

Instrumentation For

---

**EXOTIC**  
AND  
**AVIAN**

---

Surgical Specialties

**Micro-Satinsky Vena Cava**

DeBakey double-angle jaw / curved shaft / 4 1/2" (11.5 cm)

1103-855  
1103-855L larger jaw

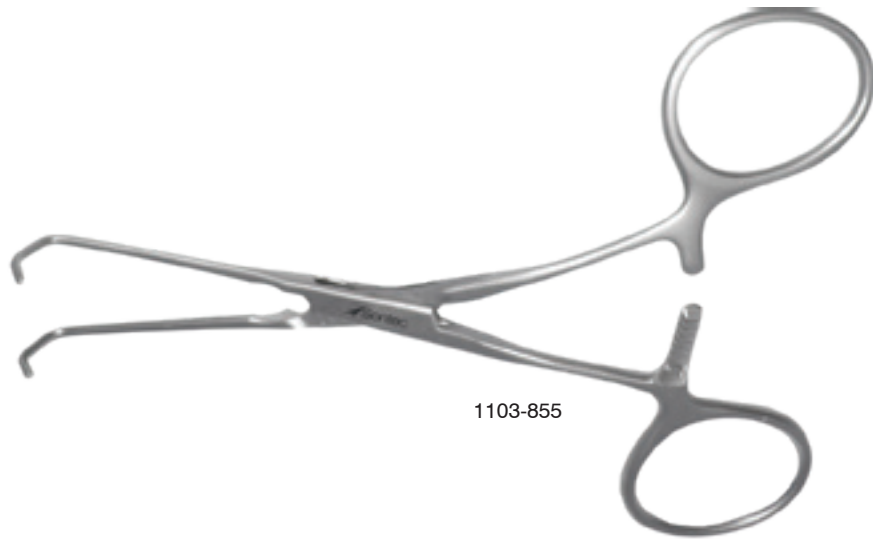
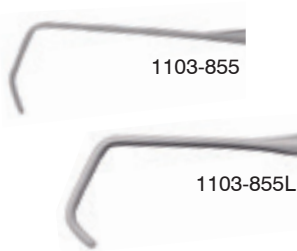

**Bennett Avian Cross-Action Retractor**

Self-retaining / 4" (10 cm) / 3" (7.5 cm) spread

1103-862 sharp  
1103-862A blunt



**Doolen Self-Retaining Atrium Retractor**

1/8" deep prongs / 4.5 mm / blunt

1103-860 2 1/4" spread 2 3/4" (7 cm)  
1103-858 3" spread 4" (10 cm)



**Jameson Caliper**

Scale to 3" (8 cm)

12-9450



**Doolen-Sontec Self-Retaining Atrium Retractor**

15 mm deep prongs / 4 x 4 / blunt

- 1103-8541 2 3/4"
- 1103-8542 4"



1103-8541



1103-8542

**Castroviejo Caliper**

Scale to 20 mm / 3 1/2" (9 cm)

- 12-9300 str
- 12-9310 cvd
- 12-9315 angled



12-9315



12-9300



12-9310

**Doolen Avian Spay Hook**

---

1 mm ball tip / 90° / 7" (18 cm)

1103-834



1103-834

**Doolen Avian Spay Hook**

---

1 mm ball Tip / 90° / 8" (20.5cm)

2700-501



2700-501

**Krayenbuehl Nerve**

---

90° / 7 1/4" (18.5 cm)

- 400-445 2 mm tip length
- 400-447 2 mm tip length 1 mm ball tip
- 400-446 3 mm tip length
- 400-448 3 mm tip length 1 mm ball tip



400-445



400-447



400-446



400-448

**Jacobson Titanium**

Round-handle / streamlined box lock /  
TC dust / suggested suture size 5-0 and  
smaller

2600-646	str	w/lock	6" (15 cm)
2600-648	cvd	w/lock	6" (15 cm)
2600-6491	str	w/lock	7 1/8" (18.25 cm)
2600-6502	cvd	w/lock	7 1/8" (18.25 cm)
2600-6531	str	w/lock	8 1/4" (21 cm)
2600-6542	cvd	w/lock	8 1/4" (21 cm)



All available in a curved tip



TC dust curved



TC dust straight



2600-646



2600-6491

2600-6431	str	w/lock	9 1/8" (23.5 cm)
2600-6512	cvd	w/lock	9 1/8" (23.5 cm)
2600-6551	str	w/lock	10" (25 cm)
2600-6562	cvd	w/lock	10" (25 cm)



2600-6551

2600-6461	str	w/o lock	6" (15 cm)
2600-6481	cvd	w/o lock	6" (15 cm)
2600-6611	str	w/o lock	7 1/8" (18.25 cm)
2600-6622	cvd	w/o lock	7 1/8" (18.25 cm)
2600-6651	str	w/o lock	8 1/4" (21 cm)
2600-6662	cvd	w/o lock	8 1/4" (21 cm)

2600-6521	str	w/o lock	9 1/8" (23.5 cm)
2600-6692	cvd	w/o lock	9 1/8" (23.5 cm)
2600-6671	str	w/o lock	10" (25 cm)
2600-6682	cvd	w/o lock	10" (25 cm)
2600-6476	str	w/lock	12" (30.5 cm)



2600-6476

## Double-Action SS

**Stainless / TC dust / round handle / 7 1/4" (18.5 cm)**

1103-888		straight
1103-887	w/ lock	straight
1103-888C		curved
1103-887C	w/ lock	curved



TC Dust, straight



TC Dust, curved



1103-887

## Double Action Titanium

**TC dust / with u-lock / suggested suture size 5-0 and smaller**

2600-683L	str	7 1/8" (18.25 cm)
2600-684L	cvd	7 1/8" (18.25 cm)
2600-682	str	8 1/4" (21 cm)
2600-682L	cvd	8 1/4" (21 cm)
2600-684S	str	9" (23 cm)
2600-684C	cvd	9" (23 cm)



TC dust straight



TC dust curved



2600-683L



2600-684L

**TC dust / without lock / suggested suture size 5-0 and smaller**

2600-682S	str	6" (15 cm)
2600-682C	cvd	6" (15 cm)
2600-683	str	7 1/4" (18.5 cm)
2600-684	cvd	7 1/4" (18.5 cm)



2600-683

## Jacobson Scissors

---

Round handle / sharp / 7" (18 cm)

2400-650 straight  
2400-652 curved

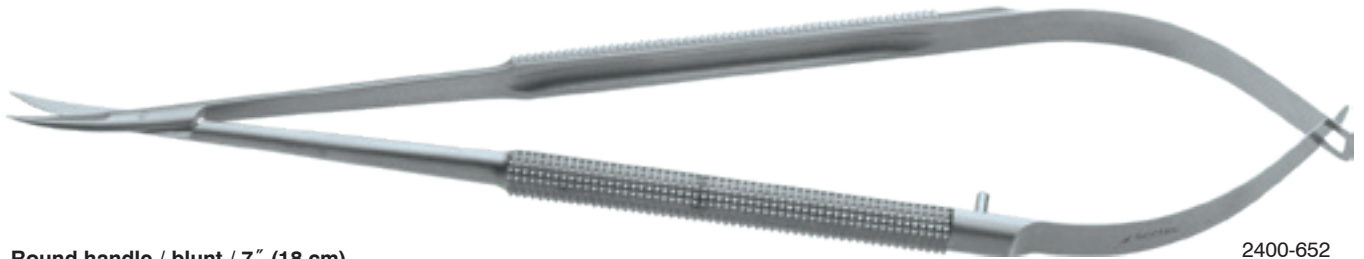

Round handle / blunt / 7" (18 cm)

2400-654 straight  
2400-656 curved

2400-652

## Avian Micro Scissors

---

Double-action / round handle /  
counterweight / 7 1/4" (18.5 cm)

1103-865 stainless straight  
1103-866 stainless curved  
1103-869S titanium straight  
1103-869T titanium curved



1103-869S

## Harrison Needle Holder

---

TC serrated / stainless / round  
handle / with lock

1103-889 6" (15 cm)  
1103-890 7 1/4" (18.5 cm)



1103-890

**Olsen-Hegar Deluxe**

**Tungsten carbide**

- 1100-105A 5" (12.5 cm)
- 1100-106D 5 3/4" (14.5 cm)

**Serrated without TC/standard**

- 1100-124D 5 3/4" (14.5 cm)
- 1100-126D 6 3/4" (17 cm)
- 1100-128D 7 3/4" (19.5 cm)

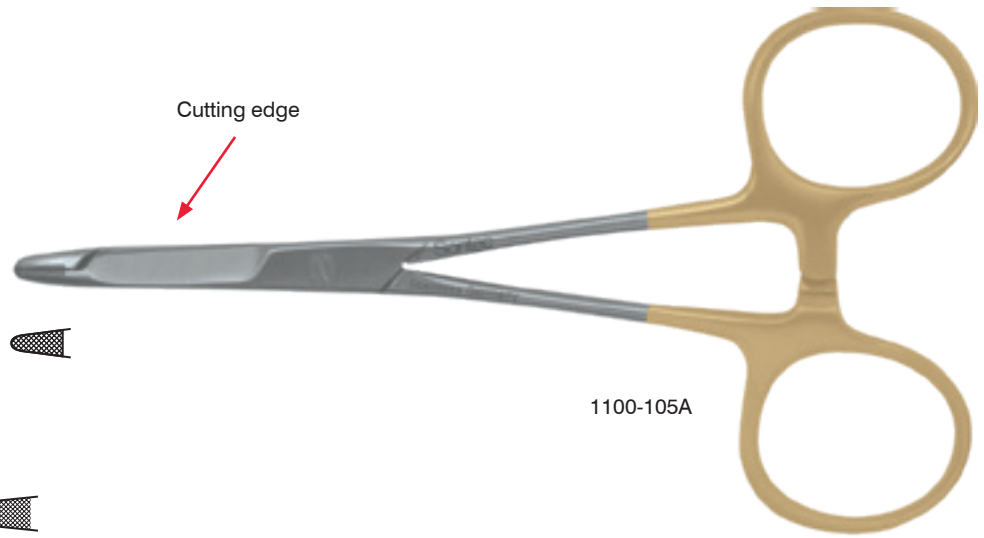

1100-105A



1100-124D

1100-126D

1100-128D

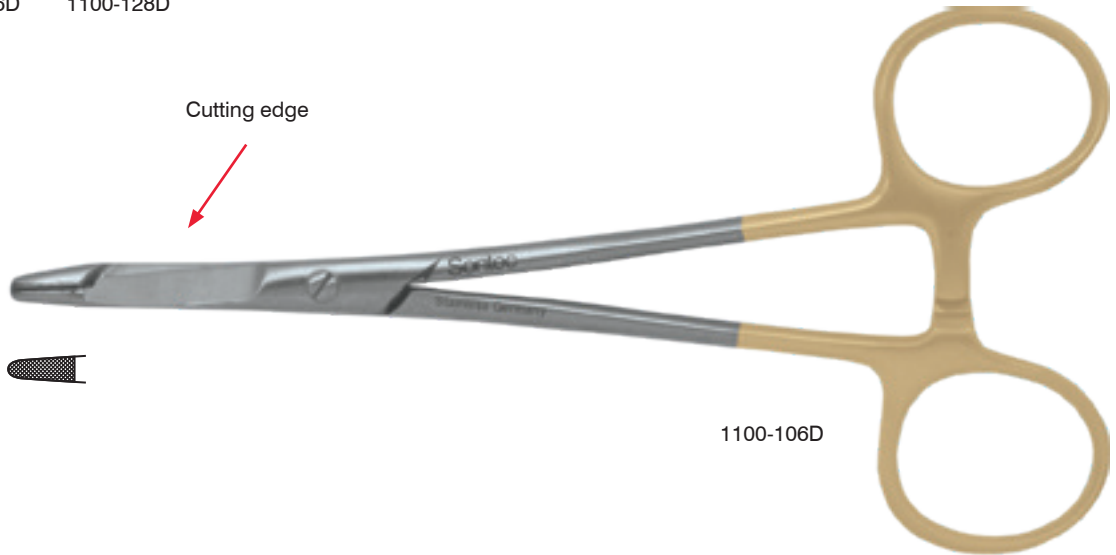

1100-106D





**Olsen-Hegar Deluxe**

Tungsten carbide

- 1100-108D 6 3/4" (17 cm)
- 1100-110D 7 3/4" (19.5 cm)



**Olsen-Webster**

4 3/4" (12 cm)

- 1103-601 serrated w/out TC/standard
- 132-362 TC serrated
- 132-360 TC smooth
- 1103-604 TC dust delicate
- 132-361 TC dust
- 132-362D TC serrated \*
- 132-362S TC offset ring

\* Double offset ring



TC Dust    TC smooth    TC serrated

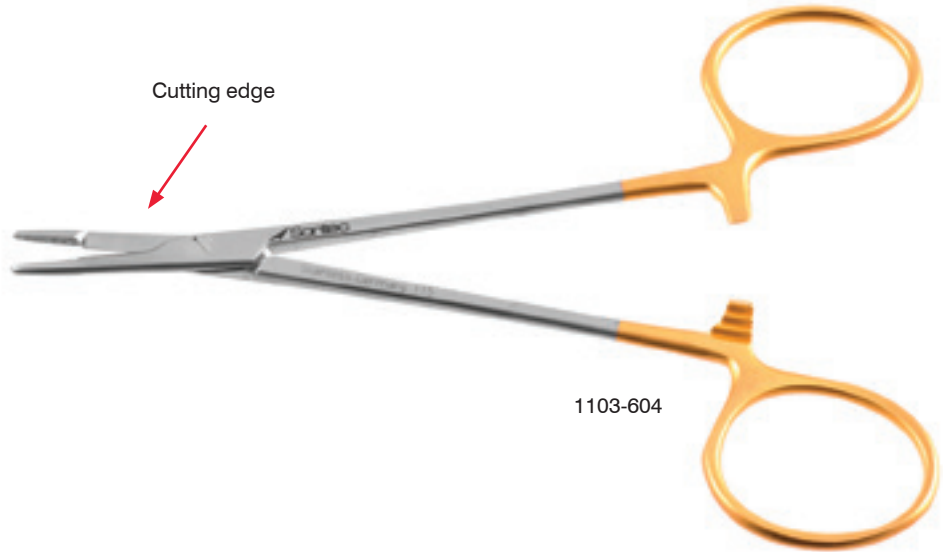
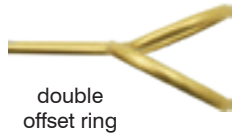

## Micro Ring Tip Counterweight Forceps Titanium

### Round handle / counterweight / ring tip / 1 mm / TC dust

2600-523	6" (15 cm)	
2600-524	6" (15 cm)	curved
2600-525	7 1/8" (18.25 cm)	
2600-526	8 1/4" (21 cm)	

### Round handle / counterweight / ring tip / 2 mm / TC dust

2600-527	6" (15 cm)
2600-528	7 1/8" (18.25 cm)
2600-529	8 1/4" (21 cm)

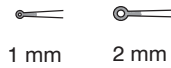

**Sontec Mosquito**

Extra micro / 1 mm tip / 3 3/4" (9.5 cm)

- 1103-817 straight
- 1103-818 curved

Extra micro / 1 mm tip / 5" (13 cm)

- 1103-815 straight
- 1103-816 curved

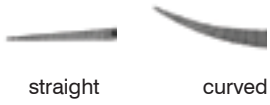

1103-818

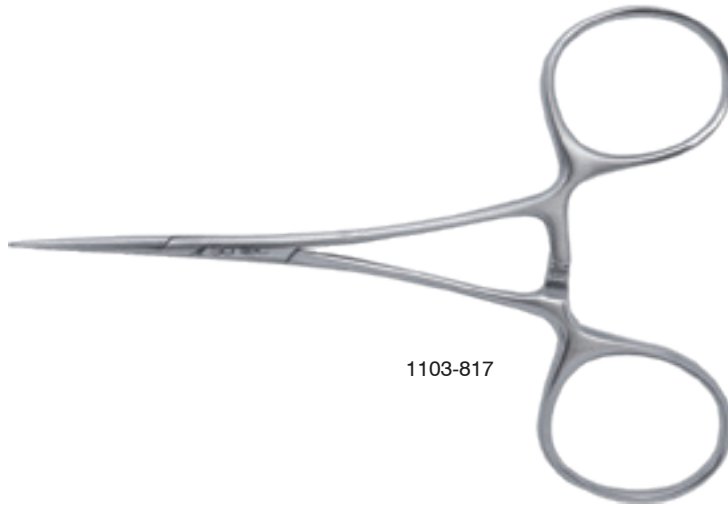

1103-817

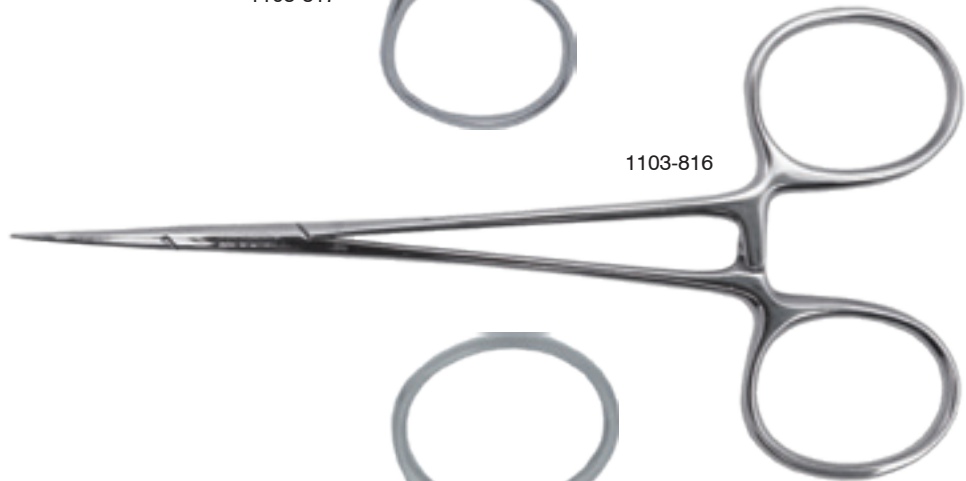

1103-816

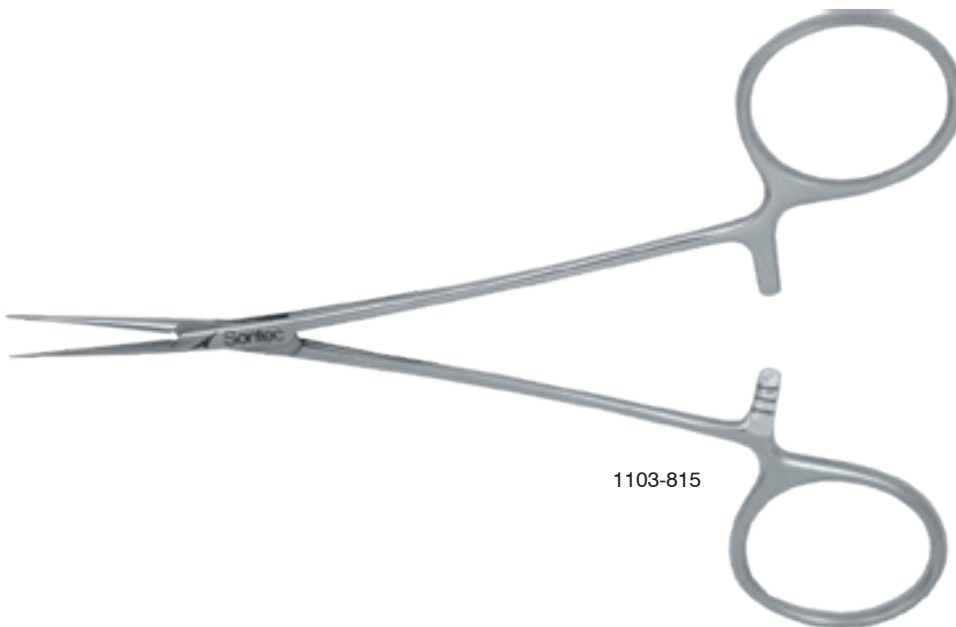

1103-815

## DeBakey Needle-Pulling

### Flat handle / TC platform / 6" (15 cm)

2200-074	1.0 mm
2200-077	1.2 mm
2200-078	1.5 mm
2200-080	2.0 mm
2200-079	2.7 mm
2200-081	3.5 mm

### Flat handle / TC platform / light weight / 2.0 mm tip / 8" (20 cm)

2200-160

### Flat handle / TC platform / 8" (20 cm)

2200-075	1.0 mm	
2200-096	1.2 mm	
2200-097	1.5 mm	
2200-100	2.0 mm	
2200-099	2.7 mm	
2200-099P	2.7 mm	with guide pin
2200-098	3.5 mm	



2200-097

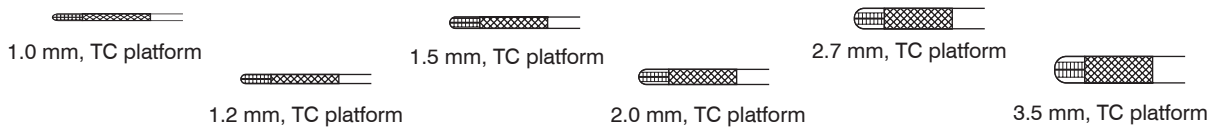

**Adson Harris**

Ring tip / TC dust / 1 mm tip /  
4 3/4" (12 cm)

1103-810  
1103-812 fenestrated handle



ring tip  
1mm

Ring tip / 2 mm tip / 4 3/4" (12  
cm)

1103-809



1103-810



1103-812

**Adson-Harris Forceps Titanium**

Fenestrated / ring-tip / TC dust / 4 3/4" (12 cm)

1103-812T



140-304T

**Harris**

Fenestrated handle / ring  
tip / 1 mm tip / 6" (15.5 cm)

1103-811  
1103-811T



ring tip  
1mm

Fenestrated handle / TC  
dust ring tip / 2 mm tip / 6"  
(15.5 cm)

1103-813



1103-811



1103-811T

**Harris DeBakey Forceps Titanium**

1 mm tip / 7 1/4" (18.5 cm) / light weight

1103-803

Counterweight

1103-805



1103-803



## Verbrugge Bone Clamp

Curved to side / with speedlock

1103-069	4" (10 cm)
1103-070	6" (15.5 cm)
1103-074	7 1/2" (19 cm)
1103-075	8 1/4" (21 cm)
1103-080	10" (25.5 cm)

Swivel jaw / curved to side / with speedlock

1103-071	5 3/4" (15 cm)
1103-073	8" (20.5 cm)
1103-077	9" (23 cm)
1103-078	10 1/4" (26 cm)
1103-079	11 1/4" (29 cm)

Ring handle / with ratchet

1103-068	7" (18 cm)
----------	------------

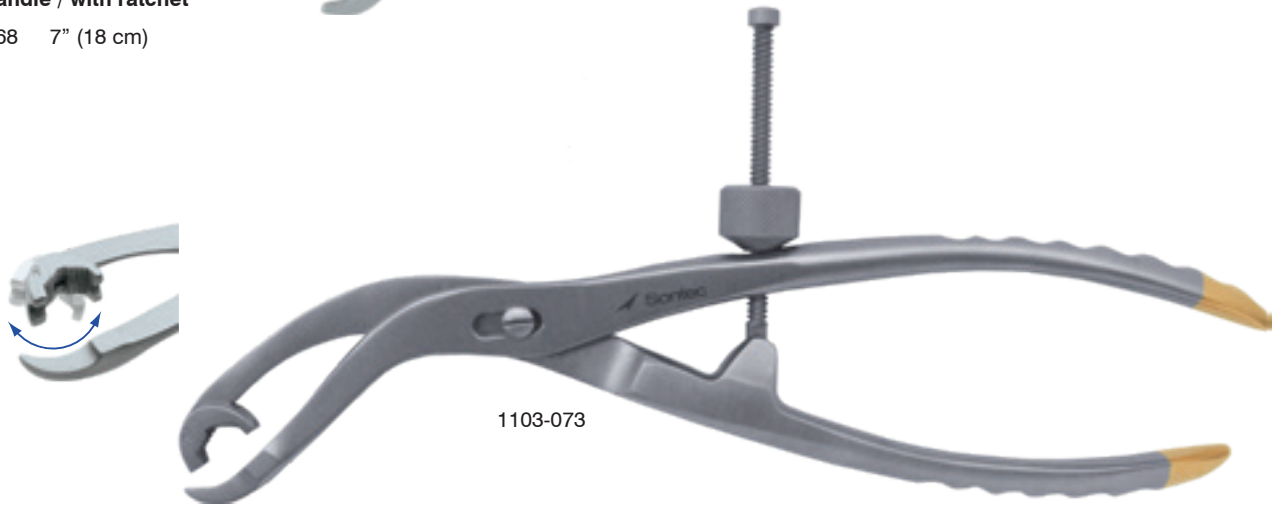

## Bone Holding Clamp

---

5 1/2" (14 cm)

1103-040A

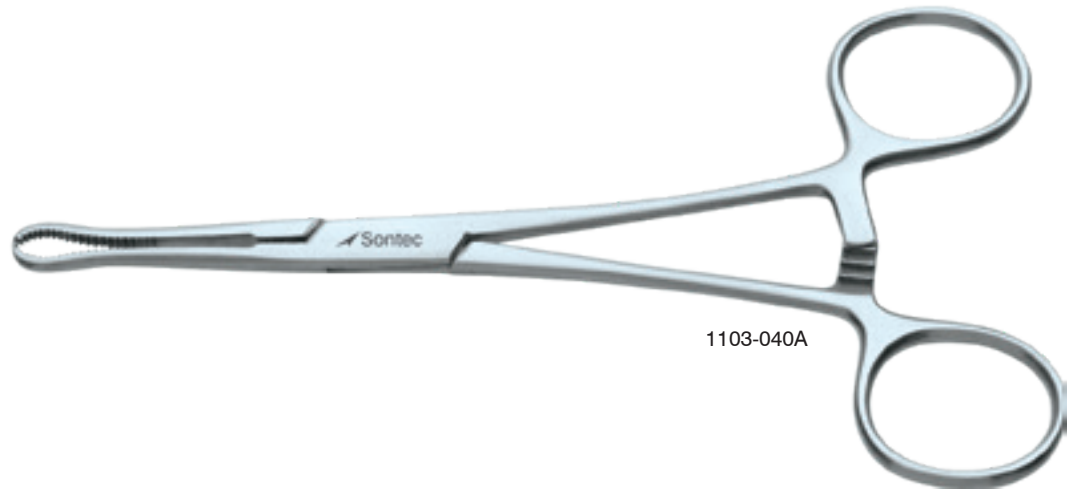

1103-040A

## Raleigh Bone Reduction Clamp

---

5 1/2" (14 cm)

1103-024 with ratchet  
1103-023 with speed lock



1103-024



## Kern Bone Clamp

### With ratchet

305-333	4 3/4" (12cm)
305-335	5 1/2" (14cm)
305-325	6 1/4" (16cm)
305-337	7" (18cm)
305-345	8 1/2" (21.5cm)
305-346	13" (33cm)

### Fenestrated jaw / with ratchet

305-332	4 3/4" (12 cm)
305-334	5 1/2" (14 cm)
305-328	6 1/4" (15.9 cm)
305-338	7" (18 cm)
305-336	8 1/2" (21.5 cm)
305-347	13" (33 cm)

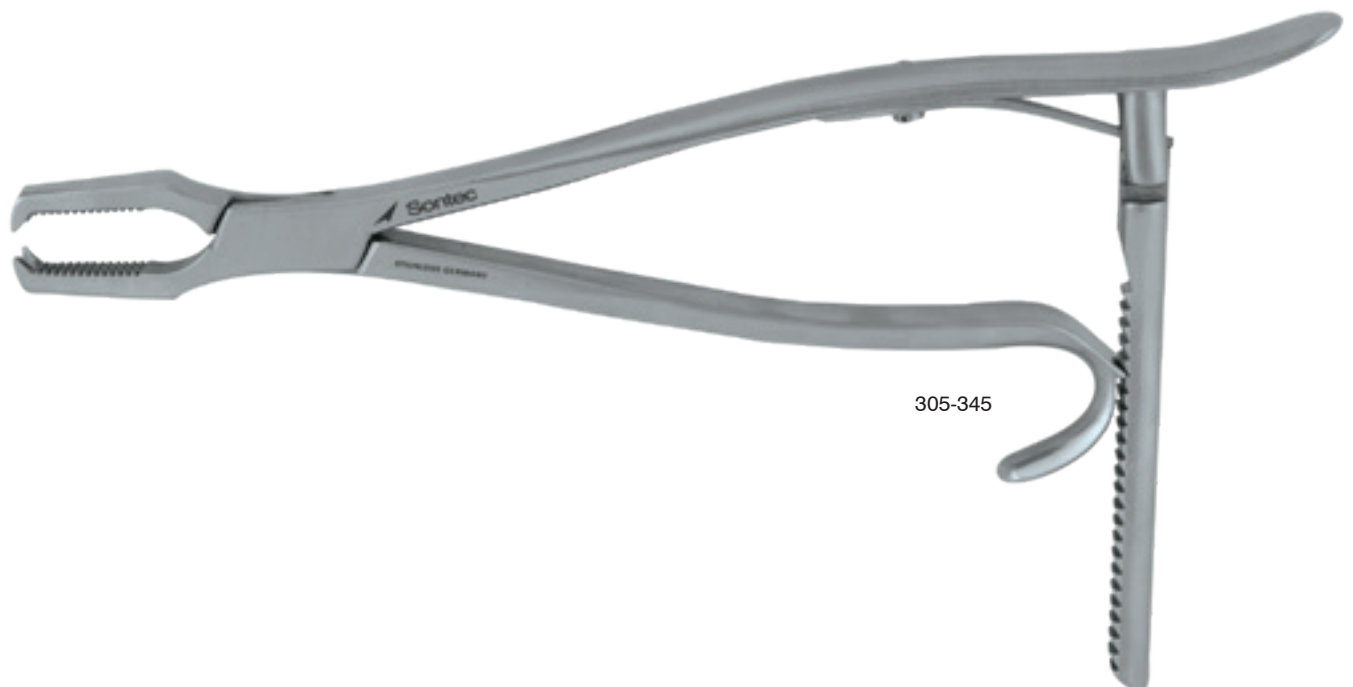

## Doolen Bone Holding Clamp

---

### 2mm wide jaw / 5'.5" (14cm)

1103-845 str w/ speedlock  
1103-846 ang w/ speedlock  
1103-846R ang w/ ratchet

### 3mm wide jaw / 6" (15cm)

1103-856 ang w/ speedlock  
1103-856 ang w/ ratchet

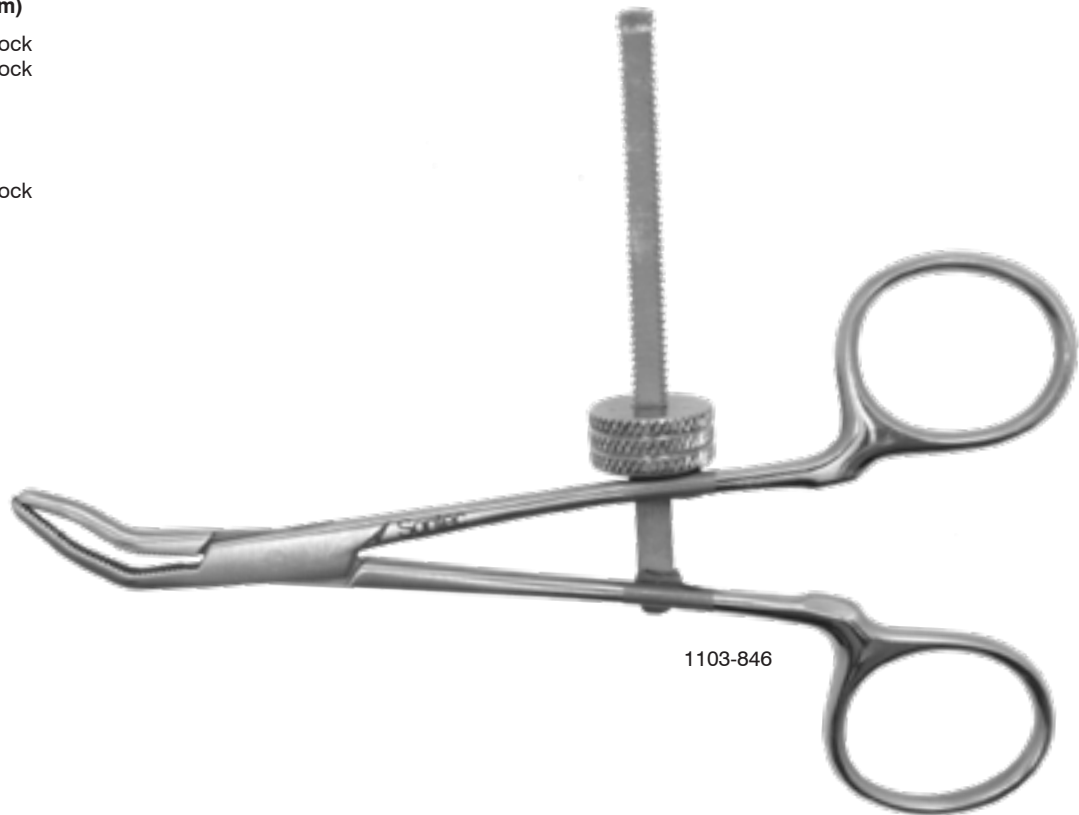

## Mini Wire Passers

---

### Sizes 22-26 for wire

1103-848 single ended  
1103-847 double ended



---

## Avian Nail Trimmer

Blue ring handle / 3 3/4" (9.5 cm)

1103-615



1103-615

---

## K Wire Pin Driver

6 3/8" (16 cm)

1103-180



1103-180

---

## Double-Ended

Single-sided / 7" (18 cm)

1103-224



1103-224

---

## Nail

Single-sided /

6 3/4" (17 cm)

345-243



345-243

**Rodent Incisor Luxator**

---

Double-ended / 6 1/4" (16 cm)

1103-385



1103-385

**Rodent Molar Luxator**

---

Double-ended / 6 1/4" (16 cm)

1103-386



1103-386

**Rodent Dental Spatula**

---

7" (18 cm)

1103-390



1103-390

**Rodent Molar Extractor**

---

6 1/2" (16.5 cm)

1103-308



1103-308

---

## Rodent Molar Cutter

Spring handle / 7 1/4" (18.5 cm)

1103-370



1103-370

actual size

---

## Tooth Cutting Forceps

TC serrated / for incisors / 7" (18 cm)

1103-368 regular

1103-369 heavy



1103-368

## Rodent Tooth Cutting Set

- 1103-360 includes:  
 1103-376 Rodent Table Retractor Restrainer  
 1103-362 Cheek Spreader, delicate  
 1103-368 Tooth Cutting Forceps, TC serrated  
 1103-372 Diamond Coated Tooth Rasp

## Rodent Table Retractor Restrainer

**Base: 8 1/2" x 7 3/4" / platform: 5 3/8" x 9 7/8" / maximum spread: 3 1/2" / varying adjustments possible**

1103-376



1103-360



1103-376

## Diamond Coated Dental

**Curved / 6 1/2"**

- 1103-379 3.5 mm x 1.8 mm  
 1103-378 4 mm x 1.8 mm



1103-379

**7" (18 cm)**

- 1103-372 fine  
 1103-374 medium



1103-372

## Joseph Bone

---

Single-sided / 7 1/2" (19 cm)

1100-466



1100-466

## Joseph Bayonet Bone

---

Single-ended / single-sided / 8" (20.5 cm)

345-255 right

345-256 left

345-257 set: including one right & one left



345-255



345-256

**Wellace Rodent Mouth Spreader**

---

Fenestrated blade / 4 1/2" (11.5 cm)

1103-380



**Weitlaner Rodent Mouth Spreader**

---

Fenestrated blade / 4 1/2" (11.5 cm)

1103-382





**Rodent Cheek Spreader**

1103-362	delicate	9 mm x 8 mm blades	
1103-363	small	10 mm x 14 mm blades	
1103-364	long	11 mm x 30 mm blades	
1103-365	extra large	15 mm x 22 mm blades	
1103-366	extra long	10 mm x 40 mm blades	
1103-367S	small	5 mm x 30 mm blades	for chinchilla
1103-367	extra narrow	5 mm x 40 mm blades	for chinchilla

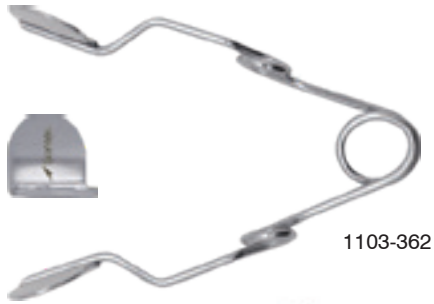

1103-362

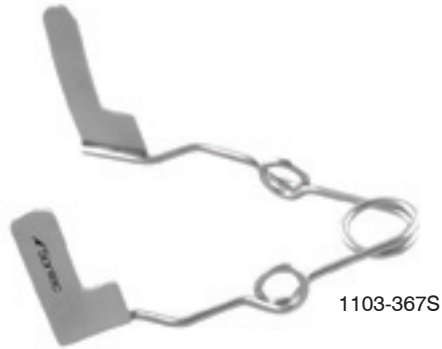

1103-367S



1103-363



1103-364



1103-365



1103-366



1103-367







**Sontec Instruments®**  
A TRADITION OF FINE SURGICAL INSTRUMENTS

Sontec Instruments, Inc.  
7248 South Tucson Way  
Centennial, Colorado 80112 USA  
Toll-free / 800.821.7496  
Local / 303.790.9411  
Fax / 303.792.2606

[SontecInstruments.com](http://SontecInstruments.com)