



 Sontec Instruments®

COLORECTAL

Dear Customer,

Sontec Instruments, Inc. is a family owned & operated medical company, providing personalized service featuring the finest in surgical instrumentation for over half a century.

Our surgical instruments encompass the entire human anatomy including specialty products specific to small and large animal surgery.

Owner of Sontec Instruments, Dennis Russell Scanlan III and his sons, Johann, Stefan and Angus Scanlan bring with them a lifetime of experience creating the highest quality products made by the world's leading manufacturing facilities featuring, cutting edge robotic technology, handmade workmanship combined with an understanding how to make exactly what our valued customers have come to expect.

Dennis R. Scanlan, III President & CEO and his wife Caron C. Scanlan thank you, for the opportunity to present our specialty Ophthalmology catalog.

Sincerely,



Dennis Russell Scanlan III

Table of Contents

Important Information 4

METZENBAUM SCISSORS 9

Colorectal CLAMPS 33

Colorectal FISTULA PROBES 41

Colorectal HOOKS 47

Colorectal LIGATION 51

Colorectal RETRACTORS 57

Colorectal SPECULUMS 83

GALL STONE Scoops 91

Colorectal UTERINE BIOPSY PUNCH 95

Index 98

IMPORTANT INFORMATION

Guarantee & Repairs Policy

Sontec® surgical instruments are guaranteed to be free of defects in materials and workmanship. Any Sontec® instrument that is defective will be repaired or replaced at our discretion. Instruments not properly cared for, used for unintended purposes, or beyond their designed capacity will not be covered under this guarantee. Our liability under this guarantee is limited to the repair or replacement of the defective merchandise.

Sontec® has its own repair department where most mechanically functional instruments can be returned to like-new condition.

Sontec® performs a variety of repairs, such as replacing worn TC jaws or sharpening scissors. In addition, we complete a comprehensive evaluation of your instruments to determine if further service is required.

For repair service, please send the following directly to the address below:

- Instruments clean, sterilized, securely wrapped and carefully packaged.
- Purchase and/or repair order
- A note with contact and shipping information
- Sending multiple items eliminates \$50 minimum charge

Return Policy

The return of new, unused instruments in their original packaging is accepted within 30 days of purchase with an authorized "Return Merchandise Authorization". Please contact Sontec directly by phone or email with your invoice or proof of purchase in order to obtain your RMA slip and instructions. Restocking fee applies and credit will not be issued for shipping charges or handling fees. Proper credit is not guaranteed without an RMA. Custom, Special Order or Modified items are non-returnable.

Sontec Instruments, Inc.
Toll free: 800.821.7496
Local: 303.790.9411
returns@sontecinstruments.com

Remember

Sontec® offers other catalogs for a variety of surgical instrumentation, including:

- Alligator, Grasping, & Biopsy Forceps
- Avian & Exotic
- Bandage Scissors
- Cardiovascular & Thoracoscopic
- Caspar & Cloward Retractor Systems
- Colon & Rectal
- Cranial Cruciate Ligament Lateral Suture

- System
- Equine (Arthroscopic)
 - Eye
 - Neurology & Orthopedic
 - Orthopedic & Arthroscopic
 - Urology
 - Veterinary Dental
 - Veterinary Eye
 - General Veterinary Instrumentation

Also, if you do not find what you are looking for, please contact us.

Instrument Care

Designed and crafted to exacting specifications, surgical instruments will perform for a number of years, provided they are maintained correctly and used for their intended purpose. A strict maintenance schedule will help reduce the need for premature replacements, thus cutting costs. For proper safeguarding of surgical instruments, please read and share the following information.

- Never substitute sterilization for cleanliness
- Wash brand new instruments prior to the first sterilization
- Remove saline solution, bleach, blood and tissue from instruments quickly and thoroughly
- Always use distilled water for cleaning instruments
- Never use saline solution for cleaning instruments
- Prevent cross-corrosion by separating corroded instruments from other instruments
- Never autoclave econo-grade stainless with superior-grade stainless.
- Always autoclave instruments with box lock open to alleviate pressure at the joint and to prevent fracture
- Lubricate joint and box lock after cleaning with an anti-microbial, water soluble lubricant
- Protect the tips of delicate instruments with protective covers (see page a.)
- Never use an instrument for anything other than its intended use

Additional Safeguarding Guidelines

Scissors and Other Blades

- Perform routine inspections for sharpness, as a blade becomes duller with each stroke (all operating and Mayo scissors should be able to cut through four layers of gauze)
- When blades no longer cut without an excessive amount of force, please return them to Sontec® for sharpening
- The more often a blade is sharpened, the longer it tends to last

Needle Holders

- Repair is necessary when needle holder no longer securely holds needle when locked on the second ratchet tooth, and needle turns easily by hand

Please Note

- We are not responsible for typographical errors in this catalog
- Instruments pictured in this catalog may or may not be to size
- Variations and changes in instrument design are possible
- Pricing is subject to change without notice
- Delivery schedules may vary from original estimates
- Some items are for veterinary use

Contact Info

Sontec Instruments, Inc.
7248 South Tucson Way
Centennial, Colorado 80112, USA
Toll free: 800.821.7496
Local: 303.790.9411
service@sontecinstruments.com
www.sontecinstruments.com

Troubleshooting Guide

Problem	Cause	Solution
Rust	Worn chrome plating on brass instruments	Be aware of plating condition and remove from service when wear is visible.
	Cross-corrosion from carbon instruments to stainless steel	Keep carbon steel and stainless steel instruments separated during cleaning and sterilization.
	Low grade instruments may not have been passivated	Remove from service.
	Autoclave not operating properly	Clean and thoroughly flush water lines in sterilizer according to manufacturer's instructions. Only use distilled water, never tap water, to generate steam.
	Organic matter left on instrument after surgery	Remove all blood and tissue before drying. Use distilled water and a nylon brush to clean hard to reach areas.
Pitting	Prolonged exposure to corrosive chemicals and/or organic substances	Only use approved cleaning and sterilization solutions. Thoroughly rinse and dry instruments.
Orange / Brown Stains	Contaminated sterilizer, high alkaline detergent, cold disinfectants	Clean sterilizer. Use neutral pH solutions. Thoroughly clean, rinse, and dry instruments.
Bluish Black Stains	Mixing dissimilar metals during cleaning and sterilization	Separate carbon steel, aluminum, and stainless steel instruments.
Rainbow - colored Stains	Chromium oxide stain-result of excessive heat	Send in for polishing and hardness check.
Cracked Box Lock	Excessive force, sterilized in the closed position	Replace the instrument.
Cracked Jaw on Pin Cutter	Cutting pin at tip of jaws	Replace the instrument. Cut pin in center of jaws.

Conversion Table

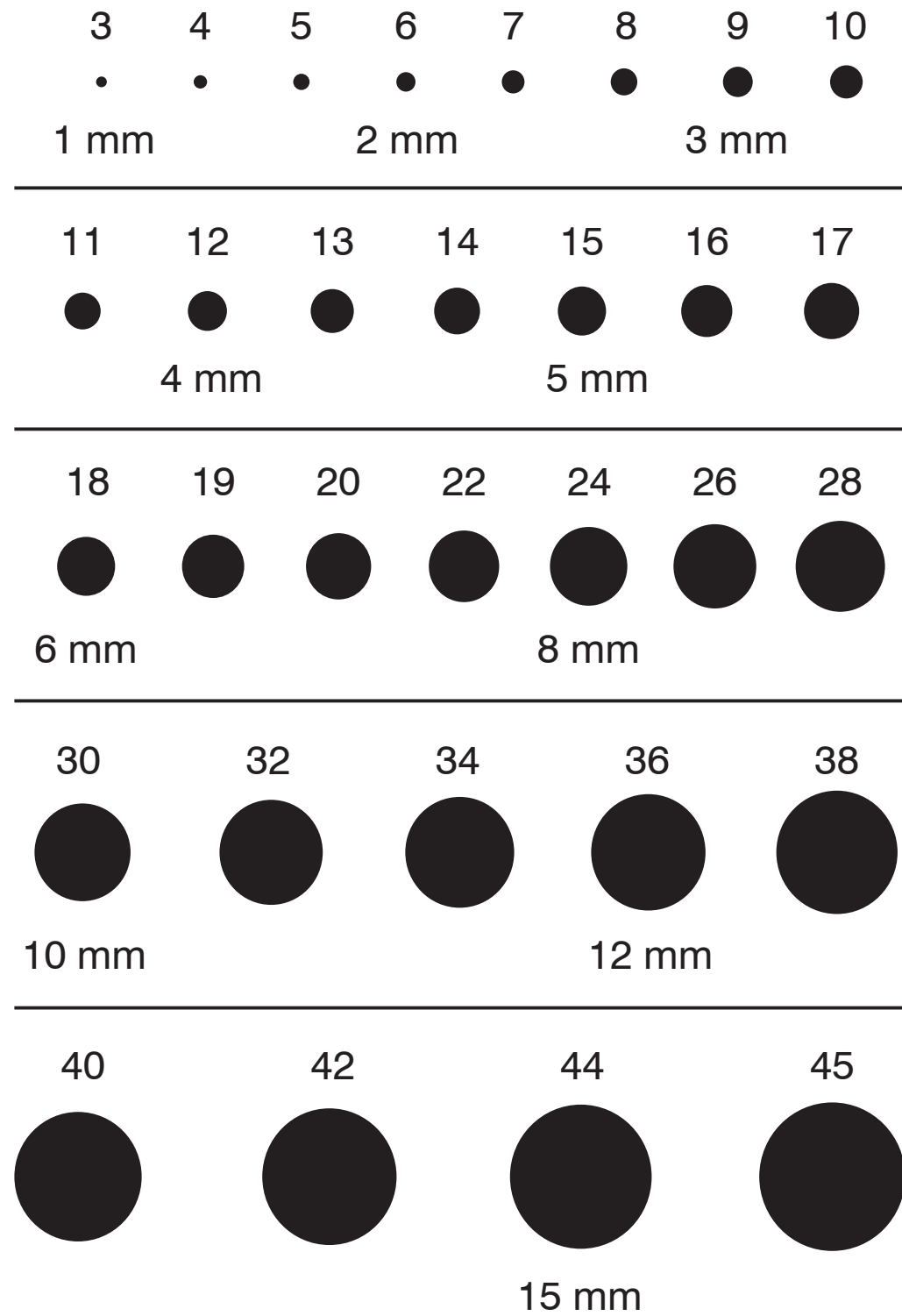

Conversion Table

Multiply	By	To Obtain
Millimeters	0.1	Centimeters
Millimeters	0.03937	Inches
Centimeters	0.3937	Inches
Centimeters	0.01	Meters
Centimeters	10	Millimeters
Inches	2.540	Centimeters
$1/8'' = 3.175$ millimeters		
$1/4'' = 6.350$ millimeters		
$3/8'' = 9.525$ millimeters		
$1/2'' = 12.70$ millimeters		
$1'' = 25.40$ millimeters		

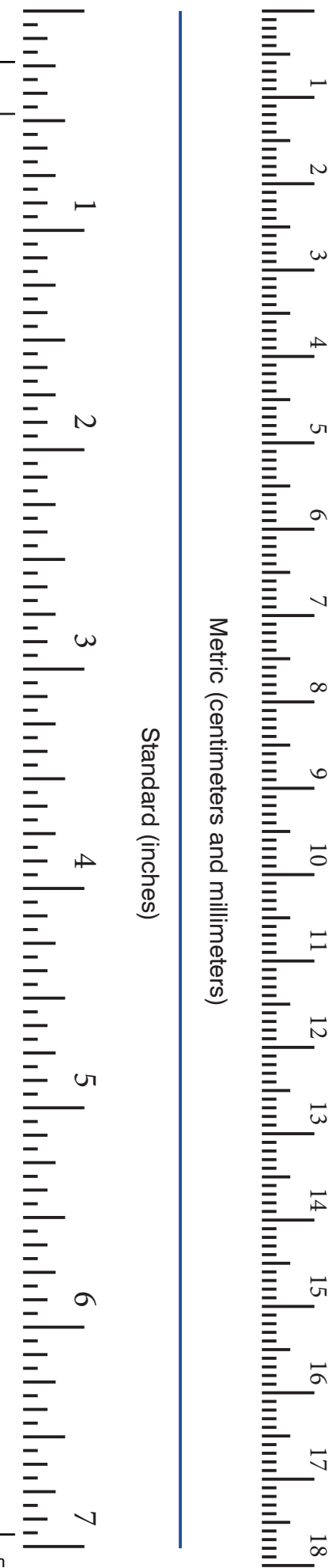



 Sontec Instruments®

METZENBAUM SCISSORS

Sontec® Scissors are simply unmatched in design, function, quality and variety. Sontec Scissors are offered in any model blade, shape or size in all of our model options listed below:

Classic Model

- Combining extremely high quality with unmatched value
- Satin or high gloss finish

Tungsten Carbide - TC inserts

Gold Rings

- diamond-ground tungsten-carbide inserts
- extremely sharp
- Blade hardness greatly increases scissor life
- available with or without serrations

Powercut blades® - PC gold

Gold Rings with Stripes on Shanks

- sharpest cutting edge available
- serrated unless otherwise requested
- Finished in Sontec's Trademarked PC Gold design
- All the attributes of Sontec PC Black scissors

Powercut blades® - PC black

Black Rings

- All the attributes of Sontec PC Gold
- Beautifully ornamented in black chrome

Tungsten Carbide / Power Cut - TC/PC:

Gold Ring / Black Ring

- Serrated unless otherwise requested
- a combination of the best options
- HANDLE: one gold ring, one black ring
- This premier line encompasses TC long life, PC power, and Sontec Quality

Ceramic Coated Scissors:

Black Ring

- offered to protect your investment even further by putting the instrument into an extremely hard coating which adds more life to your Sontec Scissors
- Offered in either PC or TC/PC models



Metzenbaum Classic Model Scissors

Classic model / 4 1/2" (11.5 cm)

- 1100-233 straight
- 1100-241 curved

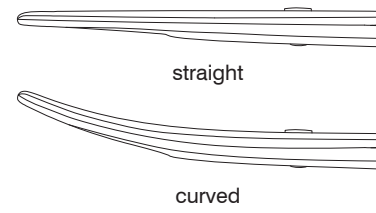

Classic model / 5 3/4" (14.5 cm)

- 1100-236 straight
- 1100-236L straight left handed
- 1100-242 curved
- 2400-346 curved extra-light
- 2400-347 curved extra-light tenotomy tip

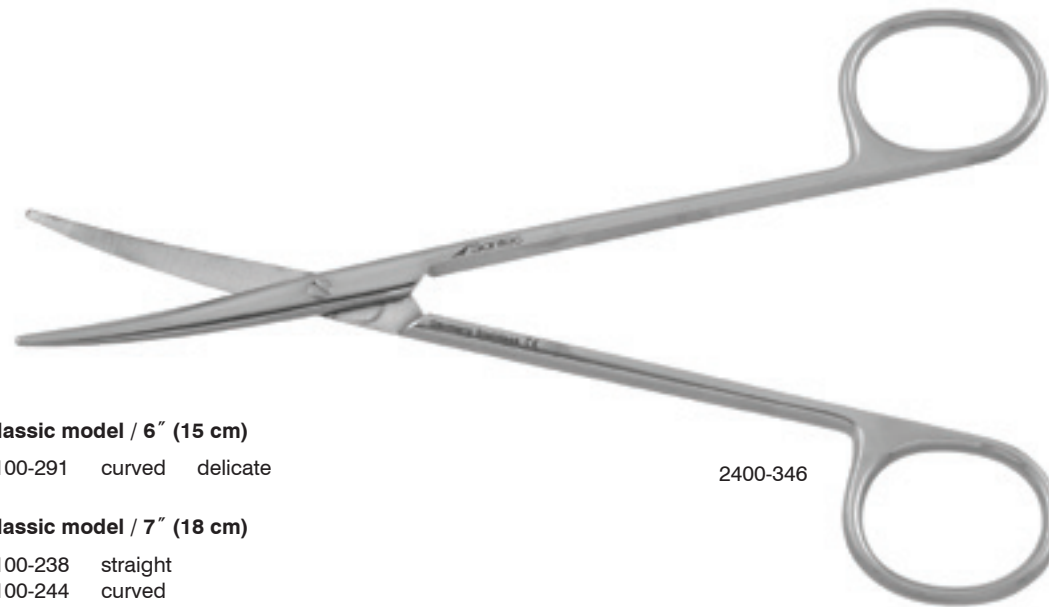
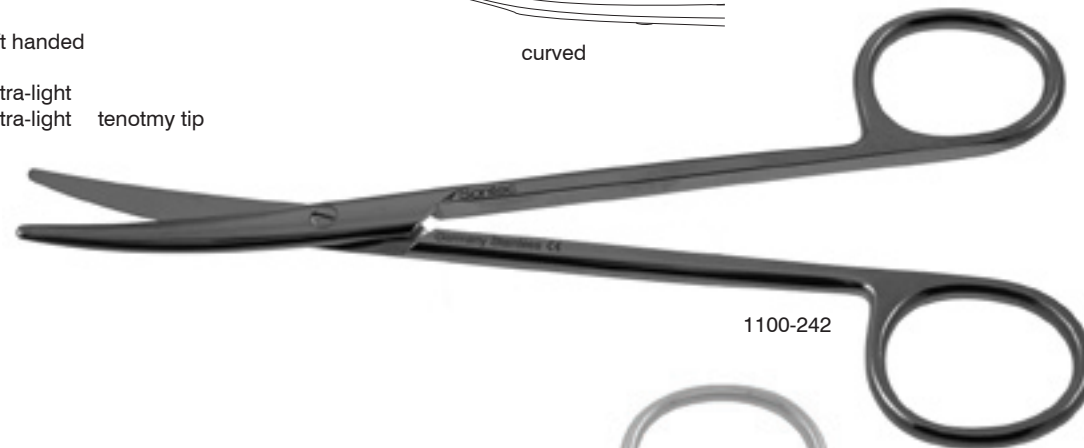

Classic model / 6" (15 cm)

- 1100-291 curved delicate

Classic model / 7" (18 cm)

- 1100-238 straight
- 1100-244 curved
- 2400-349 curved extra-light



Metzenbaum Classic Model Scissors

Classic model / 8" (20.5 cm)

- 1100-240 straight
- 1100-246 curved
- 2400-320 straight fino



Classic model / 9" (23 cm)

- 110-301 straight
- 110-302 curved
- 2400-352 curved extra-light

Classic model / 10" (25.4 cm)

- 1100-243 straight
- 1100-245 curved



Metzenbaum Scissors

Curved / power cut silver / 5 3/4" (14.6 cm)

- 1200-333



Metzenbaum Tungsten Carbide Scissors

Tungsten Carbide (TC) / 5 3/4" (15 cm)

- 2400-265 straight
- 2400-267 curved
- 2400-250 straight delicate
- 2400-252 curved delicate

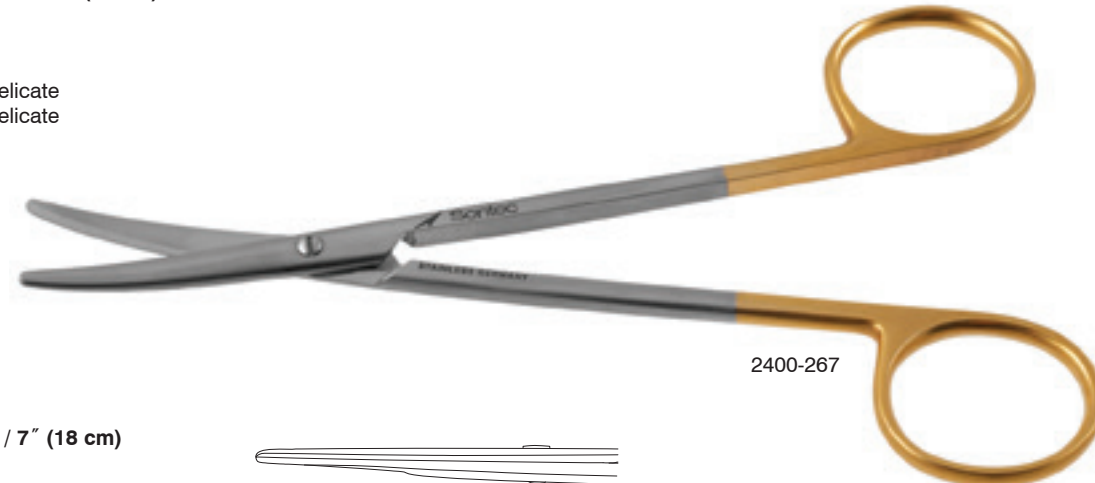

2400-267

Tungsten Carbide (TC) / 7" (18 cm)

- 2400-269 straight
- 2400-270 curved
- 2400-253 curved s-curved
- 2400-254 straight delicate
- 2400-256 curved delicate

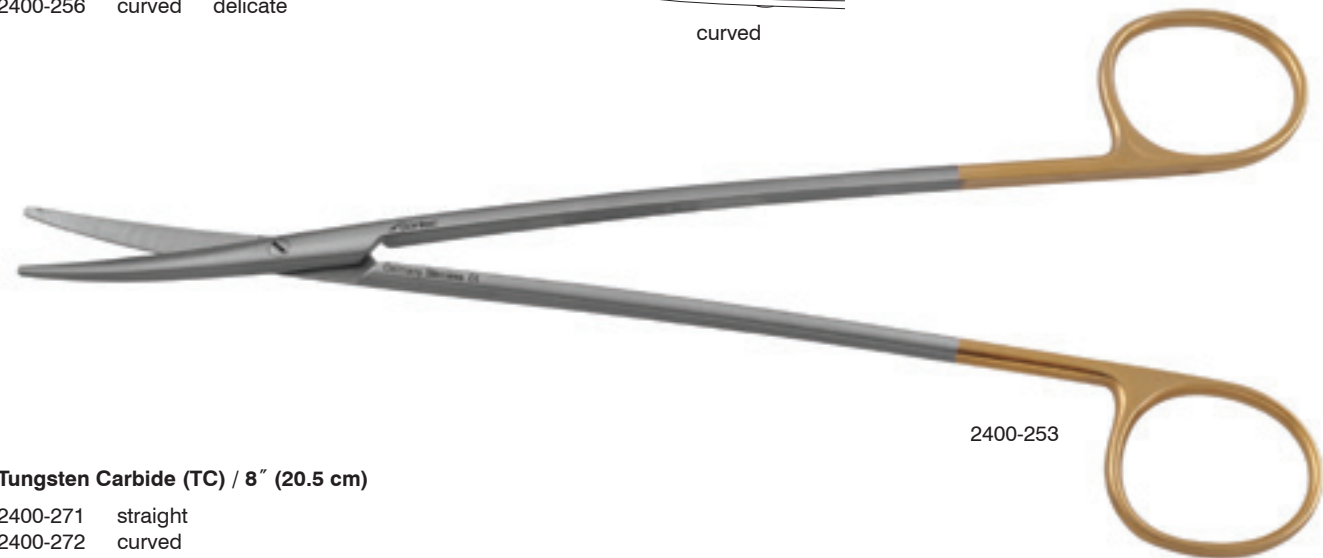
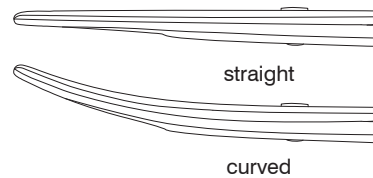

2400-253

Tungsten Carbide (TC) / 8" (20.5 cm)

- 2400-271 straight
- 2400-272 curved
- 2400-255 curved s-curved
- 2400-257 straight delicate



2400-272

Metzenbaum Tungsten Carbide Long Model Scissors

Tungsten Carbide (TC) / 9" (23 cm)

- 2400-273 straight
- 2400-275 curved
- 2400-260 straight delicate
- 2400-262 curved delicate

Tungsten Carbide (TC) / 10" (25.5 cm)

- 2400-279 straight
- 2400-280 curved

Tungsten Carbide (TC) / 11" (28 cm)

- 2400-277 straight
- 2400-278 curved
- 2400-264 curved delicate

Tungsten Carbide (TC) / 12" (30.5 cm)

- 2400-341 straight
- 2400-345 curved

Tungsten Carbide (TC) / curved / extra long

- 1100-847 14" (35.5 cm)
- 1100-849 16" (40.5 cm)
- 1100-850 18" (45.5 cm)



2400-273

Metzenbaum Stitch Scissors

TC serrated / curved / spread handle

- 2400-282 5 3/4" (14.6 cm)
- 2400-283 7" (17.8 cm)



2400-282

Metzenbaum Power Cut® Gold Scissors

Power Cut Gold (PC Gold) / 4 3/4" (12 cm)

- 1200-326 straight
- 1200-328 curved

Power Cut Gold (PC Gold) / 5" (12.5 cm)

- 2400-286 straight
- 2400-287 curved

Power Cut Gold (PC Gold) / straight / 5 3/4" (15 cm)

- 1200-330
- 1200-334 delicate

Power Cut Gold (PC Gold) / curved / 5 3/4" (15 cm)

- 1200-332
- 1200-335 delicate
- 1200-347 ergonomic spread handle

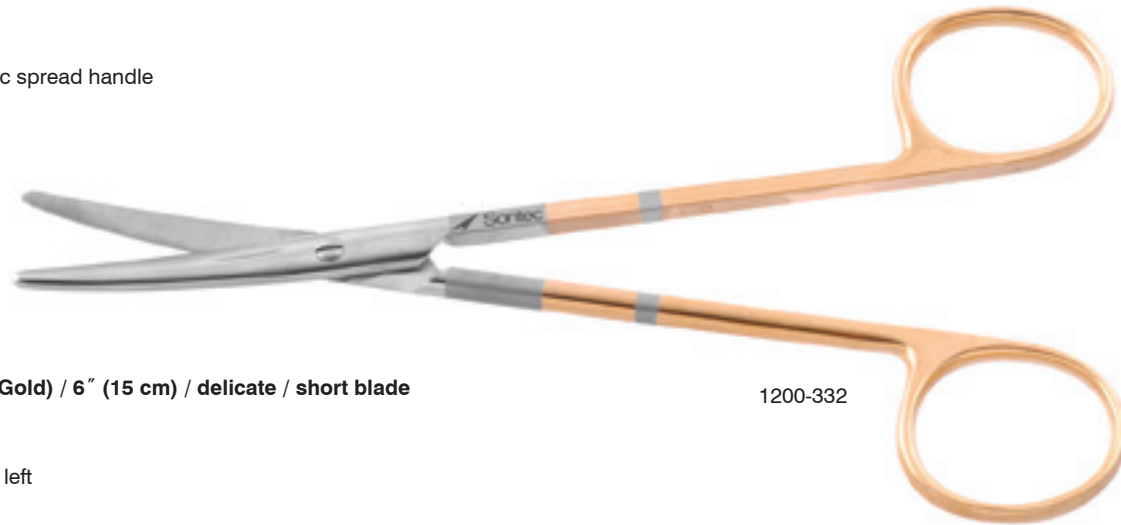

Power Cut Gold (PC Gold) / 6" (15 cm) / delicate / short blade

- 2400-314 straight
- 2400-315 curved
- 1200-330L straight left

1200-332

2400-314

Power Cut Gold (PC Gold) / straight / 7" (18 cm)

- 1200-340
- 2400-316 delicate



Metzenbaum Power Cut® Gold Scissors

Power Cut Gold (PC Gold) / curved / 7" (18 cm)

- 1200-342
- 1200-342H heavy
- 1200-342L left handed
- 1200-344 ergonomic spread handle
- 2400-317 delicate
- 2400-330 2.5 mm tip

Power Cut Gold (PC Gold) / 8" (20.5 cm)

- 1200-360 straight
- 1200-362 curved
- 2400-318 straight delicate
- 2400-319 curved delicate



1200-342



1200-360

Metzenbaum S-Curved Power Cut® Gold Scissors

Power Cut Gold (PC Gold) / s-curved / curved shank & blade

- 1200-525 7" (17.8 cm)
- 1200-523 8" (20.5 cm)



Metzenbaum Bayonet Power Cut® Gold Scissors

Power Cut Gold (PC Gold) / bayonet / curved / 7" (18 cm)

- 1200-370
- 1200-372 tenotomy tip

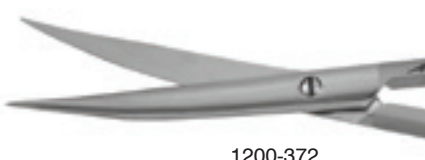

Metzenbaum Power Cut® Gold Long Model Scissors

Power Cut Gold (PC Gold) / 9" (23 cm)

- 2400-302 straight
- 2400-304 curved
- 2400-322 straight delicate
- 2400-321 curved delicate



Power Cut Gold (PC Gold) / 10 1/4" (26 cm)

- 2400-306 straight
- 2400-308 curved
- 2400-309 straight delicate
- 2400-323 curved delicate



Power Cut Gold (PC Gold) / curved /

- 2400-310 11" (28 cm)
- 2400-311 12" (30.5 cm)
- 1200-268 14" (35.5 cm)
- 1200-269 16" (40.5 cm)
- 1200-270 18" (45.5 cm)



Metzenbaum Power Cut® Black Scissors

Power Cut Black (PC Black) / 4 1/2" (11.5 cm)

- 1200-775M straight baby
- 1200-776M curved baby

Power Cut Black (PC Black) / 5" (13 cm)

- 1200-780 straight
- 1200-782 curved
- 1200-750 straight tenotomy tip
- 1200-752 curved tenotomy tip

Power Cut Black (PC Black) / extra delicate / 5 1/4" (13.5 cm)

- 2400-812A straight
- 2400-813A curved

Power Cut Black (PC Black) / extra delicate / 5 5/8" (14 cm)

- 2400-814A straight
- 2400-815A curved

Power Cut Black (PC Black) / tenotomy tip / 5 3/4" (14.5 cm)

- 1200-760 straight
- 1200-762 curved

Power Cut Black (PC Black) / 5 3/4" (14.5 cm)

- 1200-784 straight
- 1200-786 curved
- 1200-783 straight delicate
- 1200-787 curved delicate



1200-775M

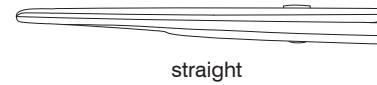

straight



curved



1200-752



delicate blade



1200-760

Metzenbaum Power Cut® Black Scissors

Power Cut Black (PC Black) / fine tip / curved / 5 3/4" (14.6 cm)

- 2400-815

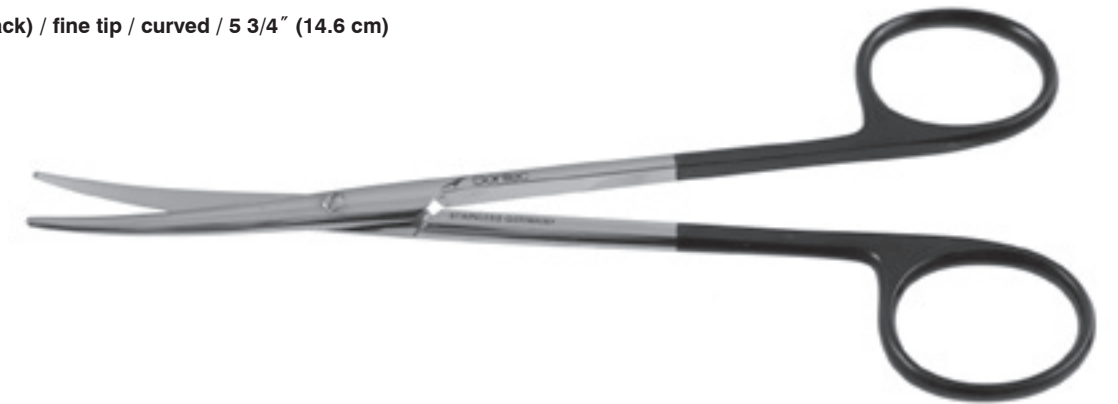

Metzenbaum Power Cut® Black Scissors

Power Cut Black (PC Black) / 6" (15 cm)

- 2400-790 straight unique short blades
- 2400-792 curved unique short blades
- 2400-816 straight delicate
- 1200-770 curved tenotomy tip ergonomic spread handle

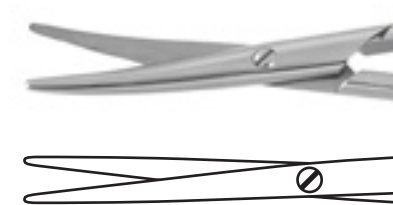

delicate blade

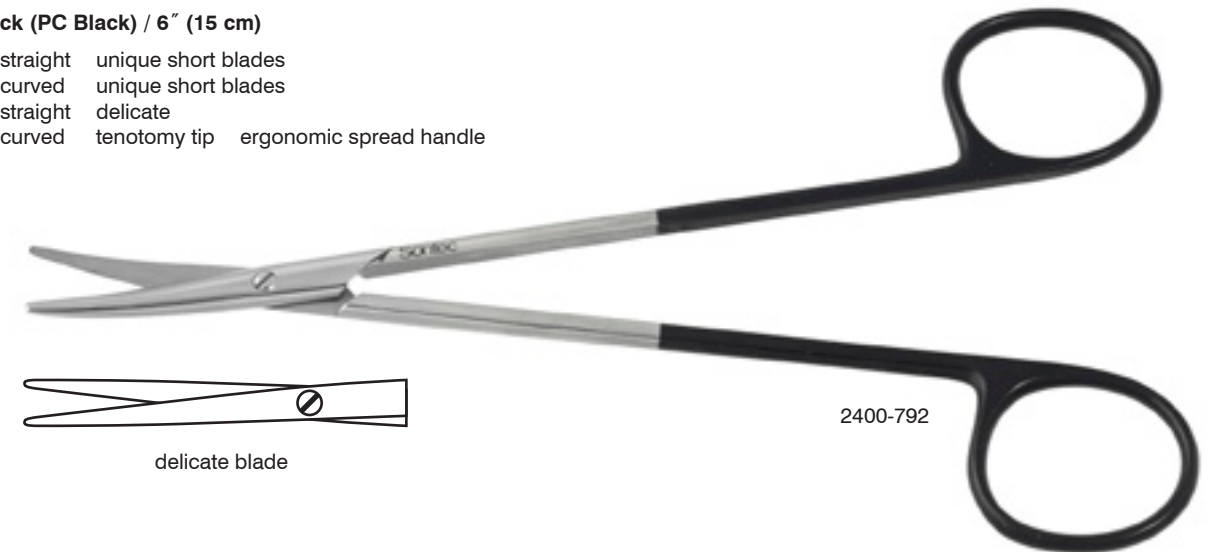

2400-792

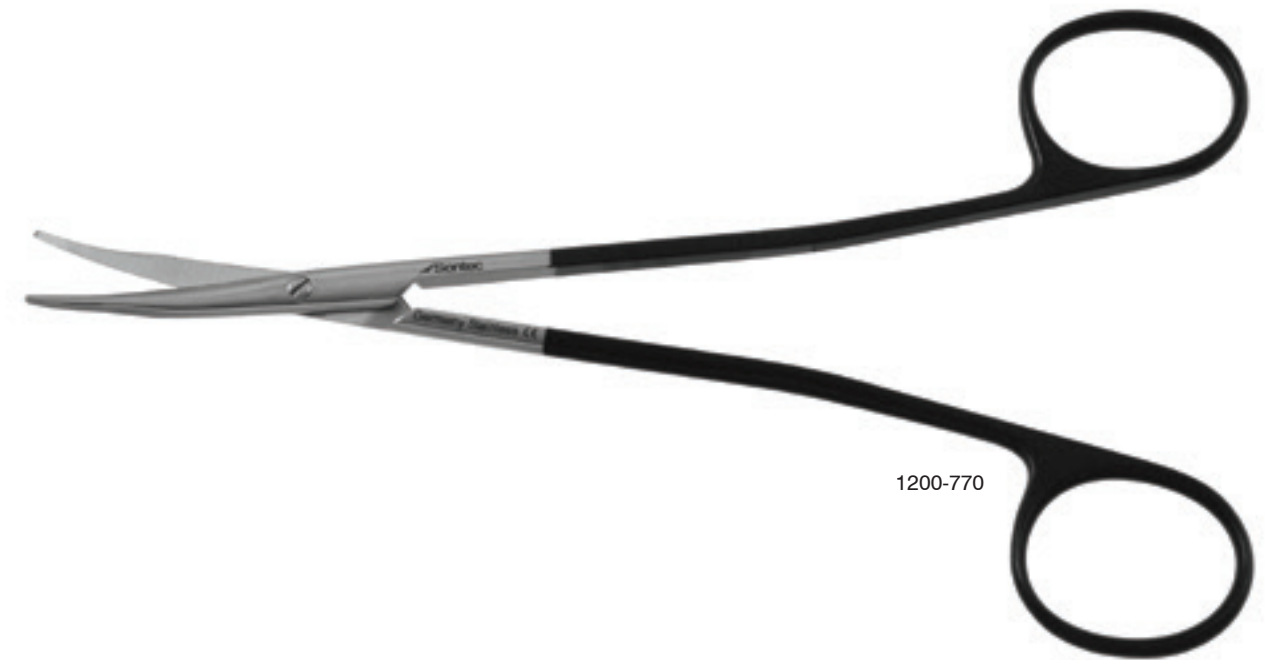

1200-770

Metzenbaum Power Cut® Black Scissors

Power Cut Black (PC Black) / 7" (18 cm)

1200-788	straight	
1200-790	curved	
2400-797	curved	2.5mm tip

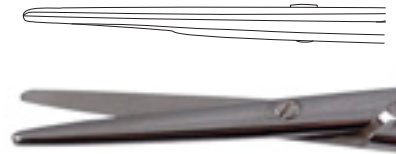

1200-788

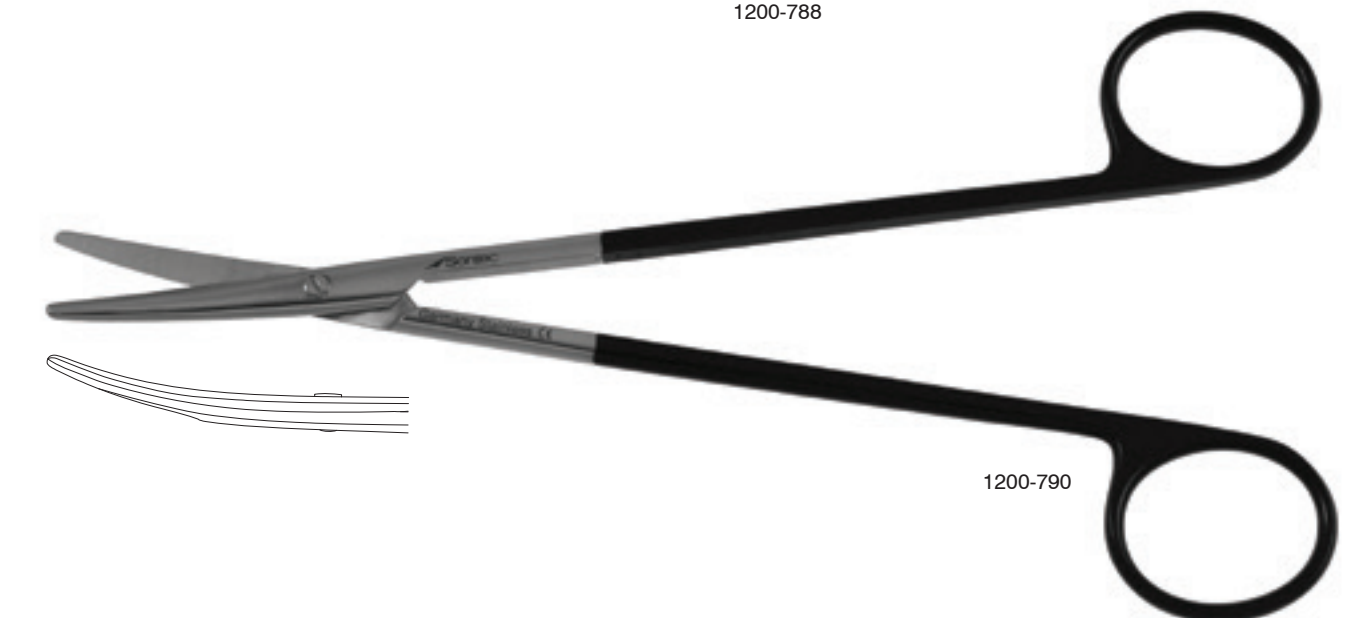

1200-790

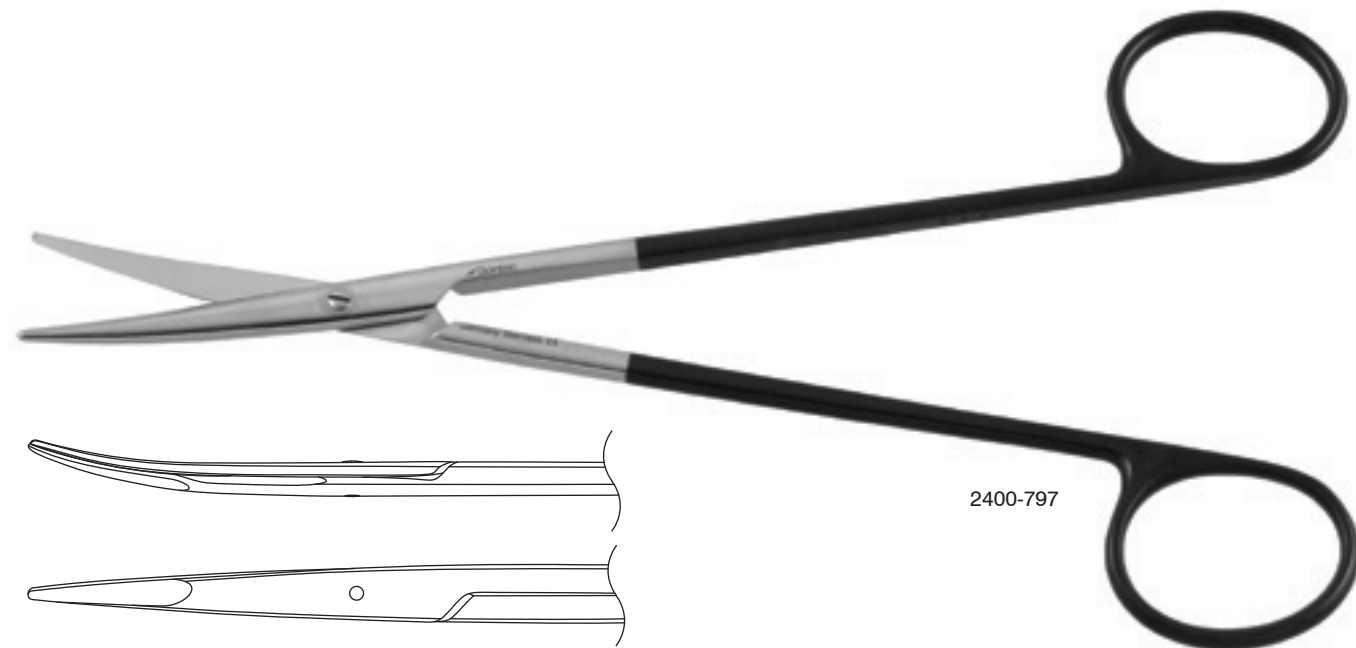

2400-797

Metzenbaum Power Cut® Black Scissors

Power Cut Black (PC Black) / 8" (20.5 cm)

2400-798	straight	
2400-800	curved	
2400-801	curved	tenotomy tip
2400-820	straight	delicate
2400-819	curved	delicate

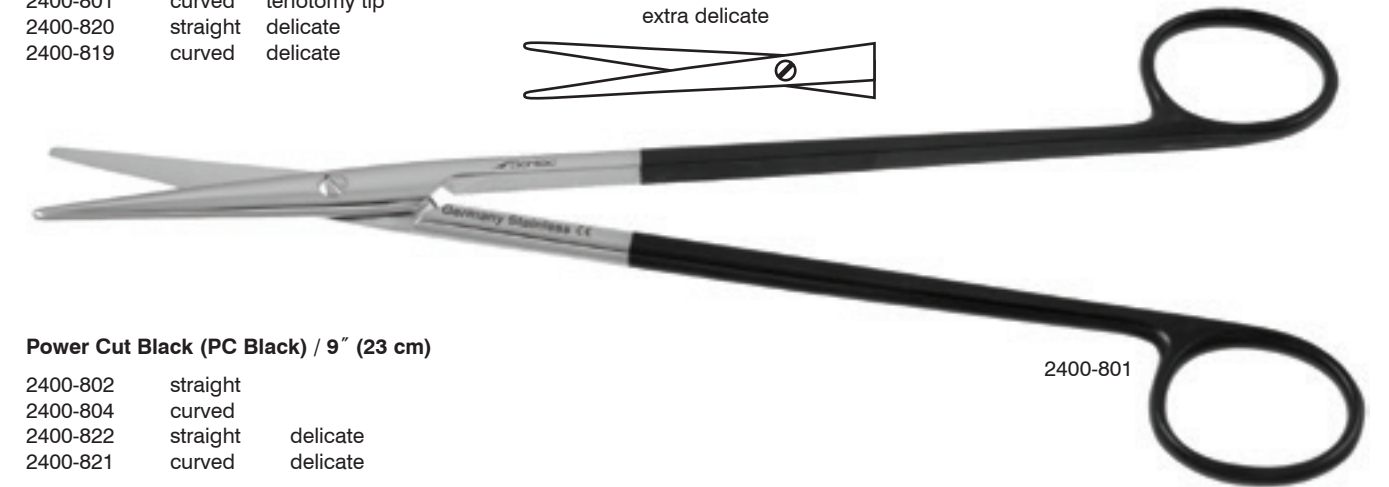
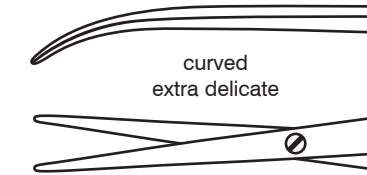

2400-801

Power Cut Black (PC Black) / 9" (23 cm)

2400-802	straight	
2400-804	curved	
2400-822	straight	delicate
2400-821	curved	delicate



2400-822

Power Cut Black (PC Black) / 10 1/4" (26 cm)

2400-806	straight	
2400-808	curved	
2400-807	straight	delicate
2400-809	curved	delicate

Power Cut Black (PC Black) / 11" (28 cm)

2400-803	straight	
2400-805	curved	

Power Cut Black (PC Black) / curved / 12" (30.5 cm)

2400-811



2400-808

Metzenbaum Power Cut® Black Scissors

Power Cut Black (PC Black) / 7" (18 cm)

2400-817	curved	delicate
2400-818	straight	delicate
2400-818M	straight	extra delicate
2400-817M	curved	extra delicate
2400-817F	full curved	extra delicate



2400-817

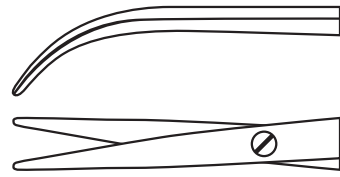

full curved
extra delicate



2400-818

Metzenbaum-Toennis Power Cut® Black Scissors

PC black / extra delicate / 7" (18 cm)

2400-841	curved
----------	--------



2400-841

Baby Metzenbaum Power Cut Black® Scissors

PC Black / 4 3/4" (12.1 cm)

2400-785	straight
2400-787	curved



2400-787

Metzenbaum Ceramic Coated Power Cut® Scissors

Special / ceramic coated scissors / with Power Cut blades / delicate / 5" (13 cm)

1200-900	straight
1200-905	curved

Special / ceramic coated scissors / with Power Cut blades / 5 3/4" (15 cm)

1200-909	straight
1200-908	curved

Special / ceramic coated scissors / with TC/PC blades / curved / delicate

1200-910	5 3/4" (15 cm)
1200-904	7" (18 cm)

Special / ceramic coated scissors / with Power Cut blades / 7" (18 cm)

1200-907	straight
1200-906	curved
1200-902	straight delicate

* Titanium Nitrate Coating is a very hard coating that keeps scissors sharper longer, reduces friction and adds a layer of corrosion protection



1200-908

Metzenbaum Tungsten Carbide Power Cut® Gold/Black Scissors

Strabismus / tungsten Carbide /Power Cut (TC/PC) / 4 1/2" (11.5 cm)

- 1200-500 straight
- 1200-501 curved

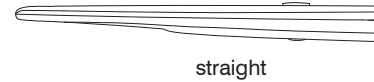

Tungsten Carbide /Power Cut (TC/PC) / Serrated / 5 3/4" (14.5 cm)

- 1200-505 straight
- 1200-510 curved
- 1200-507 straight delicate
- 1200-512 curved delicate
- 1200-514 curved ergonomic spread handle

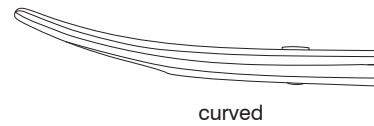

Tungsten Carbide /Power Cut (TC/PC) / 7" (18 cm)

- 1200-515 straight
- 1200-520 curved
- 1200-526 curved ergonomic spread handle
- 1200-526S curved ergonomic spread handle sharp tips
- 2400-247 curved delicate

Tungsten Carbide /Power Cut (TC/PC) / 8" (20.5 cm)

- 1200-530 straight
- 1200-529 curved
- 1200-531 curved ergonomic spread handle
- 2400-248 curved delicate



Tungsten Carbide /Power Cut (TC/PC) / 9" (23 cm)

- 1200-535 straight
- 1200-536 curved
- 2400-259 curved delicate

Tungsten Carbide /Power Cut (TC/PC) / 10" (25.5 cm)

- 1200-537 straight
- 1200-538 curved
- 2400-281 curved delicate

Metzenbaum Ceramitec Power Cut® Scissors

Special / ceramic coated scissors / with Power Cut blades / black with gold screw / curved

- 1200-911 5 3/4" (15 cm)
- 1200-912 5 3/4" (15 cm)
- 1200-915 7" (18 cm)
- 1200-916 delicate 7" (18 cm)



* Titanium Nitrate Coating is a very hard coating that keeps scissors sharper longer, reduces friction and adds a layer of corrosion protection



Metzenbaum Ceramitec TC/PC Scissors

Special / ceramic coated scissors / with TC/PC curved blades / black with gold screw and gold shiny rings

1200-913 5 3/4"
1200-919 7"

Special / ceramic coated scissors / with TC/PC curved blades / black with gold screw and gold shiny rings / spread handle

1200-914 5 3/4"
1200-9192 7"



1200-914



1200-9192

Metzenbaum Ceramitec Power Cut® Scissors

Special / ceramic coated scissors / with Power Cut blades / black with gold screw / curved / spread handle / 4 1/2" (11.4 cm)

1200-899

* Titanium Nitrate Coating is a very hard coating that keeps scissors sharper longer, reduces friction and adds a layer of corrosion protection



1200-899

Stussak Metzenbaum Power Cut® Gold Scissors

Strong curve / blunt / 7" (17.8 cm)

1100-235 classic
508-617 PC



508-617

strong curve

Metzenbaum Brophy Sharp/Sharp Tip Scissors

Sharp/sharp tips / power cut / 5 3/4" (14.5 cm)

- 475-158 straight
- 475-160 curved



Sharp/sharp tips / tungsten carbide / delicate / 5 3/4" (14.5 cm)

- 2400-235 straight
- 2400-237 curved

475-158

Sharp/ tungsten carbide / power cut / 5 3/4" (14.5 cm)

- 2400-236 straight
- 2400-238 curved



2400-238

Sharp/sharp tips / tungsten carbide / 7" (18 cm)

- 112-506 curved
- 112-418 straight

Sharp/sharp tips / tungsten carbide / delicate / 7" (18 cm)

- 2400-239 straight
- 2400-240 curved



2400-240

Metzenbaum Brophy Sharp/Sharp Scissors

Sharp/sharp tips / tungsten carbide / delicate / 8" (20 cm)

- 2400-241 straight
- 2400-242 curved

Sharp/sharp tips / tungsten carbide/power cut / curved

- 2400-242T 8" (20 cm)
- 2400-240T 7" (17.8 cm)
- 2400-245T 9" (22.9 cm)

Sharp/sharp tips / tungsten carbide / delicate / 9" (23 cm)

- 2400-243 straight
- 2400-245 curved

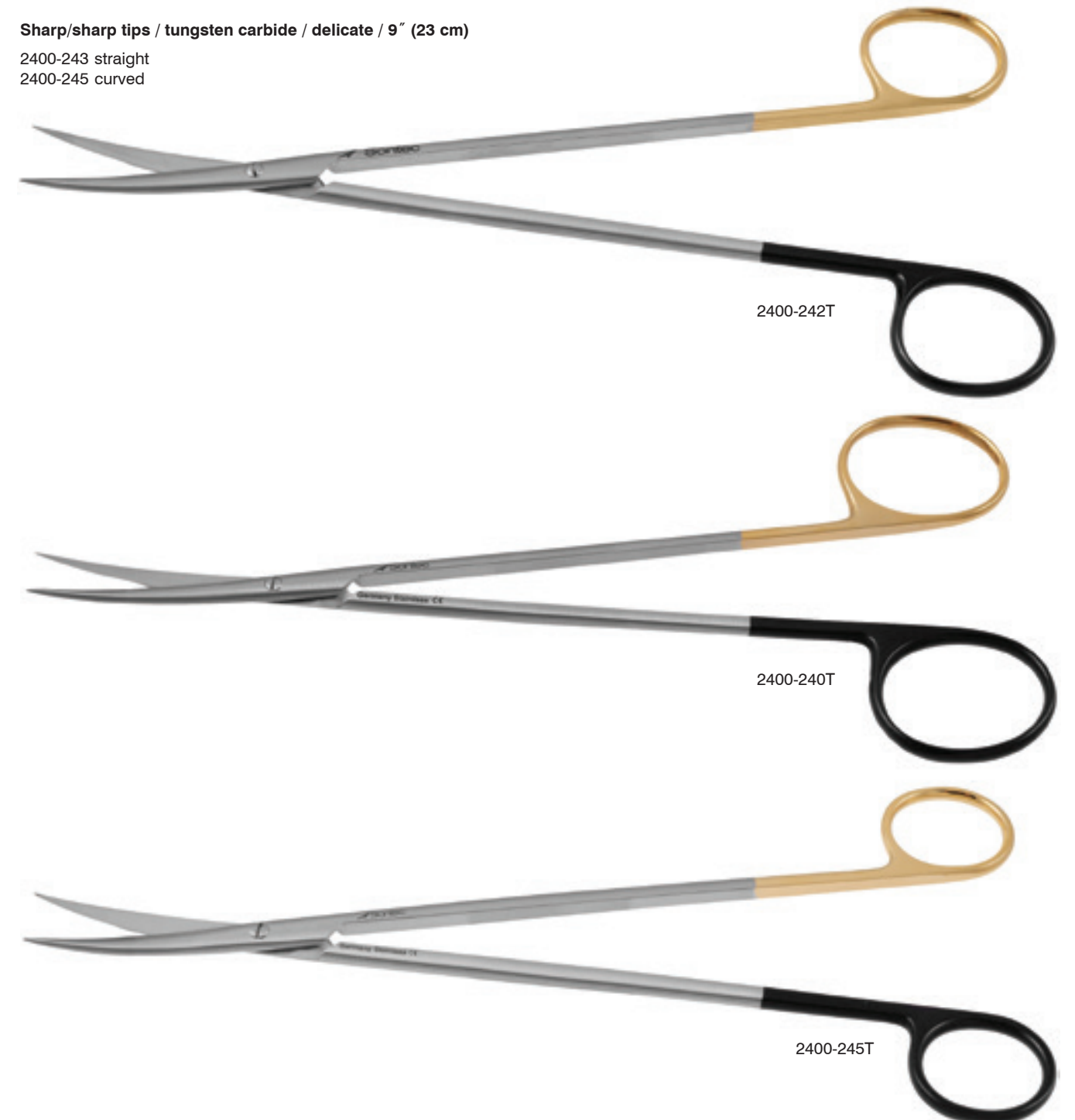

2400-242T

2400-240T

2400-245T



 Sontec Instruments®

Colorectal CLAMPS

Best Colon Clamp

10 3/4" (26.5 cm)

- 10-0570 small jaw
- 10-0571 medium jaw
- 10-0572 large jaw



10-0570

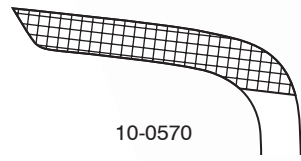

10-0570

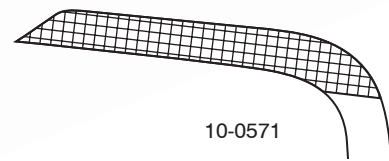

10-0571

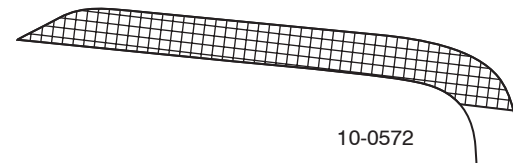

10-0572

Thorlakson Upper Occlusive Clamp

Atraumatic jaw / 11 1/2" (29 cm)

10-0660



10-0660

Resano Sigmoid Anastomosis Clamp

Atraumatic jaw / 12" (30 cm)

10-0565

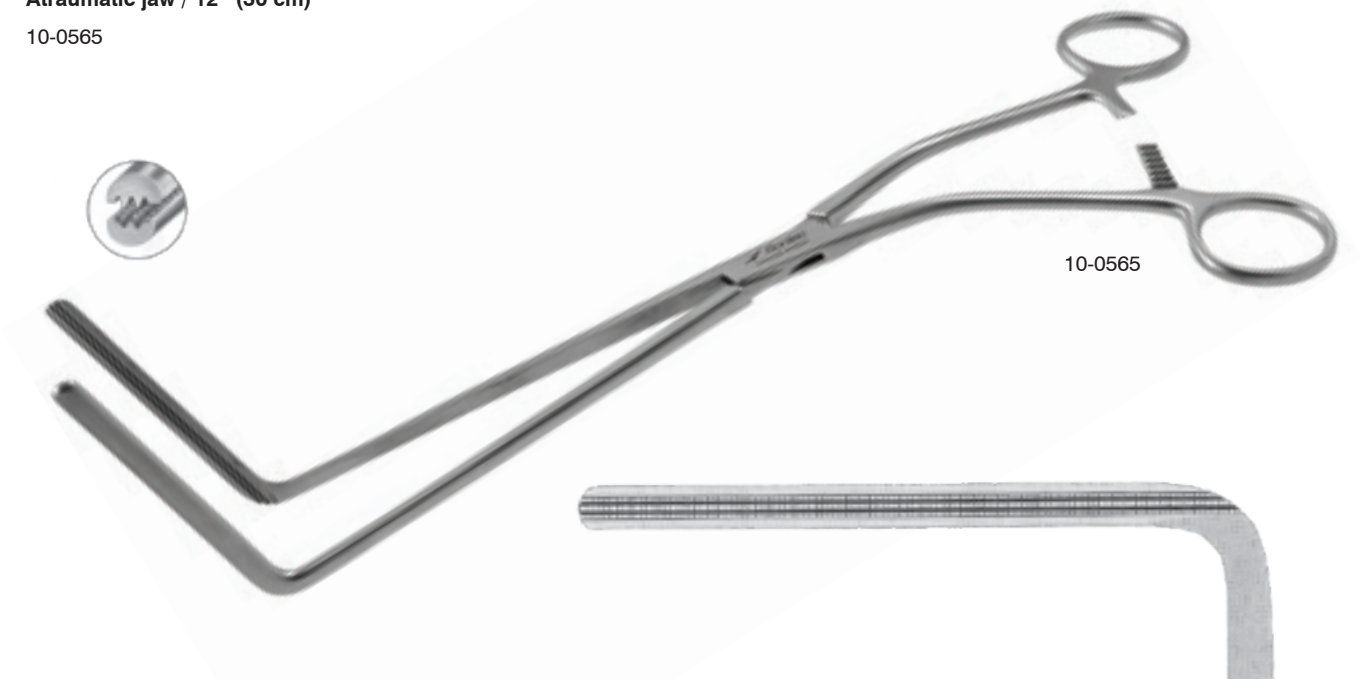

10-0565

Brunner Sigmoid Anastomosis Clamp

9" (26 cm)

142-020

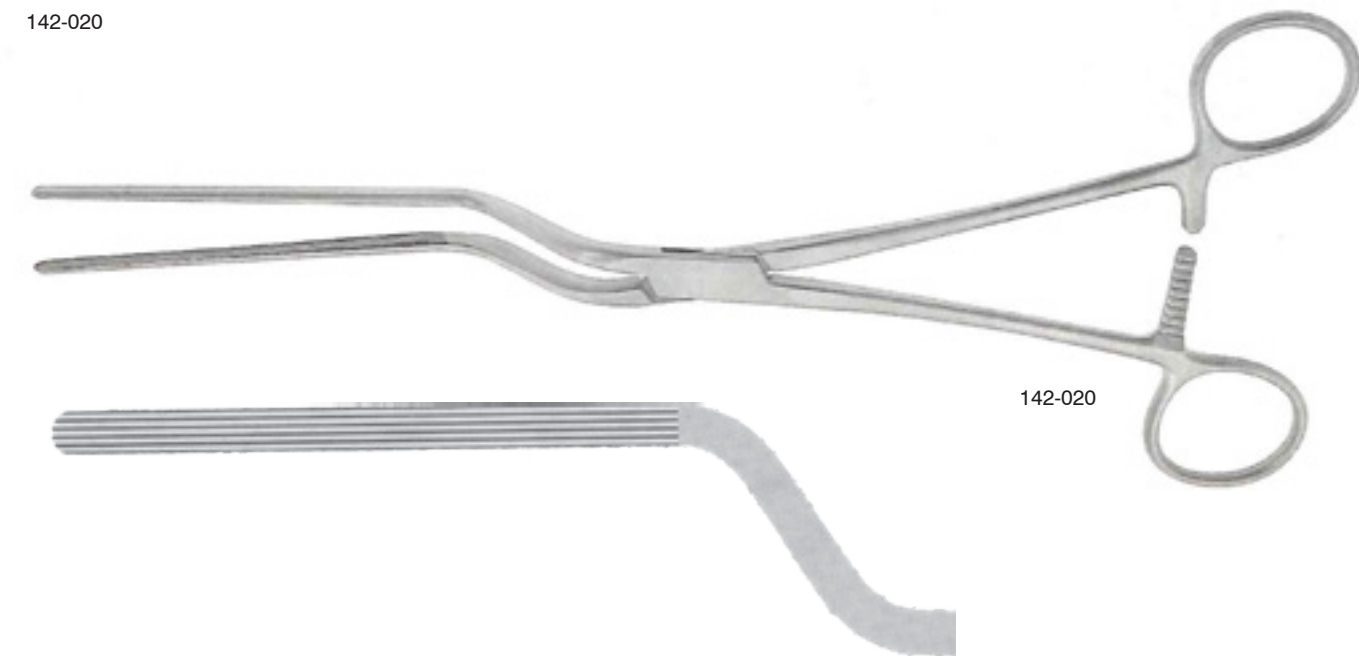

142-020

Thorlakson Lower Occlusive Clamp

Atraumatic jaw / 11 1/2" (29 cm)

- 10-0670 straight
- 10-0671 angled to side 20°



10-0671

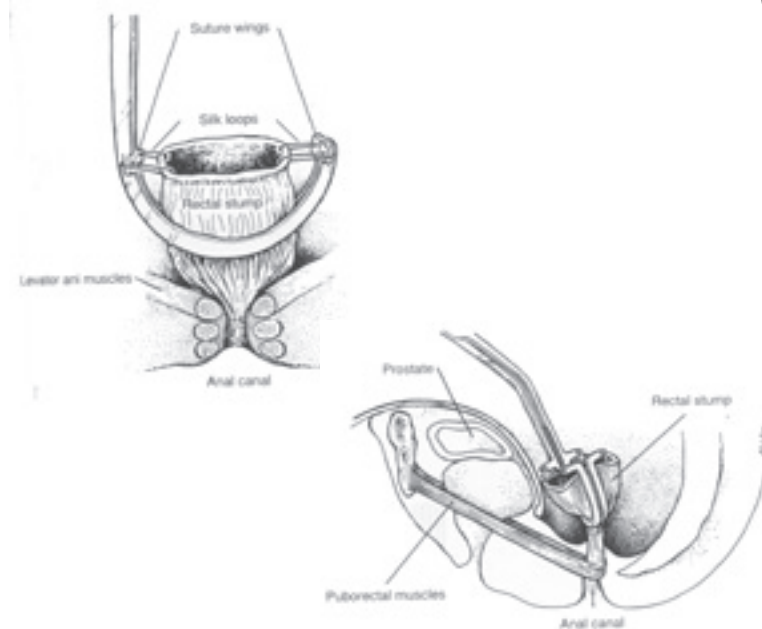
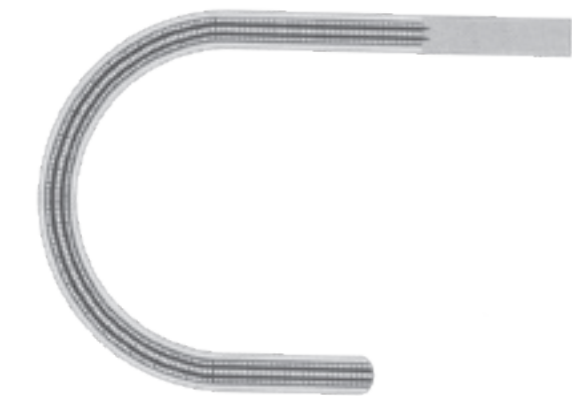
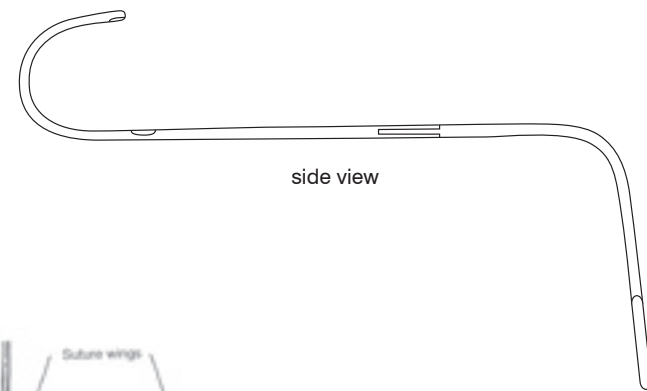
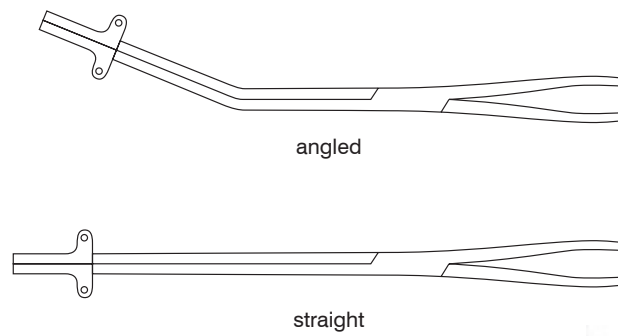

Fehland Sigmoid Anastomosis Clamp

2 x 3 DeBakey jaws / atraumatic jaw / 9 1/2" (24 cm)

10-0562

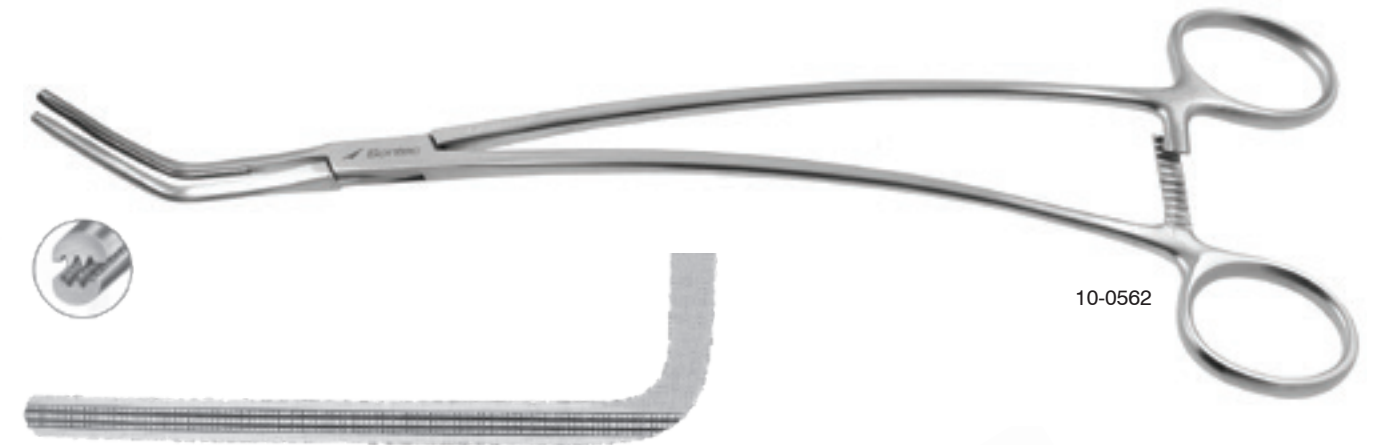

10-0562

Hayes Sigmoid Anastomosis Clamp

2 x 3 DeBakey jaws / atraumatic jaw

- 10-0566 12" (30 cm)
- 10-0567 12 1/4" (31 cm)

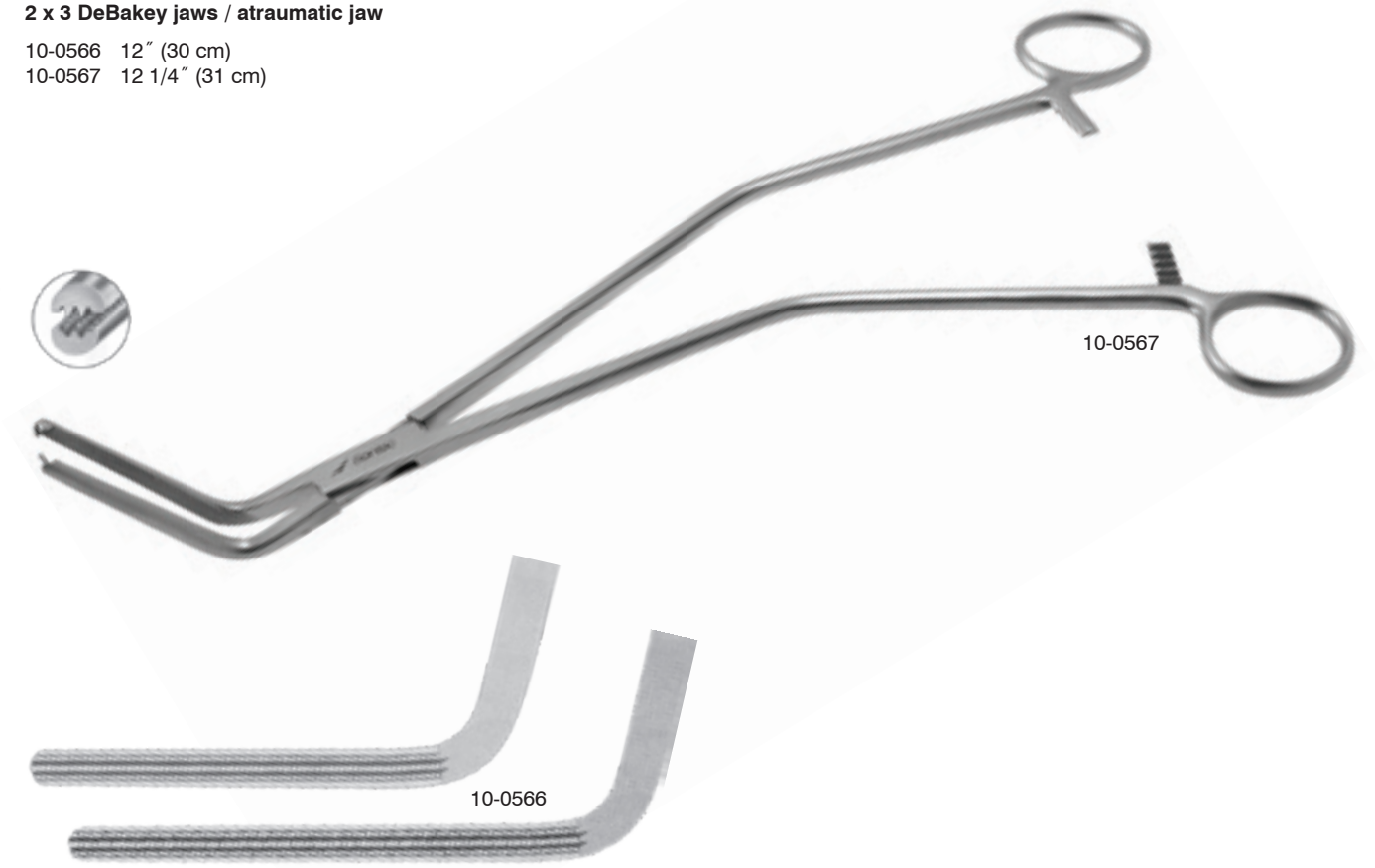

10-0567

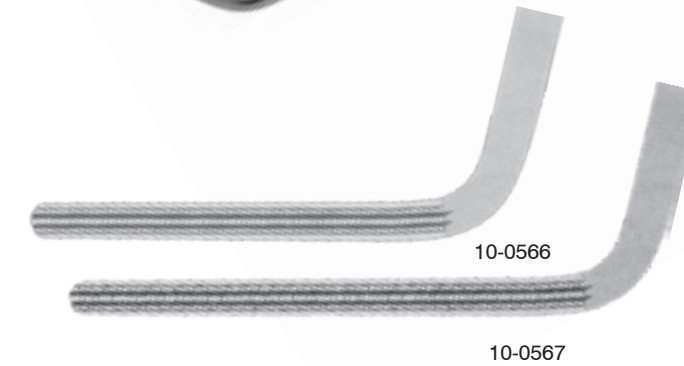

10-0566

10-0567

Lloyd Davis Clamp

12 1/2" (32 cm)
508-630



508-630

Mikulicz Clamp

7 1/2" (19 cm)
10-0580 short
10-0581 long

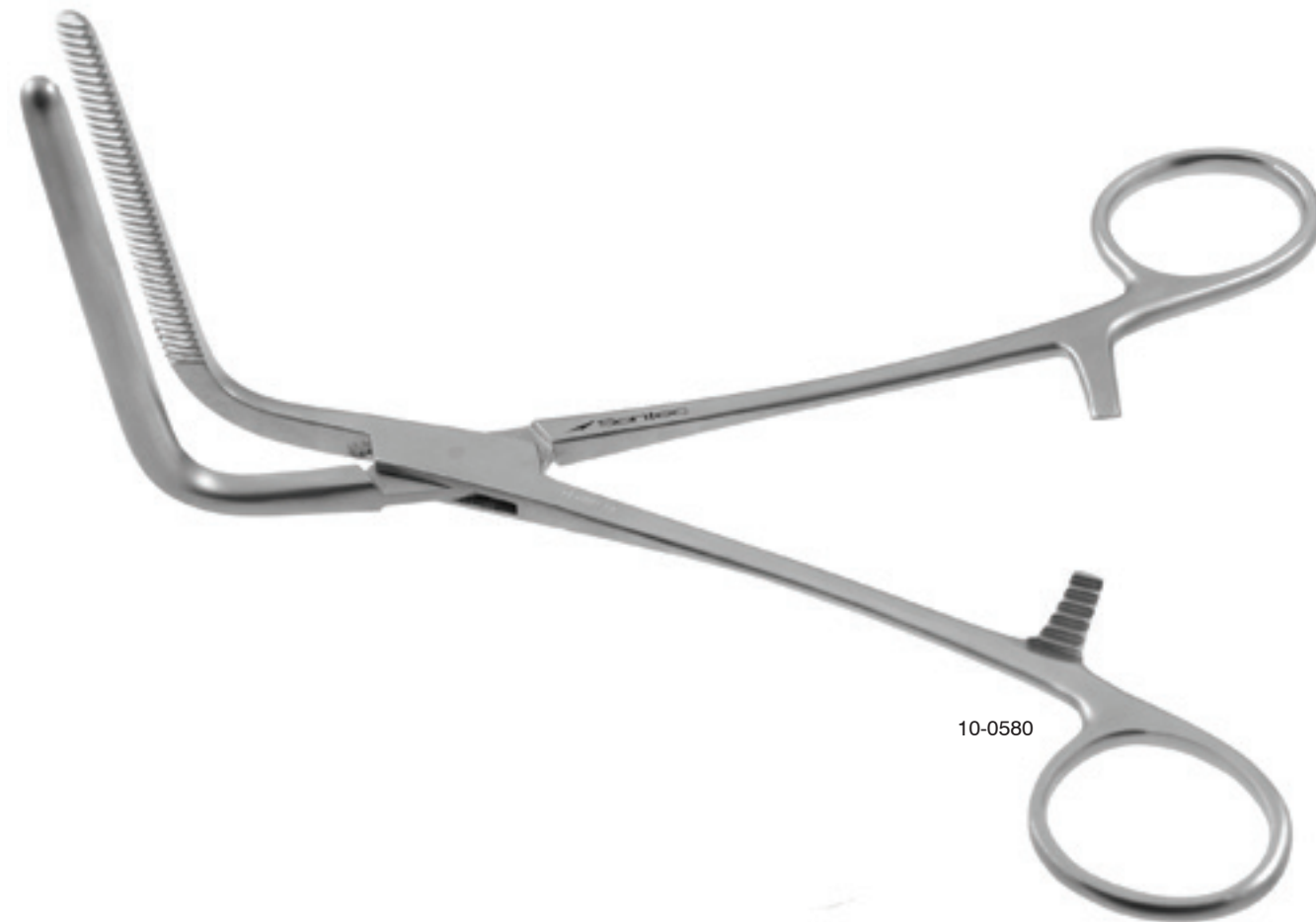

10-0580

Scudder Clamp

Straight
142-030 9 1/2" (24 cm)
142-035 13" (33 cm)

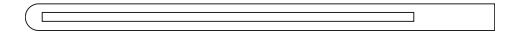

142-035

Payr Intestinal Stomach Clamp

With pin
142-130 6" (15 cm)
142-132 8" (20 cm)
142-137 11 1/2" (29 cm)
142-141 13 3/4" (34.5 cm)

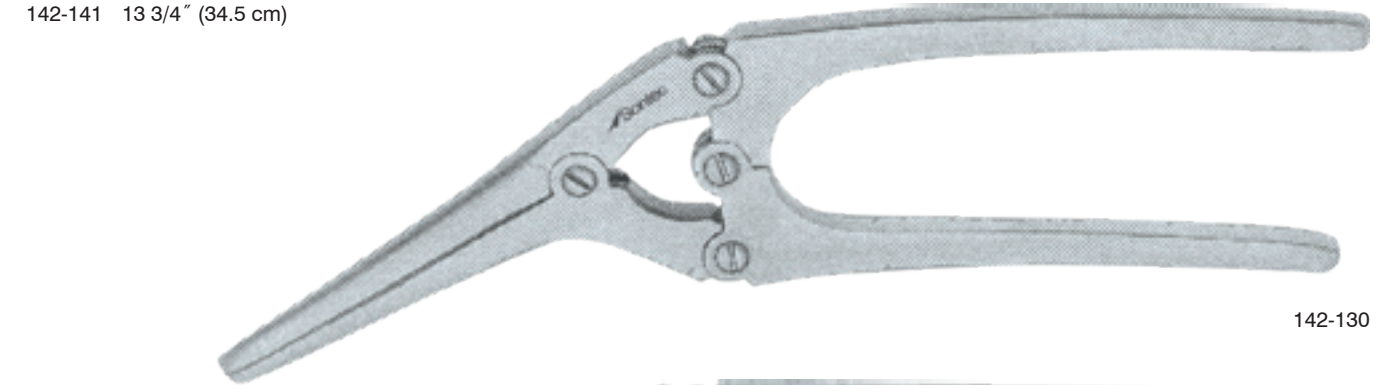

142-130

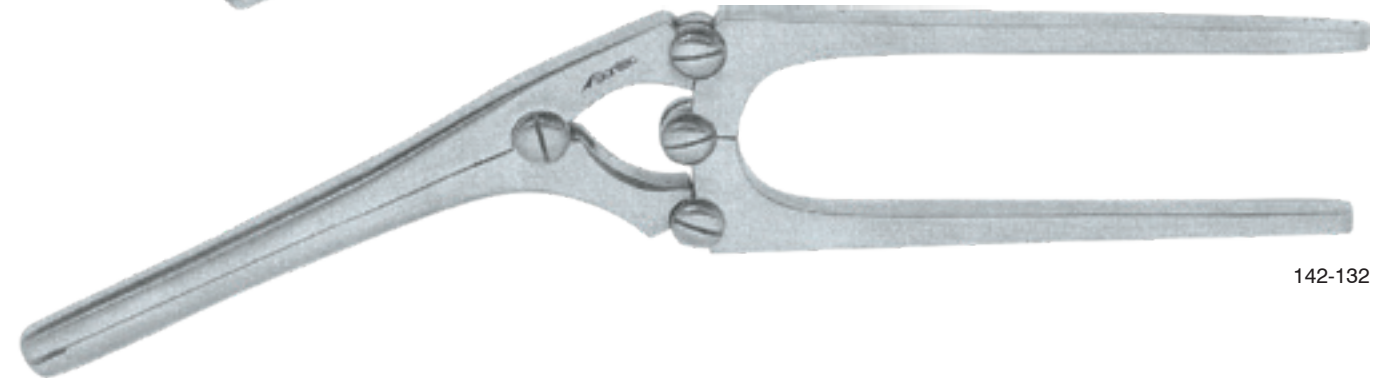

142-132



142-130



142-132



142-137



142-141

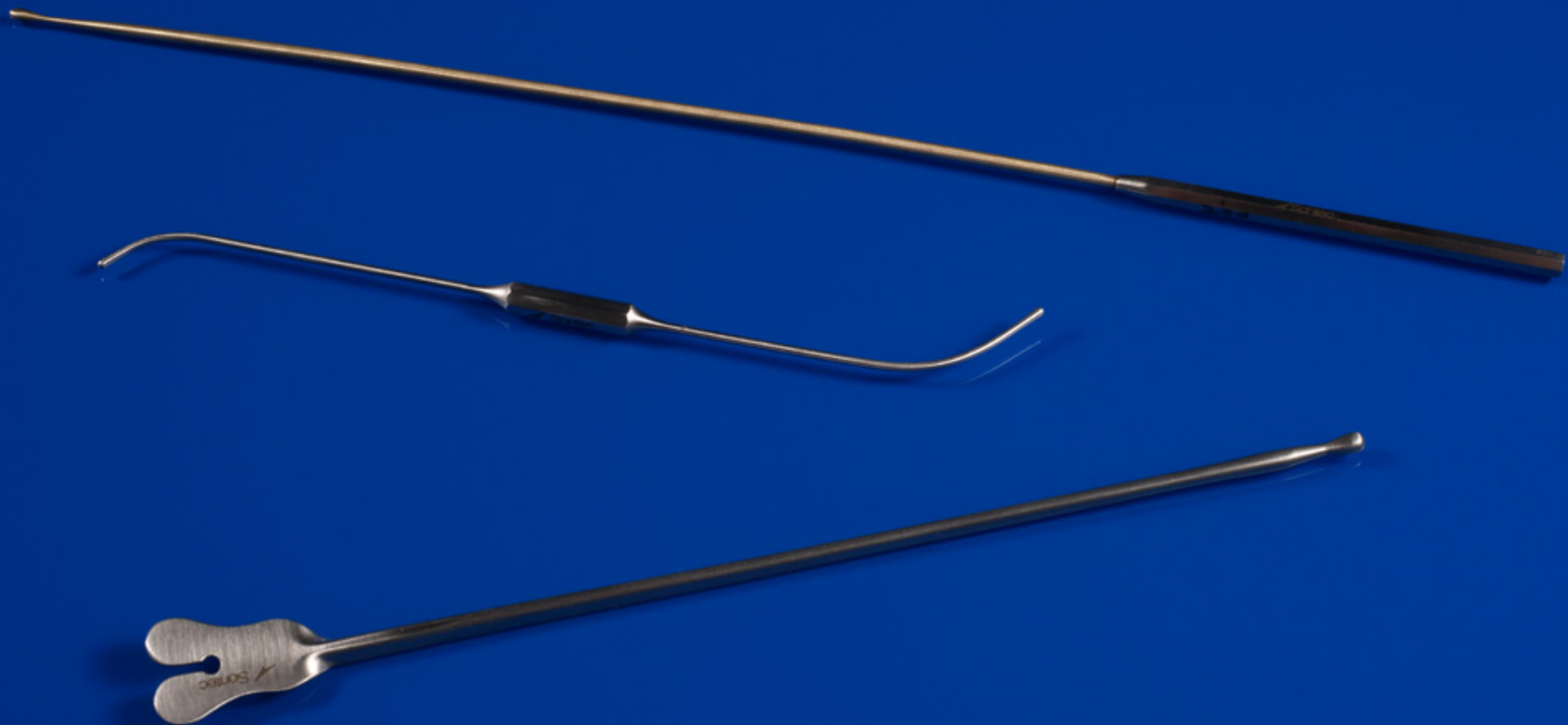

 Sontec Instruments®

Colorectal FISTULA PROBES

Lockhart Mummery Fistula Probe

With eye hole at tip / 6 1/2" (16.5 cm)

- 15-0230 #1 straight
- 15-0231 #2 45° curve
- 15-0232 #3 90° curve
- 15-0233 #4 hook



Grooved Director Tongue Tie

- 197-690 4 1/2" (11.5 cm)
- 197-691 5" (12.5 cm)
- 197-692 5 1/2" (14 cm)
- 197-693 6" (15 cm)
- 197-694 7" (17.8 cm)
- 197-695 8" (20 cm)

With probe point

- 197-700 4 1/2" (11.5 cm)
- 197-701 5" (12.5 cm)
- 197-702 5 1/2" (14 cm)
- 197-703 6" (15 cm)
- 197-704 7" (17.8 cm)
- 197-705 8" (20 cm)



Larry Fistula Probe

Grooved director / 6" (15 cm)

508-544



St. Marks Fistula Probe

Curved / 7" (18 cm)

508-541



Buie Fistula Probe

Sterling silver shaft / 5 3/8" (13.5 cm)

508-536

508-538 heavy



Barr Fistula Probe

11" (28 cm)

508-542 w/ eye at tip

508-543



Barr Double Ended Probe

Double-ended / 7" (18 cm)

508-547



Universal Double Ended Probe

Stainless steel / double-ended

197-670	4 1/2" (11 cm)
197-671	5" (13 cm)
197-672	5 1/2" (14 cm)
197-673	6" (15 cm)
197-674	7" (18 cm)
197-675	8" (20 cm)
197-676	10" (25 cm)
197-677	12" (30 cm)



197-670

Silver / malleable / double-ended

197-6705	4 1/2" (11 cm)
197-6715	5" (13 cm)
197-6725	5 1/2" (14 cm)
197-6735	6" (15 cm)
197-6745	7" (18 cm)
197-6755	8" (20 cm)
197-6765	10" (25 cm)



197-6755

Probe with Eye

Stainless steel

197-660	4 1/2" (11 cm)
197-661	5" (13 cm)
197-662	5 1/2" (14 cm)
197-663	6" (15 cm)
197-664	7" (18 cm)
197-665	8" (20 cm)
197-666	9" (22.9 cm)
197-667	10" (25.4 cm)
197-668	12" (30 cm)



197-666

Silver

197-679	4 1/2" (11 cm)
197-680	5" (13 cm)
197-681	5 1/2" (14 cm)
197-682	6" (15 cm)
197-683	7" (18 cm)
197-684	8" (20 cm)
197-685	9" (22.9 cm)
197-686	10" (25 cm)
197-687	12" (30 cm)



197-682



 Sontec Instruments®

Colorectal HOOKS

Pratt Crypt Hook

8 1/2" (21.5 cm)

- 90-0309 narrow hook
- 90-0311 short hook
- 90-0312 long hook



Stewart Crypt Hook

8 1/2" (21.5 cm)

- 508-640 short hook
- 508-641 long hook



Barr Hook

- One short hook / one long hook / 10" (25 cm)
- 508-545



Rosser Crypt Hook

- 6 5/8" (18 cm)
- 508-546





 Sontec Instruments®

Colorectal LIGATION

Hemorrhoidal Suction Ligator

One handed / includes loading cone / 10 mm in diameter

508-580 down-angle 7 3/4" (19.5 cm) working length
 508-575 up-angle 7 3/4" (19.5 cm) working length



508-575



508-580

Loading Cone for Hemorrhoidal Ligator

10 mm / compatible with 508-580 & 508-575

508-570



Latex O-rings

Bag of 100

508-551 regular
 508-551N latex free



508-551

O-Ring Hemorrhoid Band Cutter

6 1/2" (16.5 cm)

508-556



508-556

Eder Cotton Carrier

14 1/2" (37 cm)

90-0351



90-0351

McGivney Ligator

Includes loading cone and
100 Latex O-rings / 12 mm in
diameter / 7" (18 cm) working
length

508-550

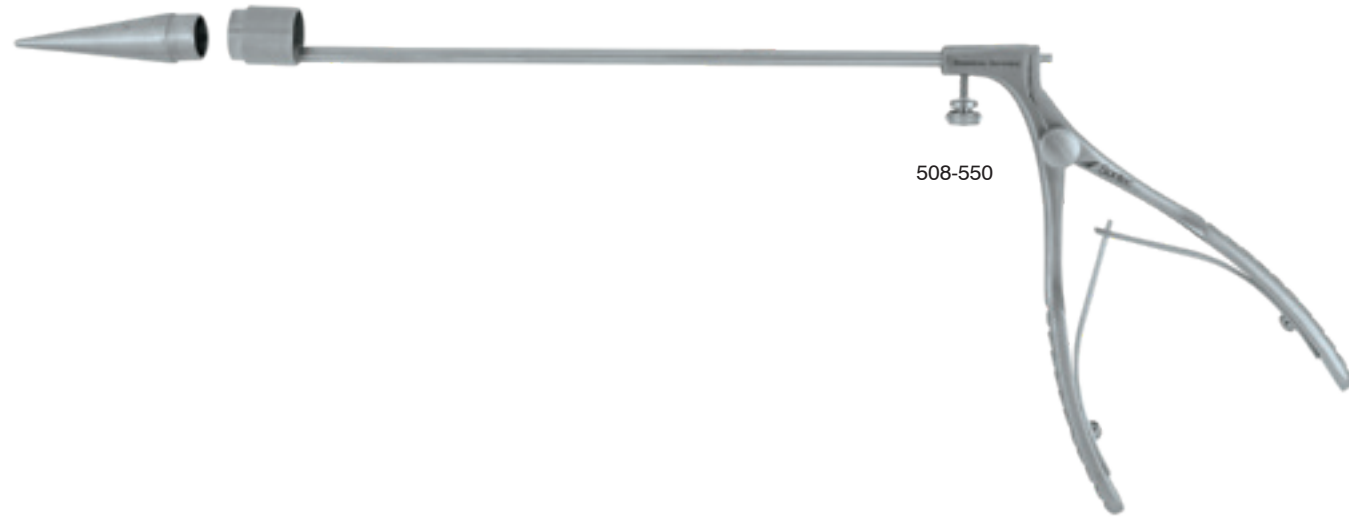

Ford-Dixon Ligator

Includes loading cone and
100 Latex O-rings / 12 mm
in diameter / 7 1/2" (19 cm)
working length

508-560



Simple Style Ligator

Includes loading cone / 12
mm in diameter / 7" (18 cm)
working length

508-561



Self Loading Hemorrhoidal Ligator

Rotates 360° / includes loading cone / 10 mm in
diameter / straight / 9 1/2" (24 cm) working length

508-585





 Sontec Instruments®

Colorectal RETRACTORS

Thorlakson Abdominal Hand Retractor

13 1/2" in length

	A	B
20-1862	170 mm	40 mm
20-1864	170 mm	50 mm
20-1866	170 mm	65 mm

Illuminated	A	B
20-2862	170 mm	40 mm
20-2864	170 mm	50 mm
20-2866	170 mm	65 mm

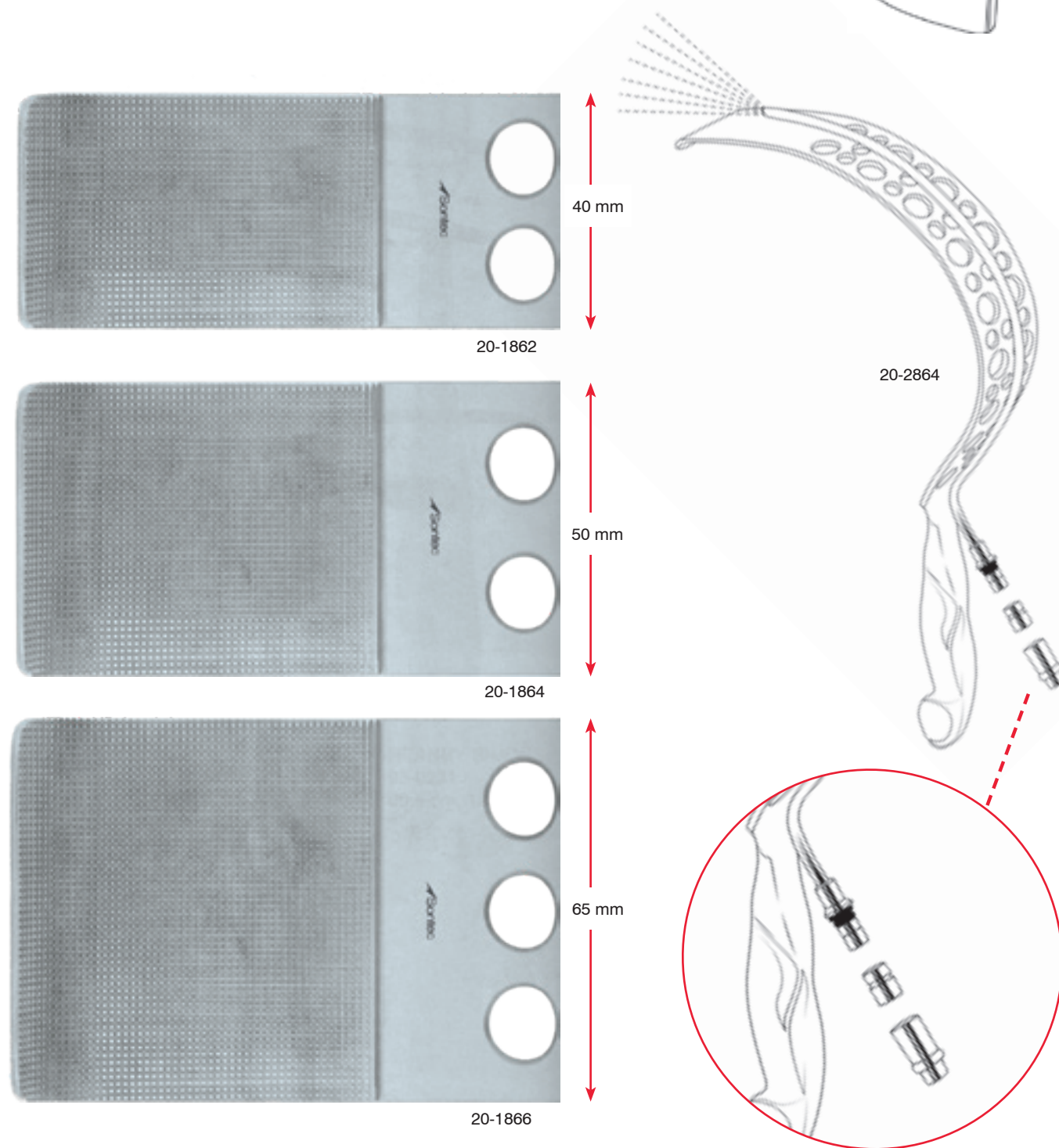

Thorlakson Simple Hand Retractor

Double-ended / 10" (25 cm)

20-0440	25 mm	1"
20-0442	35 mm	1.5"
20-0444	50 mm	2"

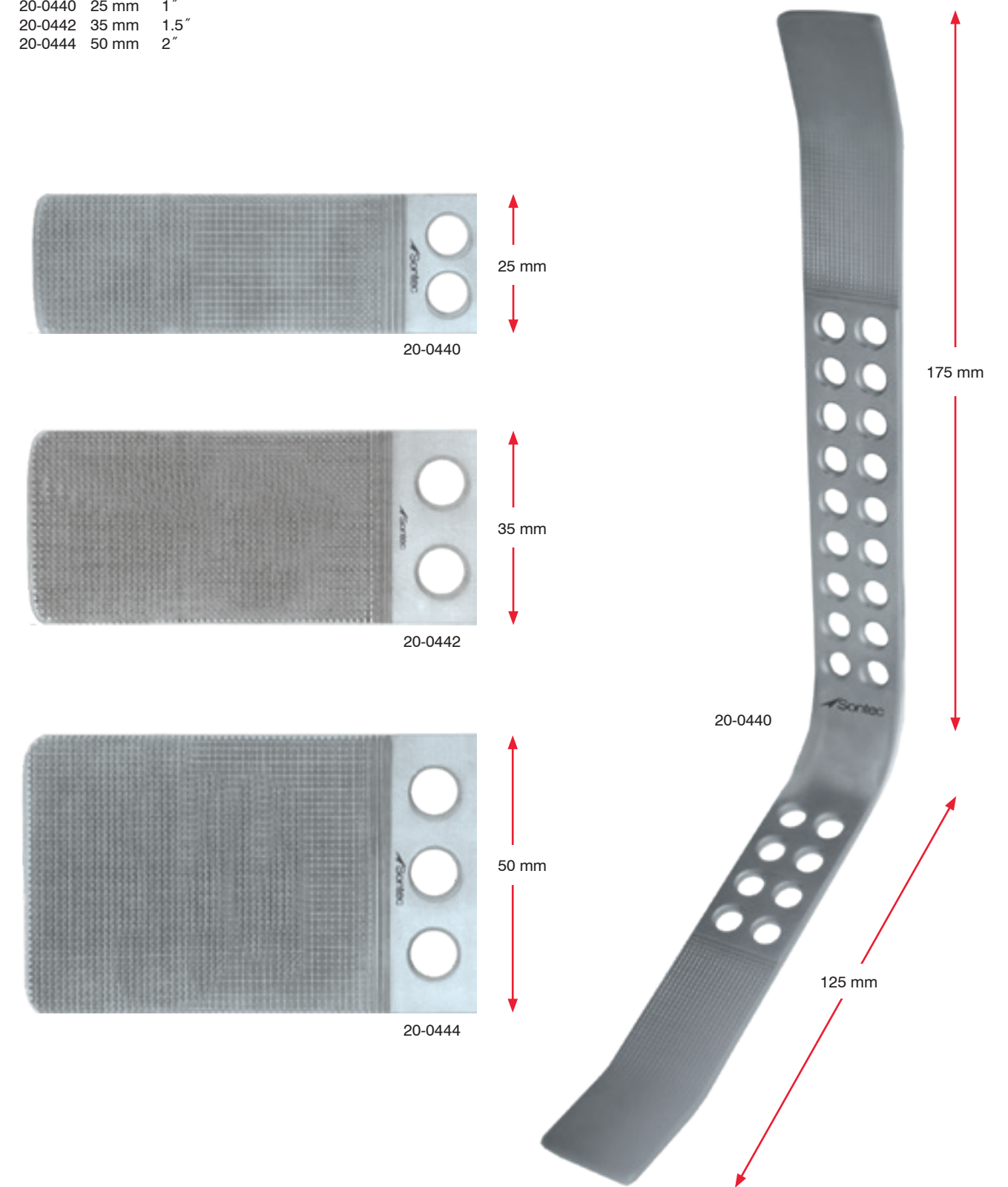

Alan-Parks Rectal Retractor System

Ball-snap closure

90-0115	complete set	
90-0116	spreader	5 3/4" (14.5 cm)
90-0117	lateral valves, pair	75 x 22 mm
90-0118	lateral valves, pair	95 x 22 mm
90-0119	central valve	95 x 22 mm



Barr Rectal Retractor

self retaining blades

2 3/4" (7 cm) x 7/8" (2.2 cm)
508-330 8" (20 cm)



St. Marks Perineal Retractor

Deep Blades / sold separately in pairs

- 508-300 includes handle & all 3 sizes of blades
- 508-303 1 3/4" (4.5 cm) blades
- 508-302 3" (7.5 cm) blades
- 508-304 4" (10 cm) blades

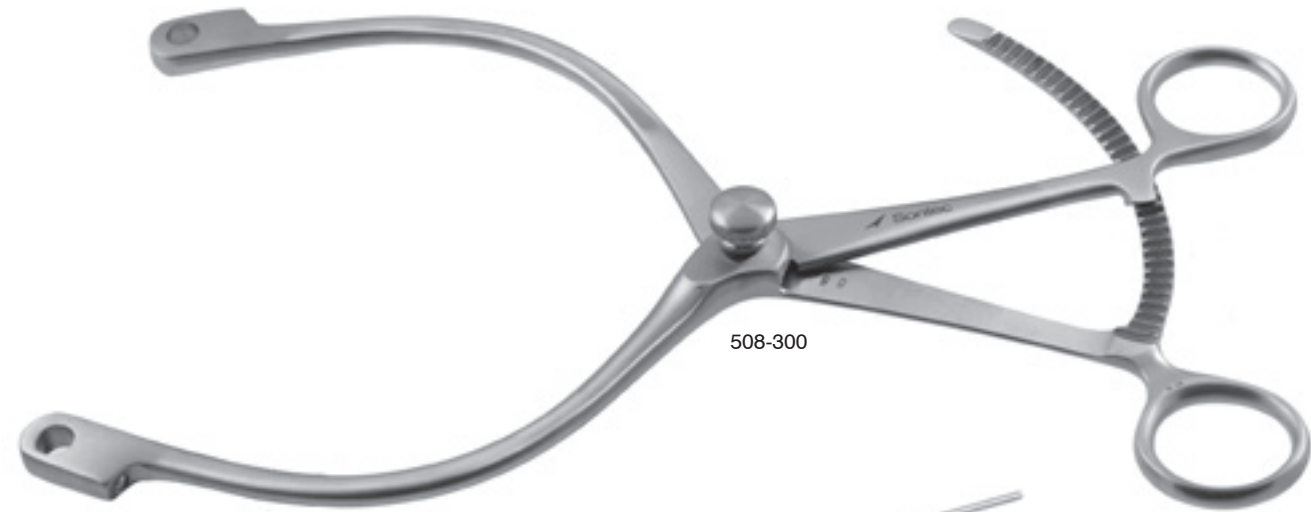

Sontec-Millins Bladder Retractor

**One center blade / two sets of blades / pair
A - 60 x 25 mm / pair B - 85 x 25 mm / center
blade-110 x 45 mm**

516-190 10" (25 cm)

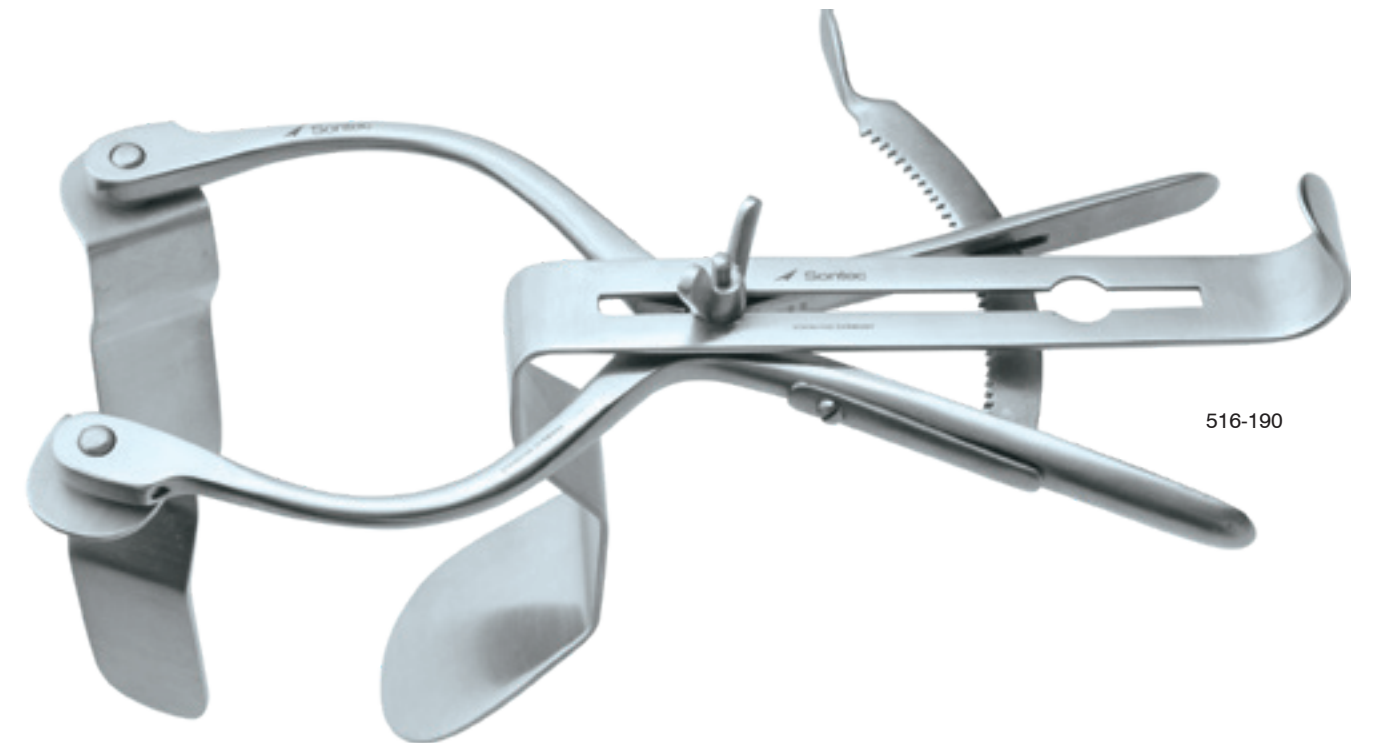

Collin Retractor

	Lateral Blades		Center Blades		Blade Opening
	A	B	A	B	C
21-0350	1 1/2" (3.8 cm)	2 1/2" (6.4 cm)			4" (10 cm)
21-0355	1 1/4" (3.2 cm)	2 7/16" (6.2 cm)	2 1/8" (5.5 cm)	2 1/8" (5.5 cm)	3" (7.5 cm)
21-0356	1 1/2" (3.8 cm)	3 1/8" (8 cm)	2 1/8" (5.5 cm)	2 9/16" (6.5 cm)	3" (7.5 cm)
21-0357	1 1/2" (3.8 cm)	4" (10 cm)	2 1/8" (5.5 cm)	3" (7.5 cm)	3" (7.5 cm)



21-0350



21-0355

Sawyer Rectal Retractor

- 90-0260 2 1/2" x 7/8" blade
- 90-0261 3" x 1 1/8" blade
- 90-0262 3 1/2" x 1 1/2" blade



90-0262

Hill-Ferguson Retractor

Original design

90-0270	small	7/8" (2 cm)w x 2 5/8"l
90-0271	medium	1 1/8" (3 cm)w x 3" l
90-0272	large	1 3/8" (3.5 cm)w x 3 1/8"l
90-0273	x-large	1 1/2" (4 cm)w x 3 1/4"l



90-0271

Hill-Ferguson Retractor

With reverse handle / original design

90-0270R	small	7/8" (2 cm)w x 2 5/8"l
90-0271R	medium	1 1/8" (3 cm)w x 3" l
90-0272R	large	1 3/8" (3.5 cm)w x 3 1/8"l
90-0273R	x-large	1 1/2" (4 cm)w x 3 1/4"l



St. Marks Hand Retractor

With lip

508-322	5" (12.5 cm) blade	angled handle
508-323	7" (18 cm) blade	straight handle
508-323A	7" (18 cm) blade	angled handle
508-325	7" (18 cm) blade	tapers to 3.5 cm angled tip
508-326S	9" (23 cm) blade	angled handle
508-326	9" (23 cm) blade	angled 15° at tip
508-327	11" (28 cm) blade	angled 15° at tip

With lip / with fiber optic light carrier illuminated with universal connector

508-323L	7" (18 cm) blade	angled handle
508-325L	7" (18 cm) blade	tapers to 3.5 cm angled tip
508-326L	9" (23 cm) blade	angled 15° at tip
508-327L	11" (28 cm) blade	angled 15° at tip

Without lip

508-324	7" (18 cm) blade	angled handle
---------	------------------	---------------

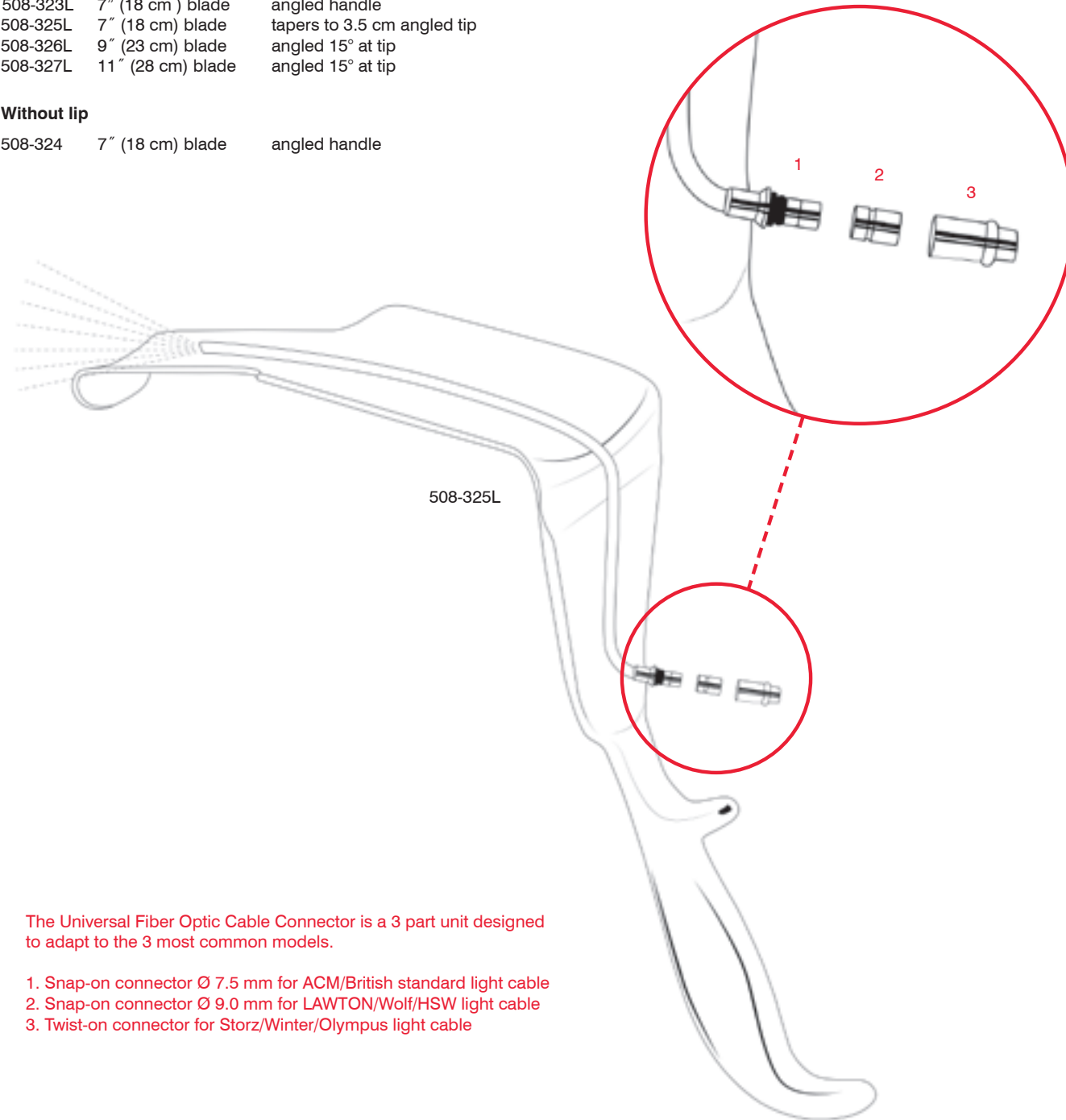

The Universal Fiber Optic Cable Connector is a 3 part unit designed to adapt to the 3 most common models.

1. Snap-on connector Ø 7.5 mm for ACM/British standard light cable
2. Snap-on connector Ø 9.0 mm for LAWTON/Wolf/HSW light cable
3. Twist-on connector for Storz/Winter/Olympus light cable



Foss Retractor

14" (35.5 cm) in length

	A	B
20-1872	165 mm	50 mm

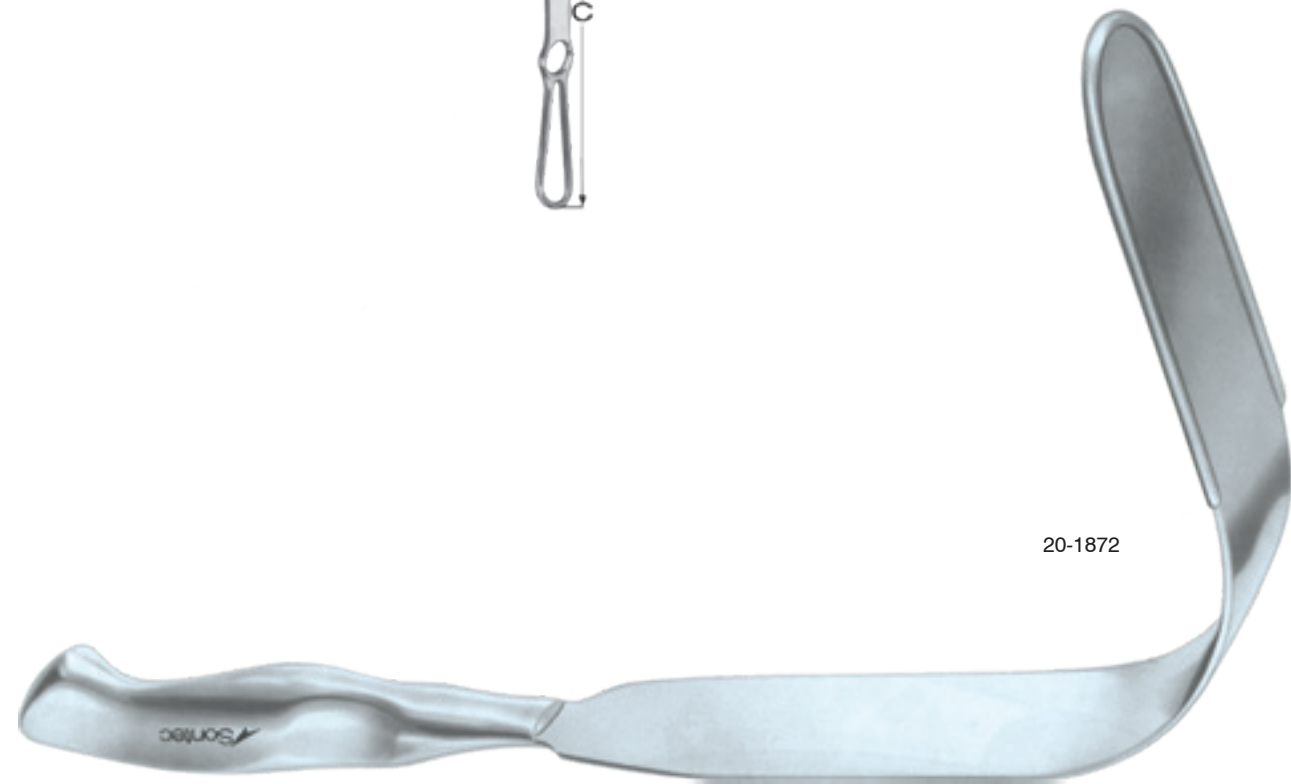

Legueu Retractor

10 3/4" (26.5 cm) in length

	A	B
92-0145	105 mm	35 mm

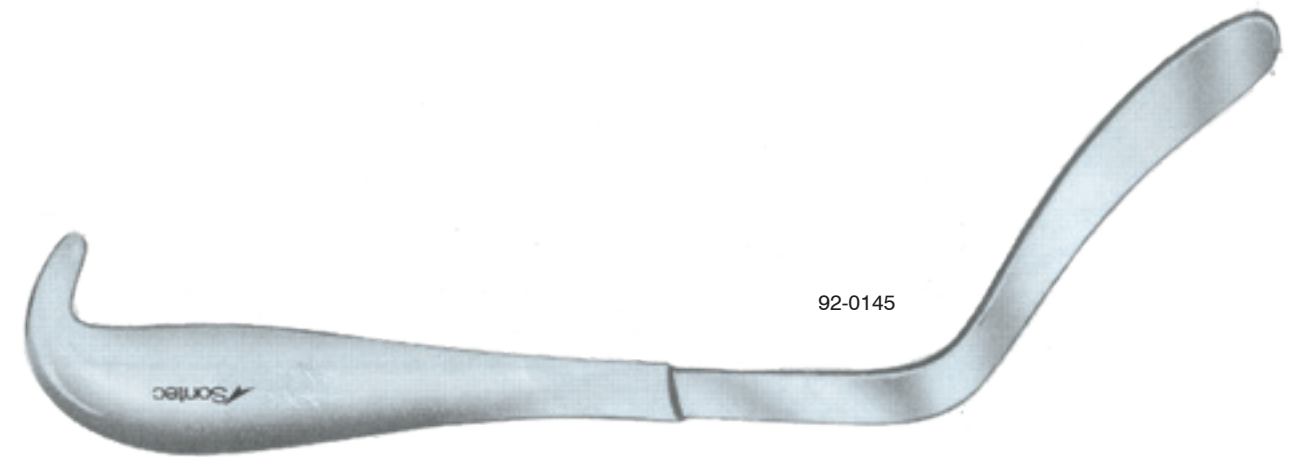

Christie Retractor

15" (38 cm) in length

	A	B
20-1887		75 mm



20-1887

Murphy Abdominal Retractor

11" (28 cm) in length

	A	B
20-1870	100 mm	32 mm
20-1871	100 mm	50 mm



20-1870

Koerte Retractor

11" (28 cm) in length

	A	B
20-0905	130 mm	46 mm

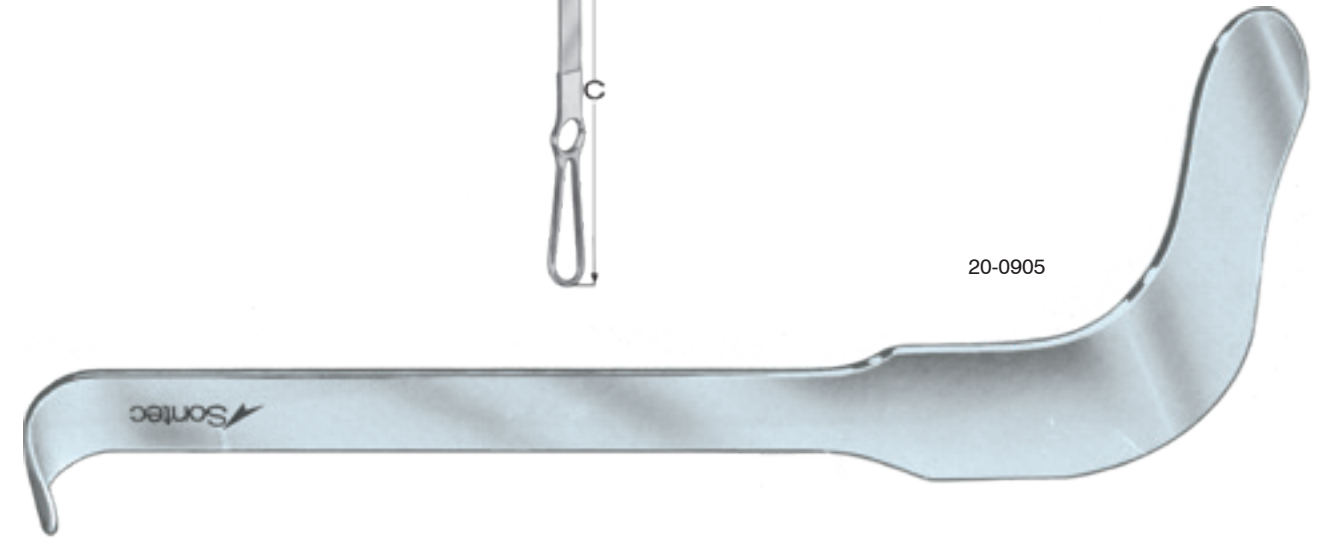

20-0905

Kummel Retractor

11" (28 cm) in length

	A	B
20-0910	100 mm	46 mm



20-0910

Harrington Retractor

	A	B	C
20-0878	76 mm	22 mm	12 1/2" (32 cm)
20-0880	150 mm	41 mm	12 1/2" (32 cm)
20-0881	150 mm	62 mm	12 1/2" (32 cm)
20-1877	150 mm	41 mm	12 1/3" (34 cm)
20-1878	150 mm	62 mm	13 1/2" (34 cm)

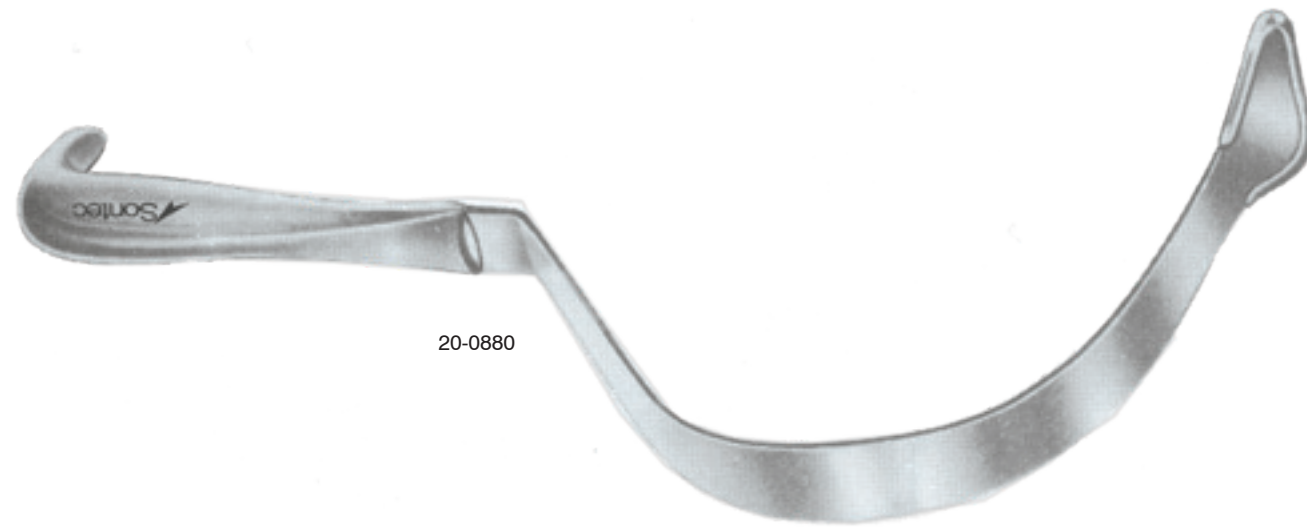

20-0880

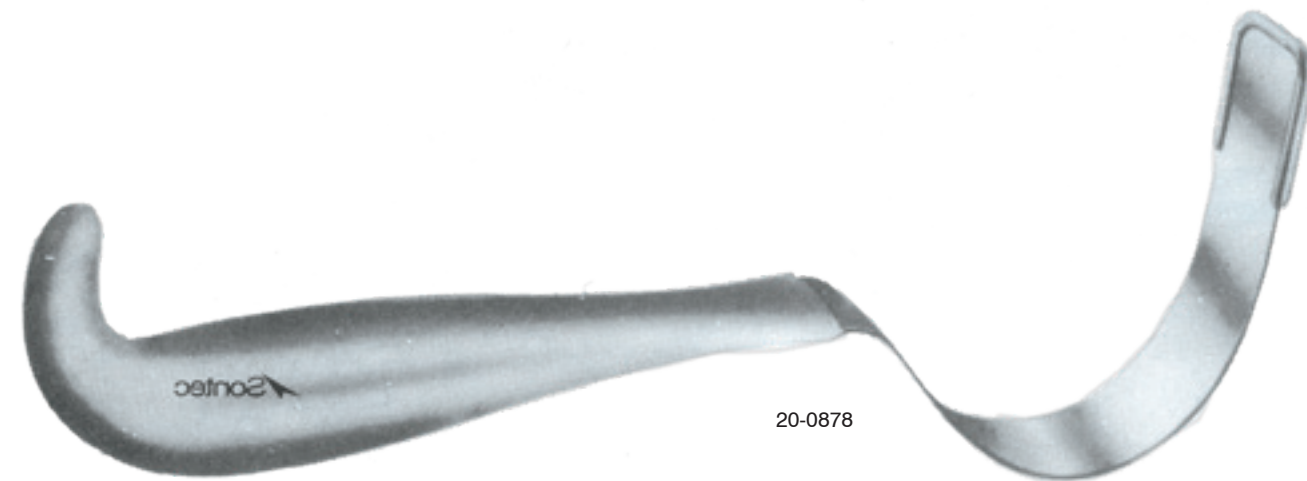

20-0878

Lawton Retractor

13" (33 cm) in length

- 20-1910 3/4" blade
- 20-1911 1" blade
- 20-1912 1 1/4" blade
- 20-1913 1 1/2" blade
- 20-1914 1 3/4" blade
- 20-1915 2" blade
- 20-1916 2 1/2" blade
- 20-1917 3" blade



20-1911

Harrington-Pemberton Retractor

	A	B	C
20-0882	150 mm	60 mm	13" (33cm)

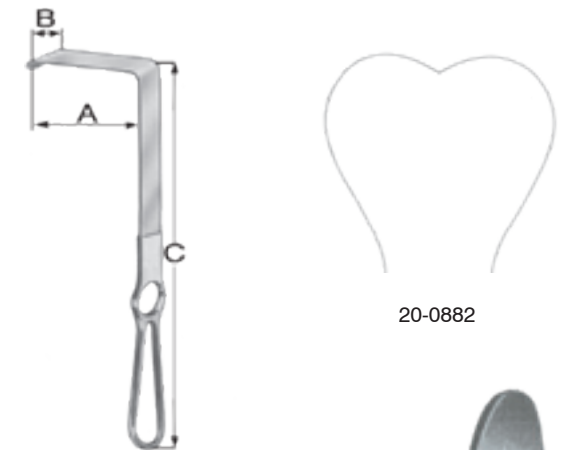

20-0882

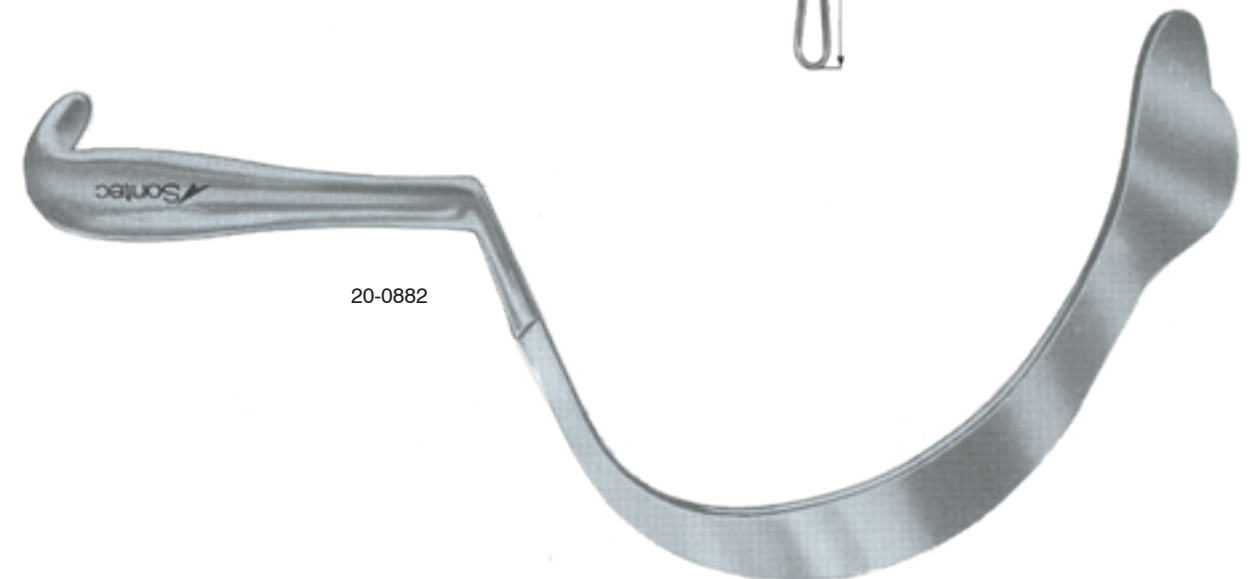

20-0882

Brunner Retractor

	A	B	C
20-0792	80 mm	20 mm	10" (25 cm)
20-0793	100 mm	20 mm	10" (25 cm)
20-0794	120 mm	25 mm	10" (25 cm)
20-0795	140 mm	25 mm	10" (25 cm)
20-0796	160 mm	30 mm	10" (25 cm)
20-0797	180 mm	30 mm	10" (25 cm)

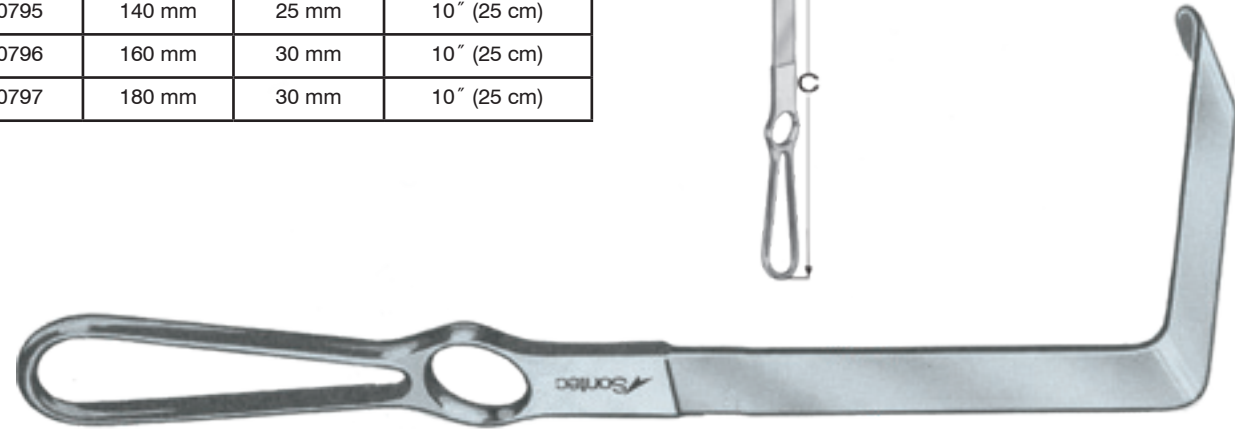

20-0792

Kelly Retractor

	A	B	C
20-0940	160 mm	38 mm	10 3/4" (27 cm)



20-0940

Mikulicz Retractor

	A	B	C
20-0930	85 mm	35 mm	10" (25 cm)
20-0931	85 mm	35 mm	9 1/2" (24 cm)
20-0932	120 mm	50 mm	10 1/4" (26 cm)
20-0933	155 mm	50 mm	10 1/4" (26 cm)



20-0932

20-0931

Kocher Retractor

	A	B	C
92-0150	88 mm	35 mm	10 1/4" (26 cm)
92-0160	108 mm	57 mm	10 1/4" (26 cm)

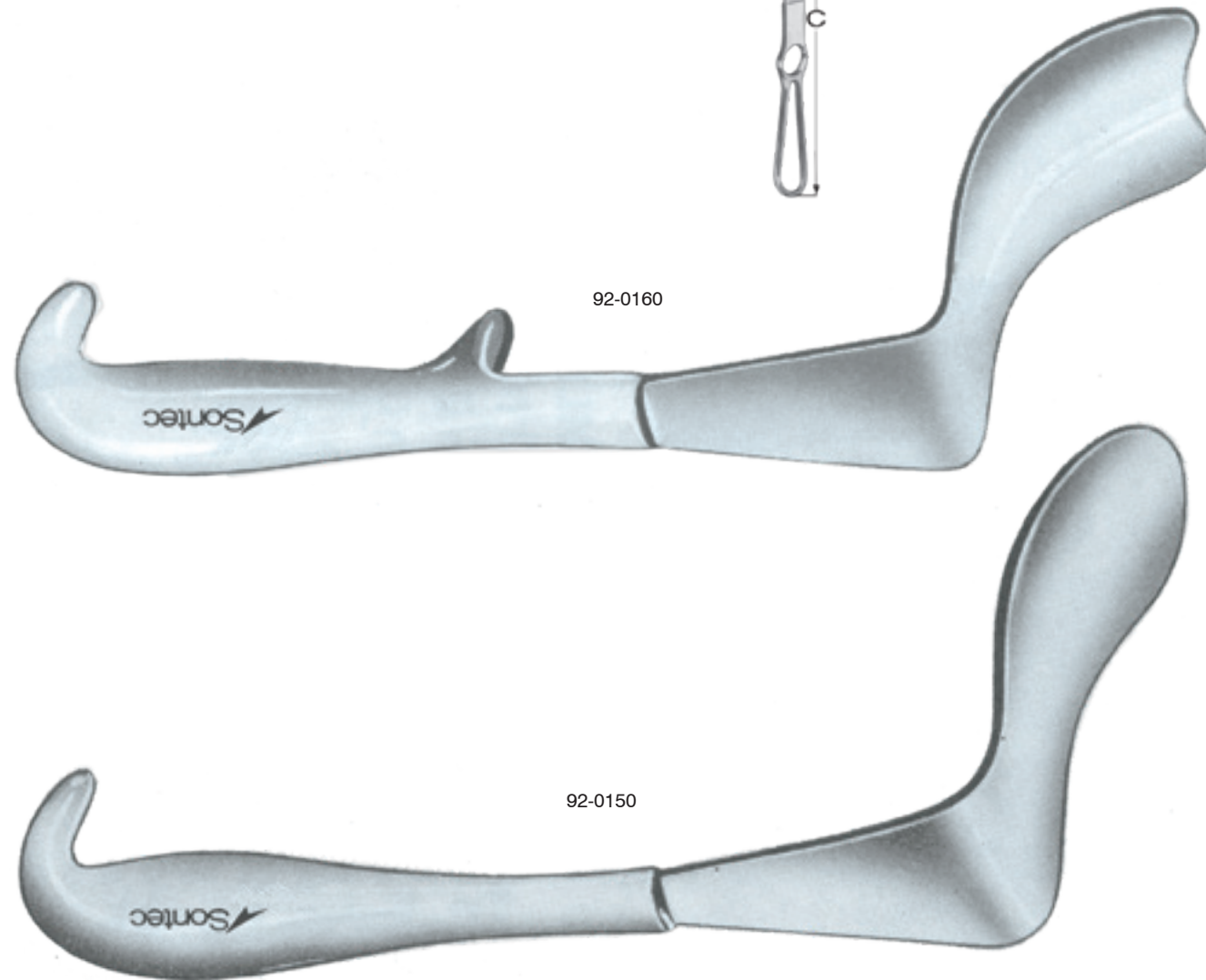

Deaver & Ford Retractor

	A	B	C
20-1811	4" (10 cm)	1" (2.5 cm)	9" (22.9 cm)
20-1816	4" (10 cm)	1" (2.5 cm)	12" (30 cm)
20-1821	4" (10 cm)	1" (2.5 cm)	13" (33 cm)
20-1826	4" (10 cm)	1" (2.5 cm)	14" (35.5 cm)
20-1831	4" (10 cm)	1 1/2" (4 cm)	12" (30.5 cm)
20-1836	4" (10 cm)	2" (5 cm)	12" (30.5 cm)
20-1841	4" (10 cm)	3" (7.5 cm)	12" (30.5 cm)
20-1845	4" (10 cm)	4" (10 cm)	14" (35.5 cm)
20-1793	5" (15 cm)	3" (7.5 cm)	17" (40.5 cm)
20-1792	6" (15 cm)	2" (5 cm)	16" (40.5 cm)
20-1794	6" (15 cm)	4" (10 cm)	16" (40.5 cm)



Wylie Deep Pelvic Retractor

508-318 blade 7" x 1"
 508-319 blade 10" x 1"

With illumination tube

508-318L blade 7" x 1"
 508-319L blade 10" x 1"

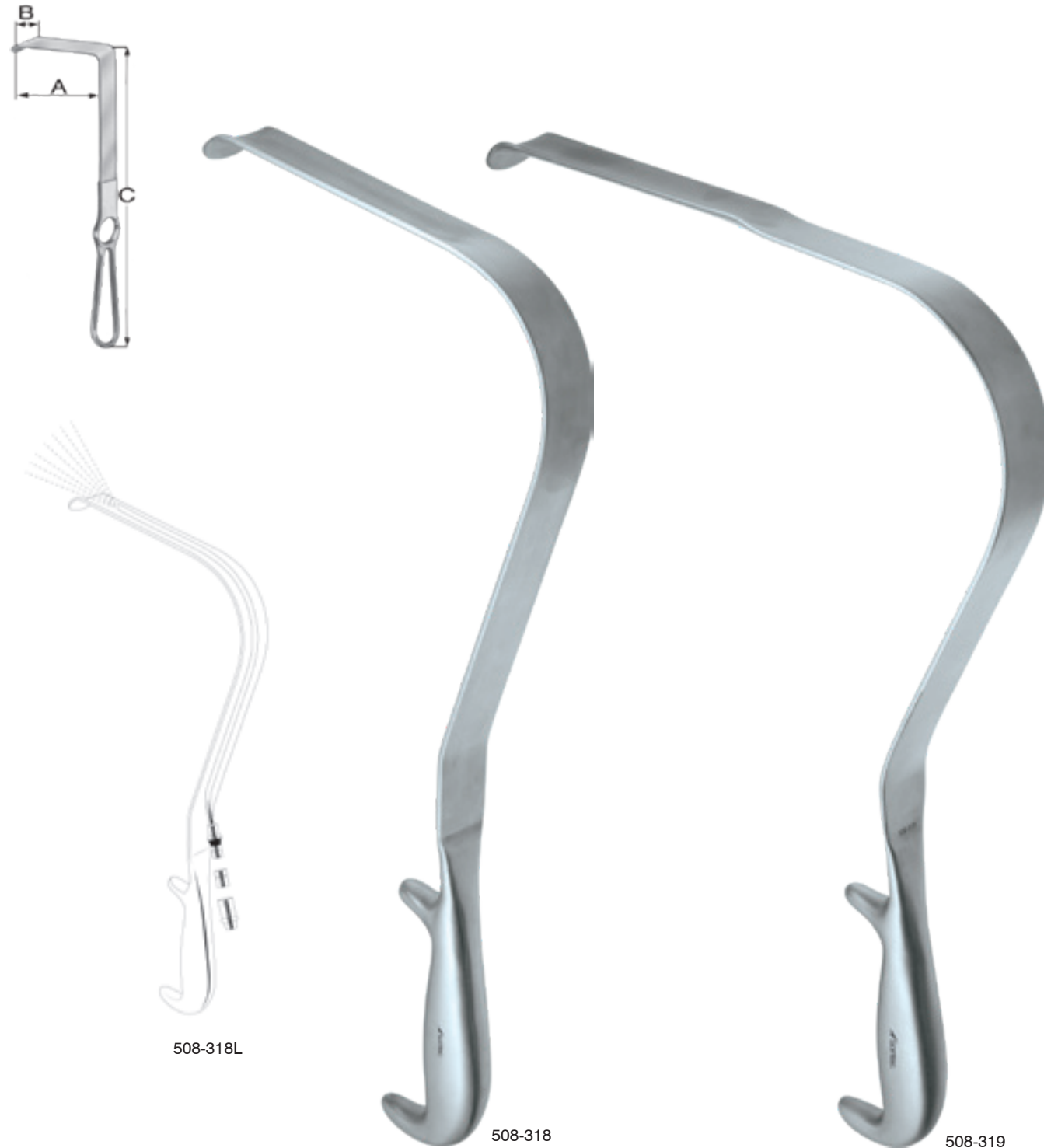

Obwegeser Retractor

8 3/4" (22.2 cm)

207-240	7 x 25 mm	curved down
207-241	10 x 42 mm	curved down
207-242	12 x 55 mm	curved down
207-243	14 x 70 mm	curved down
207-244	16 x 80 mm	curved down
207-245	13 x 42 mm	curved up
207-246	12 x 60 mm	curved up
207-247	16 x 80 mm	curved up



Smith-Buie Rectal Retractor

Self-retaining / 4" (10 cm)

508-335	2 1/2 x 7/8"
508-336	4 x 7/8"





 Sontec Instruments®

Colorectal SPECULUMS

Pratt Rectal

With screw set / 3 1/2" x 1" / 8 3/4"
(22 cm)

508-310



508-310

Bodenhammer Rectal

With screw set / 3 1/2" x 3/4" / 6" (15 cm)

508-315



508-315

Sims Rectal

With screw set / 3 1/2" x 5/8" / 6" (15 cm)

508-320



508-320

Barr-Shuford Rectal Speculum

508-328

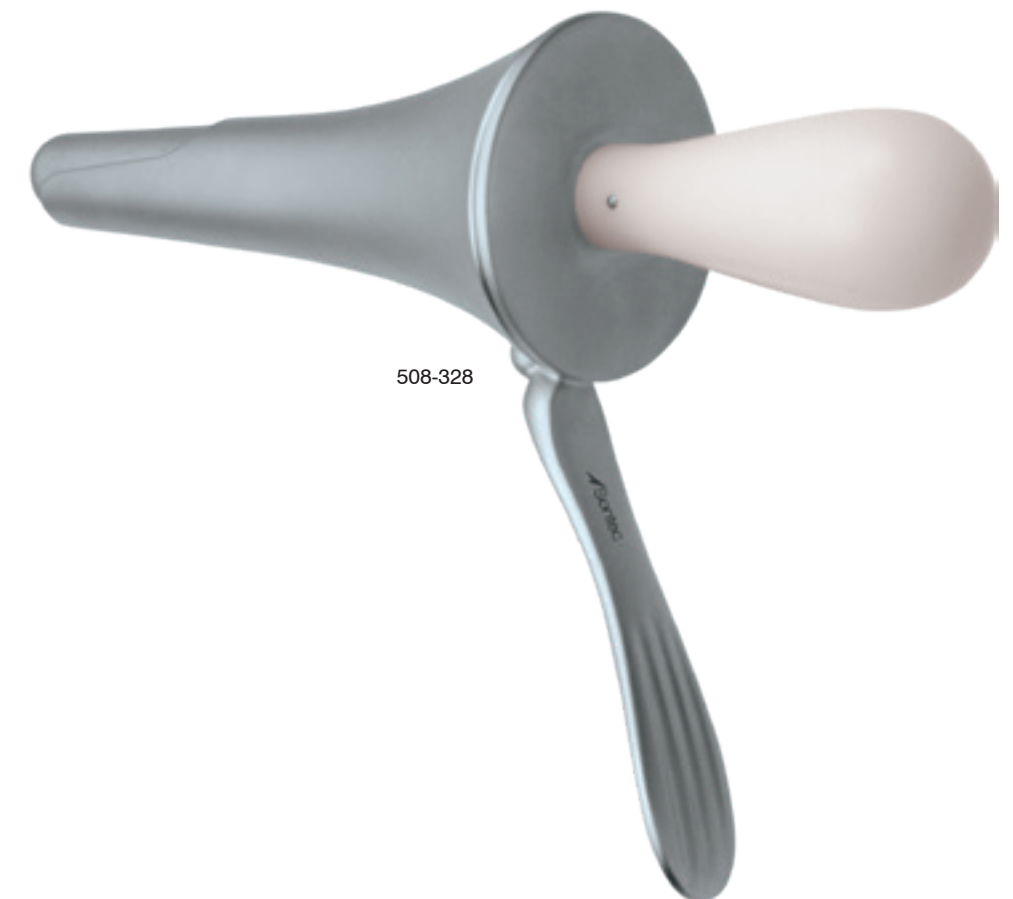

508-328

Vernon-David Rectal Speculum

With grip handle

- 508-344 short thumb handle
- 508-345 long (standard) handle



508-344

Fansler Operating Speculum

With slotted tube / extra long handle

- 508-338 standard
- 508-338A 25 mm x 65 mm (1" x 2 1/2")
- 508-338B 29 mm x 65 mm (1 1/4" x 2 1/2")
- 508-338C 38 mm x 70 mm (1 1/2" x 2 3/4")

With slotted tube / short handle

- 508-338D 29 mm x 60 mm (1 1/4" x 2 1/4")
- 508-339 operating speculum



508-338A

Brinkerhoff Rectal Speculum

- 508-370 small 3 1/2" x 1" tapers to 1/2"
- 508-372 medium 4" x 1" tapers to 5/8"
- 508-376 large 4 3/4" x 1 1/4" tapers to 3/4"



508-370

Chelsea-Eaton Speculum

Slotted handle

- 508-352 small
- 508-354 large

* With light connection available



508-354

Ives-Fansler Anoscope

With hard rubber obturator /
fenestrated handle

90-0180 22 mm x 85 mm

Long chrome handle

90-0181 3 1/4" x 1 1/8"

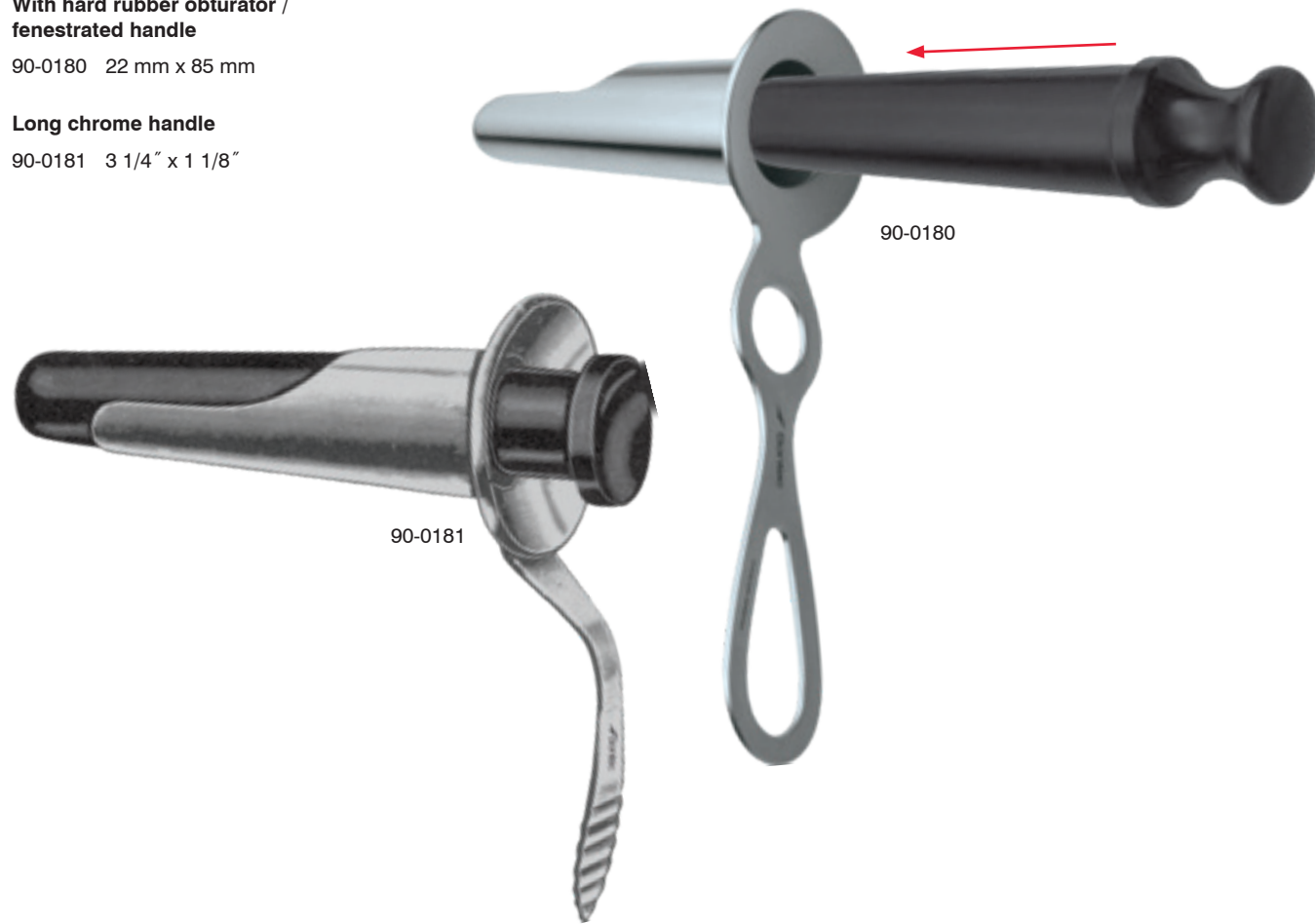

Pennington Anoscope

Solid handle

508-342 28 mm x 83 mm

508-343 obturator

Hirschman Anoscope

508-360	small	2 1/4" x 9/16" inside diameter
508-362	medium	2 5/8" x 11/16" inside diameter
508-366	large	3 1/2" x 7/8" inside diameter



Buie Hirschman Anoscope

Longer version of the Hirschmann

508-367	small	2 1/4" x 9/16" inside diameter
508-368	medium	3 3/4" x 3/4" inside diameter
508-369	large	3 7/8" x 15/16" inside diameter

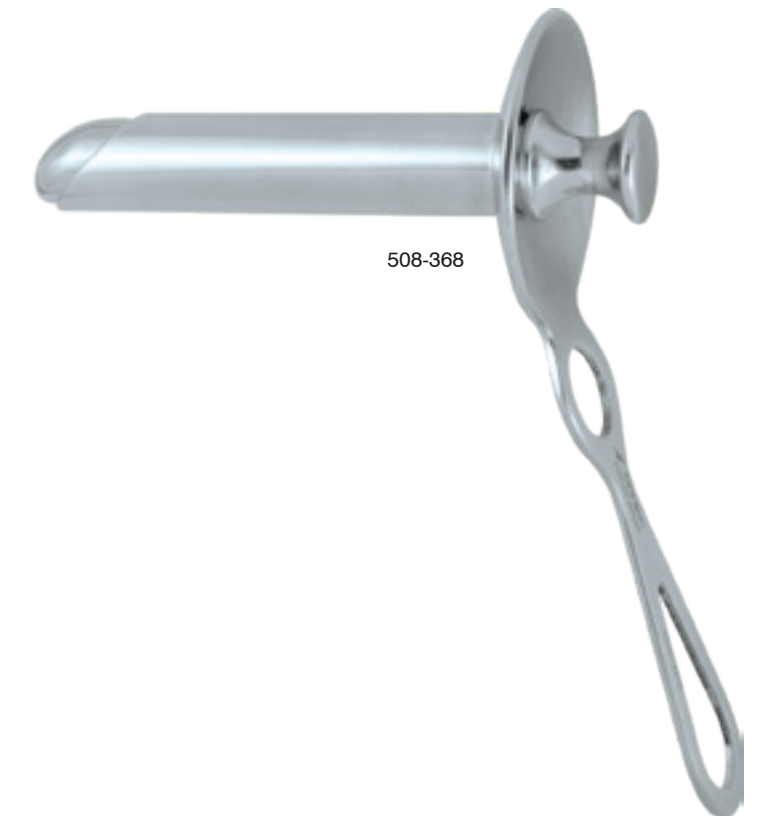



 Sontec Instruments®

GALL STONE Scoops

Davis Gallstone Scoop

Double-ended / oval cup / oval cup / blunt

- 1100-521S 5 1/2" (14 cm)
- 1100-521 6 1/2" (16.5 cm)
- 1100-521L 8" (20 cm)



1100-521



1100-521S



1100-521



1100-521L

Ferguson Gallstone Scoop

Double-ended / oval cup / oval cup / blunt / 9 1/2" (24 CM)

- 150-239 small
- 150-241 medium
- 150-243 large



150-239

Mayo Gallstone Scoop

10 3/4" (27.3 cm)
150-235



150-235



 Sontec Instruments®

Colorectal UTERINE BIOPSY PUNCH

Uterine Biopsy Punch

Oval basket / 8 1/2" (21.5 cm) shaft
525-256



525-256

Uterine Biopsy Forceps

Horizontal Oval basket / 11" (27.9 cm) shaft
525-254



525-254

Sontec Triangle Biopsy Punch Rongeur

Triangular basket / 5 1/2" (14 cm) shaft
478-322 size 0
1100-767A size 1
1100-767B size 2
1100-767C size 3

Triangular basket / 8" (20 cm) shaft
1100-768A size 1
1100-768B size 2
1100-768C size 3

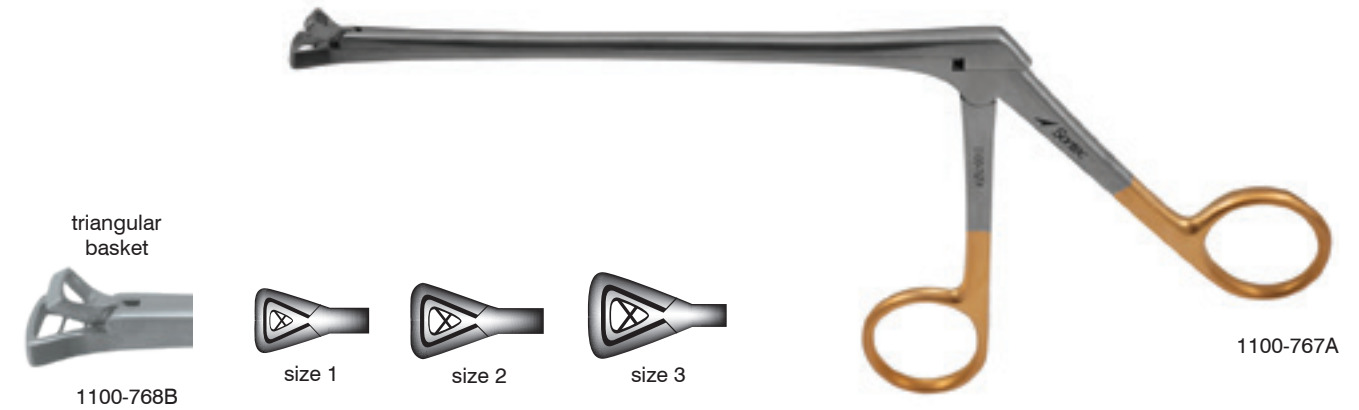

1100-767A

Yeoman Biopsy Punch Rongeur

Square basket / 11" (28 cm) shaft
90-0620 small punch
90-0630 large punch

Square basket / 14 1/2" (37 cm) shaft
90-0622 small punch
90-0632 large punch

Round basket / 360° rotating shaft / 13" (33 cm) shaft
90-0652 straight punch
90-0662 angled punch

Round basket / 360° rotating shaft / 16" (40.6 cm) shaft
90-0654 straight punch
90-0664 angled punch

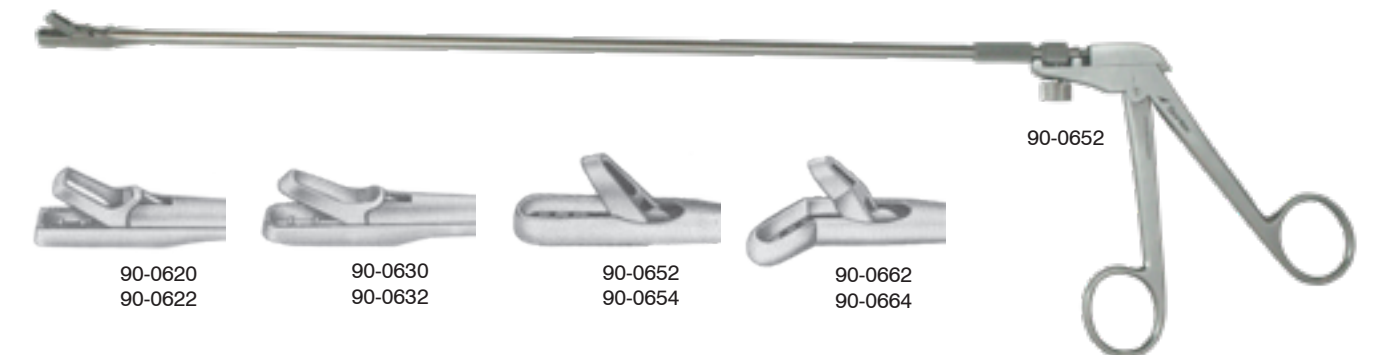

90-0652

Index

10-0562	35	20-2864	56	197-672	42
10-0565	33	20-2866	56	197-673	42
10-0566	35	21-0350	62	197-674	42
10-0567	35	21-0355	62	197-675	42
10-0570	32	21-0356	62	197-676	42
10-0571	32	21-0357	62	197-677	42
10-0572	32	90-0115	58	197-679	43
10-0580	36	90-0116	58	197-680	43
10-0581	36	90-0117	58	197-681	43
10-0660	32	90-0118	58	197-682	43
10-0670	34	90-0119	58	197-683	43
10-0671	34	90-0180	86	197-684	43
15-0230	40	90-0181	86	197-685	43
15-0231	40	90-0260	63	197-686	43
15-0232	40	90-0261	63	197-687	43
15-0233	40	90-0262	63	197-690	40
20-0440	57	90-0270	64	197-691	40
20-0442	57	90-0270R	65	197-692	40
20-0444	57	90-0271	64	197-693	40
20-0792	74	90-0271R	65	197-694	40
20-0793	74	90-0272	64	197-695	40
20-0794	74	90-0272R	65	197-700	40
20-0795	74	90-0273	64	197-701	40
20-0796	74	90-0273R	65	197-702	40
20-0797	74	90-0309	46	197-703	40
20-0878	72	90-0311	46	197-704	40
20-0880	72	90-0312	46	197-705	40
20-0881	72	90-0351	51	197-6705	42
20-0882	73	90-0620	95	197-6715	42
20-0905	71	90-0622	95	197-6725	42
20-0910	71	90-0630	95	197-6735	42
20-0930	75	90-0632	95	197-6745	42
20-0931	75	90-0652	95	197-6755	42
20-0932	75	90-0654	95	197-6765	42
20-0933	75	90-0662	95	207-240	79
20-0940	74	90-0664	95	207-241	79
20-1792	77	92-0145	69	207-242	79
20-1793	77	92-0150	76	207-243	79
20-1794	77	92-0160	76	207-244	79
20-1811	77	110-301	11	207-245	79
20-1816	77	110-302	11	207-246	79
20-1821	77	112-418	28	207-247	79
20-1826	77	112-506	28	475-158	28
20-1831	77	142-020	33	475-160	28
20-1836	77	142-030	37	478-322	95
20-1841	77	142-035	37	508-300	60
20-1845	77	142-130	37	508-302	60
20-1862	56	142-132	37	508-303	60
20-1864	56	142-137	37	508-304	60
20-1866	56	142-141	37	508-310	82
20-1870	70	150-235	91	508-315	82
20-1871	70	150-239	90	508-318	78
20-1872	68	150-241	90	508-318L	78
20-1877	72	150-243	90	508-319	78
20-1878	72	197-660	43	508-319L	78
20-1887	70	197-661	43	508-320	83
20-1910	73	197-662	43	508-322	66
20-1911	73	197-663	43	508-323	66
20-1912	73	197-664	43	508-323A	66
20-1913	73	197-665	43	508-323L	66
20-1914	73	197-666	43	508-324	66
20-1915	73	197-667	43	508-325	66
20-1916	73	197-668	43	508-325L	66
20-1917	73	197-670	42	508-326	66
20-2862	56	197-671	42	508-326L	66

508-326S	66	1100-521	90	1200-900	23
508-327	66	1100-521L	90	1200-902	23
508-327L	66	1100-521S	90	1200-904	23
508-328	83	1100-767A	95	1200-905	23
508-330	59	1100-767B	95	1200-906	23
508-335	79	1100-767C	95	1200-907	23
508-336	79	1100-768A	95	1200-908	23
508-338	84	1100-768B	95	1200-909	23
508-338A	84	1100-768C	95	1200-910	23
508-338B	84	1100-847	13	1200-911	25
508-338C	84	1100-849	13	1200-912	25
508-338D	84	1100-850	13	1200-913	26
508-339	84	1200-76M	18	1200-914	26
508-342	86	1200-268	17	1200-915	25
508-343	86	1200-269	17	1200-916	25
508-344	84	1200-270	17	1200-919	26
508-345	84	1200-326	14	1200-9192	26
508-352	85	1200-328	14	2400-235	28
508-354	85	1200-330	14	2400-236	28
508-360	87	1200-330L	14	2400-237	28
508-362	87	1200-332	14	2400-238	28
508-366	87	1200-333	11	2400-239	28
508-367	87	1200-334	14	2400-240	28
508-368	87	1200-335	14	2400-240T	29
508-369	87	1200-340	14	2400-241	29
508-370	85	1200-342	15	2400-242	29
508-372	85	1200-342H	15	2400-242T	29
508-376	85	1200-342L	15	2400-243	29
508-536	41	1200-344	15	2400-245	29
508-538	41	1200-347	14	2400-245T	29
508-541	41	1200-360	15	2400-247	24
508-542	41	1200-362	15	2400-248	24
508-543	41	1200-370	16	2400-250	12
508-544	41	1200-372	16	2400-252	12
508-545	47	1200-500	24	2400-253	12
508-546	47	1200-501	24	2400-254	12
508-547	41	1200-505	24	2400-255	12
508-550	52	1200-507	24	2400-256	12
508-551	51	1200-510	24	2400-257	12
508-551N	51	1200-512	24	2400-258	12
508-556	51	1200-514	24	2400-259	24
508-560	52	1200-515	24	2400-260	13
508-561	53	1200-520	24	2400-262	13
508-570	50	1200-525	16	2400-264	13
508-575	50	1200-526	24	2400-265	12
508-580	50	1200-526S	24	2400-267	12
508-585	53	1200-529	24	2400-269	12
508-617	27	1200-530	24	2400-270	12
508-630	36	1200-531	24	2400-271	12
508-640	46	1200-535	24	2400-272	12
508-641	46	1200-536	24	2400-273	13
516-190	61	1200-537	24	2400-275	13
525-254	94	1200-538	24	2400-277	13
525-256	94	1200-750	18	2400-278	13
1100-104	12	1200-752	18	2400-279	13
1100-233	10	1200-760	18	2400-280	13
1100-235	27	1200-762	18	2400-281	24
1100-236	10	1200-770	19	2400-282	13
1100-236L	10	1200-775M	18	2400-283	13
1100-238	10	1200-776M	18	2400-286	14
1100-240	11	1200-780	18	2400-287	14
1100-241	10	1200-782	18	2400-302	17
1100-242	10	1200-783	18	2400-304	17
1100-243	11	1200-784	18	2400-306	17
1100-244	10	1200-786	18	2400-308	17
1100-245	11	1200-787	18	2400-309	17
1100-246	11	1200-788	20	2400-310	17
1100-290	12	1200-790	20	2400-311	17
1100-291	10	1200-899	27	2400-314	14

2400-315	14	Brinkerhoff Rectal Speculum	85
2400-316	14	Brunner Retractor	74
2400-317	15	Brunner Sigmoid Anastomosis Clamp	33
2400-318	15	Buie Fistula Probe	41
2400-319	15	Buie Hirschman Anoscope	87
2400-320	11		
2400-321	17		
2400-322	17		
2400-323	17	Chelsea-Eaton Speculum	85
2400-330	15	Christie Retractor	70
2400-341	13	Clamp	
2400-345	13	Best Colon Clamp	32
2400-346	10	Brunner Sigmoid Anastomosis Clamp	33
2400-349	10	Fehland Sigmoid Anastomosis Clamp	35
2400-352	11	Hayes Sigmoid Anastomosis Clamp	35
2400-785	23	Lloyd Davis Clamp	36
2400-787	23	Mikulicz Clamp	36
2400-790	19	Payr Intestinal Stomach Clamp	37
2400-792	19	Resano Sigmoid Anastomosis Clamp	33
2400-797	20	Scudder Clamp	37
2400-798	21	Thorlakson Lower Occlusive Clamp	34
2400-800	21	Thorlakson Upper Occlusive Clamp	32
2400-801	21	Collin Retractor	62
2400-802	21		
2400-803	21		
2400-804	21		
2400-805	21	Davis Gallstone Scoop	90
2400-806	21	Deaver & Ford Retractor	77
2400-807	21		
2400-808	21		
2400-809	21		
2400-811	21	Eder Cotton Carrier	51
2400-812A	18		
2400-813A	18		
2400-814A	18		
2400-815	19	Fansler Operating Speculum	84
2400-815A	18	Fehland Sigmoid Anastomosis Clamp	35
2400-816	19	Ferguson Gallstone Scoop	90
2400-817	22	Forceps	
2400-817F	22	Uterine Biopsy Forceps	94
2400-817M	22	Ford-Dixon Ligator	52
2400-818	22	Foss Retractor	68
2400-818M	22		
2400-819	21		
2400-820	21		
2400-821	21		
2400-822	21		
2400-841	22		

A

Alan-Parks Rectal Retractor System	58
Anoscope	
Buie Hirschman Anoscope	87
Hirschman Anoscope	87
Ives-Fansler Anoscope	86
Pennington Anoscope	86

B

Baby Metzenbaum Power Cut Black® Scissors	23
Barr Double Ended Probe	41
Barr Fistula Probe	41
Barr Hook	47
Barr Rectal Retractor	59
Barr-Shuford Rectal Speculum	83
Best Colon Clamp	32
Bodenhammer Rectal Speculum	82

C

Chelsea-Eaton Speculum	85
Christie Retractor	70
Clamp	
Best Colon Clamp	32
Brunner Sigmoid Anastomosis Clamp	33
Fehland Sigmoid Anastomosis Clamp	35
Hayes Sigmoid Anastomosis Clamp	35
Lloyd Davis Clamp	36
Mikulicz Clamp	36
Payr Intestinal Stomach Clamp	37
Resano Sigmoid Anastomosis Clamp	33
Scudder Clamp	37
Thorlakson Lower Occlusive Clamp	34
Thorlakson Upper Occlusive Clamp	32
Collin Retractor	62

D

Davis Gallstone Scoop	90
Deaver & Ford Retractor	77

E

Eder Cotton Carrier	51
---------------------	----

F

Fansler Operating Speculum	84
Fehland Sigmoid Anastomosis Clamp	35
Ferguson Gallstone Scoop	90
Forceps	
Uterine Biopsy Forceps	94
Ford-Dixon Ligator	52
Foss Retractor	68

G

Grooved Director Tongue Tie	40
-----------------------------	----

H

Harrington-Pemberton Retractor	73
Harrington Retractor	72
Hayes Sigmoid Anastomosis Clamp	35
Hemorrhoidal Suction Ligator	50
Hill-Ferguson Retractor	64, 65
Hirschman Anoscope	87
Hook	
Barr Hook	47
Pratt Crypt Hook	46
Rosser Crypt Hook	47
Stewart Crypt Hook	46

I

Ives-Fansler Anoscope	86
-----------------------	----

K

Kelly Retractor	74
Kocher Retractor	76

Koerte Retractor	71
Kummel Retractor	71

L

Larry Fistula Probe	41
Latex O-rings	51
Lawton Retractor	73
Legueu Retractor	69
Ligator	
Ford-Dixon Ligator	52
Hemorrhoidal Suction Ligator	50
McGivney Ligator	52
Self Loading Hemorrhoidal Ligator	53
Simple Style Ligator	53
Lloyd Davis Clamp	36
Loading Cone for Hemorrhoidal Ligator	50
Loading Cone	50
Lockhart Mummery Fistula Probe	40

M

Mayo Gallstone Scoop	91
McGivney Ligator	52
Metzenbaum Bayonet Power Cut Gold Scissors	16
Metzenbaum Brophy Sharp/Sharp Scissors	29
Metzenbaum Brophy Sharp/Sharp Tip Scissors	28
Metzenbaum Ceramic Coated Power Cut Scissors	23
Metzenbaum Ceramitec Power Cut® Scissors	25, 27
Metzenbaum Ceramitec TC/PC Scissors	26
Metzenbaum Classic Model Scissors	10, 11
Metzenbaum Power Cut® Gold Scissors	14
Metzenbaum Power Cut Black Scissors	18, 19, 20, 21, 22
Metzenbaum Power Cut Gold Long Model Scissors	17
Metzenbaum Power Cut Gold Scissors	14, 15
Metzenbaum Scissors	11
Metzenbaum S-Curved Power Cut Gold Scissors	16
Metzenbaum Stitch Scissors	13
Metzenbaum-Toennis Power Cut Black Scissors	22
Metzenbaum Tungsten Carbide Long Model Scissors	13
Metzenbaum Tungsten Carbide Power Cut® Gold/Black Scissors	24
Metzenbaum Tungsten Carbide Scissors	12
Mikulicz Clamp	36
Mikulicz Retractor	75
Murphy Abdominal Retractor	70

O

Obwegeser Retractor	79
O-Ring Hemorrhoid Band Cutter	51

P

Payr Intestinal Stomach Clamp	37
Pennington Anoscope	86
Pratt Crypt Hook	46
Pratt Rectal Speculum	82

Probe	26
Barr Double Ended Probe	41
Barr Fistula Probe	41
Buie Fistula Probe	41
Larry Fistula Probe	41
Lockhart Mummery Fistula Probe	40
Probe with Eye	43
St. Marks Fistula Probe	41
Universal Double Ended Probe	42
Probe with Eye	43
Punch	
Uterine Biopsy Punch	94

R

Resano Sigmoid Anastomosis Clamp	33
Retractor	
Alan-Parks Rectal Retractor System	58
Barr Rectal Retractor	59
Christie Retractor	70
Collin Retractor	62
Deaver & Ford Retractor	77
Foss Retractor	68
Harrington-Pemberton Retractor	73
Harrington Retractor	72
Kelly Retractor	74
Kocher Retractor	76
Koerte Retractor	71
Kummel Retractor	71
Lawton Retractor	73
Legueu Retractor	69
Mikulicz Retractor	75
Murphy Abdominal Retractor	70
Obwegeser Retractor	79
Sawyer Rectal Retractor	63
Smith-Buie Rectal Retractor	79
Sontec-Millins Bladder Retractor	61
St. Marks Hand Retractor	66
St. Marks Perineal Retractor	60
Thorlakson Abdominal Hand Retractor	56
Thorlakson Simple Hand Retractor	57
Wylie Deep Pelvic Retractor	78
Brunner Retractor	74
Hill-Ferguson Retractor	64, 65
Rongeur	
Sontec Triangle Biopsy Punch Rongeur	95
Yeoman Biopsy Punch Rongeur	95
Rosser Crypt Hook	47

S

Sawyer Rectal Retractor	63
Scissors	
Baby Metzenbaum Power Cut Black® Scissors	23
Metzenbaum Bayonet Power Cut Gold Scissors	16
Metzenbaum Brophy Sharp/Sharp Scissors	29
Metzenbaum Brophy Sharp/Sharp Tip Scissors	28
Metzenbaum Ceramic Coated Power Cut Scissors	23
Metzenbaum Ceramitec Power Cut® Scissors	25, 27
Metzenbaum Ceramitec TC/PC Scissors	

Metzenbaum Classic Model Scissors	10, 11
Metzenbaum Power Cut Black Scissors	18, 19, 20, 21, 22
Metzenbaum Power Cut Gold Long Model Scissors	17
Metzenbaum Power Cut Gold Scissors	14, 15
Metzenbaum Scissors	11
Metzenbaum S-Curved Power Cut Gold Scissors	16
Metzenbaum Stitch Scissors	13
Metzenbaum-Toennis Power Cut Black Scissors	22
Metzenbaum Tungsten Carbide Long Model Scissors	13
Metzenbaum Tungsten Carbide Power Cut® Gold/Black Scissors	24
Metzenbaum Tungsten Carbide Scissors	12
Stussak Metzenbaum Power Cut Gold Scissors	27
Scoop	
Davis Gallstone Scoop	90
Ferguson Gallstone Scoop	90
Mayo Gallstone Scoop	91
Scudder Clamp	37
Self Loading Hemorrhoidal Ligator	53
Simple Style Ligator	53
Sims Rectal Speculum	83
Smith-Buie Rectal Retractor	79
Sontec-Millins Bladder Retractor	61
Sontec Triangle Biopsy Punch Rongeur	95
Speculum	
Barr-Shuford Rectal Speculum	83
Bodenhammer Rectal Speculum	82
Chelsea-Eaton Speculum	85
Pratt Rectal Speculum	82
Sims Rectal Speculum	83
Speculums	
Brinkerhoff Rectal Speculum	85
Fansler Operating Speculum	84
Stewart Crypt Hook	46
St. Marks Fistula Probe	41
St. Marks Hand Retractor	66
St. Marks Perineal Retractor	60
Stussak Metzenbaum Power Cut Gold Scissors	27

W

Wylie Deep Pelvic Retractor	78
-----------------------------	----

Y

Yeoman Biopsy Punch Rongeur	95
-----------------------------	----



In Business for Over 50 Years

Bringing the Highest Quality Surgical
Instrumentation to the World since 1970



Sontec Instruments®

A TRADITION OF FINE SURGICAL INSTRUMENTS

Sontec Instruments, Inc.
7248 South Tucson Way
Centennial, Colorado 80112 USA
Toll-free / 800.821.7496
Local / 303.790.9411
Fax / 303.792.2606

SontecInstruments.com