



Sontec Instruments®

A TRADITION OF FINE SURGICAL INSTRUMENTS

OPHTHALMOLOGY CATALOG

Dear Customer,

Sontec Instruments, Inc. is a family owned & operated medical company, providing personalized service featuring the finest in surgical instrumentation for over half a century.

Our surgical instruments encompass the entire human anatomy including specialty products specific to small and large animal surgery.

Owner of Sontec Instruments, Dennis Russell Scanlan III and his sons, Johann, Stefan and Angus Scanlan bring with them a lifetime of experience creating the highest quality products made by the world's leading manufacturing facilities featuring, cutting edge robotic technology, handmade workmanship combined with an understanding how to make exactly what our valued customers have come to expect.

Dennis R. Scanlan, III President & CEO and his wife Caron C. Scanlan thank you, for the opportunity to present our specialty Ophthalmology catalog.

Sincerely,



Dennis Russell Scanlan III

IMPORTANT INFORMATION

Guarantee & Repairs Policy

Sontec® surgical instruments are guaranteed to be free of defects in materials and workmanship. Any Sontec® instrument that is defective will be repaired or replaced at our discretion. Instruments not properly cared for, used for unintended purposes, or beyond their designed capacity will not be covered under this guarantee. Our liability under this guarantee is limited to the repair or replacement of the defective merchandise.

Sontec® has its own repair department where most mechanically functional instruments can be returned to like-new condition.

Sontec® performs a variety of repairs, such as replacing worn TC jaws or sharpening scissors. In addition, we complete a comprehensive evaluation of your instruments to determine if further service is required.

For repair service, please send the following directly to the address below:

- Instruments clean, sterilized, securely wrapped and carefully packaged.
- Purchase and/or repair order
- A note with contact and shipping information
- Sending multiple items eliminates \$50 minimum charge

Return Policy

The return of new, unused instruments in their original packaging is accepted within 30 days of purchase with an authorized "Return Merchandise Authorization". Please contact Sontec directly by phone or email with your invoice or proof of purchase in order to obtain your RMA slip and instructions. Restocking fee applies and credit will not be issued for shipping charges or handling fees. Proper credit is not guaranteed without an RMA. Custom, Special Order or Modified items are non-returnable.

Sontec Instruments, Inc.
Toll free: 800.821.7496
Local: 303.790.9411
returns@sontecinstruments.com

Remember

Sontec® offers other catalogs for a variety of surgical instrumentation, including:

- Alligator, Grasping, & Biopsy Forceps
- Avian & Exotic
- Bandage Scissors
- Cardiovascular & Thoracoscopic
- Caspar & Cloward Retractor Systems
- Colon & Rectal
- Cranial Cruciate Ligament Lateral Suture

- System
- Equine (Arthroscopic)
 - Eye
 - Neurology & Orthopedic
 - Orthopedic & Arthroscopic
 - Urology
 - Veterinary Dental
 - Veterinary Eye
 - General Veterinary Instrumentation

Also, if you do not find what you are looking for, please contact us.

Instrument Care

Designed and crafted to exacting specifications, surgical instruments will perform for a number of years, provided they are maintained correctly and used for their intended purpose. A strict maintenance schedule will help reduce the need for premature replacements, thus cutting costs. For proper safeguarding of surgical instruments, please read and share the following information.

- Never substitute sterilization for cleanliness
- Wash brand new instruments prior to the first sterilization
- Remove saline solution, bleach, blood and tissue from instruments quickly and thoroughly
- Always use distilled water for cleaning instruments
- Never use saline solution for cleaning instruments
- Prevent cross-corrosion by separating corroded instruments from other instruments
- Never autoclave econo-grade stainless with superior-grade stainless.
- Always autoclave instruments with box lock open to alleviate pressure at the joint and to prevent fracture
- Lubricate joint and box lock after cleaning with an anti-microbial, water soluble lubricant
- Protect the tips of delicate instruments with protective covers (see page a.)
- Never use an instrument for anything other than its intended use

Additional Safeguarding Guidelines

Scissors and Other Blades

- Perform routine inspections for sharpness, as a blade becomes duller with each stroke (all operating and Mayo scissors should be able to cut through four layers of gauze)
- When blades no longer cut without an excessive amount of force, please return them to Sontec® for sharpening
- The more often a blade is sharpened, the longer it tends to last

Needle Holders

- Repair is necessary when needle holder no longer securely holds needle when locked on the second ratchet tooth, and needle turns easily by hand

Please Note

- We are not responsible for typographical errors in this catalog
- Instruments pictured in this catalog may or may not be to size
- Variations and changes in instrument design are possible
- Pricing is subject to change without notice
- Delivery schedules may vary from original estimates
- Some items are for veterinary use

Contact Info

Sontec Instruments, Inc.
7248 South Tucson Way
Centennial, Colorado 80112, USA
Toll free: 800.821.7496
Local: 303.790.9411
service@sontecinstruments.com
www.sontecinstruments.com

Troubleshooting Guide

Problem	Cause	Solution
Rust	Worn chrome plating on brass instruments	Be aware of plating condition and remove from service when wear is visible.
	Cross-corrosion from carbon instruments to stainless steel	Keep carbon steel and stainless steel instruments separated during cleaning and sterilization.
	Low grade instruments may not have been passivated	Remove from service.
	Autoclave not operating properly	Clean and thoroughly flush water lines in sterilizer according to manufacturer's instructions. Only use distilled water, never tap water, to generate steam.
	Organic matter left on instrument after surgery	Remove all blood and tissue before drying. Use distilled water and a nylon brush to clean hard to reach areas.
Pitting	Prolonged exposure to corrosive chemicals and/or organic substances	Only use approved cleaning and sterilization solutions. Thoroughly rinse and dry instruments.
Orange / Brown Stains	Contaminated sterilizer, high alkaline detergent, cold disinfectants	Clean sterilizer. Use neutral pH solutions. Thoroughly clean, rinse, and dry instruments.
Bluish Black Stains	Mixing dissimilar metals during cleaning and sterilization	Separate carbon steel, aluminum, and stainless steel instruments.
Rainbow - olored Stains	Chromium oxide stain-result of excessive heat	Send in for polishing and hardness check.
Cracked Box Lock	Excessive force, sterilized in the closed position	Replace the instrument.
Cracked Jaw on Pin Cutter	Cutting pin at tip of jaws	Replace the instrument. Cut pin in center of jaws.

Conversion Table

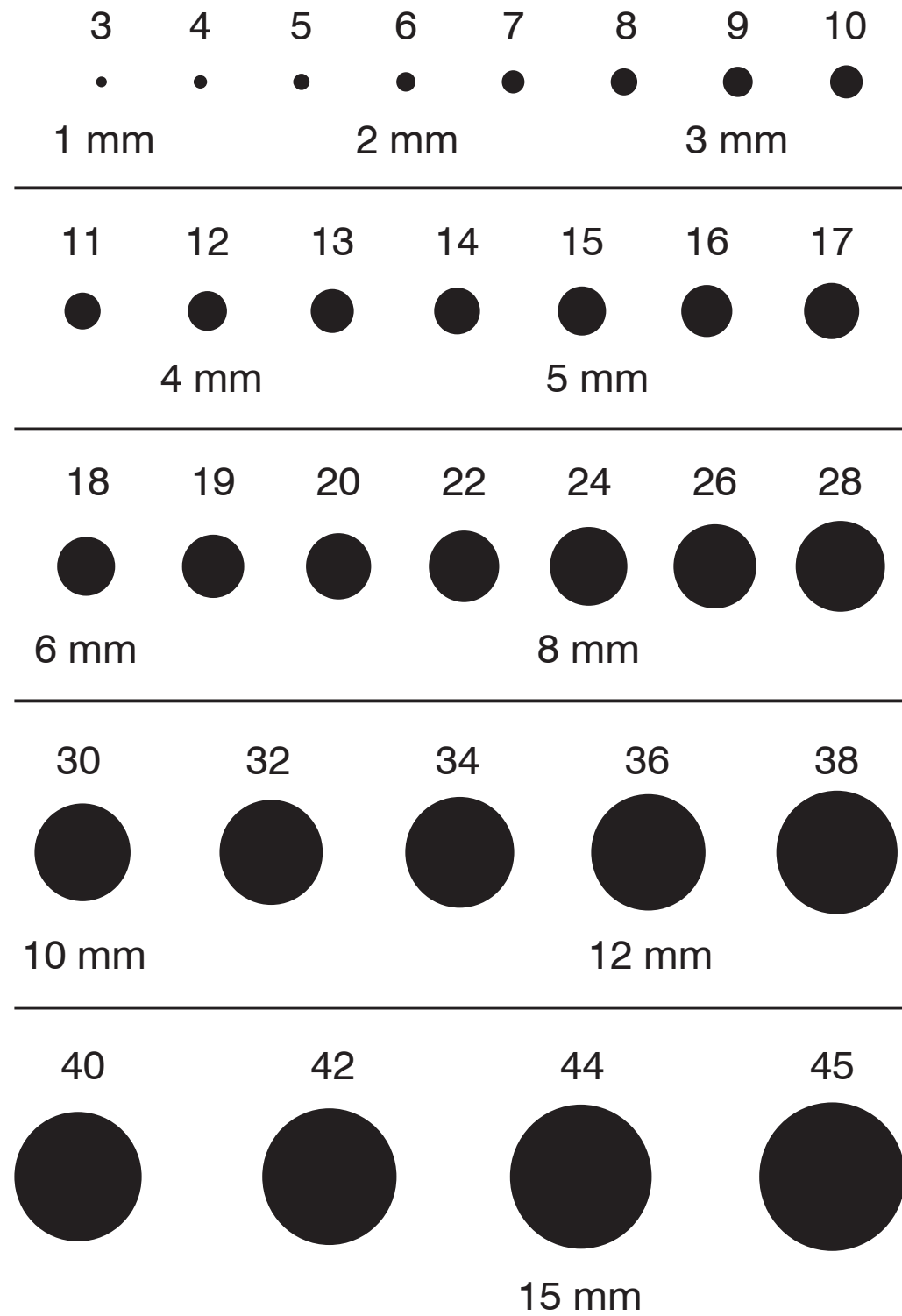

Conversion Table

Multiply	By	To Obtain
Millimeters	0.1	Centimeters
Millimeters	0.03937	Inches
Centimeters	0.3937	Inches
Centimeters	0.01	Meters
Centimeters	10	Millimeters
Inches	2.540	Centimeters
$1/8'' = 3.175$ millimeters		
$1/4'' = 6.350$ millimeters		
$3/8'' = 9.525$ millimeters		
$1/2'' = 12.70$ millimeters		
$1'' = 25.40$ millimeters		

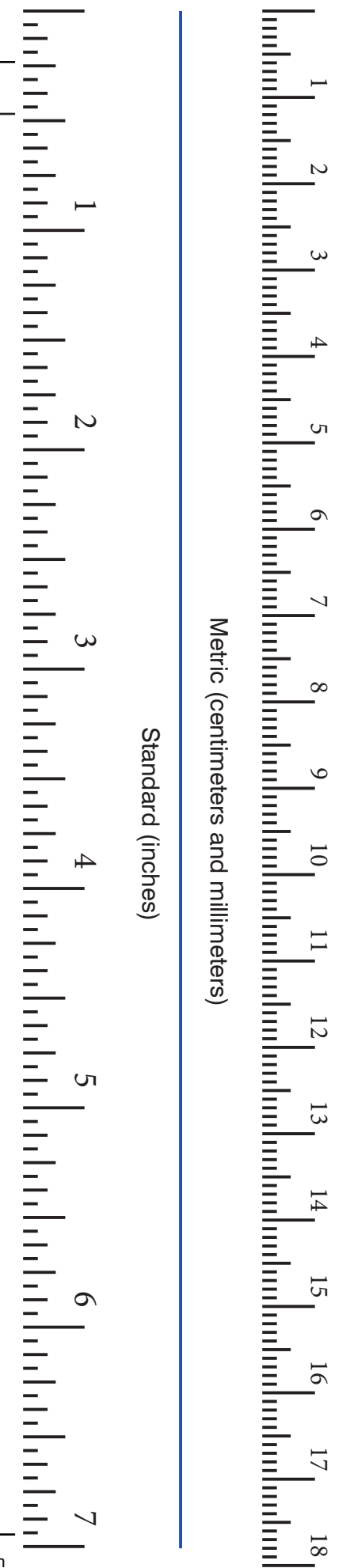

Metal Micro Instrument Tray

Single level / includes pin mat and retainers

- 18-3519 10" x 10" x 1.5" (25.5 cm x 25.5 cm x 4 cm)
- 18-3510 10" x 15" x 1.5" (25.5 cm x 38 cm x 4 cm)

* Instruments not included



18-3519



18-3510

Metal Micro Instrument Tray

Double level / includes pin mat and retainers / instruments not included

- 18-3505 10" x 10" x 3" (25.5 cm x 25.5 cm x 8 cm)
- 18-3515 10" x 15" x 3" (25.5 cm x 38 cm x 8 cm) short tray / full height

* Instruments not included



18-3505



18-3515

Metal Micro Instrument Tray

Double level / includes pin mat and retainers

- 18-3520 10.5" x 15" x 2.5" (26.5 cm x 38 cm x 6.5 cm) long tray / half height
- 18-3525 10" x 19.5" x 2.5" (25.5 cm x 49.5 cm x 6.5 cm) short tray / full height
- 18-3530 10.5" x 19.5" x 2.5" (26.5 cm x 49.5 cm x 6.5 cm) long tray / half height

* Instruments not included



18-3520



18-3525



18-3530

Rhoton Instrument Tray

Stainless steel tray

1103-708

* instruments sold as complete set
* or can order individually / separate



Rhoton Instrument Tray

Stainless solid

1103-709

* instruments sold as complete set
* or can order individually / separate



Universal Surgery Tray

10" x 21.5" x 2.5" / with lid / universal keyhole brackets

18-3560

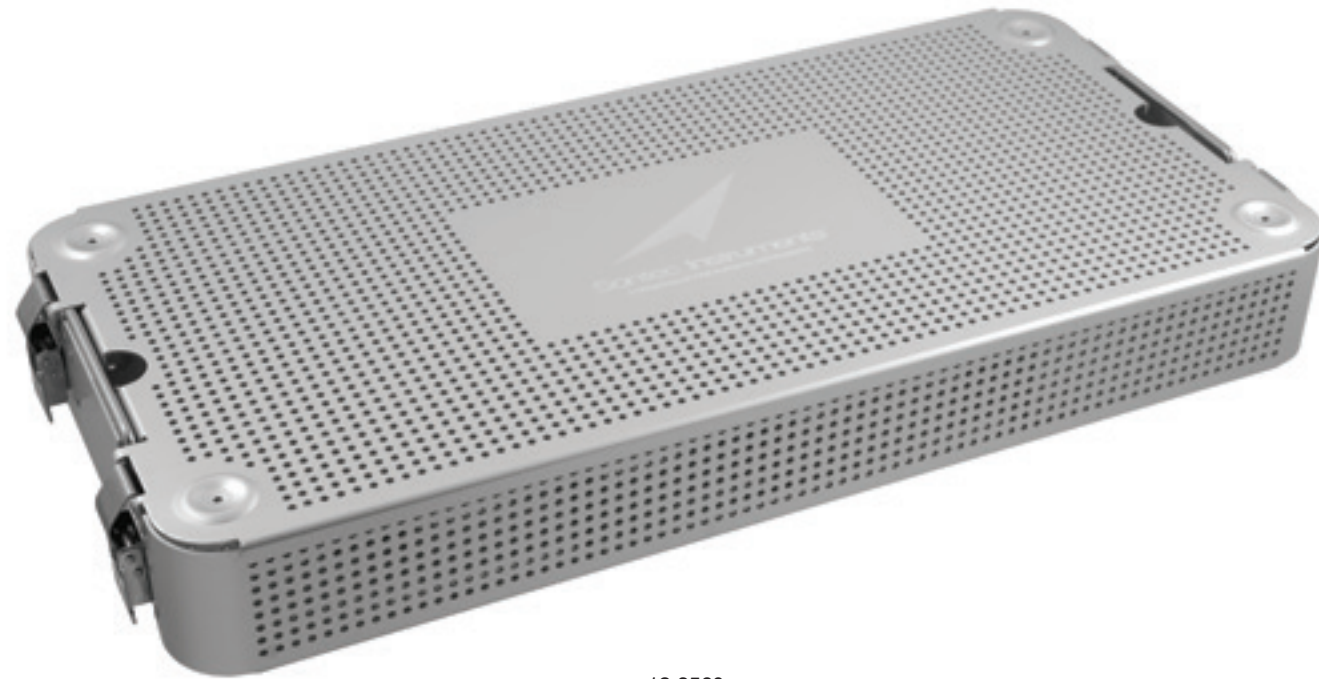

18-3560

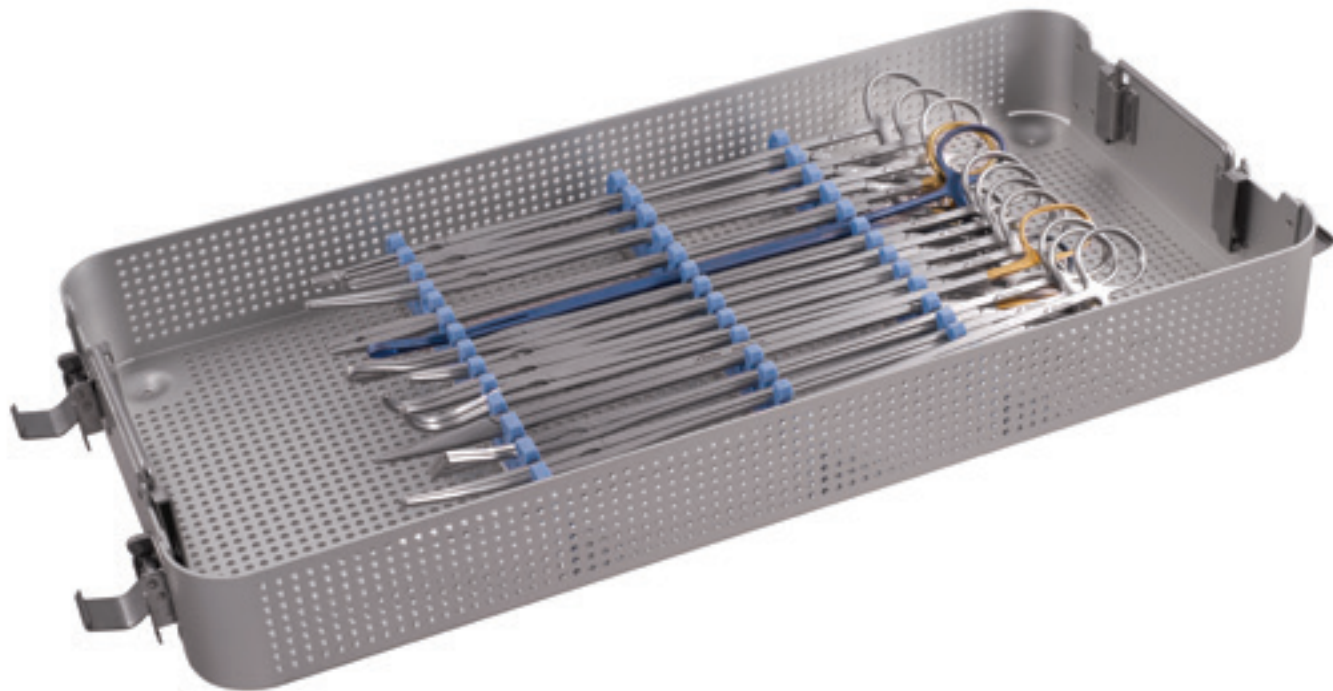

Silicone Mat

For instrument trays / cut to size / autoclavable

- 18-3120 18" x 13" (46 cm x 33 cm) with holes
- 18-3121 10" x 6" (25.5 cm x 15 cm)
- 18-3122 10" x 15" (25.5 cm x 38 cm)
- 18-3123 14" x 19" (35.5 cm x 48.5 cm)

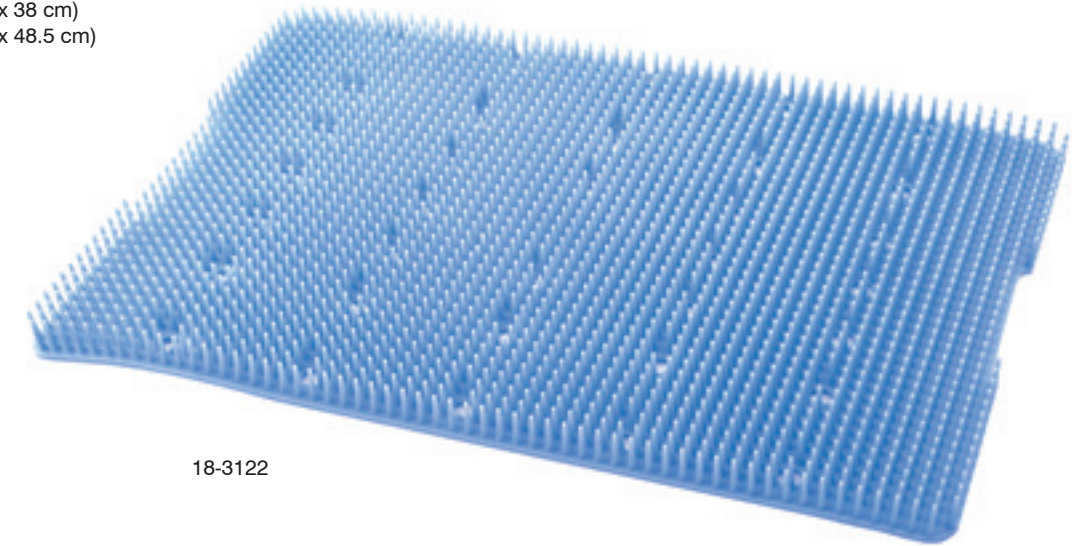

18-3122

Alligator Sterilizing Rack

3.5" x 3" x 7.5"

325-130

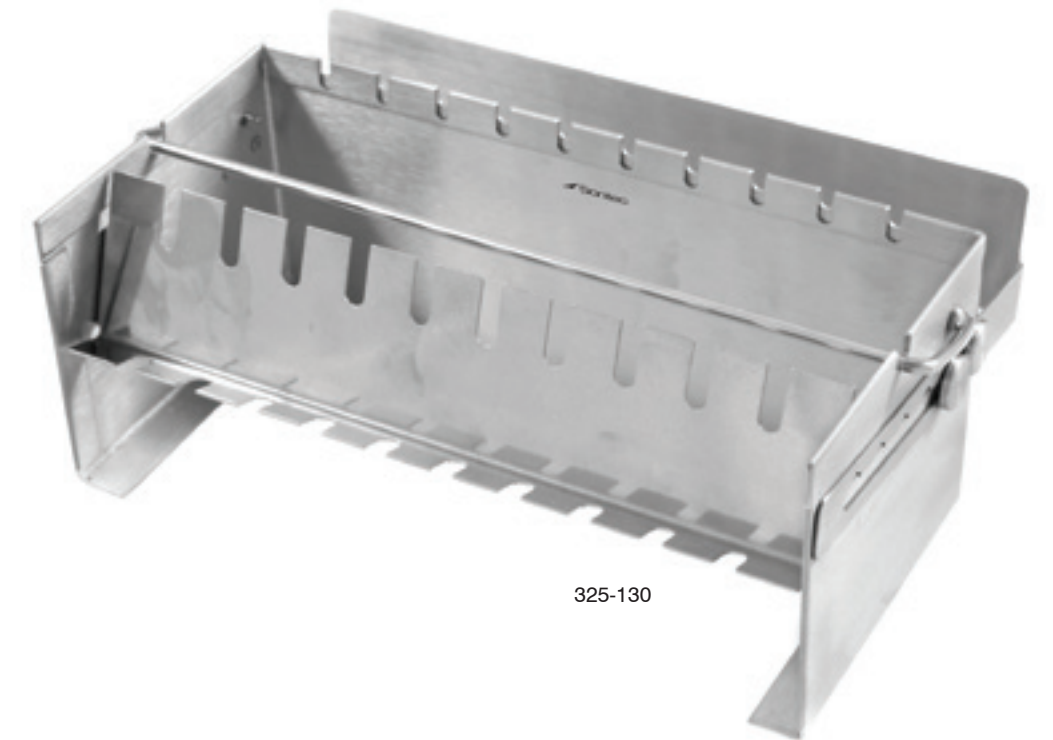

325-130

Thermoplastic Instrument Tray

With silicone mat / autoclavable

1103-702	single	6" x 2 1/2" x 3/4"
1103-703	single	1.5" x 2.7" x .75" mini tray
1103-705	single	6" x 4" x 3/4"
1103-723	single	7 1/2" x 4" x 3/4"
1103-710	single	10" x 6" x 3/4"
1103-702D	single	6" x 2 1/2" x 1 1/4" deep
1103-724	single	7 1/2" x 4" x 1 1/2" deep
1103-716	single	10" x 6" x 1 1/2" deep
1103-715	double decker	10" x 6" x 1 1/2"

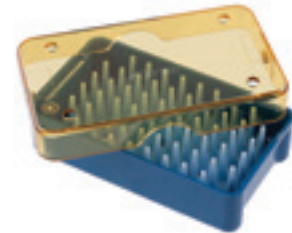

1103-703

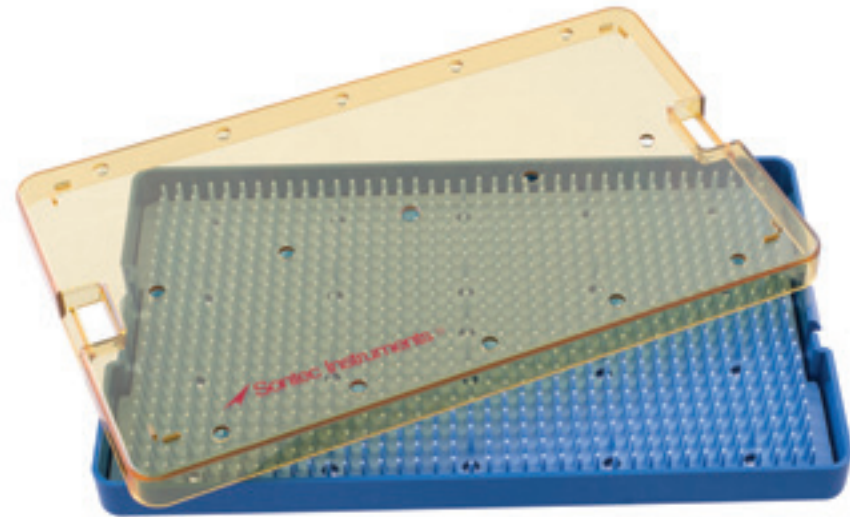

1103-710

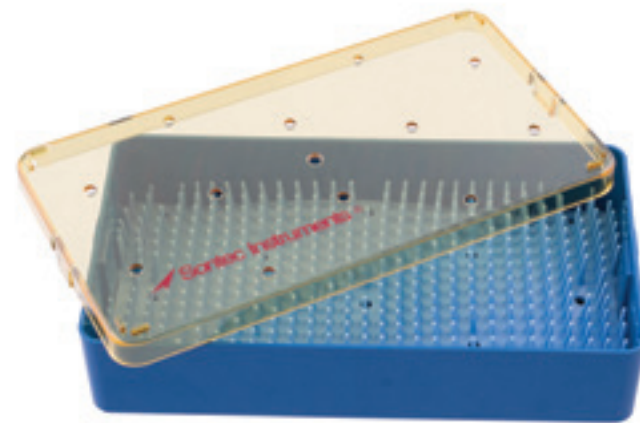

1103-724

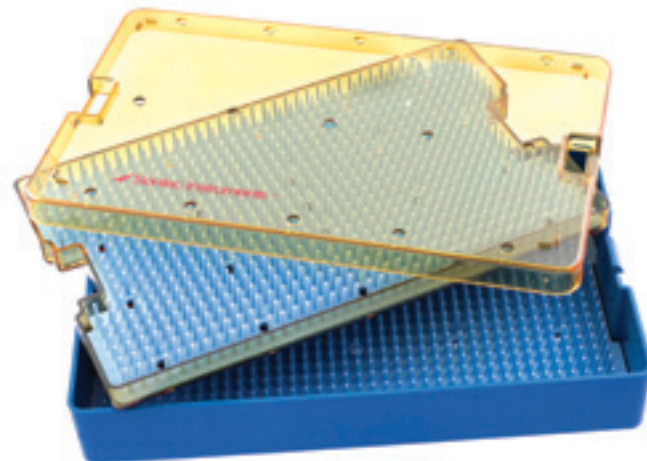

1103-715

Thermoplastic Instrument Tray

With silicone mat / autoclavable

18-3214	single	10" x 15" x 3/4"
18-3215	single	10" x 15" x 1 1/2" deep
18-3213	double decker	10" x 15" x 1 1/2"

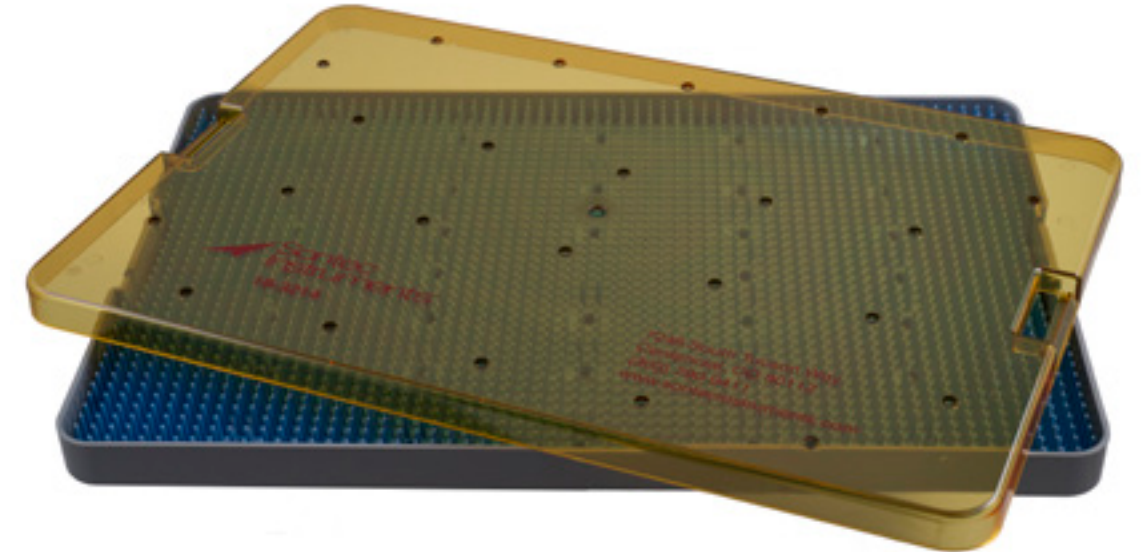

18-3214

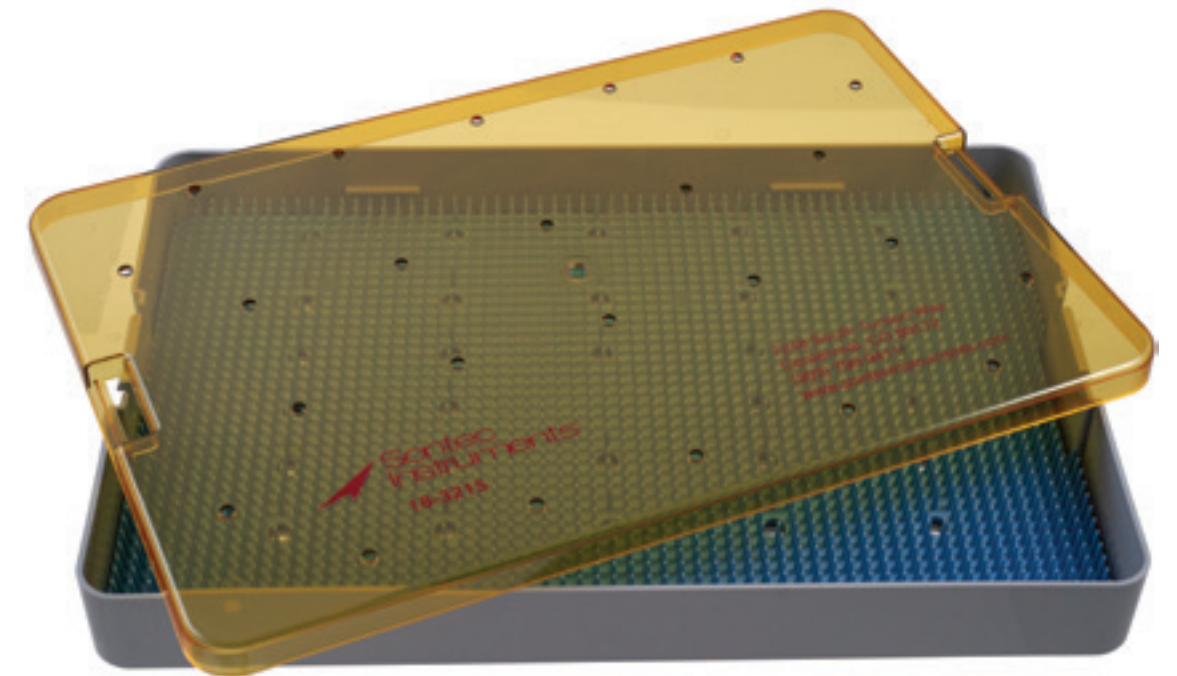

18-3215

Thermoplastic Instrument Trays

With silicone mat and metal clasps / autoclavable

- 1103-717 double decker 11" x 7" x 1 1/2"
- 1103-717D single deep 11" x 7" x 1 1/2"
- 1103-712 single shallow 11" x 7" x 3/4"

* Other sizes available upon request, requires special order. Check your measurements.

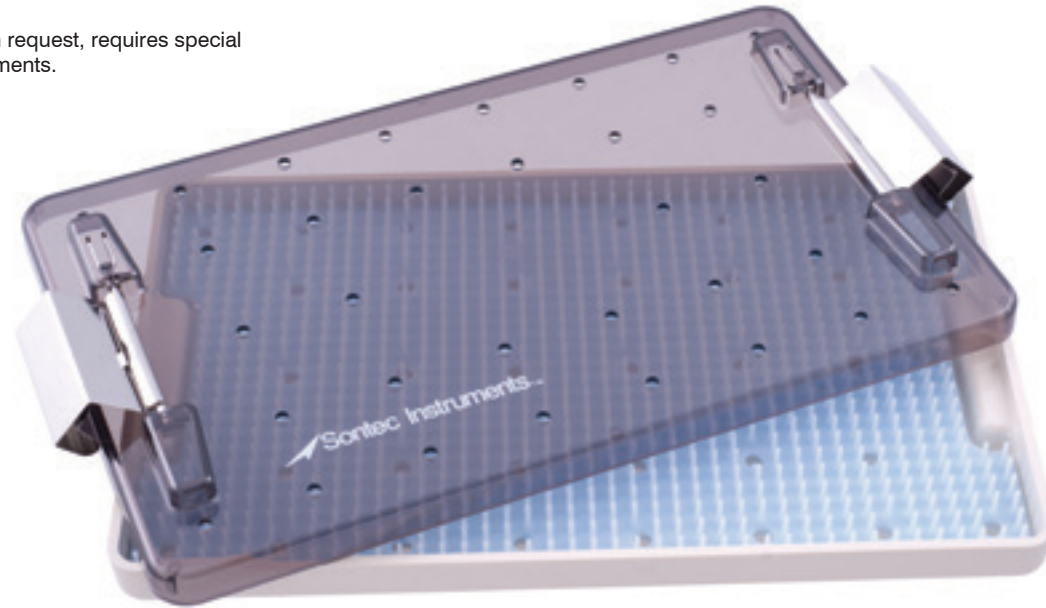

1103-712

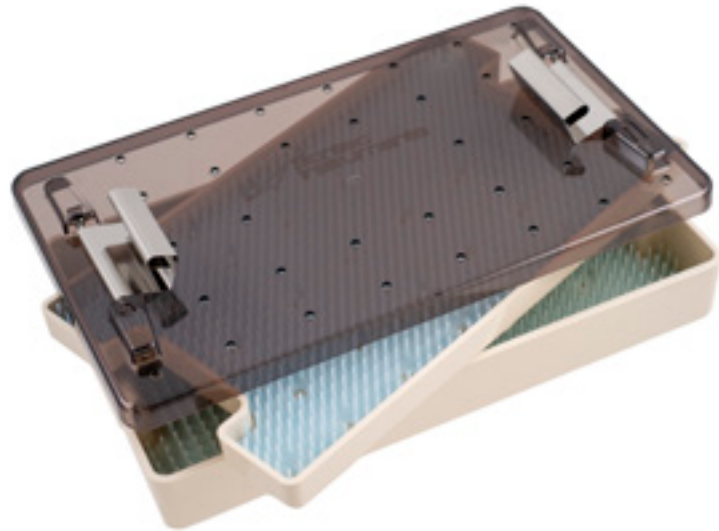

1103-717

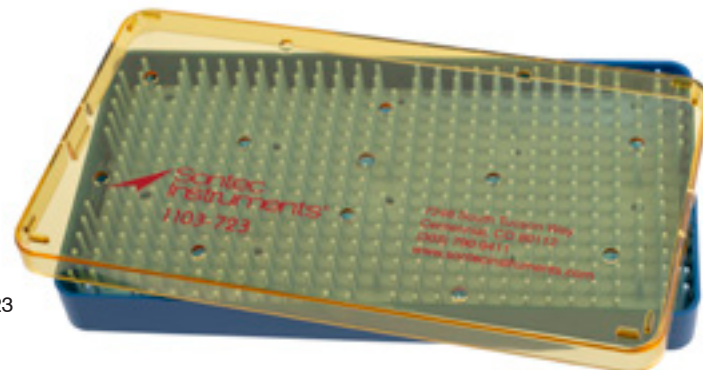

1103-723

Sontec Slim Thermo Plastic Instrument Tray

- 18-3209 tray 10.3" x 18.3" x 2.33"
- 18-3270 tray 18.3" x 8.35" x 2"

* "Check Your Measurements", These items are FINAL SALE



18-3209



18-3270

Catheter Trays & Dome Lid Covers

Heavy duty / seamless / for catheter trays / strap handles / easy to handle

ST83 8 3/4" x 3 1/4" x 1 1/2" Tray
 ST83-2 Lid Cover: fits tray ST83

ST17-0-0 17 1/4" x 4 1/2" x 2" Tray
 ST17-0-2 Lid Cover: fits tray ST170

ST95-2 8 7/8" x 5" x 2" Tray
 ST95-3 8 7/8" x 5" x 3" Tray
 ST95-2D-2 Lid Cover: fits trays ST952 & ST953

* "Check Your Measurements"
 These items are FINAL SALE



Stainless Steel Instrument Trays, Lid Covers & Perforated Nesting Sterilization Instrument Trays

Used for hot or cold sterilization / for Sterilization Trays / recessed strap handles / easy to handle / easy to store / safe to transport

STE2-0124 solid 20 3/4" x 12 3/4" x 4" Tray
 STP2-0122 perforated 20 3/4" x 12 3/4" x 2 1/2" Tray
 STE2-0126 solid 20 3/4" x 12 3/4" x 6" Tray
 STP2-0124 perforated 20 3/4" x 12 3/4" x 4" Tray
 ST20-00-2 Lid Cover: fits trays STE20124, STP20122, STE20126, STP20124
 STE1-2104 solid 12 3/4" x 10 3/8" x 4" Tray
 STP1-2102 perforated 12 3/4" x 10 3/8" x 2 1/2" Tray
 STP1-2104 perforated 12 3/4" x 10 3/8" x 4" Tray
 ST13-11-2 Lid Cover: fits trays STE1-2104, STP1-2102, STP1-2104



Stainless Steel Instrument Trays & Lid Covers

Heavy duty / seamless / covered corners / easy to sterilize / for instrument trays / recessed strap handles / easy to handle / easy to store

- ST43 5 3/8" x 4" x 2 5/8" Tray
- ST43-2 Lid Cover: fits tray ST43

- ST63 6 1/8" x 6 1/8" x 2 7/8" Tray
- ST63-2 Lid Cover: fits tray ST63

- ST95-3 8 7/8" x 5" x 3" Tray
- ST95-2 8 7/8" x 5" x 2" Tray
- ST95-2-2 Lid Cover: fits trays ST952 & ST953

- ST10-02 10" x 6 1/2" x 2" Tray
- ST10-02-2 Lid Cover: fits tray ST1002

- ST12-02 12 1/4" x 7 3/4" x 2 1/4" Tray
- ST12-02-2 Lid Cover: fits tray ST1202

- STE1-082 10" x 8 1/4" x 2 1/2" Tray
- ST10-82-2 Lid Cover: fits trays STE1082

- STE1-654 16 1/2" x 10" x 4" Tray
- STE1-650 16 1/2" x 10" x 2 1/2" Tray
- ST16-50-2 Lid Cover: fits trays STE1650 & STE1654

- STE9-02 6 7/8" x 4 1/4" x 2" Tray

- STE2-304 13 7/8" x 12 7/8" x 4" Tray
- STE2-302 13 7/8" x 12 7/8" x 2 1/2" Tray

- STE0-6066 6 7/8" x 6 3/8" x 6" Tray
- STE0-6064 6 7/8" x 6 3/8" x 4" Tray
- STE0-6062 6 7/8" x 6 3/8" x 2 1/2" Tray
- ST60-2-2 Lid Cover: fits trays STE06062, STE06064 & STE06066

- STE1-0066 10 3/8" x 6 3/8" x 6" Tray
- STE1-0064 10 3/8" x 6 3/8" x 4" Tray
- STE1-0062 10 3/8" x 6 3/8" x 2 1/2" Tray
- ST40-2-2 Lid Cover: fits trays STE10062, STE10064 & STE10066

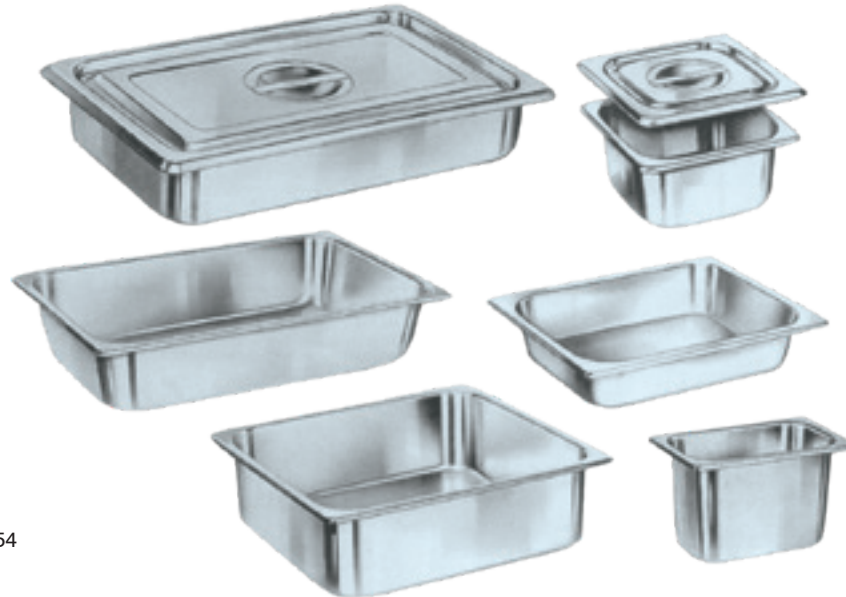

* "Check Your Measurements", These items are FINAL SALE

Stainless Steel Instrument Trays & Lid Covers **Continued**

For instrument trays / standard weight / 22 gauge

- STE1-2066 12 3/4" x 6 7/8" x 6" Tray
- STE1-2064 12 3/4" x 6 7/8" x 4" Tray
- STE1-2062 12 3/4" x 6 7/8" x 2 1/2" Tray

Heavy weight / 20 gauge

- STS1-2066 12 3/4" x 6 7/8" x 6" Tray
- STS1-2064 12 3/4" x 6 7/8" x 4" Tray
- STS1-2062 12 3/4" x 6 7/8" x 2 1/2" Tray
- ST30-2-2 Lid Cover: fits trays STE1-2062, STE1-2064, STE1-2066, STS1-2062, STS1-2064, STS1-2066

Standard weight / 22 gauge

- STE1-2106 12 3/4" x 10 3/8" x 6" Tray
- STE1-2104 12 3/4" x 10 3/8" x 4" Tray
- STE1-2102 12 3/4" x 10 3/8" x 2 1/2" Tray

Heavy weight / 20 gauge

- STS1-2106 12 3/4" x 10 3/8" x 6" Tray
- STS1-2104 12 3/4" x 10 3/8" x 4" Tray
- STS1-2102 12 3/4" x 10 3/8" x 2 1/2" Tray
- ST13-11-2 Lid Cover: fits trays STE1-2102, STE1-2104, STE1-2106, STS1-2102, STS1-2104, STS1-2106

Standard weight / 22 gauge

- STE2-0126 20 3/4" x 12 3/4" x 6" Tray
- STE2-0124 20 3/4" x 12 3/4" x 4" Tray
- STE2-0122 20 3/4" x 12 3/4" x 2 1/2" Tray

Heavy weight / 20 gauge

- STS2-0126 20 3/4" x 12 3/4" x 6" Tray
- STS2-0124 20 3/4" x 12 3/4" x 4" Tray
- STS2-0122 20 3/4" x 12 3/4" x 2 1/2" Tray
- ST20-00-2 Lid Cover: fits trays STE2-0122, STE2-0124, STE2-0126, STE2-0122, STE2-0124, STE2-0126

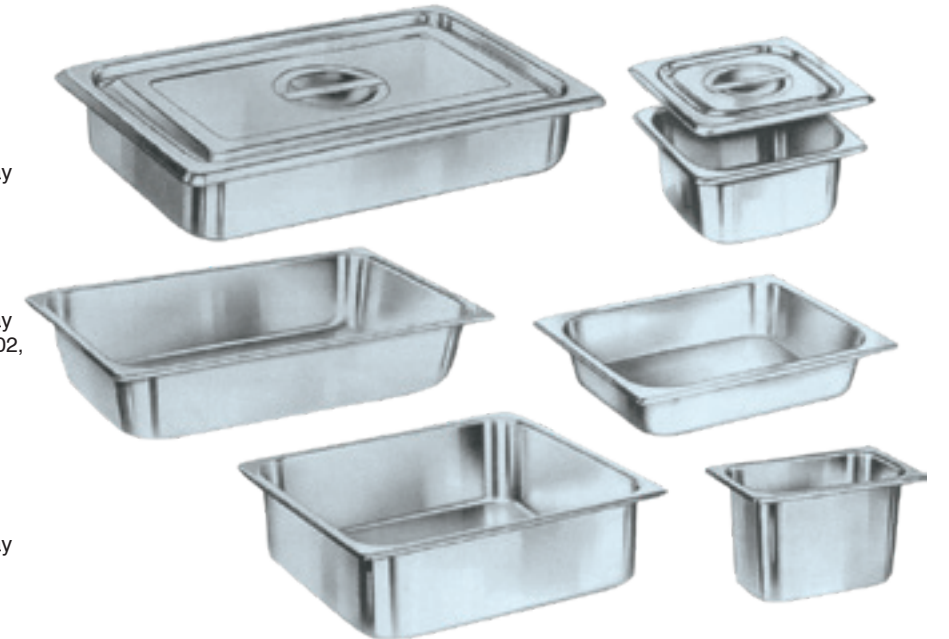

* "Check Your Measurements", These items are FINAL SALE

Stainless Steel Instrument Trays & Lid Covers **Continued**

For instrument trays / standard weight / 22 gauge

- STE1-2066 12 3/4" x 6 7/8" x 6" Tray
- STE1-2064 12 3/4" x 6 7/8" x 4" Tray
- STE1-2062 12 3/4" x 6 7/8" x 2 1/2" Tray

Heavy weight / 20 gauge

- STS1-2066 12 3/4" x 6 7/8" x 6" Tray
- STS1-2064 12 3/4" x 6 7/8" x 4" Tray
- STS1-2062 12 3/4" x 6 7/8" x 2 1/2" Tray
- ST30-2-2 Lid Cover: fits trays STE1-2062,
STE1-2064, STE1-2066, STS1-2062,
STS1-2064, STS1-2066

Standard weight / 22 gauge

- STE1-2106 12 3/4" x 10 3/8" x 6" Tray
- STE1-2104 12 3/4" x 10 3/8" x 4" Tray
- STE1-2102 12 3/4" x 10 3/8" x 2 1/2" Tray

Heavy weight / 20 gauge

- STS1-2106 12 3/4" x 10 3/8" x 6" Tray
- STS1-2104 12 3/4" x 10 3/8" x 4" Tray
- STS1-2102 12 3/4" x 10 3/8" x 2 1/2" Tray
- ST13-11-2 Lid Cover: fits trays STE1-2102,
STE1-2104, STE1-2106, STS1-2102,
STS1-2104, STS1-2106

Standard weight / 22 gauge

- STE2-0126 20 3/4" x 12 3/4" x 6" Tray
- STE2-0124 20 3/4" x 12 3/4" x 4" Tray
- STE2-0122 20 3/4" x 12 3/4" x 2 1/2" Tray

Heavy weight / 20 gauge

- STS2-0126 20 3/4" x 12 3/4" x 6" Tray
- STS2-0124 20 3/4" x 12 3/4" x 4" Tray
- STS2-0122 20 3/4" x 12 3/4" x 2 1/2" Tray
- ST20-00-2 Lid Cover: fits trays STE2-0122,
STE2-0124, STE2-0126, STE2-0122,
STE2-0124, STE2-0126

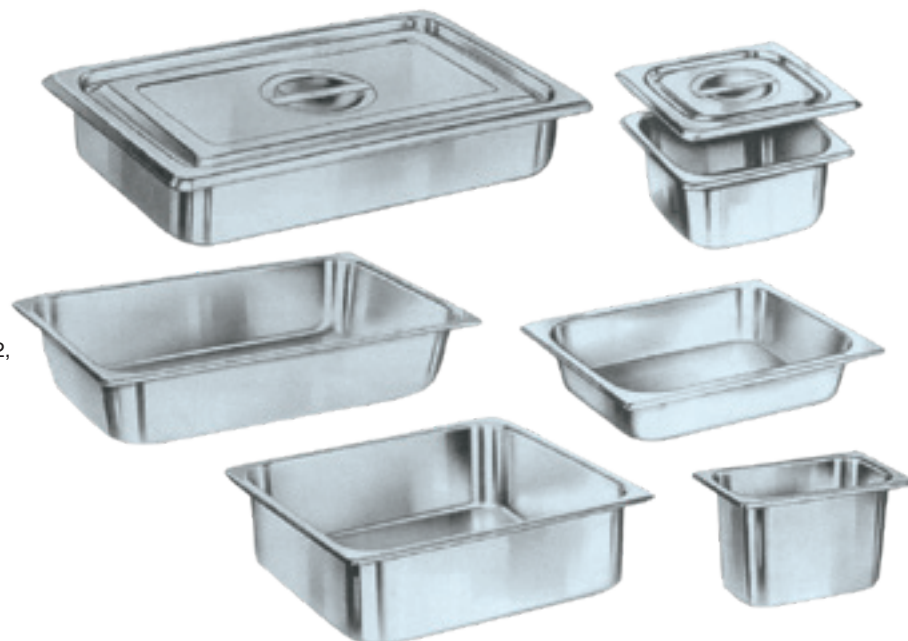

* "Check Your Measurements", These items are FINAL SALE

Emesis Basin

- ST6 10 oz.
- ST8 12 oz.
- ST10 26 oz.
- ST12 50 oz.



Instrument Tray

Rolled edge

- ST10-F 10" x 6 1/2" x 3/4"
- ST13-F 13 1/2" x 9 3/4" x 3/4"
- ST15-20 21 1/4" x 16 1/4" x 7/8"
- ST15-F 15 1/8" x 10 5/8" x 3/4"
- ST17-F 17" x 11 5/8" x 3/4"
- ST19-F 19 1/8" x 12 5/8" x 3/4"



Perforated Mayo Tray

ST10-F-PMT	10" x 6 1/2" x 3/4"
ST15-20-PMT	21 1/4" x 16 1/4" x 7/8"
ST15-F-PMT	15 1/8" x 10 5/8" x 3/4"
ST17-F-PMT	17" x 11 5/8" x 3/4"
ST19-F-PMT	19 1/8" x 12 5/8" x 3/4"



Non-Perforated Mayo Tray

ST3-926	10" x 6 1/2" x 3/4"
ST3-927	14" x 10" x 5/8"
ST3-929	17" x 11 5/8" x 3/4"
ST3-930	19 1/8" x 12 5/8" x 3/4"



Iodine Cup

ST6G	6 oz.	3 7/16" x 2"
ST14-G	14 oz.	4 3/8" x 2 5/8"

* "Check Your Measurements",
These items are FINAL SALE



Medicine Cup

ST2	2 oz.
-----	-------



Sponge Bowl

Flat bottom / straight sides /
extra stable

- ST10-7 64 oz. 7 9/16" x 3"
- ST14-8 48 oz. 7 1/8" x 2 3/4"
- ST10-6 36 oz. 6 1/4" x 2 3/4"
- ST10-0 30 oz. 5 9/16" x 2 9/16"
- ST75 20 oz. 5" x 2 3/8"
- ST52 14 oz. 4 1/4" x 2"

* "Check Your Measurements",
These items are FINAL SALE



Dressing Jar

With cover / cover
included with jar

- ST2J 2 quart
- ST3J 3 quart
- ST4J 4 3/4 quart
- ST6J 6 quart
- ST8J 8 quart



Forceps Jar

- ST14-K 1 x 4"
- ST32-K 2 1/4 x 4 1/2"
- ST72-K 2 1/4 x 7"



Tip Cover

For surgical instrument tip protection / economical & long-lasting / prevents damaging tips and edges / steam-permeable / autoclavable / conveniently color coded / soft vinyl construction, no latex / for a wide variety of instruments, including: scissors, forceps, curettes, drills, and retractors

* See colors online
 * Larger sizes available. Please call for details.
 * Individual styles, packaged 100 per bag

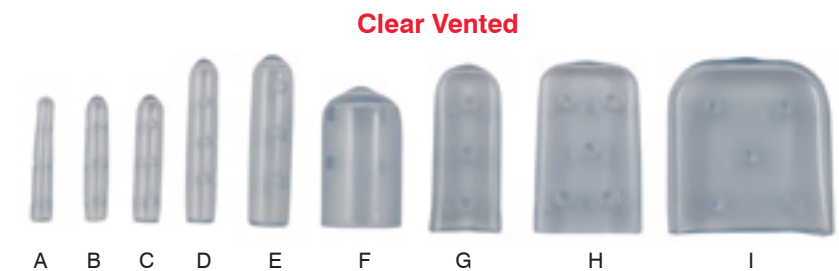
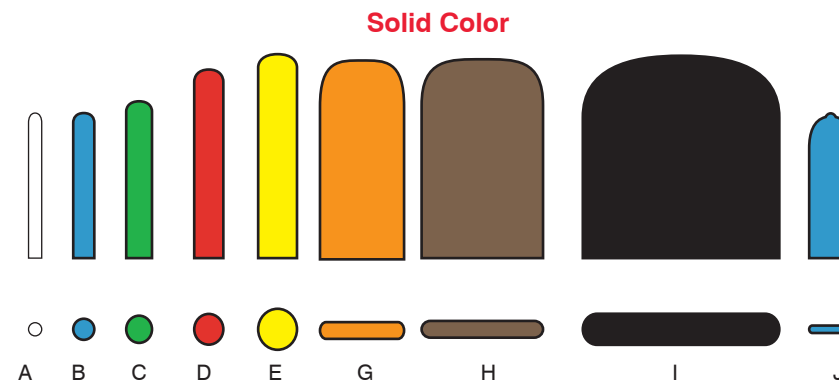

Individual styles, packaged 100 per bag

	Color	Solid #	Tinted #
A	White	105-730	105-782
B	Blue	105-732	105-783
C	Green	105-734	105-784
D	Red	105-736	105-785
E	Yellow	105-738	105-786
G	Orange	105-742	105-787
H	Brown	105-744	105-789
I	Black	105-746	105-790
J	Blue	105-764	N/A

Individual styles, packaged 100 per bag

	Size	Item #
A	1.6 mm x 19 mm	105-791
B	2 mm x 19 mm	105-792
C	2.8 mm x 19 mm	105-793
D	3 mm x 25 mm x 25 mm	105-794
E	3.2 mm x 25.4 mm	105-7951
F	5 mm x 25 mm	105-796
G	10 mm x 19 mm	105-797
H	2 mm x 9 mm x 25 mm	105-798
I	2 mm x 16 mm x 25 mm	105-799
	Assorted Sizes	105-791A

Available Assortments

	Solid #	Tinted #	Clear Vented	Description
Large Assorted	105-748	105-780		Bag of 100, Equal parts A - J
Small Assorted	105-750	105-781		Bag of 100, Equal parts A - E, G, J
Large Assorted			105-791A	Bag of 100 All sizes A - I

Sontec® Sheet Tape

For surgical instrument identification / color-codes instruments with pre-cut strips / each 8 1/2" x 11" sheet contains: 44 strips, 2" long x 1/4" wide / 220 strips, 1" long x 1/4" wide (total: 264 strips, 374" of tape)

* See colors online
 * PLEASE NOTE: Sontec® Sheet Tape is not recommended for use with cold sterilization fluids.
 * Size and color of tapes may vary slightly from actual products



	105-610 White		105-581 Plum		105-640 Fuchsia
	105-612 Kelly Green		105-540 Blue/Green		105-642 Medical Blue
	105-614 Red		105-541 Blue/Red		105-644 Emerald Green
	105-616 Yellow		105-542 Yellow/Blue		105-646 Violet
	105-618 Orange		105-543 Yellow/Green		105-660 Fuchsia
	105-620 Gray		105-544 Yellow/Red		105-662 Medical Blue
	105-622 Lavender		105-686 Purple/Black		105-664 Emerald Green
	105-624 Beige		105-688 Orange/Black		105-666 Violet
	105-626 Light Blue		105-690 Blue/Black		105-590 Smiley Face, Yellow/Black
	105-628 Lime Green		105-692 Rubine/Black		105-600 Red Hearts on White
	105-630 Pink		105-694 Yellow/Black		105-602 White Hearts on Red
	105-632 Plum		105-696 Green/Black		105-670 Fuchsia*
	105-570 Royal Blue		105-720 Lime Green		105-672 Medical Blue*
	105-571 Kelly Green		105-722 Gray		105-674 Emerald Green*
	105-572 Red		105-723 Beige		105-676 Violet*
	105-573 Yellow		105-724 Light Blue	* Each color sheet contains numbers 0 - 8	
	105-574 Orange		105-725 Pink		105-550 Red/White/Blue
	105-575 Brown		105-726 Plum		105-551 Red/White/Black
	105-576 Black		105-727 Lavender		105-552 Red/Yellow/Black
	105-577 Lavender		105-650 Fuchsia		105-553 Red/Black/Green
	105-578 Light Blue		105-652 Medical Blue	Above Styles: 3/8" wide, 245" total tape	
	105-579 Lime Green		105-654 Emerald Green		
	105-580 Pink		105-656 Violet		







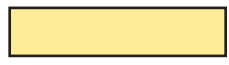

Medi-Mark™ Tape

Surgical instrument color coding system / fast and efficient identification system / available in 9 solid colors / one spool codes an average of 230 instruments / clinically proven safe in conventional, flash and gas sterilization / bonds to itself / lasts many months

* PLEASE NOTE: Medi-Mark™ Tape is not recommended for use with cold sterilization fluids.
* See colors online

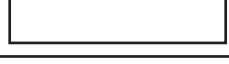
Application of Medi-Mark™ Tape

1. Instrument and hands must be clean and dry.
2. Cut Medi-Mark™ Tape with scissors. DO NOT STRETCH!
3. Overlap Medi-Mark™ Tape once.
4. Replace Medi-Mark™ Tape when color changes, before it becomes brittle.
5. Avoid placing Medi-Mark™ Tape on the shank of scissors.

	105-700 Green
	105-702 Yellow
	105-704 Blue
	105-706 Red
	105-708 Brown
	105-710 White
	105-712 Orange
	105-714 Black
	105-716 Purple

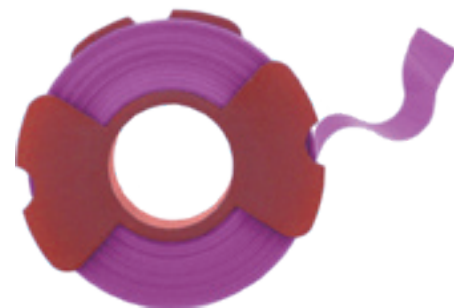
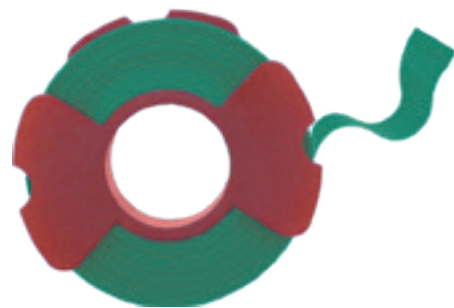

Whisk 'R Brush™

For general purpose cleaning / two bristle lengths & a sure-grip handle / available sterile & non-sterile / convenient & economical / simple to use on various shapes and surfaces / for a wide variety of instruments, including: burs, drill points, rasps, and rongeurs / easily removes bone fragments and soft tissue

- 9B-010 12 sterile brushes
- 9B-025 25 non-sterile brushes
- 9B-020 100 non-sterile brushes



Endozime AW Triple Plus®

- Multi-tiered enzymatic cleaner
- specifically designed for all washers, washer sterilizers, ultrasonics and manual cleaning
- proprietary synergistic mixture of enzymes and non-ionic detergents
- Protease, Amylase, Lipase, Carbohydrase and other proprietary enzymes
- dissolves all blood, fat, protein, carbohydrates and starches
- built in detergent eliminating the need for all other cleaners and detergents
- compatible with all washers, washer sterilizers and ultrasonics
- strong enough for the most difficult instruments but safe on the most delicate

345A-P16 16 oz
345A-PAG1 1 gal



Surgistain®

- Rust and stain remover
- removes rust, pitting, stains and corrosion from stainless steel instruments
- restores instrument's original finish
- restores articulation to box-locks and joints
- prevents destructive pitting on ridges of micro instruments
- non-corrosive; will not harm quality stainless steel

345B-16 16 oz
345B-G1 1 gal



Premixslip®

- instrument lubricant and rust inhibitor
- the only bacteriostatic pre-mixed instrument lubricant and rust inhibitor
- clinically tested to be thoroughly steam penetrable, steam sterilizable and ETO sterilizable
- prevents rust, spots, stains and corrosion
- non-oily, non-sticky, non-toxic and silicone free
- bacteriostatic high-grade mineral oil lubricant

345P-MX16 16 oz
345P-MXG1 1 gal



Prepzyme®

- multi-tiered enzymatic foam spray
- prevents bio-film from adhering to surface prior to decontamination
- foaming spray covers soiled instruments, scopes and biopsy forceps
- breaks down blood, fat, carbohydrates and starches immediately
- perfect for use in departments where instruments & scope cleaning is not readily available
- safe for all instruments and scopes (flexible or rigid), extends usable lifetime
- neutral PH, non-abrasive, free-rinsing and 100% biodegradable
- will not harm any metals, plastic, rubber, glass or corrugated tubing

345P-RP08 8 oz (with sprayer)
345P-RP22 22 oz (with sprayer)



F*A*C*T*S®

- foaming autoclave cleaning treatment system
- removes all rust, pitting, stains and corrosion from walls of autoclaves and from stainless steel carts and trays
- removes scale, alkaline and mineral deposits
- foaming spray remains on walls longer for better penetration
- eliminates all noxious odors
- restores original finish to all autoclaves, carts and trays
- non-corrosive; will not harm quality stainless steel

345F-CT22 22oz (with sprayer)
345F-CT1G 1 gal



INSTRU-BIN

- for large instruments
- for soaking and safely transporting soiled instruments without messy spills
- durable snap-down lid and transparent walls
- light-weight and sturdy with integrated handles for easy lifting and carrying
- multi-purpose, reusable, high quality
- includes mesh blanket

3451-B



Barraquer Wire Speculum

Standard

10-1000	10 mm blades	
T10-1000	10 mm blades	titanium
10-1005	12 mm blades	
T10-1005	12 mm blades	titanium
10-1007	14 mm blades	
T10-1007	14 mm blades	titanium
10-1010	15 mm blades	
T10-1010	15 mm blades	titanium

Closed wire / curved blades

10-1000C	10 mm blade	15 mm spread small	
10-1000C-13	13 mm blade	10 mm spread	
T10-1000C	10 mm blade	15 mm spread small	titanium
10-1005C	12 mm blade	18 mm spread medium	
10-1010C	14 mm blade	18 mm spread large	
10-1010C-08	8 mm blade	16 mm spread	
T10-1010C	14 mm blade	18 mm spread large	titanium

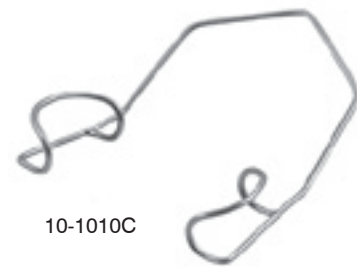
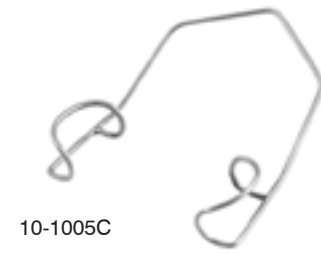
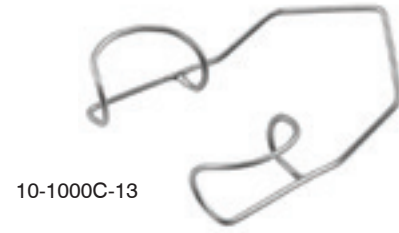
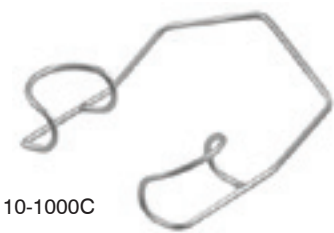
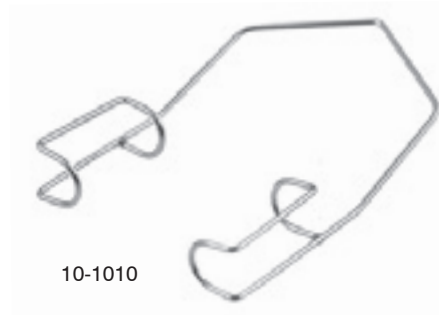
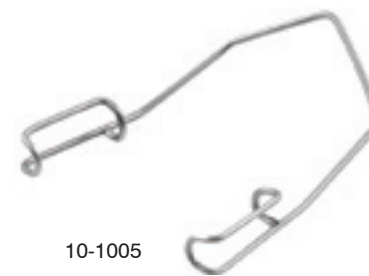
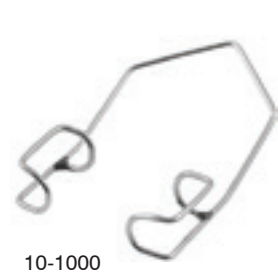

Barraquer Wire Speculum Third Eye Lid

Closed blades

T10-1013	10 mm blades	18 mm spread	left third eye lid	titanium
T10-1014	10 mm blades	18 mm spread	right third eye lid	titanium
10-1015	14 mm blades	18 mm spread	left third eye lid	
10-1016	14 mm blades	18 mm spread	right third eye lid	
T10-1015	14 mm blades	18 mm spread	left third eye lid	titanium
T10-1016	14 mm blades	18 mm spread	right third eye lid	titanium

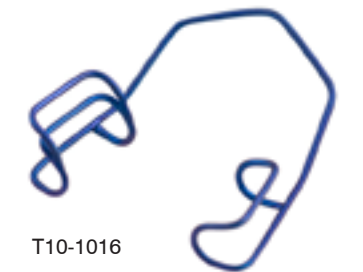
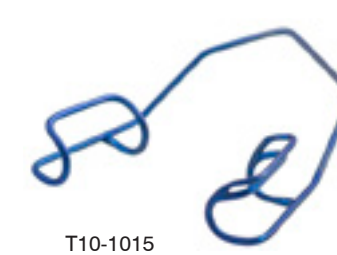
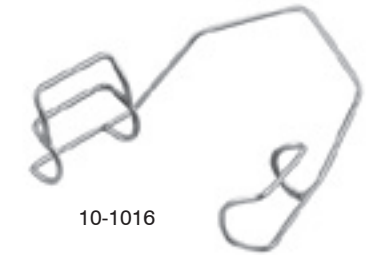
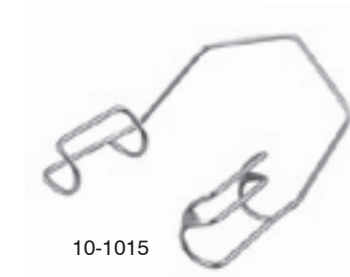
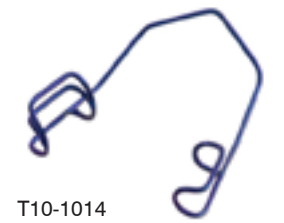
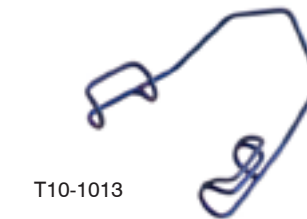

Barraquer Wire Speculum

Solid blades

10-1020	small	stainless
T10-1020	small	titanium
10-1030	large	stainless
T10-1030	large	titanium



10-1020



10-1030

Kratz Aspirating Wire Speculum

V-shaped blades

10-1043	open blades
10-1062	closed blades

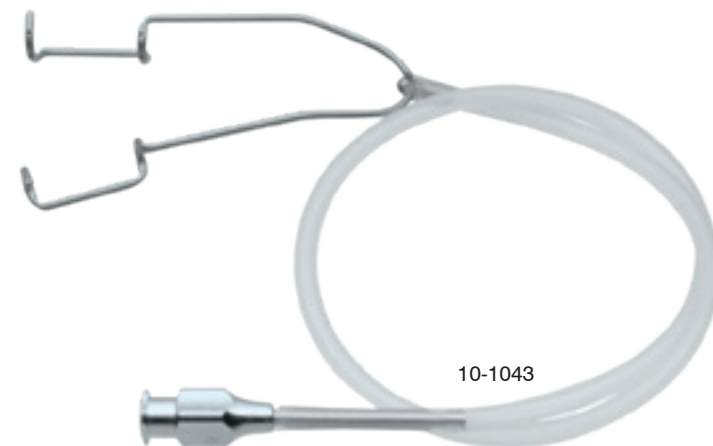

10-1043

Kratz-Barraquer Wire Speculum

Open blades / stainless steel

10-1054	4 mm blades
10-1053	8 mm blades
10-1055	10 mm blades
10-1050	15 mm blades

Open blades / titanium

T10-1054	4 mm blades
T10-1053	8 mm blades
T10-1056	10 mm blades
T10-1051	15 mm blades

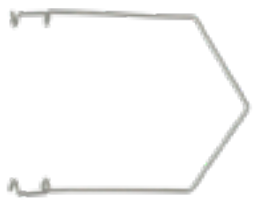

10-1054



10-1053



10-1055



T10-1051

McIntyre Wire Speculum

Gently curved springs / v-shaped blades

- 10-1044 open wire
- 10-1045 closed wire

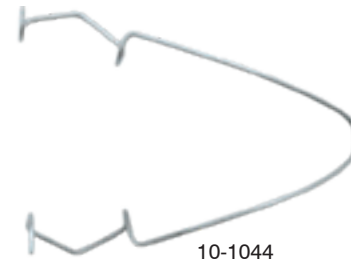

10-1044

CSU Wire Eye Speculum

Open blades / 14x6 mm blades / 2 1/2" (6.5 cm)

- 10-1042

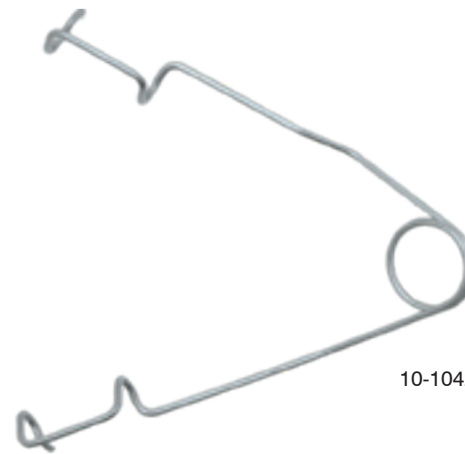

10-1042

Nevyas Wire Speculum

Curved blades / open wire

- 10-1046

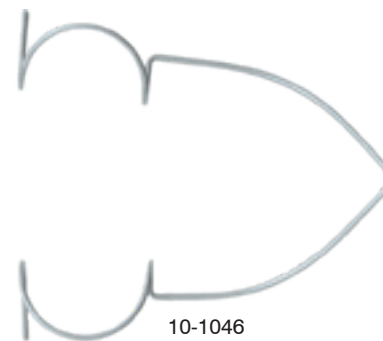

10-1046

Deluxe Wire Speculum

8 mm x 5 mm / finger discs / closed wire

- 10-1047 stainless steel
- T10-1048 titanium

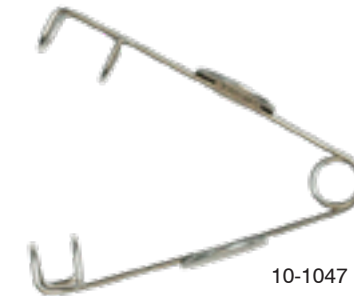

10-1047

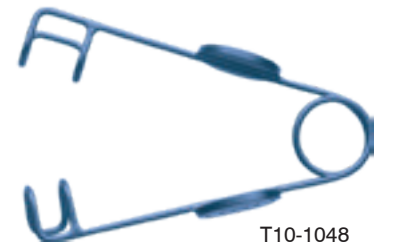

T10-1048

Floyd Barraquer Speculum

Closed wire / 14 mm w/ 6 mm lifting wings

- 10-1048

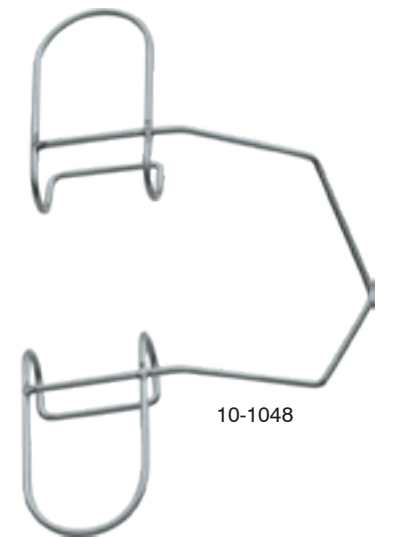

10-1048

Grandon-Barraquer Wire Speculum

With suture notches

- 10-1070



10-1070

McKee Eye Speculum

Malleable
10-1150

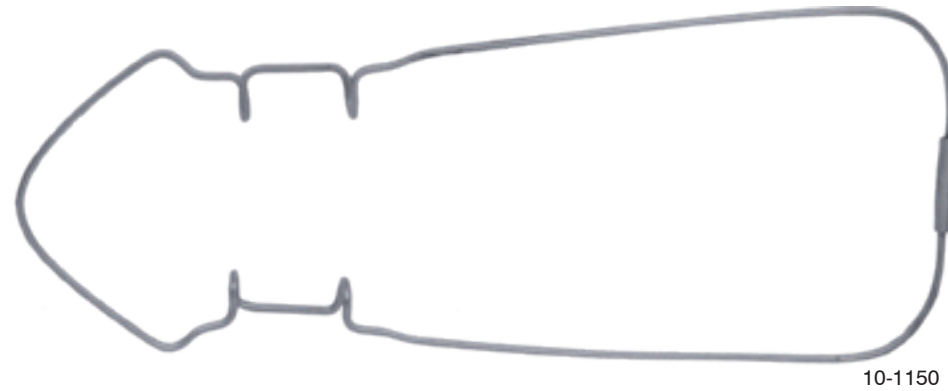

10-1150

Barraquer Infant Wire Speculum

Closed wire blades / gently curved springs / v-shaped
10-1340 4 mm blades

Closed wire blades

10-1350 4 mm blades 30 mm total length
10-1360 8 mm blades
10-1360H 8 mm blades heavy

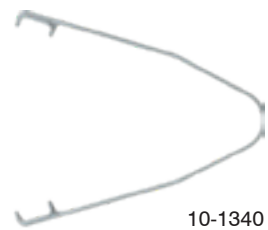

10-1340

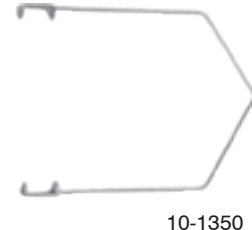

10-1350

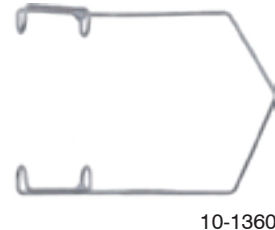

10-1360



10-1360H

Sauer Lid Speculum

Solid blades

10-1300 for infants
10-1300S for premature infants
T10-1320 adult
T10-1300S premature infants titanium



10-1300



10-1300S



T10-1320



T10-1300S

Murdoch Eye Speculum

Locking screw / open blades
10-1420 small
10-1422 large



10-1422

Cook Eye Speculum

Non-magnetic / locking screw / Solid blades

10-1400 very small
10-1401 small
10-1402 medium
10-1403 large

Non-magnetic / locking screw / Double bar

10-1404 small 11 mm
10-1405 large 15 mm



10-1404



10-1405



10-1400



10-1401

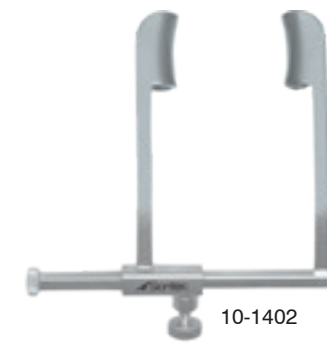

10-1402



10-1403

Lancaster Eye Speculum

Adjustable mechanism / malleable arms /
solid blades / locking nut / 15 mm blade

10-1600



10-1600

Sontec Castroviejo Eye Speculum

Adjustable mechanism

10-1702 medium #2 15 mm blade
10-1703 large #3 18 mm blade



10-1702

Classic Castroviejo Eye Speculum

Adjustable mechanism

10-1701C small #1 14 mm blade
10-1703C large #3 16 mm blade

Adjustable mechanism / titanium

T10-1701C small #1 14 mm blade
T10-1703C large #3 16 mm blade



10-1703C

Castroviejo Equine Eye Speculum

1" / 25 mm blades / 4 3/4" (cm)

10-1704



10-1704

Williams Eye Speculum

Locking screw / open blades

10-1500 small
10-1510 large



10-1500



10-1510

Weiss Eye Speculum

Fenestrated blades

- 10-1550 adult 17mm
- 10-1552 child 14mm

Solid blades

- 10-1554 adult 17mm
- 10-1556 child 14mm



10-1550



10-1556

Fishkind Eye Speculum

Adjustable mechanism / open blades

- 10-1660 stainless
- T10-1660 titanium



10-1660



T10-1660

Lieberman Eye Speculum

Nasal approach eye speculum / v-shaped blades / titanium

- T10-1753 11 mm
- T10-1751 15 mm
- T10-1749 16 mm

* Also available in Aspirating

Temporal approach eye speculum / v-shaped blades / titanium

- T10-1746 14 mm universal arms
- T10-1750 16 mm
- T10-1752 15 mm
- T10-1754 26 mm

* Also available in Aspirating



T10-1753

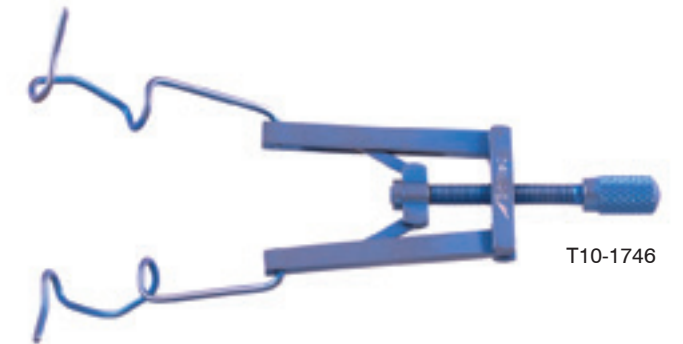

T10-1746

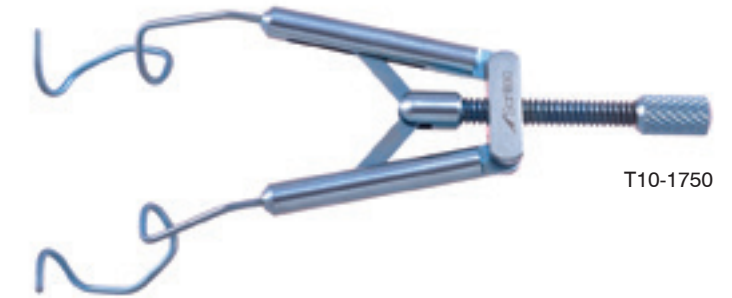

T10-1750



T10-1754

Lieberman Eye Speculum

Temporal approach eye speculum / curved blades / extended arm blades / titanium

- T10-1748 13 mm
- T10-1747 14 mm
- T10-1744 14 mm with bead tip blade ends
- T10-1742 15 mm

* Also available in Aspirating



Wright Fascia Needle

With suture eye / sharp tip / 1 mm x 6 mm oval / 5 1/2" (14 cm)

10-4600



Lieberman Eye Speculum

Universal approach eye speculum (nasal or temporal) / max spread 48 mm / complete 4 sets of blades, including: 12 mm & 15 mm solid blades, 12 mm & 16 mm wire blades / 2 1/2" (6.5 cm)

T10-1760



Maumenee-Park Eye Speculum

Non-magnetic / canthus hook blades / solid blades

10-1800

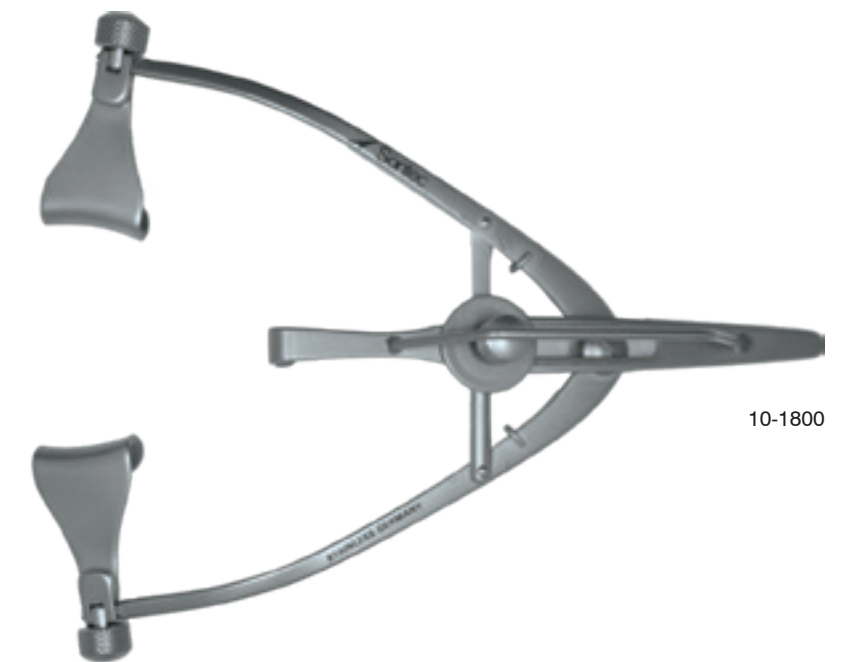

Flieringa Scleral Fixation Ring

Set of 9 sizes, 14 mm - 22 mm

10-3100-SET

Also sold individually

- 10-3140 14 mm
- 10-3150 15 mm
- 10-3160 16 mm
- 10-3170 17 mm
- 10-3180 18 mm
- 10-3190 19 mm
- 10-3200 20 mm
- 10-3210 21 mm
- 10-3220 22 mm



McNeill-Goldman Scleral Fixation Ring & Blepharostat

Stainless

- 10-3310 small 15 mm inside diameter
- 10-3312 medium 16 mm inside diameter
- 10-3314 large 17 mm inside diameter

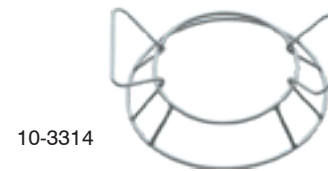

10-3314

Schepens Scleral Depressor

With thimble / black

- 10-3800 small #8
- 10-3810 medium #10
- 10-3820 large #12



10-3800

10-3820

Scleral Depressor

Double-ended / with clip

- 10-3825
- T10-3825 titanium
- T10-3840 titanium handle



10-3825

T10-3825

T10-3840

Gil-Vernet Desmarres Retractor

5 3/4" (14.5 cm)

- 10-4211 size 1
- 10-4221 size 2
- 10-4231 size 3
- 10-4241 size 4



10-4211

10-4231

10-4221

10-4241

10-4241

Desmarres Lid Retractor

Stainless steel / 5 1/2" (14 cm)

- 10-4192 6 mm
- 10-4194 8 mm
- 10-4196 9 mm
- 10-4198 10 mm
- 10-4200 11 mm
- 10-4201 11 mm electro-blue coated
- 10-4206 12 mm
- 10-4207 12 mm electro-blue coated
- 10-4210 13 mm
- 10-4213 13 mm electro-blue coated
- 10-4216 14 mm
- 10-4220 15 mm



10-4200



10-4223

- 10-4218 14 mm
- 10-4223 15 mm electro-blue coated
- 10-4226 16 mm
- 10-4227 16 mm electro-blue coated
- 10-4230 17 mm



10-4236

- 10-4233 17 mm electro-blue coated
- 10-4236 18 mm
- 10-4237 18 mm electro-blue coated
- 10-4240 19 mm

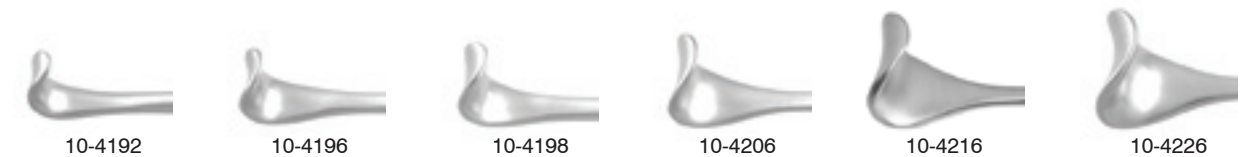

10-4192

10-4196

10-4198

10-4206

10-4216

10-4226

Stevenson Lacrimal Retractor

Adjustable spread

- 10-5500 3 x 3 blunt prongs
- 10-5520 serrated solid blades



10-5500

Agricola Lacrimal Retractor

Adjustable spread

- 10-5540 2 x 2 sharp prongs
- 10-5550 3 x 3 sharp prongs



10-5550

Goldstein Lacrimal Retractor

Adjustable spread / 1 1/4" (3 cm)

10-5552 3 x 3 prongs



10-5552

Corneal Eye Shields in Non-Reflective Laser Finish or Electro Blue Coating

Non-reflective laser finish stainless / 22 mm x 27 mm

18-8026 can be used with suction cup 18-8028
 18-8025 can be used with suction cup 18-8028 pair
 18-8022 with handle
 18-8020 with handle pair

Electro blue coated / 22 mm x 27 mm

18-8026B without handle
 18-8025B without handle pair
 18-8022B with handle
 18-8020B with handle pair

Titanium / 24 mm x 21 mm

T18-8023 with handle



18-8022



18-8026



18-8022B



T18-8023

Corneal Eye Shield

Sterilize by ETO only / green is the normal stock color, to order other colors please specify when minimum quantity is 4 each

1100-409PG pediatric 15.5 mm x 16.5 mm
 1100-409SG small 20.5 mm x 22.5 mm
 1100-409MG medium 24.5 mm x 22.5 mm
 1100-409LG large 24.5 mm x 26.5 mm

* Color order key: W=White / O=Orange / C=Clear
 * Colors: clear, white, green, or orange
 * Please be specific when ordering

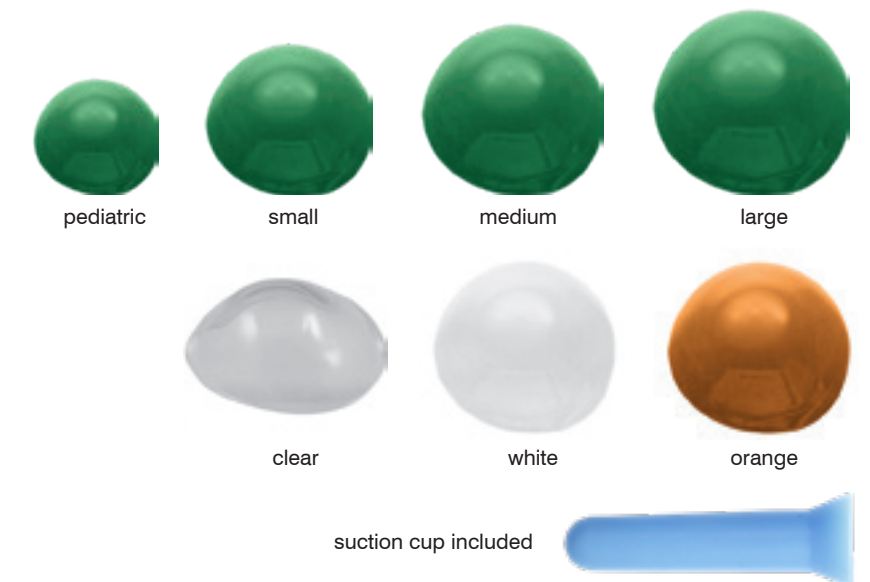

Suction Cup Handle for Eye Shields

18-8028 silicone blue



18-8028

Eye Ribbon Retractor

Malleable / 4 1/4" (11 cm)
10-5400 stainless



10-5400

Flexible Neck Hook Retractor

5" (13 cm)
205-819 sharp 3 prongs

6" (15 cm)
205-820 sharp 1 prong
205-826 blunt 1 prong
205-822 sharp 2 prongs
205-828 blunt 2 prongs
205-824 sharp 3 prongs
205-830 blunt 3 prongs

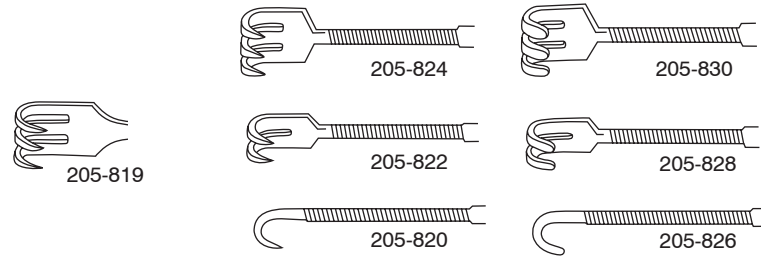

205-822

205-828

Blair Hook Retractor

Four prongs / 5" (12.5 cm)
205-847 sharp
205-848 blunt



205-848

Knapp Rollet Hook Retractor

4 prongs / 5" (12.5 cm)
205-844 sharp
205-846 blunt



205-844

Miller Skin Rake Retractor

5" (12.5 cm)
199-480 9 prong sharp
199-481 9 prong blunt
199-482 6 prong sharp
199-483 6 prong blunt



199-481

Paul Skin Rake Retractor

Blunt / 5" (12.5 cm)
199-490



199-490

Helveston Tissue Retractor

2 mm wide / curved blade
10-5480 stainless
T10-5480 titanium



T10-5480

Helveston Tissue Retractor

Single ended / curved / flat handle / 5"
10-5487 7 mm
10-5489 9 mm
10-5491 11 mm

Single ended / curved / flat handle / titanium / 5"
T10-5487 4 x 7 mm
T10-5489 4 x 9 mm
T10-5491 4 x 11 mm



10-5487

10-5489

10-5491

T10-5487

T10-5489

T10-5491

Tooke Corneal Knife

Straight blade / curved cutting edge
11-3350



11-3350

Gill Corneal Knife

Straight
11-3400



11-3400

Troutman Corneal Knife

Single end
11-3421



11-3421

Fukasaku Hockey Knife

Sharp front edge / semi-sharp bottom edge
11-3735



11-3735

Barraquer Keratoplasty Dissecting Knife

11-3419



11-3419

Von Graefe Needle

Curved blade
11-1010



11-1010

Martinez Corneal Dissector

Double-ended
11-3420



11-3420

Troutman Sontec Corneal Dissector

Single-ended
11-3423



11-3423

Golf Club Foreign Body

Angled / slightly-round tip
11-3700

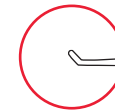

11-3700

Walter Corneal Foreign Body

Sharp
11-3740

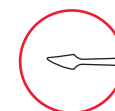

11-3740

Francis Foreign Body

Angled / flag-shaped tip
11-3750



11-3750

Ellis Foreign Body

Curved / slightly-round tip
11-3760

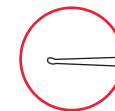

11-3760

Drysdale Nucleus Manipulator

Angled tip
12-5850 stainless
T12-5850 titanium



T12-5850

Angled tip / with anterior capsule polisher / stainless steel

12-5851

Bechert-Wilkie Spud/Rotator

Formed, angled tip
12-5852 stainless 14 mm
T12-5852 titanium 14 mm



T12-5852

Castroviejo Blade Breaker Holder with Sliding Lock

Long model
11-4700



11-4700

Troutman-Castroviejo Mini Blade Breaker Holder

10 x 3 mm angled jaw
11-4770



11-4770

Sontec Micro Blade Breaker Holder

7 x 2 mm
11-4780



11-4780

Castroviejo Blade Breaker Holder

Short model
11-4800



11-4800

Swiss Model Blade Breaker Holder

Spherical tip
11-4850



11-4850

Sontec Double Edge Blades

For blade breakers above / carbon steel
11-5200 10pk non-sterile
11-5210 50pk non-sterile

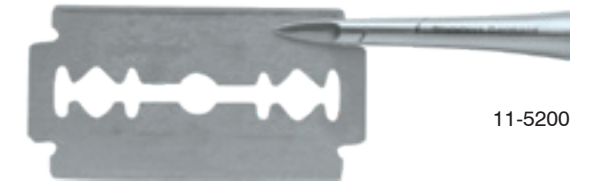

11-5200

Gass Corneoscleral Punch

1 mm diameter head / 0.75 mm deep bite
/ rotatable tip for convenient positioning
11-9200

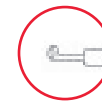

11-9200

Kelly Descemets Membrane Punch

1.0 mm diameter head / 0.75 mm deep bite
11-9270

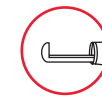

11-9270

Algerbrush II Corneal Rust Ring Remover Burr

Battery powered

- 11-4600 complete w/ 0.5 mm burr
- 11-4601 complete w/ 1 mm burr
- 11-4610 burr only 0.5 mm
- 11-4609 burr only 1 mm



11-4600

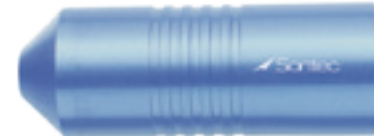

11-4610

Algerbrush II Pterygium Burr

Battery powered

- 11-4611 complete w/ 2.5mm Fine ball tip
- 11-4612 2.5 mm fine ball tip only
- 11-4613 complete w/ 3.5mm medium ball tip
- 11-4614 3.5 mm medium ball tip only
- 11-4615 complete w/ 4mm fine wheel
- 11-4616 4 mm fine wheel tip only
- 11-4617 complete w/ 5mm medium wheel
- 11-4618 5 mm wheel tip only



11-4611

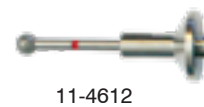

11-4612



11-4614



11-4616



11-4618



Meyerhoefer-Chalazion Curette

5" (12.5 cm)

- 12-1285 0.5 mm
- 12-1290 1.0 mm
- 12-1300 1.5 mm
- 12-1310 1.75 mm
- 12-1320 2.0 mm
- 12-1355 2.5 mm
- 12-1360 3.0 mm
- 12-1365 3.5 mm
- 12-1367 4.0 mm
- 12-1368 4.5 mm

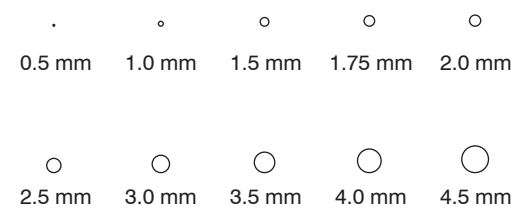

12-1368

House Curette

Double-ended / 5 3/4" (14.5 cm)

- 199-133 both ends cvd 1.5 mm x 1.2 mm micro tip



199-133

Double-ended / 6" (15 cm)

- 199-132 one end angled, one end str 2.0 mm x 3.2 mm
- 199-129 both ends angled 2.0 mm x 3.5 mm
- 199-131 both ends str 2.0 mm x 3.5 mm



199-129



199-131



199-132

Double-ended / 7" (18 cm)

- 199-130 both ends angled 1.5 mm x 3.0 mm

Double-ended / 9" (22.8 cm)

- 199-136 both ends straight 2.0 mm x 3.5 mm



199-130



199-136

Davis Brain Spatula

Malleable / 7" (18 cm)

- 412-770 1/4"
- 412-771 3/8"
- 412-772 1/2"
- 412-773 5/8"
- 412-774 3/4"
- 412-775 1"
- 412-776 1 1/4"
- 412-777 1 1/2"



412-770



412-771



412-772



412-773



412-774



412-775

Davis Brain Black Silicon Spatula

Silicone coated / malleable / 7" (18 cm)

- 412-766 small 6 mm & 10 mm
- 412-767 medium 9 mm & 15 mm
- 412-768 large 11 mm & 20 mm
- 412-769 x-large 14 mm & 25 mm



412-766



412-767



412-768



412-769

Corneal Trephine

	Handle	Blade
2.5 mm	12-2263	12-1195
3.0 mm	12-2264	12-1196
3.5 mm	12-2265	12-1197
4.0 mm	12-2266	12-1198
4.5 mm	12-2267	12-1199
5.0 mm	12-2268	12-1201
5.5 mm	12-2269	12-1202
6.0 mm	12-2270	12-1200
6.5 mm	12-2271	12-1205
7.5 mm	12-2273	12-1225
8.5 mm	12-2277	12-1245
9.0 mm	12-2279	12-1255
9.5 mm	12-2280	12-1260
10.0 mm	12-2281	12-1261
10.5 mm	12-2282	12-1262
11.0 mm	12-2283	12-1263



9.0 Trephine



* Please contact Sontec for additional trephine sizes and styles

Pre-Chopper

Round handle / with cross action / 45° angle tip / titanium

T14-7766



Universal Pre-Chopper

Round handle / straight

T14-7768 titanium



Akahoshi Combo Pre-Chopper

Round handle / sabre tip

14-7770 straight
T14-7767 angled titanium
T14-7770 straight titanium



Phaco Chopper

60° angle cutting edge

12-1400 stainless steel
T12-1400 titanium



T12-1400

Verges Phaco Chopper

Ambidextrous / mirror polished distal tip

12-1407 stainless steel
T12-1407 titanium



Distal tip with converging bevels for chopping left, right or towards a paracentesis



T12-1407

Chang Combination Chopper / Micro Finger

For smaller eyes / vertical & horizontal chopping

12-1402 left stainless steel
12-1403 right stainless steel
T12-1402 left titanium
T12-1403 right titanium



T12-1403

T12-1402

Chang Combination Chopper / Micro Finger

Double-ended / titanium / angled/angled universal

T12-1455



T12-1455

Phaco Chopper Paddle Manipulator

Double-ended / titanium

T12-1457



T12-1457

Ball End Phaco Chopper

Titanium

T12-1410



T12-1410

Claw Chopper

Single-ended

12-1415 stainless steel
T12-1415 titanium



12-1415

Haefliger Phaco Chopper

Titanium

T12-1420



T12-1420

Chang Micro Finger Hook

Titanium

T12-1425



T12-1425

Nagahara Chopper

Single-ended

12-1430 stainless steel
12-1430L stainless steel
T12-1440 titanium



T12-1430

Spherical Chopper

Single-ended

T12-1440



T12-1440

Lasik Spatula

Single-ended / 0.5 mm wide / semi-sharp tip / titanium

T12-1442



T12-1442

Micro Finger & Spatula

Double-ended / titanium

T12-1480 right hand
T12-1482 left hand



T12-1480



Culler Iris Spatula

Sterling silver blade /curved

12-2400 1 mm wide
12-2410 2 mm wide



12-2400



12-2410

Wheeler Iris Spatula

Double-ended / lightly curved

12-2420



12-2420

Green Iris Spatula

Slightly curved ends / 4 mm x 14 mm and 5 mm x 16 mm / 6" (15 cm)

12-2422



12-2422

Kimura Platinum Spatula

Flat blade

12-3800



12-3800

Lasik Flap Spatula

2mm / single ended/ 11.8 cm

12-2860
T12-2860 titanium



12-2860



T12-2860

Barraquer Iris Spatula

Round, smooth curved blade

12-2600 stainless 0.5 mm diameter
12-2610 stainless 0.25 mm diameter
T12-2600 titanium 0.5 mm diameter

Round, smooth curved blade / hexagonal handle

12-2620 stainless 0.5 mm diameter



12-2600

Lippman Sideport Nucleus Rotator

Blunt, forked tip / angled tip / curved 0.5 mm blade / stainless / 10 mm

12-2730



12-2730

Koch Nucleus Spatula

Smooth / 0.8 mm wide

12-2740 stainless
T12-2740 titanium



12-2740



T12-2740

Girard Synechia Spatula

Semi-sharp tip / 0.5 mm wide

12-2800



12-2800

Guimaraes Lasik Spatula

11.4 cm

12-2832



12-2832

Madox Lasik Spatula

Double ended / 11.8 cm

12-2835



12-2835

Jaffe Lens Spatula

Flat blade / 0.5 mm wide

12-2900



12-2900

Elschnig Cyclodialysis Spatula

Flat blade / 1 mm wide

12-3300



12-3300

Castroviejo Synechia Spatula

Double-ended / semi-sharp tips / 0.5 mm wide

12-3450



12-3450

Castroviejo Cyclodialysis Spatula

Double-ended / blunt tips / stainless

12-3500 0.25 mm wide

12-3510 0.5 mm wide



12-3500

Fukasaka Spatula

Flat posterior / round anterior

12-2930



12-2930

O'Gawa Lens Dialer

Single-ended / curved tip

12-1421 stainless
T12-1421 titanium



T12-1421

Intracapsular Manipulating Wand

Straight

12-1405 stainless
T12-1405 titanium



12-1406

45° angled

12-1406 stainless
T12-1406 titanium

Cornell Lasik Sweep

Single-ended / 0.5 mm wide / semi-sharp tip / titanium

T12-1445



T12-1445

Rothchild Lasik Sweep and Hook

Double-ended / titanium

T12-1460



T12-1460

Bechert Lens Nucleus Rotator

Blunt, forked tip / angled tip

12-2701	stainless	14 mm	
12-2710	stainless	10 mm	
12-2711	stainless	14 mm	formed
T12-2701	titanium	14 mm	
T12-2710	titanium	10 mm	
T12-2711	titanium	14 mm	formed



T12-2710



T12-2711

Lester Lens Pusher

For pushing P/C lens loop / fits into hole of P/C lens / 0.25 mm diameter

12-2980	straight	stainless steel
12-2990	angled	stainless steel
T12-2980	straight	titanium
T12-2990	angled	titanium



T12-2990

Trident Splitter

T12-1475 straight



T12-1475

Lewis Lens Loop

Single-ended
 12-4300 small 5 1/4"
 12-4310 large 5 1/2"



New Orleans Lens Loop

Single-ended / 5 1/4"
 12-4330



Wilder Lens Loop

Serrated / 5 1/4"
 12-4400 straight stainless
 12-4402 curved stainless
 T12-4400 straight titanium



Kirby Lens Loop

Single-ended / 4 1/4"
 12-4440 standard
 12-4450 double-curve



Kirby Hook & Loop

Double-ended / 5 3/4"
 12-4460



Morrison Lens Loop & Probe

23 gauge / 5 5/8"
 12-4480



Billeau Ear Loop/Curette

6 1/2" (16.5 cm)

467-440XS extra small
 467-440 small
 467-438 medium
 467-436 large

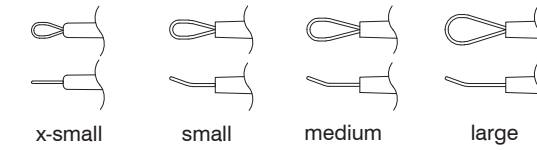

Paton Spatula & Spoon

Double-ended / for corneal button transfer / 5 1/2"
 12-4550



Bunge Evisceration Spoon

Straight head
 12-4601 6.0 mm
 12-4602 7.0 mm
 12-4600 8.0 mm
 12-4604 10.0 mm
 12-4608 11.0 mm
 12-4610 12.0 mm

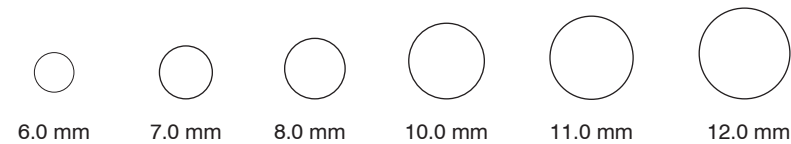

Wells Enucleation Spoon

Angled head
 12-4750



Jaffe Iris Hook

Blunt
12-5440

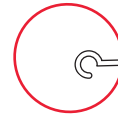

15-5440

Tyrell Iris Hook

Sharp
12-5130 large
12-5150 small

Blunt
12-5140 large
12-5160 small

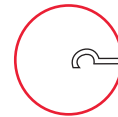

12-5140

Fixation Hook

Sharp / 2 prongs
12-6300 small
12-6310 large



12-6300

Scleral Fixation Twist Hook

2 crossed prongs
12-6400 right
12-6410 left

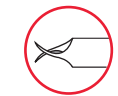

12-6400

Rainin Micro Iris Hook

Blunt
12-5450



12-5450

Rentsch Boat Hook

May be used as an iris/capsule retractor and lens manipulator / straight with guard

12-5826
T12-5826 titanium



12-5826



T12-5826

Osher "Y" Lens Manipulator

Straight
12-2720 stainless
T12-2720 titanium

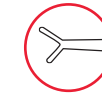

12-2720

Bonn Micro Iris Hook

Blunt
12-5350 stainless
T12-5350 titanium



12-5350

Jaffe-Knolle Iris Hook

Very blunt / angled
12-5390
T12-5390 titanium



12-5390

Knolle Iris Hook

Very blunt / straight
12-5400



12-5400

Shepard Iris Hook

Blunt
12-5410 stainless
T12-5410 titanium



12-5410

Graether Micro Iris Retractor

With collar button
12-5200 straight
12-5210 angled



12-5210

Titanium / with collar button
T12-5210 angled



T12-5210

Sinskey Lens Manipulating Hook

For P/C IOL holes / 0.25 mm blunt tip / 0.3 mm to 0.4 mm diameter

12-5492 straight



12-5492

Sinskey II Lens Manipulating Hook

Blunt tip / for P/C IOL holes, 0.25 mm to 0.4 mm diameter / 0.2 mm diameter

12-5520 straight stainless
12-5530 angled stainless
T12-5520 straight titanium
T12-5530 angled titanium



12-5530

Lewicky Lens Manipulator Hook

Blunt / angle / 0.15 mm Ø tip / 0.2/0.3 Ø holes

12-5550



12-5550

Kuglen Iris Hook & Lens Manipulator

Push-pull model

12-5800 stainless straight
12-5810 stainless angled
T12-5800 titanium straight
T12-5810 titanium angled



T12-5810

Clover leaf shape

12-5820 stainless straight
12-5822 stainless angled
T12-5820 titanium straight
T12-5822 titanium angled



12-5820

Fenzl Lens Manipulating Hook

Very blunt / for IOLs having a hole in the center or distal end of its loop / 0.15 mm diameter

12-5830 straight
12-5831 angled
T12-5830 titanium straight
T12-5831 titanium angled



12-5831



T12-5830



T12-5831

Culler Neuro Hook

Classic flat handle / 7 mm hook / 4 3/4" (12 cm)

412-445



412-445

Graefe Muscle Hook

12-7010 size 1
12-7020 size 2
12-7030 size 3
T12-7030 size 3 titanium

Round knurled handle / 6"

12-7025 size 2



12-7010



12-7020



12-7030



T12-7030



12-7025

Jameson Muscle

12-7100 small
12-7110 large
T12-7110 large titanium



12-7100



12-7110



T12-7110

Stevens Tenotomy Muscle Hook

Smooth & blunt tip / 5"
12-6900
T12-6900



12-6900



T12-6900

Helveston Finder Hook

Titanium / extra delicate / slightly angled / 5"
T12-6920 large
T12-6925 small



T12-6925



T12-6920

Extra delicate / slightly angled / 5"
12-6920 large
12-6925 small



12-6920



12-6925

Helveston Teaser Hook

Extra delicate / 5"
12-6930



12-6930

Culler Muscle Hook

4 3/4" (12 cm)
412-445A round handle delicate
412-445 flat handle



412-445A



412-445

Kirby Muscle Hook

12-7120



12-7120

Gass Retinal Detachment Hook

Flat with hole / cherry eye / 5 3/4" (14.6 cm)
12-6910



12-6910

Manson Triple Muscle Hook

Double-ended / 6" (15 cm)
12-7130 stainless
T12-7130 titanium



12-7130

Titanium Double Muscle Hook

6 3/4" (17 cm)
T12-7060



T12-7060

Helveston Muscle Hook

Extra delicate / 12mm tip / used in
Laparoscopic approach
12-6935



12-6935

Extra delicate / titanium
T12-6930 8 mm
T12-6933 10 mm
T12-6935 12 mm



12-6935



12-6935

Thornton Corneal Marker

Titanium handle / single-end

- T12-9100-2 2 blades
- T12-9100 4 blades
- T12-9101 6 blades
- T12-9102 8 blades
- T12-9103 10 blades
- T12-9104 12 blades
- T12-9105 16 blades

Titanium handle / double-end

- T12-9106 8/6 blades



T12-9100-2



T12-9100



T12-9101



T12-9106

Lindstrom Arcuate Incision Marker

7mm optical zone

12-8500



12-8500

Thornton Globe Fixation Ring Titanium

Titanium / with multiple teeth / 16 mm diameter / swivel handle / round handle

T12-6467



T12-6467

Braun Fixed Caliper

8 cm / special sizes made to order

12-9340



12-9340

Castroviejo Caliper

Scale to 20 mm / 3 1/2" (9 cm)

12-9200	straight	original with wider shanks
12-9300	straight	
T12-9300	straight	titanium
12-9300D	straight	deluxe
12-9305	angled 45°	
12-9310	curved	
12-9310D	curved	deluxe
12-9315	angled	
12-9316	straight	40 mm scale
12-9318	angled	40 mm scale

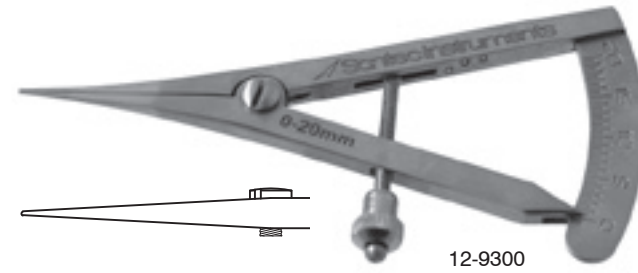

12-9300

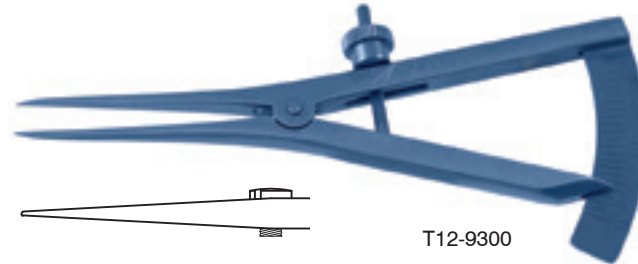

T12-9300



12-9200



12-9300D



12-9305



12-9310D

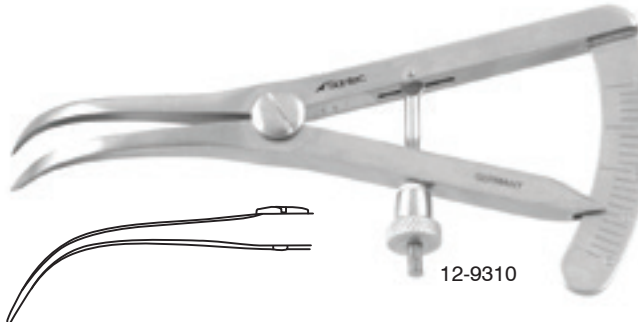

12-9310



12-9316

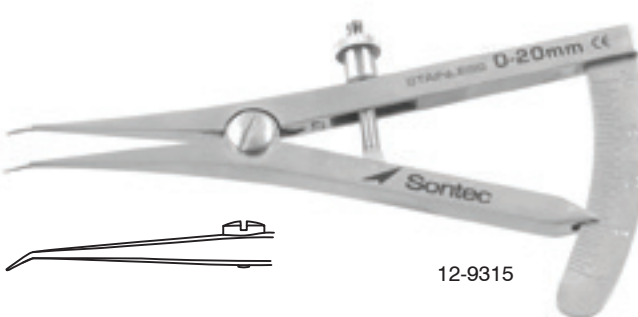

12-9315

Jameson Caliper

Scale to 3" (8 cm)

12-9450



12-9450

Thorpe Caliper

Scale to 3" (8 cm) /
angled / markings in
0.5 mm increments

12-9400



12-9400

Flexible Stainless Ruler

6" (15 cm) / graduated in 1/32"
fractions and millimeters

12-9500

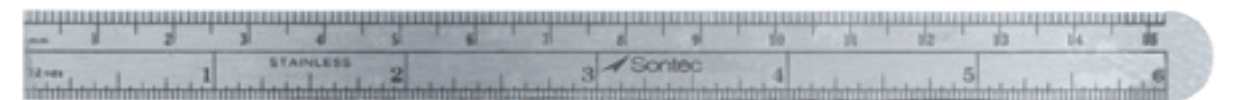

12-9500

Stahl A/C Lens Gauge

For verifying diameter of A/C lenses in 1.5 mm increments / Teflon coated stainless steel

12-9630

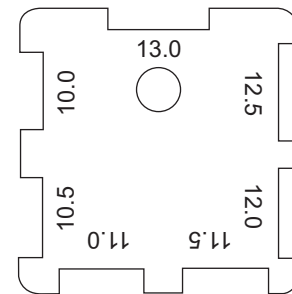

12-9600

Stahl Caliper

A/C caliper for measuring corneal diameter prior to A/C IOL / size markings on both sides

12-9600



12-9630

Serrefine Bulldog Clamp

1 1/2" (4 cm) / cross-action

14-9935 straight
14-9940 curved



14-9935

2 1/2" (6.4 cm) / cross-action

115-585 straight
115-586 curved



115-585

John Hopkins Bulldog Clamp

Straight / cross-action

440-352 1 1/2"
440-354 2"
440-356 2 1/4"
440-358 2 1/2"
440-360 2 3/4"
440-362 3"
440-364 3 1/2"



440-352



440-354

Curved / cross-action

440-370 1 1/2"
440-372 2"
440-374 2 1/4"
440-376 2 1/2"
440-378 2 3/4"
440-380 3"
440-382 3 1/2"

Dietrich Bulldog Clamp Titanium

Serrated tip / cross-action / straight

2600-836 2 x 11 mm jaw 5.5 cm
2600-8365 2 x 15 mm jaw 6.1 cm
2600-837 2 x 20 mm jaw 6.9 cm

Serrated tip / cross-action / angled

2600-839 2 x 11 mm jaw 5.5 cm
2600-8395 2 x 15 mm jaw 5.7 cm
2600-840 2 x 20 mm jaw 6.5 cm

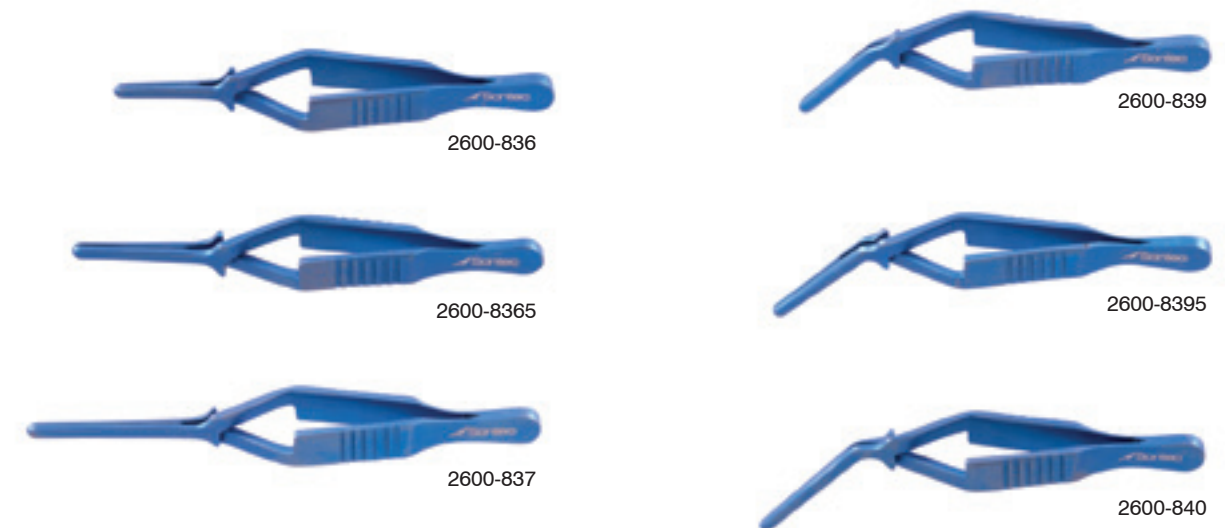

2600-836

2600-839

2600-8365

2600-8395

2600-837

2600-840

DeBakey-Dietrich Bulldog Clamp Titanium

Atraumatic tip / cross-action / straight

2600-844 2 x 11 mm jaw 5.5 cm
2600-845 2 x 15 mm jaw 6.1 cm
2600-846 2 x 20 mm jaw 6.9 cm

Atraumatic tip / cross-action / angled

2600-847 2 x 11 mm jaw 5.5 cm
2600-848 2 x 15 mm jaw 5.7 cm
2600-849 2 x 20 mm jaw 6.5 cm

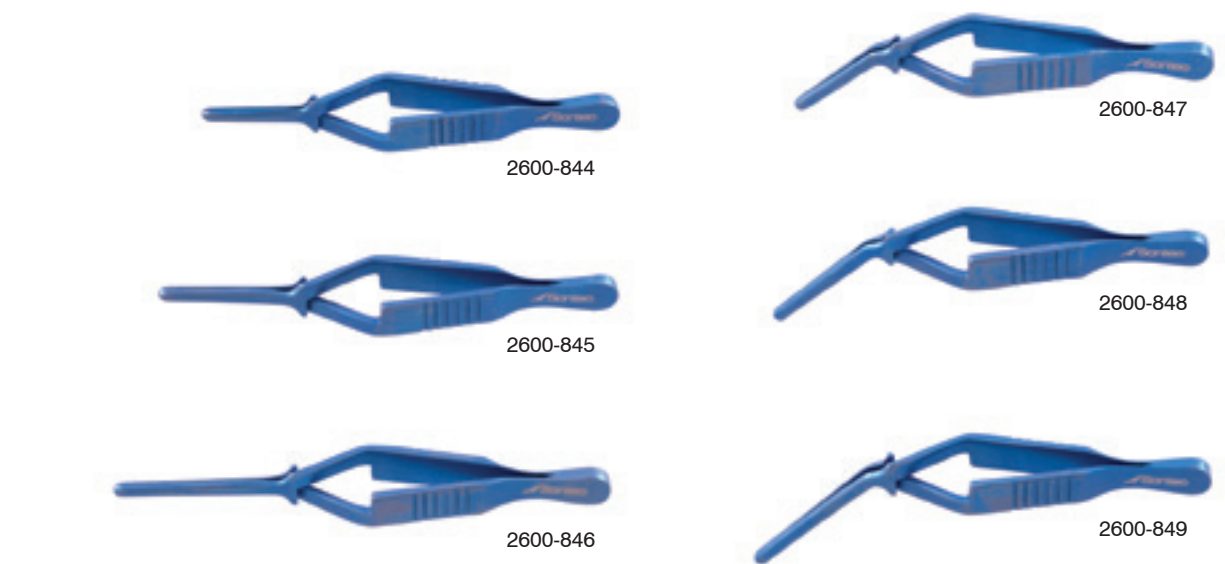

2600-844

2600-847

2600-845

2600-848

2600-846

2600-849

Micro Friedman Rongeur

1.5 mm x 5 mm jaw / 5 1/2" (14 cm)

- 315-505S str
- 315-505C 30° angle
- 315-505 90° angle

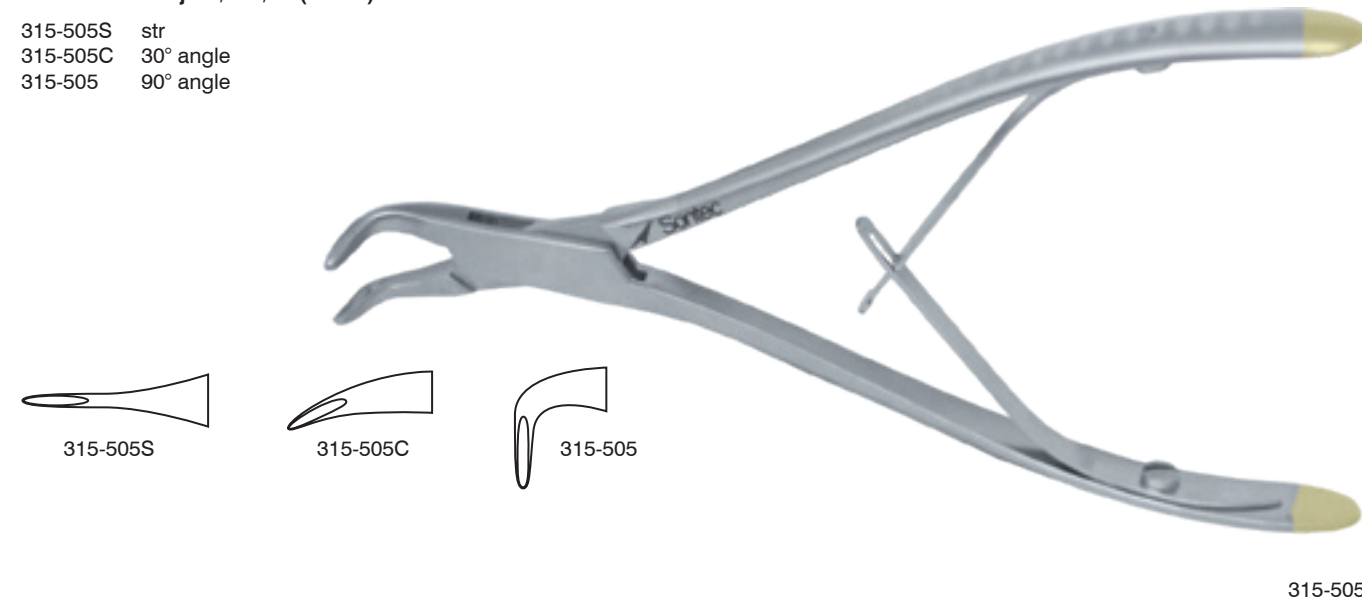

Cicherelli Rongeur

3 mm x 12 mm jaw / full curve / 6 1/2" (16.5 cm)

315-559



Shearer Chickenbill Rongeur

Curved / 3 mm x 12 mm jaw

- 315-511 5 1/2" (14 cm)
- 315-513 6 1/2" (16.5 cm)
- 315-515 7" (18 cm)



Kleinert-Kutz Rongeur

2 mm x 6 mm jaw / 5 1/4" (13 cm)

- 315-581 slight curve
- 315-580 full curve



Sontec Micro Alligator Forceps

Delicate / lacrimal ducts / 4 mm x 0.9 mm jaw /
3 1/4" (8 cm) shaft

- | | | |
|---------|--------------|--------------|
| 469-040 | straight | with lock |
| 469-050 | angled right | with lock |
| 469-048 | angled left | with lock |
| 469-036 | straight | without lock |



Sontec Dynamic Punch Rongeur

Cuts a full 360° without rotating the instrument /
7" (18 cm) shaft / 2 mm jaw / 30° curved tip

404-3902

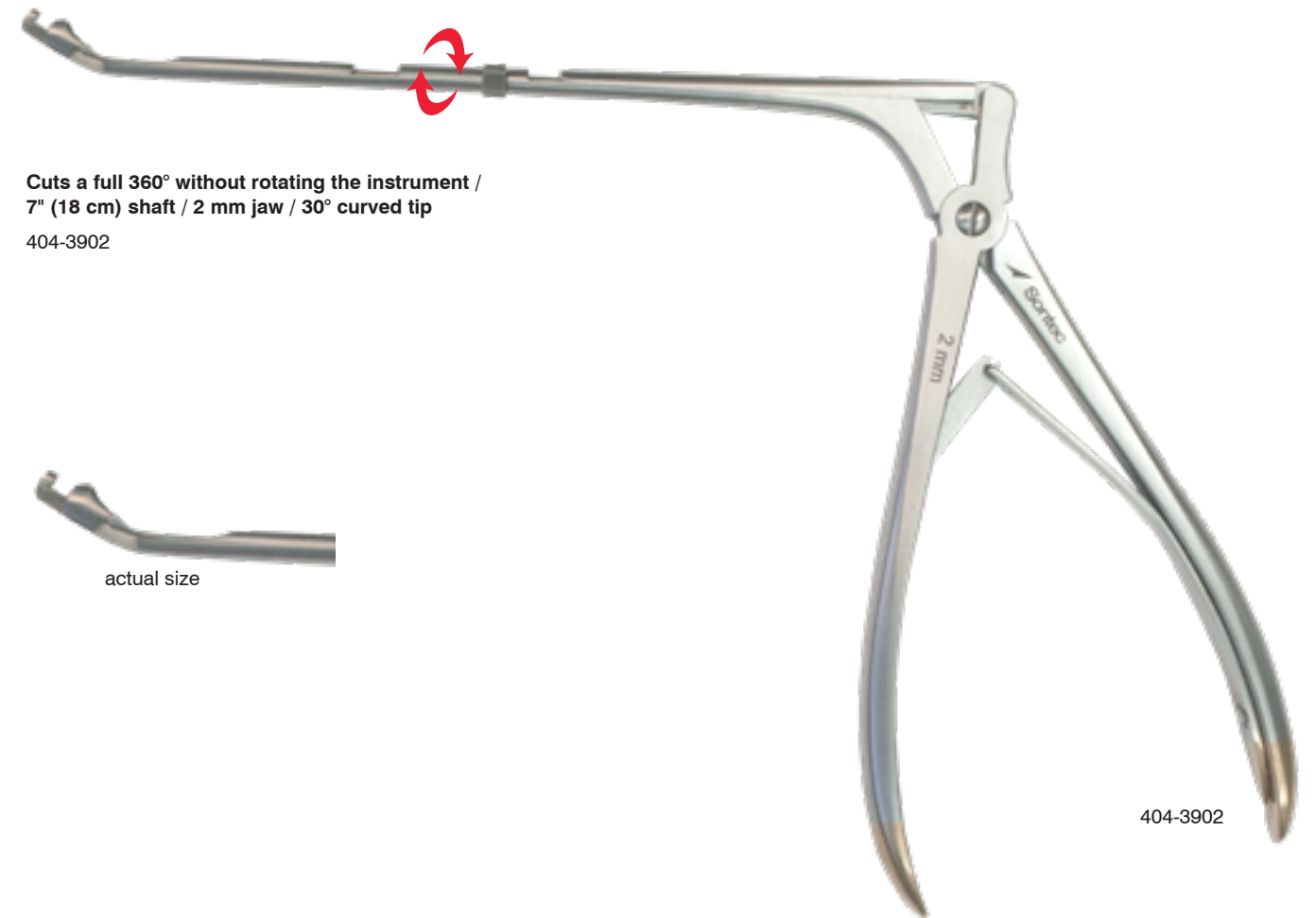

Bowman Lacrimal Probe

Sterling silver / butterfly handle

- 16-2520 set of six probes
- 16-2530 size 0000/000
- 16-2540 size 00/0
- 16-2541 size 0/1
- 16-2550 size 1/2
- 16-2551 size 2/3
- 16-2560 size 3/4
- 16-2561 size 4/5
- 16-2570 size 5/6
- 16-2571 size 6/7
- 16-2580 size 7/8

Stainless steel / butterfly handle

- 16-2530S size 0000/000
- 16-2540S size 00/0
- 16-2550S size 1/2
- 16-2560S size 3/4
- 16-2570S size 5/6



Bowman Lacrimal Probe

Stainless steel / round handle

- 16-2578 set of six probes
- 16-2579 size 0000/000
- 16-2581 size 00/0
- 16-2582 size 0/1
- 16-2583 size 1/2
- 16-2584 size 2/3
- 16-2585 size 3/4
- 16-2586 size 4/5
- 16-2587 size 5/6
- 16-2588 size 6/7
- 16-2589 size 7/8



Pigtail Lacrimal Probe Dilator

- 15 mm tip w/holes
- 16-2600



Muldoon Lacrimal Dilator

- Single-ended / graduated blunt tip
- 16-2500



Castroviejo Lacrimal Dilator

- Double-ended
- 16-2510



Wilder Lacrimal Dilator

- Single-ended
- 16-2460 fine, #1
- 16-2470 medium, #2
- 16-2480 heavy, #3



Schiotz Tonometer

Autoclavable / original model

18-8301 incline scale

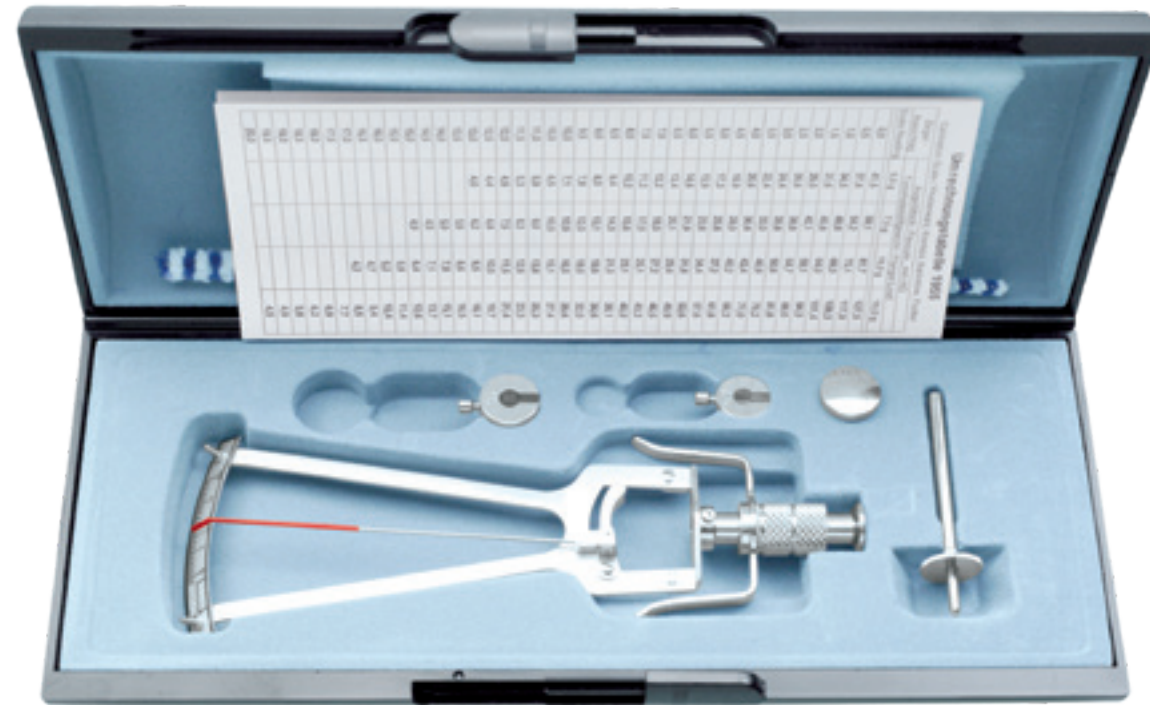

Optivisor Binocular Magnifier

Adjustable, genuine leather headband / tilts, moves out of the way when not needed / includes #5 lens plate, magnifies 2.5 times at an 8" distance

- 1103-400 2.5x
- 1103-4001 2.7x
- 1103-401 3.5x

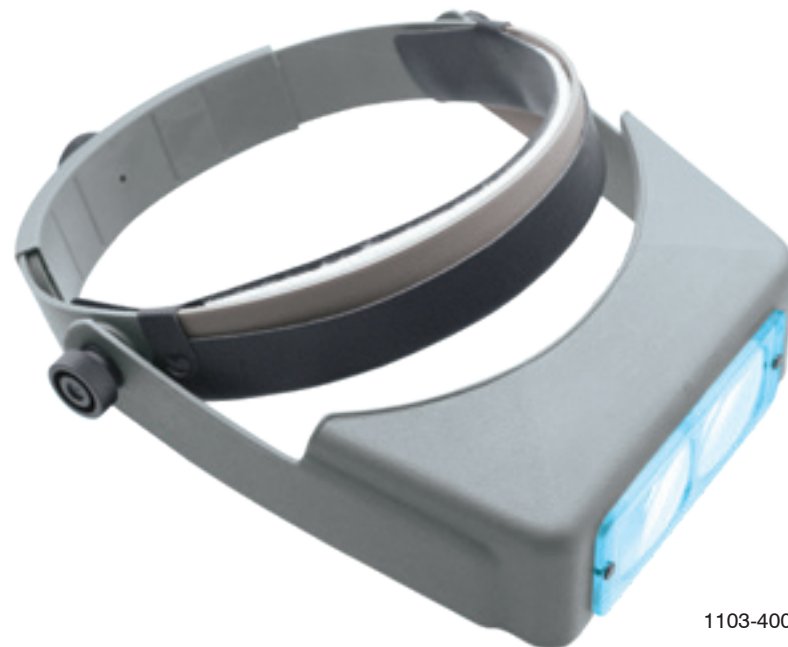

1103-400

Easy Change Phaco I/A Cannula System Stainless Steel

Irrigation/ Aspiration with a 0.3 mm or 0.5mm port / available with interchangeable tips

- 16-3100 Handle
- 16-3101A 0.3 mm tip straight
- 16-3101B 0.5 mm tip straight
- 16-3102A 0.3 mm tip curved
- 16-3102B 0.5 mm tip curved
- 16-3103A 0.3 mm tip 45° angle
- 16-3103B 0.5 mm tip 45° angle
- 16-3103C 0.3 mm tip 90° angle
- 16-3103D 0.5 mm tip 90° angle
- 16-3104 0.3 mm tip 150° angle
- 16-3107B 0.5 mm tip 150° angle
- 16-3111 Replacement O-ring



binkhorst
binkhorst
5 sets per bag

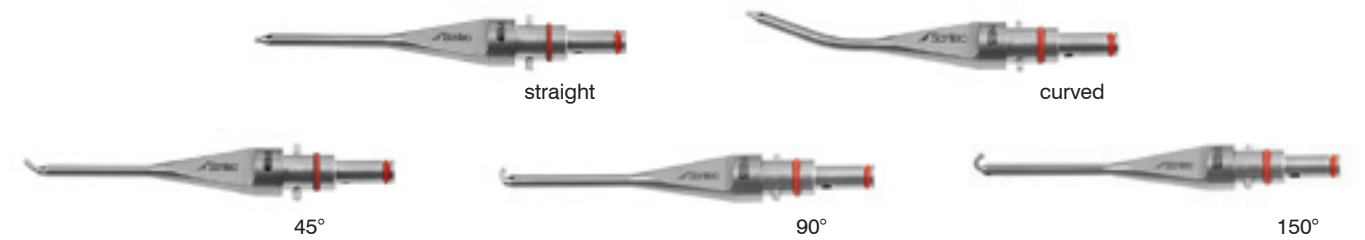

Easy Change Phaco I/A Cannula System Titanium

Irrigation/ Aspiration with a 0.3 mm or 0.5mm port / available with interchangeable tips

- T16-3100 Handle
- T16-3101A 0.3 mm tip straight
- T16-3101B 0.5 mm tip straight
- T16-3102A 0.3 mm tip curved
- T16-3102B 0.5 mm tip curved
- T16-3103A 0.3 mm tip 45° angle
- T16-3103B 0.5 mm tip 45° angle
- T16-3103C 0.3 mm tip 90° angle
- T16-3103D 0.5 mm tip 90° angle
- T16-3104 0.3 mm tip 150° angle
- T16-3112 Replacement O-ring



5 sets per bag

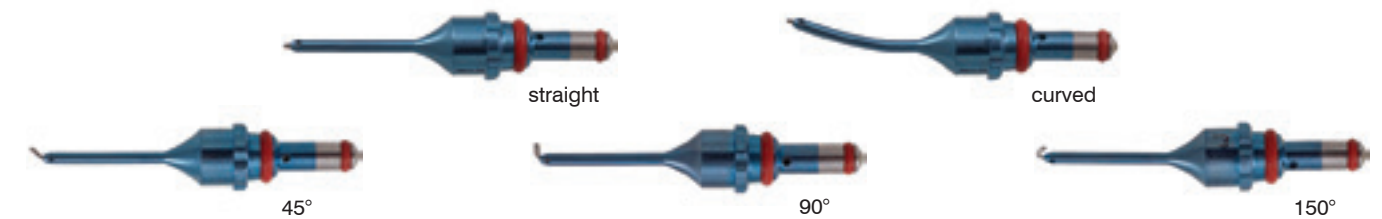

Noyes Iris Scissors

Flat handle / straight / 4 1/2" (11.5 cm)

- 13-3420 sharp-sharp
- 13-3425 sharp-blunt
- 13-3430 blunt-blunt



Flat handle / curved / sharp-sharp tips / 4 1/2" (11.5 cm)

- 13-3435



13-3435

Castroviejo Corneoscleral Scissors

Small 8 mm blades / 4" (10.2 cm)

- 13-1300 right
- 13-1310 left

Small / medium 10 mm blades / 4" (10.2 cm)

- 13-1306 right
- 13-1307 left

Medium 12.5 mm blades / 4" (10.2 cm)

- 13-1320 right
- T13-1320 right titanium
- 13-1330 left
- T13-1330 left titanium

Large blades / 4" (10.2 cm)

- 13-1340 right
- 13-1350 left

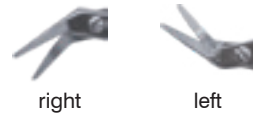

13-1306



13-1307



13-1320



13-1330

Castroviejo Corneoscleral Scissors

Fenestrated handle / small 8 mm blades / 4 1/4" (10.8 cm)

- 13-1300F right
- 13-1310F left

Medium 11 mm blades / 4 1/4" (10.8 cm)

- 13-1320F right
- 13-1330F left



13-1300F



13-1310F



13-1320F



13-1330F

Troutman-Castroviejo Corneoscleral Scissors

With lock / small blades / 4 1/4" (10.8 cm)

- 13-1500 right
- 13-1510 left

With lock / medium blades / 4 1/4" (10.8 cm)

- 13-1520 right
- 13-1530 left



With lock / medium blades / fenestrated handle / 4 1/4" (10.8 cm)

- 13-1520F right
- 13-1530F left



13-1500



13-1530F

Troutman-Katzin Corneal Transplant Scissors

Small blades 8.5 mm / strong curved / with lock / 4 1/4" (10.8 cm)

- 13-2300 right
- 13-2310 left



13-2300



13-2310

Katzin Corneal Transplant Scissors

Medium blades / strongly curved / 4 1/4" (10.8 cm)

- 13-2320 right
- 13-2330 left



13-2330

Castroviejo Corneal Scissors

Curved blunt tips / 4 1/4" (10.8 cm)

- 13-2500 small
- 13-2520 medium
- 13-2540 large



13-2500

Curved blunt tips / 4 1/4" (10.8 cm)

- 13-2500F small
- 13-2520F medium



13-2520F

Azar Corneal Scissors

Caliper blade / 11 mm blades / 4 1/4" (10.8 cm)

- 13-1840 curved blades
- 13-1842 full curved blades



13-1840

Castroviejo Keratoplasty Scissors

Angled to side / medium blades / 4" (10.2 cm)

- 13-3140 sharp
- 13-3150 blunt



13-3150

Castroviejo Keratoplasty & Keratectomy Wide Handle Scissors

Curved / wide serrated handles

- 13-3160 5 1/4" (13 cm)
- 13-3162 5 3/4" (14.5 cm)



13-3160



13-3162

McPherson-Westcott Conjunctival Scissors

Curved, blunt tips / small blades / 4" (10.2 cm)

- 13-3300
- 13-3300F fenestrated handle



13-3300



13-3300F

Westcott Tenotomy Scissors

Blunt / 4 1/2" (11.5 cm)

- 13-3400 curved
- 13-3401 straight

Blunt / standard blade / heavier / curved / 5" (12.7 cm)

- 13-3402 curved

Blunt / standard blade / streamlined / curved / 5" (12.7 cm)

- 13-3406 curved



13-3400



13-3401



13-3402



13-3406

Ceramitec Westcott Tenotomy Scissors

Curved blunt tips / medium blades / 5" (12.7 cm)

- 13-3304B



13-3304B

Westcott Stitch Scissors

Sharp tips / classic blades / 4 1/2" (11.5 cm)

- 13-4400 curved
- 13-4402 straight



13-4400



13-4402

Westcott Wide Handle Tenotomy Scissors

Wide handle / curved / classic blades / 5 1/2" (14 cm)

- 13-3307 sharp
- 13-3306 blunt
- 13-3307S blunt serrated blades



13-3306



13-3307

Westcott Wide Handle Conjunctival Scissors

Lightly curved / blunt tip / wide serrated handle / 5 1/2" (14 cm)

- 13-3301



13-3301

Westcott Tenotomy Scissors

Curved sharp tips / medium blades
/ 4 3/4" (12.1 cm)

13-3303 fenestrated handle



13-3303

Curved blunt tips / medium blades
/ 4 3/4" (12.1 cm)

13-3304 fenestrated handle



13-3304

Titanium Westcott Tenotomy Scissors

Blunt tip / fenestrated handle / 4 1/2" (11.5 cm)

T13-3417 curved

T13-3418 straight



T13-3417

McPherson-Westcott Stitch Scissors

Curved sharp tips / small blades / 4" (10.2 cm)

13-4300



13-4300

Jaffe-Westcott Scissors

Curved tips / medium blades / 4" (10.2 cm)

13-4450 sharp

13-4450B blunt

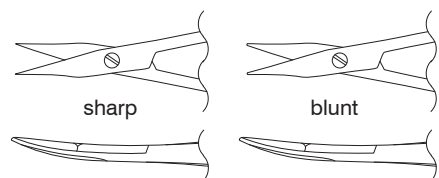

13-4450B

Jaffe-Stitch Scissors

Curved tips / medium blades / sharp tips
/ fenestrated handle / 4 1/4" (10.8 cm)

13-4450F



13-4450F

Iris Scissors

Sharp tips / small blades / 4" (10.2 cm)

13-4700 straight

13-4710 curved



13-4710

Iris Scissors

Sharp tips / small blades / curved / fenestrated handle
/ 4" (10.2 cm)

13-4710F



13-4710F

Iris Scissors

Sharp pointed tips / classic blades / 4" (10.2 cm)

13-4740 straight

13-4750 curved



13-4740

Vannas Capsulotomy Scissors

Sharp 6 mm blades

- 13-5300 straight
- 13-5310 curved

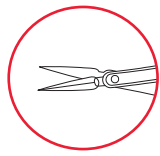

13-5300

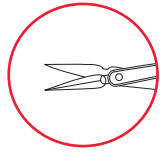

13-5310

Sharp tips / extra micro fine very delicate blades /

- 13-5312 straight
- 13-5314 curved



13-5312

Sharp tips/ angled up

- 13-5320 regular blades
- 13-5325 long blades



13-5325

Sharp tips/ angled to side

- 13-5330



13-5330

Vannas Scissors

Sharp tips / angled up

- 13-5520 flat handle
- 13-5520F fenestrated handle
- 13-5521 round handle



13-5520



13-5520F



13-5521

Sontec-Vannas Scissors

10 mm blade / fenestrated handle

- 13-5348F straight
- 13-5349F curved



13-5348F

13-5349F

McPherson-Vannas Iris Scissors

Sharp tips

- 13-5400 straight
- 13-5410 curved



13-5410

Gills-Vannas Scissors

Sharp tips / long thin 8 mm blades

- 13-5405 straight
- 13-5415 curved



13-5405

Sharp tips / long thin blades / fenestrated handle

- 13-5405F straight
- 13-5415F curved



13-5415F

Gills-Vannas Scissors

Angled forward / 3 1/2" (8.9 cm)

- 13-5370



13-5370

Round handle / angled forward / 11 mm blade / 3 1/2" (8.9 cm)

- 13-5375

Stern-Gill Capsulotomy Scissors

Extra-thin 10 mm long blades / angle forward / sharp tips

- 13-5422



13-5422

Barraquer Butterfly Iris Scissors

7 mm long blades / angled forward

- 13-5205 sharp
- 13-5200 blunt



13-5205

Vitreotomy Scissors

20 G

- 13-5600 straight
- 13-5605 30°
- 13-5610 60°
- 13-5615 90°



13-5600

Intraocular Scissors

Squeeze handle / with protective sleeve

- 13-5700 straight
- 13-5710 curved
- 13-5710B curved ceramic coated blade



13-5700



13-5710B

Squeeze handle / irrigation with protective sleeve

- 13-5701 straight
- 13-5711 curved

Additional protective sleeve available

- 13-5700SL



13-5711



13-5700SL

IOL Lens Cutter McKool Style Forceps

0.4 mm tip / 8.5 mm blade length / 1.0 mm jaw length / flat titanium handle / stainless steel blades / 4 1/2" (11.4 cm)

- 13-5390

7.7 mm blade length / flat titanium handle / stainless steel blades / 4" (10.2 cm)

- 13-5395

* For cutting soft IOLs



13-5390



13-5395

Stolte IOL Lens Cutter Titanium

To retain soft IOL during cutting, there is a slotted cover / stainless steel cutter / 5" (12.7 cm)

- 13-5398

* For cutting soft IOLs



13-5398

MICRO SERRATIONS ON ANY SCISSOR WITH REASONABLE SIZE, PLEASE INQUIRE

Stevens Tenotomy Ergonomic Spread Handle Power Cut Black® Scissors

Blunt / long tip / PC black / ergonomic spread handle / curved / 4 1/2" (11.5 cm)

1200-708

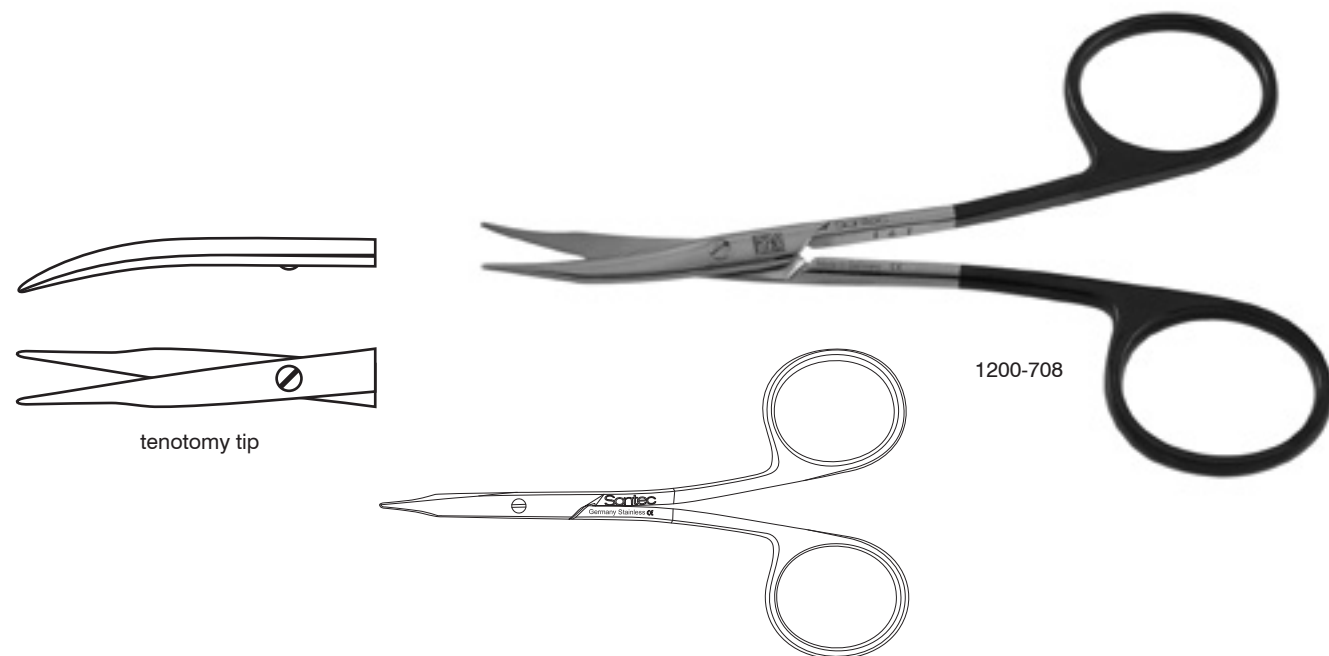

Ceramitec Stevens Tenotomy Ergonomic Spread Handle Power Cut Black® Scissors

Black with gold screw / blunt / long tip / PC Black / ergonomic spread handle / curved / 4 1/2" (11.5 cm)

1200-935



Stevens Tenotomy Ergonomic Spread Handle Tungsten Carbide Power Cut Black/Gold® Scissors

Blunt / long tip / tungsten carbide / PC black/gold / ergonomic spread handle / curved / 4 1/2" (11.5 cm)

1200-497

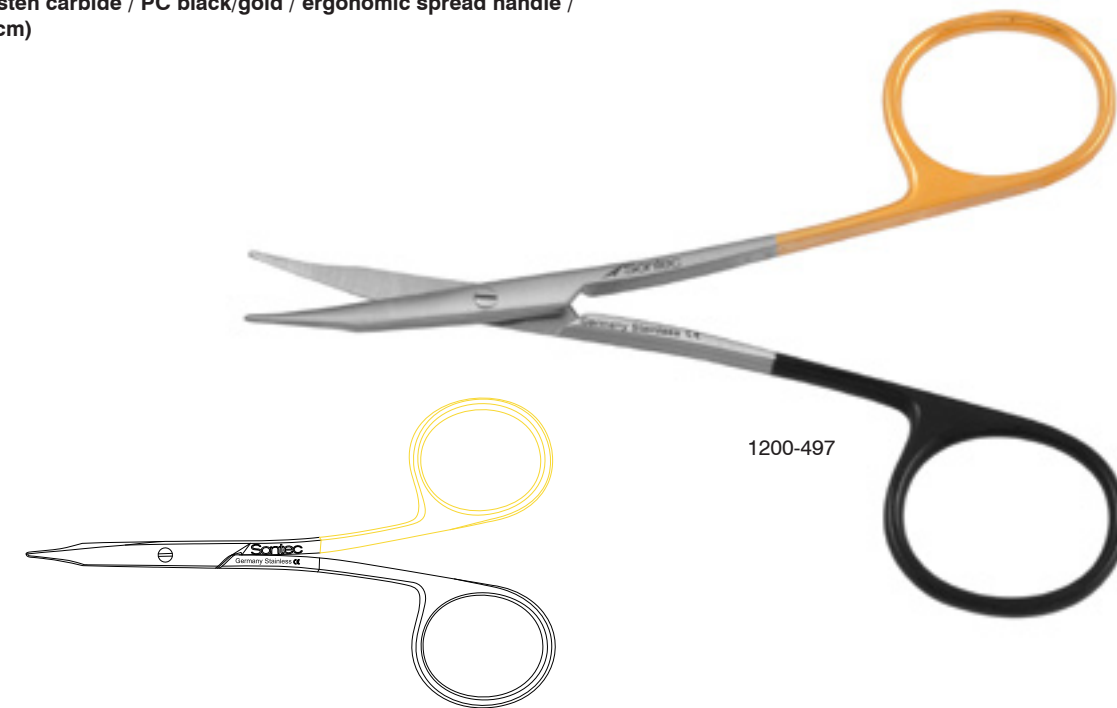

Stevens Tenotomy, Tungsten Carbide, Power Cut Gold, Power Cut Black®, Ceramic Coated Scissors

Blunt / long blades / with TC/PC curved blades / ceramitec / with gold screw and gold shiny rings / spread handle / 4 1/2" (11 cm)

1200-937



Stevens Siegert Tenotomy Scissors Double Beveled Blades

Saberback / black ceramitec coated
/ with gold screw / blunt long blades
/ curved / 4 1/2" (11.5 cm)

1200-985 black ceramitec
1200-986

Double beveled blades / TCPC / 4 1/2" (11.5 cm)

2400-365 straight
2400-367 curved pointed tips



1200-985



1200-986



2400-367

Stevens Tenotomy Classic, Tungsten Carbide, Power Cut Gold, Power Cut Black®, Ceramitec Coated Scissors

Blunt / ribbon handle / classic
/ 3 3/4" (9.5 cm)

13-8850 straight
13-8860 curved

Blunt / ribbon handle / PC gold / curved
/ 3 3/4" (9.5 cm)

13-8863 straight
13-8864 curved

Blunt / short tip / straight / 4 1/8" (10.5 cm)

13-8800 classic
1200-050 PC gold
1200-700 PC black

Blunt / short tip / curved / 4 1/8" (10.5 cm)

13-8810 classic
1200-052 PC gold
1200-702 PC black

Black / gold screw / PC / blunt / curved
/ 4 1/8" (10.5 cm)

1200-928

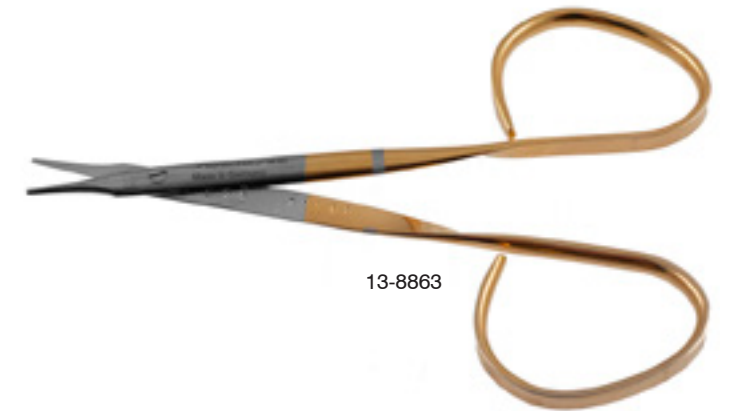

13-8863



1200-928



13-8810

Stevens Tenotomy Classic, Tungsten Carbide, Power Cut Gold, Power Cut Black®, Ceramitec Scissors

Blunt / long blades / straight / 4 1/2" (11.5 cm)

- 13-8813 classic
- 1200-062 PC gold
- 1200-704 PC black

Blunt / long blades / curved / 4 1/2" (11.5 cm)

- 13-8814 classic
- 1200-064 PC gold
- 1200-706 PC black
- 1200-499 TCPC



1200-064

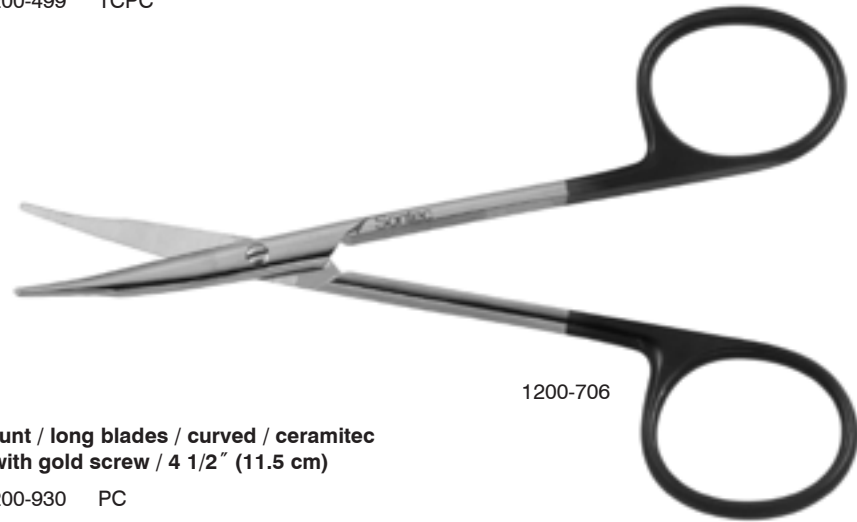

1200-706

Blunt / long blades / curved / ceramitec / with gold screw / 4 1/2" (11.5 cm)

- 1200-930 PC



1200-499

Pointed sharp blades / long blades / 4 1/2" (11.5 cm)

- 1200-490 TC/PC straight

Pointed sharp blades / long blades / curved / 4 1/2" (11.5 cm)

- 1200-491 TC/PC curved



1200-491

Stevens Tenotomy Classic, Tungsten Carbide, Power Cut Gold, Power Cut Black®, Ceramic Coated Scissors

Blunt / short blades / PC Black / 4 3/4" (12 cm)

- 1200-701 straight
- 1200-705 curved

Blunt / long blades / classic / 5" (13 cm)

- 2400-364 straight
- 2400-366 curved

Blunt / long blades / PC black / 5" (13 cm)

- 2400-865 straight
- 2400-867 curved



tenotomy tip

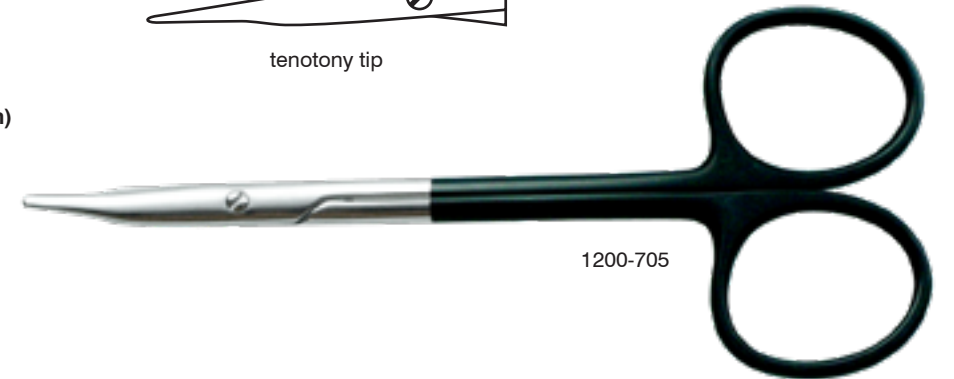

1200-705



2400-867

Stevens Tenotomy Classic PC Gold Scissors

Pointed sharp tips / short blades / classic / 4 1/8" (10.5 cm)

- 13-8805 straight
- 13-8815 curved

Pointed sharp tips / long blades / classic / 4 1/2" (11.5 cm)

- 13-8820 straight
- 13-8825 curved

Pointed sharp tips / long blades / PC Gold / 4 1/2" (11.5 cm)

- 13-8865 straight
- 13-8866 curved



13-8825

Bonn Scissors

Classic / 3 1/2" (9 cm)

- 13-7550 straight
- 13-7560 curved

PC / 3 3/4" (9.5 cm)

- 1200-008 straight
- 1200-009 curved

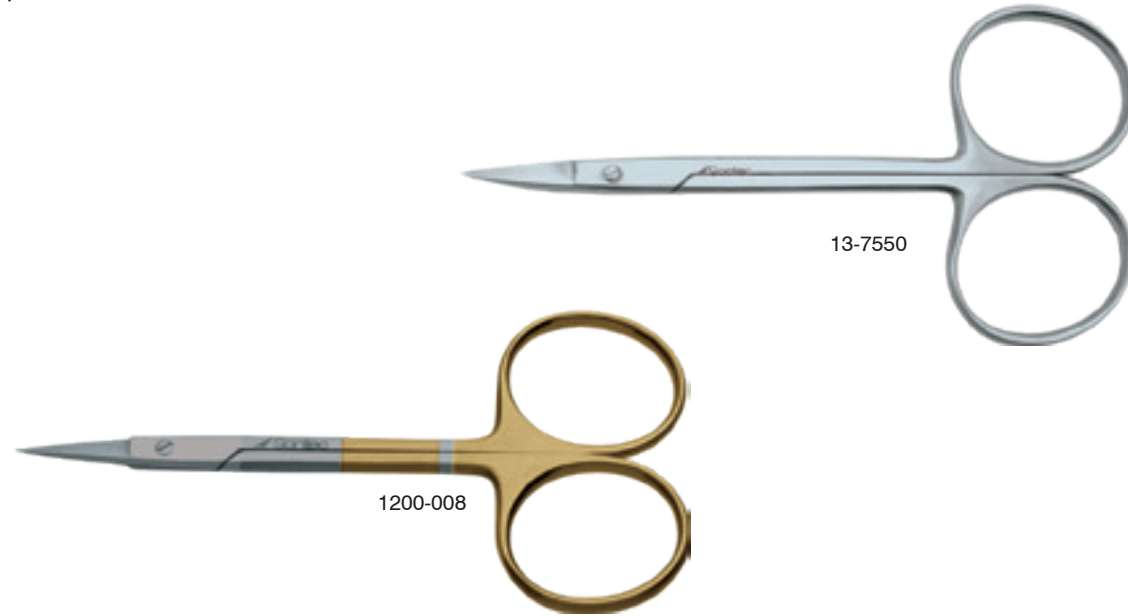

Utility Scissors

Ribbon handled / delicate flat blade / slight curve / 4" (10 cm)

- 13-9340 PC Gold
- 13-9341 PC Black

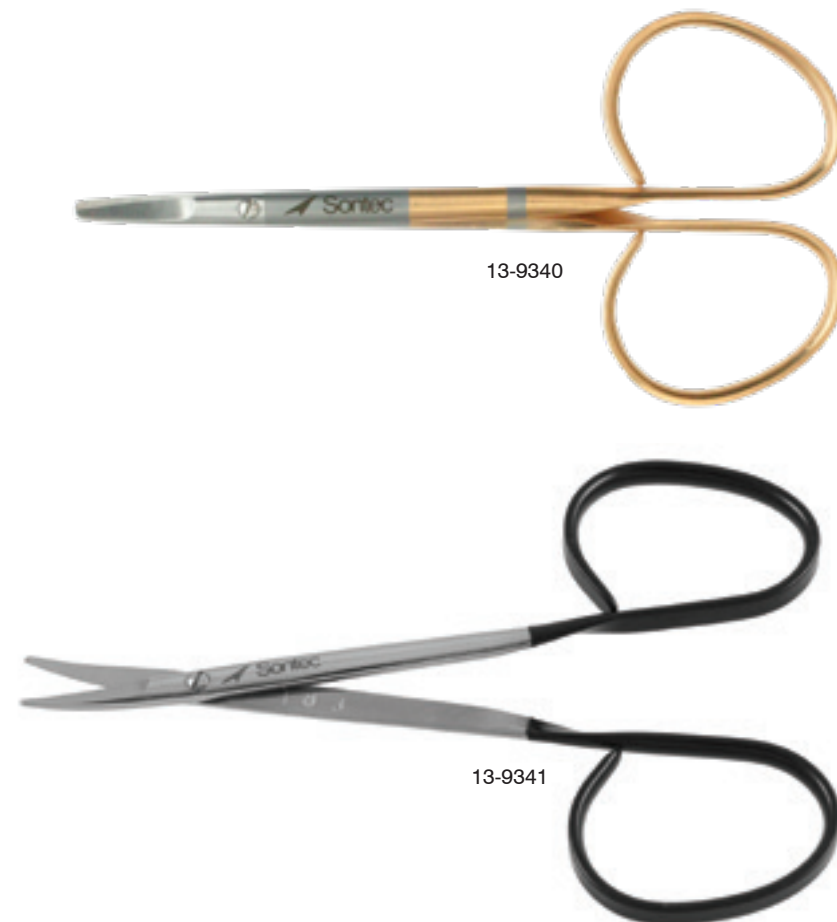

Gum Scissors

Sharp tips / 4 1/2" (11.5 cm)

- 475-151 straight
- 475-153 curved

Sharp tips / PC / 4 1/2" (11.5 cm)

- 1200-406 straight
- 1200-408 curved

Sharp tips / PC black / curved / 4 1/2" (11.5 cm)

- 1200-409



Strabismus Ribbon-Handle Scissors

Classic / 4 1/4" (11 cm)

- 13-9320 straight
- 13-9330 curved

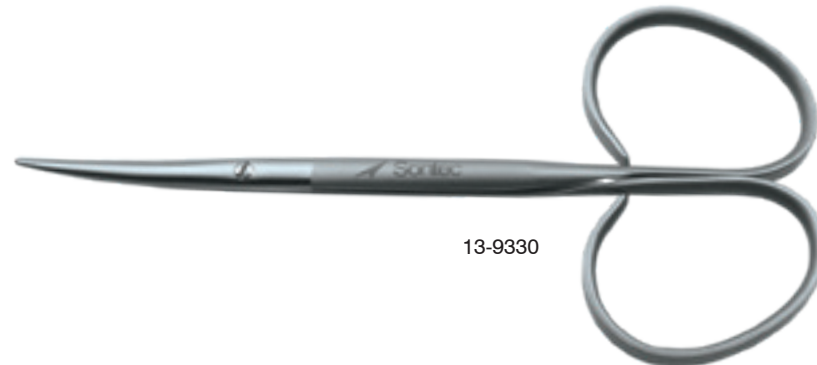

13-9330

Strabismus Baby Scissors

PC gold / 3 1/2" (9 cm)

- 1200-018 straight
- 1200-019 curved

PC black / 3 1/2" (9 cm)

- 1200-771 straight
- 1200-773 curved



1200-773

Strabismus PC Ceramitec Scissors

Black with gold screw / fine / curved / 4 1/2" (11cm)

- 1200-920 4 1/2" (11cm)
- 1200-922 5" (12.7 cm)



1200-920

Strabismus Classic Tungsten Carbide Power Cut Gold® Power Cut Black® Scissors

Delicate / PC gold / 4 1/4" (11 cm)

- 1200-021 straight
- 1200-023 curved

Classic / 4 1/2" (11.5 cm)

- 1100-344 straight
- 1100-346 curved

PC gold / 4 1/2" (11.5 cm)

- 1200-020 straight
- 1200-022 curved

PC black / 4 1/2" (11.5 cm)

- 1200-775 straight
- 1200-776 curved

PC black / sharp/sharp tips / curved / 4 1/2" (11.5 cm)

- 1200-776S

TC / 4 1/2" (11.5 cm)

- 2400-360 straight
- 2400-362 curved



1200-020



1200-776S

Iris Stille Classic Large Cut Out Rings Scissors

Curved / 4" (10.2 cm)

- 13-7786



13-7786

**Iris Classic Tungsten Carbide Power Cut Gold®
Power Cut Black® TC/PC Scissors**

Delicate / mini model / 3 1/2" (9 cm)

- 13-7500 straight
- 13-7510 curved

Ribbon handle / mini pattern / classic / 14 mm blades / 3 3/4" (9.5 cm)

- 13-7720 straight
- 13-7730 curved

PC gold / sharp tips / 4" (10 cm)

- 2400-010 straight
- 2400-012 curved

PC gold / blunt / 4" (10 cm)

- 2400-015 straight
- 2400-017 curved

PC black / sharp tips / 4" (10 cm)

- 2400-710 straight
- 2400-712 curved

Classic / 4 1/8" (10.2 cm)

- 13-7528 straight
- 13-7530 curved

Classic / delicate / 4 1/8" (10.2 cm)

- 13-7524 straight
- 13-7526 curved

PC gold / 4 1/8" (10.2 cm)

- 13-7532 straight
- 13-7533 curved

PC gold / delicate / 4 1/8" (10.2 cm)

- 13-7520 straight
- 13-7522 curved



Iris Scissors

Classic / 4 1/2" (11.5 cm)

- 13-7700 straight
- 13-7710 curved
- 13-7620 curved sideways
- 13-7715 angled sideways

PC gold / 4 1/2" (11.5 cm)

- 1200-025 angled sideways
- 1200-026 straight
- 1200-028 curved

PC black / sharp tips / 4 1/2" (11.4 cm)

- 2400-711 straight
- 2400-713 curved

PC black / blunt / 4" (10 cm)

- 2400-715 straight
- 2400-717 curved

TC / 4 1/2" (11.5 cm)

- 112-480 straight
- 112-478 curved

TC/PC / 4 1/2" (11.5 cm)

- 1200-502 straight
- 1200-503 curved

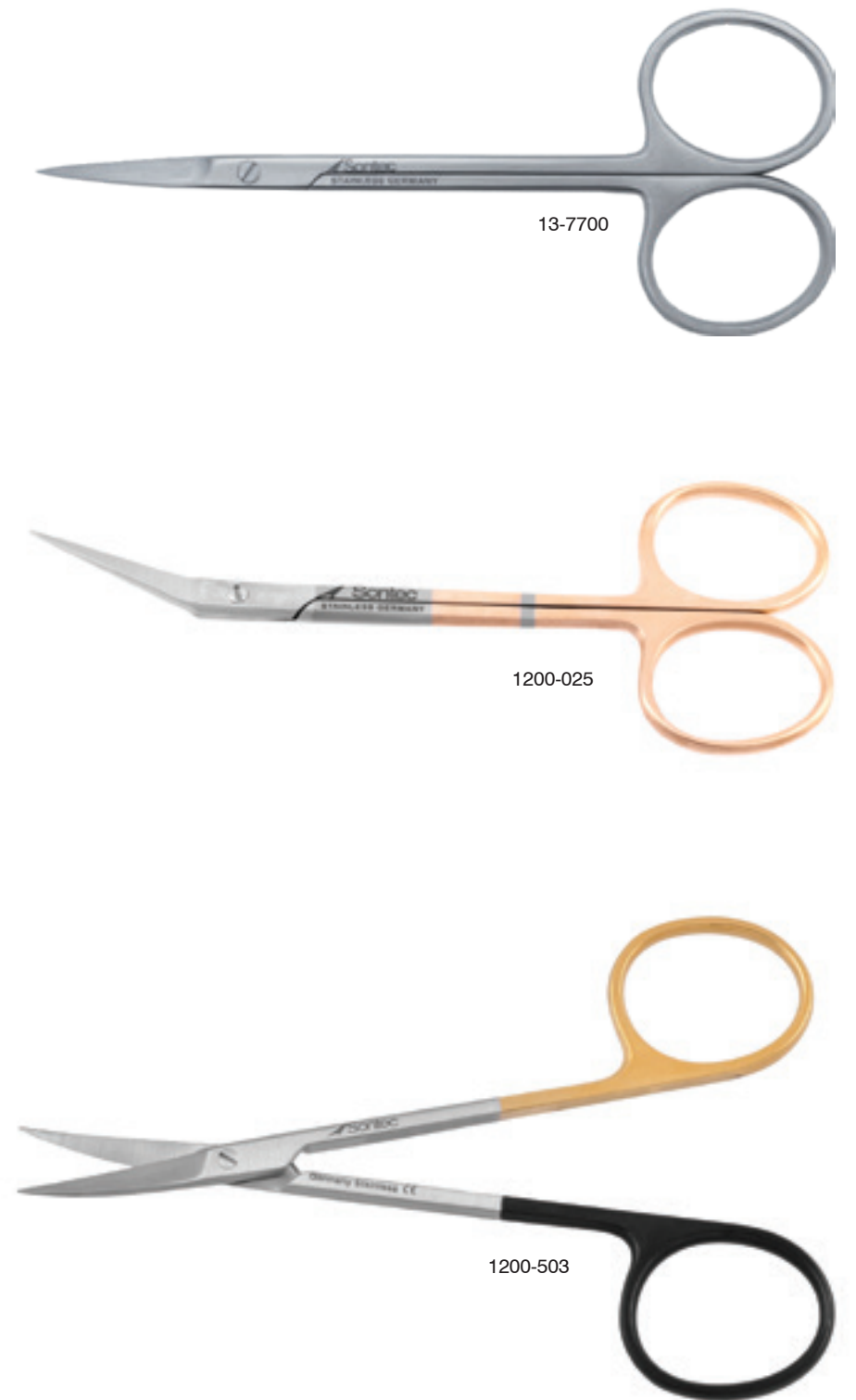

Iris Stille Classic Large Rings Scissors

Large ring / Classic / 4" (10 cm)

- 13-7740 straight
- 13-7750 curved

Large ring / PC black / 4" (10 cm)

- 1200-764 straight
- 1200-766 curved

Large ring / PC gold / 4" (10 cm)

- 1200-011 straight
- 1200-011C curved



1200-766



1200-764

Ceramitec Iris Scissors

Black with Gold Screw / TC PC / 4 1/2" (11.4 cm)

- 1200-950 straight
- 1200-952 curved



1200-950



1200-952

Sontec® Stitch Scissors

Ribbon handle / Needle point tip sharp tips / curved

- 199-517 4" (10 cm)
- 199-520 4 1/2" (11.5 cm)
- 199-522 5" (13 cm)

Classic rings / needle point tip / sharp / curved / 5" (12.7 cm)

- 199-524

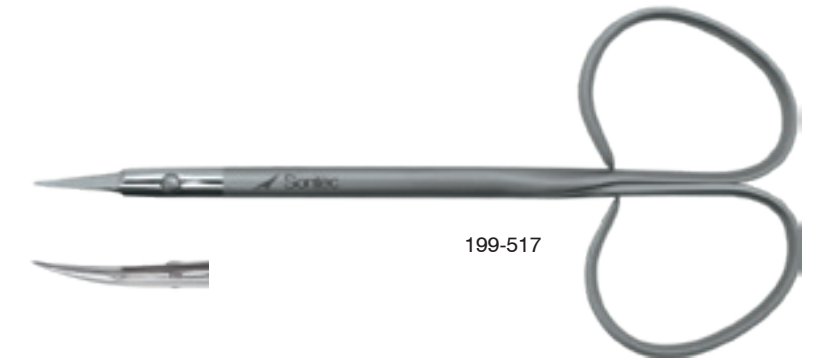

199-517



199-524

O'Brien Stitch Scissors

Side-angled / sharp tips / 3 3/4" (9.5 cm)

- 134-304 classic
- 134-305 PC gold



134-304

Gradle Scissors

Sharp tips / curved / 3 3/4" (9.5 cm)

- 199-510
- 199-535 PC Gold
- 199-545 PC Black

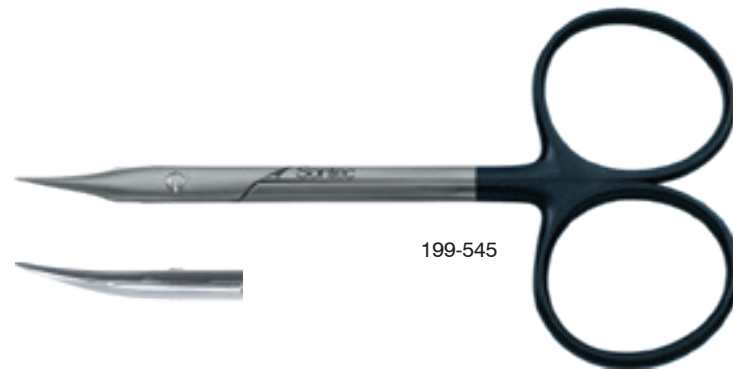

199-545

Ribbon handle / sharp tips / classic / curved / 4" (10 cm)

- 199-515

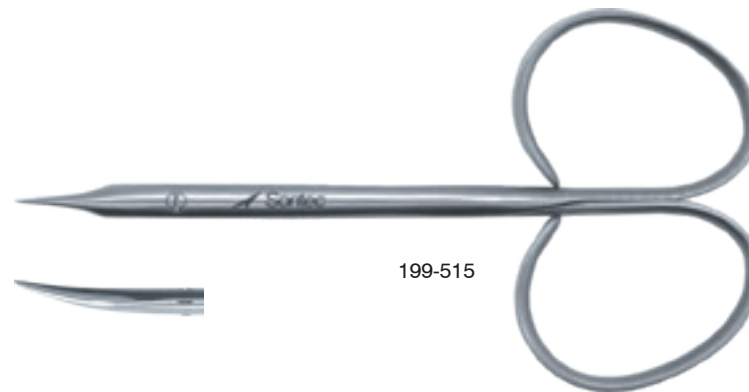

199-515

Ribbon-Handle Classic Iris Scissors

Classic blades / 4" (10 cm)

- 13-7600 straight
- 13-7610 curved

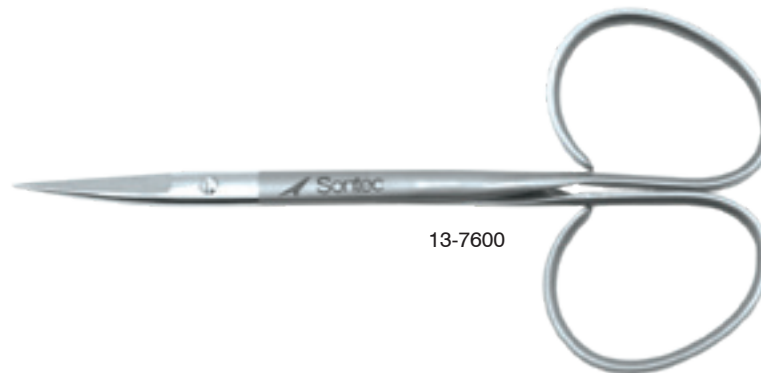

13-7600

Enucleation Scissors

PC Gold / 5 1/4" (13 cm)

- 13-9805 light curve
- 13-9810 medium curve
- 13-9820 full curve
- 13-9822 full curve PC Black



13-9820



13-9822



light curve



medium curve



full curve

Baby Stratte Scissors

PC Gold / full s-curved / 5 1/2" (14 cm)

- 508-616 metzenbaum tip
- 508-618 tenotomy tip

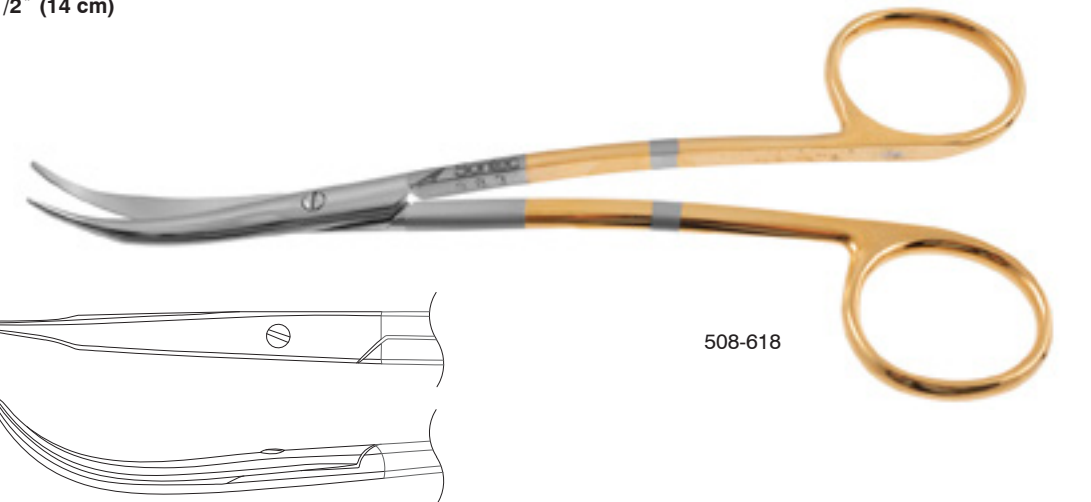

508-618

Walton Thorek Scissors

PC gold / beveled blades / full curved / 6 1/2" (16.5 cm)

508-624



Fomon Lateral Scissors

PC Gold / right-angled / beveled blades / 4 1/2" (11.5 cm)

508-622

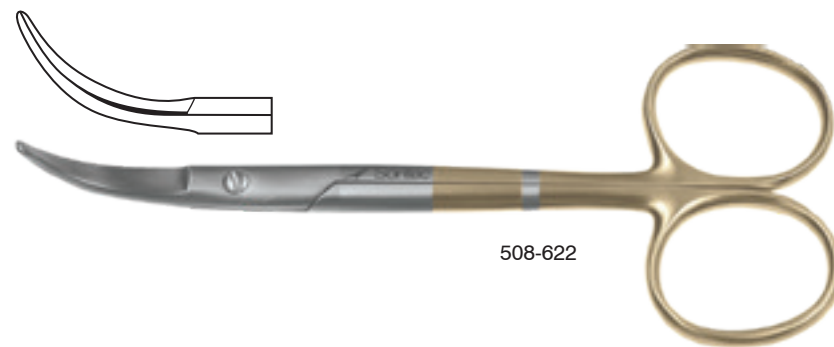

Cinelli lower lateral Scissors

PC Gold / full curve / 4 1/2" (11 cm)

508-619



Fomon Scissors

PC Gold / right-angled / 5 1/2" (14 cm)

508-615



Greenberg Par Scissors

Flat tip / PC Gold / curved / spatulated tips / 4 1/2" (11 cm)

2400-373



McGuire Corneal Section Scissors

Lightly curved blades

13-7000 right
13-7010 left

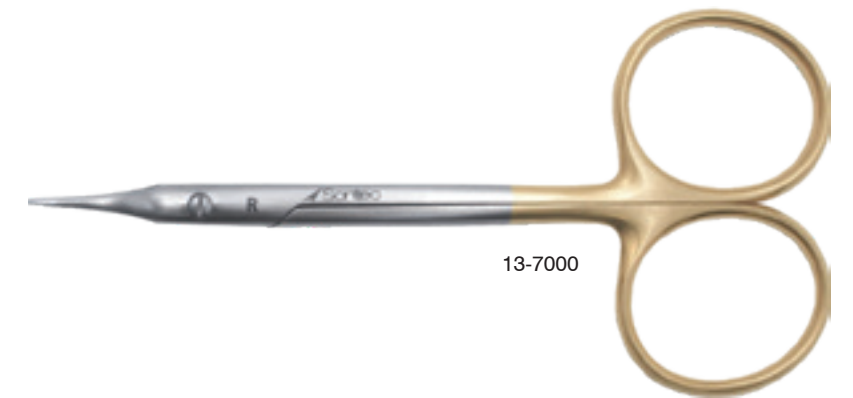
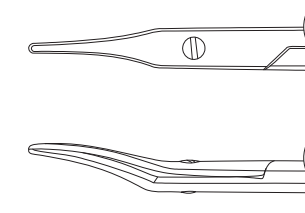

AEBLI Corneal Scissors

Upward blade

13-7030 right
13-7035 left

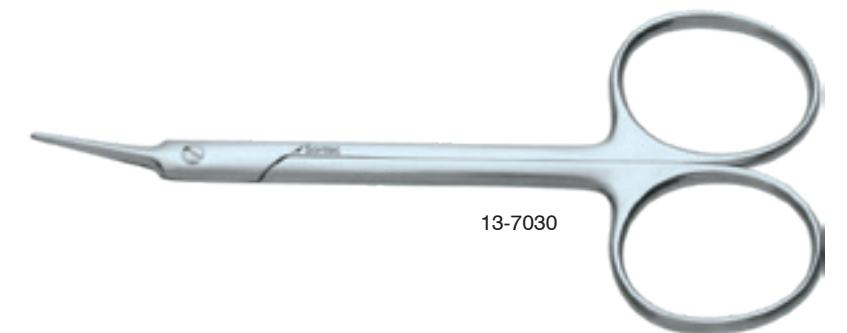

Kaye Blepharoplasty Scissors

TC / 4 1/2" (11.5 cm)

- 112-602 straight
- 112-603 curved

Serrated / ribbon handle / 4 1/4" (10.8 cm)

- 1200-070 PC gold straight
- 1200-072 PC gold curved
- 13-6800 PC silver straight
- 13-6810 PC silver curved
- 13-6815 PC Black curved

PC Gold / curved / spread handle / 4 3/4" (12 cm)

- 1200-076

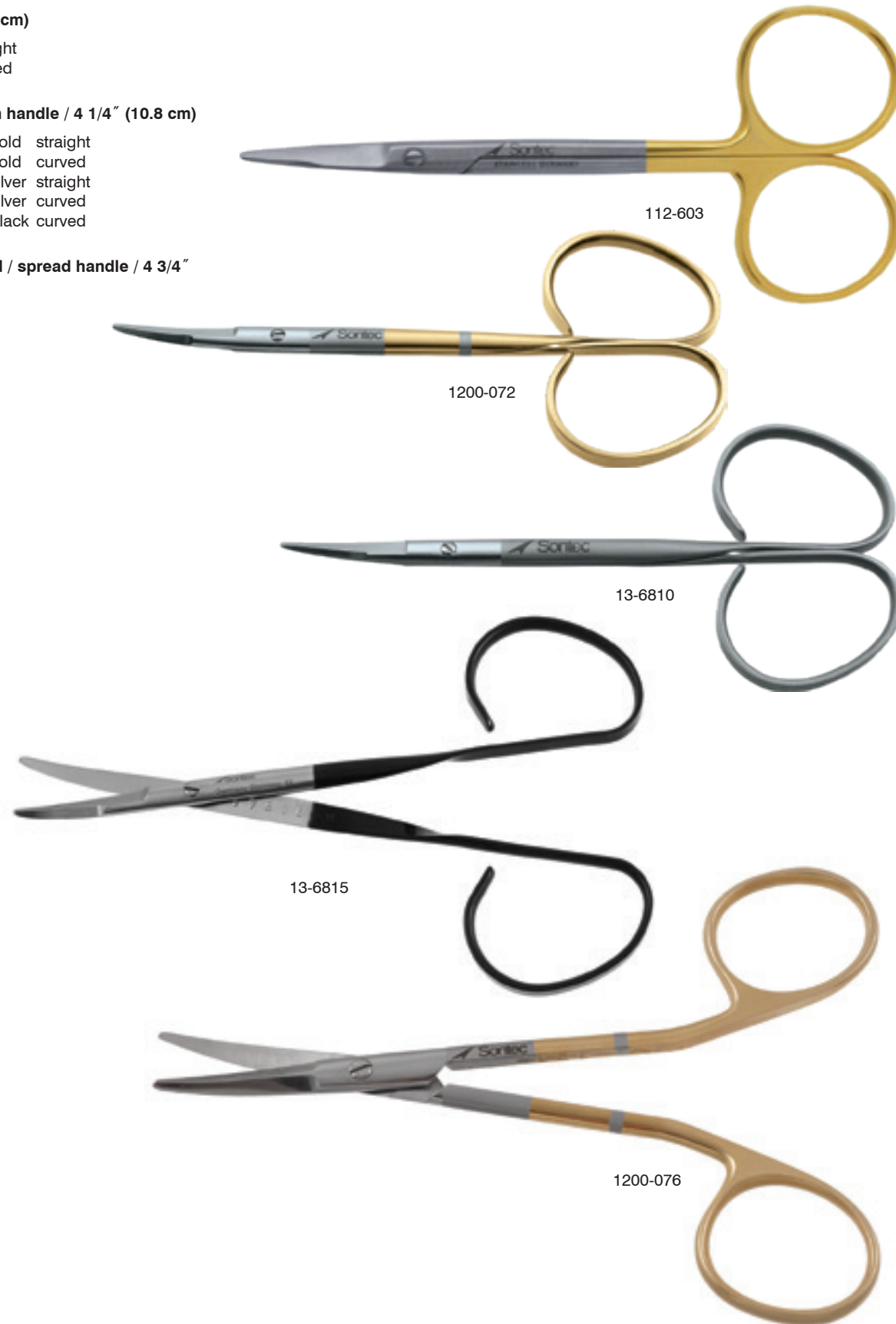

McPherson Needle Holder

Very delicate jaw / suggested suture size 8.0 and smaller

- 15-1310 straight without lock stainless 4"
- 15-1330 curved without lock stainless 4"
- 15-1300 straight with lock stainless 4"
- 15-1320 curved with lock stainless 4"
- T15-1320 curved with lock titanium 4 1/8"
- T15-1330 curved without lock titanium 4 1/8"
- T15-1320R curved with lock titanium 4 3/8"
- T15-1330R curved without lock titanium 4 3/8"

Extra delicate jaw / fenestrated handle / with lock

- 15-1300F str 4 1/4"
- 15-1320F cvd 4 1/4"

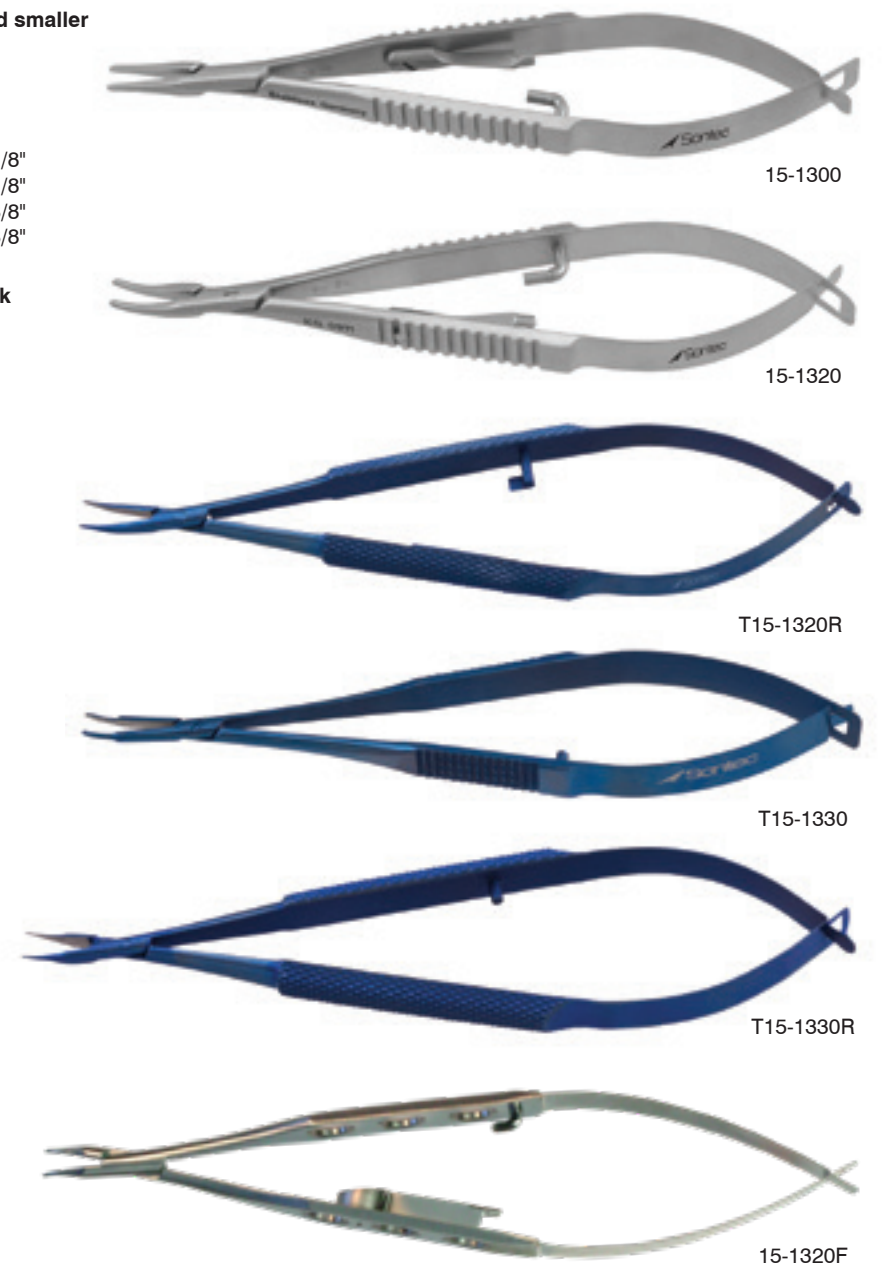

Yamamoto Needle Holder

Tying foreign body forceps / 3 1/4" suggested suture size 7.0 and smaller

- 15-4070 straight
- 15-4071 curved



Castroviejo Wide Handle Needle Holder

Delicate conical jaw / flat handle / 5 1/2"

- 15-1400 straight w/o lock
- 15-1410 curved w/o lock
- 15-1420 straight w/ lock
- 15-1430 curved w/ lock



15-1420

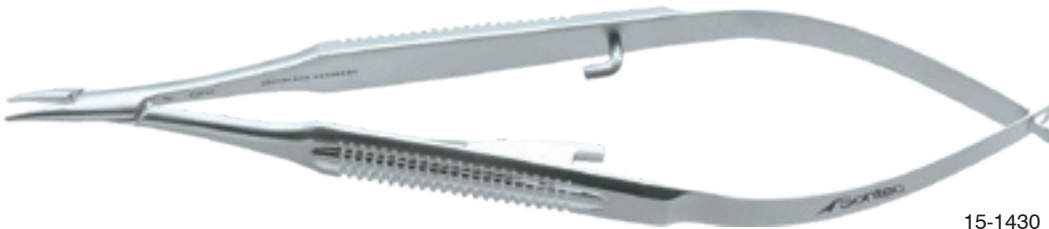

15-1430

Castroviejo Needle Holder

Delicate jaw / 5 1/2"

- 15-1800 straight w/o lock
- 15-1810 curved w/o lock
- 15-1820 straight w/ lock
- 15-1830 curved w/ lock



15-1830

Standard jaw / 5 1/2"

- 15-1860 straight w/ lock
- 15-1880 curved w/ lock
- 15-1861 straight w/o lock
- 15-1881 curved w/o lock



15-1861

Delicate jaw / titanium / 5 1/2"

- T15-1800 straight w/o lock
- T15-1810 curved w/o lock
- T15-1820 straight w/lock
- T15-1830 curved w/lock

Standard jaw / titanium / 5 1/2"

- T15-1860 straight w/lock
- T15-1880 curved w/lock
- T15-1861 straight w/o lock
- T15-1881 curved w/o lock

Castroviejo Needle Holder with Scissors

Flat handle / TC insert / 5 1/2" (14 cm) / suggested suture size 7-0 and smaller

- 15-1980 str with lock
- T15-1980 str with lock
- 15-1982 cvd with lock
- T15-1982 cvd with lock

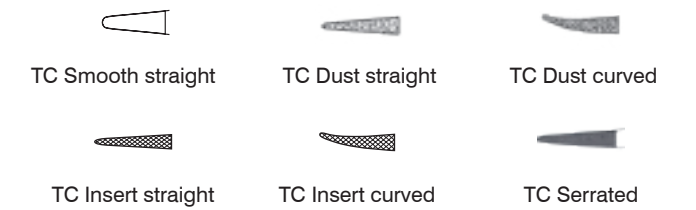

15-1980



15-1982



T15-1980



T15-1982

Castroviejo Needle Holder

Flat handle / TC dust / 5 3/4" (14.5 cm)
/ suggested suture size 7-0 and smaller

- 15-1916 str w/o lock
- 15-1917 cvd w/o lock
- 15-1912 str w/lock
- 15-1913 cvd w/lock
- 15-1914 str w/lock delicate
- 15-1915 cvd w/lock delicate

Flat handle / TC dust / 5 3/4" (14.5 cm)
/ suggested suture size 7-0 and smaller
/ titanium

- T15-1916 str w/o lock
- T15-1917 cvd w/o lock
- T15-1912 str w/lock
- T15-1913 cvd w/lock
- T15-1914 str w/lock delicate
- T15-1915 cvd w/lock delicate

Flat handle / TC insert / 5 3/4" (14.5 cm)
/ suggested suture size 7-0 and smaller

- 15-1900 str w/ lock
- 15-1910 cvd w/ lock
- 15-1901 str w/o lock
- 15-1911 cvd w/o lock



15-1912



15-1913



T15-1913



15-1900



15-1910



TC Smooth straight TC Dust straight TC Dust curved TC Insert straight TC Insert curved TC Serrated

Ryder-Castroviejo Needle Holder

Flat handle / TC serrated / delicate / with lock /
suggested suture size 7-0 and smaller

- 2300-194 5 3/4" (14.5 cm)
- 2300-195 7" (18 cm)
- 2300-196 8 1/2" (21.5 cm)



2300-195



2300-196

Barraquer Anis Needle Holder

Delicate / round handle / 4 3/4" (12 cm)

15-3800	straight	w/o lock	
T15-3800	straight	w/o lock	titanium
15-3810	curved	w/o lock	
T15-3810	curved	w/o lock	titanium
15-3820	straight	w/lock	
T15-3820	straight	w/ lock	titanium
15-3830	curved	w/lock	
T15-3830	curved	w/ lock	titanium



15-3810



15-3820



15-3830



T15-3830

Barraquer Needle Holder

Round handle / regular jaw / 5 1/2" (14 cm)

15-3960	straight	w/ lock	stainless	TC serrated
15-3965	curved	w/ lock	stainless	TC serrated
15-3961	straight	w/o lock	stainless	TC serrated
15-3964	curved	w/o lock	stainless	TC serrated

Round handle / 5 1/4" (13 cm)

15-3915	straight		
15-3920	curved		TC Dust
T15-3920	wo/ lock	curved	titanium TC Dust
15-3925	w/ lock	straight	
T15-3925	straight	w/ lock	titanium
15-3930	w/ lock	curved	TC Dust
T15-3930	curved	w/ lock	titanium

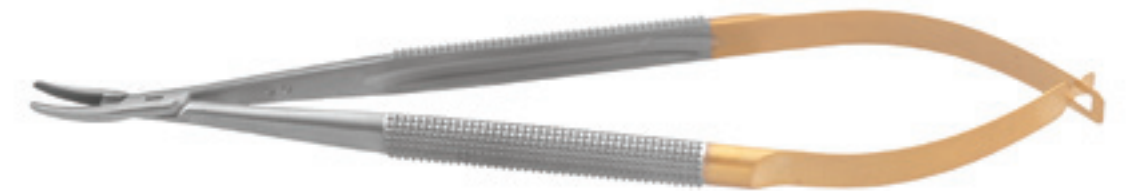

15-3964



15-3930



15-3965



15-3925

Mini Barraquer Short Needle Holder

Delicate jaw / short handle / 3 7/8" (10 cm)

- 15-3300 straight w/o lock
- 15-3310 curved w/o lock
- 15-3320 straight w/ lock
- 15-3330 curved w/ lock



15-3330

Barraquer Needle Holder Long Classic Model

Curved / with lock / 5 1/2" (14 cm)

- 15-3860 smooth jaws
- 15-3862 TC Dust
- 15-3864 TC



15-3860

Barraquer Medium Needle Holder Classic Model

Medium delicate jaw / suggested suture size 6-0 and smaller / 5 1/4" (13.3 cm)

- 15-3802 w/o lock straight
- 15-3812 w/o lock curved
- 15-3822 w/lock straight
- 15-3832 w/lock curved



15-3822

Titanium / delicate jaw / suggested suture size 6-0 and smaller / 5 1/4" (13.3 cm)

- T15-3802 w/o lock straight
- T15-3812 w/o lock curved
- T15-3822 w/lock straight
- T15-3832 w/lock curved

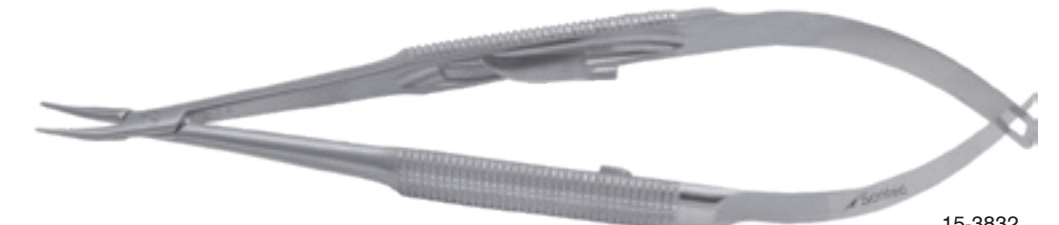

15-3832



T15-3832

Barraquer Needle Holder Titanium

Round handle / curved

- T15-3994 w/o lock 5" (13 cm)
- T15-3995 with universal lock 4" (10 cm)



T15-3994



T15-3995

Jacobi Micro Needle Holder

Round longitudinal serrated handle / suggested suture size 8.0 and smaller / 4 1/2" (11.4 cm)

- 15-4090 straight w/lock
- 15-4092 curved w/lock
- 15-4094 straight
- 15-4096 curved



15-4090



15-4092

Troutman Needle Holder

Very delicate / angled jaw / round knurled handle / suggested suture size 8.0 and smaller / 4 1/2" (11 cm)

- 15-3550 w/o lock
- 15-3560 w/lock



15-3550

Troutman-Sontec Needle Holder

Delicate short jaw / round longitudinal serrated handle / suggested suture size 6.0 and smaller / 4 1/2" (11.4 cm)

- 15-4001 straight
- 15-4011 curved
- 15-4000 straightw/ lock
- 15-4010 curved w/ lock



15-4010

Troutman Needle Holder

Extra-Delicate / round knurled handle / curved / without lock / suggested suture size 5.0 and smaller / 4 1/4" (10.8 cm)

- 15-3350

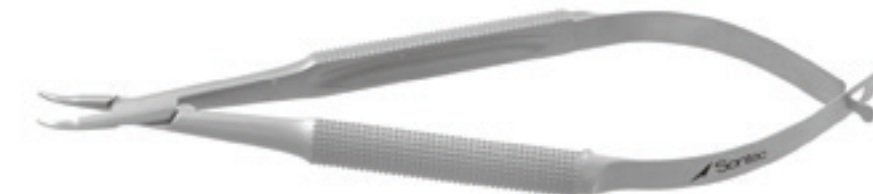

15-3350

Troutman-Barraquer Needle Holder

Round handle / medium / suggested suture size 5.0 & smaller / 4 1/2" (11 cm)

- 15-3337 straight with lock
- 15-3338 curved with lock
- 15-3339 straight without lock
- 15-3340 curved without lock

Round handle / medium/small jaws / suggested suture size 5.0 & smaller / 5 3/4" (15 cm)

- 15-3336 curved with lock



15-3338

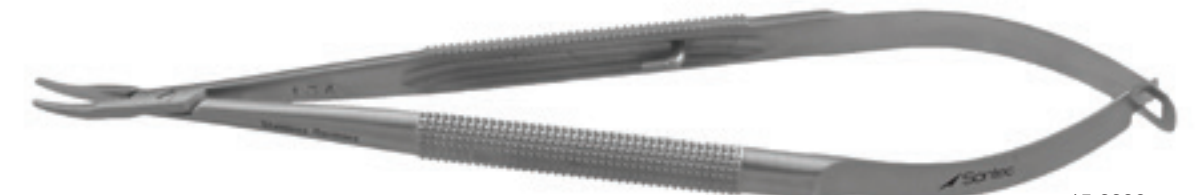

15-3336

Sontec Barraquer X-Delicate Needle Holder

Suggested suture size 8.0 and smaller / knurled handle / 4 7/8" (12 cm)

15-4100	straight	with lock
15-4110	straight	without lock
15-4120	curved	with lock
15-4130	curved	without lock

Suggested suture size 8.0 and smaller / knurled handle / titanium / 4 7/8" (12 cm)

T15-4100	straight	with lock
T15-4110	straight	without lock
T15-4120	curved	with lock
T15-4130	curved	without lock

Suggested suture size 8.0 and smaller / long serrated round handle / titanium / 0.4 jaw / 5" (12.7 cm)

T15-4105	straight	with lock
T15-4115	straight	without lock
T15-4125	curved	with lock
T15-4135	curved	without lock



15-4110



15-4120



T15-4110



T15-4120



T15-4135

Sontec Extra Micro Needle Holder

Round handle / TC dust / extra delicate jaws / specially serrated grip on shanks / 6" (15 cm) / suggested suture size 8-0 and smaller

400-254	str	w/lock
400-256	cvd	w/lock
400-250	str	w/o lock
400-252	cvd	w/o lock



400-254

Castroviejo Needle Holder

Round handle / TC dust / with lock / suggested suture size 7-0 and smaller

- 2300-020 str 4 3/4" (12 cm)
- 2300-024 cvd 4 3/4" (12 cm)
- 2300-030 str 5 3/4" (14.5 cm)
- 2300-034 cvd 5 3/4" (14.5 cm)
- 2300-038 str 6" (15 cm)

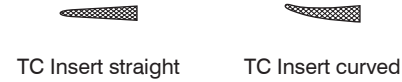

Round handle / with out lock / TC dust

- 2300-022 str 4 3/4" (12 cm)
- 2300-026 cvd 4 3/4" (12 cm)
- 2300-032 str 5 3/4" (14.5 cm)
- 2300-036 cvd 5 3/4" (14.5 cm)

Round handle / TC insert / with lock

- 2300-040 str 6" (15 cm)
- 2300-042 cvd 6" (15 cm)

Round handle / streamlined / TC serrated / with lock

- 2300-040S str 6" (15 cm)
- 2300-042S cvd 6" (15 cm)

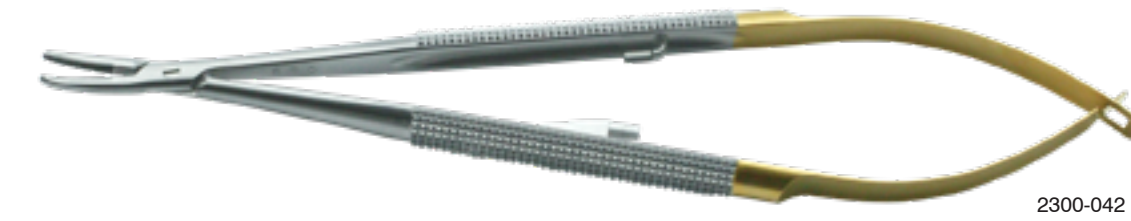

Double Action Needle Holder Titanium

8.5mm jaw / fine tip / titanium / TC dust

- T15-3840 straight
- T15-3841 curved



Kalt Needle Holder

Tungsten carbide / serrated

- 15-2100 str 5 1/2" (14 cm)

Smooth delicate

- 15-2105 str 5 1/2" (14 cm)



Kaye Needle Holder

Tungsten carbide

- 132-348 4 3/4" (12.1 cm)
- 132-350 7" (18 cm)

TC Dust

- 132-352 4 3/4" (12.1 cm)
- 132-354 7" (18 cm)

* Custom micro serrations on cutting blade available upon request



Derf Needle Holder

Mini / 3 1/2" (9 cm)

- 132-375 TC dust
- 132-376 TC serrated
- 132-376S TC smooth

Mini / 4 1/4" (11 cm)

- 132-632 TC serrated
- 132-634 smooth

4 3/4" (12 cm)

- 130-508
- 132-364 TC serrated
- 132-364L TC serrated left streamlined large rings
- 132-364S TC serrated
- 132-365 TC Dust

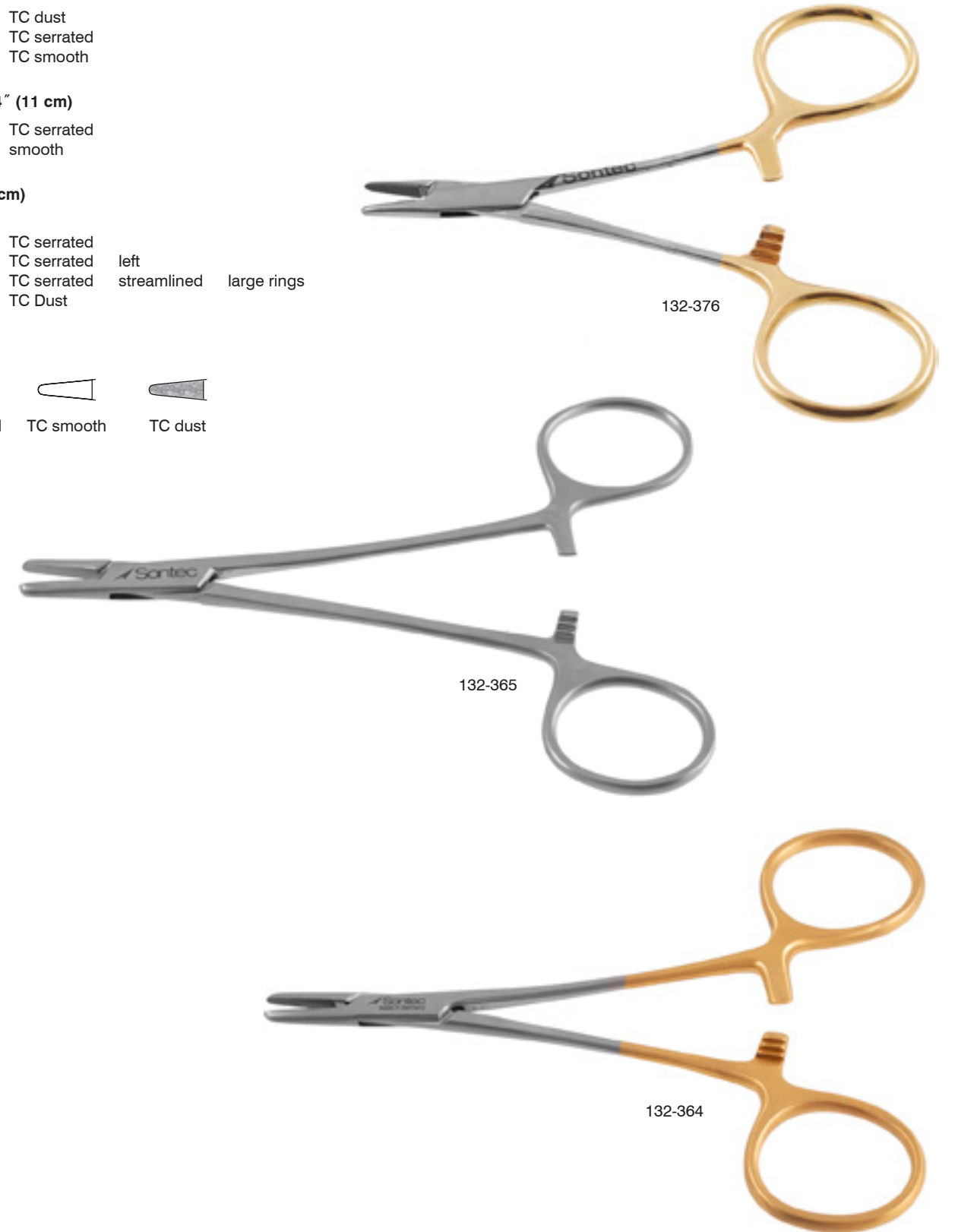
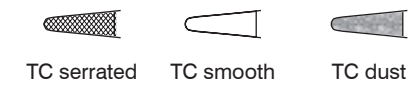

Webster Needle Holder

4 3/4" (12 cm)

- 1100-392 serrated w/out TC
- 2300-516 TC serrated
- 2300-518 TC smooth
- 2300-520 TC dust
- 2300-521 6" TC dust



2300-520
TC Dust



2300-518
TC Smooth



2300-516
TC Serrated

Olsen-Webster Needle Holder Titanium

Fine jaw / 5" (12.7 cm) / TC dust

1100-105T

* Custom micro serrations on cutting blade available upon request

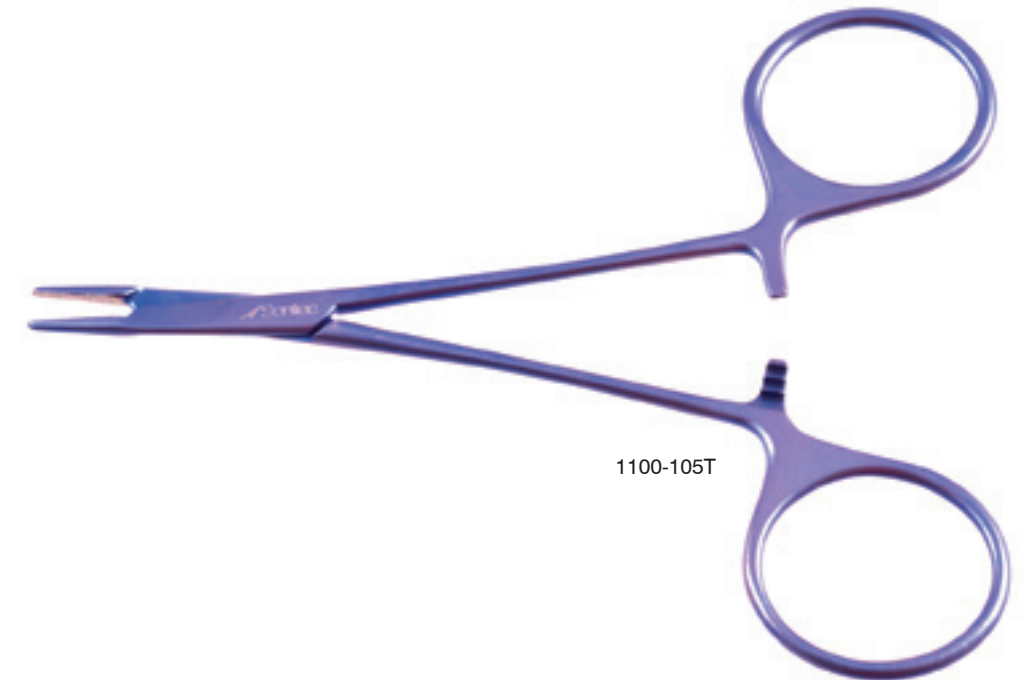

Olsen-Webster Needle Holder

4 3/4" (12 cm)

- 1103-601 serrated w/out TC/standard
- 132-362 TC serrated
- 132-359 TC serrated delicate
- 132-360 TC smooth
- 1103-604 TC dust delicate
- 132-361 TC dust
- 132-362D TC serrated *
- 132-362S TC offset ring

* Double offset ring
 * Custom micro serrations on cutting blade available upon request

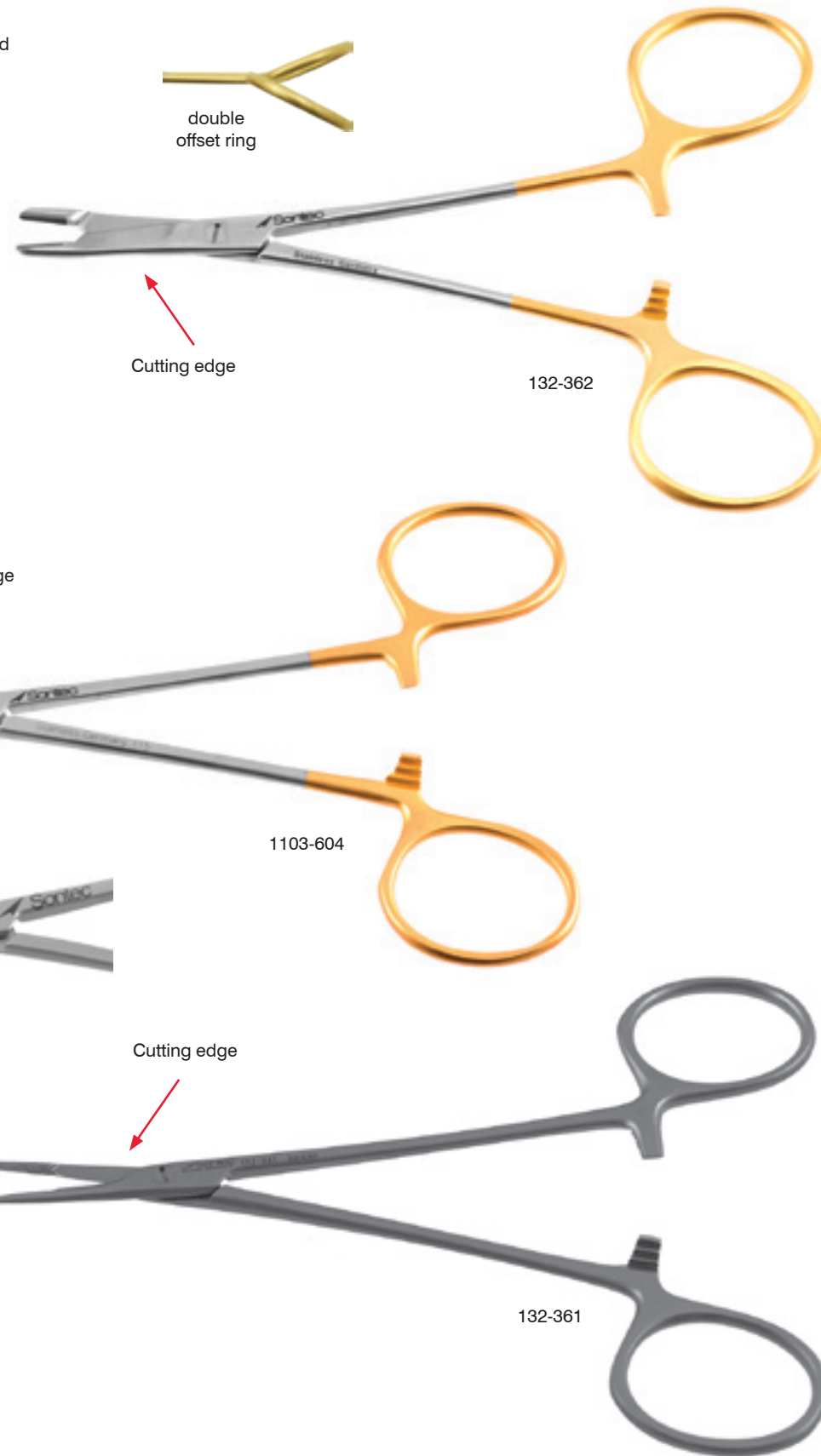
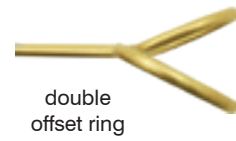
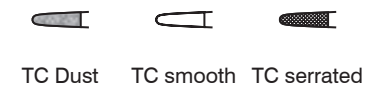

Par Needle Holder

TC serrated

- 132-367A 4 1/2" (11.5 cm)
- 132-367 5 1/4" (13 cm)



Jewelers Classic Forceps

#1 / standard handle / extra delicate

14-6810 stainless
T14-6810 titanium



14-6810

#2 / standard handle / delicate / stair

14-6815
14-6816 TCD
T14-6816 titanium



14-6815

#3 / standard handle / standard

14-6830 stainless
T14-6830 titanium



14-6830

#3 / standard handle / standard / stainless / TCD

14-6831

#3C / standard handle / short

14-6820 stainless
T14-6820 titanium



T14-6820

#3C / standard handle / standard / stainless / TCD

14-6821

#4 / standard handle / standard

14-6840 stainless
T14-6840 titanium



14-6840

#5 / standard handle / extra delicate

14-6850 stainless
T14-6850 titanium



T14-6850

#7 / standard handle / curved

14-6870 stainless
T14-6860 titanium



T14-6860

Jewelers Forceps Titanium with Serrated Handle

Serrated handle / delicate / straight / 4 3/4" (12.1 cm)

2200-001T #1 tip
2200-0012T #2 tip .2 mm tip
2200-0011T #2 tip .4 mm tip
2200-0013T #3 tip

Serrated handle / delicate / #4 tip / straight / 4 1/4" (11 cm)

T14-6841

Serrated handle / 45 degree / sharp / #5 tip / 4 1/4" (11 cm)

2200-003T

Serrated handle / curved / sharp / #7 tip / 4 1/2" (11.4 cm)

T14-6875

Serrated handle / delicate / straight / #5 / 4 1/4" (10.8 cm)

T14-6855
T14-6855P with platform



T14-6841



2200-003T



T14-6875



T14-6855P



2200-001T



2200-0012T



2200-0013T

Jewelers Precision Forceps

Serrated handle

- 2200-001 #1
- 2200-0012 #2
- 2200-0013 #3
- 2200-0014 #4
- 2200-007 #PP
- 2200-003 #5 angled 45°
- 2200-0003 #5 angled 90°
- 2200-013 #5
- 2200-014 #5A
- 2200-0006 #6 angled 80°
- 2200-002 #7 curved

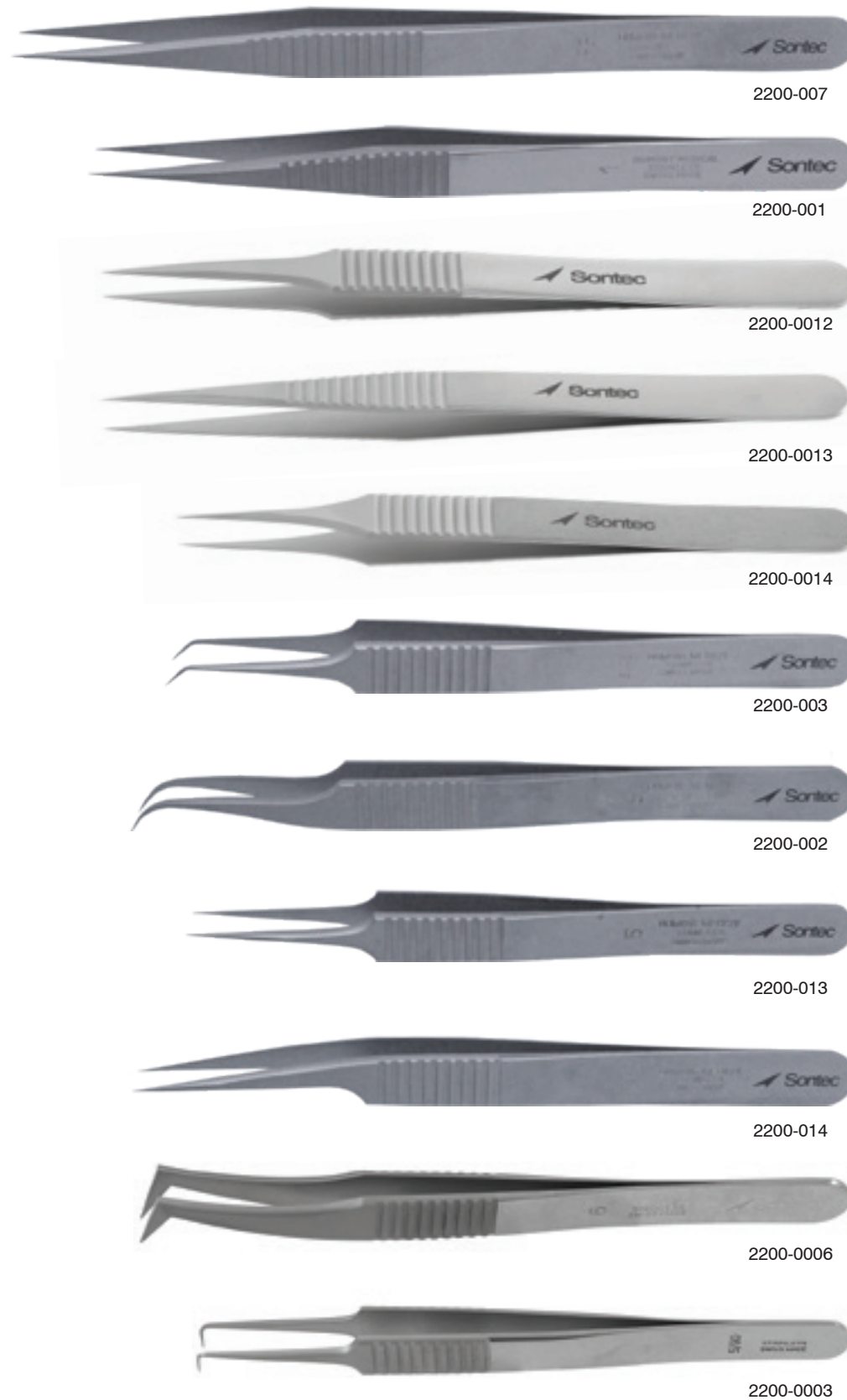

Jewelers #00 aka Cilia & Suture Removal Forceps

Fine Tip / TC Dust / 4 1/2" (11.5cm)

- 14-6805 stainless steel
- T14-6805 titanium



Jewelers Forceps Titanium

Extra Long / Fine tip / serrated handle / TC Dust / 6 1/4" (16cm)

2200-007T



Walter Splinter Forceps

4 1/2" (11.4 cm)

- 138-060 straight
- 138-065 angled



Harms-Colibri 1x2 Tissue Forceps

Tying platform / stainless / 1 x 2 box teeth

- 14-1845 0.12 mm delicate
- 14-1847 0.2 mm
- 14-1851 0.3 mm
- 14-1850 0.4 mm
- 14-1852 0.5 mm



Tying platform / titanium / 1 x 2 box teeth

- T14-1845 0.12 mm delicate
- T14-1847 0.2 mm
- T14-1851 0.3 mm
- T14-1850 0.4 mm
- T14-1852 0.5 mm



Tying platform / wide tip / titanium / 1 x 2 teeth

- T14-1845W 0.12 mm



Harms-Colibri 1x2 Tissue Forceps

Typing platform / 1 x 2 angled teeth / delicate / 0.12 mm

14-1820	stainless	0.12 mm
T14-1820	titanium	0.12 mm
T14-1819		0.3 mm



T14-1820

Polack Corneal Forceps

Colibri style / double tips / (1x2)x2=6 teeth / 3 mm spread

14-3910	0.12 mm	delicate
14-3900	0.3 mm	



14-3910

Colibri style / double tips / (1x2)x2=6 teeth / 3 mm spread

T14-3910	0.12 mm	delicate
T14-3900	0.3 mm	



T14-3910

Fenestrated handle / double tips / (1x2)x2=6 teeth / 3 mm spread / .12 mm

T14-3920



T14-3920

Hoffman-Polack Corneal Pierce Teeth Forceps

Double tips / 1 x 1 / 0.12 mm

14-3925	3 mm spread
14-3920	1 mm spread



14-3920

Sontec-Bores Fixation Forceps

U-shaped / 3 mm spread / 1x2 teeth / 0.12 mm at each tip

T14-3552	curved	with lock
T14-3550	straight	without lock



Arrow Smith Corneal Fixation Forceps

U-shaped / 14 mm spread / 1x2 teeth / 0.12 mm at each tip

T14-3555



Colibri 1x2 Tissue Forceps

1 x 2 box teeth / 0.12 mm / delicate

14-1800	stainless
T14-1800	titanium



14-1800

Botvin Iris 1x2 Tissue Forceps

Colibri style / for peripheral inductomies

14-1340	serrated
14-1350	1 x 2 box teeth



14-1350

Gill Iris Tissue Forceps

Colibri style

14-1300	cross-serrated
14-1310	1 x 2 box teeth



14-1300

Pierse Hoskin Tissue Forceps

Very delicate / micro grooved tips

T14-2000	colibri
T14-2005	angled #16
T14-2015	straight #28
T14-2020	curved #30

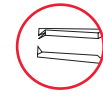

T14-2005

Very delicate / pointed tips

T14-2025	curved #34
----------	------------

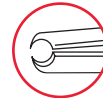

T14-2015



T14-2020

Castroviejo-Colibri Forceps

Typing platform / castroviejo handle / 0.12 mm / 1 x 2 box teeth

14-2200	stainless
14-2202	stainless delicate
T14-2200	titanium
T14-2202	titanium delicate

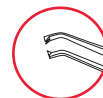

T14-2200

Typing platform / round handle / 0.12 mm / 1 x 2 box teeth

T14-2201	titanium
----------	----------

Typing platform / castroviejo handle / 0.3 mm / 1 x 2 box teeth

14-2206	stainless
T14-2206	titanium



T14-2201

Girard Corneoscleral Forceps

Tying platform / 1 x 2 angled teeth / 0.12 mm / delicate

- 14-3200 right handed
- 14-3210 left handed

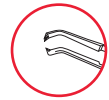

14-3200

Hyde Corneal Forceps

Tying platform / 2 x 2 box teeth / 0.12 mm / delicate

- T14-2220
- 14-2220

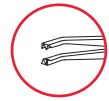

14-2220

Bishop-Harmon 1x2 Tissue Forceps Titanium

1 x 2 box teeth / 3 1/2" (9 cm)

- T14-3803 0.3 mm
- T14-3805 0.5 mm
- T14-3810 0.8 mm
- T14-3800 0.12 mm

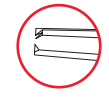

T14-3810

Bishop-Harmon 1x2 Tissue Forceps

1 x 2 teeth / 3 1/2" (9 cm)

- 14-3800 0.3 mm tip delicate
- 14-3805 0.5 mm tip
- 14-3810 0.8 mm tip

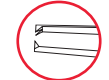

14-3810

Castroviejo Suture 1x2 Teeth Forceps

With tying platform / 1 x 2 teeth / stainless

- 14-2800 0.12 mm tip
- 14-2805 0.2 mm tip
- 14-2810 0.3 mm tip
- 14-2860 0.3 mm tip angled tips on flat
- 14-2815 0.4 mm tip
- 14-2820 0.5 mm tip
- 14-2880 0.5 mm tip angled tips on flat
- 14-2830 0.9 mm tip
- 14-2840 1.5 mm tip



14-2810

With tying platform / 1 x 2 teeth / titanium

- T14-2800 0.12 mm tip
- T14-2805 0.2 mm tip
- T14-2810 0.3 mm tip
- T14-2815 0.4 mm tip
- T14-2820 0.5 mm tip
- T14-2830 0.9 mm tip
- T14-2840 1.5 mm tip



T14-2810

Troutman-Colibri Suture Forceps

Tying platform / 1 x 2 box teeth / 0.12 mm / ergonomic handle

- 14-2955
- T14-2955



14-2955



T14-2955

Kelman & Hoffer Suture Tissue Forceps

Angled / tying platform / 1 x 2 box teeth / 0.12 mm / ergonomic handle

- 14-2935

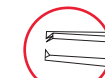

14-2935

Ergonomic-Handle Castroviejo Suture Forceps

Straight / tying platform / 1 x 2 angled teeth / 0.12 mm / 4 1/2" (11.5 cm)

- 14-2905

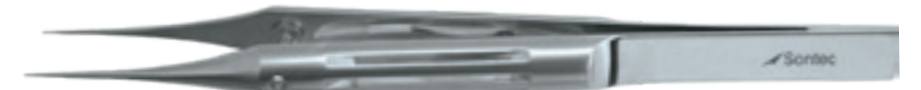
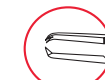

14-2905

Ergonomic-Handle Bonn Suture Forceps

Long tip / Tying platform / 1 x 2 box teeth / 0.12 mm / 4 1/2" (11.5 cm)

- 14-2920

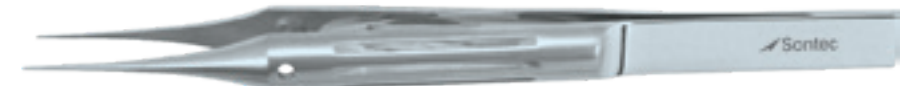

14-2920

Short tip / tying platform / 1 x 2 box teeth / 0.12 mm / 4 1/2" (11.5 cm)

- 14-2922



14-2922

Pierse Corneal 1x2 Forceps

Very delicate / micro grooved tips

- 14-2100 straight
- 14-2110 curved



14-2100

Bonn Suture 1x2 Forceps

With tying platform / 1 x 2 teeth / long handle / stainless

- 14-2320 0.12 mm tip
- 14-2323 0.3 mm tip
- 14-2326 0.6 mm tip
- 14-2329 0.9 mm tip

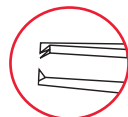

14-2300

With tying platform / 1 x 2 teeth / short handle / 0.12 mm tip / fenestrated handle

- 14-2300 stainless
- T14-2300 titanium



14-2322

With tying platform / 1 x 2 teeth / fenestrated handle / 0.3 mm tip / stainless

- 14-2322
- T14-2322 titanium



T14-2322

With tying platform / 1 x 2 teeth / titanium

- T14-2320 0.12 mm tip
- T14-2321 0.2 mm tip
- T14-2323 0.3 mm tip



T14-2320

With tying platform / 1 x 2 box teeth / 0.12 mm / serrated handle

- 14-2318

Graefe Iris 1x2 Tissue Forceps

1 x 2 teeth / 2 3/4" (7 cm)

- 14-1600 straight
- 14-1610 curved

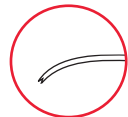
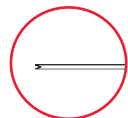

14-1610

Iris 1x2 Tissue Forceps

1 x 2 teeth / 0.5 mm tip / extra delicate / 4" (10 cm)

- 14-4400 straight
- 14-4410 half curve
- 14-4415 full curve

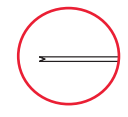

14-4440

1 x 2 teeth / 0.8 mm tip / standard / 4" (10 cm)

- 14-4440 straight
- 14-4450 half curve
- 14-4455 full curve
- T14-4440 straight titanium

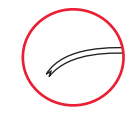

14-4410



full curve

Foerster Iris 1x2 Tissue Forceps

Curved / 1 x 2 teeth on outside / 4" (10 cm)

- 14-4700



14-4700

Foerster Iris 1x2 Tissue Forceps

1 x 2 teeth / 3 3/4" (9.5 cm)

- 14-4720 straight
- 14-4723 curved
- 14-4727 angled



14-4727

McPherson Corneal 1x2 Tissue Forceps

Long model / tying platform / 1 x 2 box teeth / 0.4 mm

- 14-2600 straight
- 14-2610 angled

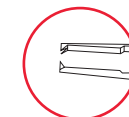

14-2610

McPherson Corneal 1x2 Tissue Forceps

Short model / tying platform / 1 x 2 box teeth / 0.4 mm

- 14-2620 straight
- 14-2625 angled
- T14-2625 angled titanium

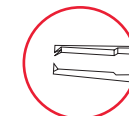

14-2625

Short model / tying platform / 1 x 2 box teeth / curved

- 14-2626 0.12 mm
- 14-2627 0.2 mm
- 14-2628 0.3 mm



14-2627

Kelman-McPherson 1x2 Tissue Forceps

8 mm long / 0.3 mm / angled / 1 x 2 box teeth
14-2630

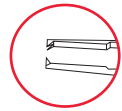

14-2630

Stern-Castroviejo Suture 1x2 Tissue Forceps

6 mm long / 1 x 2 box teeth / 0.5 mm / straight / handle with thumb catch lock
14-2890

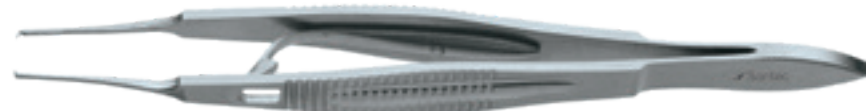
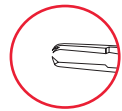

14-2890

Manhattan 1x2 Tissue Forceps

Tying platform / 1 x 2 box teeth / stainless

14-3050 0.7 mm
14-3070 0.6 mm
14-3060 0.3 mm

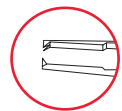

14-3070

Tying platform / 1 x 2 box teeth / titanium

T14-3050 0.7 mm
T14-3070 0.6 mm
T14-3060 0.3 mm

Manhattan Severin 1x2 Tissue Forceps

Tying platform / 1 x 2 angled teeth / stainless

14-3073 0.12 mm delicate
14-3075 0.3 mm
14-3071 0.5 mm
14-3072 0.6 mm
14-3077 0.7 mm
14-3074 0.9 mm

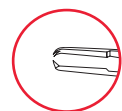

14-3077

Tying platform / 1 x 2 angled teeth / titanium

T14-3073 0.12 mm delicate
T14-3075 0.3 mm
T14-3071 0.5 mm
T14-3072 0.6 mm
T14-3077 0.7 mm
T14-3074 0.9 mm

Bracken 1x2 Fixation Forceps

1 x 2 teeth / angled / 4 1/4" (10.5 cm)
14-4800

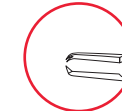

14-4800

Lester Fixation 1x2 Tissue Forceps

4" (10 cm)
14-4600 1 x 2 teeth
14-4620 2 x 3 teeth

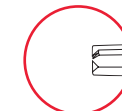

14-4620

Girard 1x2 Fixation Forceps

With sliding lock / 1 x 2 angled teeth

14-3240 0.3 mm
14-3245 0.9 mm
14-3246 0.5 mm

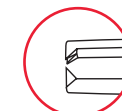

14-3240

With sliding lock / 0.5 mm / with tying platform / 1 x 2 angled teeth

14-3247 curved
14-3248 straight



14-3245



14-3247

Strabismus Forceps

1x2 teeth / slide lock

14-3150 straight
14-3152 right
14-3154 left



14-3150



14-3152



14-3154

Girard 1x2 Fixation Forceps

With push lock / 1 x 2 box teeth

14-3260A 0.3 mm
14-3260B 0.5 mm
14-3260C 0.9 mm
14-3260D 1.2 mm

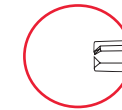

Ergonomic Handle Tying Forceps

TC dust / tying platform / 4 1/2" (11.5 cm)

- T14-5525 straight
- T14-5527 curved
- T14-5530 curved extra delicate

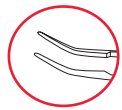

T14-5527

Tennant Tying Forceps

Smooth / titanium / delicate / tying platform / round handle / 4" (10 cm)

- T14-5560 straight
- T14-5570 curved

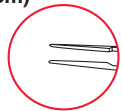

T14-5560

Smooth / stainless / delicate / tying platform / round handle / 4" (10 cm)

- 14-5560 straight
- 14-5570 curved



T14-5570

Kelman-McPherson Tying Forceps

Round fluted ergonomic handle / smooth / delicate / angled / 8 mm / tying platform / for 9-0 to 11-0 sutures

- 14-5285 stainless
- T14-5330 titanium

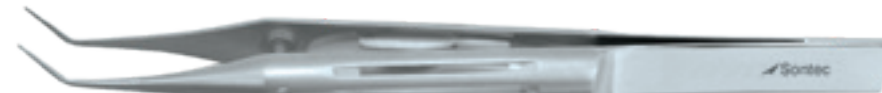

14-5285

O'Gawa Tying Forceps

With tying platform / curved tip / round handle

- 14-5548 stainless steel
- T14-5548 titanium



14-5548



T14-5548

Ergonomic Handle Tennant Tying

Smooth / delicate / long tying platform / for 9-0 to 11-0 sutures / stainless / 4 1/2" (11.5 cm)

- 14-5540 straight
- 14-5545 curved

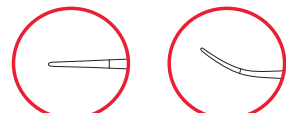

14-5545

Castroviejo Tying Forceps

Smooth / tying platform / stainless / 4 1/4" (10.5 cm)

- 14-5900 straight
- 14-5910 curved



14-5910

Stainless models available with castroviejo handle or fenestrated handle, please specify desired handle when ordering



McPherson Tying Forceps Titanium

Smooth / 5 mm long / tying platform / 4 1/4" (10.5 cm)

- T14-5300 straight
- T14-5310 angled



T14-5325

Smooth / 5 mm long / tying platform / 3 1/4" (10.5 cm)

- T14-5320 straight
- T14-5325 angled

TC dust / 5 mm long / tying platform / 4 1/4" (10.5 cm)

- T14-5301 straight
- T14-5311 angled

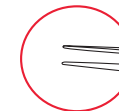

T14-5300

Castroviejo Tying Forceps Titanium

Smooth tying platform / castroviejo handle / 4 1/4" (10.5 cm)

- T14-5900 straight
- T14-5910 curved

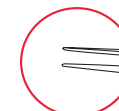

T14-5900

Bishop-Harmon Serrated Dressing Forceps

Serrated / 3 1/2" (9 cm)

- 14-3860



Cross-serrated / 0.5 mm tip / delicate / 3 1/2" (9 cm)

- 14-3850

14-3850

Graefe Iris Serrated Dressing Forceps

Cross-serrated / 2 3/4" (7 cm)

- 14-1570 straight
- 14-1580 curved



14-1580



Foerster Iris Dressing Forceps

Serrated / octagon handle / 3 3/4" (9.5 cm)

- 14-4721 straight
- 14-4725 curved

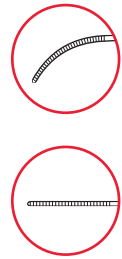

14-4725

Iris Dressing Forceps

Serrated / 0.5 mm tip / delicate / 4" (10 cm)

- 14-4300 straight
- 14-4310 half curve
- 14-4305 full curve

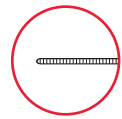

14-4300

Serrated / 0.8 mm tip / standard / 4" (10 cm)

- 14-4340 straight
- 14-4345 half curve
- 14-4350 full curve

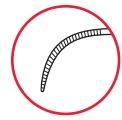
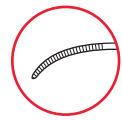

Harms-Castroviejo Handle Tying Forceps

4 1/4" (10.5 cm)

- 14-5705 straight
- 14-5715 curved

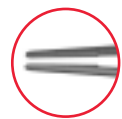

14-5715

Osher Ultra Fine Tying Forceps

Stainless

- 14-5848



14-5848

McPherson Tying Forceps

Smooth / 5 mm long / tying platform / stainless / fenestrated handle / 4 1/4" (10.5 cm)

- 14-5300 straight
- 14-5310 angled

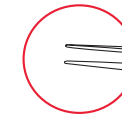

14-5310

Smooth / 5 mm long / tying platform / stainless / 3 1/4" (8.0 cm)

- 14-5320 straight
- 14-5325 angled

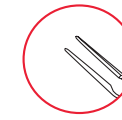

14-5325

Jaffe Tying Forceps

Smooth / tying platform / stainless / fenestrated handle / 4" (10 cm)

- 14-5500 straight
- 14-5510 angled



14-5500

Smooth / tying platform / titanium / fenestrated handle / 4" (10 cm)

- T14-5500 straight
- T14-5510 angled



14-5510

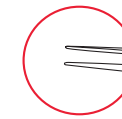

T14-5500

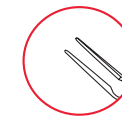

T14-5510

Harms Tying Forceps

Smooth / tying platform / stainless / flat handle / 4" (10 cm)

- 14-5700 straight
- 14-5710 curved

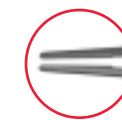

14-5700

Smooth / tying platform / titanium / flat handle / 4" (10 cm)

- T14-5700 straight
- T14-5710 curved



14-5710

Intraocular Grasping Forceps

Axial squeeze handle
14-7750

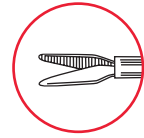

Intraocular Micro Biopsy Forceps

Axial squeeze handle
14-7751

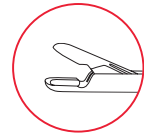

Axial Capsulorhexis Utrata Forceps

Axial handle
14-5396 stainless
T14-5396 titanium

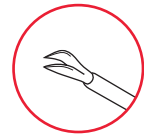

Utrata Kershner Capsulorhexis Cystotome Forceps

Flat handle / stainless
14-5384

Round handle
14-5385 stainless
T14-5385 titanium

Ergonomic handle
T14-5384 titanium
T14-5387 titanium long formed tips

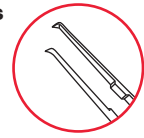
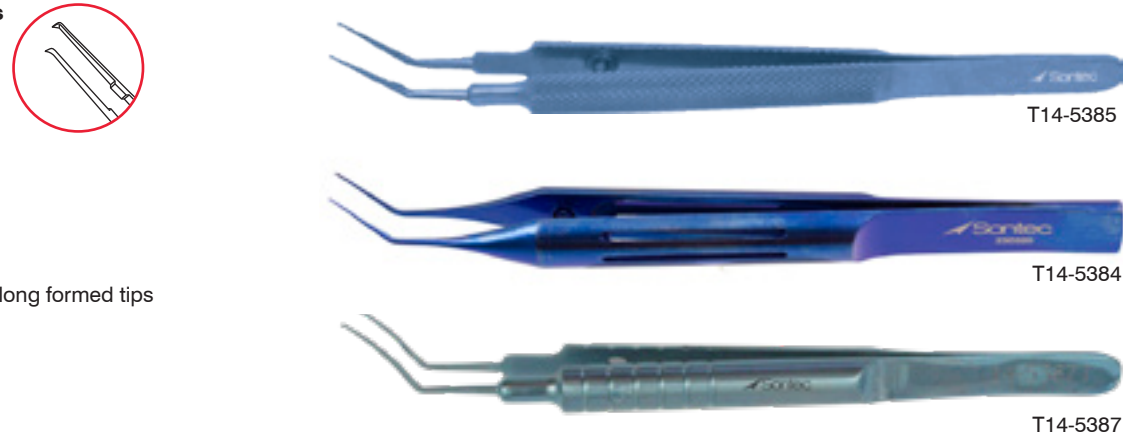

Utrata Kershner Capsulorhexis Cystotome Forceps

Titanium / formed / round spring handle
T14-5379



Utrata Capsulorhexis Forceps

Titanium / formed / round spring handle
T14-5378



Utrata Capsulorhexis Forceps

Flat handle
14-5382 stainless
T14-5382 titanium

Round handle
14-5381 stainless
T14-5381 titanium

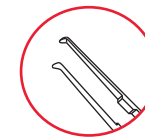

Hoffman Utrata Capsulorhexis Forceps

Stainless / flat handle
14-5383
14-5389 17 mm long jaw

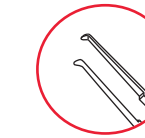

Titanium / flat handle
T14-5383
T14-5383R round knurled handle
T14-5389 17 mm long jaw



Masket Capsulorhexis Forceps

Very delicate grasping tips

14-5394 stainless
T14-5894 titanium



T14-5894

Lehner Capsulorhexis Forceps

Round fluted ergonomic handle / very delicate grasping tip

14-5395 stainless
T14-5395 titanium



14-5395



T14-5395

Fechtner Conjunctiva Ring Tip Forceps

1 mm delicate ring tip / very delicate / straight / ring shaped tips / with tying platform / 4 1/4" (11 cm)

14-6515 stainless steel
T14-6515 titanium



T14-6515

2 x 2 ring tips 1 mm / very delicate / straight / with tying platform / 4 1/4" (11 cm)

T14-6516 titanium



T14-6516

IOL Inserting Lens Forceps

Titanium / very delicate

T14-9263



T14-9263

Direct Action Foldable Lens Forceps

Very delicate / titanium

T14-9265



T14-9265

Foldable Lens Insertion Forceps

Round handle / smooth elliptical tips

14-7762 stainless
T14-7762 titanium



T14-7762

Round handle / with lock

14-7763 stainless
T14-7763 titanium

Kraff-Anis Lens Inserting Forceps

Delicately curved / for grasping IOL Haptics / angled shanks

T14-8981



T14-8981

Kraff Lens-Holding Forceps

Delicately curved / for grasping p/c lens / optic edge

14-8980



14-8980

Shepard Lens Holding Forceps

Duckbill shaped jaw/ titanium / gently curved

T14-9210



T14-9210

Shepard Lens-Holding Forceps

Slightly curved / serrated lower jaw

14-8900 standard
14-8920 with lock



14-8920

Full curved / delicate

14-8930 stainless steel
T14-8930 titanium

Full curved / delicate / with lock

14-8940 stainless steel
T14-8940 titanium



T14-8940

Cross-Action Nucleus Splitter Forceps

Cross-serrated / short handle

14-5372 stainless
T14-5372 titanium



T14-5372

Cross-serrated / long handle / fenestrated

14-5374 stainless
T14-5374 titanium



T14-5374

Cross-Action Nucleus Splitter Forceps

Round handle

T14-5376 titanium



T14-5376

Jameson Muscle Forceps

Child size / 4 teeth / slide lock

14-9300 right
14-9310 left



14-9300

Adult size / 6 teeth / slide lock

14-9320 right
14-9330 left

Gaskin Fragment Forceps

Smooth / delicate / 11mm / platform jaw / angled

14-5350



14-5350

Kansas Nucleus Removal Forceps

Fenestrated handle

14-7320

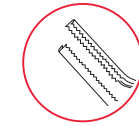

14-7320

Arruga Capsule Forceps

Standard curve / 4" (10.2 cm)

14-7310 stainless steel
T14-7310 titanium



14-7310



T14-7310

Hoffman Lens Implant Forceps

Curved

14-8510



14-8510

Littauer Cilia Forceps

3.5 mm x horizontal serrated tip

14-6301



Bonaccolto Suture Forceps

Conjunctiva forceps / longitudinally serrated jaws / with cross serrations at tips / straight

14-6500 1.2 mm tip
14-6510 1.7 mm tip



14-6510

Titanium / conjunctiva forceps / longitudinally serrated jaws / with cross serrations at tips / straight

T14-6500 1.2 mm tip
T14-6510 1.7 mm tip



T14-6510

Barraquer Cilia Forceps

TC Dust / slightly angled

14-6303



14-6303

Titanium / TC dust / slightly angled

T14-6303



T14-6303

Gradle Cilia Forceps

Smooth square jaws

14-6400
T14-6400 titanium

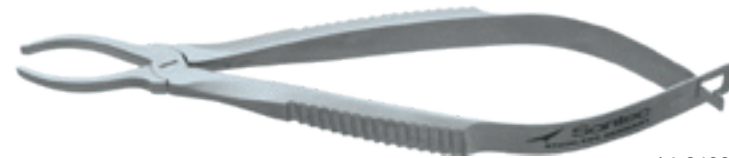

14-6400



T14-6400

Cilia Forceps

Smooth jaws / polished finish / serrated handle / narrow

14-6415



14-6415

Ziegler Cilia Forceps

TC Dust / straight

14-6450



14-6450

Bergh Cilia Forceps

5 mm wide jaws with horizontal serrations / 3 1/2" (9 cm)

14-6445



14-6445

Beer Distichia Cilia Forceps

5 mm wide jaws with TC Dust / 3 3/4" (9.5 cm)

1100-407



1100-407

Swiss Cilia Forceps

3mm platform tip / TC Dust

14-6310



14-6310

Knapp Trachoma Forceps

With rollers

14-9930



14-9930

Erhardt Lid Clamp Forceps

Oval
14-9700



14-9700

Graefe Fixation Forceps

4.5 mm jaw / 4 1/2" (11.5 cm)

14-5120 with lock
14-5122 with lock curved
14-5130 without lock



14-5120



14-5122



14-5130

Green Fixation Forceps

Atraumatic integrating teeth / 4" (10 cm)

14-5200 5 mm jaw
14-5205 5 mm jaw with lock
14-5215 10 mm jaw with lock
14-5220 10 mm jaw



14-5215



14-5220

Titanium / atraumatic integrating teeth / 4" (10 cm)

T14-5220 10 mm jaw
T14-5200 5 mm jaw



T14-5220

Sontec Eye Lid Forceps

Serrated / 5" (12.5 cm)
14-5240



14-5240

Desmarres Chalazion Clamp Forceps

Lower solid blade / stainless

14-9900 17 mm
14-9901 21 mm
14-9902 28 mm

Lower solid blade / laser finished

14-9893 17 mm
14-9894 21 mm
14-9895 28 mm

Lower solid blade / blue electro coat

14-9896 17 mm
14-9897 21 mm
14-9898 28 mm



14-9901



small (17 mm)

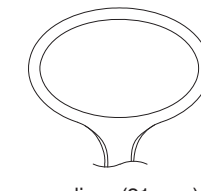

medium (21 mm)

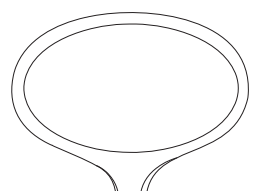

large (28 mm)

Desmarres Severin Chalazion Clamp Forceps

Two open tips / both blades fenestrated

14-9908 17 mm
14-9907 21 mm
14-9906 28 mm

Two open tips / both blades fenestrated

T14-9908 17 mm
T14-9907 21 mm
T14-9906 28 mm



14-9908



17 mm



21 mm



28 mm



T14-9908



T14-9907

Cottle Columella Clamp Forceps

14 mm tip / with locking thumb screw / 4" (19 cm)
14-9730



14-9730

Heath Chalazion Clamp Forceps

Oval / 16 mm x 14 mm
14-9740



14-9740

Lambert Chalazion Clamp Forceps

Round / 8mm
14-9750



14-9750

Hunt Chalazion Clamp Forceps

Round / 12 mm
14-9800



14-9800

Baird Chalazion Clamp Forceps

Small oval / 11 x 8 mm I.D.
14-9850 stainless steel
T14-9850 titanium



14-9850



T14-9850

Francis Chalazion Clamp Forceps

Medium oval
14-9870



14-9870

Lordan Chalazion Clamp Forceps

Triangular
14-9910



14-9910

Snellen Entropium Clamp Forceps

18 x 35 mm jaw
14-9920 right
14-9925 left

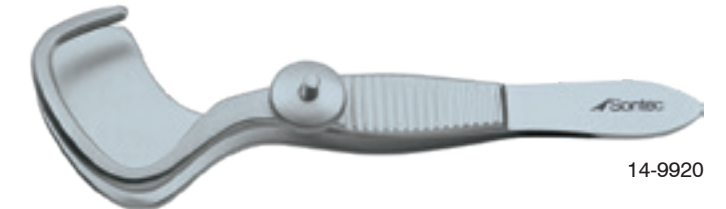

14-9920

Castroviejo Lip Graft Clamp Forceps

U-shaped / closed end
14-9725



14-9725

Jones Towel Clamp Forceps

Cross action / stainless
14-9990 2 1/4" (5.5 cm)
14-9992 3 1/2" (7.5 cm)



14-9990

Cross action / titanium
T14-9990 2 1/2" (6 cm)



T14-9990

Putterman Clamp Forceps

14-9400	stainless	slide lock
T14-9400	titanium	slide lock
14-9410	stainless	screw lock



Berke Ptosis Forceps

14-9600	stainless	slide lock	20 mm
14-9610	stainless	slide lock	27 mm



Castaneda Enucleation Clamp Forceps

Autramatic curved jaw / curved shank / 4 3/4" (12 cm)
23-1818



Kerrison Punch (Ocular-plasti) 90° Rongeur

4" (10 cm) shaft

- 16-2100 1.0 mm wide up
- 16-2101 1.5 mm wide up
- 16-2102 2.0 mm wide up
- 16-2106 2.5 mm wide up
- 16-2103 3.0 mm wide up
- 16-2104 3.0 mm wide down
- 16-2105 4.0 mm wide down

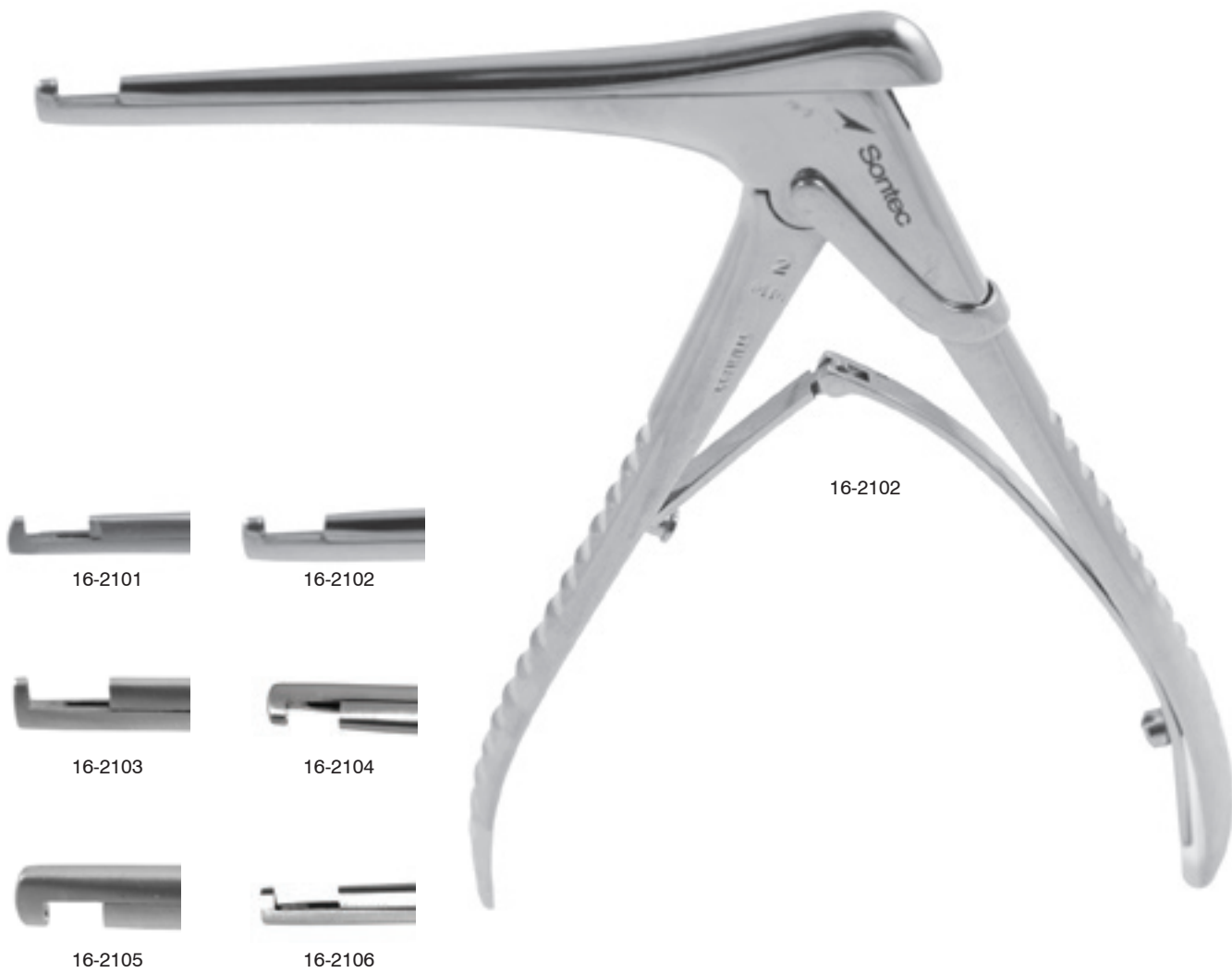

Kerrison Punch (Ocular-plasti) 40° Rongeur

4" (10 cm) shaft

- 16-2096 1.0 mm wide
- 16-2097 1.5 mm wide
- 16-2098 2.0 mm wide
- 16-2099 3.0 mm wide

		Bite Width	
40° Up-Angle		1 mm	16-2096
		1.5 mm	16-2097
		2 mm	16-2098
		3 mm	16-2099

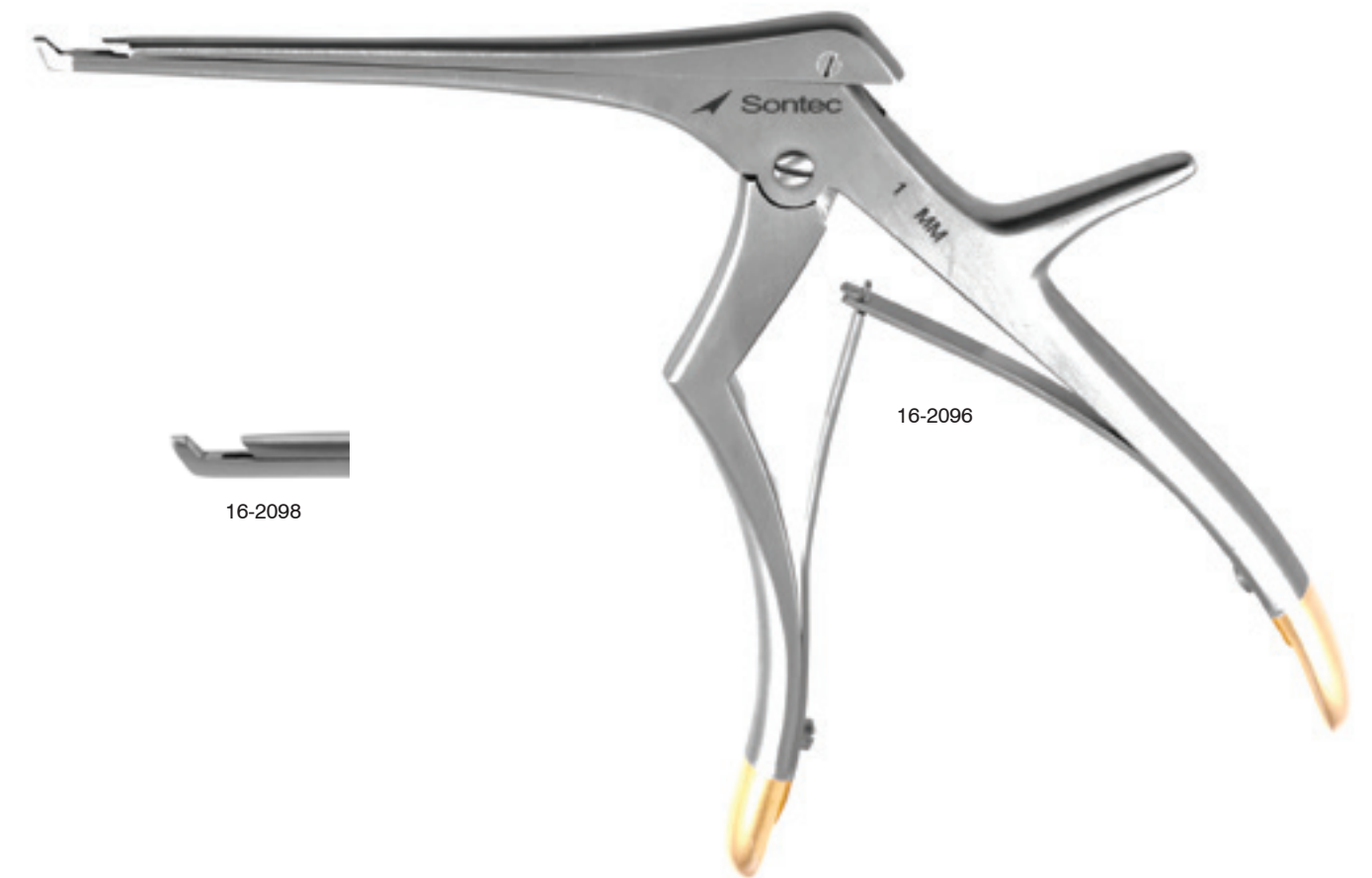

Sontec Micro Mallet

3/4" head diameter / 6 1/2" (16.5 cm)

330-817 stainless steel convex/flat combo 4 oz.
 330-819 lead filled head no recoil 5.6 oz.



330-817

Tieck-Halle Infant Nasal Speculum

5 3/4" (14 cm)

16-2330 stainless
 16-2332 ebonized



16-2330

Vienna Nasal Speculum

5 3/4" (14 cm)

16-2340 small 24 mm blades
 16-2350 medium 30 mm blades
 16-2360 large 32 mm blades



16-2350

Sontec Micro Gouge

5 1/2" (14 cm)

475-803 3mm
 475-804 4mm
 475-805 5mm
 475-806 6mm



475-803

West Osteotome

Square handle

330-708 4 mm 6 1/2" (16.5 cm)
 330-708A 6 mm 7 1/2" (19 cm)



330-708A

Joseph Periosteal Elevator

Curved / 6 3/4" (17 cm)

16-2207 3 mm
 16-2208 3.5 mm
 16-2209 4 mm
 16-2210 5 mm
 16-2200 6.5 mm



16-2209



16-2210

Universal Magnet for Retrieval/Demagnetizing

1404-841 tubular handle 6" (15 cm)
 1404-841P phenolic handle 7" (18 cm)



1404-841



1404-841P

Freer Periosteal Elevator

Double-ended / square handle / straight
/4.5 mm tip / sharp/blunt / 7 3/4"

1100-798S

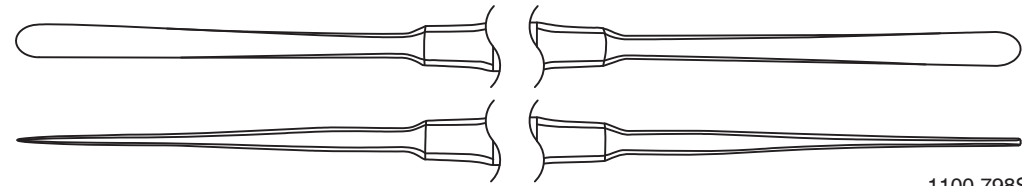

1100-798S

Double-ended / square handle / curved /
4.5 mm tip / sharp/blunt

1100-798 7 3/4"

1100-798G 8 1/2"

1100-798F 8 3/4"



1100-798

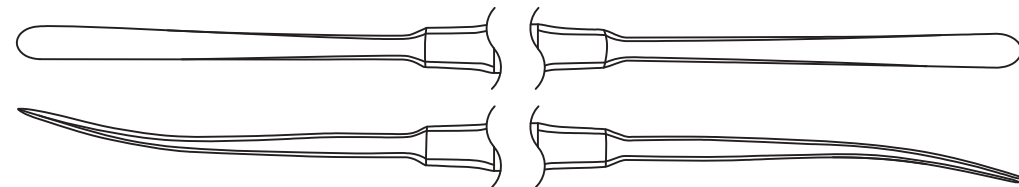

Double-ended / square handle / curved /
6.5 mm tip / sharp/blunt

1100-798A 7 3/4"

1100-798E 8 3/4"



1100-798A

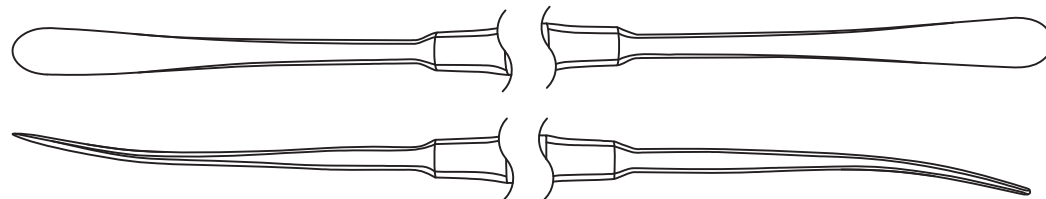

Freer Periosteal Elevator

Double-ended / round handle / curved /
sharp/blunt / 7 1/2"

1100-798B 5 mm tip

1100-798C 6.7 mm tip



1100-798B

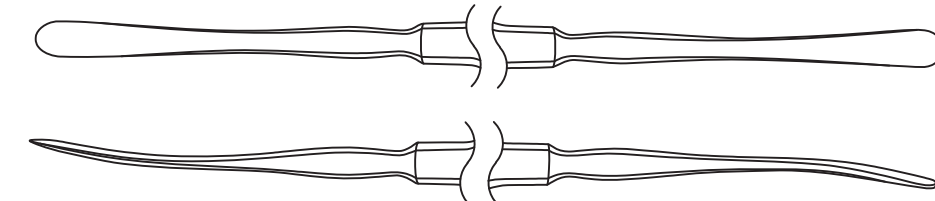

1100-798C

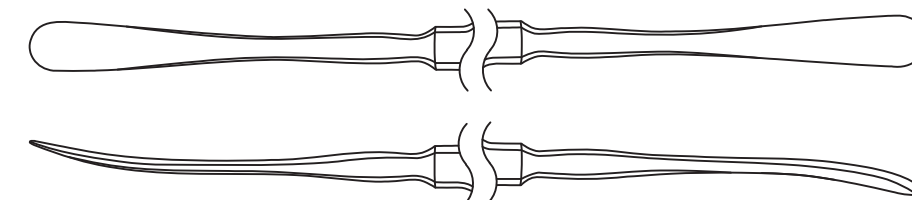

Double-ended / knurled round handle /
curved / 4.5 mm tip / sharp/blunt / 6 3/4"

1100-798D



1100-798D

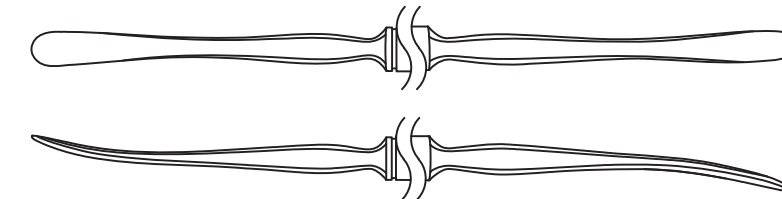

Freer Periosteal Elevator

Double-ended / round handle / curved / 3.5 mm tip / sharp / 7 1/4"

1100-798H

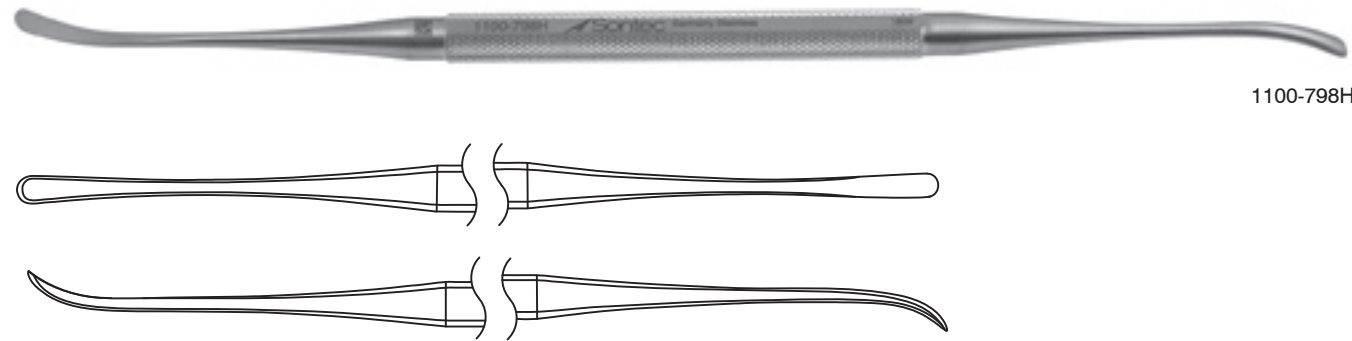

1100-798H

Silicone Eye Implants

Please specify size when ordering / not for medical use (vet only)

- 1100-411-10 10 mm
- 1100-411-11 11 mm
- 1100-411-12 12 mm
- 1100-411-13 13 mm
- 1100-411-14 14 mm
- 1100-411-15 15 mm
- 1100-411-16 16 mm
- 1100-411-17 17 mm
- 1100-411-18 18 mm
- 1100-411-19 19 mm
- 1100-411-20 20 mm
- 1100-411-21 21 mm
- 1100-411-22 22 mm
- 1100-411-23 23 mm
- 1100-412-24 24 mm
- 1100-412-26 26 mm
- 1100-412-28 28 mm
- 1100-412-30 30 mm
- 1100-412-33 33 mm
- 1100-412-36 36 mm
- 1100-412-38 38 mm
- 1100-412-40 40 mm
- 1100-412-43 43 mm
- 1100-412-45 45 mm
- 1100-412-47 47 mm

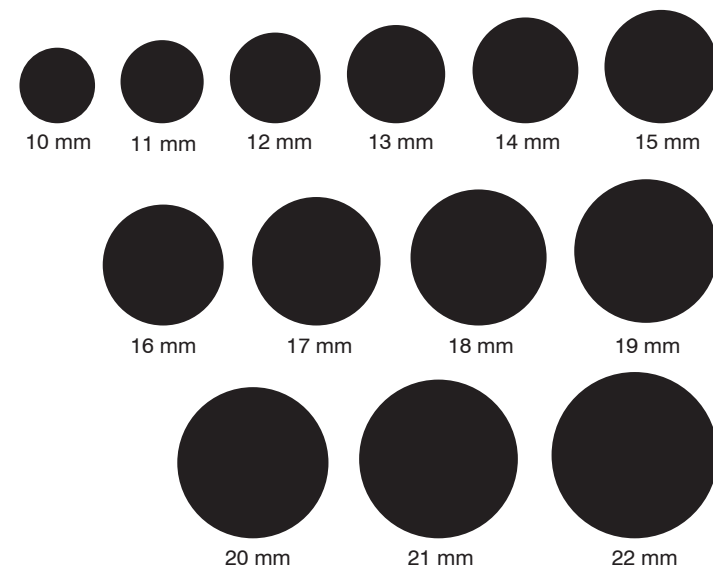

Carter Sphere Introducer

5" (12.5 cm)

17-1000

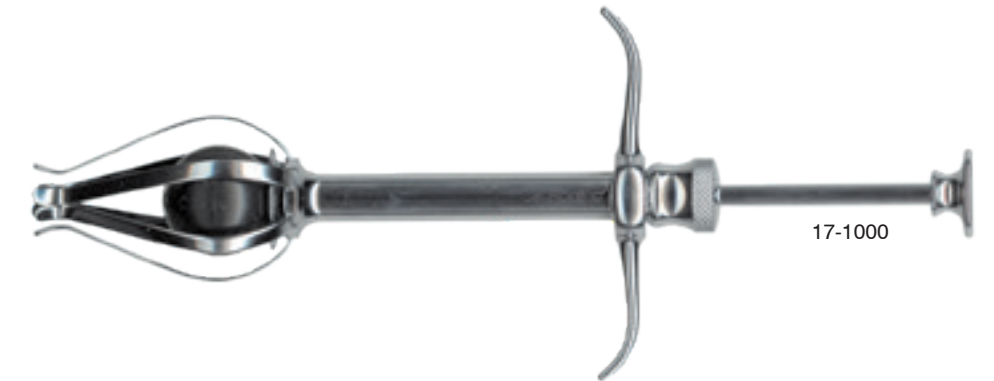

17-1000

Bishop-Harmon Irrigation Bulb Cannula Set

Adapter and blue silicone bulb / angled cannula

- 16-5300-SET complete (bulb, adapter, 19 gauge cannula)
- 16-5310 silicone bulb
- 16-5330 19 gauge cannula
- 16-5331 21 gauge cannula (separate purchase)
- 16-5340 bulb & adapter (separate purchase)
- 16-5320 SS adapter
- 16-5325 plastic adapter (bag of 5 each)
- 16-5321 plastic adapter (1 each)



16-5300-SET



16-5320

16-5330

16-5325

Lacrimal Cannula

Reinforced shaft / 23 gauge

16-3300 straight
16-3310 curved



16-3310

Straight / 23 gauge / 25 mm length

16-3290

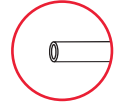

16-3290

Severin Lacrimal Cannula

Curved

1103-500 19 gauge
1103-500A 20 gauge
1103-500B 21 gauge
1103-500C 22 gauge
1103-500D 23 gauge
1103-500E 24 gauge
1103-500F 25 gauge
1103-500G 26 gauge
1103-500H 27 gauge
1103-500J 30 gauge

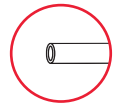

1103-500A

Fasanella Lacrimal Cannula

Curved / 15 mm length / 23 gauge

16-3350



16-3350

Lacrimal Cannula

Side opening / straight / 28 mm length / 19 gauge

16-3346

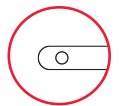

16-3346

Shahinian Lacrimal Cannula

Smooth conical tip / straight / 0.3 mm side opening / 11 mm length / 23 gauge

16-3314

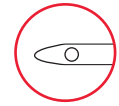

16-3314

McIntyre Lacrimal Cannula

0.3 mm dual sideports / 23 gauge

16-3320 straight
16-3330 curved

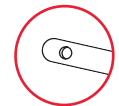

16-3330

West Cannula

Side opening / curved / 25 mm length / 23 gauge

16-3348

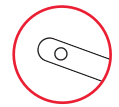

16-3348

Air Injection Cannula

Angled / 5 mm tip

16-3810 25 gauge
16-3820 27 gauge
16-3800 30 gauge



16-3820

Angled / 7 mm tip

16-3821 27 gauge
16-3826 30 gauge



16-3821

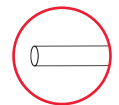
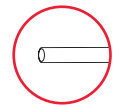

Rainin Air Injection Cannula

Spatulated tip / angled tip / 27 gauge

16-3880

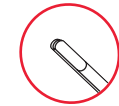

16-3880

Gans Severin Cycled Cannula

19 gauge

16-6085 left side opening
16-6086 right side opening



16-6086

Randolph Cyclodialysis Cannula

Spatulated tip / angled tip

16-3900 21 gauge
16-3920 19 gauge



16-3900

Kelman Cyclodialysis Cannula

Spatulated tip / double angled tip / 19 gauge

16-3960 right side opening
16-3970 left side opening



16-3960

Sheets Cyclodialysis Cannula

Spatulated tip / angled tip / one front & two side openings / 19 gauge

16-3980

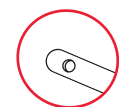

16-3980

Troutman Alpha-Chymotrypsis Cannula

Delicate olive tip / 25 gauge

16-4100

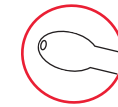

16-4100

Kelman Cystotome Cannula

Sharp cutting edge & tip / straight / 22 gauge

16-4900
16-4910 blunt blade



16-4900



16-4910

Knolle Kelman Cystotome Cannula

Small blade / sharp cutting edge / sharp point / 22 gauge

16-4960



16-4960

McIntyre Reverse Cystotome Cannula

Sharp point / angled tip / 23 gauge

16-4980



16-4980

Lieppman Micro Cystotome Cannula

Very small / sharp cutting edge & tip / straight / 22 gauge
16-5000



16-5000

Welsh Cannula

Flat olive tip / 25 gauge
16-4120 straight
16-4130 left
16-4140 right



16-4120

Osher "J" Cannula

Straight / with hook / 27 gauge
16-4160

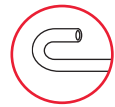

16-4160

Atkinson Retrobulbar Needle Cannula

Straight / 35 mm length
16-4300 23 gauge
16-4310 25 gauge

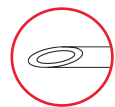

16-4300

McIntyre Inner Cannula

46 mm length / 23 gauge
16-4520 0.2 mm side opening
16-4525 0.25 mm side opening
16-4530 0.3 mm side opening
16-4540 front opening

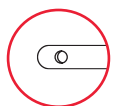

16-4520

Kratz Scratcher Cannula

Front opening / slightly angled / 22 gauge
16-5200



16-5200

Graether Collar Button Cannula

Side irrigation
16-5220 straight
16-5230 angled

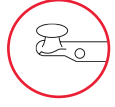

16-5220

Chang Hydrodissection Cannula

Angled 90° / with beveled opening / 27 gauge / 16 mm overall length
16-7295 1.5 mm flat standard tip
16-7296 3.0 mm flat long tip



16-7295



16-7296

Simcoe Cortex Veryctor Cannula

Smooth closed tip / side opening facing into curve / 23 gauge
16-5520 13 mm
16-5530 21 mm



16-5520

De La Vega Anterior Chamber Lens Pusher Cannula

Right-angled u-shaped
16-5940



16-5940

Kuglen Irrigating Lens Manipulator Cannula

Disk-shaped tip, 0.25 mm diameter peg / 25 gauge
16-5970 straight
16-5980 angled

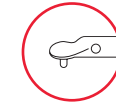

16-5970

Simcoe Nucleus Delivery Cannula

Two ports / 13 mm x 4 mm loop / 25 gauge serrated loop
16-6070 right
16-6075 left

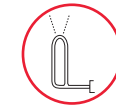

16-6070

Vidaurri Cannula Cannula

16-7350 horizontal
16-7355 vertical



16-7355

Drews Posterior Capsule Polisher Cannula

Slightly rough bottom / 2 mm IO loop / 0.2 mm irrigation facing into loop / slightly angled
16-5080



16-5080

Kraff Posterior Capsule Polishing Curette Cannula

Semi-sharp outer edge / 1.75 mm diameter cup with irrigation / 25 gauge
16-5180

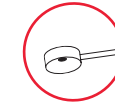

16-5180

Bracken Irrigating Cannula

Smooth tip / beveled tip / front opening / 19 gauge
16-5400

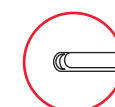

16-5400

McIntyre Anterior Chamber Irrigating Cannula

Smooth tip / blunt tip

- 16-5420 straight 23 gauge
- 16-5430 angled 23 gauge
- 16-5440 straight 26 gauge
- 16-5450 angled 26 gauge
- 16-5460 straight 30 gauge
- 16-5470 angled 30 gauge



16-5430

McIntyre-Binkhorst Irrigating Cannula

Smooth, blunt & angled tip / 26 gauge

- 16-5740 right hook
- 16-5750 left hook



16-5750

Knolle Pearce Irrigating Vectis Cannula

Dual fluid flow through / three front ports / 23 gauge loop

16-5800

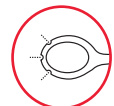

16-5800

Drews-Knolle Irrigating Vectis Cannula

Dual fluid flow through one front & two back openings / 23 gauge loop

16-5810



16-5810

Sheets Irrigating Vectis Cannula

Dual fluid flow through / three large front openings / 20 gauge serrated loop

16-5820

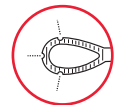

16-5820

Annis Irrigating Vectis Cannula

Dual fluid flow through / two front openings / 23 gauge heart-shaped loop

16-5840

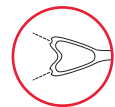

16-5840

Dishler Lasik Cannula

Two ports / angled tip / 25 gauge

- 16-7200 7 mm tip
- 16-7210 9 mm tip



16-7210

Lasik Cannula

Two ports / angled tip

16-7230



16-7230

Bansal Lasik Cannula

Spatulated tip / angled tip / 26 gauge

16-7240



16-7240

Fukasaku Lasik Cannula

23 gauge

16-7245

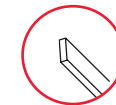

16-7245

Gimbel Lasik Fountain Cannula

Right / 25 gauge

16-7250



16-7250

Banaji Lasik Cannula

Six ports

- 16-7260 smooth
- 16-7270 textured



16-7260

Brierley Lasik Irrigating Cannula

25 gauge

16-7275

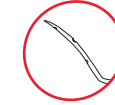

16-7275

Burrato Lasik Cannula

Angled tip

- 16-7280 25 gauge
- 16-7290 23 gauge



16-7290

Mancue Lasik Cannula

Angled tip / 2 ports

16-7300



16-7300

Carter Lasik Cannula

Flat open tip / 25 gauge

16-7330



16-7330

Gimbel Lasik Polishing Cannula

30 gauge
16-7340



16-7340

Healon Aspirating Cannula

Angled tip / 10 mm from angle to tip
16-3850 22 gauge
16-3860 19 gauge



16-3850

Angled tip / 5 mm from angle to tip
16-3848 21 gauge



Keats Infusion Handle

Cones on both ends to fit luer-lock hubs / stainless steel
16-7095



16-7095

Irrigating/Aspirating Handle

4.5" (11.5 cm)
16-7100



16-7100

Gills-Welsh Aspirating Cannula

Smooth, blunt & angled tip / 25 gauge
16-5660 5 mm tip
16-5670 7 mm tip
16-5680 8 mm tip
16-5690 10 mm tip

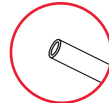

16-5660

Morrison Aspirating Cannula

Smooth, blunt & angled tip / front opening
16-5695

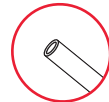

16-5695

McIntyre Infusion Handle

Autoclavable plastic / 3" (7.5 cm)
16-7050

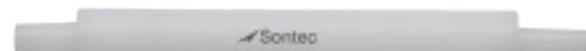

16-7050

Heslin Infusion Cannula

Lightly roughened for retention in the incision / 3 mm long beveled tip / with silicone tubing and adapter
16-7000 25 gauge
16-7010 23 gauge

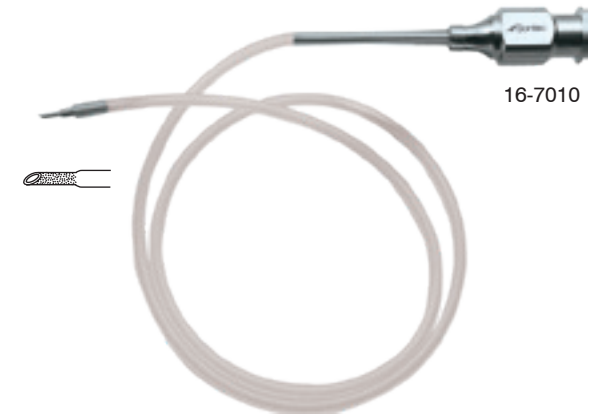

16-7010

Gillis Irrigating-Aspirating Cannula

Side by side front openings / angled / 23 gauge
16-4860

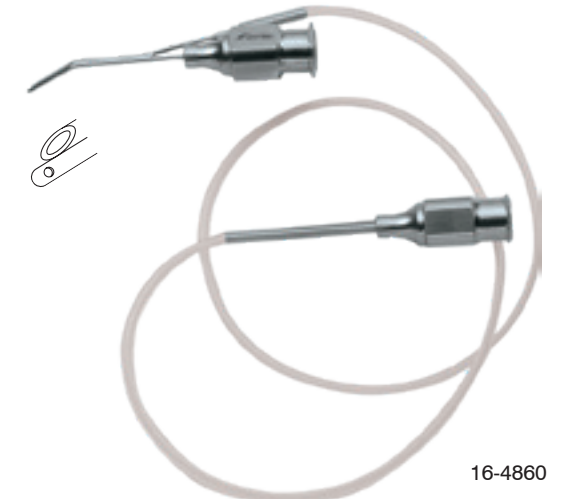

16-4860

Simcoe Irrigating-Aspirating Cannula

For the Simcoe I/A technique / 0.3 mm diameter aspirating port, slightly / shorter irrigating tip with 45° angled opening / 15 mm length / curved / 23 gauge
16-4800 original
16-4805 reversed *

* For a more conventional technique of aspirating through the luer-lock hub cannula

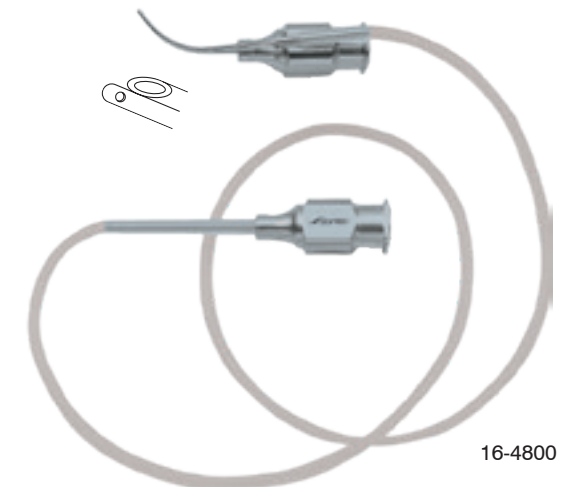

16-4800

Catalano Lacrimal Intubation Set

Includes 2 blunt 0.7 mm diameter probes attached to 30.5 cm long silicone tubing

16-2590



16-2590

Jackson Lacrimal Intubation Set

Includes 2 blunt 0.9 mm diameter probes attached to 30.5 cm long silicone tubing

16-2592



16-2592

Crawford Lacrimal Intubation Set

Includes 2 olive tip 0.6 mm diameter probes attached to 30.5 cm long silicone tubing

16-2594



16-2594

Bodian Lacrimal Probe Set

Includes 2 curved blunt 1.0 mm diameter probes attached to 30.5 cm long silicone tubing

16-2596

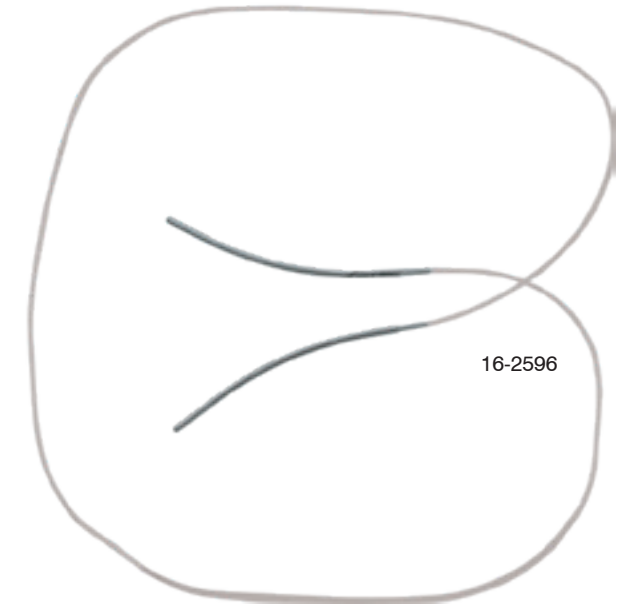

16-2596

Jaeger Lid Plate

Stainless

- 10-4520 1/2 laser finish
- 10-4521 broad laser finish mini 3 3/4"
- 10-4522 1/2 laser finish slight "S" curved
- 10-4525 blue electro coat
- 10-4530 stainless steel
- 10-4535 black laser finish

Titanium

- 10-4540

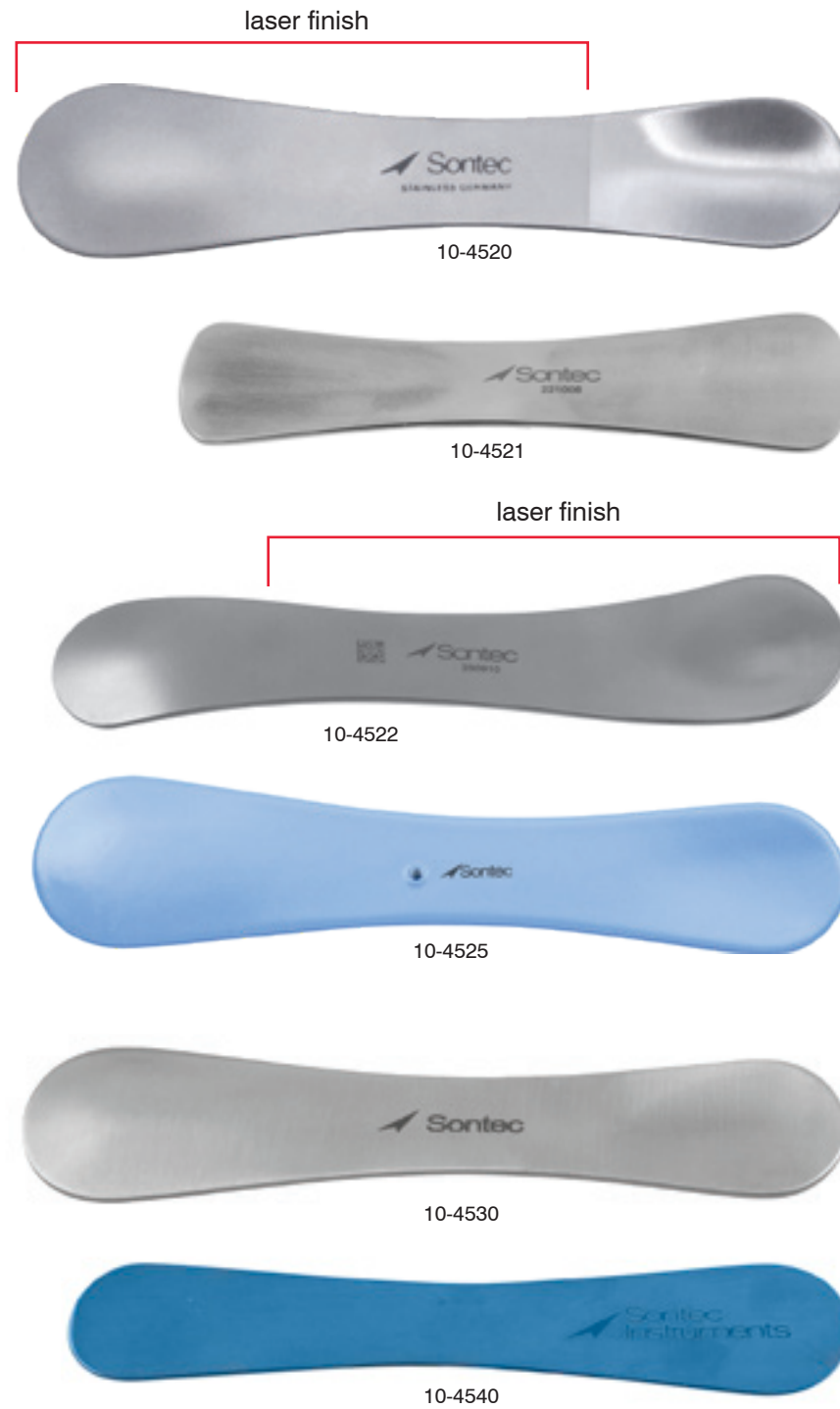

Jaeger Lid Plate with Wedge End

1 round end / 1 flat end / 3 1/2" / stainless steel

- 10-4531



SONTEC ELECTRIFIED BIPOLAR

FINEST QUALITY IN THE INDUSTRY / AGGRESSIVE PRICING

Creating non-stick ceramic
& silver electro cauterly
instrumentation



CERAMIC
Inlayed blades provide an
incredible smooth cut.



FORCEPS
all shown are available
in a variety of lengths, tip
sizes and angles. Choose
wide or classic grip.



- 1. Bayonet Wide Grip Forceps - 2700-852NS
- 2. Bayonet Wide Grip with Suction - 2700-817
- 3. Bayonet Wide Grip Forceps - 2700-807NS
- 4. Bipolar Non-Stick Frazier Suction - 2700-552NS
- 5. Adson 5-Hole Forceps - 2700-908NS
- 6. Metzenbaum Scissors 2700-5331
- 7. Cushing Tissue Forceps - 2700-804NS
- 8. Cushing Forceps 2700-905NS
- 9. Metzenbaum Scissors 2700-S071
- 10. Jensen Bayonet Classic Grip Forceps 2700-891NS
- 11. Metzenbaum Scissors 2700-5431
- 12. Bayonet Wide Grip Forceps 2700-844NS

NEW WIDE GRIP HANDLE
offers yet another option to surgeons by
providing more handle space to articulate
the non-stick silver tips

Sontec Instruments

A TRADITION OF FINE SURGICAL INSTRUMENTS

www.SontecInstruments.com

Colorado / USA / 800.821.7486

PLASTILOGICAL INSTRUMENTATION

FINEST QUALITY IN THE INDUSTRY / AGGRESSIVE PRICING

- 1. Cottle Crusher 350-849
- 2. Gillies 132-394C
- 3. Davis 412-767
- 4. Sontec 3mm 1100-479M
- 5. Lacrimal Probe 16-2510
- 6. Westcott 13-3306
- 7. Desmarres 10-4220
- 8. Kahn Face Lift Scissors 475-175



- 9. Eye Shield 1100-409M
- 10. Eye Shield Pair 18-8020
- 11. 2 mm 40° Kernson 404-491
- 12. Desmarres Electro Blue 14-9608
- 13. Bipolar Suction Forceps 2700-817
- 14. Joseph 16-2210
- 15. 0.5 Castroviejo 14-2820
- 16. Cottle 6 mm 350-849C

- 17. Puttermann 714-9400
- 18. Jewellers 14-6940
- 19. Mini Neuro 1106-086
- 20. Silicon Eye Spheres 1100-411-23
- 21. Joseph Hook Electro Blue 199-432
- 22. Stevens 1200-497
- 23. Sphero Introducer 17-1000
- 24. Castroviejo 15-1910

Sontec Instruments

A TRADITION OF FINE SURGICAL INSTRUMENTS

www.SontecInstruments.com

Colorado / USA / 800.821.7486



SONTEC EXPERTS OF INSTRUMENTATION

FINEST QUALITY IN THE INDUSTRY / AGGRESSIVE PRICING

1. Vergeze Pizzo Chopper - 12-1407
2. Stevens Ergonomical Scissors - 1200-708
3. Castroviejo Coblin - 14-2200
4. Pigtail Probe with Hook - 16-2000
5. Easy Change Pizzo I/A Ceramix System - 16-3100
6. 0.5 mm 90° Pizzo Tip - 16-3103D
7. Plastic Eye Shield - 1100-429L
8. Thopce Caliper - 12-8400
9. Eye Shield Set - 18-8028
10. Serrhini - 14-8925
11. Castroviejo Retractor - 10-1701C
12. Trautman Scissors - 13-1510
13. Silicone Eye Spheres
14. Gill Verreas Scissors - 13-5415
15. Barnauer Speculum - T10-1010
16. Kaye Scissors - 1200-072
17. Tennant Forceps - 14-9570
18. Micro Alligator - 409-040
19. Sheppard Lens Forceps - T14-8940
20. Wilder Lens Loop - 12-4402
21. 20 Gauge Veterinary Scissors - 13-9000
22. Grife Fixation Forceps - 14-5122
23. Piton Spatula with Spoon - 12-4850
24. Reeh Strich Scissors - 13-9025
25. Jewellers Bipolar Nordeck - 2700-824
26. Anis Needle Holder - 15-3830
27. Jaffe Forceps - T14-8900



Sontec Instruments

A TRADITION OF FINE SURGICAL INSTRUMENTS

www.SontecInstruments.com

Colorado / USA / 800.821.7486



SONTEC INSTRUMENTATION OF EXPERTS

FINEST QUALITY IN THE INDUSTRY / AGGRESSIVE PRICING

1. Martez Dissector - 11-3420
2. Lasic Flap Spatula - 12-2860
3. Kelly Membrane Punch 1.0 mm - 11-9270
4. 0.12 Cobler with Angled Teeth - 14-2820
5. Fine Strich Scissors - 13-4800
6. Marshall 0.3 mm Forceps - T14-3000
7. Serrhini Clamp - 14-9240
8. Desmarres Lid Retractor - 10-4200
9. Maslet Capulathexis Forceps - 14-8384
10. Rizzuti Iris Retractor and Lens Expresor 2 mm - 12-4800
11. Castroviejo TC Needle Holder - 15-1910
12. Bishop Harmon Forceps 0.5 mm - T14-8905
13. Silicone Eye Sphers
14. Fomon Enucleation Scissors - 508-822
15. Micro Intraocular Biopsy Forceps - 14-7751
16. 7° Ceramic TC/PC Madsenbaum Scissors - 1200-915
17. Full Curved Iris Forceps 1 X 2.0 mm - 14-4655
18. Singer Capsule Squee/Pelster - T12-2900
19. Gemard Fixation 1 X 2 Forceps 0.5 mm - 14-5200E
20. Cook Speculum Medium - 10-1402
21. Grife Scissors - 199-550
22. Sevenn Clamp Medium - 14-9907
23. Eye Shield Plastic - 1100-429M
24. Suction Cup (for above lens) - 18-8028
25. Tissue Forceps Bipolar Nordeck - 2700-884NB



Sontec Instruments

A TRADITION OF FINE SURGICAL INSTRUMENTS

www.SontecInstruments.com

Colorado / USA / 800.821.7486

TAKAHASHI RONNGEURS

FINEST QUALITY IN THE INDUSTRY / AGGRESSIVE PRICING



1. Straight - 404-767 / 2.5 mm x 10 mm jaw cup / 4 1/2" (11.5 cm) shaft
2. Straight - 404-768 / 2.5 mm x 10 mm jaw cup / 5 1/2" (14 cm) shaft
3. Straight - 404-7675 / 3.5 mm x 10 mm jaw cup / 4" (10 cm) shaft
4. Straight - 404-7671 / 2.5 mm x 10 mm jaw cup / 5 1/2" (14 cm) shaft
5. Up-angled - 404-768U / 3 mm x 10 mm jaw cup / 4 1/2" (11.5 cm) shaft

Select from a variety of jaw sizes, angles and shaft lengths. Peapods offer the perfect jaw design for tight small and hard to navigate joint areas!

Sontec Instruments®

A TRADITION OF FINE SURGICAL INSTRUMENTS

Colorado / USA / 800.621.7486

www.SontecInstruments.com

NECESSARY SELECTIONS

FINEST QUALITY IN THE INDUSTRY / AGGRESSIVE PRICING



1. Westcott with wide grip - 13-3301
2. 0.5 Bishop Harmon - T14-3605
3. Ceramic Stevens - 1200-690
4. Jewelers #4 - 2200-0014
5. Barraquer - T10-1000
6. Barraquer - T10-1005
7. Colibri 0.12 fluted handle - 14-5395
8. Castroviejo speculum - 10-1700C
9. Dert TC - 132-354
10. 2.5 mm Burr - 11-4612
11. Easy Change Handle - 16-3100
12. 0.5 Blinkherst - 16-3107B
13. Strabismus Power Cut - 1200-023
14. Manhester 0.3 - T14-3060

Sontec Instruments®

A TRADITION OF FINE SURGICAL INSTRUMENTS

Colorado / USA / 800.621.7486

www.SontecInstruments.com

NEUROSURGICAL INNOVATION

BY THE LEADER IN INSTRUMENTATION / FINEST QUALITY IN THE INDUSTRY / AGGRESSIVE PRICING



1. Decker Rongeur 469-057
2. Sontec Tapered S-Retractor 207-417
3. Micro Axial Bayonet Scissors 2900-022
4. 3 mm Tumor Grasping Forceps 400-075
5. Jacob Bayonet Needle Holder TC Round Handle Curved Jaws 400-229
6. Bayonet Foreminotomy Kerison 404-468
7. Micro Axial New Large Gauge Handle Needle Holder 2900-004
8. Suction Monopolar Silver Non-Stick 2700-554NS

9. Neuro Jacobson Scissors 2400-6500
10. Dissector 412-550T
11. Axial Curette 320-886D
12. Dissecting Suction Elevator 478-360
13. Dissecting Suction Elevator 2700-310
14. Brain Spatula 2 mm 412-779
15. Elevator with Suction 478-375
16. Dissector Curette 412-547T
17. Dissector Wax Packer 412-549

Colorado / USA / 800.821.7496

Sontec Instruments®
A TRADITION OF FINE SURGICAL INSTRUMENTS

www.Sontecinstruments.com

Ceramitec

FINEST QUALITY IN THE INDUSTRY / AGGRESSIVE PRICING

Sontec's Ceramitec line of unique instrumentation is identified at first glance by its bold jet black surface with bright gold lettering for easy recognition and recording. Ceramitec is designed to reduce friction which prolongs the sharpness of a scissors' blades. Please visit Sontecinstruments.com to view all Ceramitec products. You may also request a printed catalog.



1. Bandage Scissors / 1200-680
2. Metzenbaum / 1200-615 3. Freeman / 1200-670
4. Dissector 45° / 413-003 5. Micro Hook / 413-010
6. 5 mm Hook 90° / 413-017 7. 7 mm Probe 45° / 413-018
8. Curved Dissecting Spatula / 413-004 9. Baby Metzenbaum / 1200-622
10. Ina Scissors / 1200-650 11. Metzenbaum 5 3/4" / 1200-611 12. Stevens 4 1/2" / 1200-630
13. JACOBY / 1200-640 14. Baby Metzenbaum Spread Handle / 1200-609 15. Stevens 4 1/4" / 1200-629
16. Westcott / 13-3004B 17. Stevens Spread Handle / 1200-605 18. Jacobson / 2400-603B

Sontec Instruments®

A TRADITION OF FINE SURGICAL INSTRUMENTS

Colorado / USA / 800.821.7496

www.Sontecinstruments.com

ELITE WIRELESS LED HEADLIGHT

FINEST QUALITY IN THE INDUSTRY / AGGRESSIVE PRICING



Wrap around rear cranial support on headband for added comfort. Removable if needed



Easy change battery fixture holds one battery while the backup is charging

Removable / sterilizable lever to safely adjust beam direction

Ideal color temperature at 4,500° K

Rheostat for spot variability 20-110 mm at 16"/40 cm working distance

100-5500

Rheostat control 0-30,000 Lux at 16"/40 cm working distance

Battery indicator / Low battery indicator

Sold with 2 batteries, each with 4 hours of power at 100% output and a lightweight carrying case

Designed to remove shadows in complex surgical operations

- Cardiovascular
- Orthopedic
- Spinal
- Abdominal

Sontec Instruments

UNIVERSAL KLICK KERRISON SET

FINEST QUALITY IN THE INDUSTRY / AGGRESSIVE PRICING

1. 5 mm 40° 404-6085
2. 3 mm 40° 404-6083
3. 2 mm 90° 404-6072
4. 1 mm 40° 404-6081
5. Endoscopic Shaft 2.5 mm 40° 404-6082SE
6. Bealy Foamotomy Curved Down 2 mm 40° 404-6082C
7. Bealy Foamotomy Curved Up 2 mm 40° 404-6082
8. Universal Klick Kerrison Handle 404-606
9. Bealy Foamotomy Curved Up 3 mm 40° 404-6083B
10. Endoscopic Shaft 3 mm 40° 12 1/2° 404-6088E
11. Endoscopic Shaft 3 mm 40° 404-6083EB
12. Bayonet Shaft 3 mm 40° 16° 404-6083B



- 360° 8-point rotation
- Built in ejector pin on all shaft designs

Sontec Instruments

A TRADITION OF FINE SURGICAL INSTRUMENTS

Colorado / USA / 800.821.7486

www.Sontecinstruments.com

Colorado / USA / 800.821.7486

A TRADITION OF FINE SURGICAL INSTRUMENTS

www.Sontecinstruments.com

Product update: **HEINE® LoupeLight 2**

With HEINE HR or HRP Binocular Loupes for a perfect view.

The combination of light and loupe delivers the ultimate in performance as high quality illumination with LED^{HQ} maximises the image quality of the loupe.

For a perfect view and a precise diagnosis, the LoupeLight 2 is now 25% brighter than its predecessor model, with a homogeneous edge-to-edge illumination of typ. 55,000 lux.

For intensive use, the LoupeLight 2 now features a replaceable connecting cord which connects the device to the mPack mini – the new and compact power source for the LoupeLight 2 (product description see overleaf).

NEW!
 ✓ Now 25% brighter due to improved LED technology
 ✓ Replaceable connecting cord



Replaceable connecting cord with high-quality splashproof threaded connector for heavy duty use.

Now even 25% brighter

LED^{HQ}
 LED NOW IN HEINE QUALITY.



HR 2.5x High Resolution Binocular Loupes. Achromatic optics for crisp, bright images.

Product update: **HEINE® MicroLight 2**

Ultralight, universal headlight.

For those who need a compact, lightweight illumination solution without magnification, we offer the MicroLight 2. Featuring LED^{HQ} illumination for homogeneous illumination with true and natural colour rendering for every examination situation. Two mounting options offer individuality and easy handling. Illumination without compromises, in a lightweight design.



HEINE MicroLight 2 on S-FRAME



HEINE MicroLight 2 on Lightweight Headband

See overleaf for ordering information.



HEINE® mPack mini – The compact and light power source for LoupeLight 2 and MicroLight 2.

The new, high performance power source HEINE mPack mini for LoupeLight 2 and MicroLight 2 offers freedom from cables that tie the users to desk, wall or static power sources. With a weight of just 95g and dimensions of 44 x 23 x 101 mm, this mobile power source is now approximately approx. 70% smaller and lighter than its predecessor.

The pouch, which is included in the delivery, can be attached to the belt. The mPack mini can also be charged whilst in the pouch. Thanks to the LI-Ion battery technology the power source has an operating time of typ. 9 hours, in continuous operation at maximum power typ. 4 hours. The mPack mini is flexible in charging due to its USB connector. Charge it via laptop, desktop or USB charger.

NEW!
 ✓ 70% smaller and lighter
 ✓ Operating time typ. 9 hours
 ✓ Charging time typ. 4 hours



USB charging option



Size comparison of HEINE mPack LL/mPack mini

LoupeLight 2 Sets with HR Binocular Loupes	
HR 2.5x optics with i-View on S-FRAME, LoupeLight 2, detachable yellow filter, mPack mini, mPack mini Belt Clip, E4-USB plug-in transformer, protective lenses, 2 sterilisable levers, retaining cord, cleaning fluid, cleaning cloth, carrying case	
340mm working distance	C-008.32.450
420mm working distance	C-008.32.451
520mm working distance	C-008.32.452
MicroLight 2 Sets	
MicroLight 2 on S-FRAME with mPack mini, mPack mini Belt Clip, E4-USB plug-in transformer, retaining cord and cleaning fluid in case	J-008.31.276
MicroLight 2 on Lightweight Headband with mPack mini, mPack mini Belt Clip, E4-USB plug-in transformer, case	J-008.31.277
Single Devices	
LoupeLight 2 for HR/HRP Loupes with i-View loupe mount	C-008.32.226
mPack mini with LI-ion rechargeable battery and E4-USB plug-in transformer	X-007.99.650
mPack mini with LI-ion rechargeable battery, without E4-USB plug-in transformer	X-007.99.649
Connecting cord SC1 (1.6m) for LoupeLight 2 or MicroLight 2/mPack mini	C-000.32.240

For further ordering information please contact your HEINE distributor **Sontec Instruments**

Sontec Instruments
 7248 S. Tucson Way
 Centennial, CO 80112
 USA Headquarters
 Heine USA



AUTHORIZED DEALER

HEINE Optotechnik GmbH & Co. KG, Kientalstr. 7, 82211 Herrsching, Germany
 Tel. +49 (0) 8152/38-0, Fax +49 (0) 8152/38-202, E-Mail: info@heine.com, www.heine.com



A-099020218 • 04/17
 We reserve the right to change specifications without notice.
 © 2018 HEINE Optotechnik GmbH & Co. KG. All rights reserved.

Index

T10-1000	32	T15-1912	126	10-1556	42
T10-1000C	32	T15-1913	126	10-1600	40
T10-1005	32	T15-1914	126	10-1660	42
T10-1010	32	T15-1915	126	T10-1660	42
T10-1048	37	T15-1916	126	10-1701C	40
T10-1701C	40	T15-1917	126	10-1702	40
T10-1703C	40	T15-3800	128	10-1703	40
T10-3825	46	T16-3100	91	10-1703C	40
T10-5480	51	T16-3103B	91	10-1704	41
T10-5487	51	T16-3103D	91	T10-1760	45
T10-5489	51	T16-3104	91	10-1800	45
T10-5491	51	10-1000	32	10-3100-SET	45
T12-1457	62	10-1000C	32	10-3140	45
T12-2860	65	10-1000C-13	32	10-3150	45
T12-5826	72	10-1005	32	10-3160	45
T12-5830	74	10-1005C	32	10-3170	45
T12-5831	74	10-1007	32	10-3180	45
T12-6467	79	10-1010	32	10-3190	45
T12-6930	77	10-1010C	32	10-3200	45
T12-6933	77	10-1010C-08	32	10-3210	45
T12-6935	77	10-1015	33	10-3220	45
T12-7030	75	10-1016	33	10-3310	46
T12-9101	78	10-1020	34	10-3312	46
T12-9102	78	T10-1020	34	10-3314	46
T12-9103	78	10-1030	34	10-3800	46
T12-9104	78	T10-1030	34	10-3810	46
T12-9106	78	10-1042	36	10-3820	46
T13-3417	98	10-1043	34	10-3825	46
T13-3418	98	10-1044	36	T10-3840	46
T14-1819	148	10-1045	36	10-4192	47
T14-1852	147	10-1046	36	10-4194	47
T14-2220	150	10-1047	37	10-4196	47
T14-2320	152	10-1048	37	10-4198	47
T14-2321	152	T10-1048	37	10-4200	47
T14-2323	152	10-1050	35	10-4201	47
T14-2800	150	T10-1051	35	10-4206	47
T14-2810	150	10-1053	35	10-4207	47
T14-2830	150	T10-1053	35	10-4210	47
T14-2840	150	10-1054	35	10-4211	46
T14-3552	148	T10-1054	35	10-4213	47
T14-3555	148	10-1055	35	10-4216	47
T14-3900	148	T10-1056	35	10-4218	47
T14-3910	148	10-1062	34	10-4220	47
T14-3920	148	10-1070	37	10-4221	46
T14-5376	164	10-1150	38	10-4223	47
T14-5500	159	10-1300	38	10-4226	47
T14-5894	162	10-1300S	38	10-4230	47
T14-6515	162	T10-1320	38	10-4231	46
T14-6516	162	10-1340	38	10-4233	47
T14-6805	144	10-1350	38	10-4236	47
T14-6820	144	10-1360	38	10-4240	47
T14-6830	144	10-1360H	38	10-4241	46
T14-6840	144	10-1400	39	10-4520	192
T14-6850	144	10-1401	39	10-4521	192
T14-6860	144	10-1402	39	10-4522	192
T14-9400	171, 172	10-1403	39	10-4525	192
T14-9990	171	10-1404	39	10-4530	192
T15-1800	124	10-1405	39	10-4531	193
T15-1810	124	10-1420	39	10-4535	192
T15-1820	124	10-1422	39	10-4540	192
T15-1830	124	10-1500	41	10-4600	44
T15-1860	124	10-1510	41	10-5400	50
T15-1861	124	10-1550	42	10-5480	51
T15-1880	124	10-1552	42	10-5487	51
T15-1881	124	10-1554	42	10-5489	51

10-5491	51	12-1405	68	12-3800	65
10-5500	47	T12-1405	68	12-4300	70
10-5520	47	12-1406	68	12-4310	70
10-5540	47	T12-1406	68	12-4330	70
10-5550	47	12-1407	62	12-4400	70
10-5552	48	T12-1407	62	T12-4400	70
11-1010	52	T12-1410	63	12-4402	70
11-3350	52	12-1415	63	12-4440	70
11-3400	52	T12-1415	63	12-4450	70
11-3419	52	T12-1420	63	12-4460	70
11-3420	52	12-1421	68	12-4480	70
11-3421	52	T12-1421	68	12-4550	71
11-3700	53	T12-1425	63	12-4600	71
11-3735	52	12-1430	63	12-4601	71
11-3750	53	12-1430L	63	12-4602	71
11-3760	53	T12-1440	63	12-4604	71
11-4560	56	T12-1442	64	12-4608	71
11-4600	56	T12-1445	68	12-4610	71
11-4601	56	T12-1455	62	12-4750	71
11-4609	56	T12-1460	68	12-5130	72
11-4610	56	T12-1480	64	12-5140	72
11-4611	56	T12-1482	64	12-5150	72
11-4612	56	12-2263	60	12-5160	72
11-4613	56	12-2264	60	12-5200	73
11-4614	56	12-2265	60	12-5210	73
11-4615	56	12-2266	60	12-5350	73
11-4616	56	12-2267	60	T12-5350	73
11-4617	56	12-2268	60	12-5390	73
11-4618	56	12-2269	60	12-5400	73
11-4700	54	12-2270	60	12-5410	73
11-4770	54	12-2271	60	T12-5410	73
11-4780	54	12-2273	60	12-5440	72
11-4800	54	12-2277	60	12-5450	72
11-4850	54	12-2279	60	12-5492	74
11-5200	55	12-2280	60	12-5520	74
11-5210	55	12-2281	60	T12-5520	74
11-9200	55	12-2282	60	12-5530	74
11-9270	55	12-2283	60	T12-5530	74
12-1195	60	12-2400	64	12-5550	74
12-1196	60	12-2410	64	12-5800	74
12-1197	60	12-2420	64	T12-5800	74
12-1198	60	12-2422	65	12-5810	74
12-1199	60	12-2600	65	T12-5810	74
12-1200	60	T12-2600	65	12-5820	74
12-1201	60	12-2610	65	T12-5820	74
12-1202	60	12-2620	65	12-5822	74
12-1205	60	12-2701	69	T12-5822	74
12-1225	60	T12-2701	69	12-5826	72
12-1245	60	12-2710	69	12-5830	74
12-1255	60	T12-2710	69	12-5831	74
12-1260	60	12-2711	69	12-5850	53
12-1261	60	T12-2711	69	T12-5850	53
12-1262	60	12-2720	73	12-5851	53
12-1263	60	T12-2720	73	12-5852	53
12-1285	56	12-2730	66	T12-5852	53
12-1290	56	12-2740	66	12-6300	72
12-1300	56	T12-2740	66	12-6310	72
12-1310	56	12-2800	66	12-6400	72
12-1320	56	12-2832	66	12-6410	72
12-1355	56	12-2835	66	12-6900	76
12-1360	56	12-2860	65	T12-6900	76
12-1365	56	12-2900	67	12-6910	77
12-1367	56	12-2930	67	12-6920	76
12-1368	56	12-2980	69	T12-6920	76
12-1400	62	12-2990	69	12-6925	76
T12-1400	62	12-3300	67	T12-6925	76
12-1402	62	12-3450	67	12-6930	76
T12-1402	62	12-3500	67	12-6935	77
12-1403	62	12-3510	67	12-7010	75

12-7020	75	13-3307S	97	13-7528	114
12-7025	75	13-3400	96	13-7530	114
12-7030	75	13-3401	96	13-7532	114
T12-7060	77	13-3402	96	13-7533	114
12-7100	75	13-3406	96	13-7550	110
12-7110	75	13-3420	92	13-7560	110
T12-7110	75	13-3425	92	13-7600	118
12-7120	77	13-3430	92	13-7610	118
12-7130	77	13-3435	92	13-7620	115
T12-7130	77	13-4300	98	13-7700	115
12-8500	79	13-4400	97	13-7710	115
T12-9100	78	13-4402	97	13-7715	115
T12-9105	78	13-4450	98	13-7720	114
12-9200	80	13-4450B	98	13-7730	114
12-9300	80	13-4450F	99	13-7740	116
12-9300D	80	13-4700	99	13-7750	116
12-9305	80	13-4710	99	13-7786	113
12-9310	80	13-4710F	99	13-8800	107
12-9310D	80	13-4740	99	13-8805	109
12-9315	80	13-4750	99	13-8810	107
12-9316	80	13-5200	102	13-8813	108
12-9318	80	13-5205	102	13-8814	108
12-9340	79	13-5300	100	13-8815	109
12-9400	81	13-5310	100	13-8820	109
12-9450	81	13-5312	100	13-8825	109
12-9500	81	13-5314	100	13-8850	107
12-9600	82	13-5320	100	13-8860	107
12-9630	82	13-5325	100	13-8863	107
13-1300	92	13-5330	100	13-8864	107
13-1300F	93	13-5348F	101	13-8865	109
13-1306	92	13-5349F	101	13-8866	109
13-1307	92	13-5370	101	13-9320	112
13-1310	92	13-5375	101	13-9330	112
13-1310F	93	13-5390	103	13-9340	110
13-1320	92	13-5395	103	13-9341	110
13-1320F	93	13-5398	103	13-9805	119
13-1330	92	13-5400	101	13-9810	119
13-1330F	93	13-5405	101	13-9820	119
13-1340	92	13-5405F	101	13-9822	119
13-1350	92	13-5410	101	14-1300	149
13-1500	93	13-5415	101	14-1310	149
13-1510	93	13-5415F	101	14-1340	149
13-1520	93	13-5422	101	14-1350	149
13-1520F	93	13-5520	100	14-1570	157
13-1530	93	13-5520F	100	14-1580	157
13-1530F	93	13-5521	100	14-1600	152
13-1840	94	13-5600	102	14-1610	152
13-1842	94	13-5605	102	14-1800	149
13-2300	94	13-5610	102	T14-1800	149
13-2310	94	13-5615	102	14-1820	148
13-2320	94	13-5700	102	T14-1820	148
13-2330	94	13-5700SL	102	14-1845	147
13-2500	94	13-5701	102	T14-1845	147
13-2500F	94	13-5710	102	14-1847	147
13-2520	94	13-5710B	102	14-1850	147
13-2520F	94	13-5711	102	T14-1850	147
13-2540	94	13-6800	122	14-1851	147
13-3140	95	13-6810	122	T14-1851	147
13-3150	95	13-6815	122	T14-2000	149
13-3160	95	13-7000	121	T14-2005	149
13-3162	95	13-7010	121	T14-2015	149
13-3300	95	13-7030	121	T14-2020	149
13-3300F	95	13-7035	121	T14-2025	149
13-3301	97	13-7500	114	14-2100	151
13-3303	98	13-7510	114	14-2110	151
13-3304	98	13-7520	114	14-2200	149
13-3304B	96	13-7522	114	T14-2200	149
13-3306	97	13-7524	114	14-2202	149
13-3307	97	13-7526	114	T14-2202	149

14-2206	149	14-3900	148	14-5396	160
T14-2206	149	14-3910	148	T14-5396	160
14-2220	150	14-3920	148	14-5500	159
T14-2300	152	14-3925	148	14-5510	159
14-2318	152	14-4300	158	T14-5510	159
14-2320	152	14-4305	158	T14-5525	156
14-2322	152	14-4310	158	T14-5527	156
14-2323	152	14-4340	158	T14-5530	156
14-2326	152	14-4345	158	14-5540	156
14-2600	153	14-4350	158	14-5545	156
14-2610	153	14-4400	152	14-5548	156
14-2620	153	14-4410	152	14-5560	156
14-2625	153	14-4415	152	T14-5560	156
14-2626	153	14-4440	152	14-5570	156
14-2627	153	14-4450	152	T14-5570	156
14-2628	153	14-4455	152	14-5700	159
14-2630	154	14-4600	155	T14-5700	159
14-2800	150	14-4620	155	14-5705	158
14-2805	150	14-4700	153	14-5710	159
T14-2805	150	14-4720	153	T14-5710	159
14-2810	150	14-4721	158	14-5715	158
14-2815	150	14-4723	153	14-5848	158
T14-2815	150	14-4725	158	14-5900	157
14-2820	150	14-4727	153	T14-5900	157
T14-2820	150	14-4800	155	14-5910	157
14-2830	150	14-5120	168	T14-5910	157
14-2840	150	14-5122	168	14-6301	165
14-2860	150	14-5130	168	14-6303	166
14-2880	150	14-5200	168	14-6310	167
14-2890	154	14-5205	168	14-6400	166
14-2905	151	14-5215	168	14-6415	166
14-2920	151	14-5220	168	14-6445	167
14-2922	151	14-5240	169	14-6450	167
14-2935	151	14-5285	156	14-6500	166
14-2955	151	14-5300	159	14-6510	166
14-3050	154	T14-5300	157	14-6515	162
T14-3050	154	T14-5301	157	14-6805	147
14-3060	154	14-5310	159	14-6810	144
T14-3060	154	T14-5310	157	14-6815	144
14-3070	154	T14-5311	157	14-6816	144
T14-3070	154	14-5320	159	14-6820	144
14-3071	154	T14-5320	157	14-6821	144
14-3072	154	14-5325	159	14-6830	144
14-3073	154	T14-5325	157	14-6831	144
14-3074	154	14-5330	164	14-6840	144
14-3075	154	T14-5330	156	T14-6841	145
14-3077	154	14-5350	164	14-6850	144
14-3150	155	14-5372	164	T14-6855	145
14-3152	155	T14-5372	164	T14-6855P	145
14-3154	155	14-5374	164	14-6870	144
14-3200	150	T14-5374	164	T14-6875	145
14-3210	150	14-5378	161	14-7310	165
14-3240	155	T14-5379	161	14-7320	165
14-3245	155	14-5381	161	14-7750	160
14-3246	155	T14-5381	161	14-7751	160
14-3247	155	14-5382	161	14-7762	163
14-3248	155	T14-5382	161	T14-7762	163
14-3260A	155	14-5383	161	14-7763	163
14-3260B	155	T14-5383	161	T14-7763	163
14-3260C	155	14-5383R	161	T14-7766	61
14-3260D	155	14-5384	160	T14-7767	61
14-3800	150	T14-5384	160	T14-7768	61
T14-3803	150	14-5385	160	14-7770	61
14-3805	150	T14-5385	160	T14-7770	61
T14-3805	150	T14-5387	160	14-8510	165
14-3810	150	14-5389	161	14-8900	163
T14-3810	150	T14-5391	161	14-8920	163
14-3850	157	14-5394	162	14-8940	163
14-3860	157	14-5395	162	14-8980	163

T14-8981	163	15-3300	130	16-2330	176
T14-9210	163	15-3310	130	16-2332	176
T14-9263	162	15-3320	130	16-2340	176
T14-9265	162	15-3330	130	16-2350	176
14-9300	164	15-3336	133	16-2360	176
14-9310	164	15-3337	133	16-2460	89
14-9320	164	15-3338	133	16-2470	89
14-9330	164	15-3339	133	16-2480	89
14-9400	172	15-3340	133	16-2500	89
14-9410	172	15-3350	132	16-2510	89
14-9600	173	15-3550	132	16-2520	88
14-9610	173	15-3560	132	16-2530	88
14-9700	168	15-3800	128	16-2530S	88
14-9725	171	15-3802	131	16-2540	88
14-9730	170	15-3810	128	16-2540S	88
14-9740	170	T15-3810	128	16-2541	88
14-9750	170	15-3812	131	16-2550	88
14-9800	170	15-3820	128	16-2550S	88
14-9850	170	T15-3820	128	16-2551	88
14-9870	171	15-3822	131	16-2560	88
14-9893	169	15-3830	128	16-2560S	88
14-9894	169	T15-3830	128	16-2561	88
14-9895	169	15-3832	131	16-2570	88
14-9900	169	T15-3840	137	16-2570S	88
14-9901	169	T15-3841	137	16-2571	88
14-9902	169	15-3860	130	16-2578	88
14-9906	169	15-3862	130	16-2579	88
14-9907	169	15-3864	130	16-2580	88
14-9908	169	15-3915	129	16-2581	88
14-9910	171	15-3920	129	16-2582	88
14-9920	171	15-3925	129	16-2583	88
14-9925	171	T15-3925	129	16-2584	88
14-9930	167	15-3930	129	16-2585	88
14-9935	82	T15-3930	129	16-2586	88
14-9940	82	15-3960	129	16-2587	88
14-9990	171	15-3961	129	16-2588	88
14-9992	171	15-3964	129	16-2589	88
15-1300	123	15-3965	129	16-2590	190
15-1300F	123	T15-3994	131	16-2592	190
15-1310	123	T15-3995	131	16-2594	190
15-1320	123	15-4000	132	16-2596	191
15-1320F	123	15-4001	132	16-2600	89
15-1330	123	15-4010	132	16-3100	91
15-1400	124	15-4011	132	16-3101A	91
15-1410	124	15-4070	123	T16-3101A	91
15-1420	124	15-4071	123	16-3101B	91
15-1430	124	15-4090	132	T16-3101B	91
15-1800	124	15-4092	132	16-3102A	91
15-1810	124	15-4094	132	T16-3102A	91
15-1820	124	15-4096	132	16-3102B	91
15-1830	124	15-4100	134	T16-3102B	91
15-1860	124	15-4110	134	16-3103A	91
15-1861	124	15-4120	134	T16-3103A	91
15-1880	124	15-4130	134	16-3103B	91
15-1881	124	16-2096	175	16-3103C	91
15-1900	126	16-2097	175	T16-3103C	91
15-1901	126	16-2098	175	16-3103D	91
15-1910	126	16-2099	175	16-3104	91
15-1911	126	16-2100	174	16-3107B	91
15-1912	126	16-2101	174	16-3111	91
15-1913	126	16-2102	174	T16-3112	91
15-1914	126	16-2103	174	16-3290	182
15-1915	126	16-2104	174	16-3300	182
15-1916	126	16-2105	174	16-3310	182
15-1917	126	16-2106	174	16-3314	182
15-1980	125	16-2207	177	16-3320	182
15-1982	125	16-2208	177	16-3330	182
15-2100	137	16-2209	177	16-3346	182
15-2105	137	16-2210	177	16-3348	182

16-3350	182	16-6070	185	105-574	27
16-3800	182	16-6075	185	105-575	27
16-3810	182	16-6085	183	105-576	27
16-3820	182	16-6086	183	105-577	27
16-3821	182	16-7000	189	105-578	27
16-3826	182	16-7010	189	105-579	27
16-3850	188	16-7050	188	105-580	27
16-3860	188	16-7095	188	105-581	27
16-3880	183	16-7100	188	105-590	27
16-3900	183	16-7200	186	105-600	27
16-3920	183	16-7210	186	105-602	27
16-3960	183	16-7230	186	105-610	27
16-3970	183	16-7240	187	105-612	27
16-3980	183	16-7245	187	105-614	27
16-4100	183	16-7250	187	105-616	27
16-4120	184	16-7260	187	105-618	27
16-4130	184	16-7270	187	105-620	27
16-4140	184	16-7275	187	105-622	27
16-4160	184	16-7280	187	105-624	27
16-4300	184	16-7290	187	105-626	27
16-4310	184	16-7295	184	105-628	27
16-4520	184	16-7296	184	105-630	27
16-4525	184	16-7300	187	105-632	27
16-4530	184	16-7330	187	105-640	27
16-4540	184	16-7340	188	105-642	27
16-4800	189	16-7350	185	105-644	27
16-4805	189	16-7355	185	105-646	27
16-4860	189	17-1000	181	105-650	27
16-4900	183	18-3120	11	105-652	27
16-4910	183	18-3121	11	105-654	27
16-4960	183	18-3122	11	105-656	27
16-4980	183	18-3123	11	105-660	27
16-5000	184	18-3209	15	105-662	27
16-5080	185	18-3213	13	105-664	27
16-5180	185	18-3214	13	105-666	27
16-5200	184	18-3215	13	105-670	27
16-5220	184	18-3270	15	105-672	27
16-5230	184	18-3505	6	105-674	27
16-5300-SET	181	18-3510	6	105-676	27
16-5310	181	18-3515	6	105-686	27
16-5320	181	18-3519	6	105-688	27
16-5321	181	18-3520	7	105-690	27
16-5330	181	18-3525	7	105-692	27
16-5331	181	18-3530	7	105-694	27
16-5340	181	18-3560	10	105-696	27
16-5400	185	18-8020	48	105-700	28
16-5420	186	18-8020B	48	105-702	28
16-5430	186	18-8022	48	105-704	28
16-5440	186	18-8022B	48	105-706	28
16-5450	186	18-8025	48	105-708	28
16-5460	186	18-8025B	48	105-710	28
16-5470	186	18-8026	48	105-712	28
16-5520	185	18-8026B	48	105-714	28
16-5530	185	18-8028	49	105-716	28
16-5660	188	18-8301	90	105-720	27
16-5670	188	23-1818	173	105-722	27
16-5680	188	105-540	27	105-723	27
16-5690	188	105-541	27	105-724	27
16-5740	186	105-542	27	105-725	27
16-5750	186	105-543	27	105-726	27
16-5800	186	105-544	27	105-727	27
16-5810	186	105-550	27	105-730	26
16-5820	186	105-551	27	105-732	26
16-5840	186	105-552	27	105-734	26
16-5940	185	105-553	27	105-736	26
16-5970	185	105-570	27	105-738	26
16-5980	185	105-571	27	105-742	26
		105-572	27	105-744	26
		105-573	27	105-746	26

105-748	26	199-522	117	440-378	82
105-750	26	199-524	117	440-380	82
105-780	26	199-535	118	440-382	82
105-781	26	199-545	118	467-436	71
105-782	26	205-819	50	467-438	71
105-783	26	205-820	50	467-440	71
105-784	26	205-822	50	467-440XS	71
105-785	26	205-824	50	469-036	86
105-786	26	205-826	50	469-040	86
105-787	26	205-828	50	469-048	86
105-789	26	205-830	50	469-050	86
105-790	26	205-844	50	475-151	111
105-791	26	205-846	50	475-153	111
105-791A	26	205-847	50	475-803	177
105-792	26	205-848	50	475-804	177
105-793	26	315-505	84	475-805	177
105-794	26	315-505C	84	475-806	177
105-796	26	315-505S	84	508-615	120
105-797	26	315-511	84	508-619	120
105-798	26	315-513	84	508-622	120
105-799	26	315-515	84	508-624	120
105-7951	26	315-559	85	1100-105T	141
112-478	115	315-580	85	1100-344	113
112-480	115	315-581	85	1100-346	113
112-602	122	325-130	11	1100-392	140
112-603	122	330-708	177	1100-407	167
115-585	82	330-708A	177	1100-409LG	49
115-586	82	330-817	176	1100-409MG	49
130-508	139	330-819	176	1100-409PG	49
132-348	138	345A-P16	30	1100-409SG	49
132-350	138	345A-PAG1	30	1100-411-10	180
132-352	138	345B-16	30	1100-411-11	180
132-354	138	345B-G1	30	1100-411-12	180
132-359	142	345F-CT1G	31	1100-411-13	180
132-360	142	345F-CT22	31	1100-411-14	180
132-361	142	345P-MX16	30	1100-411-15	180
132-362	142	345P-MXG1	30	1100-411-16	180
132-362D	142	345P-RP08	31	1100-411-17	180
132-362S	142	345P-RP22	31	1100-411-18	180
132-364	139	400-250	135	1100-411-19	180
132-364L	139	400-252	135	1100-411-20	180
132-364S	139	400-254	135	1100-411-21	180
132-365	139	400-256	135	1100-411-22	180
132-367	143	404-3902	87	1100-411-23	180
132-367A	143	412-445	75, 76	1100-412-24	180
132-375	139	412-445A	76	1100-412-26	180
132-376	139	412-766	59	1100-412-28	180
132-376S	139	412-767	59	1100-412-30	180
132-632	139	412-768	59	1100-412-33	180
132-634	139	412-769	59	1100-412-36	180
134-304	117	412-770	58	1100-412-38	180
134-305	117	412-771	58	1100-412-40	180
138-060	147	412-772	58	1100-412-43	180
138-065	147	412-773	58	1100-412-45	180
199-129	57	412-774	58	1100-412-47	180
199-130	57	412-775	58	1100-798	178
199-131	57	412-776	58	1100-798A	178
199-132	57	412-777	58	1100-798B	179
199-133	57	440-352	82	1100-798C	179
199-136	57	440-354	82	1100-798D	179
199-480	51	440-356	82	1100-798E	178
199-481	51	440-358	82	1100-798F	178
199-482	51	440-360	82	1100-798G	178
199-483	51	440-362	82	1100-798H	180
199-490	51	440-364	82	1100-798S	178
199-510	118	440-370	82	1103-400	90
199-515	118	440-372	82	1103-401	90
199-517	117	440-374	82	1103-500	182
199-520	117	440-376	82	1103-500A	182

1103-500B	182	1200-922	112	2600-845	83
1103-500C	182	1200-928	107	2600-846	83
1103-500D	182	1200-930	108	2600-847	83
1103-500E	182	1200-935	104	2600-848	83
1103-500F	182	1200-937	105	2600-849	83
1103-500G	182	1200-950	116	2600-8365	83
1103-500H	182	1200-952	116	2600-8395	83
1103-500J	182	1200-985	106	3451-B	31
1103-601	142	1200-986	106	9B-010	29
1103-604	142	1404-841	177	9B-020	29
1103-702	12	1404-841P	177	9B-025	29
1103-702D	12	2200-001	146	ST2	23
1103-703	12	2200-001T	145	ST3-926	22
1103-705	12	2200-002	146	ST3-927	22
1103-708	8	2200-003	146	ST3-929	22
1103-709	9	2200-003T	145	ST3-930	22
1103-710	12	2200-0006	146	ST6	21
1103-712	14	2200-007	146	ST6G	23
1103-715	12	2200-007T	147	ST8	21
1103-716	12	2200-0011T	145	ST10	21
1103-717	14	2200-0012	146	ST10-F	21
1103-717D	14	2200-0012T	145	ST10-F-PMT	22
1103-723	12	2200-013	146	ST12	21
1103-724	12	2200-0013T	145	ST13-F	21
1103-4001	90	2200-014	146	ST14G	23
1200-008	110	2300-020	136	ST14-K	25
1200-009	110	2300-022	136	ST15-20	21
1200-011	116	2300-024	136	ST15-F	21
1200-011C	116	2300-026	136	ST15-F-PMT	22
1200-018	112	2300-030	136	ST17-F	21
1200-019	112	2300-032	136	ST17-F-PMT	22
1200-020	113	2300-034	136	ST19-F	21
1200-021	113	2300-036	136	ST19-F-PMT	22
1200-022	113	2300-038	136	ST32-K	25
1200-023	113	2300-040	136	ST43	18
1200-025	115	2300-040S	136	ST43-2	18
1200-026	115	2300-042	136	ST52	24
1200-028	115	2300-042S	136	ST63	18
1200-050	107	2300-194	127	ST63-2	18
1200-052	107	2300-195	127	ST72-K	25
1200-062	108	2300-196	127	ST75	24
1200-064	108	2300-516	140	ST83	16
1200-070	122	2300-518	140	ST83-2	16
1200-072	122	2300-520	140	ST100	24
1200-076	122	2300-521	140	ST106	24
1200-406	111	2400-010	114	ST107	24
1200-408	111	2400-012	114	ST148	24
1200-409	111	2400-015	114	ST170-0	16
1200-490	108	2400-017	114	ST170-2	16
1200-491	108	2400-360	113	ST302-2	19, 20
1200-497	105	2400-362	113	ST402-2	18
1200-499	108	2400-364	109	ST602-2	18
1200-502	115	2400-365	106	ST952	16, 18
1200-503	115	2400-366	109	ST952-2	18
1200-700	107	2400-367	106	ST952D-2	16
1200-701	109	2400-373	121	ST953	16, 18
1200-702	107	2400-710	114	ST1002	18
1200-704	108	2400-711	115	ST1002-2	18
1200-705	109	2400-712	114	ST1082-2	18
1200-706	108	2400-713	115	ST1202	18
1200-708	104	2400-715	115	ST1202-2	18
1200-764	116	2400-717	115	ST1311-2	17, 19, 20
1200-766	116	2400-865	109	ST1650-2	18
1200-771	112	2400-867	109	ST2000-2	17, 19, 20
1200-773	112	2600-836	83	STE902	18
1200-775	113	2600-837	83	STE1082	18
1200-776	113	2600-839	83	STE1650	18
1200-776S	113	2600-840	83	STE1654	18
1200-920	112	2600-844	83	STE2302	18

STE2304 18
 STE06062 18
 STE06064 18
 STE06066 18
 STE10062 18
 STE10064 18
 STE10066 18
 STE12062 19, 20
 STE12064 19, 20
 STE12066 19, 20
 STE12102 19, 20
 STE12104 17, 19, 20
 STE12106 19, 20
 STE20122 19, 20
 STE20124 17, 19, 20
 STE20126 17, 19, 20
 STP12102 17
 STP12104 17
 STP20122 17
 STP20124 17
 STS12062 19, 20
 STS12064 19, 20
 STS12066 19, 20
 STS12102 19, 20
 STS12104 19, 20
 STS12106 19, 20
 STS20122 19, 20
 STS20124 19, 20
 STS20126 19, 20

A

AEBLI Corneal Scissors 121
 Agricola Lacrimal Retractor 47
 Air Injection Cannula 182
 Akahoshi Combo Pre-Chopper 61
 Algerbrush II Corneal Rust Ring Remover Burr 56
 Algerbrush II Pterygium Burr 56
 Alligator Sterilizing Rack 11
 Annis Irrigating Vectis Cannula 186
 Arrow Smith Corneal Fixation Forceps 148
 Arruga Capsule Forceps 165
 Atkinson Retrobulbar Needle Cannula 184
 Axial Capsulorhexis Utrata Forceps 160
 Azar Corneal Scissors 94

B

Baby Stratte Scissors 119
 Baird Chalazion Clamp Forceps 170
 Ball End Phaco Chopper 63
 Banaji Lasik Cannula 187
 Bansal Lasik Cannula 187
 Barraquer Anis Needle Holder 128
 Barraquer Cilia Forceps 166
 Barraquer Infant Wire Speculum 38
 Barraquer Iris Spatula 65
 Barraquer Keratoplasty Dissecting Knife 52
 Barraquer Medium Needle Holder Classic Model 131
 Barraquer Needle Holder 129
 Barraquer Needle Holder Long Classic Model 130
 Barraquer Needle Holder Titanium 131
 Barraquer Wire Speculum 32, 34
 Barraquer Wire Speculum Third Eye Lid 33
 Basin
 Emesis Basin 21

Beichert Lens Nucleus Rotator 69
 Beichert-Wilkie Spud/Rotator 53
 Beer Distichia Cilia Forceps 167
 Bergh Cilia Forceps 167
 Berke Ptosis Forceps 173
 Billeau Ear Loop/Curette 71
 Bin
 INSTRU-BIN 31
 Bishop-Harmon 1x2 Tissue Forceps 150
 Bishop-Harmon 1x2 Tissue Forceps Titanium 150
 Bishop-Harmon Irrigation Bulb Cannula Set 181
 Bishop-Harmon Serrated Dressing Forceps 157
 Blade Breaker Holder
 Castroviejo Blade Breaker Holder 54
 Castroviejo Blade Breaker Holder with Sliding Lock 54
 Sontec Micro Blade Breaker Holder 54
 Swiss Model Blade Breaker Holder 54
 Troutman-Castroviejo Mini Blade Breaker Holder 54
 Blair Hook Retractor 50
 Bodian Lacrimal Probe Set 191
 Bonaccolto Suture Forceps 166
 Bonn Micro Iris Hook 73
 Bonn Scissors 110
 Bonn Suture 1x2 Forceps 152
 Botvin Iris 1x2 Tissue Forceps 149
 Bowl
 Sponge Bowl 24
 Bowman Lacrimal Probe 88
 Bracken 1x2 Fixation Forceps 155
 Bracken Irrigating Cannula 185
 Air Injection Cannula 185
 Braun Fixed Caliper 79
 Brierley Lasik Irrigating Cannula 187
 Brush
 Whisk 'R Brush 29
 Bunge Evisceration Spoon 71
 Burr
 Algerbrush II Corneal Rust Ring Remover Burr 56
 Algerbrush II Pterygium Burr 56
 Burrato Lasik Cannula 187

C

Caliper
 Braun Fixed Caliper 79
 Castroviejo Caliper 80
 Jameson Caliper 81
 Stahl Caliper 82
 Thorpe Caliper 81
 Cannula
 Air Injection Cannula 182
 Annis Irrigating Vectis Cannula 186
 Atkinson Retrobulbar Needle Cannula 184
 Banaji Lasik Cannula 187
 Bansal Lasik Cannula 187
 Bracken Irrigating Cannula 185
 Brierley Lasik Irrigating Cannula 187
 Burrato Lasik Cannula 187
 Carter Lasik Cannula 187
 Chang Hydrodissection Cannula 184
 De La Vega Anterior Chamber Lens Pusher Cannula 185
 Dishler Lasik Cannula 186
 Drews-Knolle Irrigating Vectis Cannula 186

Drews Posterior Capsule Polisher Cannula 185
 Easy Change Phaco I/A Cannula System
 Stainless Steel 91
 Easy Change Phaco I/A Cannula System
 Titanium 91
 Fasanella Lacrimal Cannula 182
 Fukasaku Lasik Cannula 187
 Gans Severin Cycled Cannula 183
 Gillis Irrigating-Aspirating Cannula 189
 Gills-Welsh Aspirating Cannula 188
 Gimbel Lasik Fountain Cannula 187
 Gimbel Lasik Polishing Cannula 188
 Graether Collar Button Cannula 184
 Healon Aspirating Cannula 188
 Heslin Infusion Cannula 189
 Keats Infusion Handle 188
 Kelman Cyclodialysis Cannula 183
 Kelman Cystotome Cannula 183
 Knolle Kelman Cystotome Cannula 183
 Knolle Pearce Irrigating Vectis Cannula 186
 Kraff Posterior Capsule Polishing Curette Cannula 185
 Kratz Scratcher Cannula 184
 Kuglen Irrigating Lens Manipulator Cannula 185
 Lacrimal Cannula 182
 Lasik Cannula 186
 Lieppman Micro Cystotome Cannula 184
 Mancue Lasik Cannula 187
 McIntyre Anterior Chamber Irrigating Cannula 186
 McIntyre-Binkhorst Irrigating Cannula 186
 McIntyre Inner Cannula 184
 McIntyre Lacrimal Cannula 182
 McIntyre Reverse Cystotome Cannula 183
 Morrison Aspirating Cannula 188
 Osher 'J' Cannula 184
 Rainin Air Injection Cannula 183
 Randolph Cyclodialysis Cannula 183
 Severin Lacrimal Cannula 182
 Shahinian Lacrimal Cannula 182
 Sheets Cyclodialysis Cannula 183
 Sheets Irrigating Vectis Cannula 186
 Simcoe Cortex Veryctor Cannula 185
 Simcoe Irrigating-Aspirating Cannula 189
 Simcoe Nucleus Delivery Cannula 185
 Troutman Alpha-Chymotrypsin Cannula 183
 Vidaurri Cannula Cannula 185
 Welsh Cannula 184
 West Cannula 182
 Carter Lasik Cannula 187
 Castaneda Enucleation Clamp Forceps 173
 Castroviejo Blade Breaker Holder 54
 Castroviejo Blade Breaker Holder with Sliding Lock 54
 Castroviejo Caliper 80
 Castroviejo-Colibri Forceps 149
 Castroviejo Corneal Scissors 94
 Castroviejo Corneoscleral Scissors 92, 93
 Castroviejo Cyclodialysis Spatula 67
 Castroviejo Equine Eye Speculum 41
 Castroviejo Keratoplasty & Keratectomy Wide Handle Scissors 95
 Castroviejo Keratoplasty Scissors 95
 Castroviejo Lacrimal Dilator 89
 Castroviejo Lip Graft Clamp Forceps 171

Castroviejo Needle Holder 124, 126, 136
 Castroviejo Needle Holder with Scissors 125
 Castroviejo Suture 1x2 Teeth Forceps 150
 Castroviejo Synechia Spatula 67
 Castroviejo Tying Forceps 157
 Castroviejo Tying Forceps Titanium 157
 Catalano Lacrimal Intubation Set 190
 Catheter Tray & Dome Lid Cover 16
 Ceramic Coated Scissors 105
 Ceramitec Coated Scissors 107
 Ceramitec Iris Scissors 116
 Ceramitec Scissors 108
 Ceramitec Stevens Tenotomy Ergonomic Spread Handle Power Cut Black® Scissors 104
 Ceramitec Westcott Tenotomy Scissors 96
 Chang Combination Chopper / Micro Finger 62
 Chang Combination Chopper / Micro Finger 62
 Chang Hydrodissection Cannula 184
 Chang Micro Finger Hook 63
 Chopper
 Akahoshi Combo Pre-Chopper 61
 Ball End Phaco Chopper 63
 Chang Combination Chopper / Micro Finger 62
 Chang Combination Chopper / Micro Finger 62
 Claw Chopper 63
 Haefliger Phaco Chopper 63
 Nagahara Chopper 63
 Phaco Chopper 62
 Spherical Chopper 63
 Universal Pre-Chopper 61
 Verges Phaco Chopper 62
 Cicherelli Rongeur 85
 Cilia Forceps 166
 Cinelli lower lateral Scissors 120
 Clamp 171
 Castaneda Enucleation Clamp Forceps 173
 Castroviejo Lip Graft Clamp Forceps 171
 DeBakey-Dietrich Bulldog Clamp Titanium 83
 Dietrich Bulldog Clamp Titanium 83
 John Hopkins Bulldog Clamp 82
 Putterman Clamp Forceps 172
 Serrefine Bulldog Clamp 82
 Classic Castroviejo Eye Speculum 40
 Claw Chopper 63
 Cleaner
 Endozime AW Triple Plus 30
 F*A*C*T*S 31
 Premixslip 30
 Prepzyme 31
 Surgistain 30
 Colibri 1x2 Tissue Forceps 149
 Colibri Forceps 147
 Cook Eye Speculum 39
 Corneal Eye Shield 49
 Corneal Marker
 Lindstrom Arcuate Incision Marker 79
 Thornton Corneal Marker 78
 Cornell Lasik Sweep 68
 Cottle Columella Clamp Forceps 170
 Cover
 Stainless Steel Instrument Tray, Lid Cover & Perforated Nesting Sterilization

Instrument Tray 17
 Tip Cover 26
 Covers
 Catheter Tray & Dome Lid Cover 16
 Stainless Steel Instrument Tray & Lid Cover 18, 19, 20
 Crawford Lacrimal Intubation Set 190
 Cross-Action Nucleus Splitter Forceps 164
 CSU Wire Eye Speculum 36
 Culler Iris Spatula 64
 Culler Muscle Hook 76
 Culler Neuro Hook 75
 Cup
 Iodine Cup 23
 Medicine Cup 23
 Curette
 Billeau Ear Loop/Curette 71
 House Curette 57
 Meyerhoefer-Chalazion Curette 56

D

Davis Brain Black Silicon Spatula 59
 Davis Brain Spatula 58
 DeBakey-Dietrich Bulldog Clamp Titanium 83
 De La Vega Anterior Chamber Lens Pusher Cannula 185
 Deluxe Wire Speculum 37
 Depressor
 Schepens Scleral Depressor 46
 Scleral Depressor 46
 Derf Needle Holder 139
 Desmarres Chalazion Clamp Forceps 169
 Desmarres Lid Retractor 47
 Desmarres Severin Chalazion Clamp Forceps 169
 Dialer
 O'Gawa Lens Dialer 68
 Dietrich Bulldog Clamp Titanium 83
 Dilator
 Castroviejo Lacrimal Dilator 89
 Muldoon Lacrimal Dilator 89
 Pigtail Lacrimal Probe Dilator 89
 Wilder Lacrimal Dilator 89
 Direct Action Foldable Lens Forceps 162
 Dishler Lasik Cannula 186
 Dissector
 Martinez Corneal Dissector 52
 Troutman Sontec Corneal Dissector 52
 Double Action Needle Holder Titanium 137
 Dressing Jar 25
 Drews-Knolle Irrigating Vectis Cannula 186
 Drews Posterior Capsule Polisher Cannula 185
 Drysdale Nucleus Manipulator 53

E

Easy Change Phaco I/A Cannula System
 Stainless Steel 91
 Easy Change Phaco I/A Cannula System
 Titanium 91
 Elevator
 Freer Periosteal Elevator 178, 179, 180
 Joseph Periosteal Elevator 177
 Ellis Foreign Body 53
 Elschmig Cyclodialysis Spatula 67

Emesis Basin 21
 Endozime AW Triple Plus® 30
 Enucleation Scissors 119
 Ergonomic-Handle Bonn Suture Forceps 151
 Ergonomic-Handle Castroviejo Suture Forceps 151
 Ergonomic Handle Tennant Tying Forceps 156
 Ergonomic Handle Tying Forceps 156
 Erhardt Lid Clamp Forceps 168
 Eye Ribbone Retractor 50

F

F*A*C*T*S® 31
 Fasanella Lacrimal Cannula 182
 Fechtner Conjunctiva Ring Tip Forceps 162
 Fenzl Lens Manipulating Hook 74
 Fishkind Eye Speculum 42
 Fixation Hook 72
 Fixation Ring
 Thornton Globe Fixation Ring Titanium 79
 Flexible Neck Hook Retractor 50
 Flieringa Scleral Fixation Ring 45
 Floyd Barraquer Speculum 37
 Foerster Iris 1x2 Tissue Forceps 153
 Foerster Iris Dressing Forceps 158
 Foldable Lens Insertion Forceps 163
 Fomon Lateral Scissors 120
 Fomon Scissors 120
 Forceps
 Arrow Smith Corneal Fixation Forceps 148
 Arruga Capsule Forceps 165
 Axial Capsulorhexis Utrata Forceps 160
 Baird Chalazion Clamp Forceps 170
 Barraquer Cilia Forceps 166
 Beer Distichia Cilia Forceps 167
 Bergh Cilia Forceps 167
 Berke Ptosis Forceps 173
 Bishop-Harmon 1x2 Tissue Forceps 150
 Bishop-Harmon 1x2 Tissue Forceps Titanium 150
 Bishop-Harmon Serrated Dressing Forceps 157
 Bonaccolto Suture Forceps 166
 Bonn Suture 1x2 Forceps 152
 Botvin Iris 1x2 Tissue Forceps 149
 Bracken 1x2 Fixation Forceps 155
 Castaneda Enucleation Clamp Forceps 173
 Castroviejo-Colibri Forceps 149
 Castroviejo Lip Graft Clamp Forceps 171
 Castroviejo Suture 1x2 Teeth Forceps 150
 Castroviejo Tying Forceps 157
 Castroviejo Tying Forceps Titanium 157
 Cilia Forceps 166
 Colibri 1x2 Tissue Forceps 149
 Colibri Forceps 147
 Cottle Columella Clamp Forceps 170
 Cross-Action Nucleus Splitter Forceps 164
 Desmarres Chalazion Clamp Forceps 169
 Desmarres Severin Chalazion Clamp Forceps 169
 Direct Action Foldable Lens Forceps 162
 Ergonomic-Handle Bonn Suture Forceps 151
 Ergonomic-Handle Castroviejo Suture

Forceps	151
Ergonomic Handle Tennant Tying Forceps	156
Ergonomic Handle Tying Forceps	156
Erhardt Lid Clamp Forceps	168
Fechtner Conjunctiva Ring Tip Forceps	162
Foerster Iris 1x2 Tissue Forceps	153
Foerster Iris Dressing Forceps	158
Foldable Lens Insertion Forceps	163
Francis Chalazion Clamp Forceps	171
Gaskin Fragment Forceps	164
Gill Iris Tissue Forceps	149
Girard 1x2 Fixation Forceps	155
Girard Corneoscleral Forceps	150
Gradle Cilia Forceps	166
Graefe Fixation Forceps	168
Graefe Iris 1x2 Tissue Forceps	152
Graefe Iris Serrated Dressing Forceps	157
Green Fixation Forceps	168
Harms-Castroviejo Handle Tying Forceps	158
Harms-Colibri 1x2 Tissue Forceps	147, 148
Harms Tying Forceps	159
Heath Chalazion Clamp Forceps	170
Hoffman Lens Implant Forceps	165
Hoffman-Polack Corneal Pierce Teeth Forceps	148
Hoffman Utrata Capsulorhexis Forceps	161
Hunt Chalazion Clamp Forceps	170
Intraocular Grasping Forceps	160
Intraocular Micro Biopsy Forceps	160
IOL Inserting Lens Forceps	162
IOL Lens Cutter McKool Style Forceps	103
Iris 1x2 Tissue Forceps	152
Iris Dressing Forceps	158
Jameson Muscle Forceps	164
Jewelers #00 aka Cilia & Suture Removal Forceps	147
Jewelers Classic Forceps	144
Jewelers Forceps Titanium	147
Jewelers Forceps Titanium with Serrated Handle	145
Jewelers Precision Forceps	146
Jones Towel Clamp Forceps	171
Kansas Nucleus Removal Forceps	165
Kelman & Hoffer Suture Tissue Forceps	151
Kelman-McPherson 1x2 Tissue Forceps	154
Kelman-McPherson Tying Forceps	156
Knapp Trachoma Forceps	167
Kraff-Anis Lens Inserting Forceps	163
Kraff Lens-Holding Forceps	163
Lambert Chalazion Clamp Forceps	170
Lehner Capsulorhexis Forceps	162
Lester Fixation 1x2 Tissue Forceps	155
Littauer Cilia Forceps	165
Lordan Chalazion Clamp Forceps	171
Manhattan 1x2 Tissue Forceps	154
Manhattan Severin 1x2 Tissue Forceps	154
Masket Capsulorhexis Forceps	162
McPherson Corneal 1x2 Tissue Forceps	153
McPherson Tying Forceps	159
McPherson Tying Forceps Titanium	157

G

O'Gawa Tying Forceps	156
Osher Ultra Fine Tying Forceps	158
Pierse Corneal 1x2 Forceps	151
Pierse Hoskin Tissue Forceps	149
Polack Corneal Forceps	148
Putterman Clamp Forceps	172
Shepard Lens Holding Forceps	163
Shepard Lens-Holding Forceps	163
Snellen Entropion Clamp Forceps	171
Sontec-Bores Fixation Forceps	148
Sontec Eye Lid Forceps	169
Sontec-Micro Alligator Forceps	86
Stern-Castroviejo Suture 1x2 Tissue Forceps	154
Strabismus Forceps	155
Swiss Cilia Forceps	167
Tennant Tying Forceps	156
Troutman-Colibri Suture Forceps	151
Utrata Capsulorhexis Forceps	161
Utrata Kershner Capsulorhexis Cystotome Forceps	160, 161
Walter Splinter Forceps	147
Ziegler Cilia Forceps	167

H

Foreign Body	
Walter Corneal Foreign Body	53
Francis Chalazion Clamp Forceps	171
Francis Foreign Body	53
Freer Periosteal Elevator	178, 179, 180
Fukasaku Spatula	67
Fukasaku Hockey Knife	52
Fukasaku Lasik Cannula	187

I

Gans Severin Cycled Cannula	183
Gaskin Fragment Forceps	164
Gass Corneoscleral Punch	55
Gass Retinal Detachment Hook	77
Gauge	
Stahl A/C Lens Gauge	82
Gill Corneal Knife	52
Gill Iris Tissue Forceps	149
Gillis Irrigating-Aspirating Cannula	189
Gills-Vannas Scissors	101
Gills-Welsh Aspirating Cannula	188
Gil-Vernet Desmarres Retractor	46
Gimbel Lasik Fountain Cannula	187
Gimbel Lasik Polishing Cannula	188
Girard 1x2 Fixation Forceps	155
Girard Corneoscleral Forceps	150
Girard Synchiaie Spatula	66
Goldstein Lacrimal Retractor	48
Golf Club Foreign Body	53
Gouge	
Sontec Micro Gouge	177
Gradle Cilia Forceps	166
Gradle Scissors	118
Graefe Fixation Forceps	168
Graefe Iris 1x2 Tissue Forceps	152
Graefe Iris Serrated Dressing Forceps	157
Graefe Muscle Hook	75
Graether Collar Button Cannula	184
Graether Micro Iris Retractor	73
Grandon-Barraquer Wire Speculum	37
Greenberg Par Scissors	121
Green Fixation Forceps	168
Green Iris Spatula	65
Guimaraes Lasik Spatula	66

Gum Scissors	111
------------------------	-----

H

Haefliger Phaco Chopper	63
Handle	
Suction Cup Handle for Eye Shields	49
Harms-Castroviejo Handle Tying Forceps	158
Harms-Colibri 1x2 Tissue Forceps	147, 148
Harms Tying Forceps	159
Healon Aspirating Cannula	188
Heath Chalazion Clamp Forceps	170
Helveston Finder Hook	76
Helveston Muscle Hook	77
Helveston Teaser Hook	76
Helveston Tissue Retractor	51
Heslin Infusion Cannula	189
Hoffman Lens Implant Forceps	165
Hoffman-Polack Corneal Pierce Teeth Forceps	148
Hoffman Utrata Capsulorhexis Forceps	161
Stevens Tenotomy Hook	76

Hook

Bonn Micro Iris Hook	73
Chang Micro Finger Hook	63
Culler Muscle Hook	76
Culler Neuro Hook	75
Fenzl Lens Manipulating Hook	74
Fixation Hook	72
Gass Retinal Detachment Hook	77
Graefe Muscle Hook	75
Helveston Finder Hook	76
Helveston Muscle Hook	77
Helveston Teaser Hook	76
Jaffe Iris Hook	72
Jaffe-Knolle Iris Hook	73
Jameson Muscle Hook	75
Kirby Muscle Hook	77
Knolle Iris Hook	73
Kuglen Iris Hook & Lens Manipulator	74
Manson Triple Muscle Hook	77
Osher "Y" Hook Lens Manipulator	73
Rainin Micro Iris Hook	72
Rentsch Boat Hook	72
Rothchild Lasik Sweep and Hook	68
Scleral Fixation Twist Hook	72
Shepard Iris Hook	73
Sinskey II Lens Manipulating Hook	74
Sinskey Lens Manipulating Hook	74
Stevens Tenotomy Muscle Hook	76
Titanium Double Muscle Hook	77
Tyrell Iris Hook	72
Gass Retinal Detachment Hook	77

Hooks

Lewicky Lens Manipulator Hook	74
House Curette	57
Hunt Chalazion Clamp Forceps	170
Hyde Corneal Forceps	150

I

INSTRU-BIN	31
Instrument Tray	21
Intracapsular Manipulating Wand	68
Intraocular Grasping Forceps	160
Intraocular Micro Biopsy Forceps	160
Intraocular Scissors	102
Iodine Cup	23

IOL Inserting Lens Forceps	162
IOL Lens Cutter McKool Style Forceps	103
Iris 1x2 Tissue Forceps	152
Iris Classic Tungsten Carbide Power Cut Gold Power Cut Black TC/PC Scissors	114
Iris Dressing Forceps	158
Iris Scissors	99
Iris Stille Classic Large Cut Out Rings Scissors	113
Iris Stille Classic Large Rings Scissors	116
Irragating/Aspirating Handle	188

J

Jackson Lacrimal Intubation Set	190
Jacobi Micro Needle Holder	132
Jaeger Lid Plate	192
Jaeger Lid Plate with Wedge End	193
Jaffe Iris Hook	72
Jaffe-Knolle Iris Hook	73
Jaffe Lens Spatula	67
Jaffe-Stitch Scissors	99
Jaffe-Westcott Scissors	98
Jameson Caliper	81
Jameson Muscle Forceps	164
Jameson Muscle Hook	75
Jar	
Dressing Jar	25
Jewelers #00 aka Cilia & Suture Removal Forceps	147
Jewelers Classic Forceps	144
Jewelers Forceps Titanium	147
Jewelers Forceps Titanium with Serrated Handle	145
Jewelers Precision Forceps	146
John Hopkins Bulldog Clamp	82
Jones Towel Clamp Forceps	171
Joseph Periosteal Elevator	177

K

Kalt Needle Holder	137
Kansas Nucleus Removal Forceps	165
Katzin Corneal Transplant Scissors	94
Kaye Blepharoplasty Scissors	122
Kaye Needle Holder	138
Keats Infusion Handle	188
Kelly Descemets Membrane Punch	55
Kelman Cycloclodialysis Cannula	183
Kelman Cystotome Cannula	183
Kelman & Hoffer Suture Tissue Forceps	151
Kelman-McPherson 1x2 Tissue Forceps	154
Kelman-McPherson Tying Forceps	156
Kerrison Punch (Ocular-plasti) 40° Rongeur	175
Kerrison Punch (Ocular-plasti) 90° Rongeur	174
Kimura Platinum Spatula	65
Kirby Hook & Loop	70
Kirby Lens Loop	70
Kirby Muscle Hook	77
Kleinert-Kutz Rongeur	85
Knapp Rollet Hook Retractor	50
Knapp Trachoma Forceps	167
Knife	
Fukasaku Hockey Knife	52
Gill Corneal Knife	52
Tooke Corneal Knife	52

Troutman Corneal Knife	52
Von Graefe Needle	52
Knolle Iris Hook	73
Knolle Kelman Cystotome Cannula	183
Knolle Pearce Irrigating Vectis Cannula	186
Koch Nucleus Spatula	66
Kraff-Anis Lens Inserting Forceps	163
Kraff Lens-Holding Forceps	163
Kraff Posterior Capsule Polishing Curette Cannula	185
Kratz Aspirating Wire Speculum	34
Kratz-Barraquer Wire Speculum	35
Kratz Scratcher Cannula	184
Kuglen Iris Hook & Lens Manipulator	74
Kuglen Irrigating Lens Manipulator Cannula	185

L

Lacrimal Cannula	182
Lambert Chalazion Clamp Forceps	170
Lancaster Eye Speculum	40
Lasik Cannula	186
Lasik Flap Spatula	65
Lasik Spatula	64
Lehner Capsulorhexis Forceps	162
Lens Cutter	
Stolte IOL Lens Cutter Titanium	103
Lester Fixation 1x2 Tissue Forceps	155
Lester Lens Pusher	69
Lewicky Lens Manipulator Hook	74
Lewis Lens Loop	70
Lid Cover & Perforated Nesting Sterilization Instrument Tray	17
Lid Plate	
Jaeger Lid Plate with Wedge End	193
Lids	
Stainless Steel Instrument Tray & Lid Cover	19, 20
Lieberman Eye Speculum	43
Lieberman Speculum	44, 45
Lieppman Micro Cystotome Cannula	184
Lindstrom Arcuate Incision Marker	79
Lippman Sideport Nucleus Rotator	66
Littauer Cilia Forceps	165
Loop	
Billeau Ear Loop/Curette	71
Kirby Hook & Loop	70
Kirby Lens Loop	70
Lewis Lens Loop	70
Morrison Lens Loop & Probe	70
New Orleans Lens Loop	70
Wilder Lens Loop	70
Lordan Chalazion Clamp Forceps	171

M

Madox Lasik Spatula	66
Magnet	
Universal Magnet for Retrieval/Demagnetizing	177
Magnifier	
Optivisor Binocular Magnifier	90
Mallet	
Sontec Micro Mallet	176
Mancue Lasik Cannula	187
Manhattan 1x2 Tissue Forceps	154
Manhattan Severin 1x2 Tissue Forceps	154
Manipulator	

Kuglen Iris Hook & Lens Manipulator	74
Phaco Chopper Paddle Manipulator	62
Manson Triple Muscle Hook	77
Martinez Corneal Dissector	52
Masket Capsulorhexis Forceps	162
Mat	
Silicone Mat	11
Maumenee-Park Eye Speculum	45
McGuire Corneal Section Scissors	121
McIntyre Arterior Chamber Irrigating Cannula	186
McIntyre-Binkhorst Irrigating Cannula	186
McIntyre Infusion Handle	188
McIntyre Inner Cannula	184
McIntyre Lacrimal Cannula	182
McIntyre Reverse Cystotome Cannula	183
McIntyre Wire Speculum	36
McKee Eye Speculum	38
McNeill-Goldman Scleral Fixation Ring & Blepharostat	46
McPherson Corneal 1x2 Tissue Forceps	153
McPherson Needle Holder	123
McPherson Tying Forceps	159
McPherson Tying Forceps Titanium	157
McPherson-Vannas Iris Scissors	101
McPherson-Westcott Conjunctival Scissors	95
McPherson-Westcott Stitch Scissors	98
Medicine Cup	23
Medi-Mark™ Tape	28
Metal Micro Instrument Tray	6, 7
Meyerhoefer-Chalazion Curette	56
Micro Finger	
Chang Combination Chopper / Micro Finger	62
Chang Combination Chopper / Micro Finger	62
Micro Friedman Rongeur	84
Miller Skin Rake Retractor	51
Mini Barraquer Short Needle Holder	130
Morrison Aspirating Cannula	188
Morrison Lens Loop & Probe	70
Muldoon Lacrimal Dilator	89
Murdoch Eye Speculum	39

N

Nagahara Chopper	63
Needle	
Wright Fascia Needle	44
Needle Holder	
Barraquer Anis Needle Holder	128
Barraquer Medium Needle Holder Classic Model	131
Barraquer Needle Holder	129
Barraquer Needle Holder Long Classic Model	130
Barraquer Needle Holder Titanium	131
Castroviejo Needle Holder	126, 136
Castroviejo Needle Holder with Scissors	125
Derf Needle Holder	139
Double Action Needle Holder Titanium	137
Jacobi Micro Needle Holder	132
Kalt Needle Holder	137
Kaye Needle Holder	138
McPherson Needle Holder	123</

Mini Barraquer Short Needle Holder . . . 130
 Olsen-Webster Needle Holder 142
 Olsen-Webster Needle Holder Titanium
 141
 Par Needle Holder 143
 Sontec Barraquer X-Delicate Needle Holder
 134
 Sontec Extra Micro Needle Holder 135
 Troutman-Barraquer Needle Holder . . . 133
 Troutman Needle Holder 132
 Troutman-Sontec Needle Holder 132
 Webster Needle Holder 140
 Yamamoto Needle Holder 123
 Nevyas Wire Speculum 36
 New Orleans Lens Loop 70
 Non-Perforated Mayo Tray 22

O

O'Brien Stitch Scissors 117
 O'Gawa Lens Dialer 68
 O'Gawa Tying Forceps 156
 Olsen-Webster Needle Holder 142
 Olsen-Webster Needle Holder Titanium . 141
 Optivisor Binocular Magnifier 90
 Osher "J" Cannula 184
 Osher Ultra Fine Tying Forceps 158
 Osher "Y" Hook Lens Manipulator 73
 Osteotome
 West Osteotome 177

P

Par Needle Holder 143
 Paton Spatula & Spoon 71
 Paul Skin Rake Retractor 51
 Perforated Mayo Tray 22
 Phaco Chopper 62
 Phaco Chopper Paddle Manipulator . . . 62
 Pierser Corneal 1x2 Forceps 151
 Pierser Hoskin Tissue Forceps 149
 Pigtail Lacrimal Probe Dilator 89
 Polack Corneal Forceps 148
 Power Cut Black® 105, 107, 108
 Power Cut Gold 105, 107, 108
 Pre-Chopper 61
 Premixslip® 30
 Prepzyme® 31
 Probe
 Bowman Lacrimal Probe 88
 Punch
 Gass Corneoscleral Punch 55
 Kelly Descemets Membrane Punch . . . 55
 Pusher
 Lester Lens Pusher 69
 Putterman Clamp Forceps 172

R

Rainin Air Injection Cannula 183
 Rainin Micro Iris Hook 72
 Randolph Cyclodialysis Cannula 183
 Rentsch Boat Hook 72
 Retractor
 Agricola Lacrimal Retractor 47
 Desmarres Lid Retractor 47
 Eye Ribbone Retractor 50
 Flexible Neck Hook Retractor 50
 Gil-Vernet Desmarres Retractor 46

Goldstein Lacrimal Retractor 48
 Graether Micro Iris Retractor 73
 Helveston Tissue Retractor 51
 Knapp Rollet Hook Retractor 50
 Miller Skin Rake Retractor 51
 Paul Skin Rake Retractor 51
 Stevenson Lacrimal Retractor 47
 Blair Hook Retractor 50
 Ribbon-Handle Classic Iris Scissors . . 118
 Rongeur
 Cicherelli Rongeur 85
 Kerrison Punch (Ocular-plasti) 40° Rongeur
 175
 Kerrison Punch (Ocular-plasti) 90° Rongeur
 174
 Kleinert-Kutz Rongeur 85
 Micro Friedmann Rongeur 84
 Shearer Chickenbill Rongeur 84
 Sontec Dynamic Punch Rongeur 87

Rotator
 Bechert Lens Nucleus Rotator 69
 Bechert-Wilkie Spud/Rotator 53
 Lippman Sideport Nucleus Rotator . . . 66
 Rothchild Lasik Sweep and Hook 68
 Ryder-Castroviejo Needle Holder 127

S

Sauer Lid Speculum 38
 Schepens Scleral Depressor 46
 Schiotz Tonometer 90
 Iris Scissors 99
 Scissors
 AEBLI Corneal Scissors 121
 Azar Corneal Scissors 94
 Baby Stratte Scissors 119
 Bonn Scissors 110
 Castroviejo Corneal Scissors 94
 Castroviejo Corneoscleral Scissors . . . 92, 93
 Castroviejo Keratoplasty & Keratectomy
 Wide Handle Scissors 95
 Castroviejo Keratoplasty Scissors 95
 Ceramitec Iris Scissors 116
 Ceramitec Stevens Tenotomy Ergonomic
 Spread Handle Power Cut Black®
 Scissors 104
 Ceramitec Westcott Tenotomy Scissors
 96
 Cinelli lower lateral Scissors 120
 Enucleation Scissors 119
 Fomon Lateral Scissors 120
 Fomon Scissors 120
 Gills-Vannas Scissors 101
 Gradle Scissors 118
 Greenberg Par Scissors 121
 Gum Scissors 111
 Intraocular Scissors 102
 Iris Classic Tungsten Carbide Power Cut
 Gold Power Cut Black TC/PC Scis-
 sors 114
 Iris Scissors 99
 Iris Stille Classic Large Rings Scissors . 116
 Jaffe-Stitch Scissors 99
 Jaffe-Westcott Scissors 98
 Katzin Corneal Transplant Scissors . . . 94
 Kaye Blepharoplasty Scissors 122
 McGuire Corneal Section Scissors . . . 121
 McPherson-Vannas Iris Scissors 101

McPherson-Westcott Conjunctival Scissors
 95
 McPherson-Westcott Stitch Scissors . . 98
 O'Brien Stitch Scissors 117
 Ribbon-Handle Classic Iris Scissors . . 118
 Sontec Stitch Scissors 117
 Sontec-Vannas Scissors 101
 Stern-Gill Capsulotomy Scissors 101
 Stevens Siegert Tenotomy Scissors Double
 Beveled Blades 106
 Stevens Tenotomy Classic PC Gold Scis-
 sors 109
 Stevens Tenotomy Classic, Tungsten
 Carbide, Power Cut Gold, Power Cut
 Black®, Ceramitec Coated Scissors
 107
 Stevens Tenotomy Classic, Tungsten
 Carbide, Power Cut Gold, Power Cut
 Black®, Ceramic Coated Scissors . 109
 Stevens Tenotomy Ergonomic Spread
 Handle Power Cut Black Scissors
 104
 Stevens Tenotomy Ergonomic Spread
 Handle Tungsten Carbide Power Cut
 Black/Gold Scissors 105
 Stevens Tenotomy , Tungsten Carbide,
 Power Cut Gold, Power Cut Black®,
 Ceramic Coated Scissors 105
 Strabismus Baby Scissors 112
 Strabismus Classic Tungsten Carbide
 Power Cut Gold Power Cut Black
 Scissors 113
 Strabismus PC Ceramitec Scissors . . . 112
 Strabismus Ribbon-Handle Scissors . . 112
 Titanium Westcott Tenotomy Scissors . 98
 Troutman-Castroviejo Corneoscleral Scis-
 sors 93
 Troutman-Katzin Corneal Transplant Scis-
 sors 94
 Vannas Capsulotomy Scissors 100
 Vannas Scissors 100
 Walton Thorek Scissors 120
 Westcott Stitch Scissors 97
 Westcott Tenotomy Scissors 96, 98
 Westcott Wide Handle Conjunctival Scis-
 sors 97
 Westcott Wide Handle Tenotomy Scissors
 97
 Scissors
 Iris Stille Classic Large Cut Out Rings Scis-
 sors 113
 Scleral Depressor 46
 Scleral Fixation Twist Hook 72
 Serrefine Bulldog Clamp 82
 Set
 Bishop-Harmon Irrigation Bulb Cannula Set
 181
 Bodian Lacrimal Probe Set 191
 Catalano Lacrimal Intubation Set 190
 Crawford Lacrimal Intubation Set 190
 Jackson Lacrimal Intubation Set 190
 Severin Lacrimal Cannula 182
 Shahinian Lacrimal Cannula 182
 Shearer Chickenbill Rongeur 84
 Sheets Cyclodialysis Cannula 183

Sheets Irrigating Vectis Cannula 186
 Shepard Iris Hook 73
 Shepard Lens Holding Forceps 163
 Shepard Lens-Holding Forceps 163
 Silicone Eye Implants 180
 Silicone Mat 11
 Simcoe Cortex Veryctor Cannula 185
 Simcoe Irrigating-Aspirating Cannula . 189
 Simcoe Nucleus Delivery Cannula 185
 Sinskey II Lens Manipulating Hook 74
 Sinskey Lens Manipulating Hook 74
 Snellen Entropium Clamp Forceps . . . 171
 Sontec Barraquer X-Delicate Needle Holder.
 134
 Sontec-Bores Fixation Forceps 148
 Sontec Castroviejo Eye Speculum 40
 Sontec Dynamic Punch Rongeur 87
 Sontec Extra Micro Needle Holder 135
 Sontec Eye Lid Forceps 169
 Sontec Micro Alligator Forceps 86
 Sontec Micro Blade Breaker Holder 54
 Sontec Micro Gouge 177
 Sontec Micro Mallet 176
 Sontec Sheet Tape 27
 Sontec Slim Thermo Plastic Instrument Tray.
 15
 Sontec Stitch Scissors 117
 Sontec-Vannas Scissors 101
 Spatula
 Barraquer Iris Spatula 65
 Castroviejo Cyclodialysis Spatula 67
 Castroviejo Synechia Spatula 67
 Culler Iris Spatula 64
 Davis Brain Black Silicon Spatula 59
 Davis Brain Spatula 58
 Elschmig Cyclodialysis Spatula 67
 Fukasaka Spatula 67
 Girard Synechia Spatula 66
 Green Iris Spatula 65
 Guimaraes Lasik Spatula 66
 Jaffe Lens Spatula 67
 Kimura Platinum Spatula 65
 Koch Nucleus Spatula 66
 Lasik Flap Spatula 65
 Lasik Spatula 64
 Madox Lasik Spatula 66
 Wheeler Iris Spatula 64
 Speculum
 Barraquer Infant Wire Speculum 38
 Barraquer Wire Speculum 32, 34
 Barraquer Wire Speculum Third Eye Lid
 33
 Castroviejo Equine Eye Speculum 41
 Classic Castroviejo Eye Speculum 40
 Cook Eye Speculum 39
 Deluxe Wire Speculum 37
 Fishkind Eye Speculum 42
 Floyd Barraquer Speculum 37
 Grandon-Barraquer Wire Speculum 37
 Kratz Aspirating Wire Speculum 34
 Kratz-Barraquer Wire Speculum 35
 Lancaster Eye Speculum 40
 Lieberman Eye Speculum 43
 Lieberman Speculum 44, 45
 Maumenee-Park Eye Speculum 45
 McIntyre Wire Speculum 36
 McKee Eye Speculum 38

Murdoch Eye Speculum 39
 Nevyas Wire Speculum 36
 Sauer Lid Speculum 38
 Sontec Castroviejo Eye Speculum 40
 Tieck-Halle Infant Nasal Speculum 176
 Vienna Nasal Speculum 176
 Weiss Eye Speculum 42
 Williams Eye Speculum 41
 Spherical Chopper 63
 Sponge Bowl 24
 Spoon
 Bunge Evisceration Spoon 71
 Paton Spatula & Spoon 71
 Wells Enucleation Spoon 71
 Spud
 Bechert-Wilkie Spud/Rotator 53
 Drysdale Nucleus Manipulator 53
 Ellis Foreign Body 53
 Francis Foreign Body 53
 Golf Club Foreign Body 53
 ST15-20-PMT 22
 Stahl A/C Lens Gauge 82
 Stahl Caliper 82
 Stainless Steel Instrument Tray 17
 Stainless Steel Instrument Tray & Lid Cover .
 18, 19, 20
 Sterilizing Rack
 Alligator Sterilizing Rack 11
 Stern-Castroviejo Suture 1x2 Tissue Forceps
 154
 Stern-Gill Capsulotomy Scissors 101
 Stevenson Lacrimal Retractor 47
 Stevens Siegert Tenotomy Scissors Double
 Beveled Blades 106
 Stevens Tenotomy 105
 Stevens Tenotomy Classic 107, 108
 Stevens Tenotomy Classic PC Gold Scissors
 109
 Stevens Tenotomy Classic, Tungsten Car-
 bide, Power Cut Gold, Power Cut
 Black, Ceramic Coated Scissors. 109
 Stevens Tenotomy Ergonomic Spread
 Handle Power Cut Black Scissors . . 123
 Stevens Tenotomy Ergonomic Spread
 Handle Tungsten Carbide Power Cut
 Black/Gold Scissors 105
 Stevens Tenotomy Hook 76
 Stevens Tenotomy Muscle Hook 76
 Stolte IOL Lens Cutter Titanium 103
 Strabismus Baby Scissors 112
 Strabismus Classic Tungsten Carbide Power
 Cut Gold Power Cut Black Scissors .
 113
 Strabismus Forceps 155
 Strabismus PC Ceramitec Scissors . . . 112
 Strabismus Ribbon-Handle Scissors . . 112
 Suction Cup Handle for Eye Shields . . . 49
 Surgistain® 30
 Sweep
 Cornell Lasik Sweep 68
 Rothchild Lasik Sweep and Hook 68
 Swiss Cilia Forceps 167
 Swiss Model Blade Breaker Holder 54

T

T10-1010C 32
 T10-1013 33

T10-1014 33
 T10-1015 33
 T10-1016 33
 T10-1300S 38
 T12-1475 69
 T12-2980 69
 T12-2990 69
 T12-5210 73
 T12-5390 73
 T12-9100-2 78
 T12-9300 80
 T13-1320 92
 T13-1330 92
 T14-1845W 147
 T14-1847 147
 T14-2201 149
 T14-2322 152
 T14-2625 153
 T14-2955 151
 T14-3071 154
 T14-3072 154
 T14-3073 154
 T14-3074 154
 T14-3075 154
 T14-3077 154
 T14-3550 148
 T14-3800 150
 T14-4440 152
 T14-5200 168
 T14-5220 168
 T14-5395 162
 T14-5548 156
 T14-6303 166
 T14-6400 166
 T14-6500 166
 T14-6510 166
 T14-6816 144
 T14-7310 165
 T14-9850 170
 T14-9906 169
 T14-9907 169
 T14-9908 169
 T14-9909 169
 T15-1320 123
 T15-1320R 123
 T15-1330 123
 T15-1330R 123
 T15-1980 125
 T15-1982 125
 T15-3802 131
 T15-3812 131
 T15-3822 131
 T15-3832 131
 T15-3920 129
 T15-4100 134
 T15-4105 134
 T15-4110 134
 T15-4115 134
 T15-4120 134
 T15-4125 134
 T15-4130 134
 T15-4135 134
 T18-8023 48
 Tape
 Medi-Mark™ Tape 28
 Sontec Sheet Tape 27
 Tennant Tying Forceps 156
 Thermoplastic Instrument Tray 12, 13
 Thermoplastic Instrument Trays 14
 Thornton Corneal Marker 78

Thornton Globe Fixation Ring Titanium . . . 79	Walton Thorek Scissors 120
Thorpe Caliper 81	Webster Needle Holder 140
Tieck-Halle Infant Nasal Speculum 176	Weiss Eye Speculum 42
Tip Cover 26	Wells Enucleation Spoon 71
Titanium Double Muscle Hook 77	Welsh Cannula 184
Titanium Westcott Tenotomy Scissors . . . 98	West Cannula 182
Tonometer	Westcott Stitch Scissors 97
Schiotz Tonometer 90	Westcott Tenotomy Scissors 96, 98
Tooke Corneal Knife 52	Westcott Wide Handle Conjunctival Scissors . 97
Tray	Westcott Wide Handle Tenotomy Scissors . . 97
Catheter Tray & Dome Lid Cover 16	West Osteotome 177
Instrument Tray 21	Wheeler Iris Spatula 64
Metal Micro Instrument Tray 6, 7	Whisk 'R Brush™ 29
Non-Perforated Mayo Tray 22	Wilder Lacrimal Dilator 89
Perforated Mayo Tray 22	Wilder Lens Loop 70
Sontec Slim Thermo Plastic Instrument Tray 15	Williams Eye Speculum 41
Stainless Steel Instrument Tray, Lid Cover & Perforated Nesting Sterilization Instrument Tray 17	Wright Fascia Needle 44
Thermoplastic Instrument Tray 12, 13	
Thermoplastic Instrument Trays 14	
Universal Surgery Tray 10	
Trays	
Stainless Steel Instrument Tray & Lid Cover . 18	
Trident Splitter 69	
Troutman Alpha-Chymotrypsin Cannula. 183	
Troutman-Barraquer Needle Holder . . . 133	
Troutman-Castroviejo Corneoscleral Scissors . 93	
Troutman-Castroviejo Mini Blade Breaker Holder 54	
Troutman-Colibri Suture Forceps 151	
Troutman Corneal Knife 52	
Troutman-Katzin Corneal Transplant Scissors . 94	
Troutman Needle Holder 132	
Troutman Sontec Corneal Dissector 52	
Troutman-Sontec Needle Holder 132	
Tungsten Carbide 105, 107, 108	
Tyrell Iris Hook 72	

U

Universal Magnet for Retrieval/Demagnetizing 177
Universal Pre-Chopper 61
Universal Surgery Tray 10
Utility Scissors 110
Utrata Capsulorhexis Forceps 161
Utrata Kershner Capsulorhexis Cystotome Forceps 160, 161

V

Vannas Capsulotomy Scissors 100
Vannas Scissors 100
Verges Phaco Chopper 62
Vidaurre Cannula Cannula 185
Vienna Nasal Speculum 176
Von Graefe Knife Needle 52
Von Graefe Needle 52

W

Walter Corneal Foreign Body 53
Walter Splinter Forceps 147

Y

Yamamoto Needle Holder 123

Z

Ziegler Cilia Forceps 167



Bringing the Highest Quality Surgical
Instrumentation to the World since 1970



Sontec Instruments®

A TRADITION OF FINE SURGICAL INSTRUMENTS

Sontec Instruments, Inc.
7248 South Tucson Way
Centennial, Colorado 80112 USA
Toll-free / 800.821.7496
Local / 303.790.9411
Fax / 303.792.2606

SontecInstruments.com