



 Sontec Instruments®

ORTHOPEDIC

Dear Customer,

Sontec Instruments, Inc. is a family owned & operated medical company, providing personalized service featuring the finest in surgical instrumentation for over half a century.

Our surgical instruments encompass the entire human anatomy including specialty products specific to small and large animal surgery.

Owner of Sontec Instruments, Dennis Russell Scanlan III and his sons, Johann, Stefan and Angus Scanlan bring with them a lifetime of experience creating the highest quality products made by the world's leading manufacturing facilities featuring, cutting edge robotic technology, handmade workmanship combined with an understanding how to make exactly what our valued customers have come to expect.

Dennis R. Scanlan, III President & CEO and his wife Caron C. Scanlan thank you, for the opportunity to present our specialty Ophthalmology catalog.

Sincerely,



Dennis Russell Scanlan III

## Table of Contents

Important Information . . . . .	4
STORAGE CASES & CLEANING . . . . .	9
KNIFE & BLADE Handles . . . . .	43
CALIPERS & RULERS . . . . .	51
ALLIGATOR BIOPSY FORCEPS . . . . .	59
FORCEPS Flat Handle . . . . .	97
Ligature Carriers . . . . .	161
Micro HAND SURGERY . . . . .	167
Neuro HOOKS . . . . .	177
Neuro RASPATORY . . . . .	189
Neuro Spinal DISSECTORS . . . . .	193
Neuro Spinal ELEVATORS . . . . .	199
Neuro Spinal PROBES . . . . .	205
Caspar RETRACTORS & DISTRATORS . . . . .	209
Brain SPATULAS . . . . .	235
Nerve RETRACTORS . . . . .	243
Rhoton Jacobson Curette & Dissector Hook Set . . . . .	253
Spinal RASPS . . . . .	259
Spinal RETRACTORS . . . . .	263
SUCTION Selection . . . . .	283
Orthopedic BONE HOLDING CLAMPS . . . . .	317
Orthopedic BONE REDUCTION CLAMPS . . . . .	337
Orthopedic CARTILAGE CLAMPS . . . . .	357
Orthopedic CURETTES . . . . .	365
Orthopedic ELEVATORS . . . . .	373
Orthopedic GOUGES . . . . .	383
Orthopedic OSTEOTOMES . . . . .	389
Orthopedic MALLETS . . . . .	403
Orthopedic MENISCOTOMES & KNIVES . . . . .	415
Orthopedic PIN-PULLERS, DRIVERS & BENDERS . . . . .	421
Orthopedic PLATE BENDERS & BENDING IRONS . . . . .	431
Orthopedic RETRACTORS . . . . .	439
Orthopedic Spinal LAMINA SPREADERS . . . . .	481
Orthopedic ROD HOLDERS & BENDERS . . . . .	489
Orthopedic SCREWDRIVERS . . . . .	497
Orthopedic DRILLS, DRILL GUIDES & CHUCKS . . . . .	503
Orthopedic SPECIALTY . . . . .	517
Orthopedic Spinal Neuro CURETTES . . . . .	529
Orthopedic TREPHINE . . . . .	549
Orthopedic VISE GRIP PLIERS . . . . .	555
Orthopedic WIRE PASSERS . . . . .	561
Orthopedic WIRE PIN CUTTERS . . . . .	567
Orthopedic WIRE TWISTERS . . . . .	585
ARTHROSCOPIC . . . . .	595
Bone & NAIL CUTTING Forceps . . . . .	655
Kerrison RONGEURS . . . . .	667
Pistol Grip RONGEURS . . . . .	697
Orthopedic DOUBLE ACTION RONGEURS . . . . .	723
Orthopedic SINGLE ACTION RONGEURS . . . . .	739
RASPS 755	
Headlights & Cameras . . . . .	777
Index	784

## IMPORTANT INFORMATION

### Guarantee & Repairs Policy

Sontec® surgical instruments are guaranteed to be free of defects in materials and workmanship. Any Sontec® instrument that is defective will be repaired or replaced at our discretion. Instruments not properly cared for, used for unintended purposes, or beyond their designed capacity will not be covered under this guarantee. Our liability under this guarantee is limited to the repair or replacement of the defective merchandise.

Sontec® has its own repair department where most mechanically functional instruments can be returned to like-new condition.

Sontec® performs a variety of repairs, such as replacing worn TC jaws or sharpening scissors. In addition, we complete a comprehensive evaluation of your instruments to determine if further service is required.

For repair service, please send the following directly to the address below:

- Instruments clean, sterilized, securely wrapped and carefully packaged.
- Purchase and/or repair order
- A note with contact and shipping information
- Sending multiple items eliminates \$50 minimum charge

### Return Policy

The return of new, unused instruments in their original packaging is accepted within 30 days of purchase with an authorized "Return Merchandise Authorization". Please contact Sontec directly by phone or email with your invoice or proof of purchase in order to obtain your RMA slip and instructions. Restocking fee applies and credit will not be issued for shipping charges or handling fees. Proper credit is not guaranteed without an RMA. Custom, Special Order or Modified items are non-returnable.

Sontec Instruments, Inc.  
Toll free: 800.821.7496  
Local: 303.790.9411  
returns@sontecinstruments.com

### Remember

Sontec® offers other catalogs for a variety of surgical instrumentation, including:

- Alligator, Grasping, & Biopsy Forceps
- Avian & Exotic
- Bandage Scissors
- Cardiovascular & Thoracoscopic
- Caspar & Cloward Retractor Systems
- Colon & Rectal
- Cranial Cruciate Ligament Lateral Suture

- System
- Equine (Arthroscopic)
  - Eye
  - Neurology & Orthopedic
  - Orthopedic & Arthroscopic
  - Urology
  - Veterinary Dental
  - Veterinary Eye
  - General Veterinary Instrumentation

Also, if you do not find what you are looking for, please contact us.

### Instrument Care

Designed and crafted to exacting specifications, surgical instruments will perform for a number of years, provided they are maintained correctly and used for their intended purpose. A strict maintenance schedule will help reduce the need for premature replacements, thus cutting costs. For proper safeguarding of surgical instruments, please read and share the following information.

- Never substitute sterilization for cleanliness
- Wash brand new instruments prior to the first sterilization
- Remove saline solution, bleach, blood and tissue from instruments quickly and thoroughly
- Always use distilled water for cleaning instruments
- Never use saline solution for cleaning instruments
- Prevent cross-corrosion by separating corroded instruments from other instruments
- Never autoclave econo-grade stainless with superior-grade stainless.
- Always autoclave instruments with box lock open to alleviate pressure at the joint and to prevent fracture
- Lubricate joint and box lock after cleaning with an anti-microbial, water soluble lubricant
- Protect the tips of delicate instruments with protective covers (see page a.)
- Never use an instrument for anything other than its intended use

### Additional Safeguarding Guidelines

#### Scissors and Other Blades

- Perform routine inspections for sharpness, as a blade becomes duller with each stroke (all operating and Mayo scissors should be able to cut through four layers of gauze)
- When blades no longer cut without an excessive amount of force, please return them to Sontec® for sharpening
- The more often a blade is sharpened, the longer it tends to last

#### Needle Holders

- Repair is necessary when needle holder no longer securely holds needle when locked on the second ratchet tooth, and needle turns easily by hand

### Please Note

- We are not responsible for typographical errors in this catalog
- Instruments pictured in this catalog may or may not be to size
- Variations and changes in instrument design are possible
- Pricing is subject to change without notice
- Delivery schedules may vary from original estimates
- Some items are for veterinary use

### Contact Info

Sontec Instruments, Inc.  
7248 South Tucson Way  
Centennial, Colorado 80112, USA  
Toll free: 800.821.7496  
Local: 303.790.9411  
service@sontecinstruments.com  
www.sontecinstruments.com

## Troubleshooting Guide

Problem	Cause	Solution
Rust	Worn chrome plating on brass instruments	Be aware of plating condition and remove from service when wear is visible.
	Cross-corrosion from carbon instruments to stainless steel	Keep carbon steel and stainless steel instruments separated during cleaning and sterilization.
	Low grade instruments may not have been passivated	Remove from service.
	Autoclave not operating properly	Clean and thoroughly flush water lines in sterilizer according to manufacturer's instructions. Only use distilled water, never tap water, to generate steam.
	Organic matter left on instrument after surgery	Remove all blood and tissue before drying. Use distilled water and a nylon brush to clean hard to reach areas.
Pitting	Prolonged exposure to corrosive chemicals and/or organic substances	Only use approved cleaning and sterilization solutions. Thoroughly rinse and dry instruments.
Orange / Brown Stains	Contaminated sterilizer, high alkaline detergent, cold disinfectants	Clean sterilizer. Use neutral pH solutions. Thoroughly clean, rinse, and dry instruments.
Bluish Black Stains	Mixing dissimilar metals during cleaning and sterilization	Separate carbon steel, aluminum, and stainless steel instruments.
Rainbow - olored Stains	Chromium oxide stain-result of excessive heat	Send in for polishing and hardness check.
Cracked Box Lock	Excessive force, sterilized in the closed position	Replace the instrument.
Cracked Jaw on Pin Cutter	Cutting pin at tip of jaws	Replace the instrument. Cut pin in center of jaws.

Conversion Table

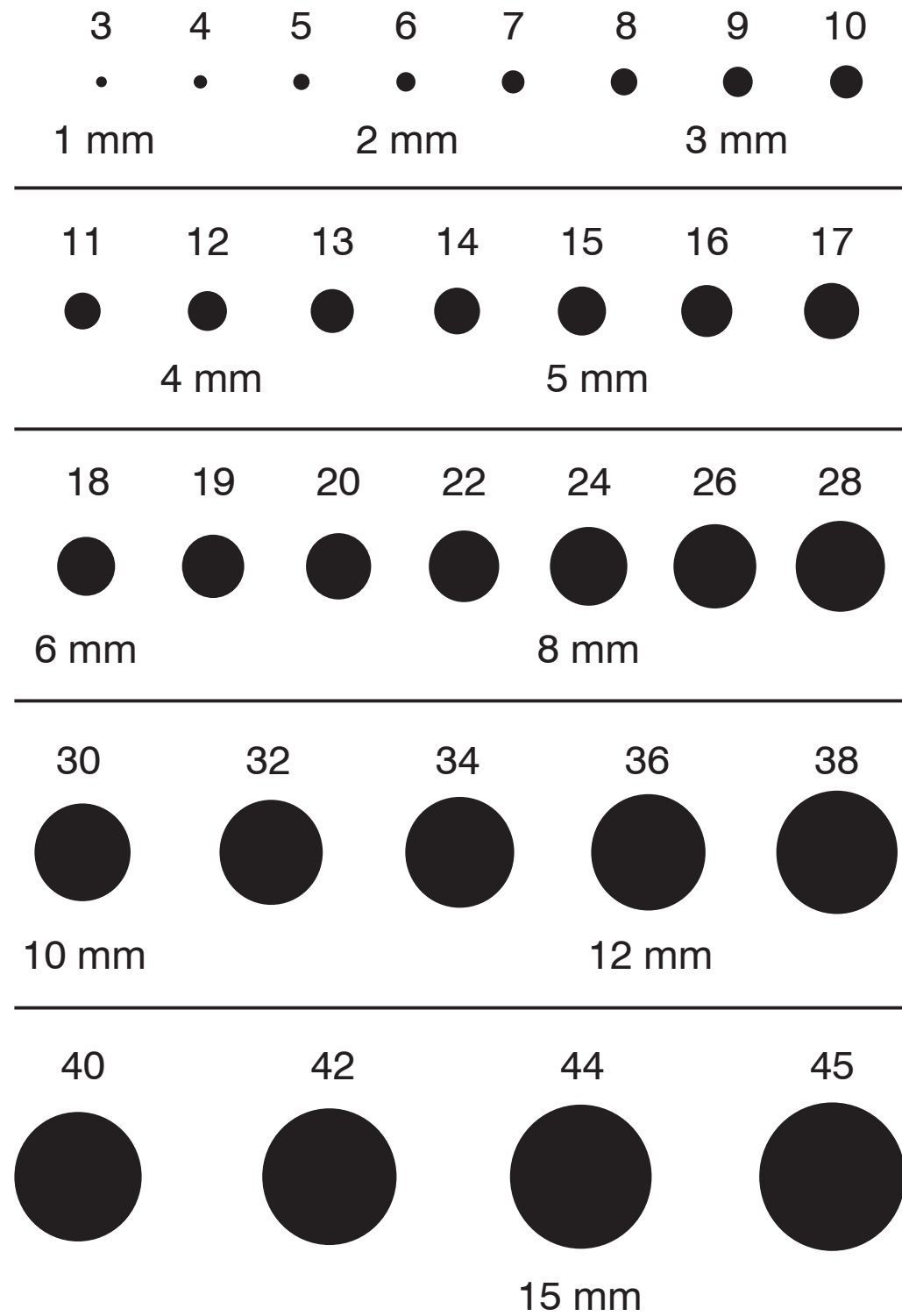

Conversion Table

Multiply	By	To Obtain
Millimeters	0.1	Centimeters
Millimeters	0.03937	Inches
Centimeters	0.3937	Inches
Centimeters	0.01	Meters
Centimeters	10	Millimeters
Inches	2.540	Centimeters
$1/8'' = 3.175$ millimeters		
$1/4'' = 6.350$ millimeters		
$3/8'' = 9.525$ millimeters		
$1/2'' = 12.70$ millimeters		
$1'' = 25.40$ millimeters		

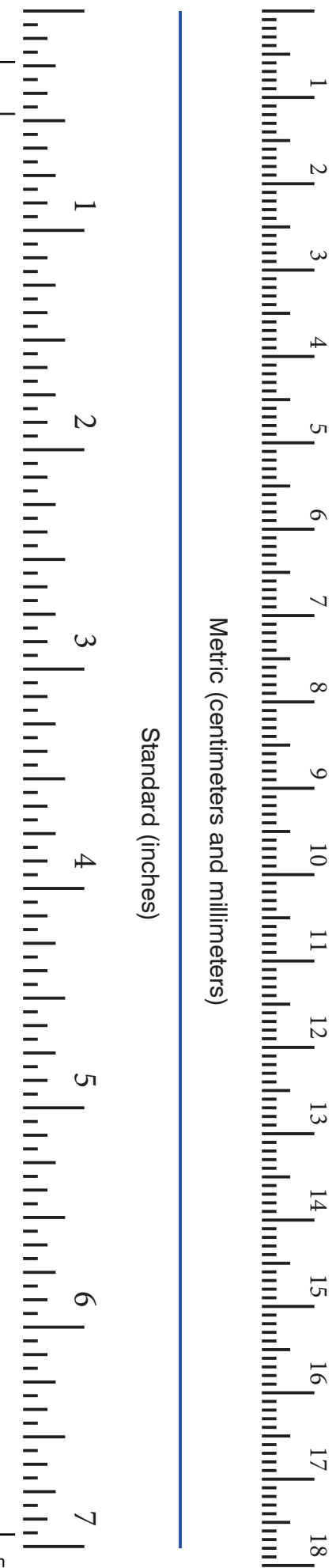

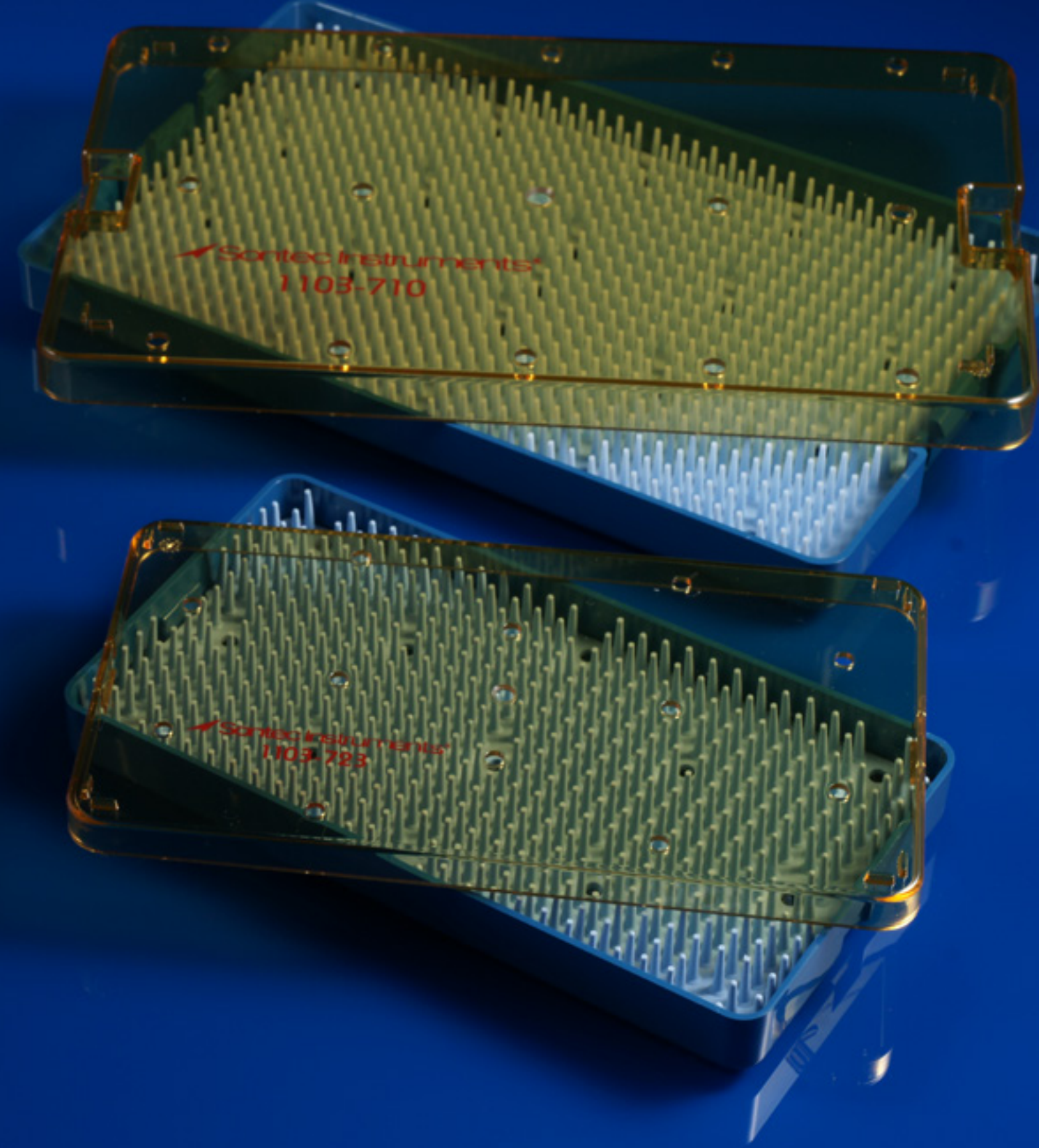
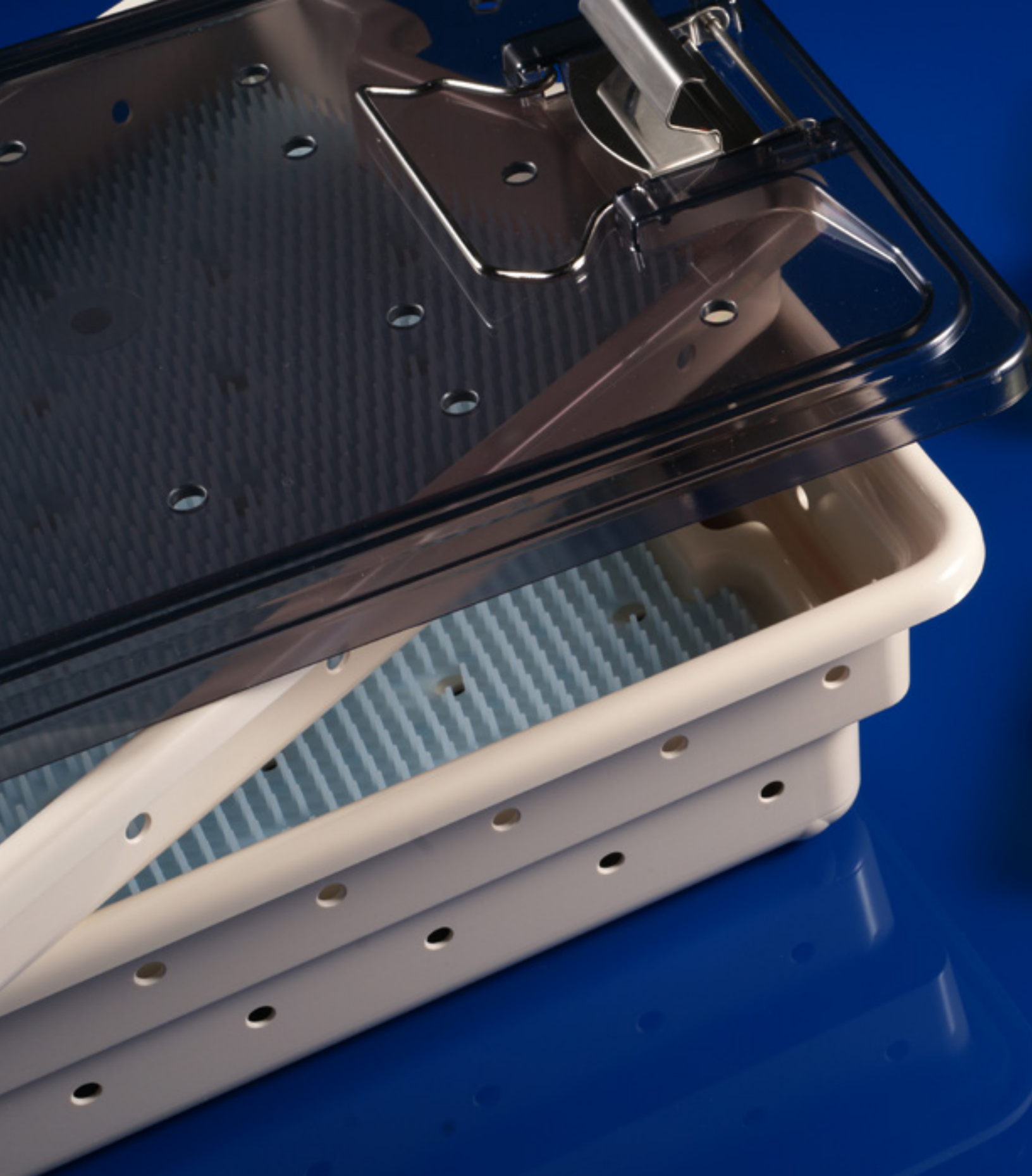

 Sontec Instruments®  
STORAGE CASES & CLEANING

**Metal Micro Instrument Tray**

Single level / includes pin mat and retainers

- 18-3519 10" x 10" x 1.5" (25.5 cm x 25.5 cm x 4 cm)
- 18-3510 10" x 15" x 1.5" (25.5 cm x 38 cm x 4 cm)

\* Instruments not included



18-3519



18-3510

**Metal Micro Instrument Tray**

Double level / includes pin mat and retainers / instruments not included

- 18-3505 10" x 10" x 3" (25.5 cm x 25.5 cm x 8 cm)
- 18-3515 10" x 15" x 3" (25.5 cm x 38 cm x 8 cm) short tray / full height

\* Instruments not included



18-3505



18-3515

**Metal Micro Instrument Tray**

Double level / includes pin mat and retainers

- 18-3520 10.5" x 15" x 2.5" (26.5 cm x 38 cm x 6.5 cm) long tray / half height
- 18-3525 10" x 19.5" x 2.5" (25.5 cm x 49.5 cm x 6.5 cm) short tray / full height
- 18-3530 10.5" x 19.5" x 2.5" (26.5 cm x 49.5 cm x 6.5 cm) long tray / half height

\* Instruments not included



18-3520



18-3525



18-3530

**Rhoton Instrument Tray**

**Stainless steel tray**

1103-708

\* instruments sold as complete set  
\* or can order individually / separate



**Rhoton Instrument Tray**

**Stainless solid**

1103-709

\* instruments sold as complete set  
\* or can order individually / separate



**Universal Surgery Tray**

10" x 21.5" x 2.5" / with lid / universal  
keyhole brackets

18-3560

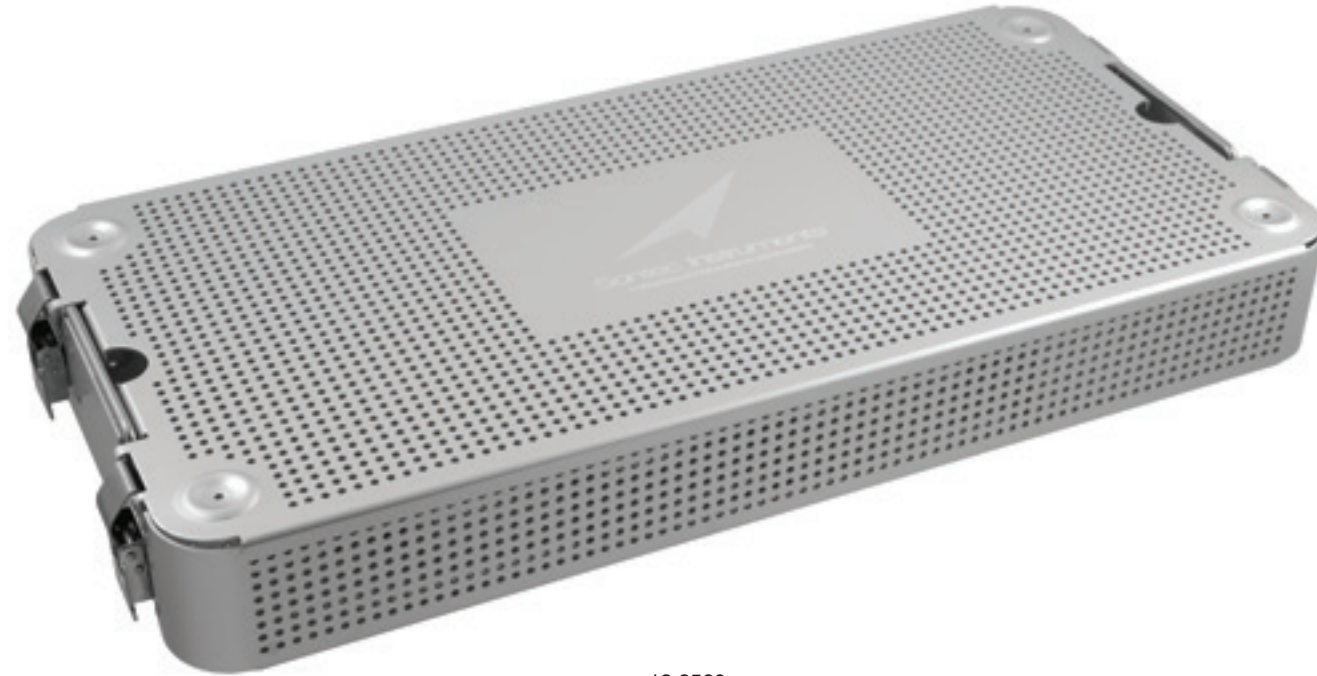

18-3560

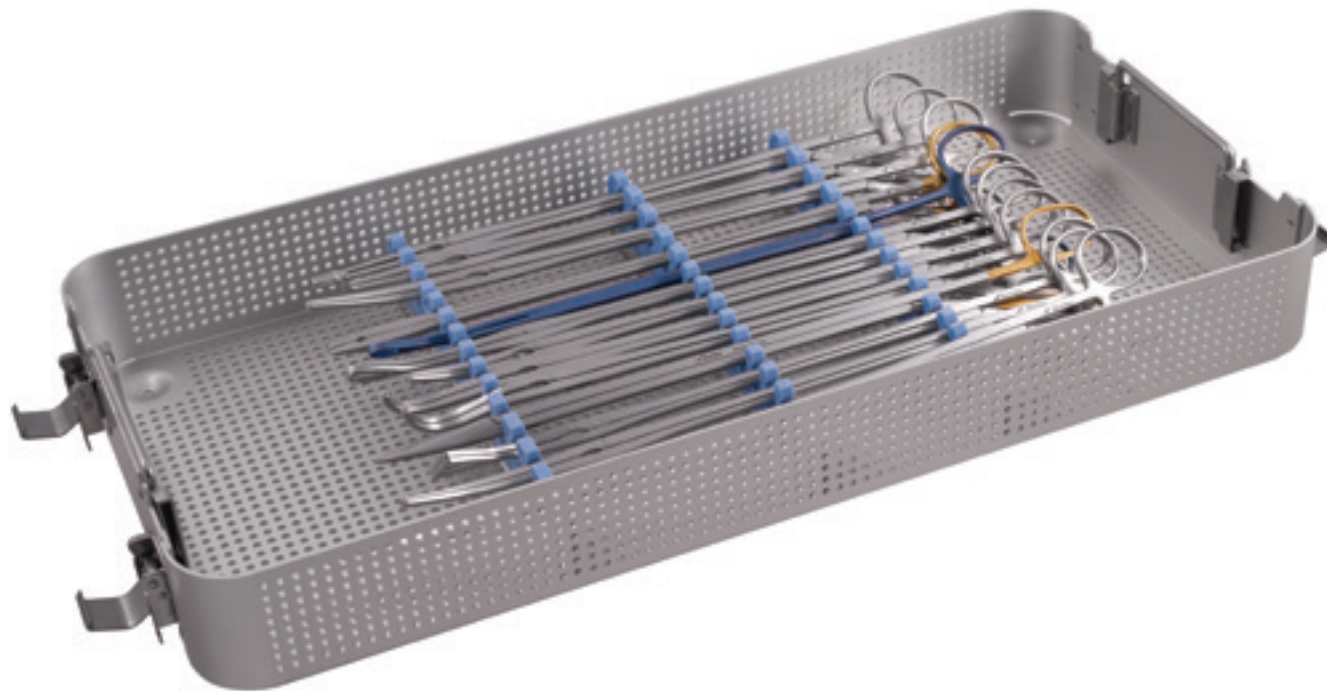

**Silicone Mat**

For instrument trays / cut to size /  
autoclavable

- 18-3120 18" x 13" (46 cm x 33 cm) with holes
- 18-3121 10" x 6" (25.5 cm x 15 cm)
- 18-3122 10" x 15" (25.5 cm x 38 cm)
- 18-3123 13" x 18" (35.5 cm x 48.5 cm)

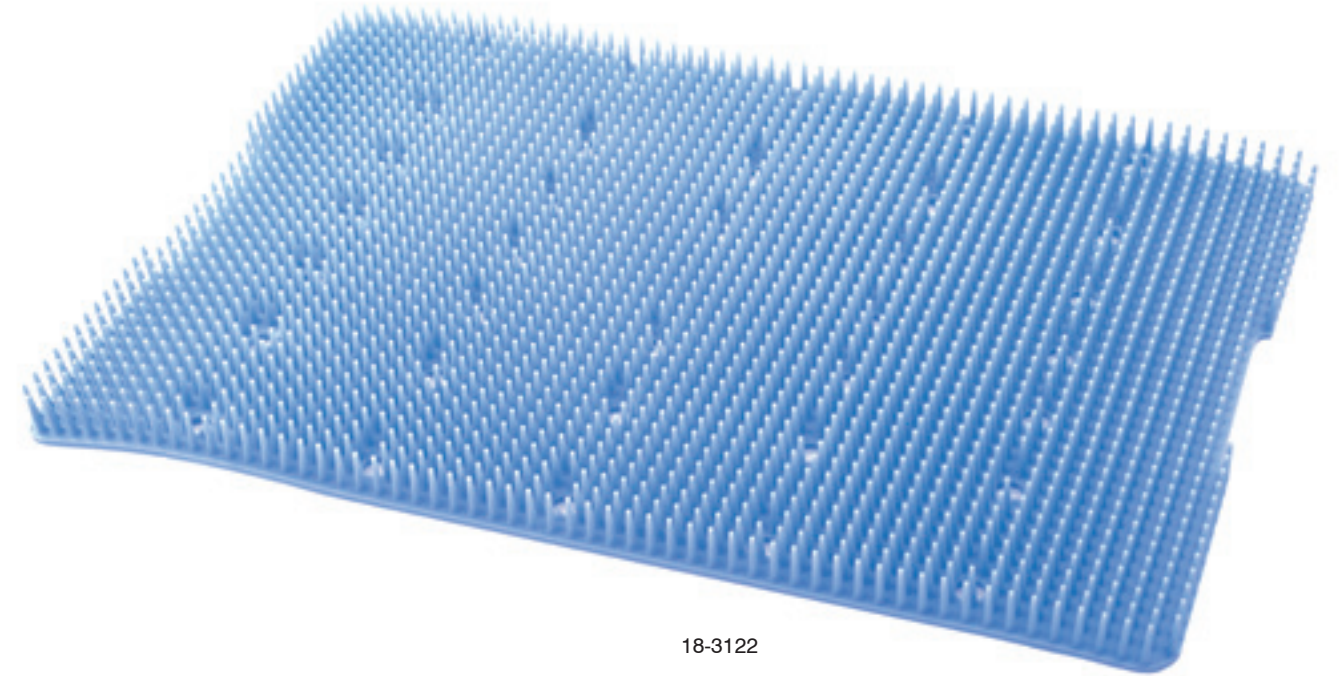

18-3122

**Universal Kerrison Klick Rongeur Tray for Set**

18-3564 tray for the set

To configure you own personalized set, refer to "Kerrison Section" > "Kerrison Universal Rotating 360° Rongeur" for all possible options

\*different size shafts available up request



**Alligator Sterilizing Rack**

3.5" x 3" x 7.5"  
325-130

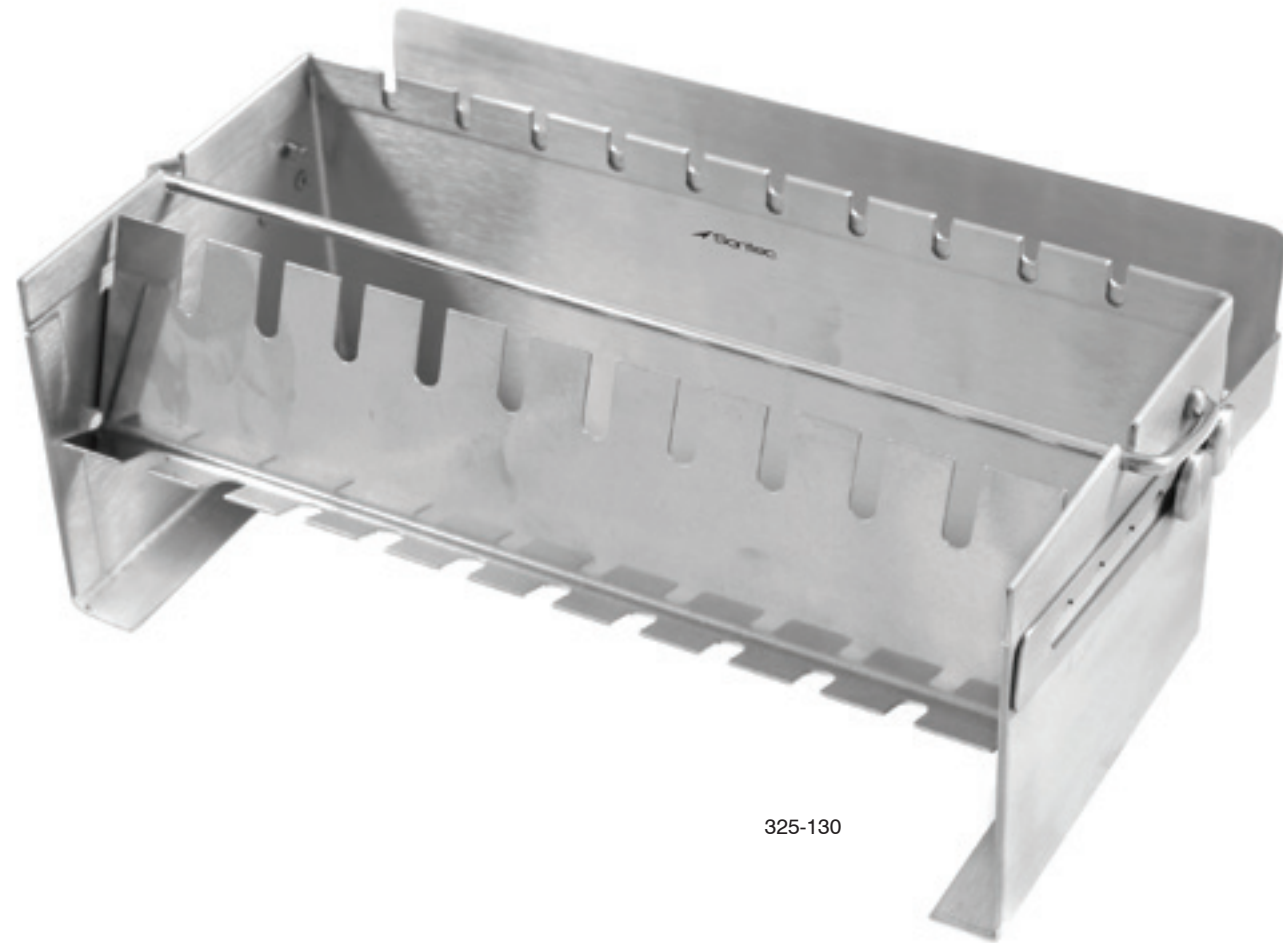

325-130

**Thermoplastic Instrument Tray**

With silicone mat / autoclavable

1103-719	single	10" x 6" x 2.5"	deep with flat lid
1103-720	single	10" x 6" x 3"	deep with dome lid

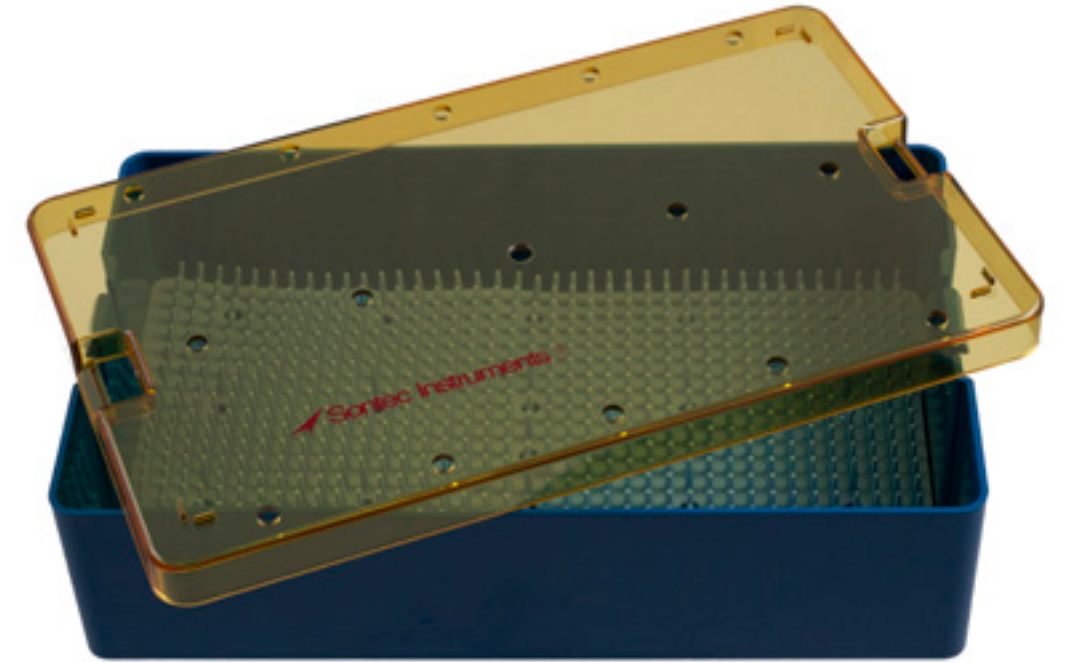

1103-719

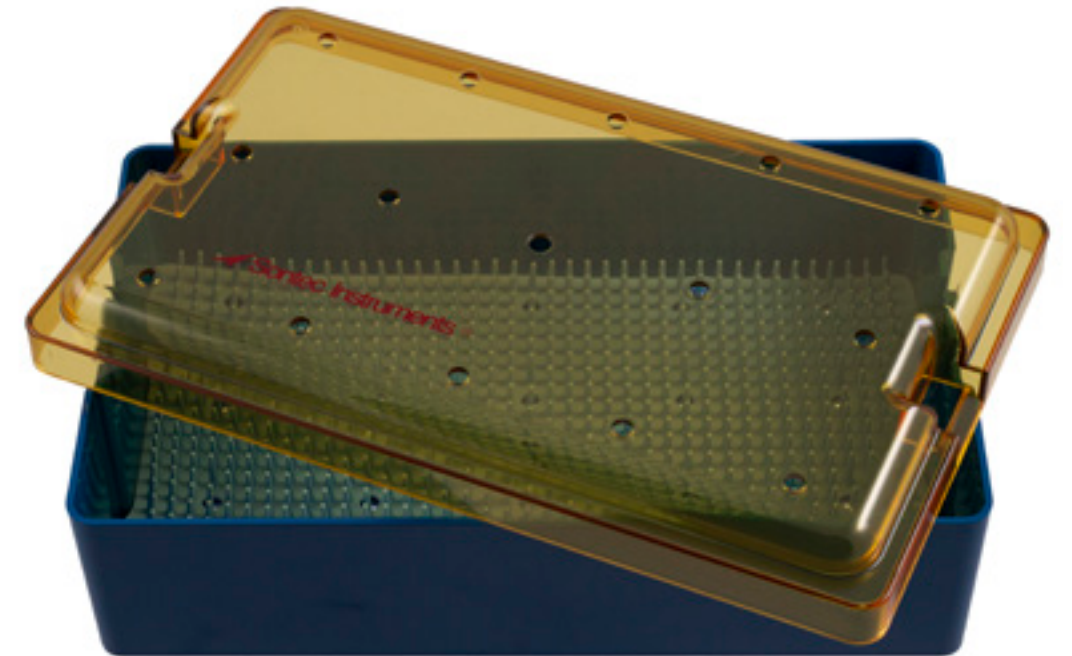

1103-720

**Thermoplastic Instrument Tray**

With silicone mat / autoclavable

1103-702	single	6" x 2 1/2" x 3/4"
1103-703	single	1.5" x 2.7" x .75" mini tray
1103-705	single	6" x 4" x 3/4"
1103-723	single	7 1/2" x 4" x 3/4"
1103-710	single	10" x 6" x 3/4"
1103-702D	single	6" x 2 1/2" x 1 1/4" deep
1103-724	single	7 1/2" x 4" x 1 1/2" deep
1103-716	single	10" x 6" x 1 1/2" deep
1103-715	double decker	10" x 6" x 1 1/2"



1103-703

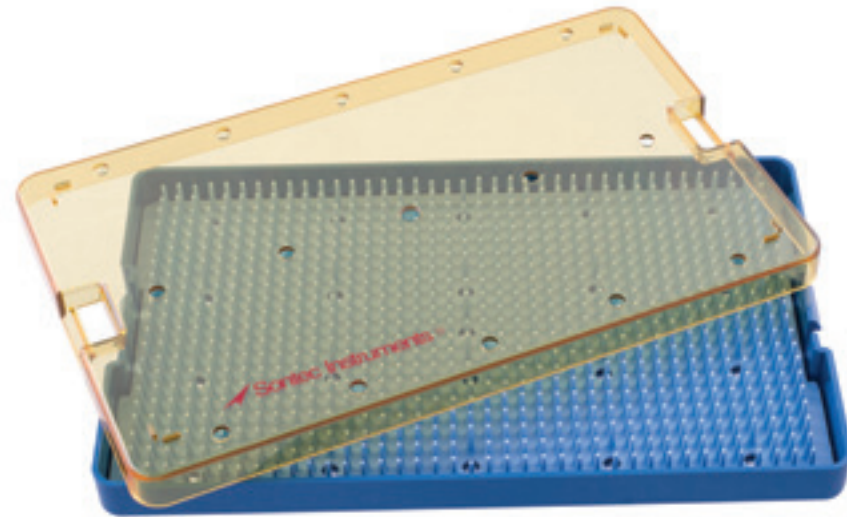

1103-710

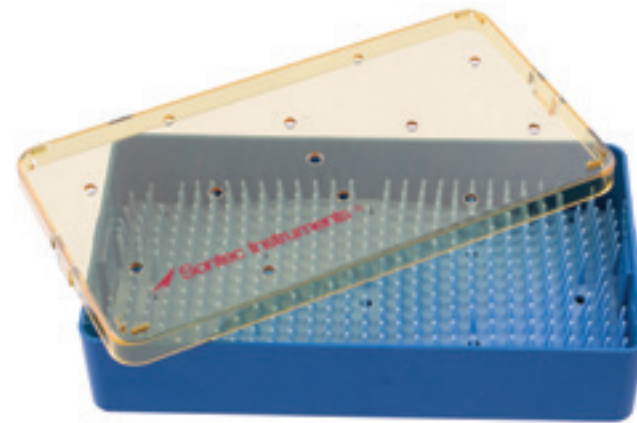

1103-724

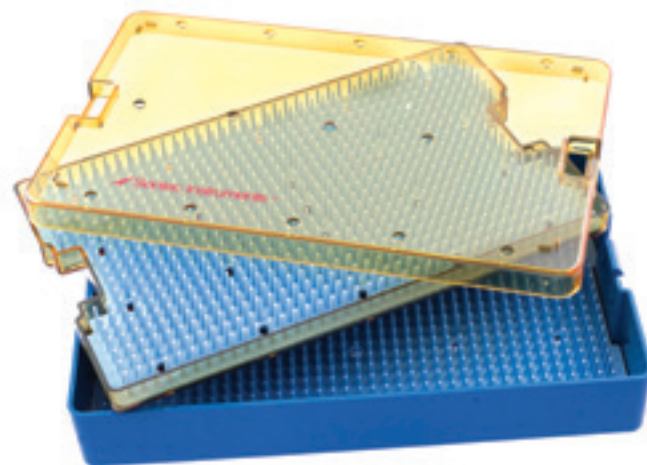

1103-715

**Thermoplastic Instrument Tray**

With silicone mat / autoclavable

18-3214	single	10" x 15" x 3/4"
18-3215	single	10" x 15" x 1 1/2" deep
18-3213	double decker	10" x 15" x 1 1/2"

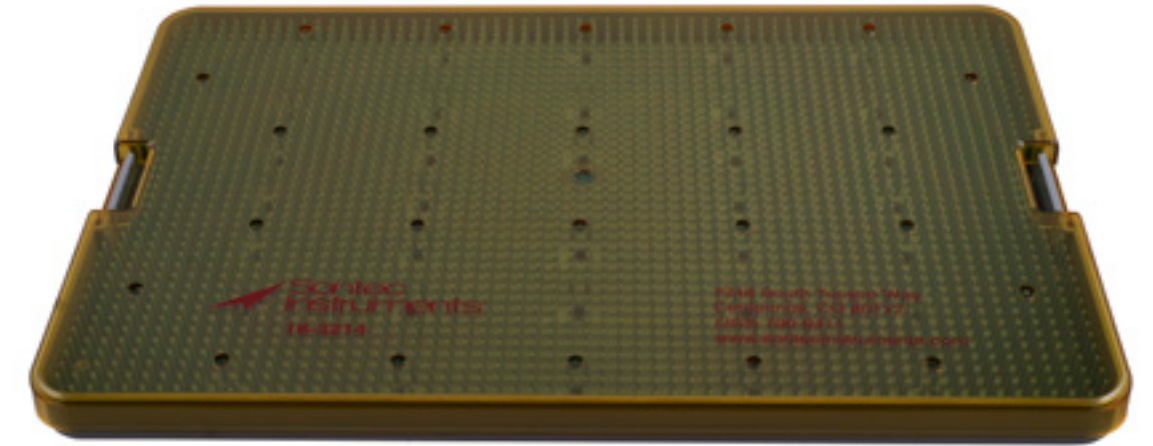

18-3214

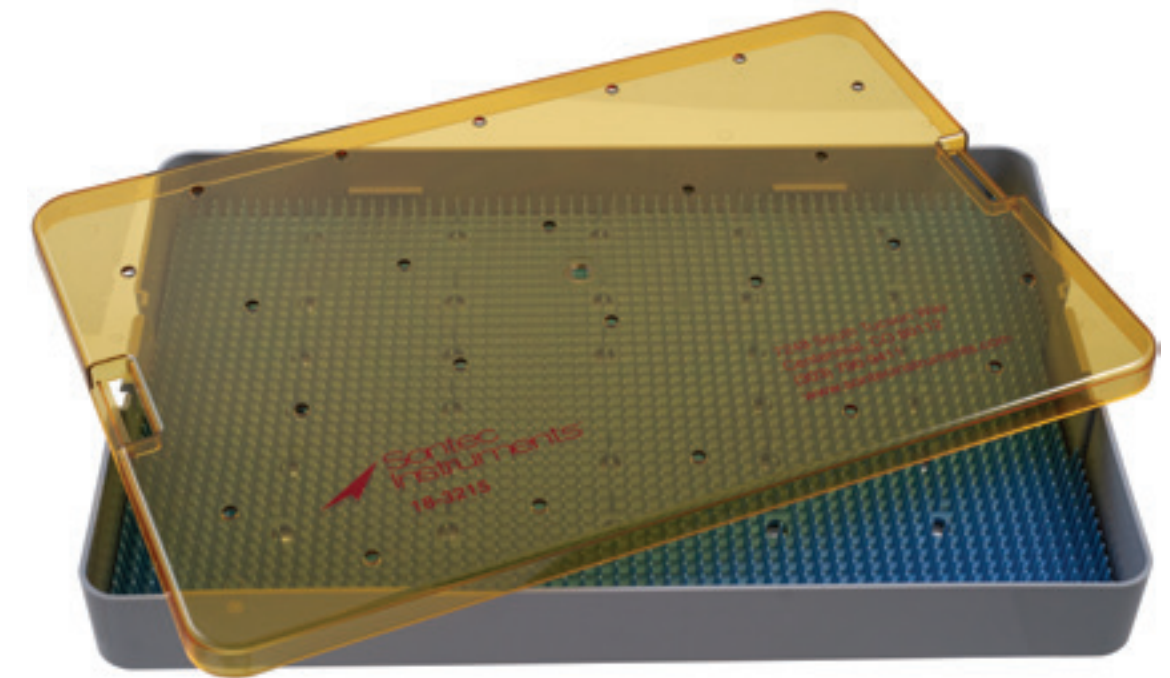

18-3215

**Thermoplastic Instrument Trays**

With silicone mat and metal clasps / autoclavable

- 1103-717 double decker 11" x 7" x 1 1/2"
- 1103-717D single deep 11" x 7" x 1 1/2"
- 1103-712 single shallow 11" x 7" x 3/4"

\* Other sizes available upon request, requires special order. Check your measurements.

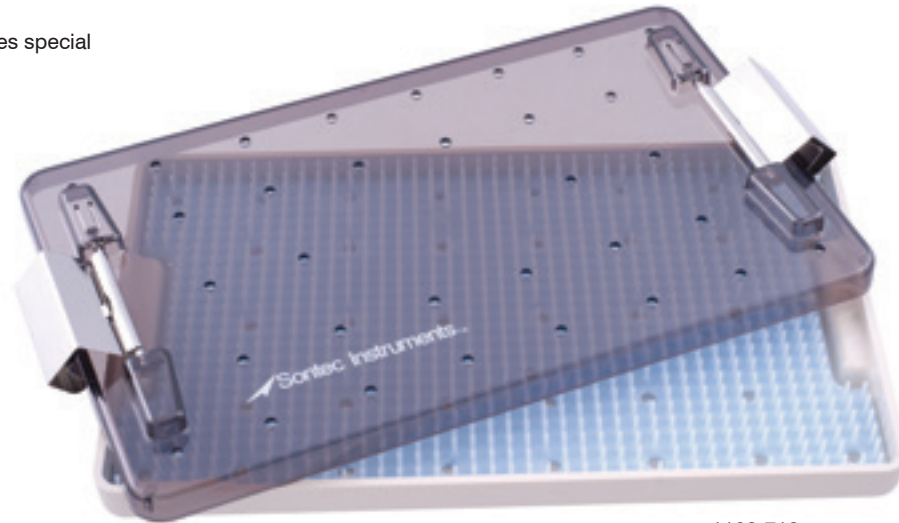

1103-712

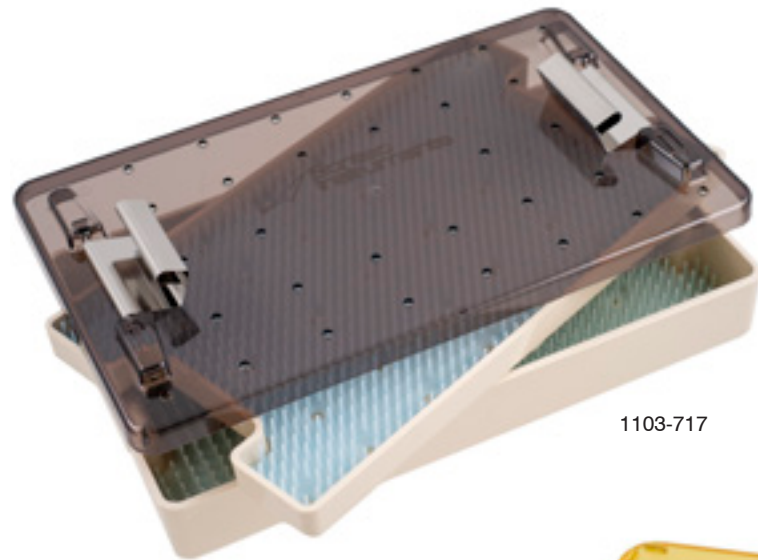

1103-717

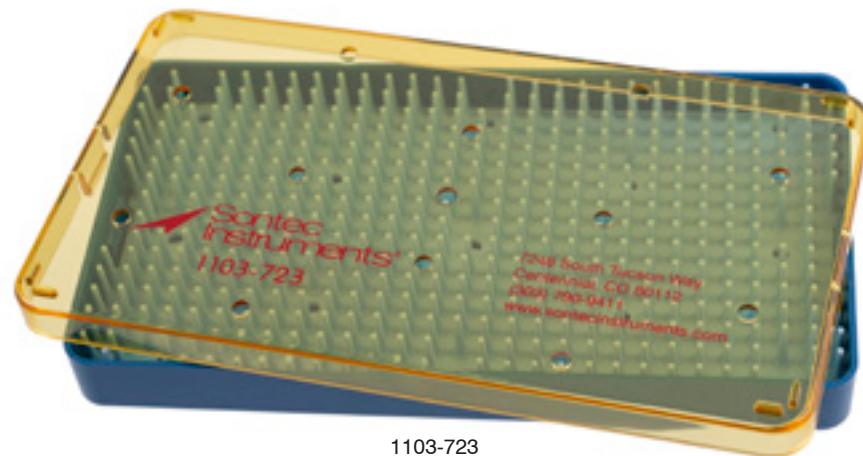

1103-723

**Sontec Slim Thermoplastic Instrument Tray**

- 18-3209 tray 10.3" x 18.3" x 2.33"
- 18-3270 tray 18.3" x 8.35" x 2"

\* "Check Your Measurements", These items are FINAL SALE



18-3209



18-3270

**Catheter Trays & Dome Lid Covers**

Heavy duty / seamless / for catheter trays / strap handles / easy to handle

ST83 8 3/4" x 3 1/4" x 1 1/2" Tray  
ST83-2 Lid Cover: fits tray ST83

ST17-0-0 17 1/4" x 4 1/2" x 2" Tray  
ST17-0-2 Lid Cover: fits tray ST170

ST95-2 8 7/8" x 5" x 2" Tray  
ST95-3 8 7/8" x 5" x 3" Tray  
ST95-2D-2 Lid Cover: fits trays ST952 & ST953

\* "Check Your Measurements"  
These items are FINAL SALE



ST95-2

**Stainless Steel Instrument Trays, Lid Covers & Perforated Nesting Sterilization Instrument Trays**

Used for hot or cold sterilization / for Sterilization Trays / recessed strap handles / easy to handle / easy to store / safe to transport

STE2-0124 solid 20 3/4" x 12 3/4" x 4" Tray  
STP2-0122 perforated 20 3/4" x 12 3/4" x 2 1/2" Tray  
STE2-0126 solid 20 3/4" x 12 3/4" x 6" Tray  
STP2-0124 perforated 20 3/4" x 12 3/4" x 4" Tray  
ST20-00-2 Lid Cover: fits trays STE20124, STP20122, STE20126, STP20124

STE1-2104 solid 12 3/4" x 10 3/8" x 4" Tray  
STP1-2102 perforated 12 3/4" x 10 3/8" x 2 1/2" Tray  
STP1-2104 perforated 12 3/4" x 10 3/8" x 4" Tray  
ST13-11-2 Lid Cover: fits trays STE1-2104, STP1-2102, STP1-2104



STP1-2104

**Stainless Steel Instrument Trays & Lid Covers**

Heavy duty / seamless / covered corners / easy to sterilize / for instrument trays / recessed strap handles / easy to handle / easy to store

ST43 5 3/8" x 4" x 2 5/8" Tray  
ST43-2 Lid Cover: fits tray ST43

ST63 6 1/8" x 6 1/8" x 2 7/8" Tray  
ST63-2 Lid Cover: fits tray ST63

ST95-3 8 7/8" x 5" x 3" Tray  
ST95-2 8 7/8" x 5" x 2" Tray  
ST95-2-2 Lid Cover: fits trays ST952 & ST953

ST10-02 10" x 6 1/2" x 2" Tray  
ST10-02-2 Lid Cover: fits tray ST1002

ST12-02 12 1/4" x 7 3/4" x 2 1/4" Tray  
ST12-02-2 Lid Cover: fits tray ST1202

STE1-082 10" x 8 1/4" x 2 1/2" Tray  
ST10-82-2 Lid Cover: fits trays STE1082

STE1-654 16 1/2" x 10" x 4" Tray  
STE1-650 16 1/2" x 10" x 2 1/2" Tray  
ST16-50-2 Lid Cover: fits trays STE1650 & STE1654

STE9-02 6 7/8" x 4 1/4" x 2" Tray

STE2-304 13 7/8" x 12 7/8" x 4" Tray  
STE2-302 13 7/8" x 12 7/8" x 2 1/2" Tray

STE0-6066 6 7/8" x 6 3/8" x 6" Tray  
STE0-6064 6 7/8" x 6 3/8" x 4" Tray  
STE0-6062 6 7/8" x 6 3/8" x 2 1/2" Tray  
ST60-2-2 Lid Cover: fits trays STE06062, STE06064 & STE06066

STE1-0066 10 3/8" x 6 3/8" x 6" Tray  
STE1-0064 10 3/8" x 6 3/8" x 4" Tray  
STE1-0062 10 3/8" x 6 3/8" x 2 1/2" Tray  
ST40-2-2 Lid Cover: fits trays STE10062, STE10064 & STE10066

\* "Check Your Measurements", These items are FINAL SALE

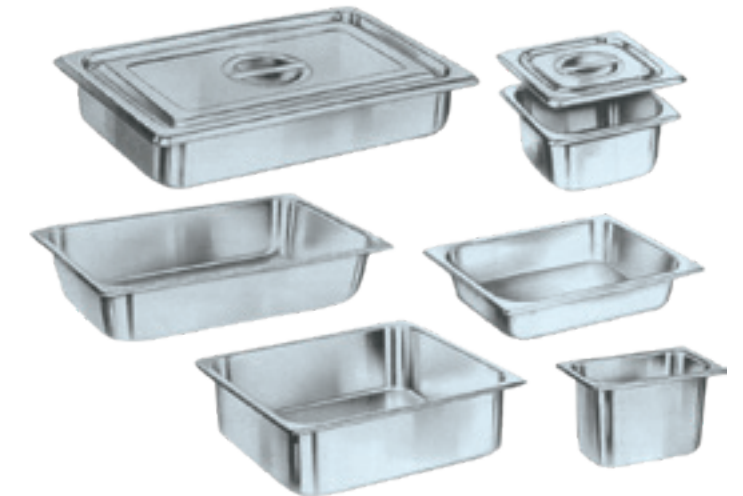

ST95-2



ST16-50-2



STE1-654

**Stainless Steel Instrument Trays & Lid Covers** Continued

**For instrument trays / standard weight / 22 gauge**

- STE1-2066 12 3/4" x 6 7/8" x 6" Tray
- STE1-2064 12 3/4" x 6 7/8" x 4" Tray
- STE1-2062 12 3/4" x 6 7/8" x 2 1/2" Tray

**Heavy weight / 20 gauge**

- STS1-2066 12 3/4" x 6 7/8" x 6" Tray
- STS1-2064 12 3/4" x 6 7/8" x 4" Tray
- STS1-2062 12 3/4" x 6 7/8" x 2 1/2" Tray
- ST30-2-2 Lid Cover: fits trays STE1-2062, STE1-2064, STE1-2066, STS1-2062, STS1-2064, STS1-2066

**Standard weight / 22 gauge**

- STE1-2106 12 3/4" x 10 3/8" x 6" Tray
- STE1-2104 12 3/4" x 10 3/8" x 4" Tray
- STE1-2102 12 3/4" x 10 3/8" x 2 1/2" Tray

**Heavy weight / 20 gauge**

- STS1-2106 12 3/4" x 10 3/8" x 6" Tray
- STS1-2104 12 3/4" x 10 3/8" x 4" Tray
- STS1-2102 12 3/4" x 10 3/8" x 2 1/2" Tray
- ST13-11-2 Lid Cover: fits trays STE1-2102, STE1-2104, STE1-2106, STS1-2102, STS1-2104, STS1-2106

**Standard weight / 22 gauge**

- STE2-0126 20 3/4" x 12 3/4" x 6" Tray
- STE2-0124 20 3/4" x 12 3/4" x 4" Tray
- STE2-0122 20 3/4" x 12 3/4" x 2 1/2" Tray

**Heavy weight / 20 gauge**

- STS2-0126 20 3/4" x 12 3/4" x 6" Tray
- STS2-0124 20 3/4" x 12 3/4" x 4" Tray
- STS2-0122 20 3/4" x 12 3/4" x 2 1/2" Tray
- ST20-00-2 Lid Cover: fits trays STE2-0122, STE2-0124, STE2-0126, STE2-0122, STE2-0124, STE2-0126

\* "Check Your Measurements", These items are FINAL SALE

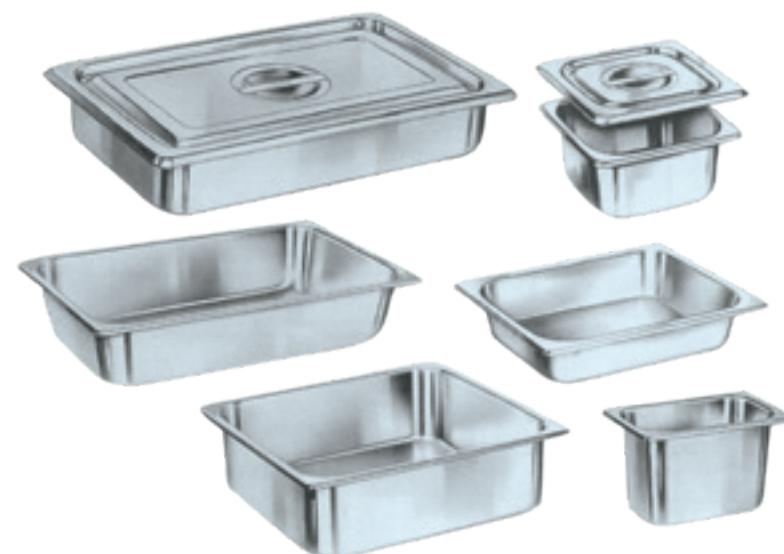

STS1-2104

**Emesis Basin**

- ST6 10 oz.
- ST8 12 oz.
- ST10 26 oz.
- ST12 50 oz.



**Instrument Tray**

**Rolled edge**

- ST10-F 10" x 6 1/2" x 3/4"
- ST13-F 13 1/2" x 9 3/4" x 3/4"
- ST15-20 21 1/4" x 16 1/4" x 7/8"
- ST15-F 15 1/8" x 10 5/8" x 3/4"
- ST17-F 17" x 11 5/8" x 3/4"
- ST19-F 19 1/8" x 12 5/8" x 3/4"



**Perforated Mayo Tray**

- ST10-F-PMT 10" x 6 1/2" x 3/4"
- ST15-20-PMT 21 1/4" x 16 1/4" x 7/8"
- ST15-F-PMT 15 1/8" x 10 5/8" x 3/4"
- ST17-F-PMT 17" x 11 5/8" x 3/4"
- ST19-F-PMT 19 1/8" x 12 5/8" x 3/4"



**Non-Perforated Mayo Tray**

ST3-926	10" x 6 1/2" x 3/4"
ST3-927	14" x 10" x 5/8"
ST3-929	17" x 11 5/8" x 3/4"
ST3-930	19 1/8" x 12 5/8" x 3/4"



ST3-926



ST3-927



ST3-930

**Iodine Cup**

ST6G	6 oz. 3 7/16" x 2"
ST14-G	14 oz. 4 3/8" x 2 5/8"

\* "Check Your Measurements",  
These items are FINAL SALE



ST14-G



ST6G

**Sponge Bowl**

Flat bottom / straight sides / extra stable

ST10-7	64 oz.	7 9/16" x 3"
ST14-8	48 oz.	7 1/8" x 2 3/4"
ST10-6	36 oz.	6 1/4" x 2 3/4"
ST10-0	30 oz.	5 9/16" x 2 9/16"
ST75	20 oz.	5" x 2 3/8"
ST52	14 oz.	4 1/4" x 2"

\* "Check Your Measurements", These items are FINAL SALE



ST10-6



ST52



ST75

**Dressing Jar**

With cover / cover included with jar

ST2J	2 quart
ST3J	3 quart
ST4J	4 3/4 quart



**Forceps Jar**

ST14-K	1 x 4"
ST32-K	2 1/4 x 4 1/2"
ST72-K	2 1/4 x 7"



ST14-K

**Medicine Cup**

ST2 2 oz.



**Sontec Scrub Pants**

- 103-109 small
- 103-110 medium
- 103-111 large



**Sontec Instrument Fabric Barrier Wrap 2Ply**

- 103-115 18 x 18"
- 103-117 24 x 24"
- 103-119 30 x 30"



**Sontec Forceps Holder**

**Side lock / pin**

- 125-634 2 1/2" x 6" (15.2 cm)
- 125-635 2 1/2" x 8" (20.3 cm)
- 125-636 2 1/2" x 10" (25.4 cm)
- 125-637 2 1/2" x 12" (30.5 cm)
- 125-638 2 1/2" x 16" (40.6 cm)
- 125-639 2 1/2" x 18" (45.7 cm)

**Open U**

- 125-661 2 1/2" x 6" (15.2 cm)
- 125-662 2 1/2" x 8" (20.3 cm)
- 125-663 2 1/2" x 10" (25.4 cm)
- 125-664 2 1/2" x 12" (30.5 cm)

**Center lock / hook**

- 125-666 2 1/2" x 6" (15.2 cm)
- 125-667 2 1/2" x 8" (20.3 cm)
- 125-668 2 1/2" x 10" (25.4 cm)
- 125-669 2 1/2" x 12" (30.5 cm)
- 125-670 2 1/2" x 16" (40.6 cm)
- 125-671 2 1/2" x 18" (45.7 cm)

**Side lock / wide / hook**

- 125-640 2 1/2" x 8" (20.5 cm)
- 125-642 2 1/2" x 10" (25.5 cm)
- 125-644 2 1/2" x 12" (30.5 cm)
- 125-646 2 1/2" x 16" (41 cm)

**Side lock**

- 125-655 5" x 8" (20.3 cm)
- 125-656 5" x 10" (25.4 cm)
- 125-657 5" x 12" (30.5 cm)
- 125-658 5" x 16" (40.6 cm)
- 125-659 5" x 18" (45.7 cm)

**Closed U**

- 125-673 2 1/2" x 6" (15.2 cm)
- 125-674 2 1/2" x 8" (20.3 cm)
- 125-675 2 1/2" x 10" (25.4 cm)
- 125-676 2 1/2" x 12" (30.5 cm)

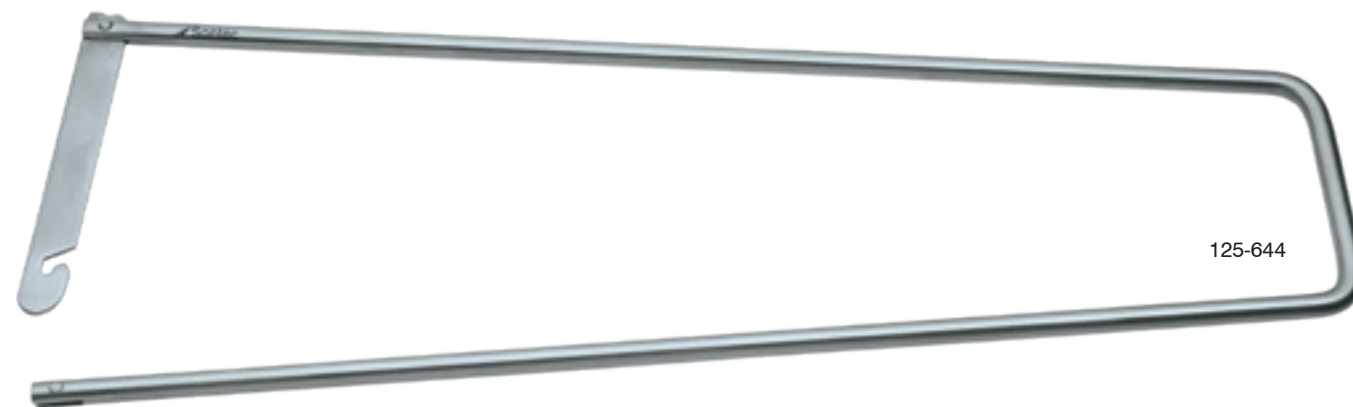

**Stringer Forceps Holder**

**With loop end**

- 127-227 6"
- 127-228 8"
- 127-226 10"
- 127-229 12"



**Bunt Forceps Holder Ring**

**With loop end**

- 1100-788

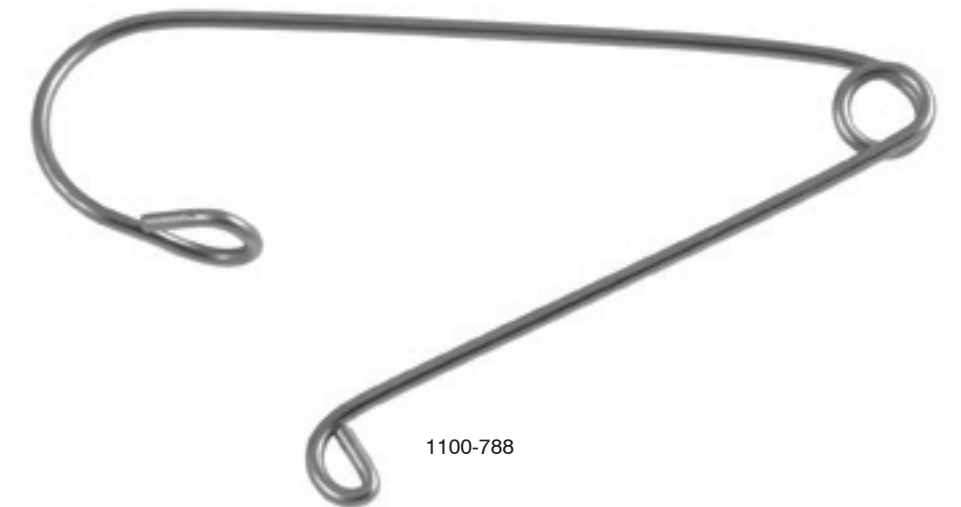

**Needle Boat / Spiral Rack**

**For holding needles**

- 1103-730

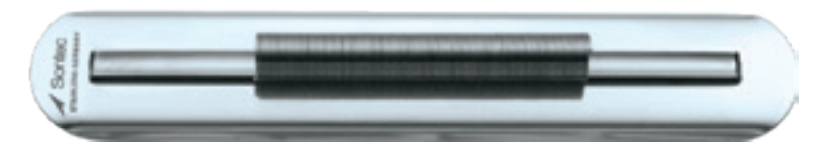

**Tip Cover**

For surgical instrument tip protection / economical & long-lasting / prevents damaging tips and edges / steam-permeable / autoclavable / conveniently color coded / soft vinyl construction, no latex / for a wide variety of instruments, including: scissors, forceps, curettes, drills, and retractors

\* See colors online  
 \* Larger sizes available. Please call for details.  
 \* Individual styles, packaged 100 per bag

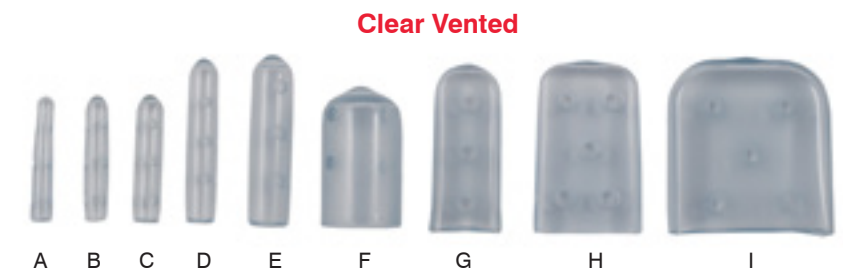
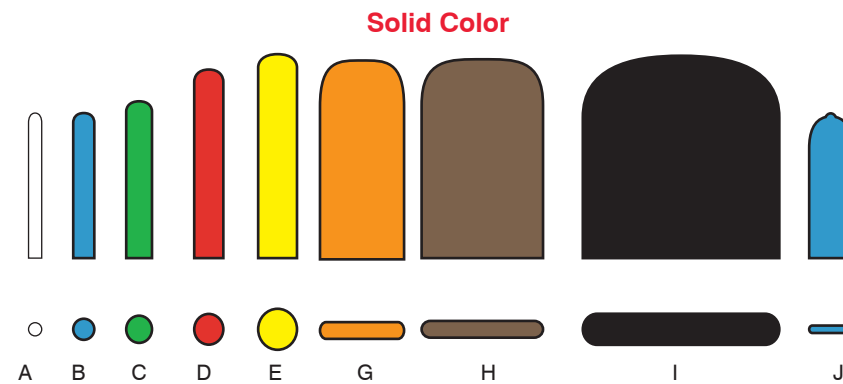

Individual styles, packaged 100 per bag

	Color	Solid #	Tinted #
A	White	105-730	105-782
B	Blue	105-732	105-783
C	Green	105-734	105-784
D	Red	105-736	105-785
E	Yellow	105-738	105-786
G	Orange	105-742	105-787
H	Brown	105-744	105-789
I	Black	105-746	105-790
J	Blue	105-764	N/A

Individual styles, packaged 100 per bag

	Size	Item #
A	1.6 mm x 19 mm	105-791
B	2 mm x 19 mm	105-792
C	2.8 mm x 19 mm	105-793
D	3 mm x 25 mm x 25 mm	105-794
E	3.2 mm x 25.4 mm	105-7951
F	5 mm x 25 mm	105-796
G	10 mm x 19 mm	105-797
H	2 mm x 9 mm x 25 mm	105-798
I	2 mm x 16 mm x 25 mm	105-799
	Assorted Sizes	105-791A

Available Assortments

	Solid #	Tinted #	Clear Vented	Description
Large Assorted	105-748	105-780		Bag of 100, Equal parts A - J
Small Assorted	105-750	105-781		Bag of 100, Equal parts A - E, G, J
Large Assorted			105-791A	Bag of 100 All sizes A - I

**Sontec® Sheet Tape**

For surgical instrument identification / color-codes instruments with pre-cut strips / each 8 1/2" x 11" sheet contains: 44 strips, 2" long x 1/4" wide / 220 strips, 1" long x 1/4" wide (total: 264 strips, 374" of tape)

\* See colors online  
 \* PLEASE NOTE: Sontec® Sheet Tape is not recommended for use with cold sterilization fluids.  
 \* Size and color of tapes may vary slightly from actual products



	105-610 White		105-581 Plum		105-640 Fuchsia
	105-612 Kelly Green		105-540 Blue/Green		105-642 Medical Blue
	105-614 Red		105-541 Blue/Red		105-644 Emerald Green
	105-616 Yellow		105-542 Yellow/Blue		105-646 Violet
	105-618 Orange		105-543 Yellow/Green		105-660 Fuchsia
	105-620 Gray		105-544 Yellow/Red		105-662 Medical Blue
	105-622 Lavender		105-686 Purple/Black		105-664 Emerald Green
	105-624 Beige		105-688 Orange/Black		105-666 Violet
	105-626 Light Blue		105-690 Blue/Black		105-590 Smiley Face, Yellow/Black
	105-628 Lime Green		105-692 Rubine/Black		105-600 Red Hearts on White
	105-630 Pink		105-694 Yellow/Black		105-602 White Hearts on Red
	105-632 Plum		105-696 Green/Black		105-670 Fuchsia*
	105-570 Royal Blue		105-720 Lime Green		105-672 Medical Blue*
	105-571 Kelly Green		105-722 Gray		105-674 Emerald Green*
	105-572 Red		105-723 Beige		105-676 Violet*
	105-573 Yellow		105-724 Light Blue	* Each color sheet contains numbers 0 - 8	
	105-574 Orange		105-725 Pink		105-550 Red/White/Blue
	105-575 Brown		105-726 Plum		105-551 Red/White/Black
	105-576 Black		105-727 Lavender		105-552 Red/Yellow/Black
	105-577 Lavender		105-650 Fuchsia		105-553 Red/Black/Green
	105-578 Light Blue		105-652 Medical Blue	Above Styles: 3/8" wide, 245" total tape	
	105-579 Lime Green		105-654 Emerald Green		
	105-580 Pink		105-656 Violet		







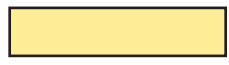

**Medi-Mark™ Tape**

Surgical instrument color coding system / fast and efficient identification system / available in 9 solid colors / one spool codes an average of 230 instruments / clinically proven safe in conventional, flash and gas sterilization / bonds to itself / lasts many months

\* PLEASE NOTE: Medi-Mark™ Tape is not recommended for use with cold sterilization fluids.  
\* See colors online

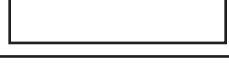
**Application of Medi-Mark™ Tape**

1. Instrument and hands must be clean and dry.
2. Cut Medi-Mark™ Tape with scissors. DO NOT STRETCH!
3. Overlap Medi-Mark™ Tape once.
4. Replace Medi-Mark™ Tape when color changes, before it becomes brittle.
5. Avoid placing Medi-Mark™ Tape on the shank of scissors.

	105-700 Green
	105-702 Yellow
	105-704 Blue
	105-706 Red
	105-708 Brown
	105-710 White
	105-712 Orange
	105-714 Black
	105-716 Purple

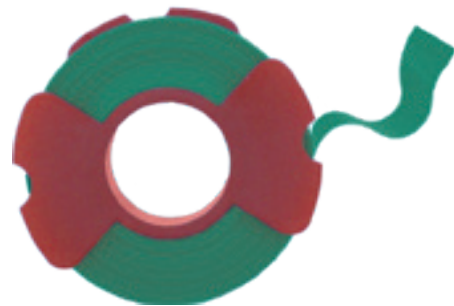

**Whisk 'R Brush™**

For general purpose cleaning / two bristle lengths & a sure-grip handle / available sterile & non-sterile / convenient & economical / simple to use on various shapes and surfaces / for a wide variety of instruments, including: burs, drill points, rasps, and rongeurs / easily removes bone fragments and soft tissue

- 9B-010 12 sterile brushes
- 9B-025 25 non-sterile brushes
- 9B-020 100 non-sterile brushes



**Endozime AW Triple Plus®**

- Multi-tiered enzymatic cleaner
- specifically designed for all washers, washer sterilizers, ultrasonics and manual cleaning
- proprietary synergistic mixture of enzymes and non-ionic detergents
- Protease, Amylase, Lipase, Carbohydrase and other proprietary enzymes
- dissolves all blood, fat, protein, carbohydrates and starches
- built in detergent eliminating the need for all other cleaners and detergents
- compatible with all washers, washer sterilizers and ultrasonics
- strong enough for the most difficult instruments but safe on the most delicate

345A-P16 16 oz  
345A-PAG1 1 gal



**Surgistain®**

- Rust and stain remover
- removes rust, pitting, stains and corrosion from stainless steel instruments
- restores instrument's original finish
- restores articulation to box-locks and joints
- prevents destructive pitting on ridges of micro instruments
- non-corrosive; will not harm quality stainless steel

345B-16 16 oz  
345B-G1 1 gal



**Premixslip®**

- instrument lubricant and rust inhibitor
- the only bacteriostatic pre-mixed instrument lubricant and rust inhibitor
- clinically tested to be thoroughly steam penetrable, steam sterilizable and ETO sterilizable
- prevents rust, spots, stains and corrosion
- non-oily, non-sticky, non-toxic and silicone free
- bacteriostatic high-grade mineral oil lubricant

345P-MX16 16 oz  
345P-MXG1 1 gal



**Prepzyme®**

- multi-tiered enzymatic foam spray
- prevents bio-film from adhering to surface prior to decontamination
- foaming spray covers soiled instruments, scopes and biopsy forceps
- breaks down blood, fat, carbohydrates and starches immediately
- perfect for use in departments where instruments & scope cleaning is not readily available
- safe for all instruments and scopes (flexible or rigid), extends usable lifetime
- neutral PH, non-abrasive, free-rinsing and 100% biodegradable
- will not harm any metals, plastic, rubber, glass or corrugated tubing

345P-RP08 8 oz (with sprayer)  
345P-RP22 22 oz (with sprayer)



**F\*A\*C\*T\*S®**

- foaming autoclave cleaning treatment system
- removes all rust, pitting, stains and corrosion from walls of autoclaves and from stainless steel carts and trays
- removes scale, alkaline and mineral deposits
- foaming spray remains on walls longer for better penetration
- eliminates all noxious odors
- restores original finish to all autoclaves, carts and trays
- non-corrosive; will not harm quality stainless steel

345F-CT22 22oz (with sprayer)





 Sontec Instruments®

KNIFE & BLADE Handles

**Knife Handle #3**

Fits surgical blades 10-15 / with calibrated scale

\* surgical blade not included

1100-740 5" (12.5 cm)



Round handle

1100-741 6" (15 cm)

1100-740



1100-741

Round knurl handle / double / 1 mm / 6 1/4"

1100-7411



1100-7411

**Wide Barrel Grip Knife Handle #3**

Round knurled / straight / 5" (12.7 cm)

117-577



117-577

**Universal Adjustable Angle Knife Handle #3**

Adjustable tip & lock / straight / 10 mm locking increments of 7 positions / 6 1/2" (16.5 cm)

117-578 vertical adjusting  
117-5781 horizontal adjusting



117-578



117-5781

**Knife Handle #3L**

Fits surgical blades 10-15

1100-866 8 1/2" (21.5 cm)

1100-868 12" (30 cm)

117-582 8 3/8" (20 cm) angled



1100-866



117-582

**Staley Round Knurled Knife Handle**

Aluminum / 6" (15.2 cm)

117-571



117-571

**Sontec Knife Handle #3XXL**

16" (40.6 cm)

1100-8681



1100-8681

**Knife Handle #3KL**

Round handle / 6" (15.2 mm)

117-564



117-564

**Chuck Knife Handle #3HL**

Hexagonal handle / 6" (15.2 mm)

117-566



**Beaver® Blade Chuck Handle #3K**

Fits Beaver® style blades

117-560 4" (10 cm)

T117-560 4" (10 cm) titanium

117-561 3" (7.5 cm)



117-560



T117-560

**Beaver® Blade Chuck Handle #3KD**

Fits Beaver® style blades / 5.25" (13.5 cm)

117-559



117-559

**Blake Blade Holder**

Fits size blades #10, 11, 12, 12D, 15, 15C

1100-7413



1100-7413

**Knife Handle #4**

fits surgical blades 20-25  
/ with calibrated scale

1100-742 5" (12.5 cm)



1100-742

**Knife Handle #4L**

Fits surgical blades 20-25

1100-870 8 1/2" (21.5 cm)

1100-872 12" (30 cm)

117-583 8 3/8" (20 cm) angled



1100-870



117-583

**Knife Handle #7**

Fits surgical blades 10-15

117-576 6 1/2" (16.5)

117-576A 6 1/2" (16.5) angled



117-576



117-576A

**Collett Chuck for Knife Handle**

For 3K, 3KL & 3KM handles  
19-1801



19-1801

**Knife Handle #9**

Fits surgical blades 10-15  
117-585



117-585

**Siegel Knife Handle**

Fits surgical blades 10-15 /  
round handle  
117-588



117-588

**Gubish Surgical Pen Holder Set**

5 1/4" (13 cm)  
117-593



chuck

117-593

**Gubisch Surgical Pen Replacement Tip**

10 to a package  
117-594



117-594

**Bayonet Spinal Knife Handle**

Also available in titanium / 13 3/4" (18.5 cm)  
400-428 # 3 use blades 10-15  
400-428A # 4 use blades 20-25

\* Additional sizes available please call Sontec for more information.



400-428

**Self-Locking 3K Chuck Blade Handle**

Stainless steel / 5 3/8"  
117-555



117-588

**Surgical Blade Remover**

117-602



117-602



 Sontec Instruments®

CALIPERS & RULERS

**Castroviejo Caliper**

Scale to 20 mm / 3 1/2" (9 cm)

12-9200	straight	original with wider shanks
12-9300	straight	titanium
T12-9300	straight	deluxe
12-9300D	straight	deluxe
12-9305	angled 45°	
12-9310	curved	
12-9310D	curved	deluxe
12-9315	angled	40 mm scale
12-9316	straight	40 mm scale
12-9318	angled	40 mm scale

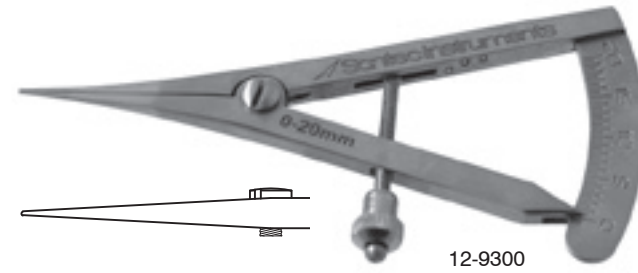

12-9300

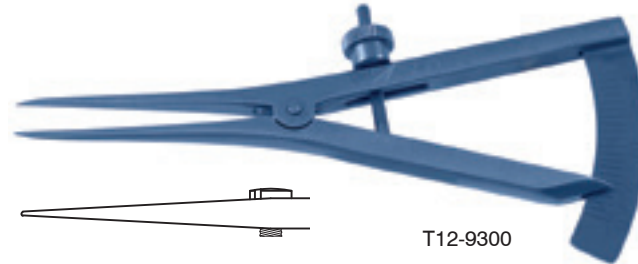

T12-9300



12-9200



12-9300D



12-9305



12-9310D

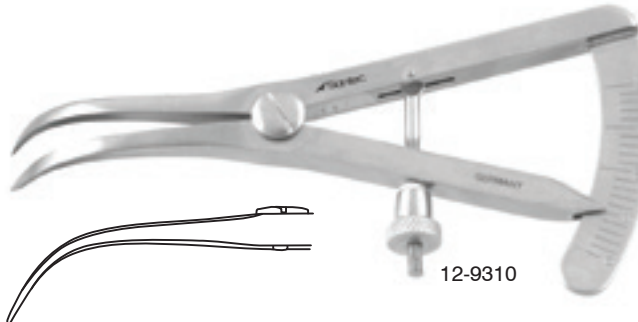

12-9310



12-9316

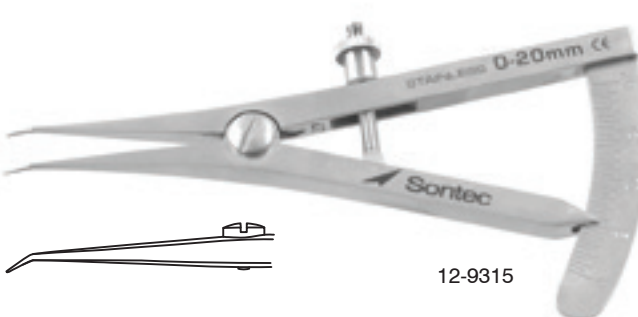

12-9315

**Finger Goniometer**

5 3/4" (14.5 cm)

350-915

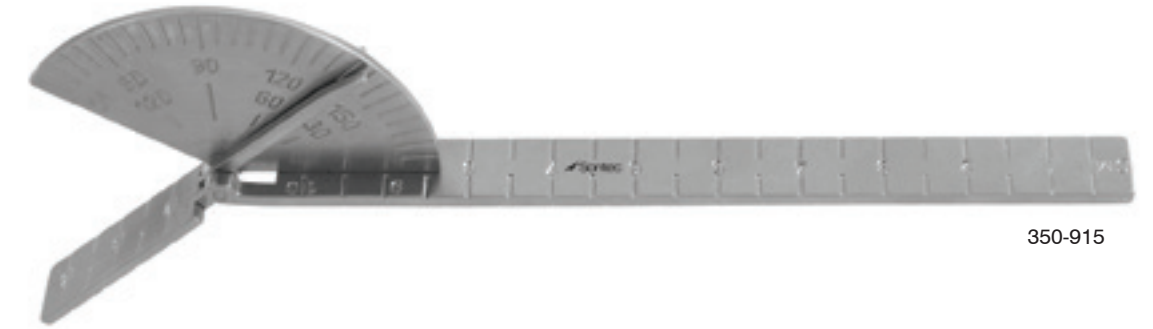

350-915

**Castroviejo Body Caliper**

0-200 mm gauge / 0-100 mm gauge

12-9330	100 mm
12-9335	200 mm



12-9330



12-9335

**Castroviejo Caliper**

40 mm / 7" (17.8 cm)

12-9320	straight
12-9325	angled



12-9320

**Jameson Caliper**

Scale to 3" (8 cm)  
12-9450



12-9450

**Thorpe Caliper**

Scale to 3" (8 cm) /  
angled / markings in  
0.5 mm increments  
12-9400



12-9400

**Orthopedic Vernier Caliper**

Stainless steel / 6" (15.5 cm)  
1103-170

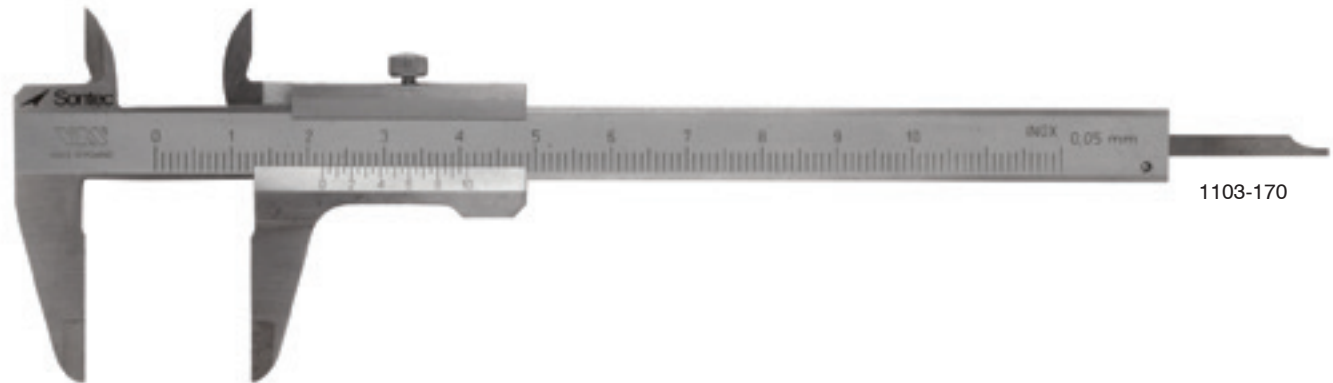

1103-170

**Mini Caliper**

Scale to 90 mm / 5" (12.5 cm)  
12-9425



**Braun Fixed Caliper**

8 cm / special sizes made to order  
12-9340



12-9340

**Stahl A/C Lens Gauge**

For verifying diameter of A/C  
lenses in 1.5 mm increments /  
Teflon coated stainless steel  
12-9630

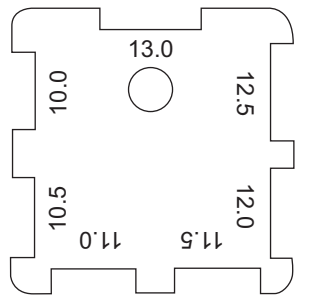

12-9600

**Stahl Caliper**

A/C caliper for  
measuring corneal  
diameter prior to A/C  
IOL / size markings  
on both sides  
12-9600



12-9600

**House Ear Caliper**

With rod mark / 6 1/4" (16 cm)  
1463-140 3.5mm  
1463-141 4mm  
1463-142 4.5mm  
1463-143 5mm



1463-142

**Schiotz Tonometer**

Autoclavable / original model  
18-8301 incline scale

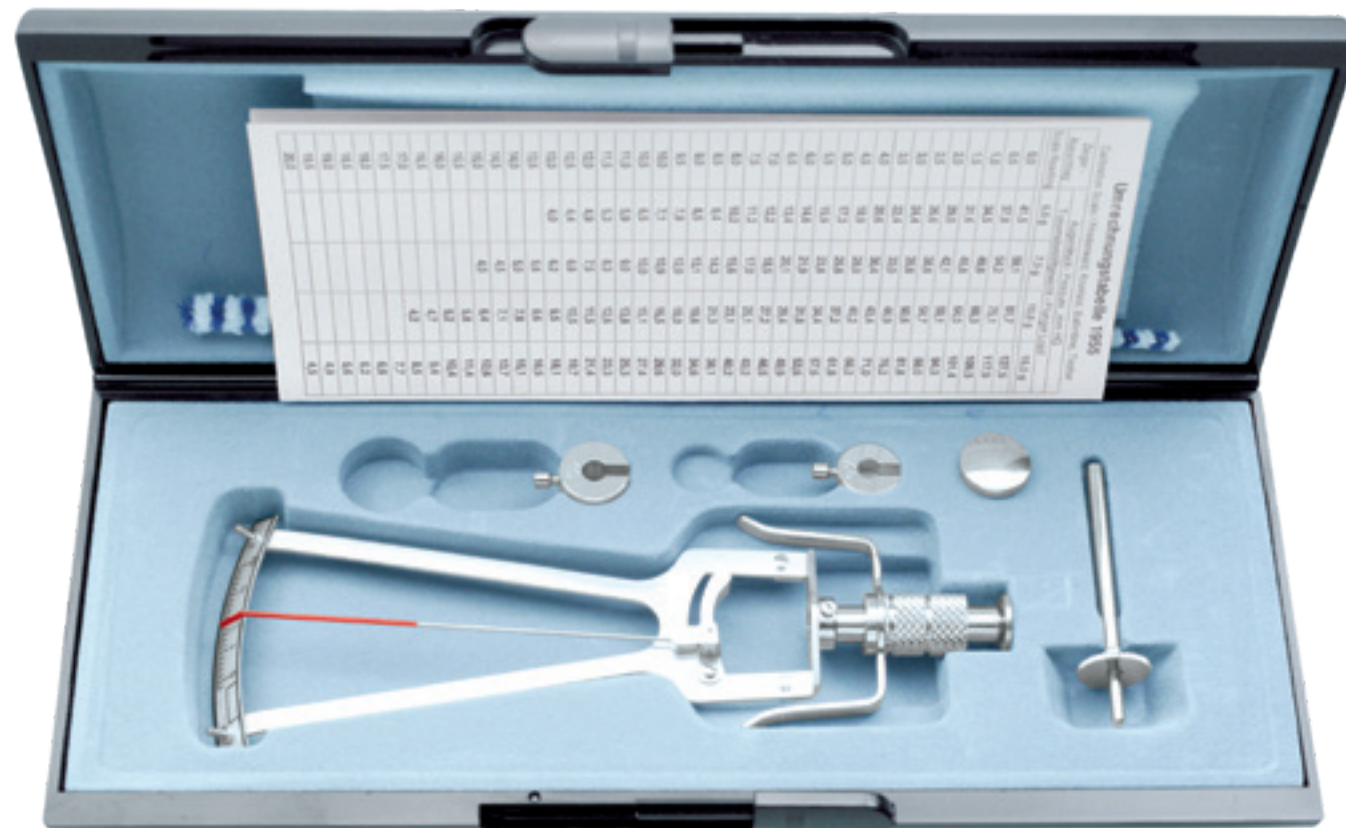

**Punched Hole Gauge Ruler**

7" (18 cm) in length  
1106-190

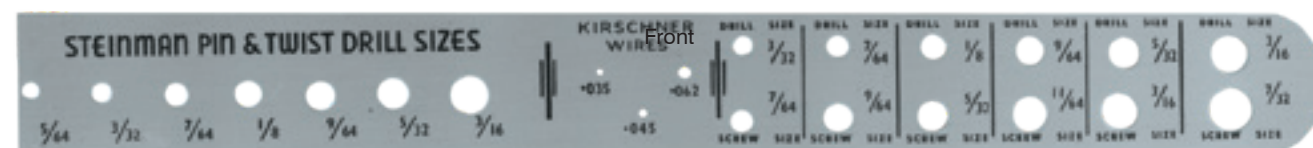
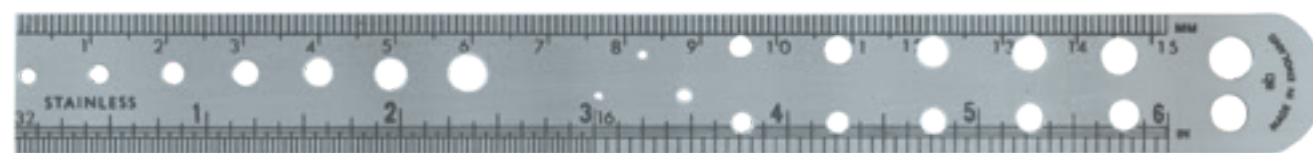

Back

1106-190

**Flexible Stainless Ruler**

6" (15 cm) / graduated in 1/32"  
fractions and millimeters  
12-9500

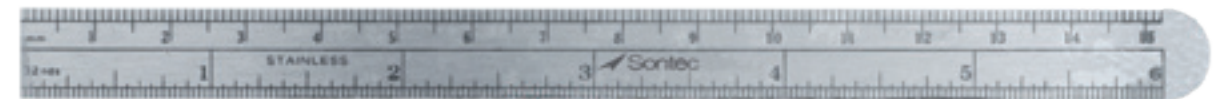

12-9500

**TPLO Double-Ended Gauge**

- 330-450 5 & 6 mm
- 330-452 7 & 8 mm
- 330-454 9 & 10 mm
- 330-456 11 & 12 mm



330-450



330-452



330-454



330-456



 Sontec Instruments®

**ALLIGATOR BIOPSY FORCEPS**

**Sontec Alligator Forceps**

**With lock / delicate jaw / delicate shaft**

- 1100-328L 3 1/2" (9 cm) long jaw
- 1100-330S 5 1/2" (14 cm) shaft
- 1100-333 6 1/2" (16.5 cm) shaft
- 1100-334 9" (23 cm) shaft



1100-328L



1100-328L



1100-330S



1100-333

**Sontec Micro Alligator Forceps**

**Delicate / lacrimal ducts / 4 mm x 0.9 mm jaw / 3 1/4" (8 cm) shaft**

- 469-036 straight without lock
- 469-040 straight with lock
- 469-048 angled left with lock
- 469-050 angled right with lock



469-036



469-040



469-048



469-050

**Hartman Alligator Forceps**

**1 x 2 teeth / 6 1/2" (16.5 cm)**

- 1100-331



**Alligator Forceps Tubular Shaft**

Delicate, flexible, tubular shaft / jaw width is uniform / 10 mm length x 1 mm width

- 1271-010 3 1/2" (9 cm) shaft
- 1271-011 5 1/2" (14 cm) shaft
- 1271-012 6 1/2" (16.5 cm) shaft
- 1271-013 9" (23 cm) shaft



1271-010

**Sontec Alligator Forceps**

Standard jaw / jaw length 10 mm / standard shaft / jaw width 2.2 tapering at tip to 1mm

- 1100-328 3 1/2" (9 cm) shaft
- 1100-330 5 1/2" (14 cm) shaft
- 1100-332 6 1/2" (16.5 cm) shaft



1100-328

**Alligator Forceps**

With lock / delicate jaw / 3 1/2" (9 cm) delicate shaft

- 1100-328S short jaw



1100-328S

**Side Biting Alligator Forceps**

10 mm jaw

- 469-009 TC 2 1/4"
- 469-010 TCD 3 1/2"
- 469-012 TC 2 1/2"



1100-012

**Micro House Alligator Forceps**

Extremely delicate / 3 1/2" (8.9 cm) shaft

469-041Q 3 mm x 0.6 mm jaw

0.6 mm x 7 mm jaw / 3 1/4" (8 cm) shaft

469-042Q angled up

469-046Q angled down



**Duckbill Ear Alligator Forceps**

Round, flat, serrated jaw

469-015 3" (7.5 cm) shaft

1100-335S 5 1/2" (14.5 cm) shaft



**Greven Alligator Forceps**

Serrated jaws / 3 1/4" (8.3 cm)

469-051



**Goodhill Alligator Forceps**

5 mm specially tapered jaw  
467-352 3" (7.5 cm) shaft



467-352

**Alligator Forceps with Malleable Shaft**

Delicate, malleable, tubular shaft / serrated  
1271-0141 3 1/2" (9 cm) shaft  
1271-0142 5 1/2" (14 cm) shaft  
1271-0143 6 1/2" (16.5 cm) shaft  
1271-0144 9" (23 cm) shaft



1271-0143

**Micro Sontec® Alligator Forceps**

Extremely delicate / 3" (9 cm) shaft  
469-039 straight 4 mm x 0.9 mm jaw  
469-041 straight 4 mm x 0.6 mm jaw  
469-044 angled up 4 mm x 0.6 mm jaw

Extremely delicate / smooth TC Dust / straight / 4 mm x 0.9 mm jaw / 3" (9 cm) shaft  
469-038



469-041



469-038

**Micro Ear Alligator Forceps**

**Black anodized coating / serrated jaw / without lock**

469-020	4 mm x 0.6 mm jaw	3 1/4" (8 cm) shaft	
469-020S	3 mm x 0.6 mm jaw	3 1/4" (8 cm) shaft	short jaw
469-021	5 mm x 0.8 mm jaw	3 1/4" (8 cm) shaft	

**Oval cup**

469-026	0.8 mm cup	3 1/4" (8 cm) shaft
---------	------------	---------------------



**Micro Ear Alligator Forceps**

**Black anodized coating / serrated jaw / with lock / 3 1/2"**

469-036B	4 mm x 0.9 mm
469-041B	3 mm x 0.6 mm



**Micro Ear Alligator Forceps**

Black anodized coating / delicate serrated jaw / 4 mm x 0.9 mm / with lock / 3 1/2"

469-048B left curved  
469-050B right curved



**Micro Alligator Grasping Forceps**

Black anodized coating / delicate shaft & jaw / with lock / 3"

1100-328LB



**Goodhill Ear Forceps**

Black anodized coating / delicate shaft & jaw / with lock / 3"

467-352B



**Micro Sontec Alligator Forceps**

Black anodized coating / extremely delicate / 4 mm x 0.9 mm / 3 1/2"  
469-039B



**Hartman Alligator Forceps**

Black anodized coating / standard shaft  
/ 10 mm serrated jaw / jaw width 2.2  
tapering at tip to 1 mm / 3 1/2"  
1100-328B



**Micro House Biopsy Alligator Forceps**

**3 1/2" (9 cm) shaft**

- 469-070 straight 1.2 mm x 0.9 mm oval cup
- 469-071 straight 1.0 mm x 0.6 mm oval cup
- 469-072 angled up 1.0 mm x 0.6 mm oval cup
- 469-074 angled down 1.0 mm x 0.6 mm oval cup
- 469-078 angled right 1.0 mm x 0.6 mm oval cup
- 469-076 angled left 1.0 mm x 0.6 mm oval cup

**3" (7.5 cm) shaft**

- 469-070B straight 1.2 mm x 0.9 mm oval cup

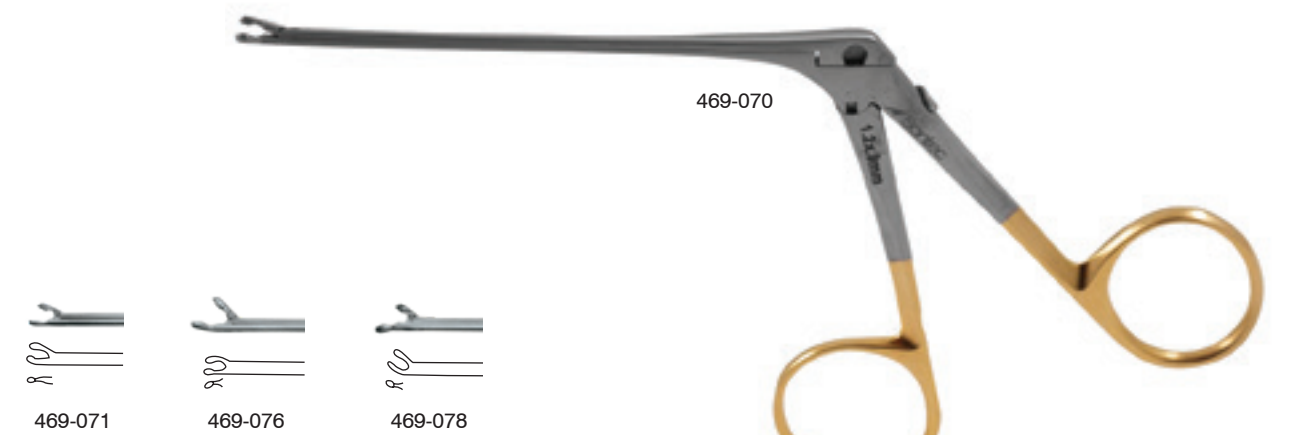

**Micro Biopsy Forceps with Flexible Tubular Shaft**

Tapered tubular shaft / 1mm round cup jaw

- 1271-0151 3 1/2" (9 cm)
- 1271-0152 5 1/2" (14 cm)
- 1271-0153 6 1/2" (16.5 cm)
- 1271-0154 9" (23 cm)



**Hartmann-Noyes Alligator Forceps**

Strong jaw / 5 mm x 1.0 mm cup / 3 1/2" (9 cm) shaft

- 467-339U angled up
- 467-339 straight micro serrated



**Arthroscopic Grasping & Biopsy Combo Rongeur Forceps**

Tubular shaft / serrated bite

- 1271-020 2.0 mm cup 4" (10 cm) shaft
- 1271-020R 2.0 mm cup 4" (10 cm) shaft
- 1271-016 2.7 mm cup 4" (10 cm) shaft
- 1271-018 3.4 mm cup 4" (10 cm) shaft
- 1271-021 2.0 mm cup 6" (15.5 cm) shaft
- 1271-021A 2.0 mm cup 6" (15.5 cm) shaft rear actuator handle



\* Available in 4.5 mm, please ask for details



**Mini Arthroscopic Small Joints Rongeur Set**

**Tubular 4" (10.2 cm) shaft / 2.0 mm jaws**

- 1271-005 grasping forceps
- 1271-005A grasping forceps rear actuator handle 6"
- 1271-006 fine scissors
- 1271-007 basket punch
- 1271-008 round cup biopsy rear actuator handle
- 1271-009 round cup biopsy

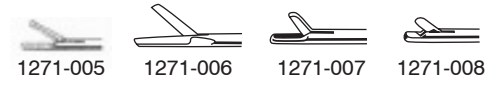

\* All tubular shaft instruments available upon request with rear actuator handles



**Frontal Sinus Giraffe Punch**

**Double Action Cup / 50 degree / 5 3/4" (14.6 cm) shaft**

- 468-340 vertical 2 mm
- 468-342 horizontal 2 mm

**Double Action Cup / 90 degree / 5 3/4" (14.6 cm) shaft**

- 468-343 horizontal 2 mm
- 468-344 vertical 2 mm



**Frontal Sinus Giraffe Forceps**

Double Action Cup / 45 degrees / 5 1/4" (13.5 cm) shaft

- 468-330 vertical 2 mm
- 468-331 horizontal 2 mm

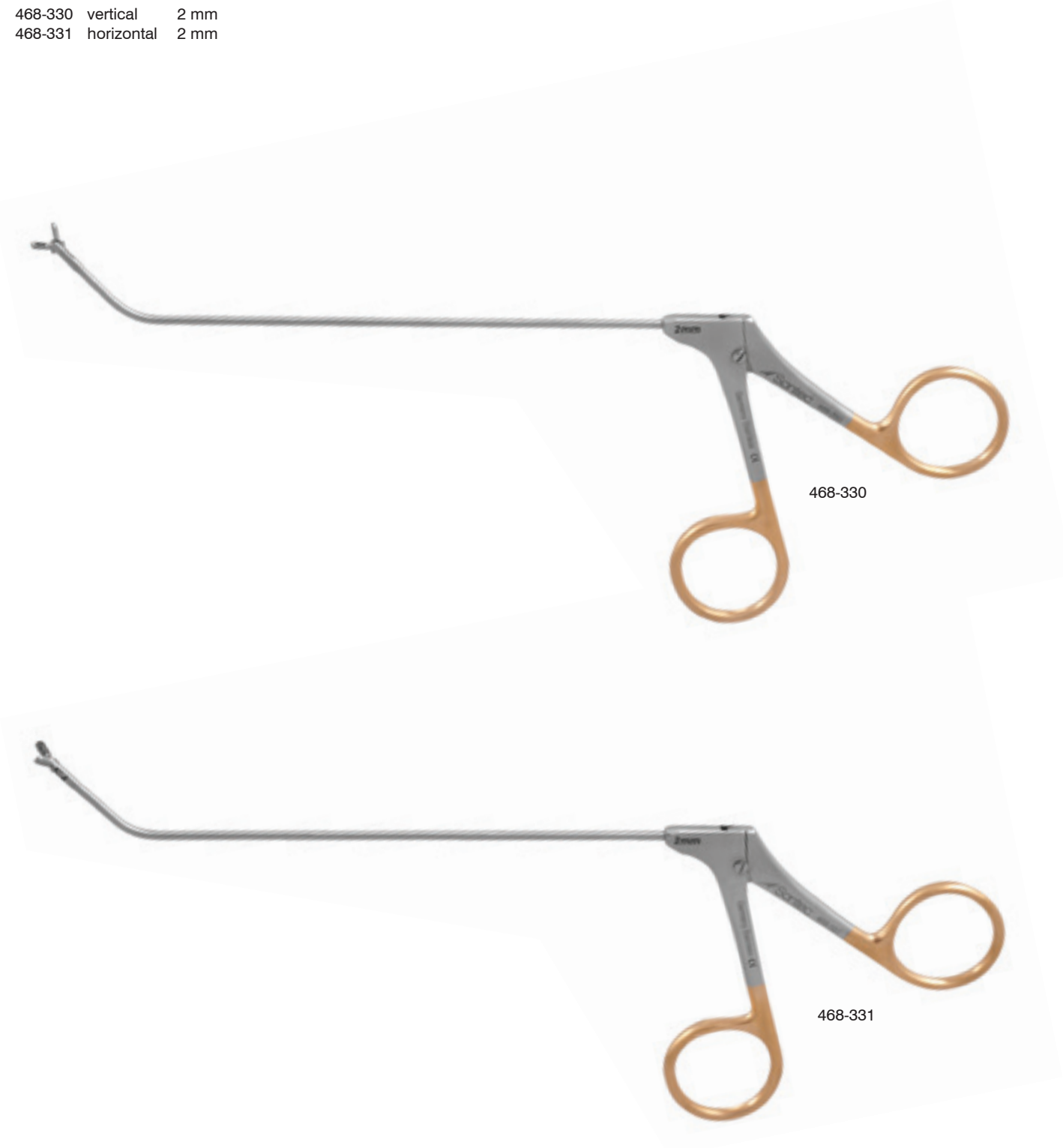

**Frontal Sinus Giraffe Forceps**

Double Action Cup / 45 degrees / 5 1/4" (13.5 cm) shaft

- 468-332 vertical 3 mm
- 468-333 horizontal 3 mm



**Frontal Sinus Giraffe Forceps**

Double Action Cup / 90 degrees / 5 1/4" (13.5 cm) shaft

- 468-334 horizontal 2 mm
- 468-335 vertical 2 mm



**Frontal Sinus Giraffe Forceps**

Double Action Cup / 90 degrees / 5 1/4" (13.5 cm) shaft

- 468-336 horizontal 3 mm
- 468-337 vertical 3 mm

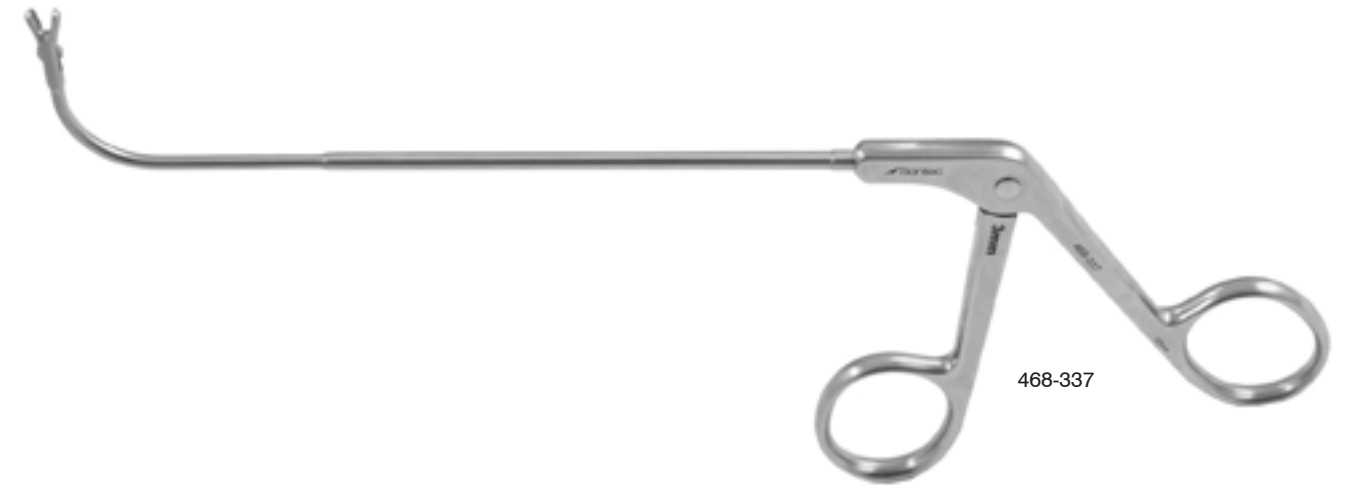

**Frontal Sinus Giraffe Forceps**

**Double Action Cup / 90 degrees / 5 1/4" (13.5 cm) shaft**

- 468-338 vertical 4 mm
- 468-339 horizontal 4 mm



**Frontal Sinus Giraffe Forceps**

**Double Action Cup / 70 degrees / 3 mm / 4 3/4" (12 cm) shaft**

- 468-321 horizontal
- 468-322 vertical

**Double Action Cup / 110 degrees / 3 mm / 4 3/4" (12 cm) shaft**

- 468-325 horizontal
- 468-326 vertical



**Frontal Sinus Giraffe Forceps**

Double Action Cup / 70 degrees/ 4 mm / 4 3/4" (12 cm) shaft

- 468-323 horizontal
- 468-324 vertical

Double Action Cup / 110 degrees/ 4 mm / 4 3/4" (12 cm) shaft

- 468-327 horizontal
- 468-328 vertical



468-323



468-324



468-327

468-328

**Micro Biopsy Forceps with Flexible Shaft**

Flexible shaft / 2.2 round cup jaw / 6" (15.2 cm) flexible shaft

1271-0156



1271-0156

**Foreign Body Removal / Grasping Forceps**

Ring handle / flexible cable shaft designed to glide through desired scope

516-002	serrated jaw 1.2 mm	21 cm
516-003	serrated cup 1.2 mm	21 cm
516-005	serrated jaw 1.0 mm	40 cm
516-006	serrated cup 1.2 mm	40 cm
516-007	serrated jaw 1.2 mm	21 cm
516-008	serrated cup 1.2 mm	21 cm

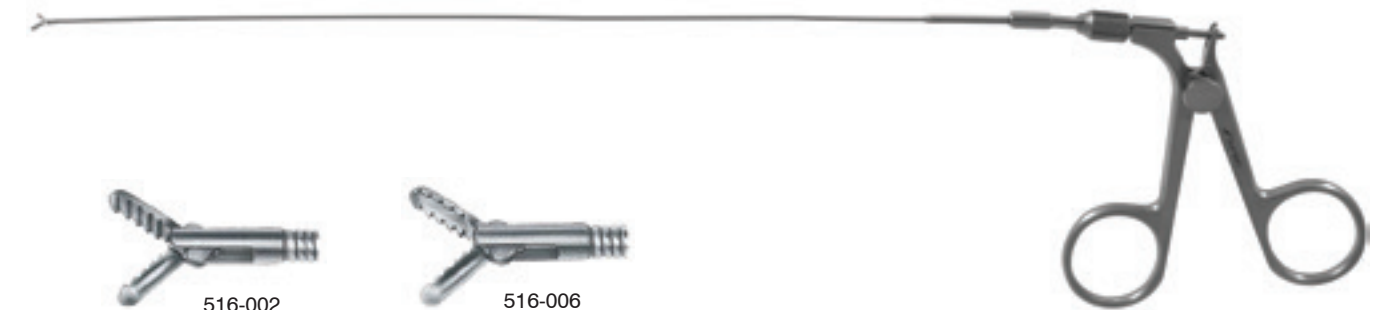

516-002



516-006



516-003



516-007



516-005



516-008

**Jurasz Laryngeal Forceps**

**Single articulating jaws / 9" (23 cm)**

- 502-271 lateral opening jaws
- 502-272 vertical opening jaws left
- 502-273 lateral opening jaws right
- 502-274 vertical opening jaws

**Double articulating jaws / 9" (23 cm)**

- 502-275 lateral opening
- 502-276 vertical opening



502-272



502-273



502-274

**Fraenkel Laryngeal Forceps**

**Foreign body grasping forceps / double articulating jaws / vertical opening / 9" (23 cm)**

502-277



502-277

**Sontec Micro Biopsy Forceps**

**Round cup**

- |          |            |                     |           |
|----------|------------|---------------------|-----------|
| 469-062  | 1.0 mm cup | 3 1/4" (8 cm) shaft |           |
| 469-063  | 2.0 mm cup | 3 1/4" (8 cm) shaft |           |
| 469-063A | 2.0 mm cup | 3 1/4" (8 cm) shaft | angled up |
| 469-063M | 2.5 mm cup | 3 1/4" (8 cm) shaft |           |
| 469-063L | 3.0 mm cup | 3 1/4" (8 cm) shaft |           |
| 469-063X | 4.0 mm cup | 3 1/4" (8 cm) shaft |           |
| 469-081  | 1.0 mm cup | 6" (15 cm) shaft    |           |
| 469-082  | 2.0 mm cup | 6" (15 cm) shaft    |           |
| 469-080  | 2.5 mm cup | 6" (15 cm) shaft    |           |
| 469-083  | 3.0 mm cup | 6" (15 cm) shaft    |           |
| 469-084  | 4.0 mm cup | 6" (15 cm) shaft    |           |
| 469-085  | 5.0 mm cup | 6" (15 cm) shaft    |           |

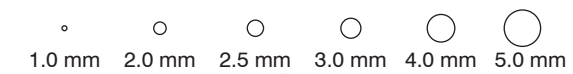

469-063M

**Jackson / Biopsy Forceps**

**Round cup / straight / 11" (28 cm) shaft**

- 1100-771A 2 mm cup
- 1100-769 4 mm cup
- 1100-770 6 mm cup

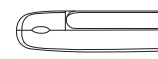
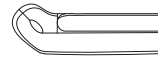

1100-710A



1100-718A

**Round cup / straight / 11 3/4" (29.75 cm) shaft**

- 1100-718A 2 mm cup
- 1100-718B 4 mm cup
- 1100-718C 6 mm cup

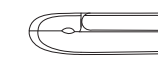
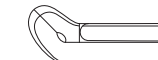

1100-710B



1100-718B

**Round cup / straight / 15 3/4" (40 cm) shaft**

- 1100-720A 2 mm cup
- 1100-720B 4 mm cup
- 1100-720C 6 mm cup



1100-710C



1100-718C

**Round cup / straight / 19 3/4" (51 cm) shaft**

- 1100-722A 2 mm cup
- 1100-722B 4 mm cup
- 1100-722C 6 mm cup

**Round cup / up-angled / 11" (28 cm) shaft**

- 1100-771B 2 mm cup

**Round cup / up-angled / 11 3/4" (29.75 cm) shaft**

- 1100-710A 2 mm cup
- 1100-710B 4 mm cup
- 1100-710C 6 mm cup



1100-710C

**Round cup / up-angled / 15 3/4" (40 cm) shaft**

- 1100-712A 2 mm cup
- 1100-712B 4 mm cup
- 1100-712C 6 mm cup

**Round cup / up-angled / 19 3/4" (51 cm) shaft**

- 1100-714A 2 mm cup
- 1100-714B 4 mm cup
- 1100-714C 6 mm cup

**Round cup / up-angled / 23 3/4" (61 cm) shaft**

- 1100-716A 2 mm cup
- 1100-716B 4 mm cup
- 1100-716C 6 mm cup

**Heyman Septum Alligator Forceps**

**Oval cup**

- 467-331S small
- 467-331M medium
- 467-331L large

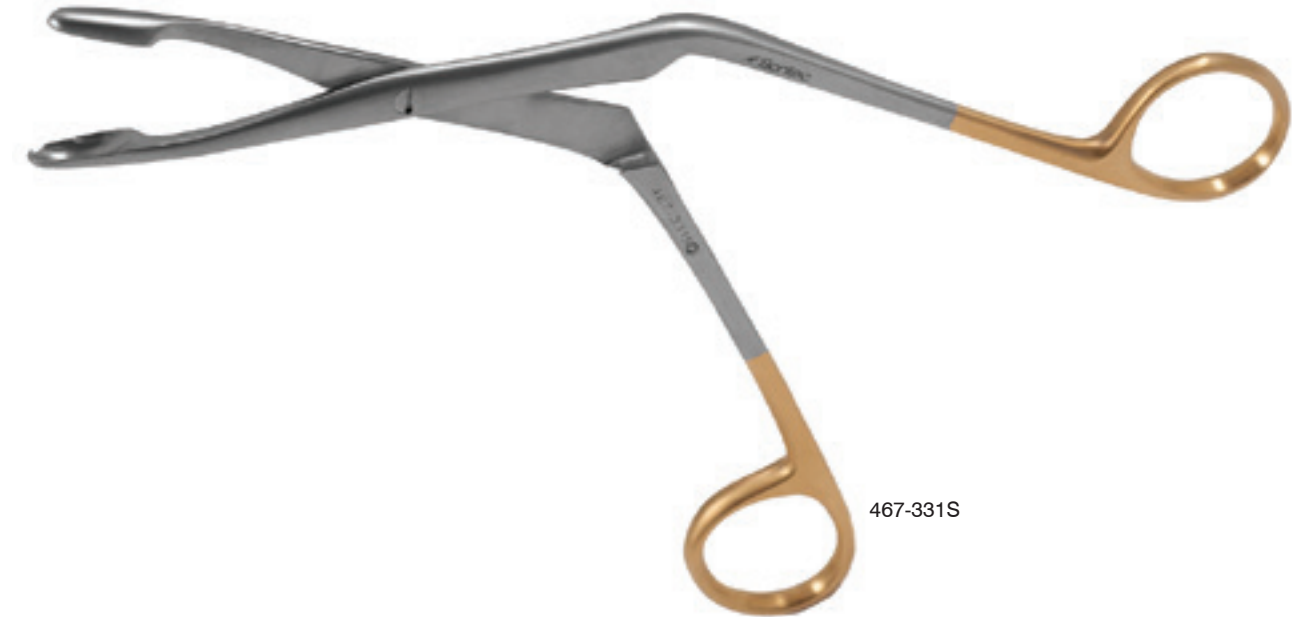

467-331S

**Hartmann Nasal Alligator Forceps**

**Delicate / 7" (19 cm)**

- 467-333



467-333

**Hartmann Ear Alligator Forceps**

Delicate / 2 x 4 mm tip / 5" (12.5 cm)

467-335

Delicate / serrated jaw / 2.5 mm x 6 mm jaw / 5 1/4" (13.3 cm)

467-335E



467-335



467-335E

**Silver Ear Dressing Alligator Forceps**

2.5 mm x 8 mm / grooved jaw / 5 1/4" (13.3 cm)

467-336



467-336

**Tobey Ear Dressing Forceps**

Extra-delicate / 2 mm x 4 mm / 5 1/4" (13.3 cm)  
467-334



**Hartman Ear Forceps**

6 1/2" (16.5 cm)  
467-350



**Sontec Septal Platform Forceps**

7 1/4" (18.4 cm)  
467-332



467-332

**Sontec Septal Platform Forceps Titanium**

Serrated jaws / 11 mm x 21 mm / 7" (17.8 cm)  
469-033T



469-033T

**Carroll Tendon Pulling Forceps**

4.5" shaft (11.4 cm) / serrated jaws  
350-805 curved down  
350-807 curved up



350-805

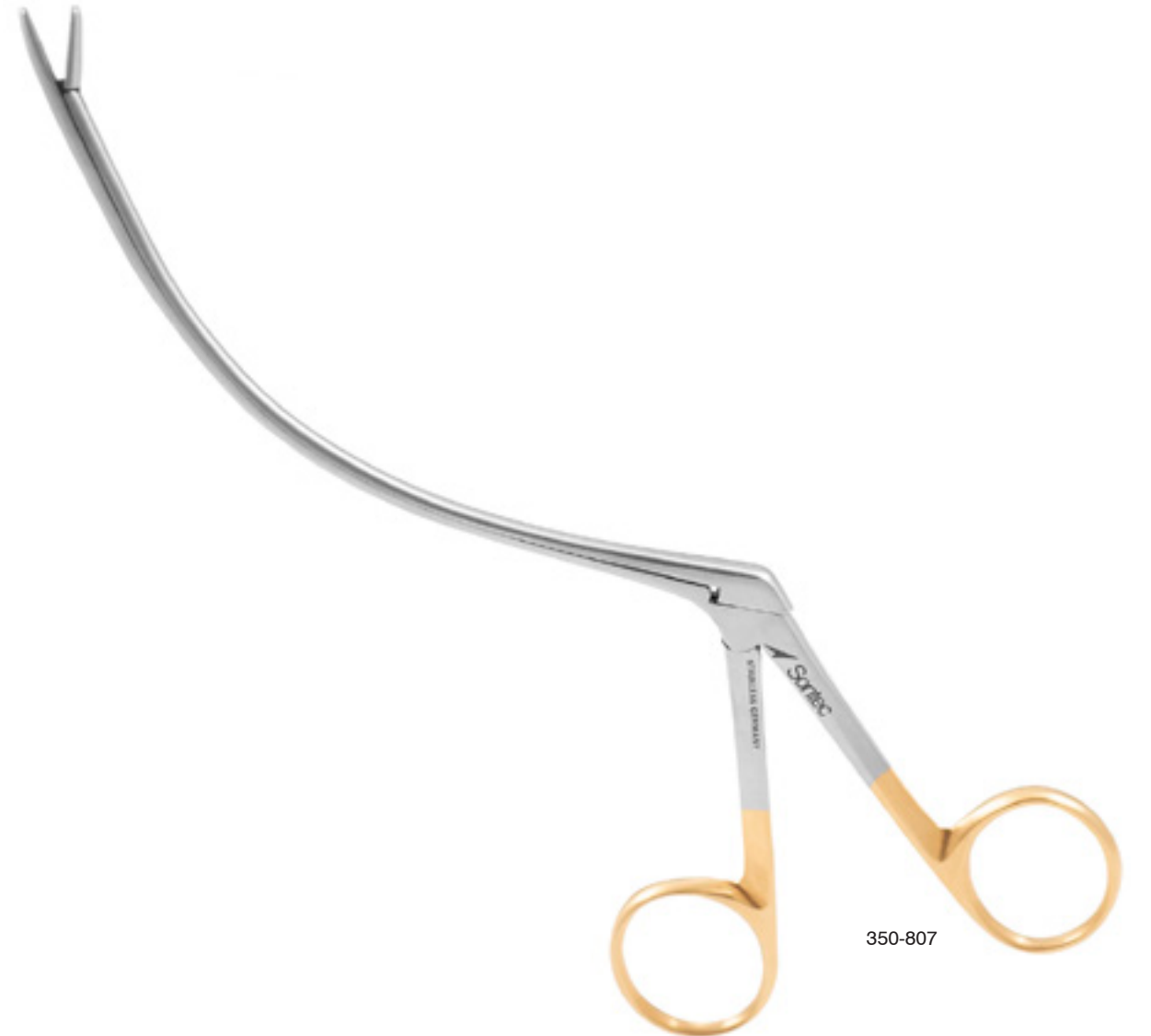

350-807

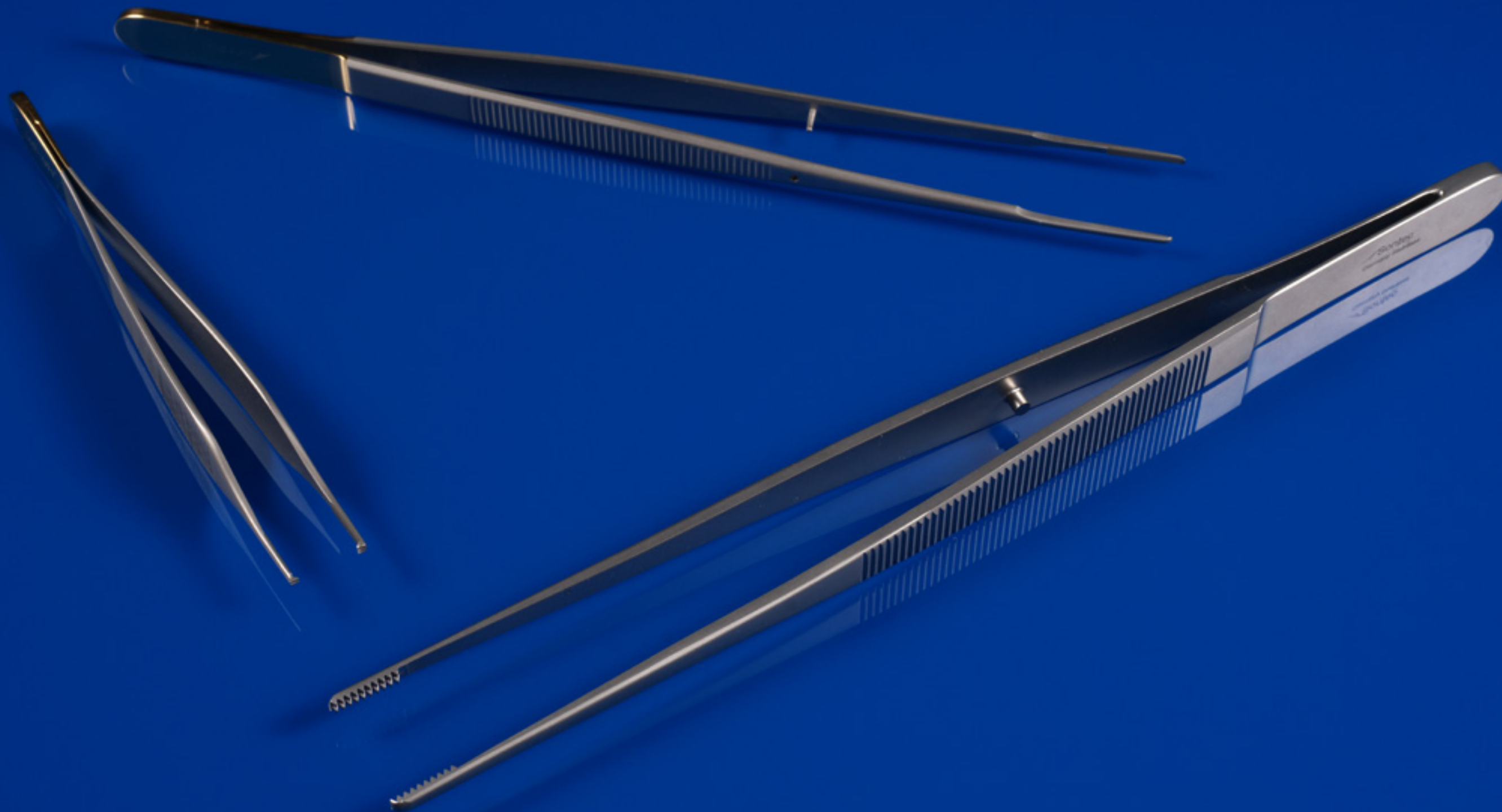

 Sontec Instruments®

**FORCEPS Flat Handle**

**DeBakey Needle Pulling Tissue Forceps Titanium**

1 mm / atraumatic tip / straight / 9" (23 cm)

2600-5863 flat serrated handle

2 mm / atraumatic tip / straight / 8" (20.5 cm)

2600-5860 flat fenestrated handle

2600-5862 flat serrated handle



2600-5863



2600-5860



2600-5862

**DeBakey Vascular Forceps Titanium**

1 mm / straight / fenestrated handle

2600-3611 6" (15 cm) 5 hole handle

2600-3641 8" (20 cm) 6 hole handle

2600-3651 9 1/2" (24 cm) 6 hole handle



2600-3611



2600-3641

**DeBakey Forceps Titanium**

1.2 mm Tip / Tapered Shaft / Short Flat Handle / Straight / Lightweight / 7 3/4" (20cm)

2600-350



2600-350

**Micro Tying Forceps Titanium**

Flat handle / TC dust / straight / 0.4 mm / 6" (15 cm)

2600-499



2600-499

**Micro Tying Forceps**

Flat handle / TC dust / with platform / straight / 0.5 mm / 7 1/4" (18.4 cm)

2200-245



2200-245

**Micro Tying Forceps**

Flat serrated handle / straight / 0.75mm / 6" (15.2 cm)

2600-498



2600-498

**DeBakey Premier Knurled Handle Forceps Titanium**

Flat Handle / DeBakey tip

2600-340 1.8 mm tip 2 x 3 teeth 9 1/2"

2600-341 1.4 mm tip 2 x 3 teeth 9 1/2" delicate

2600-345 1.2 mm tip 1 x 2 teeth 7 3/4"



2600-340



2600-341



2600-345

**DeBakey Tissue Forceps Titanium**

**Atraumatic Jaw / straight**

2600-361	1 mm	6" (15 cm)
2600-355	1.5 mm	6" (15 cm)
2600-367	2 mm	6" (15 cm)
2600-362	1 mm	7" (17.8 cm)
2600-374	1.5 mm	7 1/4" (18.4 cm)
2600-373	3 mm	7 1/4" (18.4 cm)
2600-364	1 mm	7 3/4" (19.5 cm)
2600-363	1.5 mm	7 3/4" (19.5 cm)
2600-357	2.5 mm	7 3/4" (19.5 cm)
2600-369	2 mm	7 3/4" (19.5 cm)
2600-370	3 mm	7 3/4" (19.5 cm)
2600-366	1.2 mm	8" (20 cm)
2600-365	1 mm	9 1/2" (24 cm)
2600-359	2.7 mm	9 1/2" (24 cm)
2600-371	2 mm	9 1/2" (24 cm)
2600-3714	2 mm	12" (30.5 mm)



**Angled / 2 mm**

2600-375	6" (15 cm)
2600-376	7 1/4" (18.4 cm)
2600-377	7 3/4" (19.5 cm)
2600-379	9 1/2" (24 cm)



2600-366



2600-377



2600-357



2600-370

**Original DeBakey Forceps**

**Flat Handle / 3.5 mm tip / 9 1/2" (24 cm)**

2200-114

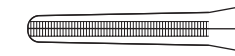

2200-114

**DeBakey Vascular Forceps**

**6" (15 cm)**

1100-183 1.5 mm tip fenestrated handle



1.5 mm DeBakey tip



1100-183

**Dietrich-DeBakey Tissue Forceps**

**Flat handle / 1.5 mm tip**

442-236	6" (15 cm)
442-238	7 3/4" (19.5 cm)
442-239	7 3/4" (19.5 cm) 45° angle
442-240	9 1/2" (24 cm)



1.5 mm

**Flat handle / 1.2 mm tip / with pin / 7 3/4"**

442-238P



442-236



442-238



442-239



442-238P

### DeBakey Tissue Forceps

#### Flat handle / 6" (15 cm)

- 2200-101 1.0 mm tip
- 2200-101A 1.5 mm tip
- 2200-105 2.0 mm tip
- 2200-105A 2.5 mm tip
- 2200-105B 2.8 mm tip

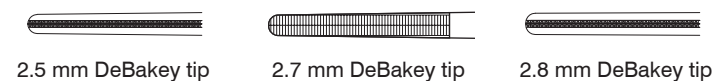

#### Flat handle / 7 3/4" (19.5 cm)

- 2200-102 1.0 mm tip
- 2200-102A 1.5 mm tip
- 2200-107 2.0 mm tip
- 2200-110 2.7 mm tip
- 2200-112 3.5 mm tip

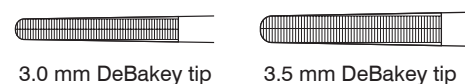

#### Flat handle / 9 1/2" (24 cm)

- 2200-103 1.5 mm tip
- 2200-108 2.0 mm tip
- 2200-111 2.7 mm tip
- 2200-1133 3.0 mm tip
- 2200-113 3.5 mm tip

#### Flat handle / 12" (30 cm)

- 2200-104 1.5 mm tip
- 2200-109 2.0 mm tip
- 2200-1112 2.7 mm tip
- 2200-1132 3.5 mm tip

#### With pin / flat handle / 7 3/4" (19.5 cm)

- 2200-107P 2.0 mm tip
- 2200-110P 2.7 mm tip

#### With pin / flat handle / 9 1/2" (24 cm)

- 2200-108P 2.0 mm tip
- 2200-111P 2.7 mm tip

#### With pin / flat handle / 12" (30 cm)

- 2200-1112P 2.7 mm tip

\* other sizes available with pin upon request.



2200-105



2200-110P



2200-111P

### DeBakey Needle-Pulling Tissue Forceps

#### Flat handle / TC platform / 6" (15 cm)

- 2200-074 1.0 mm
- 2200-077 1.2 mm
- 2200-078 1.5 mm
- 2200-080 2.0 mm
- 2200-079 2.7 mm
- 2200-081 3.5 mm



#### Flat handle / TC platform / 8" (20 cm)

- 2200-075 1.0 mm
- 2200-096 1.2 mm
- 2200-097 1.5 mm
- 2200-100 2.0 mm
- 2200-099 2.7 mm
- 2200-099P 2.7 mm with guide pin
- 2200-098 3.2 mm
- 2200-098P 3.2 mm with guide pin



2200-097

#### Flat handle / TC platform / 9 1/2" (24 cm)

- 2200-076 1.0 mm
- 2200-085 1.5 mm
- 2200-092 2.0 mm
- 2200-091 2.7 mm
- 2200-090 3.5 mm
- 2200-090P 3.5 mm with guide pin

#### Flat handle / TC platform / 12" (30 cm)

- 2200-0922 2 mm
- 2200-0912 2.7 mm
- 2200-0902 3.5 mm

### DeBakey Angled Tissue Forceps

#### Flat Handle / 40° angle

- 2200-106 2.0 mm 6"
- 2200-107C 2.0 mm 7 3/4"
- 2200-107A 2.7 mm 7 3/4"
- 2200-103A 1.5 mm 9 1/2"
- 2200-108A 2.0 mm 9 1/2"
- 2200-1132A 3.5 mm 12"



2200-107C



2200-103A

**DeBakey Thoracic Forceps**

**Flat handle / 2.5 mm tip**

- 442-210 6" (15 cm)
- 442-212 7 3/4" (20 cm)
- 442-214 9 1/2" (24 cm)
- 442-216 12" (30.5 cm)

**Flat handle / 2.8 mm tip / 12" (30.5 cm)**

442-219

**Flat handle / 3.5 mm tip / 14" (35.5 cm)**

442-215



**DeBakey Thoracic Forceps**

**Flat handle / 3.0 mm tip**

- 442-2103 6" (15.24 cm)
- 442-2123 7 3/4" (20 cm)
- 442-2143 9 1/2" (24.13)
- 442-218 10" (25.4 cm)



**DeBakey Ergonomic-Handle Forceps**

**Extra lightweight / 1.0 mm tip / fenestrated handle**

- 2200-101F 6" (15 cm)
- 2200-102F 7 7/8" (20 cm)
- 2200-103F 9 1/2" (24 cm)
- 2200-104F 12" (30 cm)

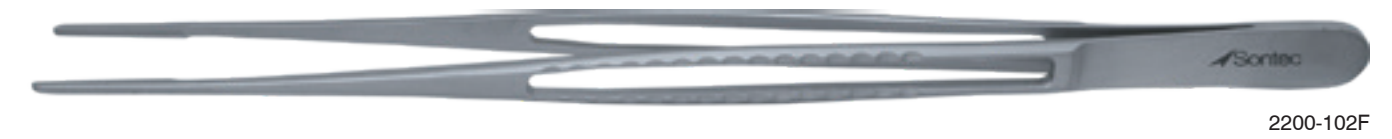

**DeBakey Ergonomic-Handle Forceps Titanium**

**Extra lightweight / 1.0 mm tip / fenestrated handle / 9 1/2" (24 cm)**

2600-593 9 1/2" (24 cm)



**Electro Blue Coated DeBakey Forceps**

**Monopolar use / insulated / 2.0 mm tip / flat handle**

- 2200-105C 6" (15 cm)
- 2200-107B 7 3/4" (19.5 cm)
- 2200-108B 9 1/2" (24 cm)
- 2200-109B 12" (30 cm)



**Monopolar use / insulated / flat handle / 12" (30 cm)**

- 2200-1112B 2.7 mm tip
- 2200-1132B 3.0 mm tip

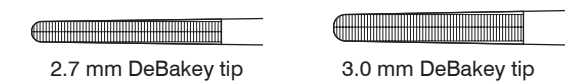

**Cooley Vascular Tissue Forceps**

**2.0 mm tip**

- 442-242 6 1/4" (16 cm)
- 442-244 7 3/4" (19.5 cm)
- 442-246 9 1/2" (24 cm)



442-244

**Gerald Tissue Forceps**

**DeBakey tip / 1 mm tip / 7" (18 cm)**

2200-150

**DeBakey tip / 8" (20.5 cm)**

- 2200-152 1 mm tip
- 2200-152N 1.5mm tip narrow handle



DeBakey tip



2200-150



2200-152N

**Gerald Brown Tissue Forceps**

**Flat handle / 8x8 teeth / 7" (18 cm)**

140-389



140-389

**Gerald Lightweight Micro Tissue Forceps Titanium**

**1 mm tip / TC Dust**

- 2600-384 7" (18 cm)
- 2600-388 8" (20 cm)

**Serrated tip / dressing**

- 2600-385 7" (18 cm)
- 2600-385S 8" (20 cm)

**Tissue / 1 x 2 Teeth**

- 2600-387 7" (18 cm)
- 2600-389 8" (20 cm)

**1 mm platform Tip / TC Dust**

- 2600-490 7" (18 cm)
- 2600-491 8" (20 cm)

**1 mm ring Tip / TC Dust**

- 2600-492 7" (18 cm)
- 2600-493 8" (20 cm)

**1 mm DeBakey Tip**

- 2600-495 7" (18 cm)
- 2600-496 8 1/4" (21 cm)
- 2600-497 7 7/8" (20 cm) wide handle
- 2600-494D 9 1/2" (24 cm)

**1 mm serrated tip**

- 2600-494 9 1/2" (24.1 cm)
- 2600-494A 9 1/2" (24.1 cm) 45° angled on the flat

**1 mm platform ring tip / TC Dust**

- 2600-492P 7" (17.8 cm)
- 2600-493P 8" (20.3 cm)
- 2600-493P1 9" (22.9 cm)

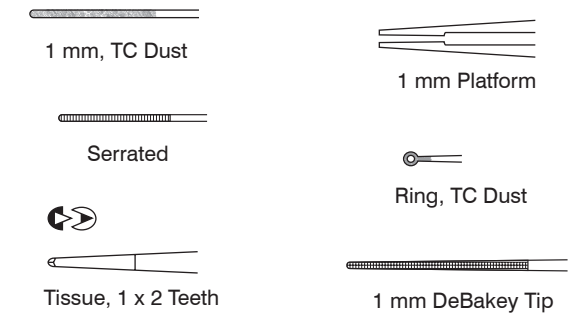

2600-490

2600-491



2600-496



2600-497



2600-495



2600-494



2600-494A

**Gerald Tissue Forceps**

**Serrated / 7" (18 cm)**

- 2200-130 straight
- 2200-131 curved

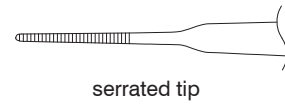

2200-130

**Cross-serrated**

- 2200-132 7 3/4" (18 cm)
- 2200-133 8" (20.5 cm)
- 2200-135 9" (23 cm)
- 2200-134 10" (25.5 cm)

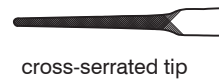

**TC platform**

- 2200-142 7" (18 cm)
- 2200-144 8" (20.5 cm)
- 2200-145 9" (23 cm)
- 2200-141A 9" (23 cm) 45° angle
- 2200-146 10" (25.5 cm)

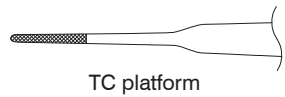

2200-142

**TC dust**

- 2200-138 7" (18 cm)
- 2200-140 8" (20.5 cm)
- 2200-141 9" (23 cm)

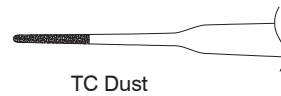

**TC dust / ring tip / 7" (18 cm)**

- 2200-154 straight
- 2200-155 curved



**Delicate / straight / 1 x 2 teeth / 0.5 mm micro tip / 7" (18 cm)**

- 2200-1365



2200-1365

**1 x 2 teeth / 0.8 mm tip / micro / 7" (18 cm)**

- 2200-136 straight
- 2200-137 curved

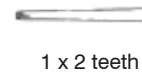

**1 x 2 teeth / 1 mm tip / 7" (18 cm)**

- 140-372 straight TC serrated
- 140-374 curved TC serrated
- 2200-129 straight



140-372

**Micro Gerald Tissue Forceps**

**Round handle / TC serrated platform / 0.9 mm tip**

- 2200-1431 7 1/4"
- 2200-1441 8 1/4"



2200-1431

**Brown Tissue Forceps**

**9 x 9 teeth**

- 136-690 6" (15.5 cm)
- 136-692 8" (20.5 cm)
- 136-694 10" (25.5 cm)



136-690

**9 x 9 teeth / TC**

- 136-691 6" (15.5 cm)
- 136-695 10" (25.4 cm)

**McGravey Tissue Forceps**

**5 x 6 delicate teeth**

- 136-766 7" (18 cm)
- 136-767 9" (22.9 cm)



136-766

**Russian Tissue Forceps**

- 136-771 6" (15.5 cm)
- 136-773 8" (20.5 cm)
- 136-775 10" (25.5 cm)
- 136-776 12" (30.5 cm)



136-773

**Sontec D'Errico Tissue Forceps**

- 136-769 7 1/4" (18.45 cm)



136-769

**Selman Tissue Forceps**

**Round cup teeth**

- 142-112 6" (15.5 cm)
- 142-113 8" (20.3 cm)
- 142-114 10" (25.4 cm)



142-113

**Singly Tuttle Forceps**

**Serrated**

- 142-103 6" (15 cm)
- 142-108 7" (18 cm)
- 142-110 9" (23 cm)
- 2200-0175 9" (23 cm) large ring
- 142-107 10" (25 cm)
- 142-111 12" (30 cm)
- 142-104 14" (35.5 cm)
- 142-106 16" (40.5 cm)



142-108



**Wangensteen Tissue Forceps**

**TC Serrated**

- 2200-015 6" (15 cm)
- 2200-016 8" (20 cm)
- 2200-017 9" (23 cm)
- 2200-018 10" (25.5 cm)



2200-017

**Evans Tissue Forceps**

**TC serrated / 10" (25 cm)**

- 2200-382



2200-382

**Resano Brown Vascular Forceps**

- 2200-376 7 1/8" (18.25 cm) 9 x 9
- 2200-377 9 1/8" (23.5 cm) 9 x 9
- 2200-377W 9 1/8" (23.5 cm) wide handle 11 x 11
- 2200-378 12 1/2" (31 cm) 9 x 9

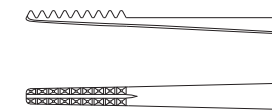

2200-376



2200-377



2200-377W



2200-378

**Resano Brown Vascular Forceps**

- 2200-361 7 1/8" (18.5 cm) 9 x 9 TC platform
- 2200-362 9 1/8" (23.5 cm) 9 x 9 TC platform
- 2200-362W 9 1/8" (23.5 cm) 11x11 TC platform wide handle



2200-361



2200-362



2200-362W

**Resano Brown Vascular Forceps Titanium**

**9 x 9 teeth**

- 2600-380 7 1/8" (18cm)
- 2600-381 9 1/8" (23.5 cm) wide handle
- 2600-382 12" (30 cm)

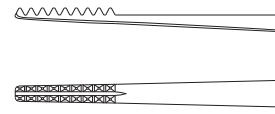

2600-380



2600-381

**Resano Double Action Vascular Forceps Titanium**

**Double action / straight**

- 2601-300 11" (28 cm)



**Potts Smith Tissue Forceps**

**1 mm tip**

- 2200-030 6 1/4" (16 cm) TC dust
- 2200-032 7 1/8" (19 cm) TC dust
- 2200-034 8" (20 cm) TC dust
- 2200-036 9 3/4" (24 cm) TC dust
- 2200-029 9" (23 cm) TC serrated



2200-032

**2 mm Tip / TC Dust**

- 2200-040 6 1/4" (16 cm)
- 2200-042 7 1/8" (19 cm)
- 2200-044 8" (20 cm)
- 2200-046 9 3/4" (24 cm)



2200-046

**2 mm Tip / TC Serrated**

- 2200-041 6 1/2" (16.5 cm)
- 2200-043 7" (18 cm)
- 2200-045 8" (20 cm)
- 2200-0459 9" (23 cm)
- 2200-047 10" (25 cm)



2200-047

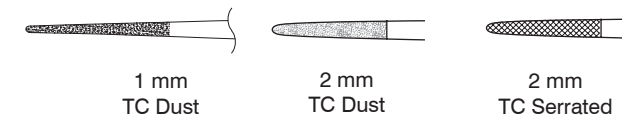

**Potts Cooley Tissue Forceps**

Serrated / 1 mm

- 2205-650 7 3/4" (19.7 cm)
- 2205-655 9 1/2" (23.5 cm)



2205-655

**Electro Blue Coated Potts-Smith Tissue Forceps**

Monopolar use / TC serrated platform / insulated / flat handle / 9 1/4" (23.5 cm)

- 2200-073B straight 2.5 mm tip 9 1/4" (23.5 cm)
- 2200-074B angled 2.5 mm tip 9 1/4" (23.5 cm)
- 2200-073C straight 1.5 mm tip 9" (22.9 cm) 1x2 teeth
- 2200-073D straight 2.5 mm tip 9 3/4" (24.8 cm)



2200-073B



2200-074B



2200-073C



2200-073D

**Potts Nevins Forceps**

TC serrated / 1.8 mm tip / 7 1/4" (18.4 cm)

140-273



140-273

**Potts-Smith Dressing**

Serrated

- 136-730 7" (18 cm)
- 136-738 8" (20.3 cm)
- 136-735 8 1/4" (21 cm)
- 136-740 9 1/2" (24 cm)
- 136-746 12" (30 cm)



136-740

**Potts-Smith Tissue Forceps**

Serrated / 1 x 2 teeth

- 136-732 7" (18 cm)
- 136-737 8 1/4" (21 cm)
- 136-742 9 1/2" (24 cm)
- 136-748 12" (30 cm)



136-737

**Reul Coronary Artery Forceps**

TC serrated / 1 mm / 8" (20 cm)

2200-126



2200-126

**Cushing Tying Forceps**

Standard / straight tip / 7" (18 cm)

- 2200-789 serrated
- 2200-790 1x2 teeth



2200-789

TC insert platform / straight tip

- 2200-383 7" (18 cm)

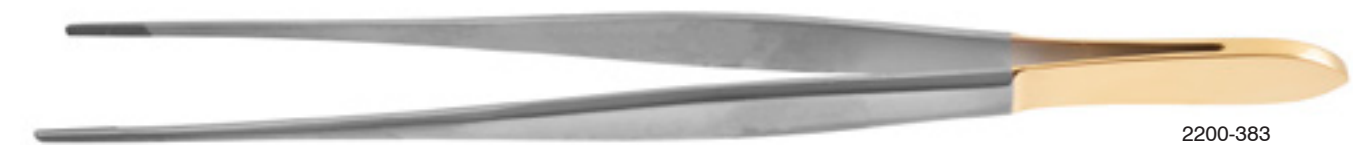

2200-383

TC insert platform / 7" (18 cm)

- 2200-387 angled tip
- 2200-389 straight tip 1x2 teeth

TC insert platform / straight tip / serrated

- 2200-394 8 1/4" (21 cm)
- 2200-396 10" (25 cm)



Straight



Angled

**Cushing Forceps Titanium**

1 mm Tip / serrated / lightweight

- 2600-335 7" (18cm)
- 2600-339 8 1/4" (21cm)



2600-335

1 mm



2600-339

**Thumb Forceps Titanium**

Serrated Handle / TC Dust tip

- 136-612T 6 1/4" (16 cm)
- 136-616T 7 7/8" (20 cm)



136-612T



136-616T

**Tissue Forceps with TC Inserts**

TC platform / 6" (15.2 cm)

- 1100-732 1 x 2 teeth
- 1100-733 2 x 3 teeth
- 1100-7334 3 x 4 teeth
- 1100-7335 4 x 5 teeth



1100-733

**Skinner Tissue Forceps**

1 x 2 teeth / TC platform / 8" (20.5 cm)

- 140-517M micro
- 140-517 delicate
- 140-517G standard



standard tip

delicate tip

micro tip

1 x 2 teeth / TC platform / 9" (23 cm)

- 140-379 micro
- 140-378 delicate
- 140-376 standard

1 x 2 teeth / TC platform / 10" (25.5 cm)

- 140-519M micro
- 140-519 delicate
- 140-519G standard



140-376

**Electro Blue Coated Skinner Tissue Forceps**

Monopolar use / TC serrated platform / 1 x 2 teeth / insulated / 9" (22.9 cm)

140-376B



140-376B

**Semken Forceps**

Dressing / serrated

136-702 4 3/4" (12 cm)

136-704 6" (15.5 cm)

Tissue / 1 x 2 teeth / delicate / 0.7mm tip / 4 3/4" (12 cm)

136-701

Tissue / 1 x 2 teeth

136-706 5" (13 cm)

136-708 6" (15.5 cm)

Tissue / TC platform / 1 x 2 teeth

140-350 5 3/4" (15 cm)

140-358 6 1/4" (16 cm)

140-364 7" (18 cm)

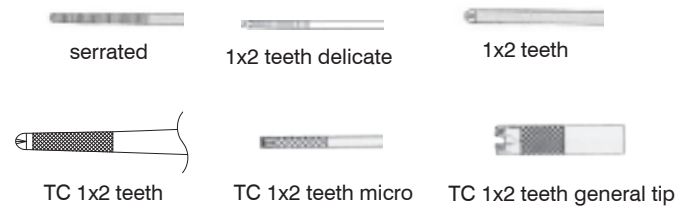

140-350



140-364

Tissue / TC platform / 1 x 2 teeth / micro

140-352 5 3/4" (15 cm)

140-360 6 1/4" (16 cm)

140-366 7" (18 cm)

Tissue / TC platform 1 x 2 teeth / general

140-354 5 3/4" (15 cm)

140-362 6 1/4" (16 cm)

140-368 7" (18 cm)

140-369 8" (20.5 cm)

**Ferris-Smith Tissue Forceps**

6 3/4" (17 cm)

136-711 1x2 teeth

136-712 2x3 teeth

140-382 2x3 teeth TC platform

140-3821 1x2 teeth TC platform



136-712



140-382



140-3821

**Oehler Forceps**

TC serrated / 1 x 2 teeth

140-512 6 1/2" (16.5 cm)

140-514 7" (17.8 cm)



140-512



140-514

**Tissue Forceps with Teeth**

**1 x 2 teeth**

136-621	4 1/2" (11.5 cm)	
136-624	5" (12.7 cm)	
136-626	5 1/2" (14 cm)	
136-626F	5 1/2" (14 cm)	fine tip
136-629	6" (15.5 cm)	
136-632	7" (18 cm)	
136-632B	7" (18 cm)	electro blue coated
136-634	8" (20.5 cm)	
136-634D	8" (20.5 cm)	delicate
136-636	10" (25.5 cm)	
136-636D	10" (25.5 cm)	delicate



136-632B



136-626F



136-634B

**2 x 3 teeth**

136-639	5" (12.7 cm)	
136-633	5" (12.7 cm)	TC serrated
136-640	5 1/2" (14 cm)	
136-637	5 1/2" (14 cm)	TC serrated
136-642	6" (15.5 cm)	
1100-179	6 1/4" (16 cm)	
136-641	6 1/4" (16 cm)	TC serrated
1100-165	7" (18 cm)	
136-643	7" (18 cm)	TC serrated
1100-167	8" (20 cm)	
136-645	8" (20 cm)	TC serrated
1100-187	9 3/4" (25 cm)	
136-649	9 3/4" (25 cm)	TC serrated
1100-169	10" (25 cm)	
136-651	10" (25 cm)	TC serrated



136-640

**3 x 4 teeth**

136-644	5 1/2" (14 cm)	
136-652	5 1/2" (14 cm)	TC serrated
136-646	6" (15 cm)	

**4 x 5 teeth**

136-648	5 1/2" (14 cm)	
136-653	5 1/2" (14 cm)	TC serrated
136-650	6" (15.5 cm)	
136-6508	8" (20.3 cm)	

**McIndoe Forceps Titanium**

Fine tip / serrated handle / serrated / 6" (15.2 cm)

2600-391	1 x 2 teeth
2600-392	serrated



2600-391



2600-392

**McIndoe Dressing and Tissue Forceps**

Fine serrations / 6" (15 cm)

2200-750



2200-750

Cross serrations with 1x2 teeth / 6" (15 cm)

2200-752



2200-752

**Thumb Dressing Forceps**

**Serrated**

136-600	4" (10 cm)
136-602	4 1/2" (11.5 cm)
136-605	5" (13 cm)
136-607	5 1/2" (14 cm)
136-610	6" (15.5 cm)
136-613	7" (18 cm)
136-615	8" (20.5 cm)
136-617	10" (25.5 cm)
136-619	12" (30.5 cm)



**TC serrated**

1100-739B	6" (15.5 cm)
1100-739A	7" (18 cm)



136-607

**Ferlit Micro Forceps**

**1 x 2 teeth / cross serrated tying platform**

140-504A	7" (18cm)	1.5 mm
140-504B	4" (10cm)	0.9 mm

**1 x 2 teeth / TC Dust / 0.5 mm teeth / 4 1/4" (10.8 cm)**

140-505T



platform



140-505T



140-504B



**Bonney Tissue Forceps**

**Serrated / 6 3/4" (17 cm)**

140-502	1 x 2 teeth	TC serrated
136-578	2 x 3 teeth	serrated

**1 x 2 / 7" (18 cm)**

136-580	serrated
140-500	TC serrated



1 x 2 teeth



2 x 3 teeth



140-502



136-578



136-580

**Duehrssen Tissue Forceps**

1 x 2 teeth / 8" (20.3 cm)  
136-590



136-590

**Gillies Forceps**

Fine serrations / 1 x 2 teeth / 6" (15 cm)  
2200-700



2200-700

**Long Tissue Forceps**

12" (30 cm)

1100-859 1 x 2 teeth  
1100-858 2 x 3 teeth



1 x 2 teeth



2 x 3 teeth



TC platform



1100-859

TC platform / 12" (30 cm)

1100-863 1 x 2 teeth  
1100-862 2 x 3 teeth

14" (35.5 cm)

1100-874 1 x 2 teeth  
1100-878 2 x 3 teeth

TC platform / 14" (35.5 cm)

1100-875 1 x 2 teeth  
1100-879 2 x 3 teeth

16" (40.5 cm)

1100-876 1 x 2 teeth  
1100-880 2 x 3 teeth



1100-880

TC platform / 16" (40.5 cm)

1100-877 1 x 2 teeth  
1100-881 2 x 3 teeth



1100-861

18" (45.5 cm)

1100-861 1 x 2 teeth  
1100-860 2 x 3 teeth



1100-861

TC platform / 18" (45.5 cm)

1100-865 1 x 2 teeth  
1100-864 2 x 3 teeth

**Hudson-Ewald Forceps**

Heavy / serrated adson handle / 4 3/4" (12 cm)

- 136-684 1 x 2 teeth
- 136-680 serrated tip

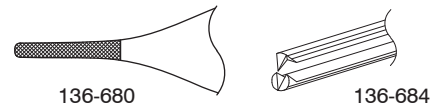

**Troutman Micro Hook Forceps**

With tying platform / TC dust / round handle

- 199-365S 5" (12.5 cm)
- 199-365 6 1/4" (16 cm)
- 199-365T 6 1/4" (16 cm) titanium

Adson handle

- 199-368 4 3/4" (12 cm)



**Adson Tissue Forceps Titanium**

TC dust / 1.0 mm tips / 4 3/4" (12 cm)

- 140-298T



**Adson Tissue Forceps Titanium**

1 x 2 / TC dust / tying platform / 4 3/4" (12 cm)

- 140-304T



**Adson Tissue Forceps Titanium**

TC dust / with tying platform / 0.6 mm / 4 3/4" (12 cm)

- 140-296T



**Adson Tissue Forceps Titanium**

TC dust / 0.3 mm / 1 x 2 tip / 4 3/4" (12 cm)

- 140-297T



**Adson Tissue Forceps Titanium**

With tying platform / TC dust / 1x2 teeth / 6" (15.2 cm)

- 2600-307



**Adson Tissue Forceps Titanium**

Serrated handle / TC dust / 0.5 mm / 1 x 2 tip / 4 3/4" (12 cm)

- 140-302T



**Adson-Harris Ring Tip Forceps Titanium**

Fenestrated / 1 mm ring-tip / TC dust / 4 3/4" (12 cm)

- 1103-812T



**Adson Tissue Forceps Titanium**

1 x 2 Teeth

- 2600-302 4 3/4"
- 2600-311 5 7/8"



**Gorney-Adson Forceps**

1 x 2 teeth with platform / stop pin / 4 3/4" (12 cm)

- 136-6741



**DeBakey-Adson Tissue Forceps**

1.5 mm / atraumatic DeBakey jaws / 4 3/4" (12 cm)

- 1100-185



**Adson Tissue Forceps**

**1 x 2 teeth / serrated handle / 4 3/4"**

- 136-668 0.8 mm
- 136-666 1.3 mm
- 136-672 1.3 mm 45° angled tips



136-666

**1 x 2 teeth / serrated handle / 6"**

- 136-683 0.8 mm
- 136-682 1.3 mm

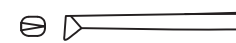

**1 x 2 teeth / serrated handle / TC dust platform / 6"**

- 136-682P 1.3 mm



136-672

**1 x 2 teeth / fenestrated handle / 4 3/4"**

- 136-669 1.0 mm
- 136-667 1.3 mm

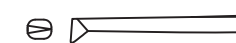

**2 x 3 teeth / serrated handle / 4 3/4"**

- 136-676 1.0 mm



136-682P



136-669



136-676



2 x 3 teeth

**Beasley-Babcock Tissue Forceps**

**Serrated adson handle / 5 x 6 teeth / 5" (13 cm)**

- 136-699



136-699



**Adson Tissue Smooth Platform Forceps**

**1 x 2 teeth / smooth platform / serrated handle / 4 3/4"**

- 136-668A 0.8 mm
- 136-674D 1.0 mm
- 136-674 1.3 mm



136-674



**1 x 2 teeth / smooth platform / fenestrated handle / 4 3/4"**

- 136-679 1.3 mm



136-679

**Adson Tissue TC Dust Platform Forceps**

**1 x 2 teeth / TC Dust platform / serrated handle / 4 3/4"**

- 140-302D 0.8 mm
- 140-302 1.0 mm

**1 x 2 teeth / TC Dust platform / fenestrated handle / 4 3/4"**

- 140-302F 0.8 mm
- 140-303F 1.0 mm



140-303F

**Adson Tissue TC Serrated Platform Forceps**

1 x 2 teeth / TC serrated platform / serrated handle / 4 3/4"

- 140-305 1.0 mm
- 140-304 1.3 mm
- 140-303 1.8 mm

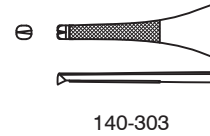

140-304

1 x 2 teeth / TC serrated platform / serrated handle / 6"

- 140-207 0.8 mm
- 140-309 1.0 mm
- 140-202 1.3 mm
- 140-203 1.8 mm



140-309

1 x 2 teeth / TC serrated platform / fenestrated handle / 4 3/4"

- 140-305F 1.0 mm
- 140-3042 1.3 mm
- 140-3032 1.8 mm



140-305F

2 x 3 teeth / TC serrated platform / serrated handle / 4 3/4"

- 140-306 0.8 mm
- 140-307 2.0 mm



140-307

2 x 3 teeth / TC serrated platform / fenestrated handle / 4 3/4"

- 140-304F 1.0 mm



140-304F

**Adson Tissue Cross Serrated Forceps**

1 x 2 teeth / cross-serrated platform / serrated handle / 4 3/4"

- 136-678 1.3 mm

1 x 2 teeth / cross-serrated platform / serrated handle / 6"

- 136-678L 1.8 mm

1 x 2 teeth / cross-serrated platform / fenestrated handle / 4 3/4"

- 136-679S 1.3 mm



136-678L



136-679S

**Adson Dressing Serrated Forceps**

Serrated tip / serrated handle / 4 3/4"

- 136-6621T 0.4 mm
- 136-6601 0.5 mm
- 136-662 0.8 mm
- 136-662T 0.8 mm
- 136-660 1.3 mm
- 136-660A 1.3 mm angled



136-660

Serrated tip / fenestrated handle / 4 3/4"

- 136-663 0.8 mm
- 136-661 1.3 mm

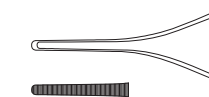

Serrated tip / serrated handle / 6"

- 140-198 1.3 mm



136-6621T

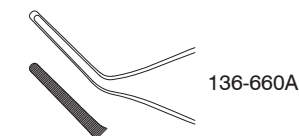

136-660A



136-662T

**Adson Dressing TC Serrated Platform Forceps**

TC Serrated platform / serrated handle / 4 3/4"

- 140-299 0.8 mm
- 140-301 1.3 mm

TC Serrated platform / serrated handle / 6"

- 140-201 1.3 mm

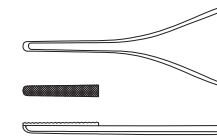
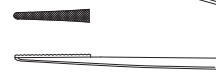

140-301

**Adson Dressing TC Dust Forceps**

TC Dust / serrated handle / 4 3/4"

- 140-298 1.3 mm
- 140-297 1.3 mm platform

TC Dust / serrated handle / 6"

- 140-205 1.3 mm
- 140-204 1.3 mm platform

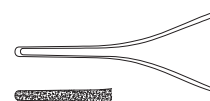

140-297

**Adson Dressing Cross-Serrated Forceps**

Cross-serrated tip / serrated handle / 4 3/4"

- 136-664D 0.8 mm
- 136-664 1.3 mm

Cross-serrated tip / fenestrated handle / 4 3/4"

- 136-665 1.3 mm



136-664

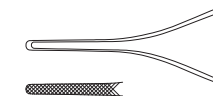

136-664D

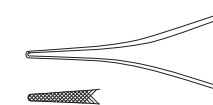

**Adson-Derlacki Forceps**

Serrated handle / 9x9 teeth / screw lock / 4 3/4" (12 mm)

- 136-6861



136-6861

**Adson Helms Forceps**

Serrated handle / 6" (15 mm)

- 2200-066



2200-066

**Adson Forceps with Skin Hook**

Attached thumb ring / 1x2 teeth / 2 sharp prong

475-492 4" (10 cm)  
475-490 6 1/4" (16 cm)



475-492

**Broli-Adson Forceps**

1.2 mm Tip / TC Dust / straight / 6" (15 mm)

2200-062



2200-062

1.2 mm Tip / 1 x 2 Teeth / straight / 6" (15 mm)

2200-064

1.2 mm Tip / Serrated 6" (15 mm)

2200-058 straight  
2200-060 curved

**Brown Adson Tissue Forceps Titanium**

1.8 mm tips / 7x7 teeth

T136-688 4 3/4" (12 cm) fenestrated handle  
136-688T 6" (15.2 cm)



T136-688

1.8 mm tips / 9x9 teeth / 4 3/4" (12 cm)

T136-686 4 3/4" (12 cm)



136-688T



T136-686

**Brown-Adson Tissue Forceps**

Serrated handle / 7 x 7 teeth / 4 3/4" (12 cm)

136-688 fenestrated handle  
136-688S



136-688

3 x 4 teeth / TC platform / 4 3/4" (12 cm)

136-689 serrated handle  
1100-735F fenestrated handle

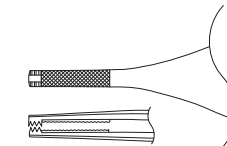

TC platform  
3 x 4 teeth



136-6891

3 x 4 teeth / TC platform / electro black coated / 4 3/4" (12 cm)

136-6891 serrated handle

Russian fenestrated handle / 8 x 8 teeth / 4 3/4" (12 cm)

136-700



136-700

Serrated handle / 9 x 9 teeth / 4 3/4" (12 cm)

136-686  
136-686D 1.6 mm delicate tip  
136-698 angled



136-686

Serrated handle / 9 x 9 teeth / 6" (15.5 cm)

136-687  
136-697 TC platform

9 X 9 teeth



136-697

**Brown-Adson Cooley Forceps**

1.5 mm tip / 4 3/4" (12 cm)

136-686C



136-686C

**Stille-Adson Tissue Forceps**

1 x 2 teeth / 4 3/4" (12 cm)

- 136-675 platform
- 136-677 serrated
- 136-678P cross-serrated platform

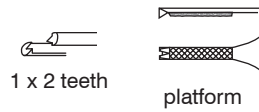

136-675

**Stille-Adson Dressing Forceps**

Serrated / 4 3/4" (12 cm)

- 136-659
- 136-659D delicate

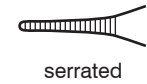

serrated



136-659

**Adson Harris Ring Tip Forceps**

Ring tip / TC dust / 1 mm tip / 4 3/4" (12 cm)

- 1103-808 fenestrated handle curved
- 1103-810
- 1103-812 fenestrated handle



ring tip  
1mm



1103-808

Ring tip / 2 mm tip / 4 3/4" (12 cm)

- 1103-809



1103-810



1103-812

**Brown Forceps**

9x9 teeth / castroviejo handle / 4 1/4" (10.8 cm)

- 14-6560
- 14-6562 with TC dust platform
- 14-6564 with TC insert



14-6560

**Harris Ring Tip Forceps**

Fenestrated handle / ring tip / 1 mm tip / 6" (15.5 cm)

- 1103-811
- 1103-811T titanium

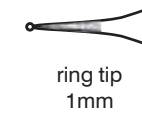

ring tip  
1mm

Fenestrated handle / TC dust ring tip / 2 mm tip / 6" (15.5 cm)

- 1103-813



1103-811



1103-811T

**Russian Adson Micro Forceps**

Fenestrated handle / with platform / 5 1/4" (13.3 cm)

- 136-671A straight
- 136-671B curved



136-671A



136-671B

Fenestrated handle / 1 x 2 teeth / 5 1/4" (13.3 cm)

- 136-671C straight



136-671C

Fenestrated handle / straight / 1 x 2 teeth / 5 3/4" (14.5 cm)

- 136-671D

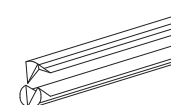

136-671D

**Jewelers Bipolar Forceps**

Straight / 0.5 mm tip / #5 tip / 4 3/4" (12.1 cm)

2700-918



2700-918

**Adson Bipolar Forceps**

1 mm tip / 4 3/4" (12 cm)

2700-905

2700-900

2700-902 4mm angled tip blue electro coat



2700-900



2700-902

1 mm tip / fenestrated handle / 4 3/4" (12 cm)

2700-902F 4 mm angled tip blue electro coat

2700-906 pointed tips



2700-902F



2700-906

1 mm tip / fenestrated handle / non-stick / black coated / 4 3/4" (12 cm)

2700-908NS straight

2700-903NS angled



2700-908NS

**Jewelers Bipolar Forceps**

0.4 mm tip / 4" (10 cm)

2700-920 straight

2700-922 curved

2700-915 straight blue coat



2700-920



2700-915

Insulated / non-stick / straight / 4 1/4" (10.8 cm)

2700-924NS 0.5 mm



2700-924NS

**McPherson Bipolar Forceps**

Smooth tying platform / 0.4 mm tip / 3 1/2" (9 cm)

16-2700 straight

16-2710 angled



16-2700



16-2710

**Jewelers-McPherson Bipolar Forceps**

Blue electro coat / straight

16-2760



16-2760

**Tenzel Bipolar Forceps**

Stop gap 0.5mm / 0.4 mm tip / 4" (10 cm)

2700-925



2700-925

**Nadler Coaptation Bipolar Forceps**

0.4 mm tip / 4" (10 cm)  
2700-931



**Cushing Bayonet Bipolar Forceps**

Stainless steel / 7 1/2" (19 cm)  
2700-978 0.7 mm tip  
2700-940 2.0 mm tip insulated



**Gerald Bayonet Bipolar Forceps**

Insulated / 1 mm tip / 7 1/2" (19 cm)  
2700-990  
2700-990NS non-stick



**Bayonet Bipolar Forceps**

Non-stick / black insulated / with stop  
pin / 1.0mm tip / 9 1/2" (24 cm)  
2700-830NS



**Hardy Bayonet Bipolar Forceps**

Insulated / 0.5 mm tip / 8 1/2" (22 cm)  
2700-980



**Yasargil Bayonet Bipolar Forceps**

1.5 mm tip / irrigated / insulated / 8 1/4" (21 cm)  
2700-974



1 mm tip / irrigated / stainless steel / 7 1/8" (18.25 cm)  
2700-975

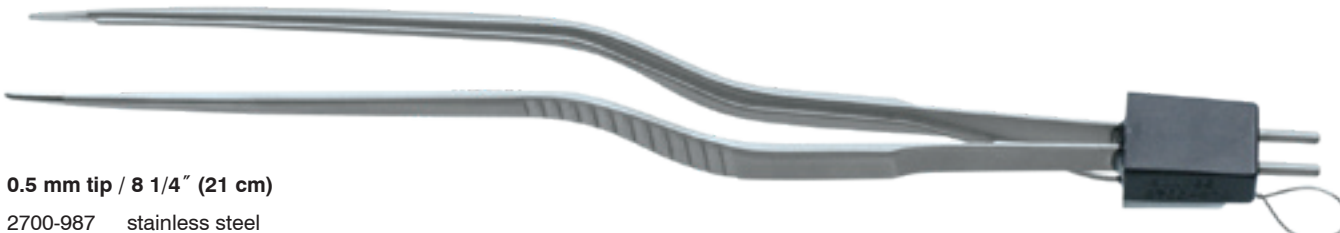

0.5 mm tip / 8 1/4" (21 cm)  
2700-987 stainless steel  
2700-984 insulated



2700-975



2700-987

0.7 mm tip / titanium / 4 hole serrated handle / 9" (22.9 cm)  
2700-983



2700-984

0.8 mm tip / stainless steel / 10 1/4" (26 cm)  
2700-988



2700-988

**Reusable Bipolar Cord**

12 feet in length  
CORD-2000

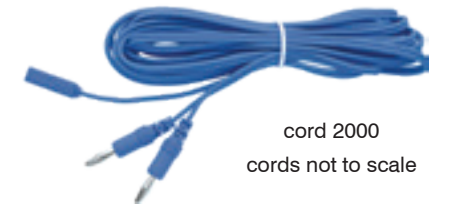

cord 2000  
cords not to scale

**Disposable Bipolar Cord**

Sterile-12 ft long / nickle plated  
banana plugs / forceps plug  
compatible with all manufacture  
bipolar forceps and sweeps /  
packaged 50 per case/ box of 10  
CORD-1000

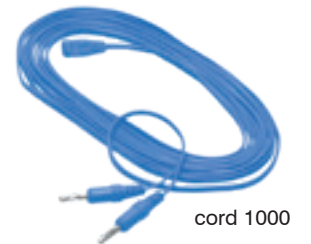

cord 1000

**Titanium Bayonet Bipolar Forceps**

Blue coating / 1.5 mm tip / irrigated / insulated / 8 3/4" (22 cm)  
2700-955



2700-955

**Hardy Bayonet Coagulation Forceps**

Blue coating / 1.5 mm tip, irrigated / insulated stops / 8 1/2" (21.5 cm)  
2700-960



2700-960

**Scoville Bayonet Bipolar Forceps**

Blue electro coating / 7 1/2" (19 cm)  
2700-967 1 mm tip  
2700-968 1.5 mm tip



Blue coating / 2 mm tip / 7 3/4" (19.5 cm)  
2700-965

2700-965

**Scoville Bipolar Forceps**

Non-stick / Black electro coating / 1.5 mm tip / 7 1/2" (19 cm)

2700-968NS



2700-968NS

**Jensen Bipolar Bayonet Irrigation Forceps**

Blue insulated / 1.0 mm / 7 1/2" (19 cm)

2700-887



2700-887

**Jansen Bipolar Forceps**

Black electro coating / 5" (12.7 cm)

2700-879NS 1.0 mm

Black electro coating / 6" (15 cm)

2700-880NS 0.5 mm  
2700-881NS 1.0 mm  
2700-8815NS 1.5 mm



2700-880NS

Black electro coating / 7" (18 cm)

2700-890NS 0.5 mm  
2700-891NS 1 mm  
2700-8915NS 1.5 mm



2700-890NS



2700-891NS

**Cushing Bipolar Forceps**

1.5 mm tip / blue electro coating / 7" (18 cm)

2700-995



2700-995

**Cushing Bipolar Forceps**

Black insulated / non-stick / 1.5 mm tip / 7" (18 cm)

2700-995NS



**Tissue Bipolar Forceps**

Black insulated / non-stick / 2.0 mm tip / 6" (15 cm)

2700-862NS

2700-864NS with stop pin



2700-862NS



2700-864NS

**Hardy Bayonet Bipolar Forceps**

1 mm tip / insulated / straight / 8 1/2" (21.5 cm)

2700-959



2700-959

**Coaptation Bipolar Forceps**

0.4 x 3 mm tip / 4 1/4" (10.5 cm)

2700-930



2700-930

**Bipolar Bayonet Wide Grip Forceps**

Non-stick / black insulated / with stop pin / wide handle / 8 mm x 2 mm

2700-840NS	downward angle	6"
2700-842NS	downward angle	6 3/4"
2700-844NS	downward angle	8"
2700-850NS	straight	6"
2700-852NS	straight	6 3/4"
2700-854NS	straight	8"
2700-856NS	straight	9"



2700-844NS



2700-852NS

Non-stick / black insulated / with stop pin / wide handle / 1.2 mm x 8 mm

2700-8581NS	downward angle	8"
2700-8591NS	downward angle	9"
2700-8601NS	downward angle	10"
2700-858NS	straight	8"
2700-859NS	straight	9"
2700-860NS	straight	10"



2700-8591NS



2700-859NS

**Bipolar Bayonet Wide Grip Forceps**

Unique micro / non-stick / black insulated / with stop pin / wide handle / thin shanks / straight / 4 mm x 1.2 mm

2700-837NS	6 3/4"
2700-839NS	8"



**Black Monopolar Suction Tube**

Non-stick / insulated

2700-550NS	straight	4.3 mm	5"	flexible
2700-552NS	angled	3.3 mm	5"	flexible
2700-554NS	angled	4.0 mm	5"	flexible
2700-556NS	angled	3.3 mm	10"	flexible
2700-558NS	angled	4.0 mm	10"	flexible
2700-560NS	angled	4.0 mm	12"	flexible

**Bipolar Bayonet Suction Wide Grip Forceps**

Black insulated / with suction / stop pin / 1.4 mm

2700-817	8" (20.3 cm)
2700-819	9" (22.9 cm)



2700-817

**Black Bipolar Bayonet Irrigation Forceps**

Insulated / with stop pin / straight / 1.2 mm

2700-810	6 3/4"
2700-812	8"
2700-814	8 3/4"
2700-815	9"



2700-810

**Yasargil Forceps Titanium**

**Flat bayonet / TC dust / 8 3/4" (22.2 cm)**

2601-295 straight 0.5 mm serrated handle  
 2601-295C straight 0.5 mm cross-serrated handle

**Flat bayonet / serrated handle / TC dust / 9" (23 cm)**

2601-296 angle up 0.5 mm  
 2601-290 straight 1 mm  
 2601-291 curved 1 mm  
 2601-292 angled up 1 mm

**Flat bayonet / serrated handle / TC dust / 10" (25.4 cm)**

2601-293 straight 1 mm



**Yasargil Forceps Titanium**

**Flat bayonet / 3 hole handle / TC dust / 9" (23 cm)**

2601-299 straight 1 mm

**Round bayonet handle / TC dust / 9" (23 cm)**

2601-270 straight 0.5 mm  
 2601-274 straight 1 mm

**Round bayonet handle / TC dust / 1 x 2 teeth / 9" (23 cm)**

2601-260 straight 1 mm

**Flat bayonet / 3 hole handle / straight / 1.3mm / 1 x 2 teeth / 8" (20.5 cm)**

2601-298



**Yasargil Micro Forceps Titanium**

Flat bayonet / 3 hole handle / TCD / 1 mm ring tip / 9" (23cm)

2601-280

Flat bayonet / serrated handle / TCD / 9" (23cm)

2601-282 straight 1 mm ring tip

2601-283 straight 1.3 mm ring tip

Round bayonet handle / TCD / 8" (20.3 cm)

2601-285 straight 1 mm ring tip



**Yasargil Tumor Grasping Forceps Titanium**

Flat bayonet 3 hole handle / flat serrated tip / 3 mm / 9" (23cm)

2601-275 straight

Round bayonet handle / flat serrated tip 4 mm / 9" (23cm)

2601-278 straight

Flat serrated handle / flat serrated tip / straight / 9" (23cm)

2601-276 3 mm

2601-279 5 mm

Flat serrated handle / curette serrated tip / straight / 9" (23cm)

2601-266 3 mm

2601-269 5 mm



**Yasargil Bayonet Forceps Titanium**

3 hole flat handle / straight / 9" (23cm)

- 2601-288 0.9 mm micro tip
- 2601-289 1.2 mm atraumatic tip



**Yasargil Tumor Grasping Bayonet Forceps Titanium**

3 hole flat handle / spoon shaped / straight / 9" (23cm)

- 2601-262 5 mm
- 2601-264 7 mm



**Yasargil Tumor Grasping Bayonet Forceps Titanium**

3 hole flat handle / 3 mm spoon shaped / 70° angle up / 9" (23cm)

- 2601-255



**Yasargil Micro Forceps Titanium**

Flat bayonet / 4 hole handle / straight / TCD / 1mm / 9" (23cm)

- 2601-294



**DeBakey Bayonet Forceps**

1.5 mm tip

- 2200-115 7 3/4" (19.5 cm)
- 2200-117A 8 1/2" (12.5 cm)

1.5 mm tip / TC / 7 3/4" (19.7 cm)

- 2200-1151

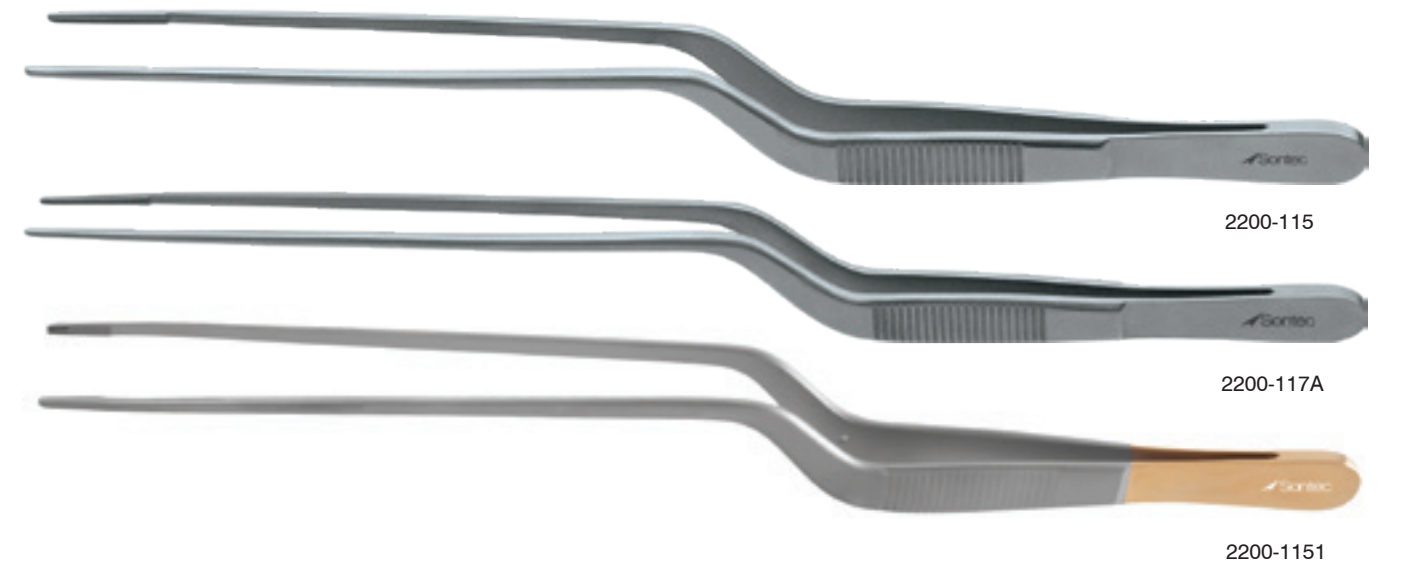

**Gerald Bayonet Forceps**

1 mm serrated tip / 7 5/8" (19 cm)

- 412-334

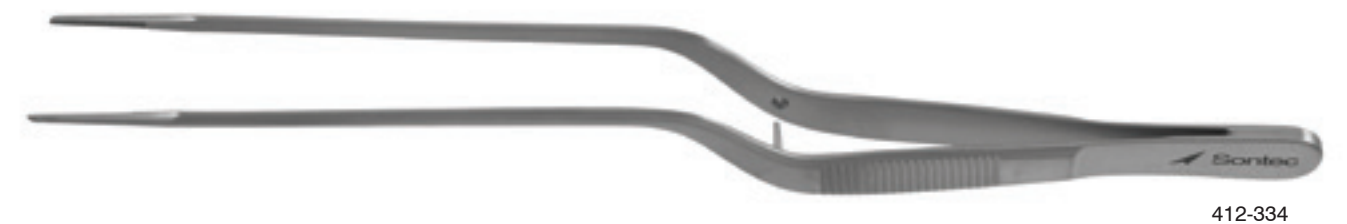

**Micro Bayonet Forceps**

**3 hole handle / TC dust / sharp**

- 400-091 straight 8" (20 cm)
- 400-095 angled 8" (20 cm)
- 400-101 straight 9" (23 cm)
- 400-105 angled 9" (23 cm)
- 400-109 straight 9 1/2" (24 cm)
- 400-113 angled 9 1/2" (24 cm)

**3 hole handle / TC dust / blunt**

- 400-093 straight 8" (20 cm)
- 400-097 angled 8" (20 cm)
- 400-103 straight 9" (23 cm)
- 400-107 angled 9" (23 cm)
- 400-111 straight 9 1/2" (24 cm)
- 400-115 angled 9 1/2" (24 cm)



400-111

**Yasargil Micro Bayonet Forceps**

**TC dust / straight / 9" (23 cm)**

- 400-298 sharp
- 400-296 blunt

**TC dust / angled / 9" (23 cm)**

- 400-293 sharp
- 400-294 blunt

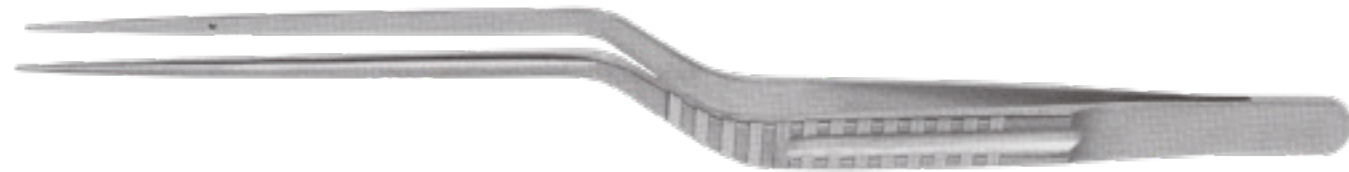

400-296

**Yasargil Tumor Bayonet Forceps**

**Serrated handle / spoon shaped / 9" (23 cm)**

- 400-070 3 mm
- 400-071 5 mm

**Serrated handle / flat serrated / 9" (23 cm)**

- 400-074 3 mm
- 400-075 5 mm

**Serrated handle / curette toothed / 9" (23 cm)**

- 400-076 3 mm
- 400-077 5 mm



400-077

**Yasargil Atrauma Forceps**

**DeBakey / straight / 1.2 mm 8" (20.3 cm)**

400-080



400-080

**Bayonet Forceps**

**Blue coat / serrated / 7 3/4" (20 cm)**

467-317B

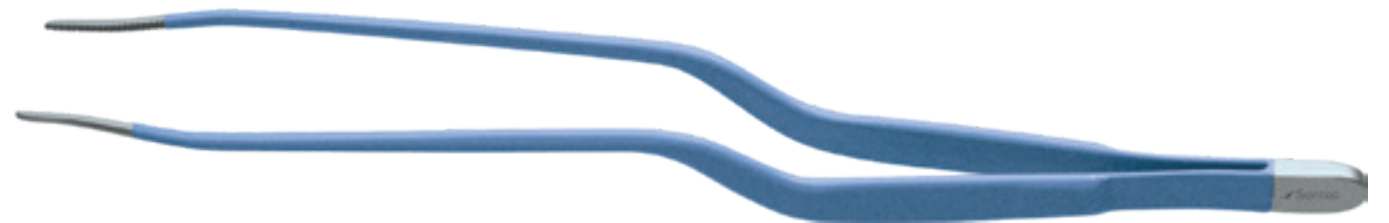

467-317B

**Lucae Ear Forceps**

**Bayonet handle / serrated**

- 467-310 4 1/2" (11.5 cm)
- 467-311 5 1/2" (14 cm)



467-310

**Wilde Ear Forceps**

**Serrated / 5 1/2" (14 cm)**

467-320



467-320

**Jacobson Micro Bayonet Forceps**

**Straight / 7" (18 cm)**

- 400-360 sharp
- 400-358 blunt

**Angled / 7" (18 cm)**

- 400-364 sharp
- 400-362 blunt



400-362

**TC dust / straight / 7" (18 cm)**

- 400-361 sharp
- 400-359 blunt

**TC dust / angled / 7" (18 cm)**

- 400-365 sharp
- 400-363 blunt

**Hypophyseal Bayonet Forceps**

**With smooth cupped jaws 7 mm Ø / 8 3/4" (22 cm)**

- 400-050
- 400-050T titanium



400-050

**Yasargil Tumor Grasping Bayonet Forceps**

**3mm / 3 hole handle / 9 1/4"**

- 400-060 spoon shaped
- 400-063 flat serrated
- 400-066 curette toothed

**5mm / 3 hole handle / 9 1/4"**

- 400-061 spoon shaped
- 400-064 flat serrated
- 400-067 curette toothed



400-066

**Cushing Bayonet Forceps**

**TC / serrated / 7 1/2" (19 cm)**

- 140-220



140-220

**Cushing Dressing Bayonet Forceps**

**1 x 2 teeth / 7 1/4" (18.4 cm)**

- 136-787



136-787

**Cottle Lower Antrum Forceps**

**Boyonet / screw lock / 6" (15.2 cm)**

- 468-300



468-300

**Electro Blue Coated Cushing Bayonet Tissue Forceps**

Monopolar use / TC serrated/insulated

- 140-220B 7 1/2"
- 140-222B 9"



140-220B

**Brown-Cushing Bayonet Forceps**

9 x 9 teeth / 7 1/4" (18.25 cm)

136-798

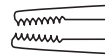

136-798

**Jansen Bayonet Ear Forceps Titanium**

1.0 mm / serrated tips / 5 1/2" (14 cm)

467-314T



467-314T

**Gruenwald (Jansen) Ear Forceps**

Bayonet handle / serrated

- 467-315 6 1/2" (16.5 cm)
- 467-317 7 3/4" (19.5 cm)
- 467-318 8 1/2" (21.5 cm)



467-315



467-317



467-318

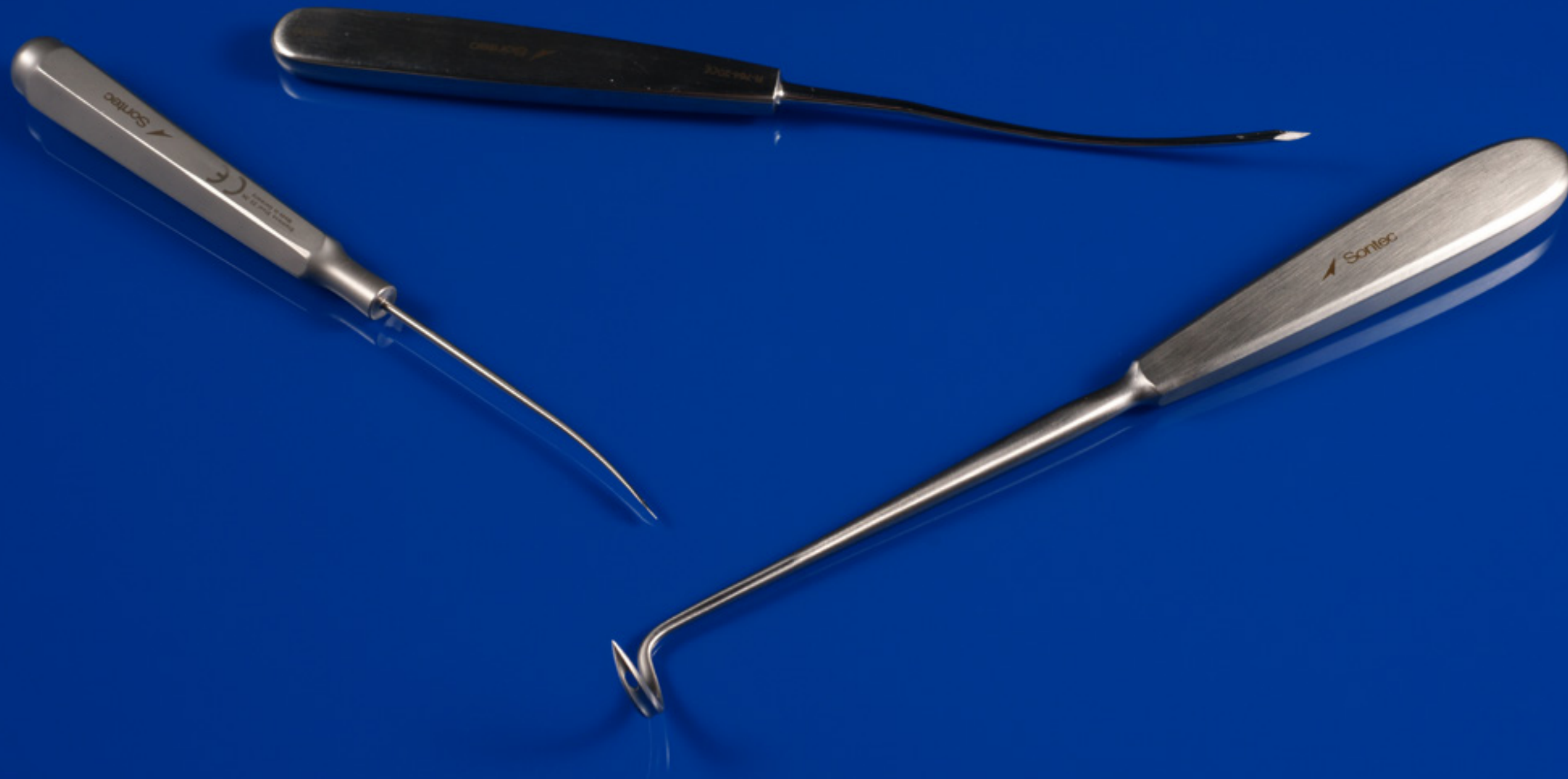

 Sontec Instruments®

Ligature Carriers

**Cassio Ligature Carrier**

Sharp / straight / 8" (20.5 cm)  
134-240

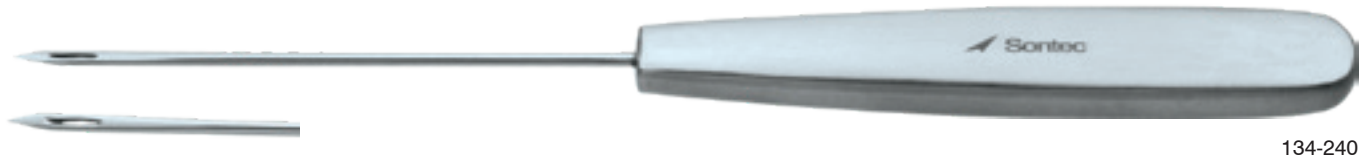

**Sontec Reverdin Blunt Needle/Ligature Carrier**

Blunt / curved / 8" (20.5 cm)  
134-242



**Reverdin Needle/Ligature Carrier**

Sharp / curved / 8" (20.5 cm)  
134-276



**Durrani Dorsal Vein Complex Ligation Needle**

90° sharp / 9" (22.9 cm)  
515-505

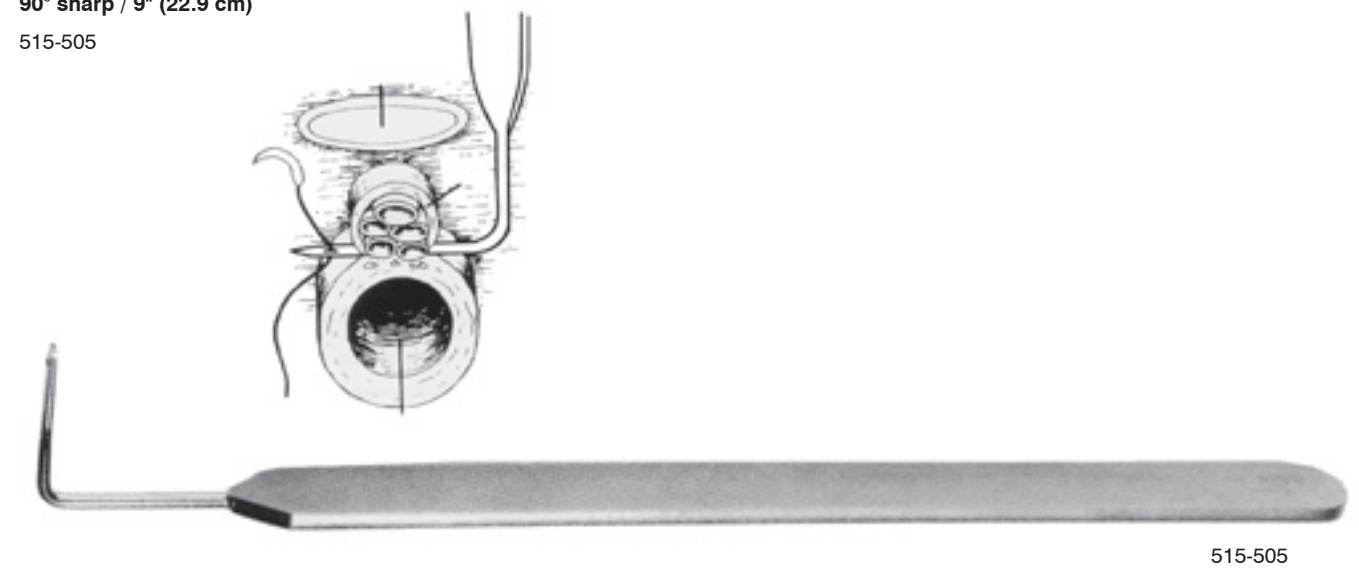

**Tendon Passer Ligature Carrier**

10.5" (26 mm) / 11" phenolic handle  
305-910



**Graft Passer Ligature Carrier**

**Curved**  
1106-400 2 cm extra small  
1106-401 3 cm small  
1106-402 4.5 cm large  
1106-403 6 cm extra large  
1106-404 8cm XX large

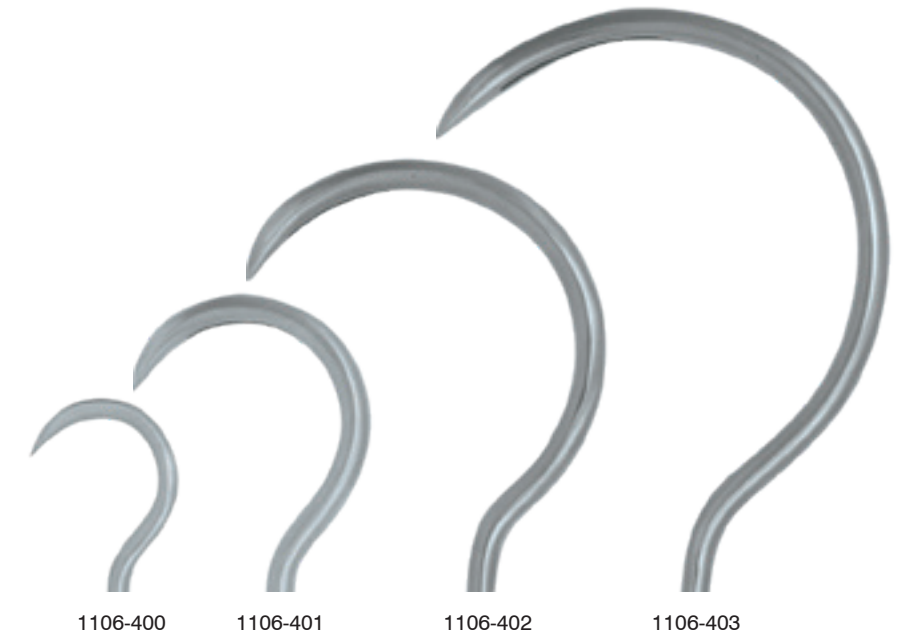

**Deschamps Ligature Carrier**

**Small / 25 mm / 8" (20 cm)**

- 134-277 sharp left
- 134-278 sharp right
- 134-280 blunt left
- 134-281 blunt right



134-278

**Medium / 30 mm / 8" (20 cm)**

- 134-277M sharp left
- 134-278M sharp right
- 134-280M blunt left
- 134-281M blunt right

**Large / 35 mm / 9 1/2" (24 cm)**

- 134-282A sharp left
- 134-282B sharp right



134-277

**Schmieden-Dick Ligature Carrier**

**Malleable / 12 3/4" (32.5 cm)**

- 134-267



134-267

**Entner Ligature Carrier**

**Curved**

- 134-243 8.1/4" (21 cm)
- 134-245 6.1/2" (16.5 cm)



134-243

**Sanders Brown Ligature Carrier**

**10" (25 cm)**

- 134-248



134-248

**Eyebrow Lifting Ligature Carrier**

**11" (28 cm)**

- 134-268



134-268

**Facia Ligature Carrier**

**6" (15 cm)**

- 134-247



134-247



 Sontec Instruments®

Micro HAND SURGERY

**Micro Scissors Long 14 mm Blades Round Handle Titanium**

2602-100	straight	5 1/2" (14 cm)	
2602-101	curved	5 1/2" (14 cm)	
2602-102	straight	7" (17.8 cm)	
2602-1201	straight	7" (17.8 cm)	serrated blades
2602-103	curved	7" (17.8 cm)	
2602-1031	curved	7" (17.8 cm)	serrated blades



2602-100



2602-101

**Micro Scissors Small 8 mm Blades Round Handle Titanium**

2602-104	straight	5 1/2" (14 cm)
2602-105	curved	5 1/2" (14 cm)
2602-1051	curved	5 3/4" (14.6 cm)
2602-106	straight	7" (17.8 cm)
2602-107	curved	7" (17.8 cm)



2602-104



2602-105



2602-1051



2602-106



2602-107

**Micro TCD Round Handle 5 1/2" Needle Holder Titanium**

2602-300	curved	
2602-301	curved	with lock
2602-302	curved	with lock 1.0 mm
2602-303	straight	
2602-304	straight	with lock 0.3 mm



2602-300



2602-301



2602-302



2602-303



2602-304

**Micro TCD Round Handle 7" Needle Holder Titanium**

2602-305	curved	
2602-306	curved	with lock 0.5 mm
2602-307	straight	
2602-308	straight	with lock 0.5 mm



2602-305



2602-306



2602-307



2602-308

**Micro Round Handle 6" Forceps Titanium**

2602-200	straight	with platform		0.20 mm
2602-201	straight	with platform		0.10 mm
2602-202	straight	with platform	strong	0.3 mm
2602-203	curved	with platform	strong	0.3 mm



2602-200



2602-201



2602-202



2602-203

**Micro Round Handle Forceps Titanium**

2602-204	curved	0.3 mm	7" (17.8 cm)
2602-205	straight	0.3 mm	7" (17.8 cm)
2602-206	curved	0.4 mm	8" (20.3 cm)
2602-207	straight	0.4 mm	8" (20.3 cm)
2602-208	straight	0.6 mm	6" (15.2 cm)
2602-209	curved	0.6 mm	6" (15.2 cm)



2602-204



2602-205



2602-206



2602-207



2602-208



2602-209

**Micro Straight Round Handle Forceps Titanium**

2602-210	delicate	1x2 teeth	6" (15.2 cm)
2602-211	delicate	1 mm ring tip	6" (15.2 cm)
2602-212	delicate	1 mm ring tip	7" (17.8 cm)



2602-211



2602-210



2602-212



 Sontec Instruments®

Neuro HOOKS

**Doolen Neuro Hook**

1 mm ball tip / 90° / 8" (20.5 cm)

- 2700-501 2 mm from angle
- 2700-502 3 mm from angle



**Krayenbuehl Nerve Hook**

90° / 7 1/4" (18.5 cm)

- 400-445 2 mm tip length
- 400-445C 2 mm tip length sharp
- 400-447 2 mm tip length 1 mm ball tip
- 400-446 3 mm tip length
- 400-448 3 mm tip length 1 mm ball tip

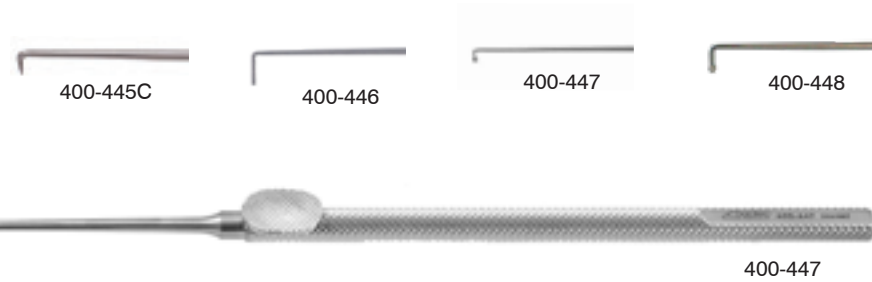

**Krayenbuehl Nerve Hook Extra Long Version**

Round Handle / special long model / 11" (27.9 cm)

- 400-445L 2 mm tip length
- 400-447L 2 mm tip length 1 mm ball tip
- 400-446L 3 mm tip length
- 400-448L 3 mm tip length 1 mm ball tip



**Tufts Pigtail Neuro Hook Probe**

With ball tip / twist right / large / 6 1/2" (16.5 cm)

- 412-443



**Frazier Dorsey Dura Separator**

Angled / 5 x 15 mm blades / 6" (15.2 cm)

- 412-488



**Tufts Pigtail Neuro Hook Probe**

With ball tip / 6 3/4" (17 cm)

- 412-442L spirals left
- 412-442R spirals right



**Pig Tail Neuro Hook Probe**

With ball tip / 6 7/8" (17.5 cm)

- 412-444 spirals right
- 412-444L spirals left
- 412-444KR spirals right 90° angle up
- 412-444KL spirals left 90° angle up

Titanium / with ball tip / 6 7/8" (17.5 cm)

- 412-444T spirals right
- 412-444LT spirals left



**Culler Neuro Round Handle Hook**

Unique sharp 3 mm tip length / 5 1/2"

412-445D

**5 mm tip length**

412-445B 0.7 mm Ø x 5 mm tip length 4 3/4"

412-445A 1 mm Ø x 5 mm tip length 4 3/4"

412-445CL 1 mm tip Ø 6 1/4"

**0.5 mm Ø tip**

412-445C 3 mm tip length 4 5/8"

412-445AL 3 mm tip length 6 1/4"

412-445BL 2 mm tip length 6 1/4"

**1.0 mm Ø 45° 4 mm tip / 6 1/4"**

412-445EL

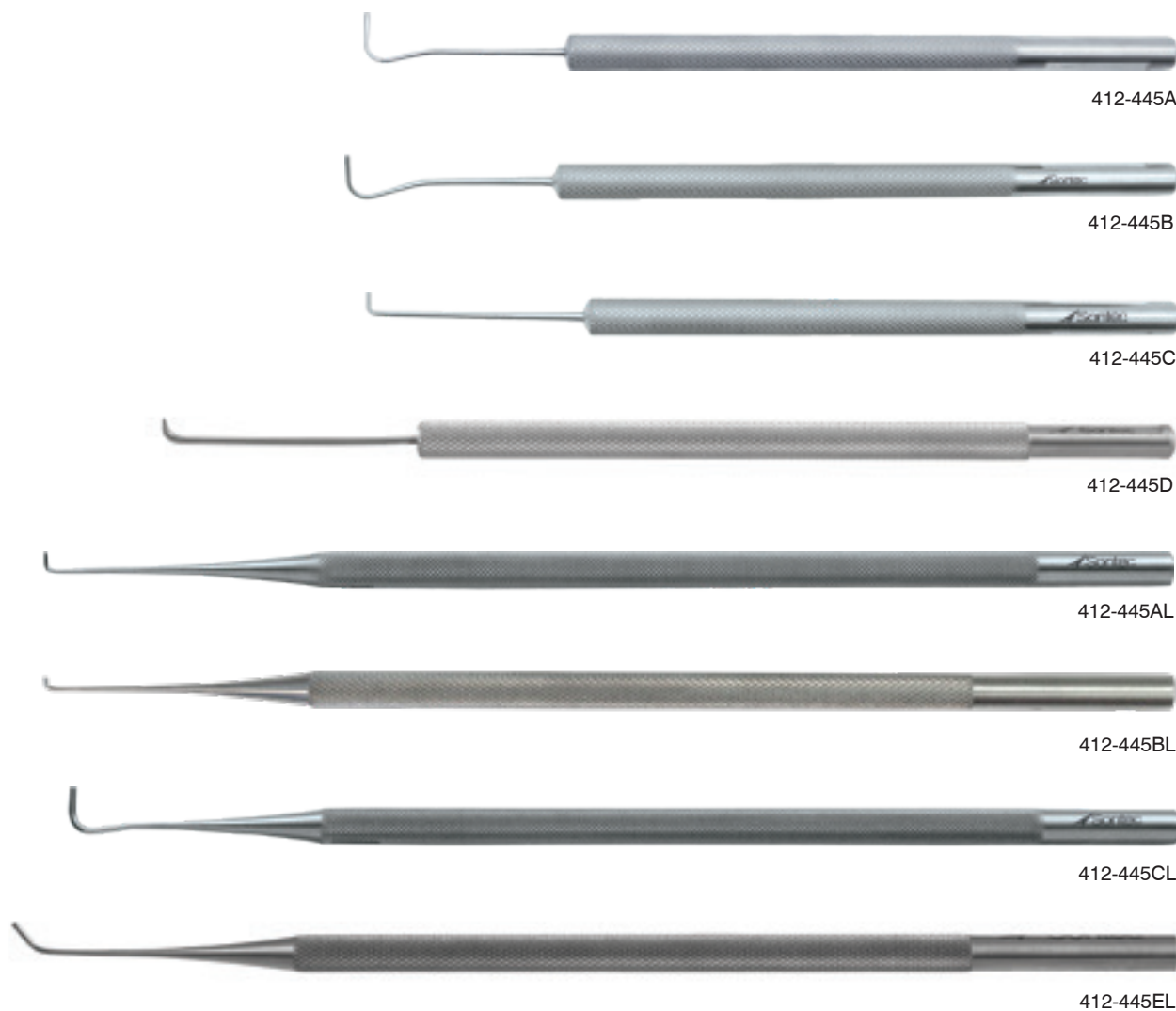

**Culler Neuro Round Handle Hook Titanium**

Unique sharp 3 mm tip length / 5 1/2"

412-445DT

**5 mm tip length**

412-445BT 0.7 mm tip Ø 4 3/4"

412-445AT 1 mm tip Ø 4 3/4"

412-445CLT 1 mm tip Ø 6 1/4"

**0.5 mm Ø tip**

412-445CT 2.5 mm tip length 4 5/8"

412-445ALT 2 mm tip length 6 1/4"

412-445BLT 2.0 mm tip length 6 1/4"

**1.0 mm Ø 45° 4 mm tip / 6 1/4"**

412-445ELT

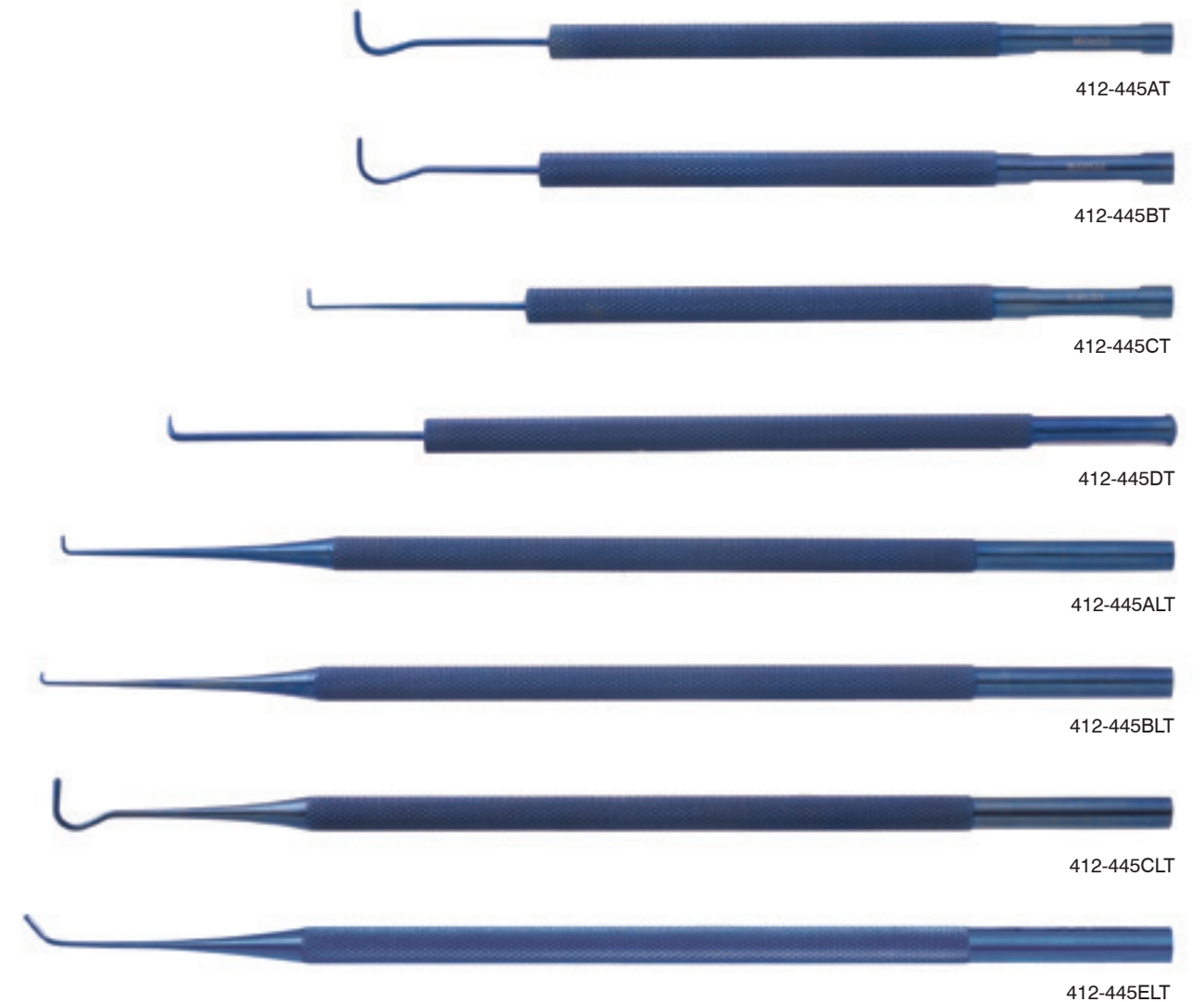

**Sontec Nerve Hook Titanium**

3 mm tip length / 1 mm ball Tip

2700-470A 7 1/8" (18 cm) 5 mm hook with 1 mm ball tip  
 2700-470 8" (20 cm) 3 mm hook with 1 mm ball tip



**Nerve & Vessel Hook Titanium**

10" (25.5 cm)

2700-450 3.5 mm tip with graduation marks  
 2700-451 1.5 mm ball tip



**Krayenbuehl Nerve Hook Titanium**

90° / 7 1/4" (18.5 cm)

400-461T 3 mm probe 1 mm ball tip  
 400-462T 3.8 mm probe 1 mm ball tip  
 400-463T 2.5 mm probe without ball tip  
 400-464T 4.0 mm probe without ball tip  
 400-465T 4.0 mm probe without ball tip



**Heartline Nerve & Vessel Hook**

3.2 mm tip with graduation marks / 12" (30.5 cm)

2800-450

1.5 mm ball tip / 10" (25 cm)

2800-451



**Carpentier Vascular Hook Titanium**

9 1/2" (24 cm)

2700-431 45° angle  
 2700-432 90° angle  
 2700-433 125° angle



**Bayonet Nerve Hook**

6" (150 mm) working length / 10 3/4" (27 cm) overall length

412-615



**Dandy Nerve Hook**

- 412-436 straight shaft 8" (20.3 cm)
- 412-438 straight shaft 9" (23 cm)
- 412-440 angled left shaft 9" (23 cm)
- 412-442 angled right shaft 9" (23 cm)



412-438



412-440



412-442

**Bayonet Nerve Hook Titanium**

Backward facing 0.9mm Ø tip / 20 mm working length / 12 1/4" (31 cm)

412-616T



412-616T

**Lucae Ear Hook**

Fine / indent ball end / 6" (15 cm)

- 468-169 2.0 mm
- 468-170 2.5 mm
- 468-171 3.0 mm
- 468-172 4.0 mm



468-171

**Bryant Mitral Hook Retractor**

10 3/4" (26.5 cm)

- 2500-313 3 semi-sharp prongs
- 2500-313T 3 semi-sharp prongs
- 2500-315 2 semi-sharp prongs
- 2500-315T 2 semi-sharp prongs
- 2500-320 1 semi-sharp prong
- 2500-320T 1 semi-sharp prong



2500-313



2500-313T



2500-315



2500-315T



2500-320



2500-320T

**Wagner Hook**

5 1/2" (14 cm)

- 468-181 size 1
- 468-182 size 2
- 468-183 size 3
- 468-184 size 4
- 468-185 size 5



468-183



**Nerve Hook Titanium**

Bayonet / ball Tip (0.5mm) / 9 1/4" (23.5 cm)

412-618T



412-618T

**Cushing Dura Hook**

6 1/2" (16 cm)

412-414



412-414

**Cloward Dura Hook**

6 1/2" (16 cm)

412-415



412-415

**Graham Dura Hook**

6 1/2" (16 cm)

412-422



412-422

**Micro Hook Titanium**

90° graduation (1 mm) / 7 1/2" (19 cm)

2700-504



2700-504

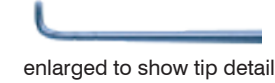

enlarged to show tip detail

**Yasargil Galea Spring Neuro Hook**

Double sharp prong hook / bulldog clamp / spring body / 310 mm

2700-405





 Sontec Instruments®

Neuro RASPATORY

**Yasargil® Raspatory Titanium**

7 1/4" (18.5 cm)

- 400-420T angle with wide blade
- 400-421T light curve with narrow blade
- 400-422T curved with narrow blade
- 400-423T angle with narrow blade



400-420T



400-421T



400-422T



400-423T

**Yasargil® Raspatory Titanium**

Angled with wide blade / 5" (13 cm)

400-419T



400-419T



**Yasargil Raspatory Probe Set**

Single-ended / 7 1/4" (18.5 cm)

- 2700-412 slight curve
- 2700-414 full curve
- 2700-416 angled
- 2700-424 double angle
- 2700-426 dissector

Single-ended / 9" (22.9 cm)

- 2700-410 slight curve



2700-410



2700-412



2700-414

**Jacobson Raspatory/Probe Set**

Single-ended / Round Handle / 7 1/4" (18.5 cm)

- 2700-418 buttoned probe
- 2700-420 twin probe
- 2700-422 suture pusher
- 2700-428 vessel knife



2700-428

2700-422

2700-420

2700-418



 Sontec Instruments®

Neuro Spinal DISSECTORS

**Yasargil Bayonet Raspatory Titanium**



**Yasargil Dissector Raspatory Titanium**

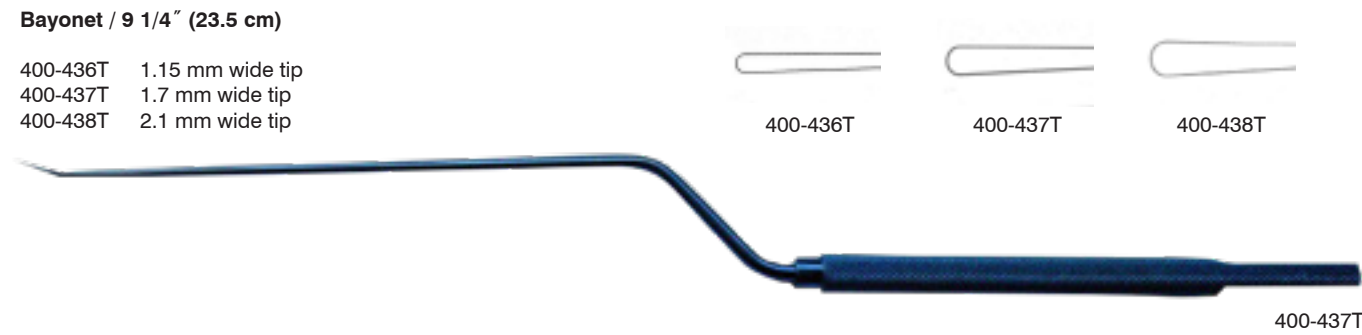

**Ochsner Dissector**



**Ochsner-Sontec Straight Dissector**

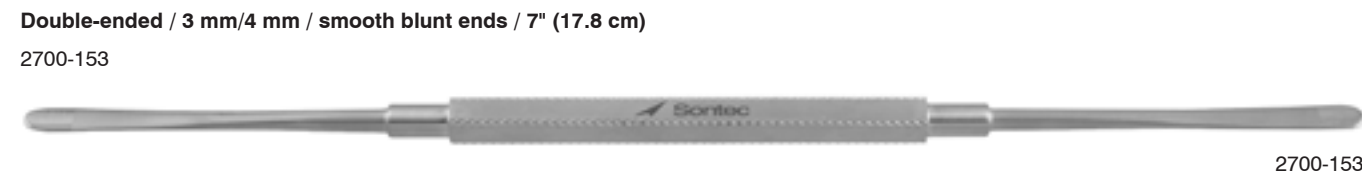

**Ochsner Dissector**

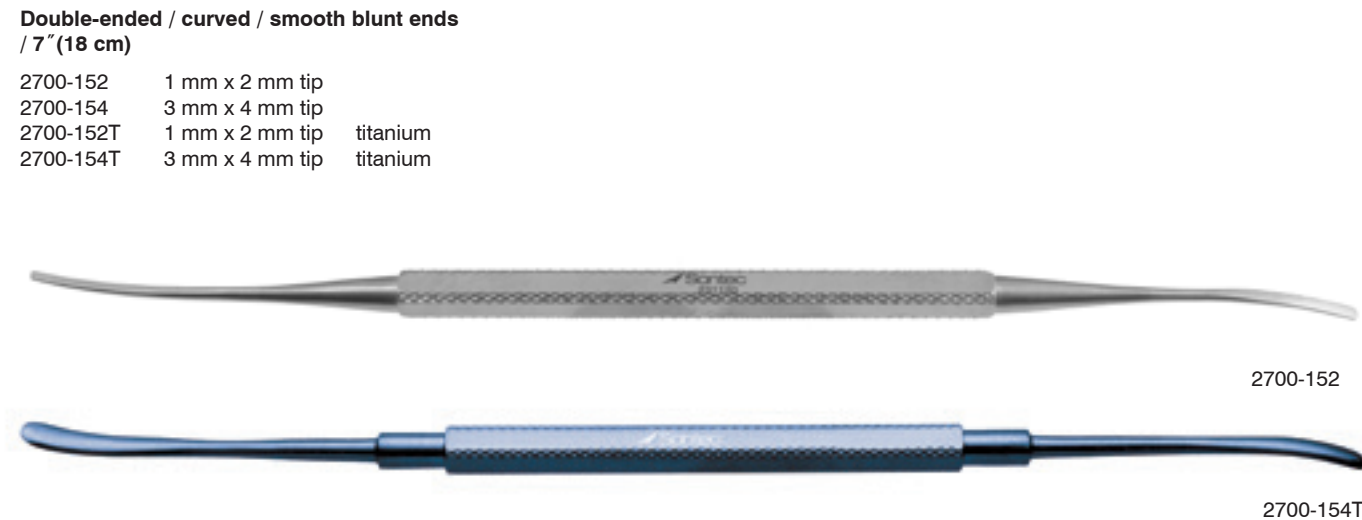

**Olivecrona Dissector**

Double-ended / curved / with Ligature Guide

2700-164	1 mm x 2 mm tip	7" (18 cm)
2700-165	2 mm x 3 mm tip	7" (18 cm)
2700-166	3 mm x 4 mm tip	7" (18 cm)
2700-168	1 mm x 2 mm tip	7 3/4" (19.5 cm)
2700-170	3 mm x 4 mm tip	7 3/4" (19.5 cm)
2700-160	2 mm x 3 mm tip	9 1/2" (24 cm)
2700-162	3 mm x 4 mm tip	9 1/2" (24 cm)



**Titanium Sontec® Dissector**

Single-ended / round knurled handle /  
curved / 7 3/4" (19.5 cm)

412-545	3 mm delicate
412-546	4 mm regular



**Lemmon Dissector**

Semi sharp / 4 mm tip / 6 3/4" (17 cm)

440-420	slight curve
440-421	medium curve
440-423	full curve



**Penfield Dissector Set**

**Sets**

412-552 #1 - #5 stainless steel  
 412-552T #1 - #5 titanium

**Double-ended / dissector / curette / curved / 6 mm / #1 / 7" (18 cm)**

412-547  
 412-547T titanium

**Double-ended / dissector / wax packer / 7 3/4" (19.5 cm)**

412-548 curved #2  
 412-548T curved #2 titanium  
 412-549 full curve #3  
 412-549T full curve #3 titanium

**Single-ended dissector / curved / 3mm / #4 / 8 1/4" (21 cm)**

412-550  
 412-550T titanium

**Double-ended dissector / curved / 6mm / #5 / 11 1/2" (29 cm)**

412-551  
 412-551T titanium



412-547



412-548T



412-549T



412-550



412-551



 Sontec Instruments®

Neuro Spinal ELEVATORS

**Nelms Suction Elevator**

- 2700-310 suction freer style sharp 7" (18 cm)
- 2700-312 suction freer style blunt 7" (18 cm)
- 2700-314 suction cottle style blunt 7 1/2" (19 cm)



2700-310

**Yasargil Bayonet Elevator Titanium**

Straight oval tip (2.75mm wide) / 8 7/8" (22 cm)

400-429T

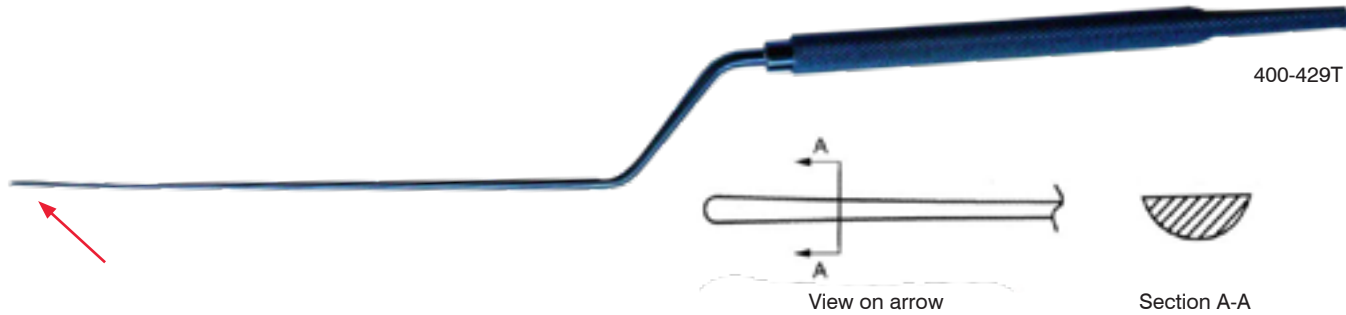

400-429T

**Cobb Spinal Elevator**

Sharp / stainless / 11" (28 cm)

- 330-654 3/8" tip
- 330-655 1/2" tip
- 330-656 3/4" tip
- 330-657 1" tip
- 330-658 1 1/4" tip

Sharp / stainless / aluminum handle / 11" (28 cm)

- 330-654A 3/8" tip
- 330-655A 1/2" tip
- 330-656A 3/4" tip
- 330-657A 1" tip
- 330-658A 1 1/4" tip

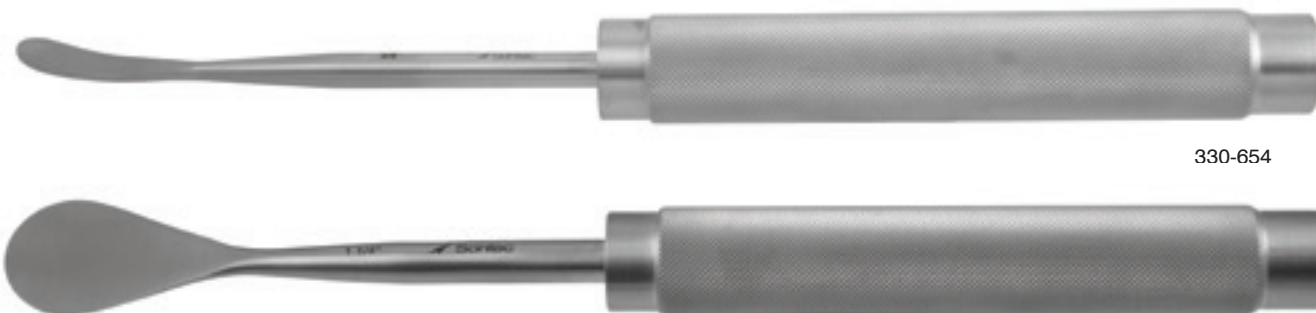

330-654

330-658

**Cobb Spinal Elevator**

Hex handle / 9 1/2" (24 cm)

- 335-320 3/8"
- 335-322 1/2"
- 335-324 3/4"
- 335-325 1"
- 335-326 1 1/4"

Long phenolic handle / 13" (33 cm)

- 335-326A size 1/2
- 335-326B size 5/8
- 335-326C size 3/4
- 335-326D size 1
- 335-326E size 1 1/8"

Long phenolic handle / 15" (38 cm)

- 335-327A size 1/2
- 335-327B size 5/8
- 335-327C size 3/4
- 335-327D size 1
- 335-327E size 1 1/8"

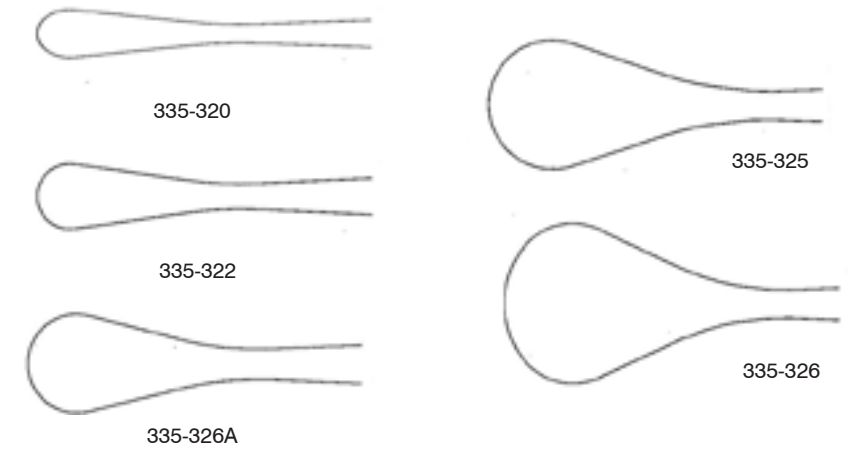

335-320



335-324



335-326

**Cobb Spinal Elevator with Unique Handle**

Sharp / black handle / 16 1/2" (41.9 cm)

- 320-627B small cobb
- 320-628B large cobb

Sharp / green handle / 16 1/2" (41.9 cm)

- 320-627G small cobb
- 320-628G large cobb

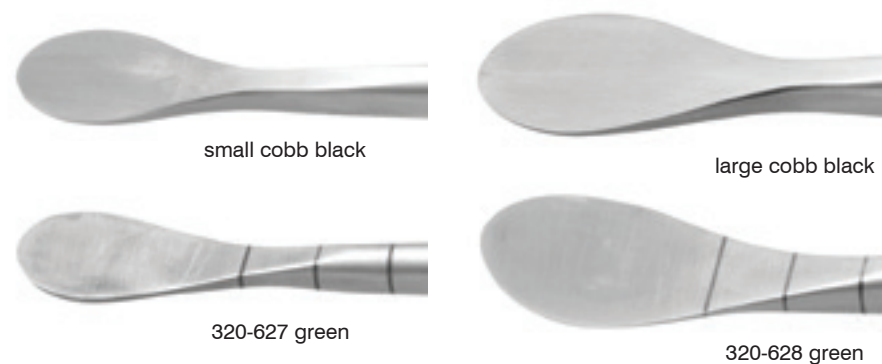

320-627B



320-627G

**Wagner Spinal Elevator**

Phenolic handle

- 335-350 8 mm tip 13" (33 cm)
- 335-360 20 mm tip 11" (28 cm)
- 335-355 17 mm tip 13" (33 cm)



335-350



335-360



335-355

**Freer/Pennington Extra Long Spinal Elevator**

Blunt / blunt / 10 mm ends / 12" (30.5 mm) / extra extra large

1100-791



1100-791



 Sontec Instruments®

Neuro Spinal PROBES

**Murphy Ball End Probe**

**8 1/2" (22 cm)**

- 413-030 curved
- 413-031 straight

**10 1/2" (25 cm)**

- 413-032 curved
- 413-033 straight



413-030



413-031

**Murphy Ball End Probe**

**9" (23 cm)**

- |         |          |      |    |
|---------|----------|------|----|
| 413-020 | straight |      | #1 |
| 413-021 | 65°      | 8mm  | #2 |
| 413-022 | 80°      | 10mm | #3 |
| 413-023 | 75°      | 12mm | #4 |
| 413-024 | 80°      | 13mm | #5 |



413-020



413-024

**For more probes go to  
"Rhoton Jacobson Curette  
& Dissector Hook Set"  
section**



 Sontec Instruments®

Caspar RETRACTORS & DISTRACTORS

**Caspar Cervical Vertebral Retractor Frame**

Accommodates all blade types / single articulation / 85 mm maximum spread / 6 1/2" (16.5 cm)

- 416-280 stainless steel
- 416-680 titanium



**Caspar Cervical Vertebral Retractor Frame**

Accommodates all blade types / double articulation / 125 mm maximum spread / 8" (20 cm)

- 416-260 stainless steel
- 416-660 titanium

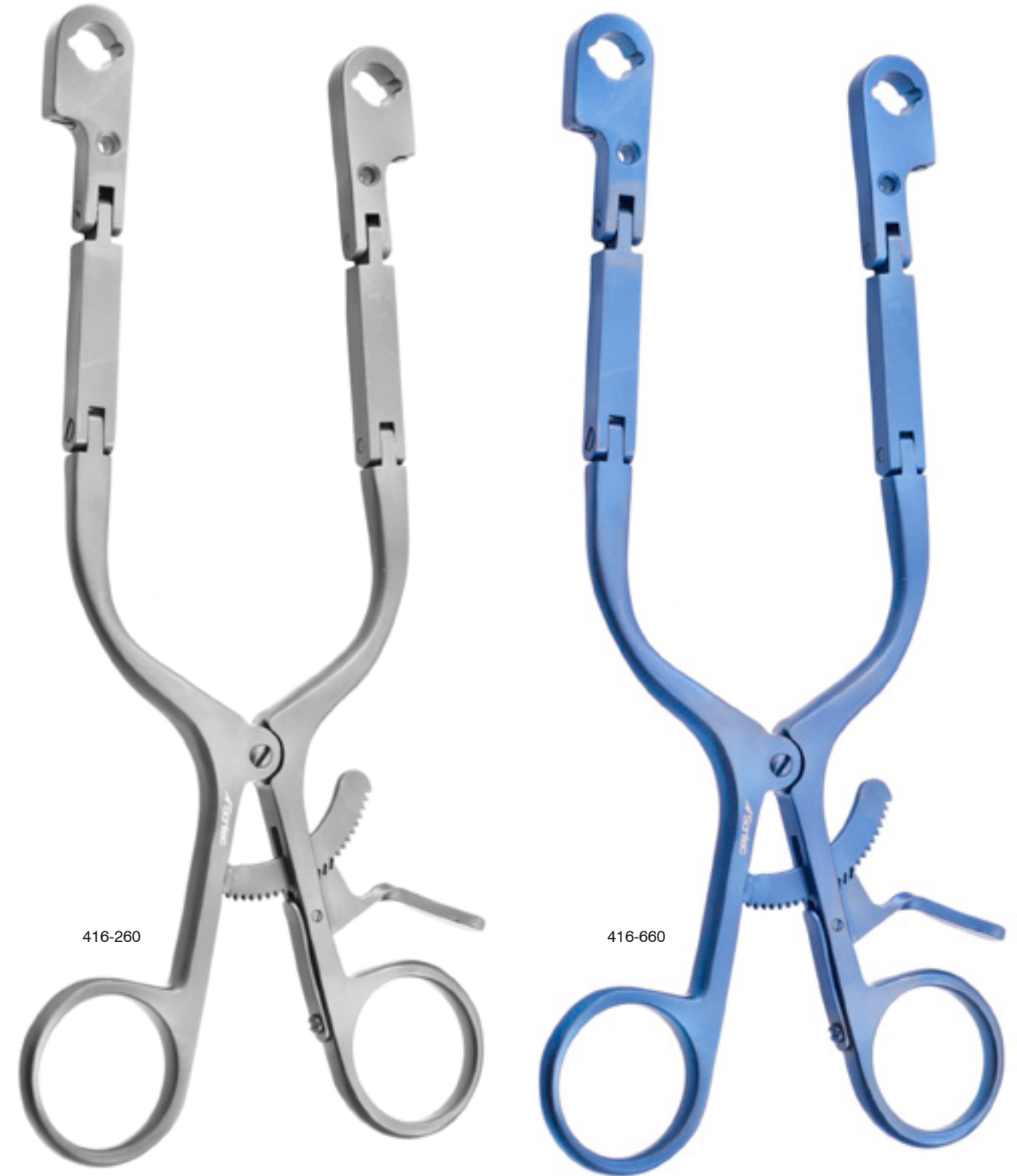

**Caspar Cervical Vertebral Retractor Frame**

Accommodates all blade types / single articulation / V-handle / 85 mm maximum spread

416-230 4 1/2 (11.5 cm)

**Caspar Cervical Vertebral Retractor Frame**

For use with the titanium & plastic quick release blades only / double articulation / 100 mm maximum spread

416-250 6 1/4" (16 cm)

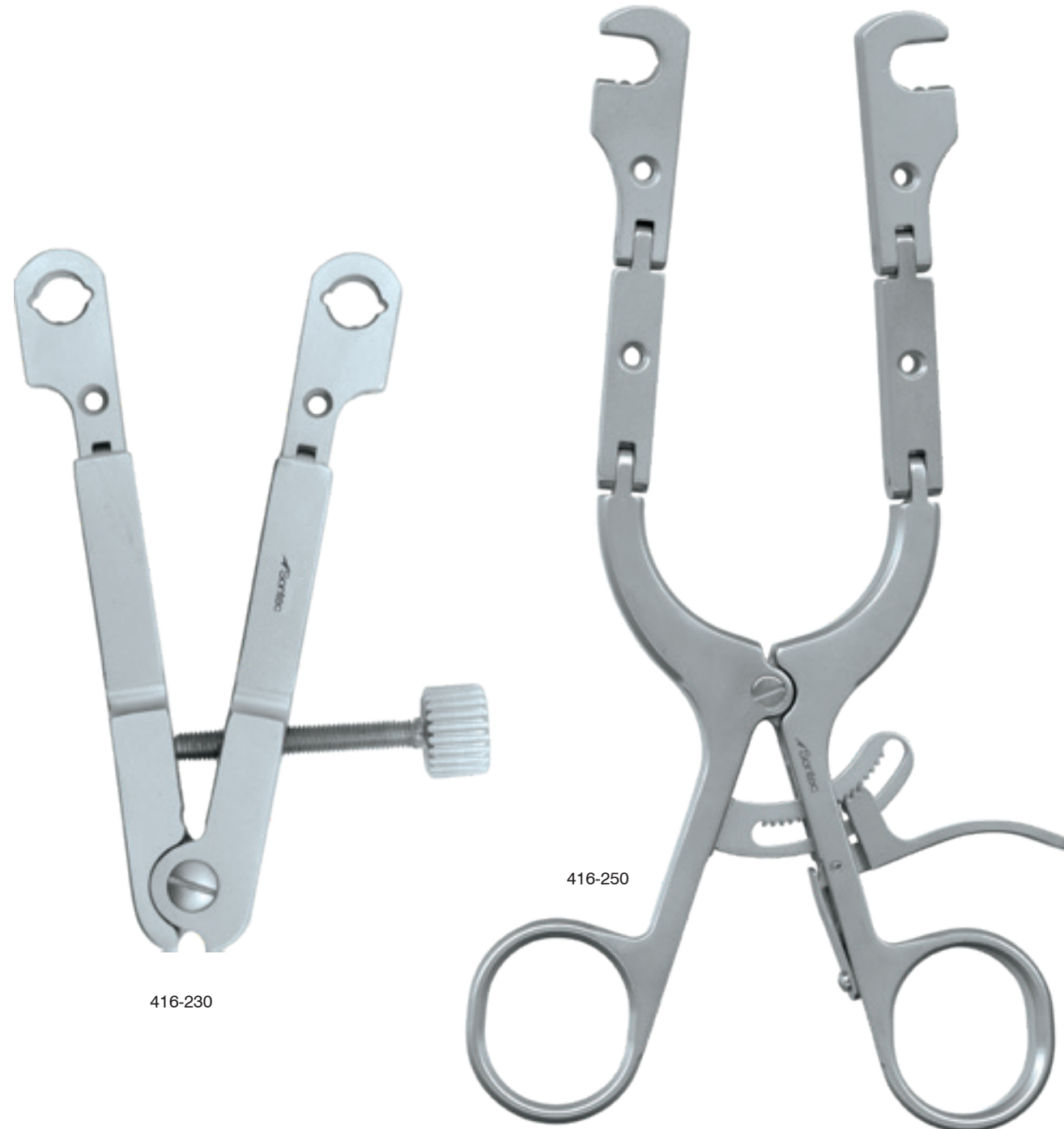

**Caspar MIS Cervical Vertebral Column Retractor Frame**

Accommodates all blade types / double articulation / 90 mm maximum spread

416-200 stainless steel  
416-700 titanium

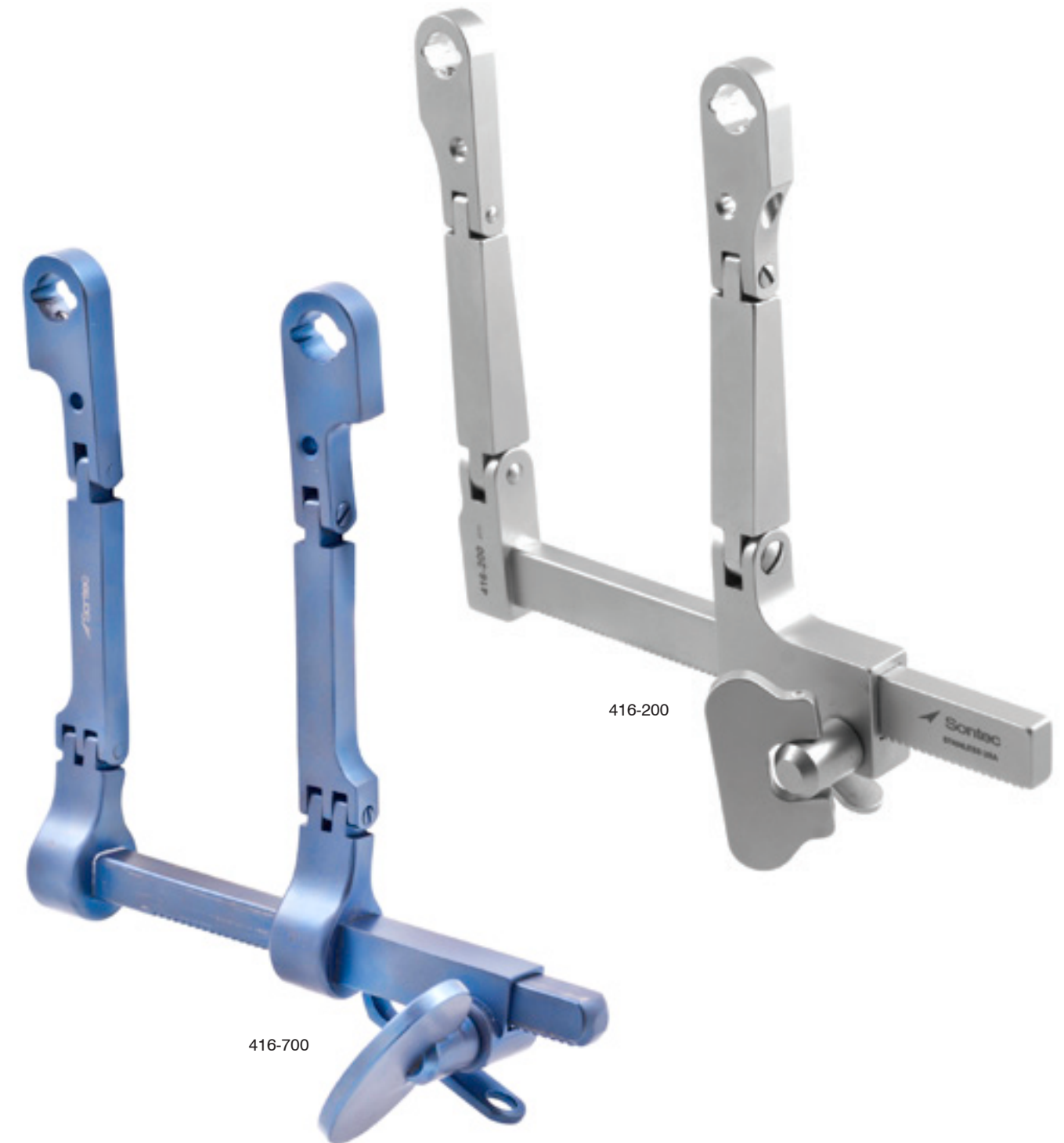

### Caspar Cervical Vertebral Column Retractor Frame

Rotatable arms / accommodates all blade types / double articulation / 90 mm maximum spread

416-202 stainless steel



416-202

### HL MIS Retractor Frame Medium

Accommodates all blade types / double articulation / 200 mm maximum spread

416-201



416-201

### Caspar V-Blunt Blade

#### Stainless steel

- 416-450 45 x 20 mm
- 416-452 50 x 20 mm
- 416-454 55 x 20 mm
- 416-456 60 x 20 mm
- 416-458 65 x 20 mm

#### Plastic / quick release / ultra-transparent to X-ray

- 416-460 45 x 20 mm
- 416-462 50 x 20 mm
- 416-464 55 x 20 mm
- 416-466 60 x 20 mm
- 416-468 65 x 20 mm



Stainless steel



Plastic / quick release

### Caspar Serrated Lateral Blade

#### Stainless steel

- 416-519 40 x 15 mm extra thin
- 416-520 45 x 20 mm
- 416-522 50 x 20 mm
- 416-524 55 x 20 mm
- 416-526 60 x 20 mm
- 416-528 65 x 20 mm

#### Anodized aluminum

- 416-510 45 x 20 mm
- 416-512 50 x 20 mm
- 416-514 55 x 20 mm
- 416-516 60 x 20 mm
- 416-518 65 x 20 mm

#### Plastic / quick release

- 416-530 45 x 20 mm
- 416-532 50 x 20 mm
- 416-534 55 x 20 mm
- 416-536 60 x 20 mm
- 416-538 65 x 20 mm

#### Titanium / quick release / semi-transparent to X-ray

- 416-500 45 x 22 mm
- 416-502 50 x 22 mm
- 416-504 55 x 22 mm
- 416-506 60 x 22 mm
- 416-508 65 x 22 mm



Titanium / quick release



Plastic / quick release



stainless steel

**Caspar Blunt Smooth Blade**

**Anodized aluminum**

- 416-560 45 x 20 mm
- 416-562 50 x 20 mm
- 416-564 55 x 20 mm
- 416-566 60 x 20 mm
- 416-568 65 x 20 mm

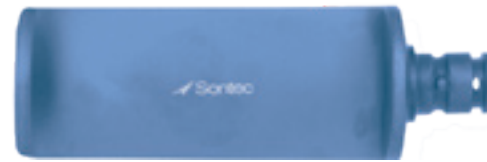

Anodized titanium

**Titanium / quick release / semi-transparent to X-ray**

- 416-550 45 x 23 mm
- 416-552 50 x 23 mm
- 416-554 55 x 23 mm
- 416-556 60 x 23 mm
- 416-558 65 x 23 mm
- 416-559 75 x 23 mm

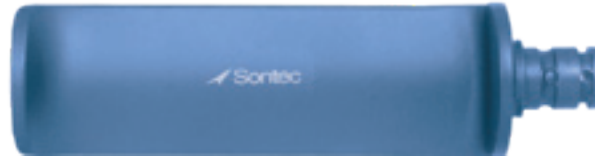

Titanium / quick release

**Medial Blade**

**Stainless steel**

- 416-400 45 x 20 mm
- 416-402 50 x 20 mm
- 416-404 55 x 20 mm
- 416-406 60 x 20 mm
- 416-408 65 x 20 mm



Aluminum

**Anodized aluminum / special order only**

- 416-410 45 x 20 mm
- 416-412 50 x 20 mm
- 416-414 55 x 20 mm
- 416-416 60 x 20 mm
- 416-418 65 x 20 mm



416-542

**Plastic / quick release / ultra-transparent to X-ray**

- 416-420 45 x 20 mm
- 416-422 50 x 20 mm
- 416-424 55 x 20 mm
- 416-426 60 x 20 mm
- 416-428 65 x 20 mm

**Titanium / quick release**

- 416-541 45 x 20 mm
- 416-542 50 x 20 mm
- 416-543 55 x 20 mm
- 416-544 60 x 20 mm
- 416-545 65 x 20 mm

**Caspar Blade Removal Forceps**

**For changing blades**

- 416-298 straight
- 416-299 angled



416-298



416-299

**Caspar Hand Universal Retractor**

**For use with the quick release blades only / with depth gauge / screw on blade lock (more secure hold)**

- 416-220 8" (20 cm)



416-220

**For use with the quick release blades only / black handle**

- 416-220L snap lock 8" (20 cm)
- 416-220B screw on blade lock 7 1/4" (18.4 cm)



416-220B



416-220L

**Caspar Cervical Vertebral Column Quick Release Retractor Frame**

Accommodates SL-Connect blades / double articulation / 90 mm maximum spread / quick release

- 416-650
- 416-655 trans-verse/stepdown

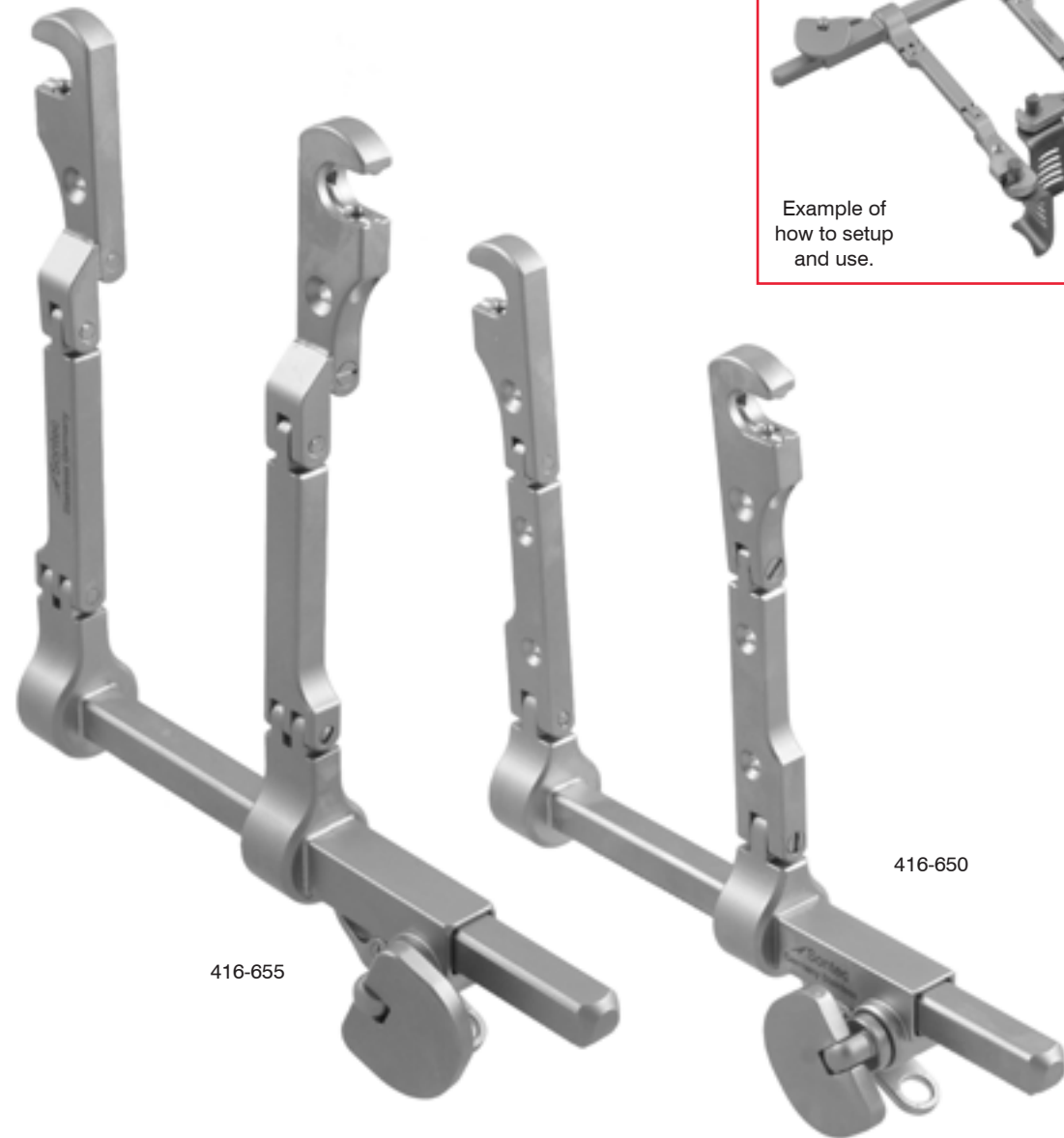
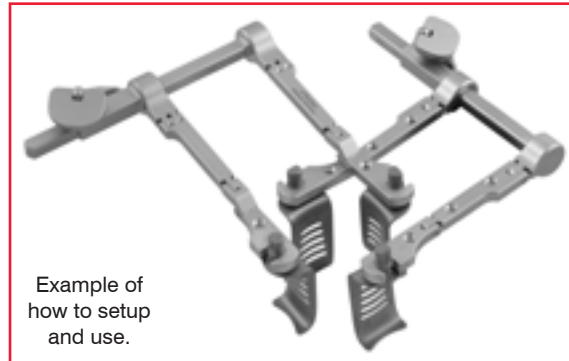

**SL - Connect Blade Insert Instrument**

7 1/4" (18m mm)

416-225



416-225

**SL - Connect Lateral Blade Titanium**

Quick release

- 416-580 24 x 45
- 416-582 24 x 50
- 416-584 24 x 55



416-580

416-582

416-584

**SL - Connect Blunt Blade Titanium**

Quick release

- 416-586 24 x 45
- 416-588 24 x 50
- 416-590 24 x 55



416-586

416-588

416-590

**Caspar Distractor Vertebral Retractor**

416-300 right  
416-305 left

A	B
70 mm	93 mm

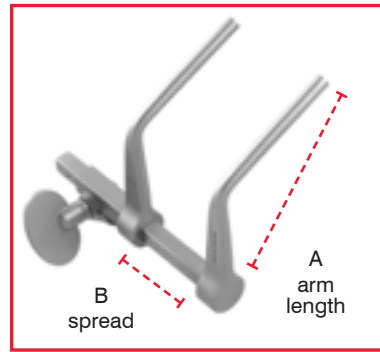

416-305



416-300

**Caspar Drill Guide**

Works inconjunction with distractors pictured on previous page. Screw mechanism slides over distractor bar for drill guide.

416-340 right  
416-342 left



416-340

right



left

416-342



right

left

**Caspar Twist Drill**

416-335 1.7 mm Ø



**Caspar Screw Post**

For Distractor

416-312 12 mm  
416-314 14 mm  
416-316 16 mm



416-314



416-316

**Caspar Screwdriver**

For Distractor / also available in phenolic plastic handle / 7 3/4"

416-330



**Caspar Lumbar Speculum**

Non-reflective / anodized surface / 18 mm wide

416-820 40 mm in length  
416-821 45 mm in length  
416-822 50 mm in length  
416-823 55 mm in length  
416-824 60 mm in length  
416-825 65 mm in length  
416-826 75 mm in length  
416-827 85 mm in length

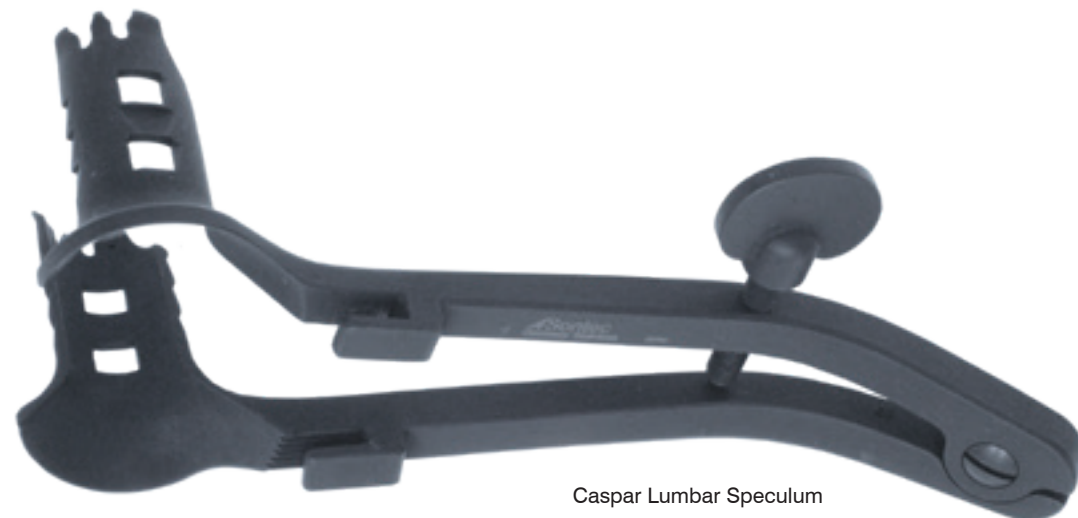

Caspar Lumbar Speculum

**Caspar Counter Retractor**

For Caspar Speculum / 60 mm maximum spread

416-800 complete with 5 blades  
416-801 retractor only

**Caspar Serrated Lateral Blade**

For Counter Retractor

416-802 35 mm  
416-803 40 mm  
416-804 45 mm  
416-805 50 mm  
416-806 55 mm  
416-807 60 mm  
416-808 65 mm  
416-809 75 mm  
416-810 85 mm

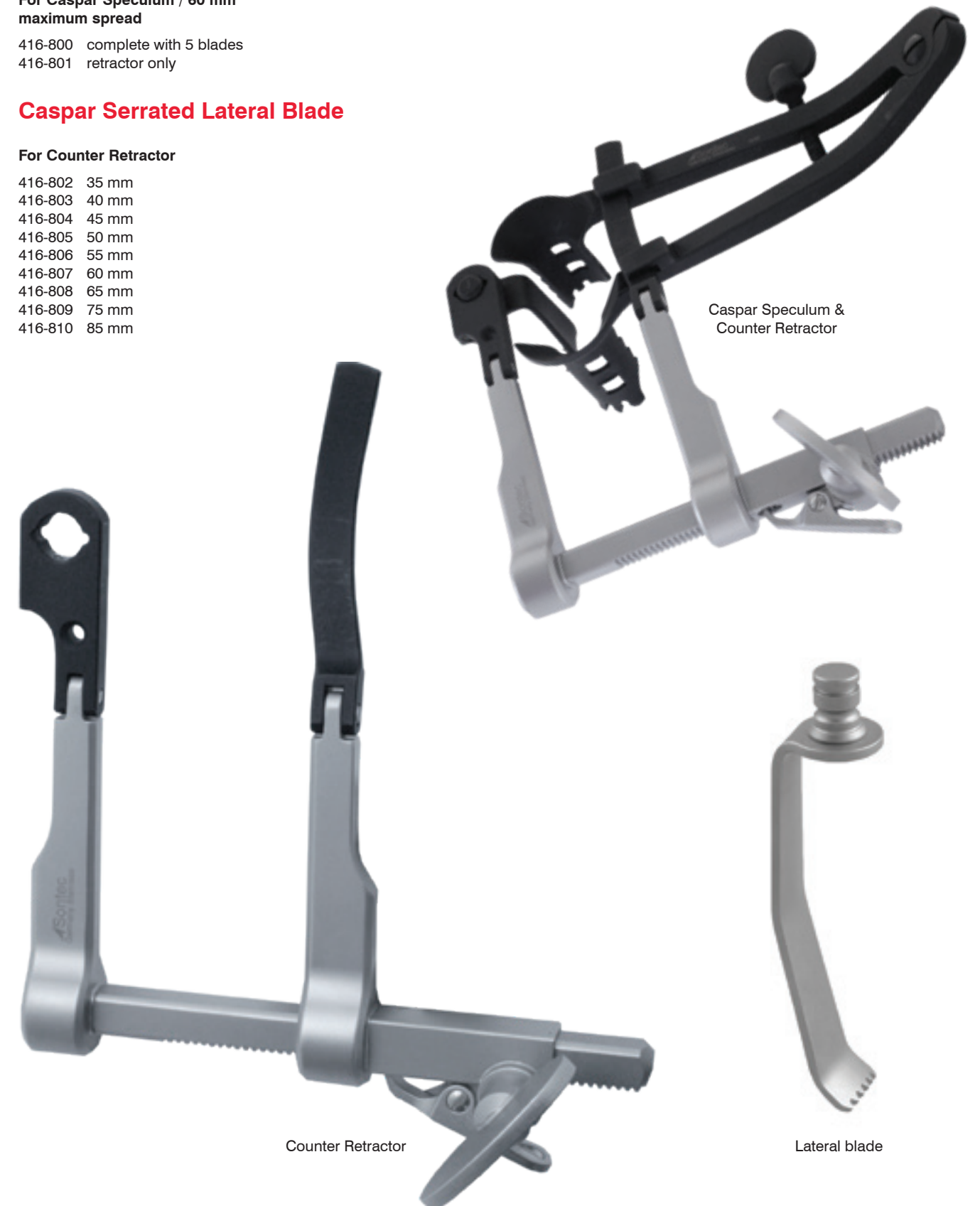

Caspar Speculum & Counter Retractor

Counter Retractor

Lateral blade

**Scoville Retractor Frame**

lumbar retractor system / accommodates  
all blade types / double articulation / 8  
1/4" long with 6 1/2" arms

417-098

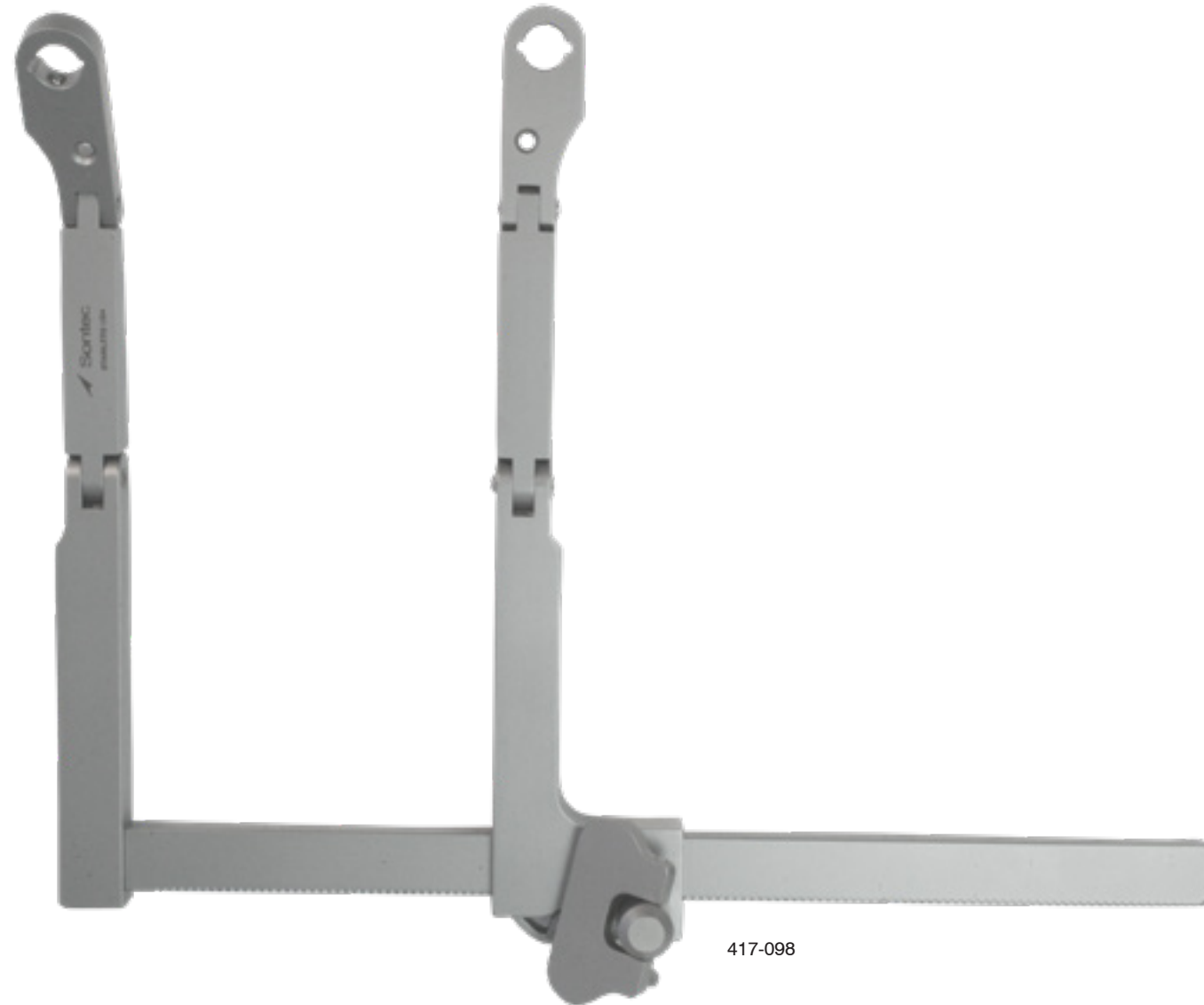

**Scoville Lumbar Blade**

**23 mm wide**

- 417-0030 23 x 35 mm
- 417-0031 23 x 45 mm
- 417-0032 23 x 55 mm
- 417-0033 23 x 65 mm
- 417-0034 23 x 75 mm
- 417-0035 23 x 85 mm
- 417-0036 23 x 100 mm
- 417-0037 23 x 120 mm

**45 mm wide**

- 417-0050 45 x 50 mm
- 417-0051 45 x 60 mm
- 417-0052 45 x 70 mm
- 417-0053 45 x 80 mm

**60 mm wide**

- 417-0060 60 x 50 mm
- 417-0061 60 x 60 mm
- 417-0062 60 x 70 mm
- 417-0063 60 x 80 mm
- 417-0064 60 x 100 mm
- 417-0065 60 x 120 mm



**Scoville Middle Lumbar Blade**

**15 degrees**

- 417-0135 35 mm
- 417-0136 40 mm
- 417-0137 45 mm
- 417-0138 50 mm
- 417-0139 55 mm
- 417-0140 60 mm
- 417-0141 65 mm
- 417-0142 70 mm
- 417-0143 75 mm
- 417-0144 80 mm



**Micro Lamina Spreader**

With speed lock / many tip widths available / 5 3/4" (14.5 cm)

417-058

With speed lock / deep angle / 6 3/4" (17.1 cm)

417-058D



417-058



417-058D



**Caspar Nerve-Root Retractor**

For micro lumbar dissection

416-844 4 mm

416-846 6 mm

416-848 8 mm

416-850 10 mm

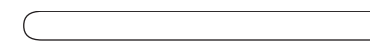

416-844



416-848



416-846



416-850

**Cloward Cervical Retractor**

64 mm maximum spread

- 416-130 complete, with 5 toothed blades
- 416-131 frame only

**Blunt Blade**

For Cloward Cervical Retractor

- 416-132 40 mm x 15/23 mm
- 416-133 45 mm x 15/23 mm
- 416-134 50 mm x 15/23 mm
- 416-135 55 mm x 15/23 mm
- 416-136 60 mm x 15/23 mm

**Round Blade**

For Cloward Cervical Retractor

- 416-138 55 mm x 20 mm
- 416-139 60 mm x 20 mm
- 416-140 65 mm x 25 mm
- 416-141 70 mm x 25 mm

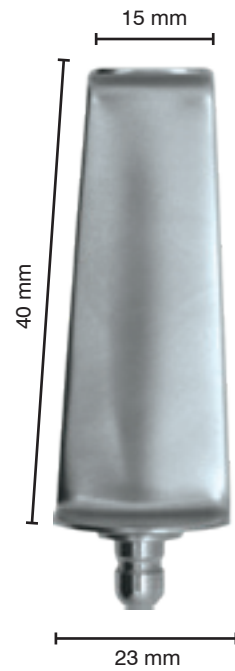

**Cloward Cervical Retractor**

114 mm maximum spread

- 416-100 complete, with 5 toothed blades
- 416-101 frame only

**Toothed Blade**

For Cloward Cervical Retractor

- 416-102 40 mm x 15/23 mm
- 416-103 45 mm x 15/23 mm
- 416-104 50 mm x 15/23 mm
- 416-105 55 mm x 15/23 mm
- 416-106 60 mm x 15/23 mm

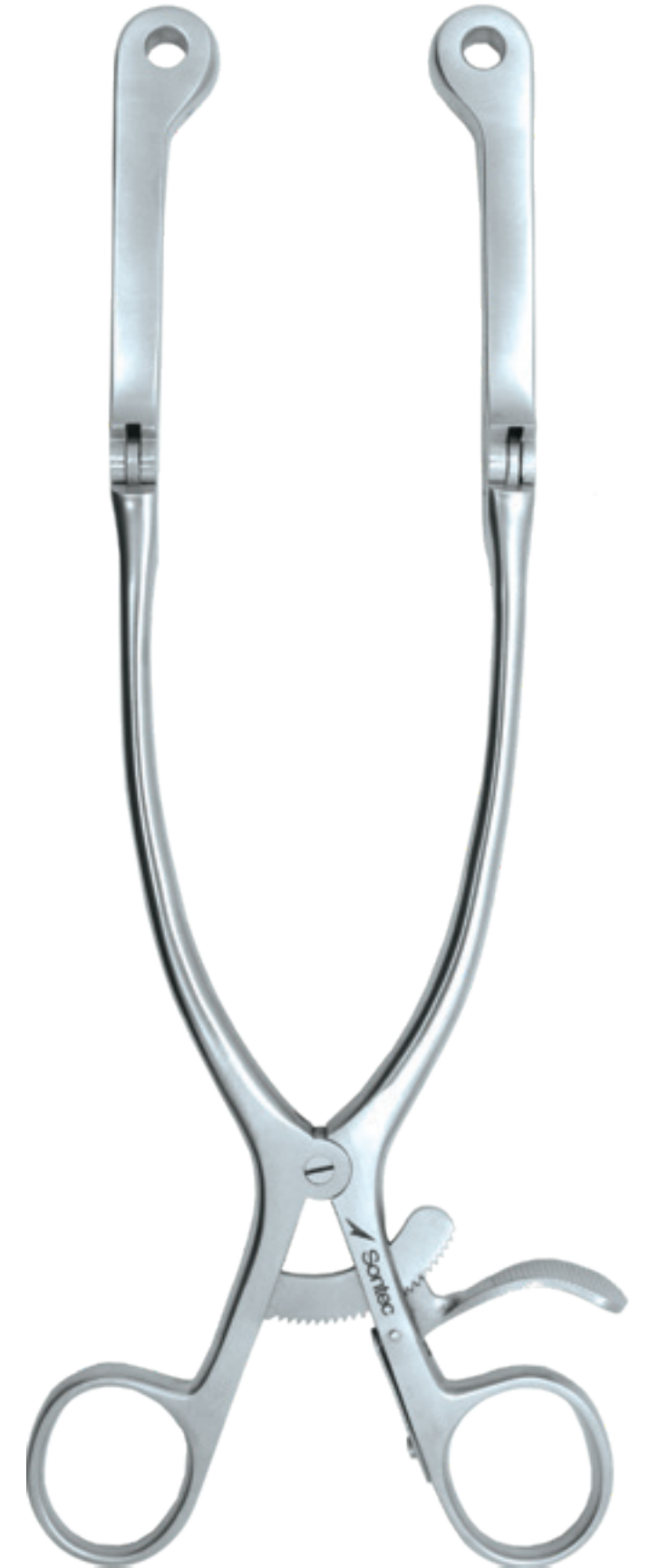
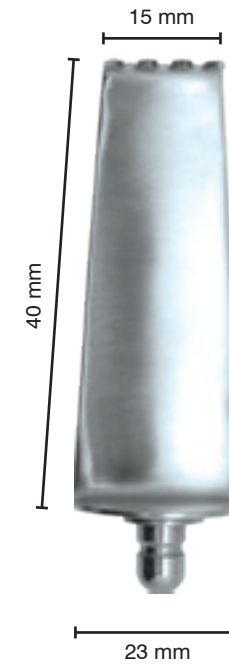

**McCullough Retractor Set**

64 mm maximum spread

416-150 extended rack 8"

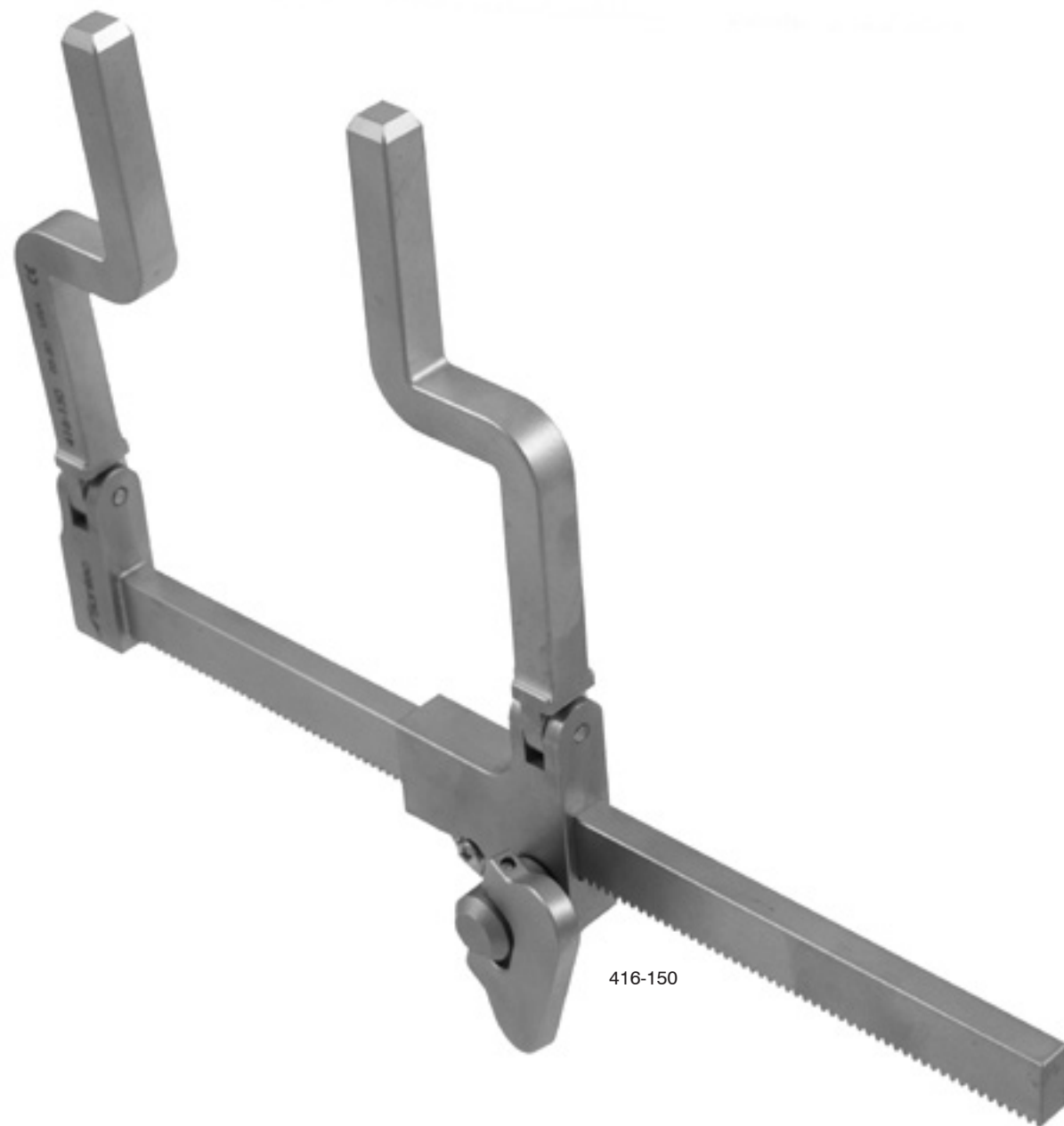

416-150

**McCullough Retractor Set**

64 mm maximum spread

- 416-150 extended rack 8"
- 416-152 black narrow muscle blade 2 cm x 9 cm
- 416-153 black narrow muscle blade 2 cm x 10 cm
- 416-154 black narrow muscle blade 2 cm x 11 cm
- 416-157 black wide muscle blade 2.7 cm x 9 cm
- 416-158 black wide muscle blade 2.7 cm x 10 cm
- 416-159 black wide muscle blade 2.7 cm x 11 cm
- 416-161 black hook blade 7 cm
- 416-162 black hook blade 8 cm
- 416-163 black hook blade 9 cm



416-152

416-153

416-154

416-157

416-159

416-161

416-163

**Neuro Caliper**

8 3/4" (22 cm)  
355-250



355-250

**Caspar System Complete Set**

1103-729 tray  
416-199 set Call for individual & set pricing

Set includes:

- 416-200 caspar cervical vertebral column retractor frame
- 416-220 caspar hand retractor with depth gauge 8"
- OR**
- 416-220B caspar hand retractor with screw on blade 7 1/4"
- 416-230 caspar cervical vertebral retractor "v-shape 4 1/2"
- 416-260 caspar cervical vertebral retractor 8" double articulating
- 416-280 caspar cervical vertebral retractor 6 1/2" single
- 416-299 caspar forceps for changing blades
- 416-300 caspar distractor right
- 416-305 caspar distractor left
- 416-314 screw post for distractor 14 mm
- 416-330 caspar screwdriver universal
- 416-335 caspar twist drill 1.7mm
- 416-340 drill guide 65 degree angle right phenolic handle
- 416-342 drill guide 65 degree angle left phenolic handle
- 417-058D micro lamina spreader deep angle with speed lock 6 3/4"
- assorted blades (10 sets) different sizes
- tray





 Sontec Instruments®

Brain SPATULAS

**Abdominal Spatula**

**Malleable**

20-0847	6 3/4" long x 5/8" wide	
20-0848	7 1/2" long x 1" wide	
20-0871	11" long x 1 1/2" to 2 1/2" wide	Reverdin
20-0874	8" long x 3/4" to 1" wide	Tuffier
20-0873	12" x 40 mm/50 mm	Haberer

20-0847



20-0873

Haberer



Tuffier

20-0874

**CSU Kloop Neuro Spatula**

6 1/2" (16.5 cm)

412-472



412-472

**Cushing Brain Depressor Spatula**

**Double-ended**

412-787 6 3/4" (17.1 cm)

412-789 7 3/4" (19.7 cm)



412-787



412-789

**Sontec Brain Spatula**

Tapered / malleable / 7" (18 cm)

- 412-779 2 mm
- 412-781 4 mm
- 412-783 6 mm



412-779



412-781



412-783

**Davis Brain Spatula**

Malleable / 7" (18 cm)

- 412-770 1/4"
- 412-771 3/8"
- 412-772 1/2"
- 412-773 5/8"
- 412-774 3/4"
- 412-775 1"
- 412-776 1 1/4"
- 412-777 1 1/2"



412-770



412-771



412-772

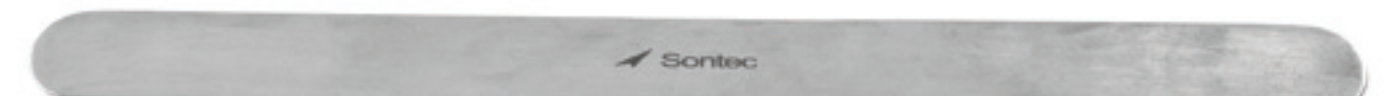

412-773



412-774



412-775

**Davis Brain Black Silicone Spatula**

**Silicone coated / malleable / 7" (18 cm)**

- 412-766 small 6 mm & 10 mm
- 412-767 medium 9 mm & 15 mm
- 412-768 large 11 mm & 20 mm
- 412-769 x-large 14 mm & 25 mm



412-766



412-767



412-768



412-769

**Davis Brain Spatula**

**Blue coated / malleable / round end**

- 412-794 2 mm 6" (15 cm)
- 412-796 4 mm 6" (15 cm)
- 412-798 6 mm 6" (15 cm)
- 412-795 2 mm 7" (18 cm)
- 412-797 4 mm 7" (18 cm)
- 412-799 6 mm 7" (18 cm)



412-794



412-797



412-799

**Blue coated / malleable / 6" (15 cm)**

- 412-790 3 prongs 3 mm
- 412-792 4 prongs 6 mm



412-790

**Blue coated / malleable / 7" (18 cm)**

- 412-791 3 prongs 3 mm
- 412-793 4 prongs 6 mm



 Sontec Instruments®

Nerve RETRACTORS

**Love Nerve Root Retractor**

Ergonomic ring handle / 90 degree / double loop curved blade 5x40 mm

412-605 7" (17.8 cm)

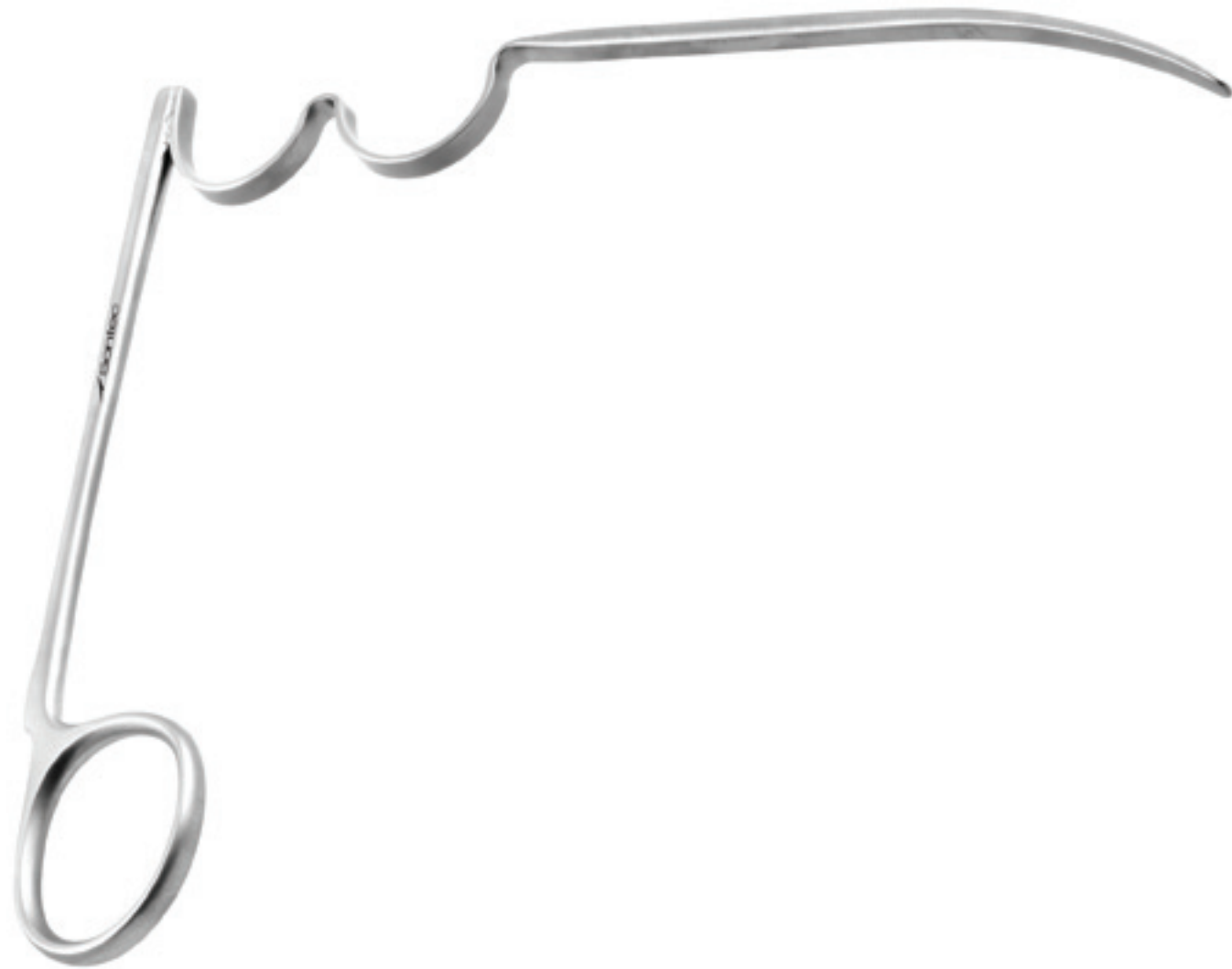

**Sontec-Love Nerve Root Retractor**

Knurled round handle

412-607 str 9.25" (23.5 cm)

412-608 45°

412-609 90°



**Love Nerve Root Retractor**

Classic model / flat handle

- 412-610 str
- 412-612 45°
- 412-614 90°



412-610

412-612

412-614

**Suction Nerve Retractor**

5" working length

- 412-721 4/2 mm 10 3/4" (27 cm)
- 412-722 7/3 mm 10 3/4" (27 cm)



412-721

412-722

**Suction Nerve Retractor**

7 french / 8" (20.3 cm)

- 412-7256 6 mm
- 412-7257 7 mm
- 412-7258 8 mm



412-7257

**Lighted Smith Nerve Retractor**

7/16 mm / 5" working length / 10 3/4" (27.3 cm)  
412-723



412-723

**Wide Scoville Nerve Root Retractor**

Phenolic handle / 9" (23cm)  
412-645A 10 mm  
412-645B 12 mm  
412-645C 14 mm

12 mm & 14mm have limited availability

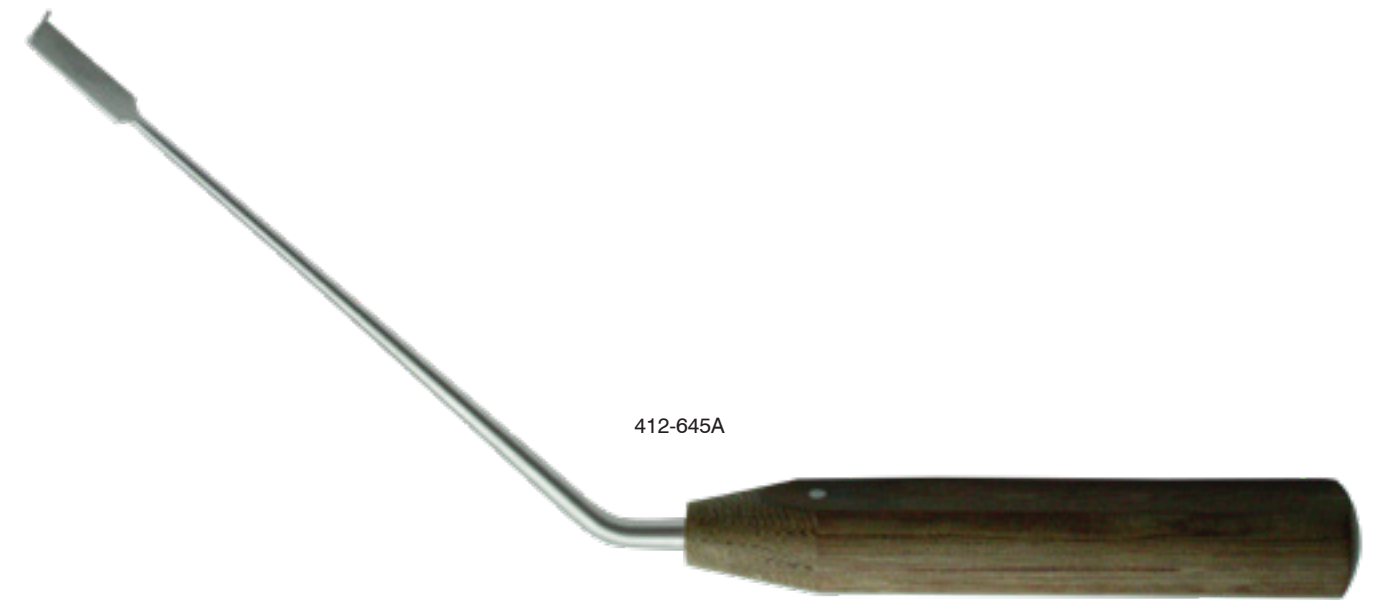

412-645A

**Hess Nerve Retractor**

**Short shaft / 6 1/2"**

- 412-620 45° 3mm
- 412-621 90° 3mm
- 412-622 45° 5mm
- 412-623 90° 5mm

**Long shaft / 7 1/2"**

- 412-624A 45° 3mm
- 412-624B 90° 3mm
- 412-625A 45° 5mm
- 412-625B 90° 5mm

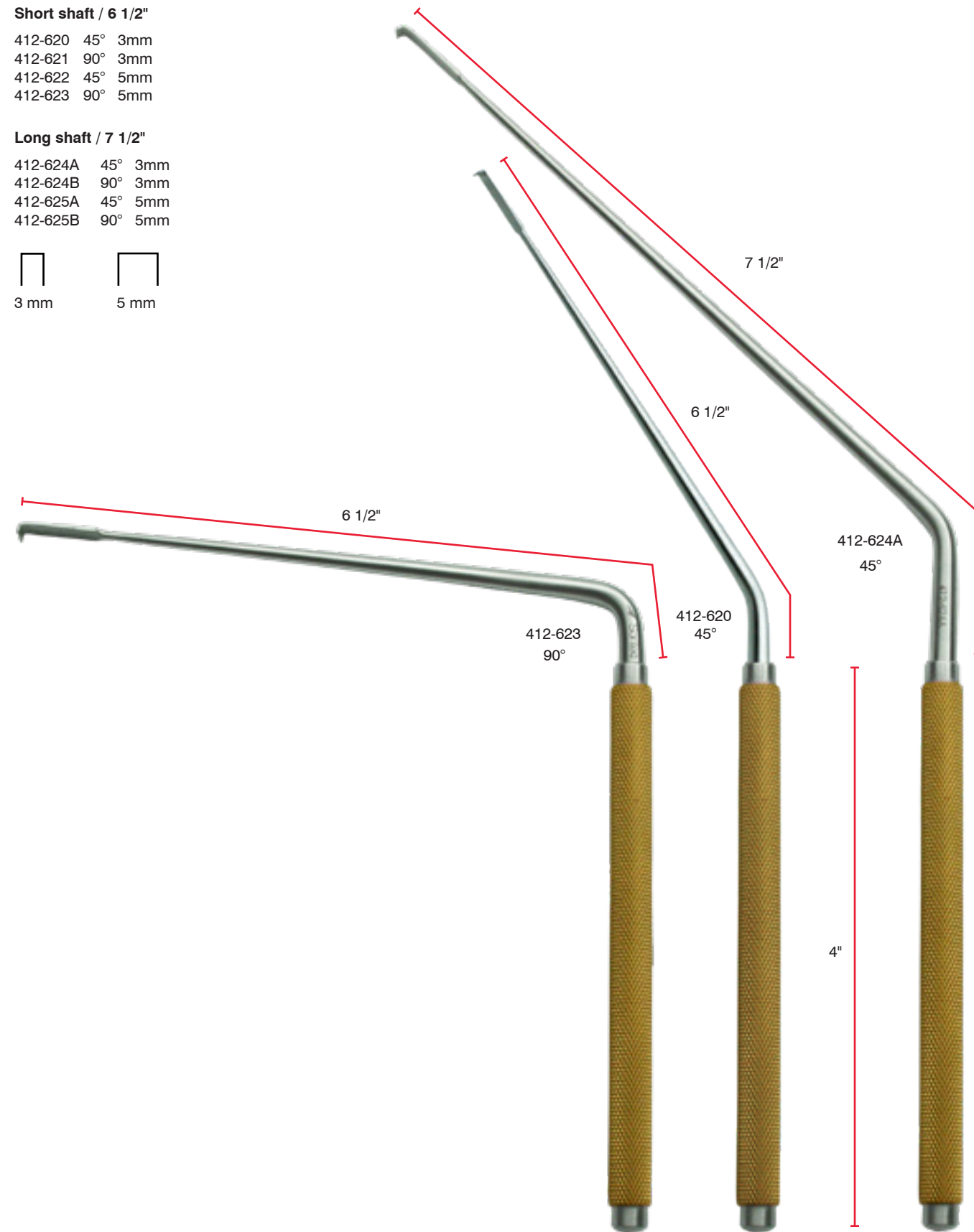
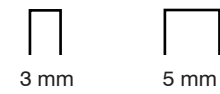

**Scoville Nerve Root Retractor**

**5" from bend / 10.5" (27 cm) / 8 mm**

- 412-643A straight
- 412-643B 45°
- 412-643C 90°
- 412-643D bayonet

\* 3 & 5 available on request

**7" from bend / 8 mm longer / 9" (23 cm)**

- 412-644A 45°
- 412-644B 90°
- 412-644C full curved

\* 3 & 5 available on request





 Sontec Instruments®

Rhoton Jacobson Curette & Dissector Hook Set

**Rhoton Circular Dissector 45°**

Stainless steel / 7 1/2" (19 cm)

413-001S	1 mm	stainless steel
413-001	1 mm	titanium
413-002S	2 mm	stainless steel
413-002	2 mm	titanium
413-003S	3 mm	stainless steel
413-003	3 mm	titanium

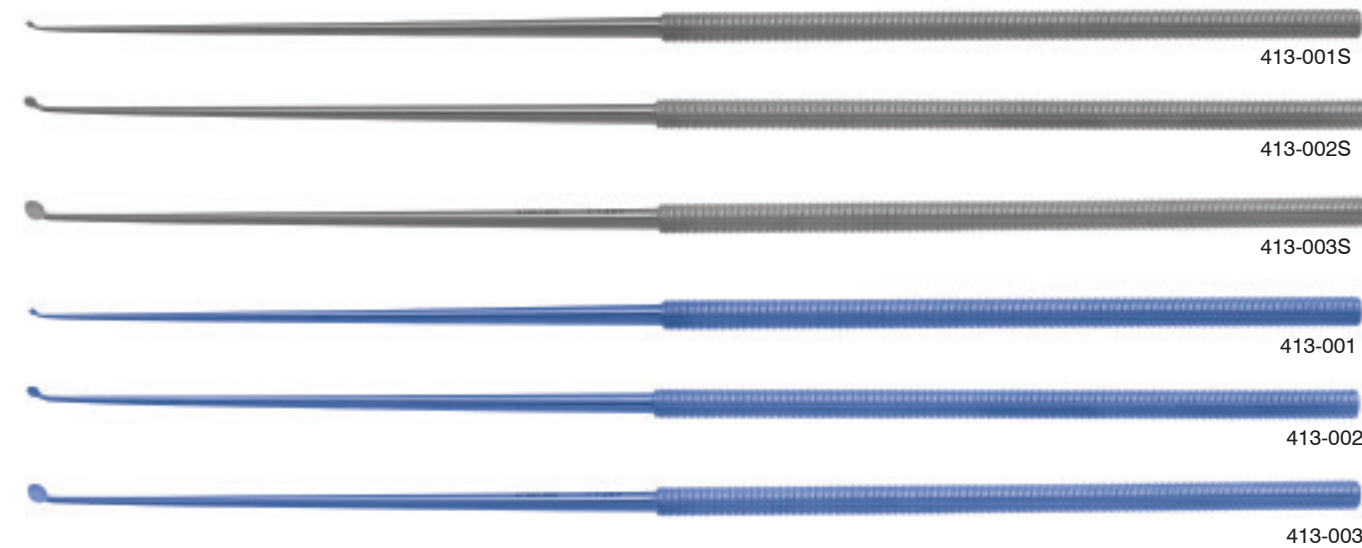

**Rhoton Dissector / Raspatory**

7 1/2" (19 cm)

413-004S	2.8 mm	curved	stainless steel
413-004	2.8 mm	curved	titanium
413-005S	1 mm	angled	stainless steel
413-005	1 mm	angled	titanium



**Jacobson Hook**

Sharp / 2 mm / 90° / 7 1/2" (19 cm)

413-006S	stainless steel
413-006	titanium



**Rhoton Dissector / Raspatory**

Semi-sharp / 25° / 7 1/2" (19 cm)

413-007S	1.5 mm	stainless steel
413-007	1.5 mm	titanium
413-008S	2 mm	stainless steel
413-008	2 mm	titanium
413-009S	1 mm	stainless steel
413-009	1 mm	titanium

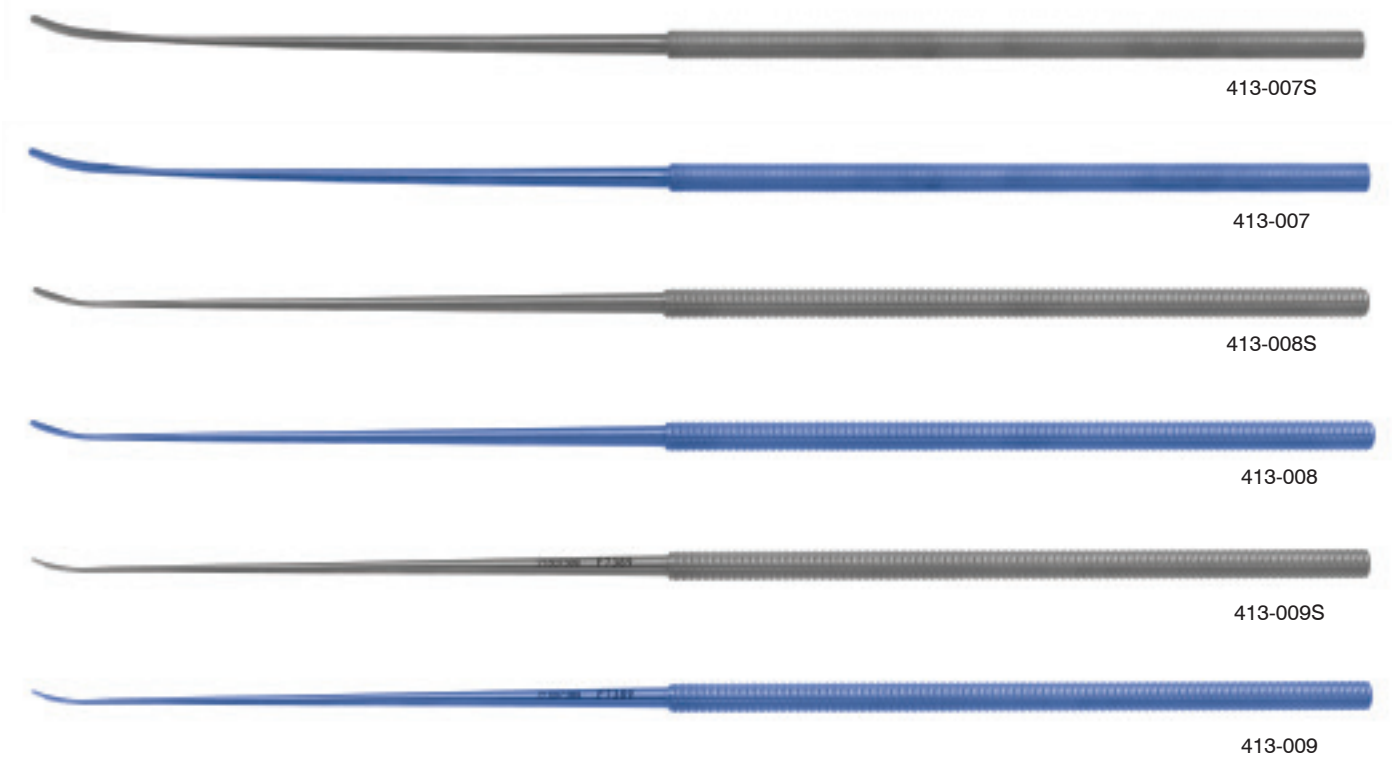

**Rhoton Hook**

7 1/2" (19 cm)

413-010S	90°	2 mm	blunt	stainless steel
413-010	90°	2 mm	blunt	titanium
413-011S	45°	3 mm	semi sharp	stainless steel
413-011	45°	3 mm	semi sharp	titanium



**Rhoton Pick**

Semi Sharp / straight / 7 1/2" (19 cm)

413-012S	stainless steel
413-012	titanium



**Rhoton Curette**

1 x 2 mm / 7 1/2" (19 cm)

413-013S	straight	stainless steel
413-013	straight	titanium
413-014S	45° angled	stainless steel
413-014	45° angled	titanium



**Jacobson Button End Probe**

Straight / blunt / 1 mm / 7 1/2" (19 cm)

413-015S	stainless steel
413-015	titanium



**Jacobson Hook Probe**

Angled 45° / 1x8 mm long / 7 1/2" (19 cm)

413-019S	stainless steel
413-019	titanium



**Jacobson Button End Hook Probe**

Angled 90° / 1 x 3.5 mm / 7 1/2" (19 cm)

413-016S	stainless steel
413-016	titanium



**Jacobson Hook Probe**

Blunt / Angled 90° / 1x5 mm long / 7 1/2" (19 cm)

413-017S	stainless steel
413-017	titanium

Blunt / Angled 45° / 1x5 mm long / 7 1/2" (19 cm)

413-018S	stainless steel
413-018	titanium





 Sontec Instruments®

Spinal RASPS

**Long Handle File**

Black plastic handle /  
square file / 18" (45.7 cm)

320-591 straight  
320-592 15° angle

Black plastic handle / round  
file / straight / 18" (45.7 cm)

320-593



320-591



320-593



320-592

**JPS Bone File**

8 3/4" (22.2 cm)

345-217



back



front

345-217



 Sontec Instruments®

Spinal RETRACTORS

**Gelpi Original Spinal Retractor**

Deep angle / parallel tips / multilevel distraction  
230-405

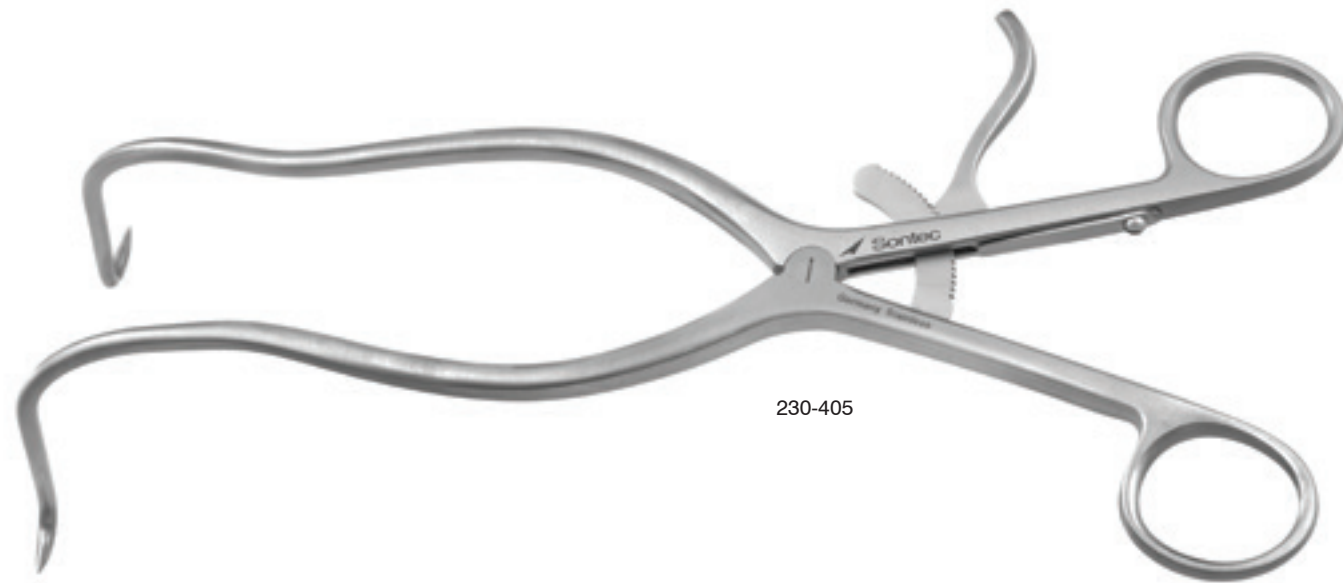

230-405

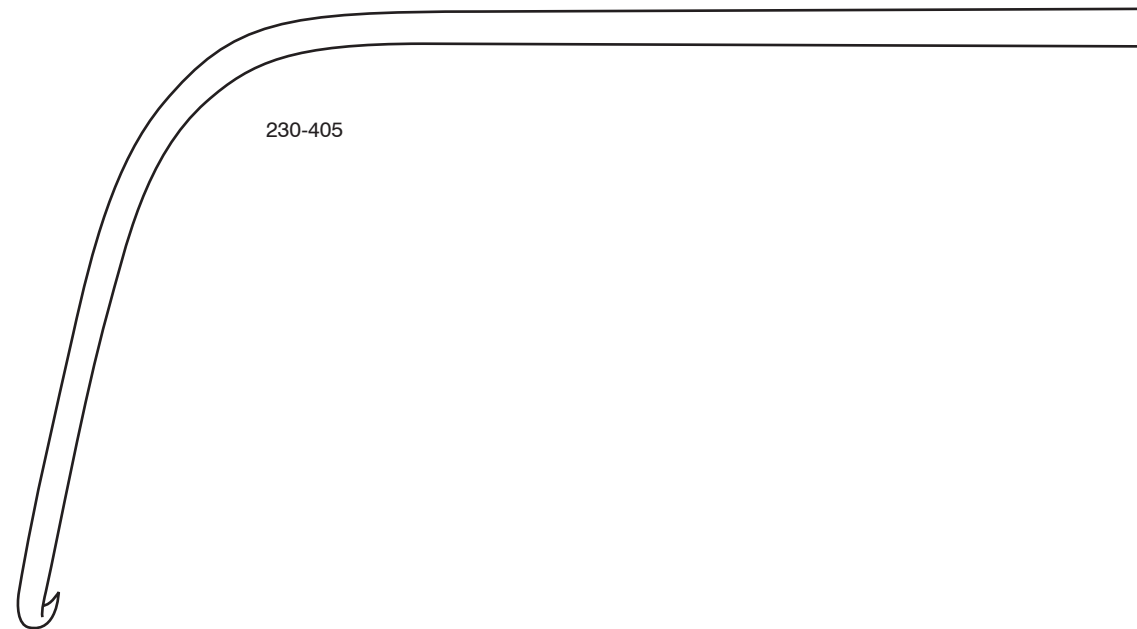

230-405

**Gelpi Retractor Titanium**

Parallel tips / multilevel distraction /  
9.5" (24 cm)  
230-406T deep angle  
230-406N neroma

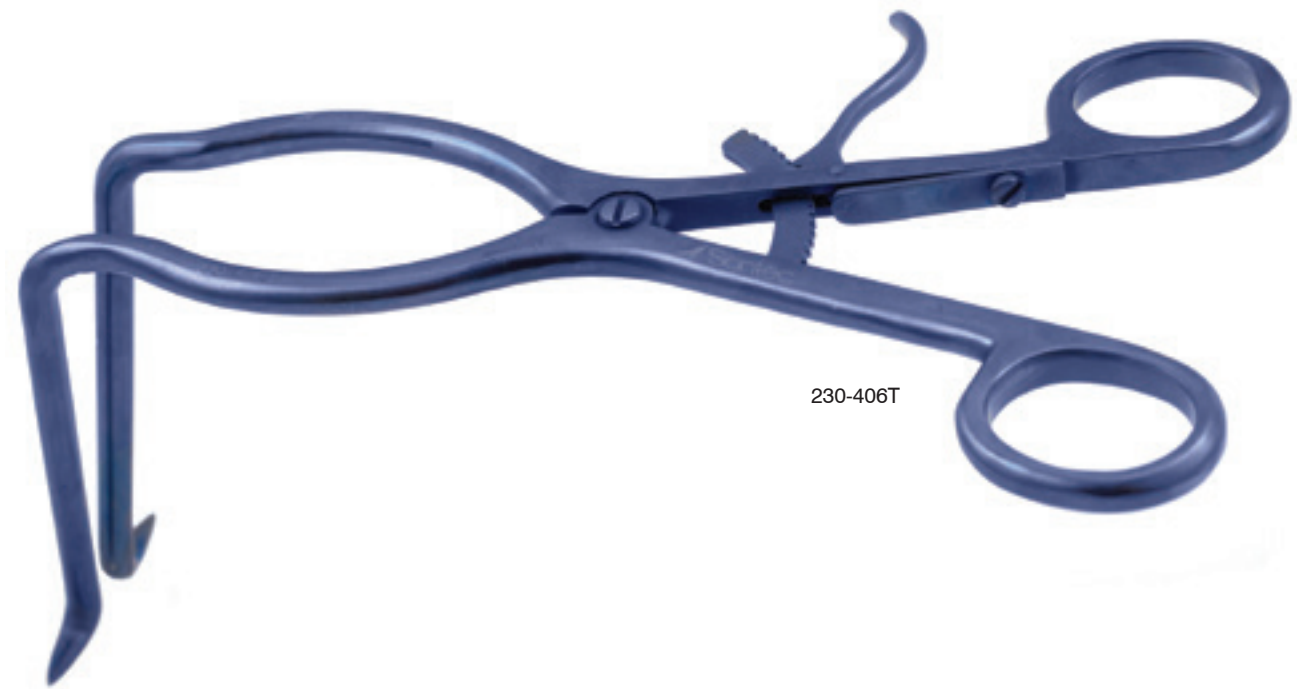

230-406T

**Gelpi Spinal Retractor**

Deep angle / double prongs / with  
ratchet / 13" (33 cm)  
417-088

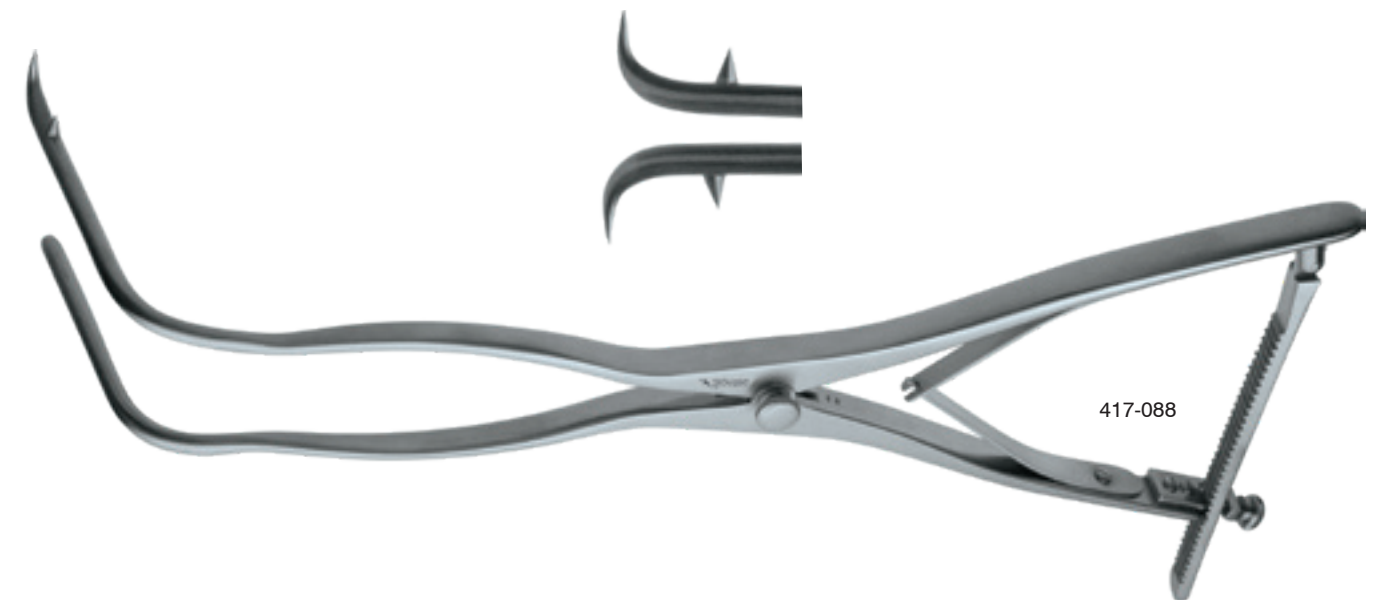

417-088

**Gelpi Spinal Retractor**

90° angle / with speed lock

- 230-371 1.5" / 11.5"
- 230-372 2" / 12"
- 230-373 3" / 13"

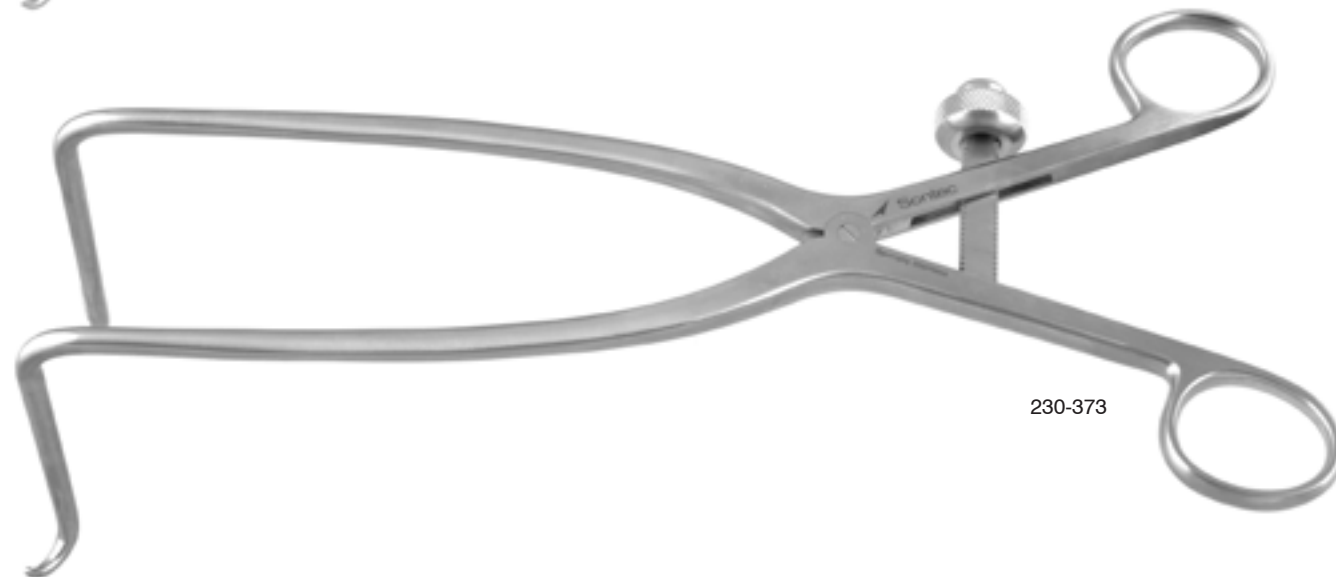
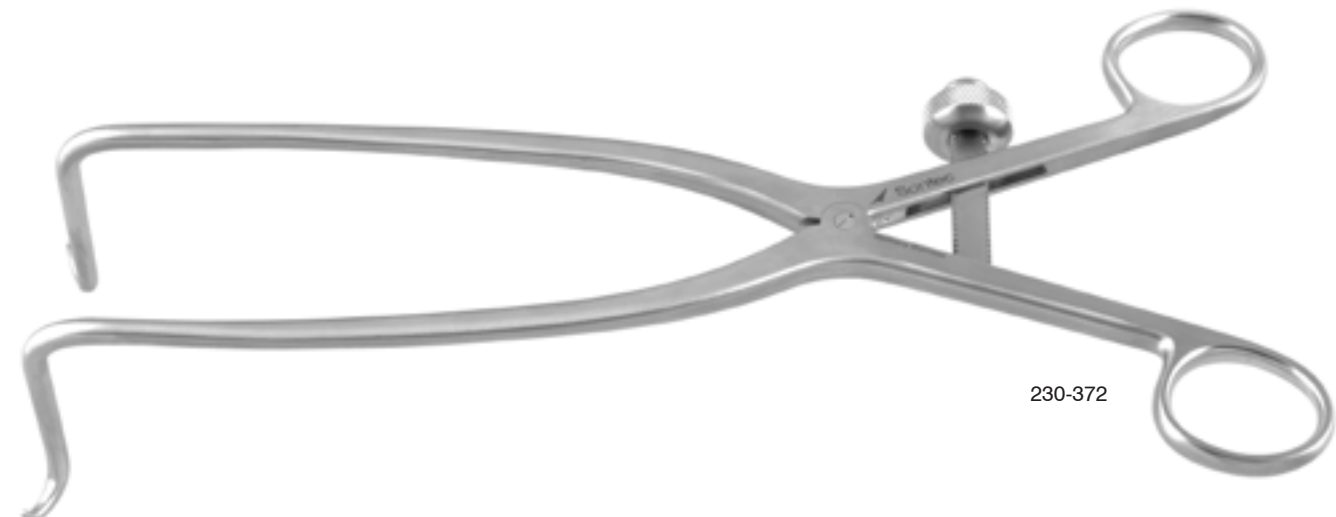
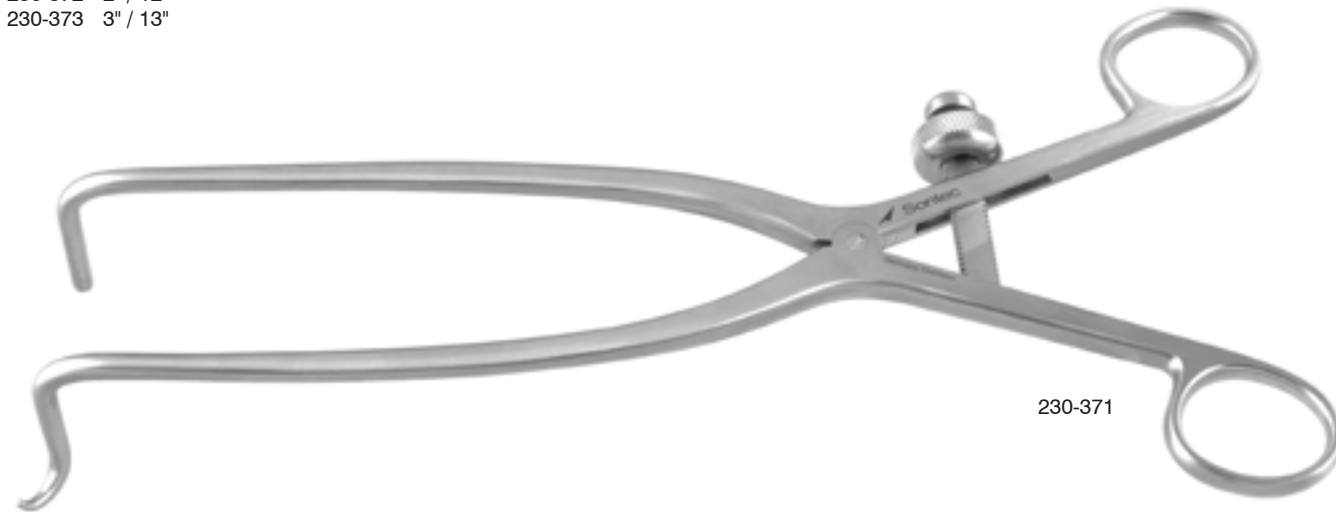

**Gelpi Spinal Retractor**

90° angle / with speed lock

- 230-374 4" / 14"
- 230-375 5" / 15"



**Neroma Gelpi Spinal Retractor**

90° angle / blunt / with speed lock

230-376 14" overall length with 4" deep arms

230-378 15" overall length with 5" deep arms

\* special order, minimum order 5 each

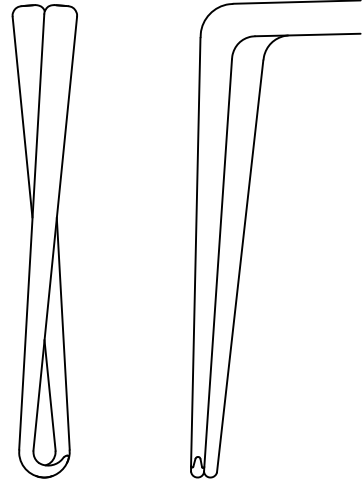
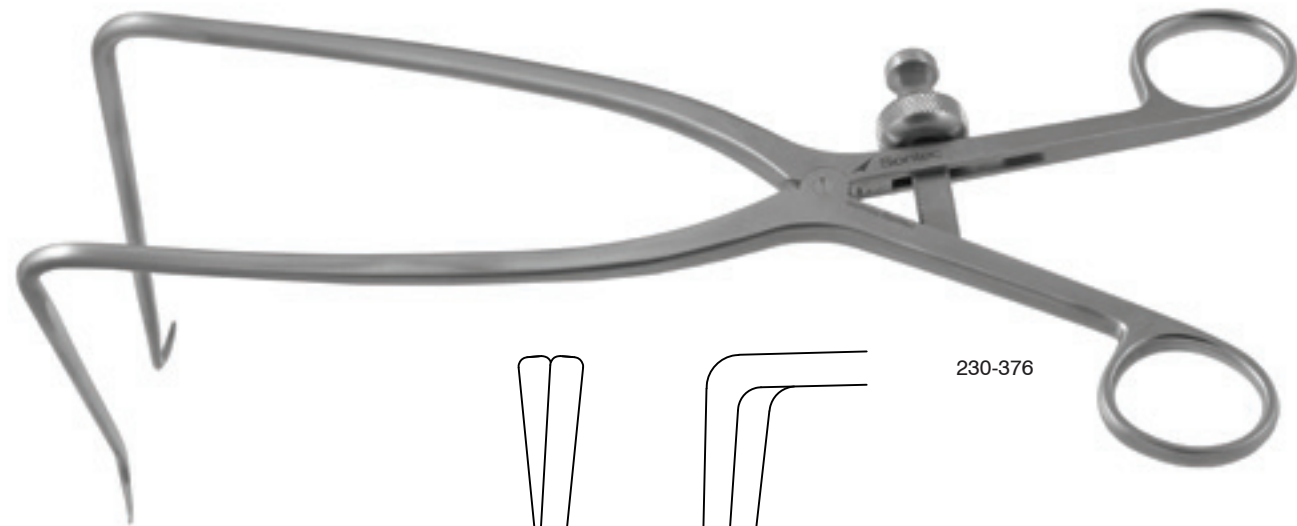

230-376

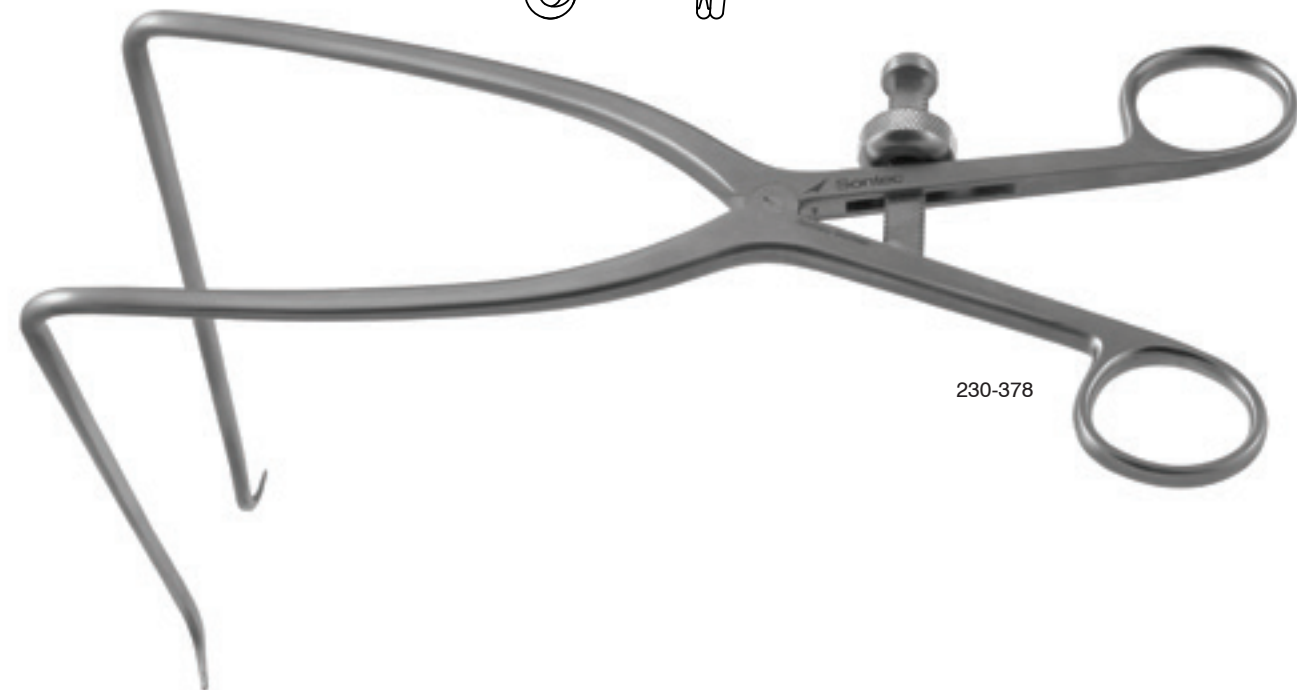

230-378

**Weitlaner Retractor**

Hinged arms / 3 x 4 prongs

1100-636 sharp 5 1/2" (14 cm)

1100-638 blunt 5 1/2" (14 cm)

1100-640 sharp 6 1/4" (16 cm)

1100-642 blunt 6 1/4" (16 cm)

1100-644 sharp 8" (20.5 cm)

1100-644B blunt 8" (20.5 cm)

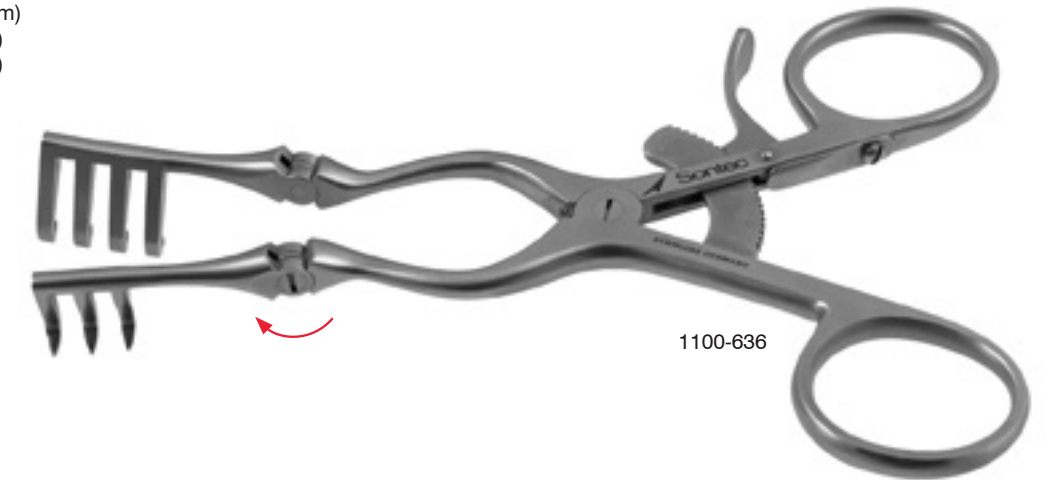

1100-636

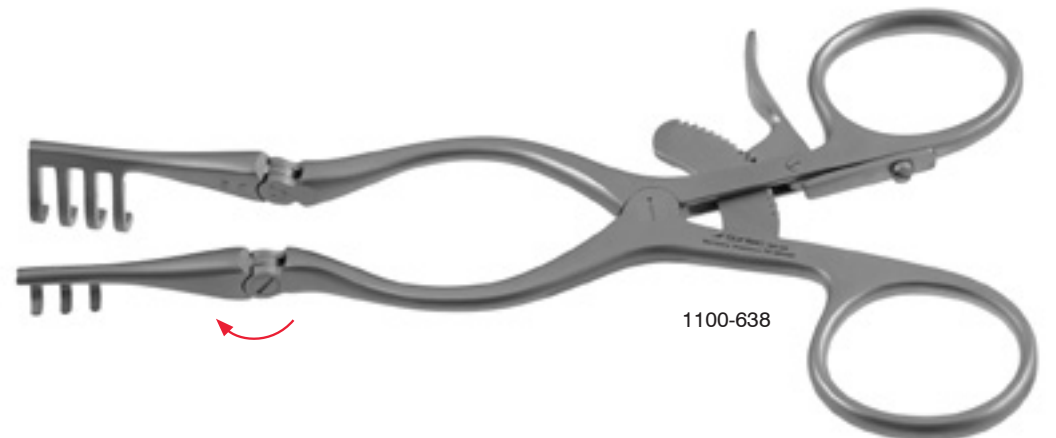

1100-638

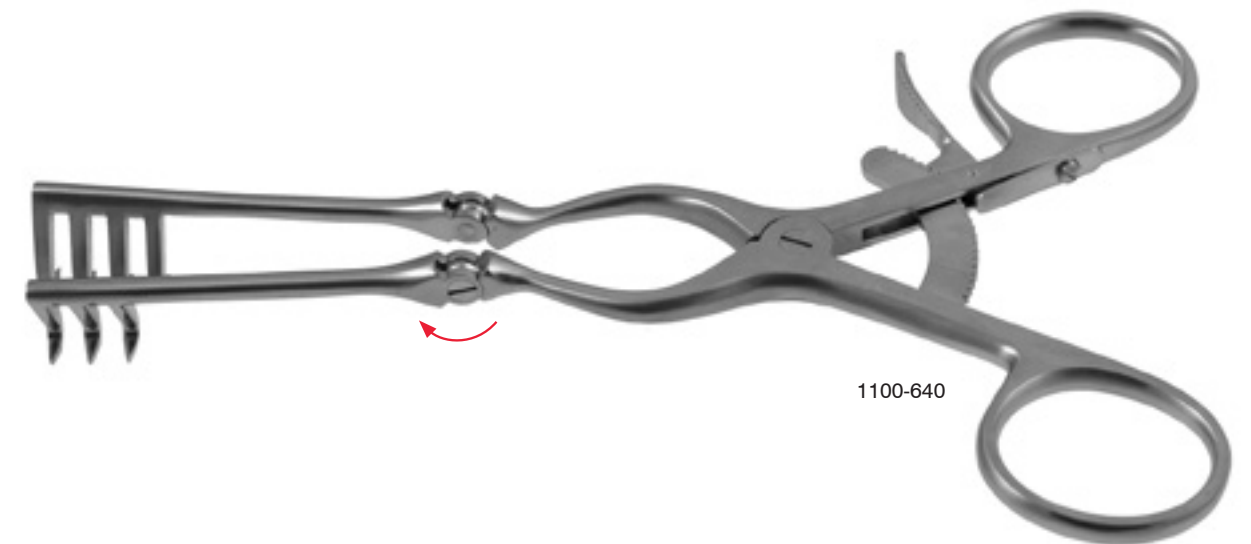

1100-640

**Adson Cerebella Retractor**

4 x 4 sharp prongs / 7 1/2" (19 cm)

230-480 straight arms

230-486 angled arms



**Weitlaner Retractor Titanium**

3x4 prongs / sharp / 5 1/2" (14 cm)

2600-618

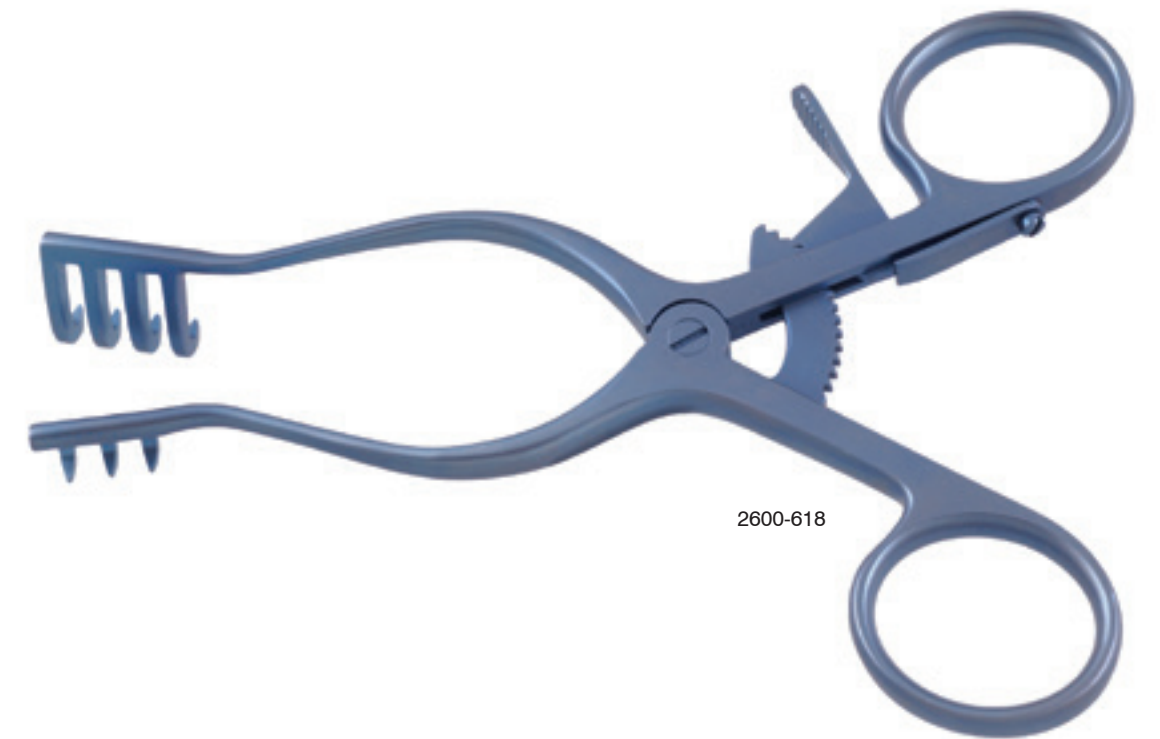

**Weitlaner Retractor**

**2 x 3 prongs**

- 1100-616 sharp 4" (10 cm)
- 1100-617 blunt 4" (10 cm)

**3 x 4 prongs**

- 1100-618 sharp 5 1/2" (14 cm)
- 1100-619 blunt 5 1/2" (14 cm)
- 1100-620 sharp 6 1/4" (16 cm)
- 1100-621 blunt 6 1/4" (16 cm)
- 1100-622 sharp 8" (20.5 cm)
- 1100-623 blunt 8" (20.5 cm)
- 1100-624 sharp 9 1/2" (24 cm)
- 1100-625 blunt 9 1/2" (24 cm)



sharp



blunt



1100-617



1100-618



1100-619

**Weitlaner Extended Blades Retractor**

With 4 prongs / prong depth 3.5 cm / straight arms / blunt tips / 4 1/2" (11.4 cm)

230-445

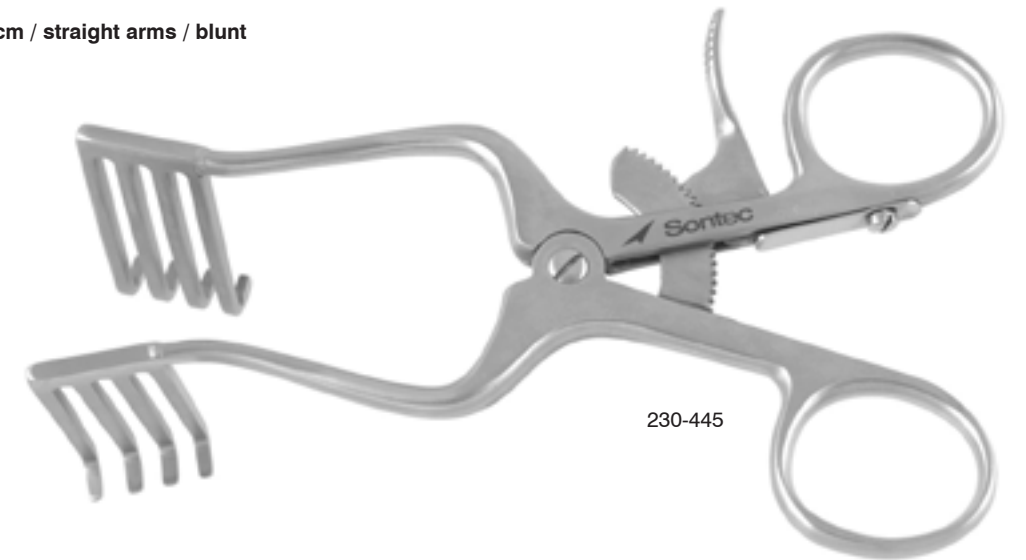

230-445

**Beckman-Adson Retractor**

4 x 4 prongs / 12 1/4" (31 cm) / hinged

- 1100-645B blunt
- 1100-645S sharp



1100-645B

**Beckman Retractor**

3 x 4 prongs / hinged / sharp / 10" (25.4 cm)

230-4901

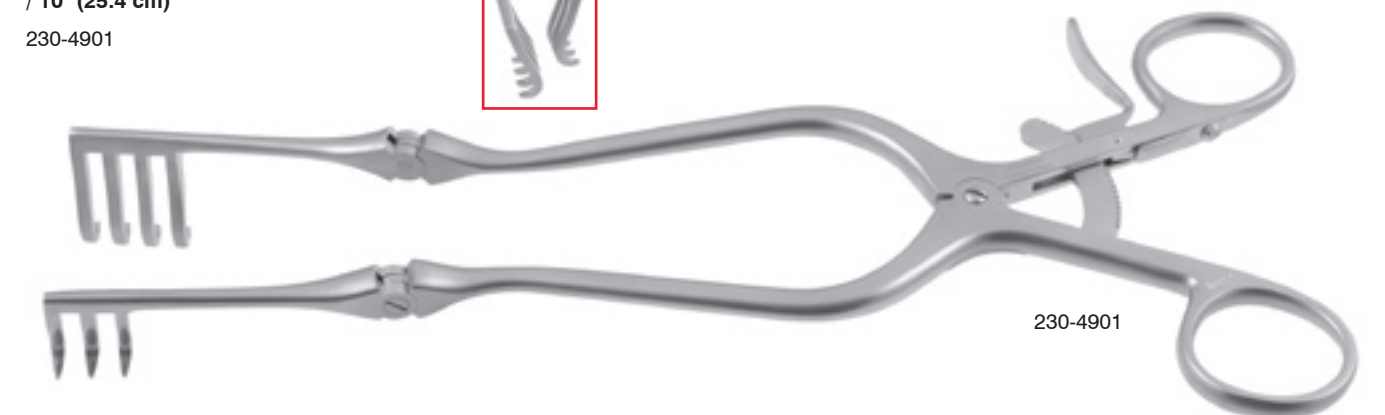

230-4901

**Mollison Retractor**

2 x 2 sharp 12 mm blades / 5" (13 cm)

1100-6251

4 x 4 sharp 15 mm blades / 6 3/4" (17 cm)

1100-6252

4 x 4 sharp 13 mm blades / 6" (15 cm)

1100-6253

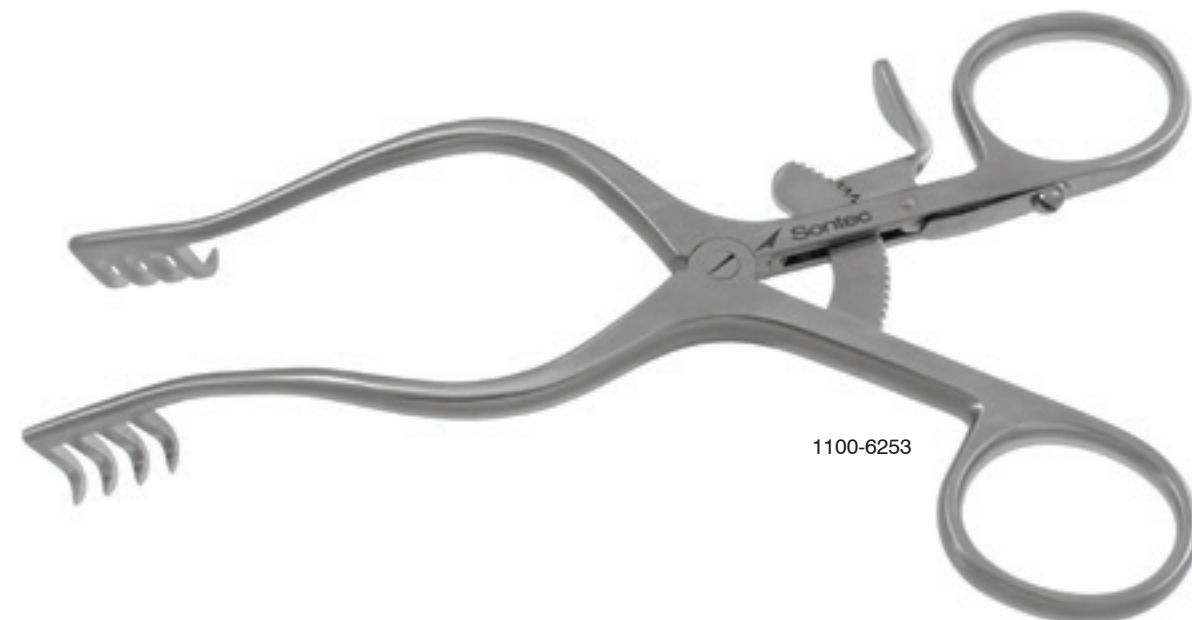
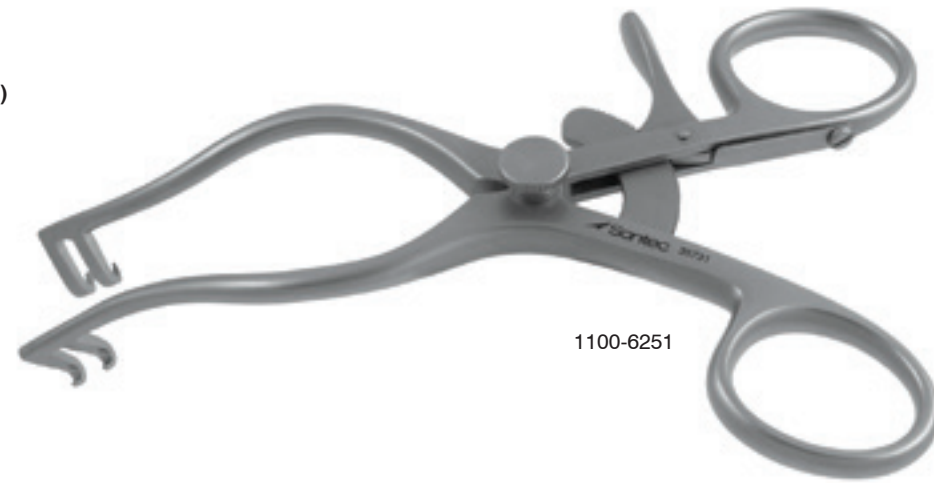

**Gelpi Spinal Retractor**

90° angle / with speed lock / with cerebellar tip / 13 1/2" (34.3 cm)

230-365

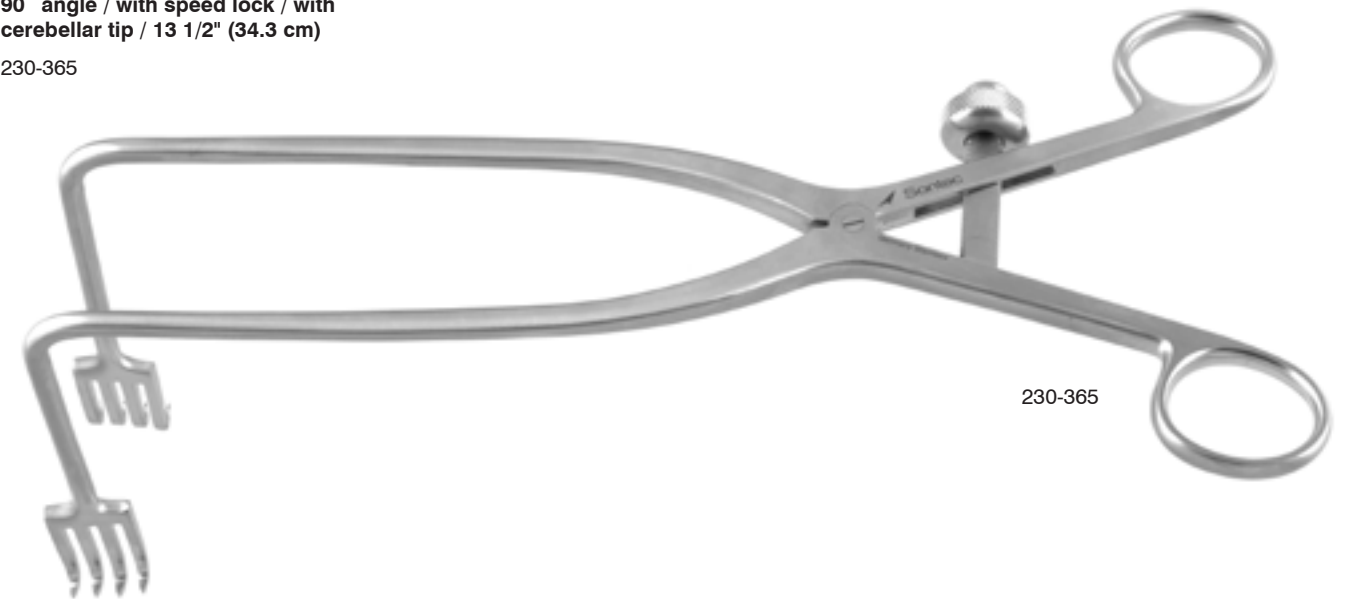

**Frazier Lamina Retractor**

1 1/4" deep / 3 x 4 prongs / 4" (10 cm) spread

1100-608



**Sontec Multi-Level Gelpi Retractor**

Sharp / 3 x 3 parallel prongs / 25 mm between prongs / 12" (30.5 cm)

- 230-352 50 mm prong tip
- 230-354 35 mm prong tip
- 230-357 60 mm prong tip
- 230-360 95 mm prong tip

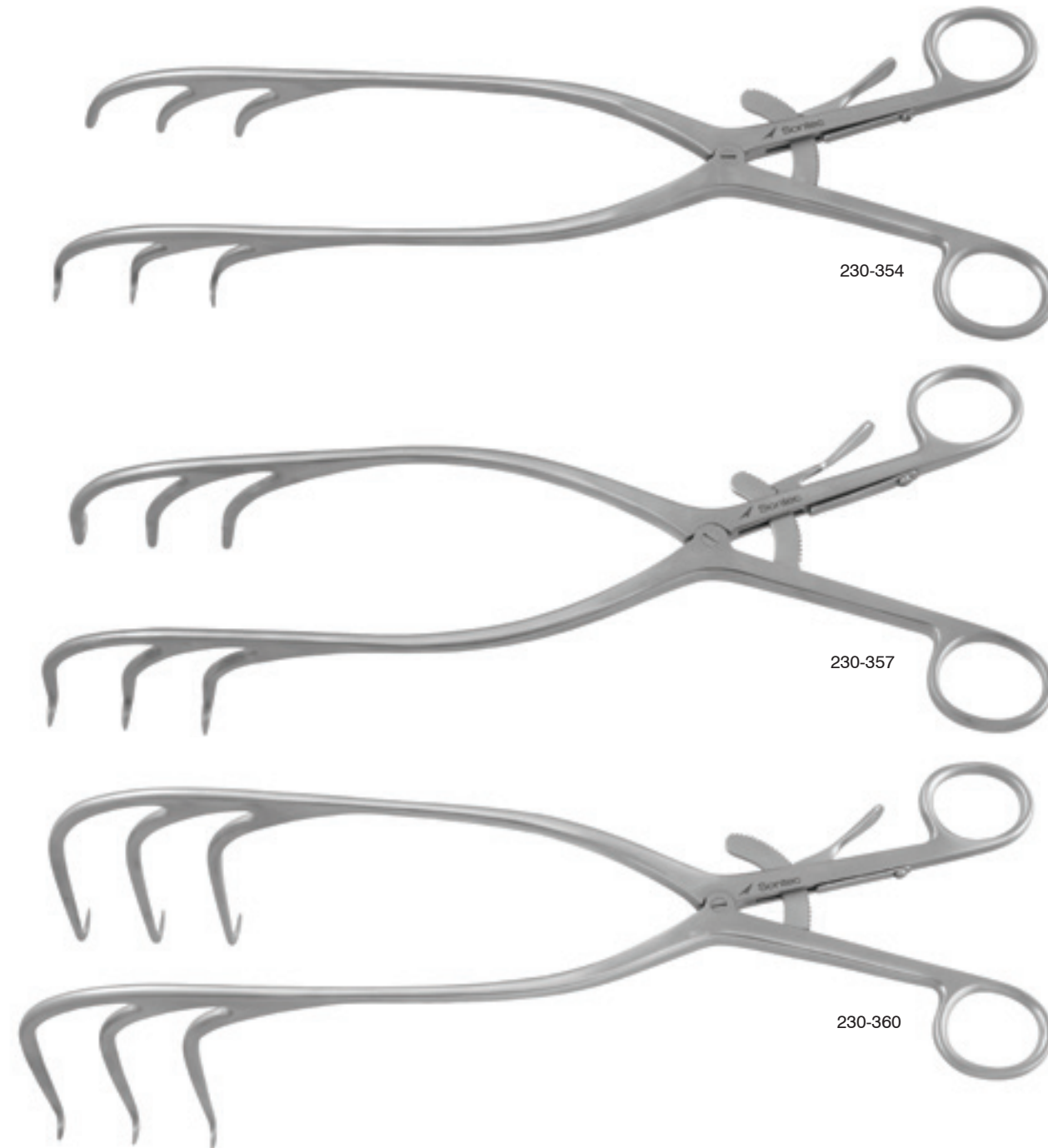
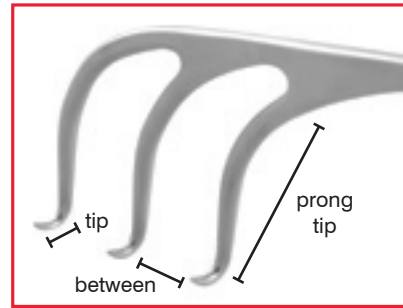

**Sontec Multi-Level Off Set Arms Gelpi Retractor**

Sharp / 3 x 3 prongs / 10.5" (27 cm) / "Shorter design in arms adds more stability with less flex."

- 230-337 right 64 mm & 44 mm prongs 7 mm tip
- 230-338 left 44 mm & 64 mm prongs 7 mm tip

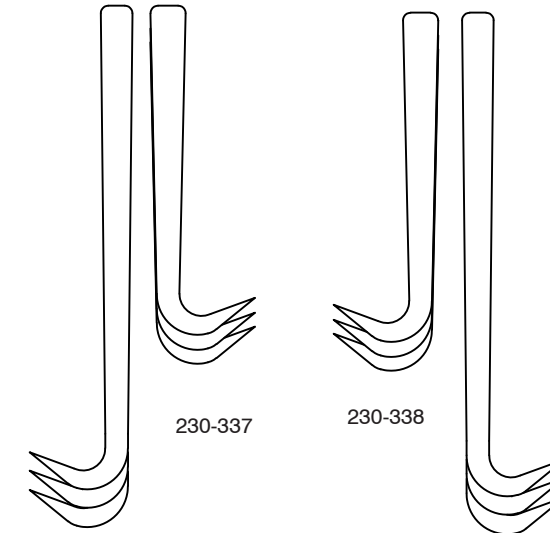
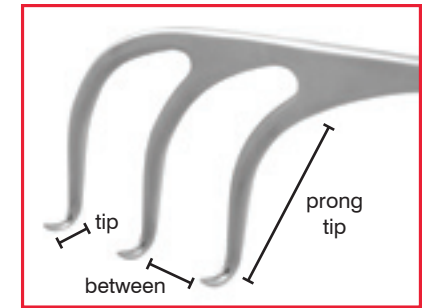

**Beckman-Eaton Retractor**

Hinged blades / 7 x 7 prongs / sharp / 12 1/2" (32 cm)

1100-646



**Sontec Multi-Level Gelpi Retractor**

Sharp / 3 x 3 prongs / with off-set arms / 10.5" (27 cm)  
 230-347 60 mm prongs 7 mm tip

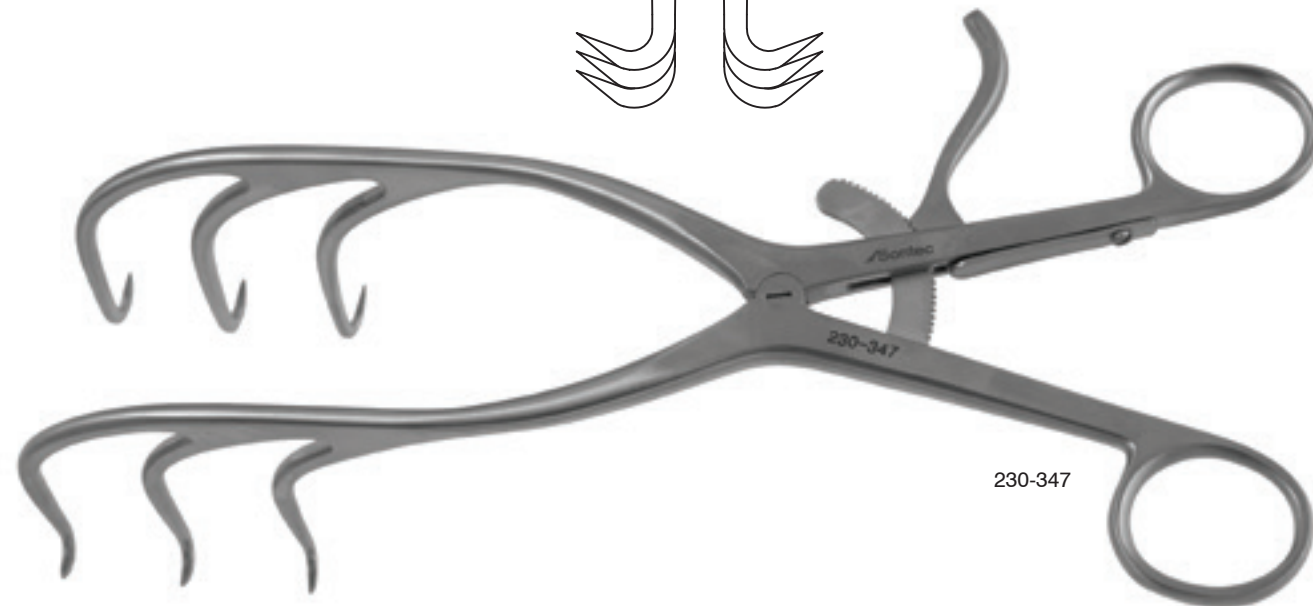
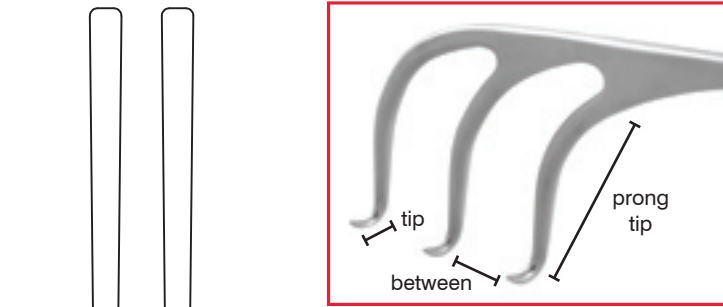

230-347

**Miskimon Cerebellum Retractor**

7 x 7 prongs  
 417-045 sharp 7 3/4" (20 cm)



417-045

**Spinal Distractor/Compressor**

11 1/4" (28.6 cm)  
 416-604 distractor  
 416-601 compressor



416-601



416-604

**Spinal Distractor**

1/4" rods / 45° angle / small style  
 416-603 9 1/2" (24 cm)

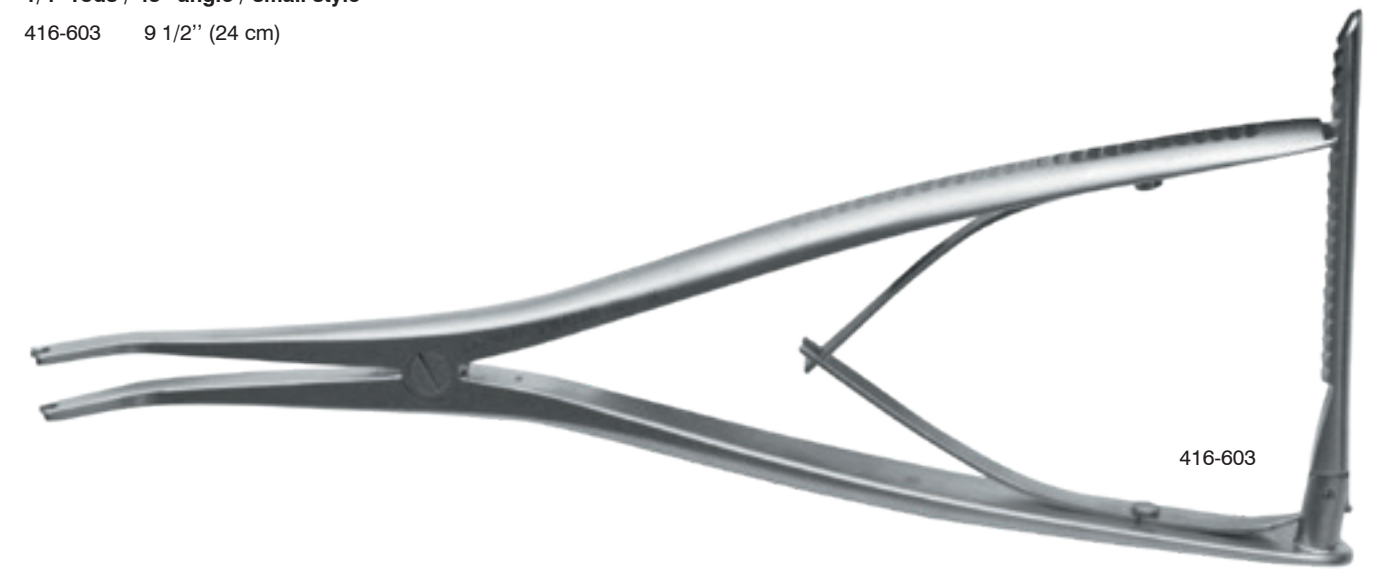

416-603

**Spinal Compressor**

Small style

416-602 10" (25.5 cm)



416-602

**Spinal Distractor**

1/4" rods / 45° angle / large style

416-605 12 1/2" (32 cm)



416-605

**Spinal Compressor**

Large style

416-600 12" (30.5 cm)



416-600

**Double-Action Distractor**

1/4" rods / 30° angle / 15" (38.1 cm)

416-610



416-610

**Double-Action Compressor**

1/4" rods / 30° angle / 15" (38.1 cm)

416-615



416-615



 Sontec Instruments®

SUCTION Selection

**General Suction Information**

**French measurement scale for determining suction tube diameter**

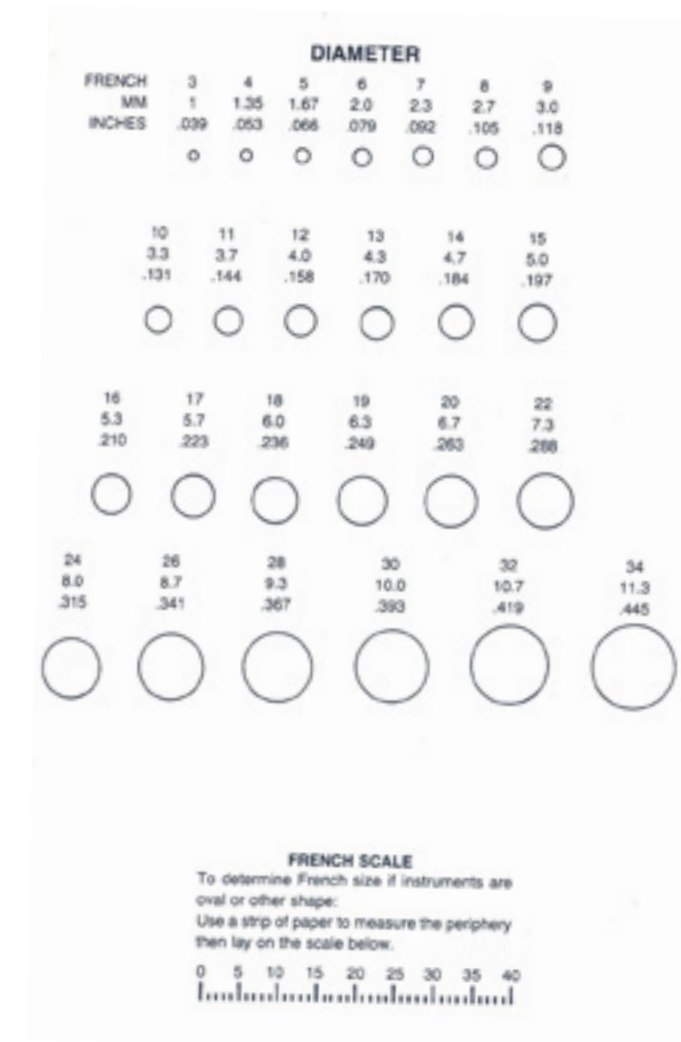

**Frazier Angled Suction**

Finger cut-off hole to control suction /  
angled / 7" (18 cm)

- 412-677 3 french
- 412-678 4 french
- 412-679 5 french
- 412-680 6 french
- 412-681 7 french
- 412-682 8 french
- 412-683 9 french
- 412-684 10 french
- 412-685 11 french
- 412-686 12 french
- 412-688 15 french

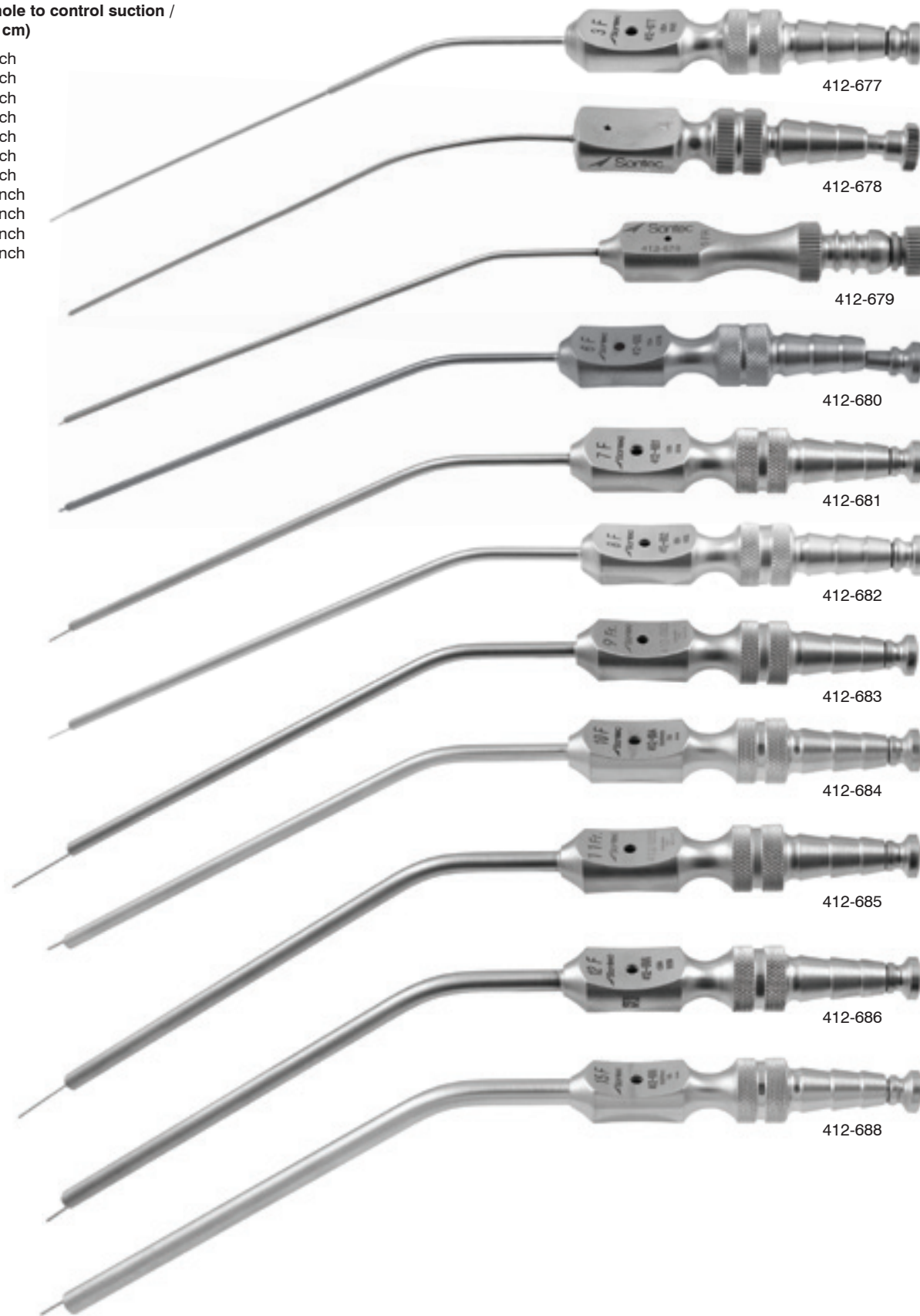

**Frazier Angled Suction**

9" (23 cm)  
412-705 10 french



**Frazier Angled Suction**

Finger cut-off hole to control suction / angled / malleable / 7" (18 cm)

- 412-677M 3 french
- 412-678M 4 french
- 412-680M 6 french
- 412-681M 7 french
- 412-682M 8 french
- 412-683M 9 french
- 412-684M 10 french
- 412-685M 11 french
- 412-686M 12 french
- 412-688M 15 french

\* special order

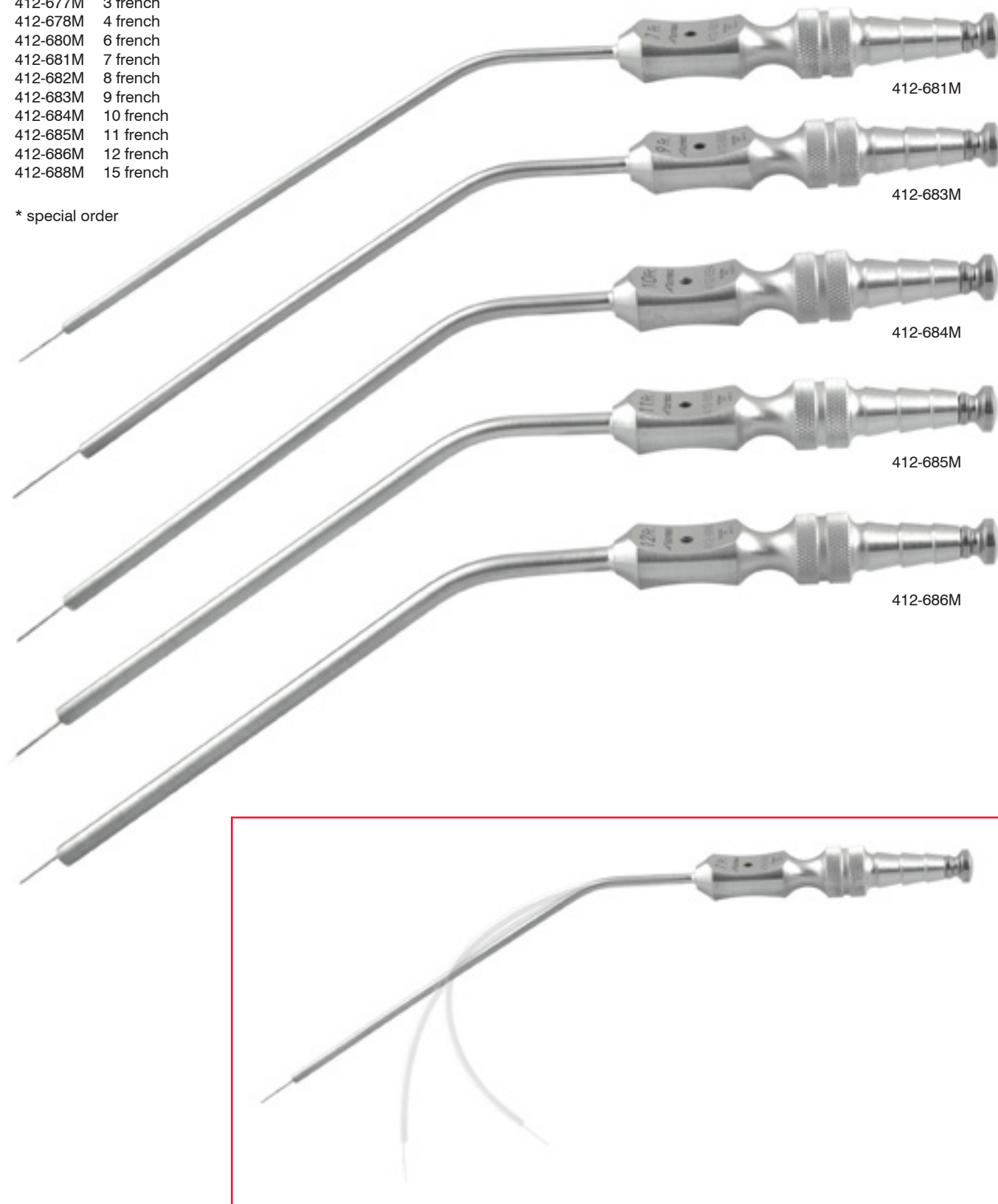

**Frazier Angled Suction**

Finger cut-off slot to control suction / angled / 7" (18 cm)

- 412-677L 3 french
- 412-678L 4 french
- 412-679L 5 french
- 412-680L 6 french
- 412-681L 7 french
- 412-682L 8 french
- 412-683L 9 french
- 412-684L 10 french
- 412-685L 11 french
- 412-686L 12 french

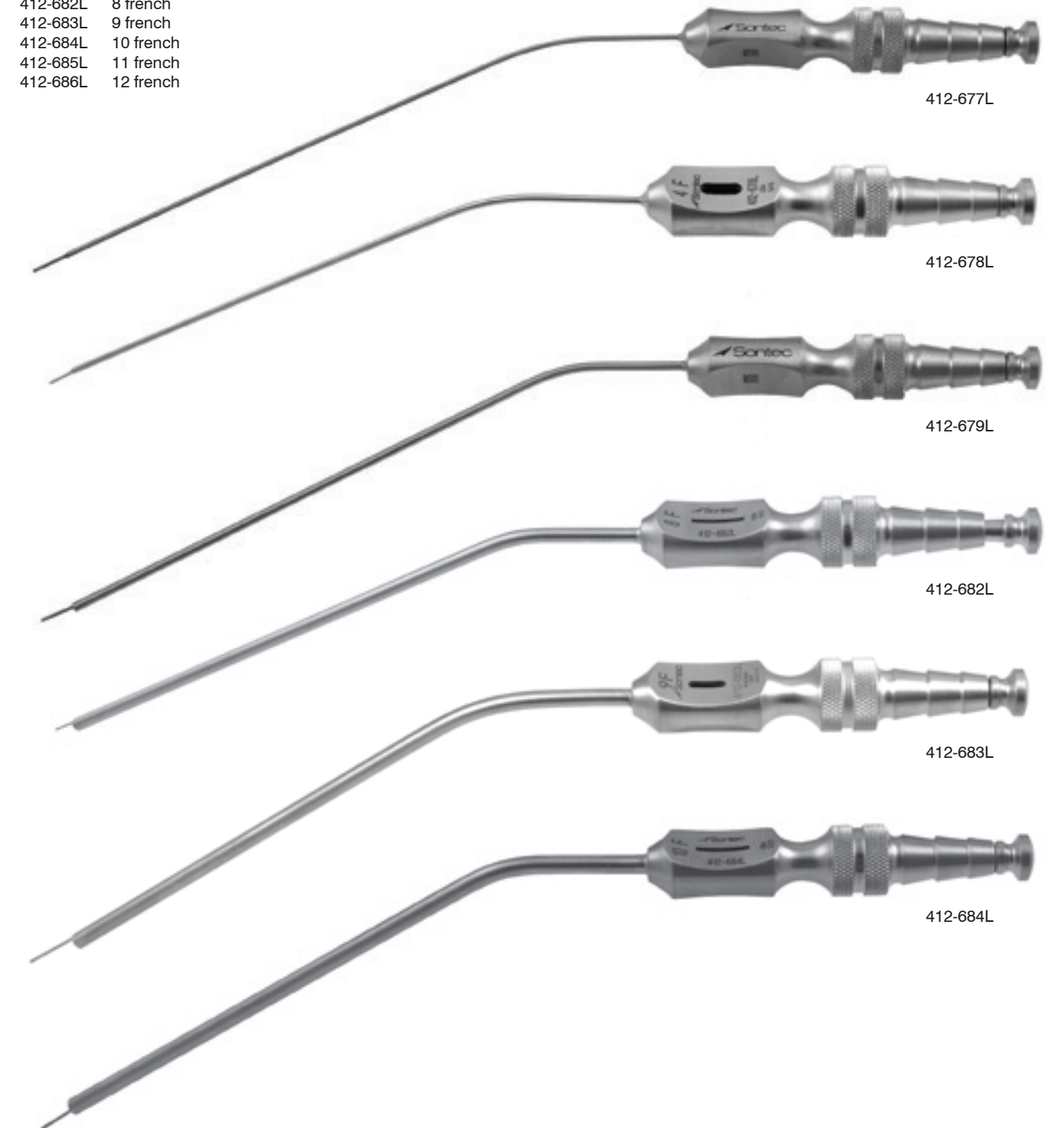

**Frazier Straight Suction**

Finger cut-off hole to control suction / straight / 7" (18 cm)

- 412-689 5 french
- 412-690 6 french
- 412-691 7 french
- 412-692 8 french
- 412-694 10 french
- 412-696 12 french

9" (23 cm)

- 412-700 6 french
- 412-701 7 french
- 412-702 8 french
- 412-704 10 french
- 412-706 12 french



**Frazier Insulated Suction**

Finger cut-off hole to control suction / angled / Insulated electro coated tube / 7" (18 cm)

- 412-677I 3 french
- 412-678I 4 french
- 412-679I 5 french
- 412-680I 6 french
- 412-681I 7 french
- 412-682I 8 french
- 412-683I 9 french
- 412-684I 10 french
- 412-685I 11 french
- 412-686I 12 french

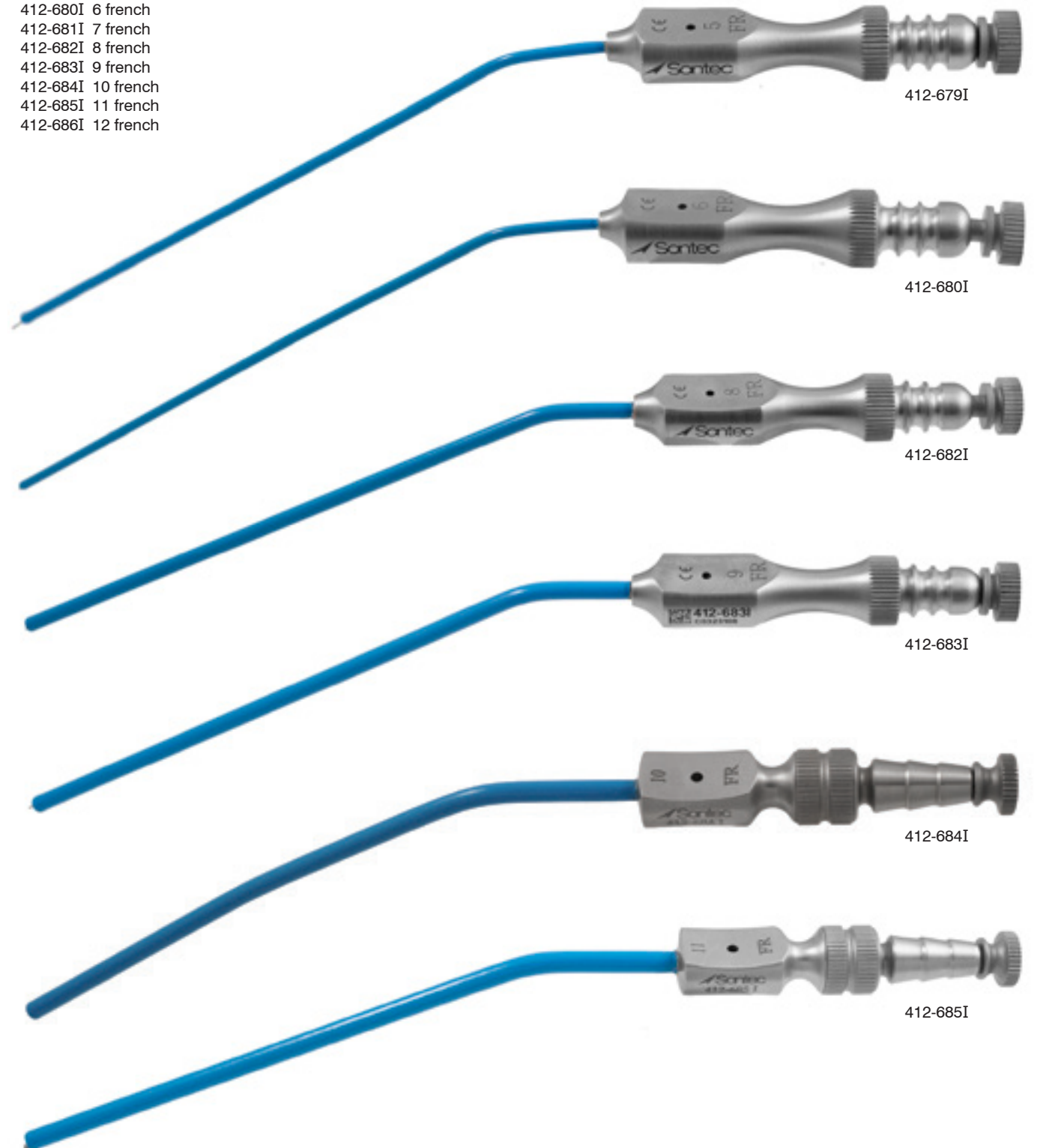

**Frazier-Rhoton Angled Suction**

Finger cut-off hole to control suction / angled / with olive tip / 7" (18 cm)

- 412-681R 7 french
- 412-682R 8 french
- 412-686R 12 french

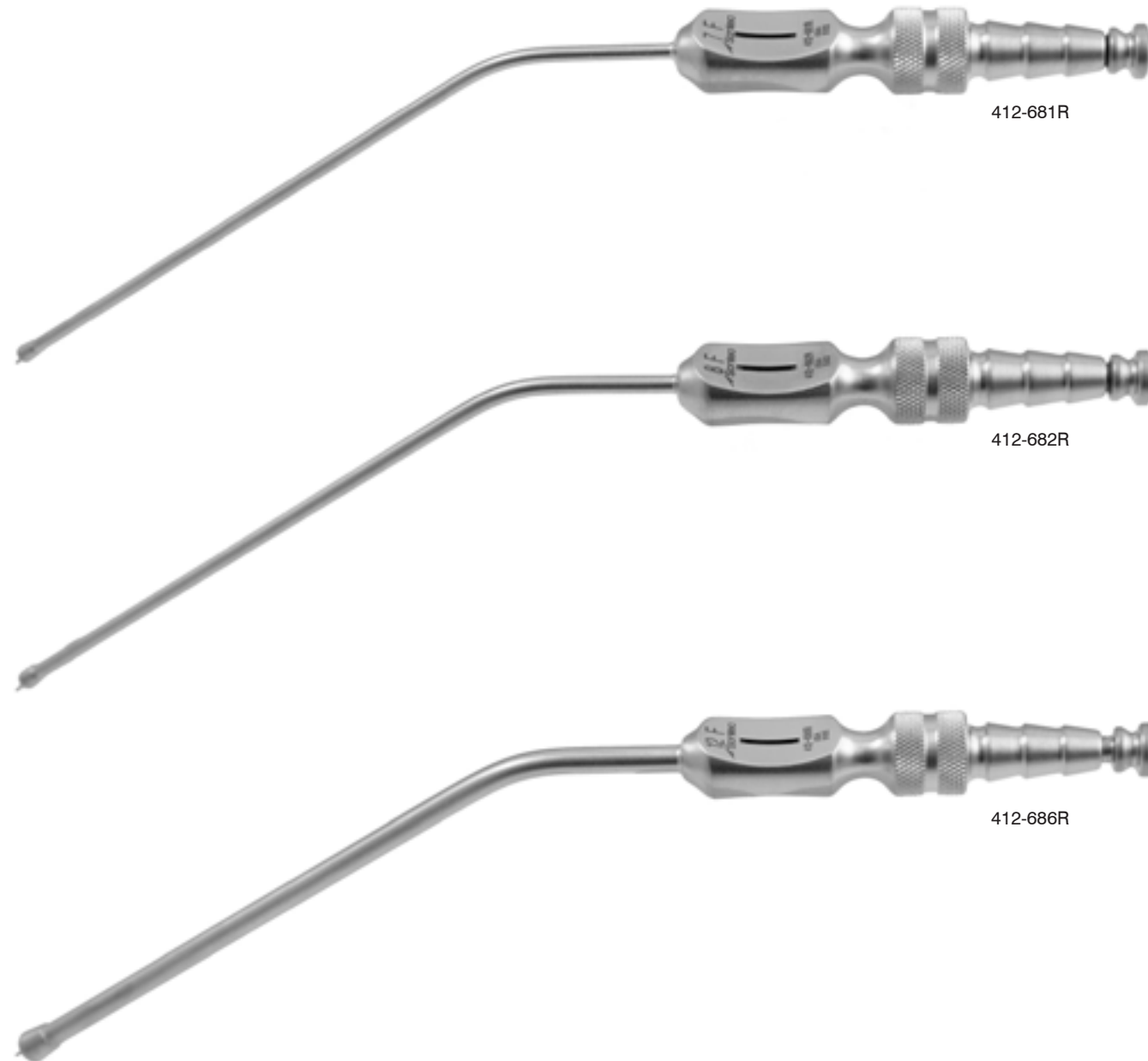

**Rhoton Micro Neuro Suction**

Specially blunted atraumatic tips / 80 mm working length

- 412-839 3 french
- 412-840 5 french
- 412-844 7 french
- 412-841 10 french

**100 mm working length**

- 412-845 3 french
- 412-848 5 french
- 412-846 7 french
- 412-847 10 french

**130 mm working length**

- 412-849 5 french
- 412-850 7 french
- 412-851 10 french
- 412-852 12 french

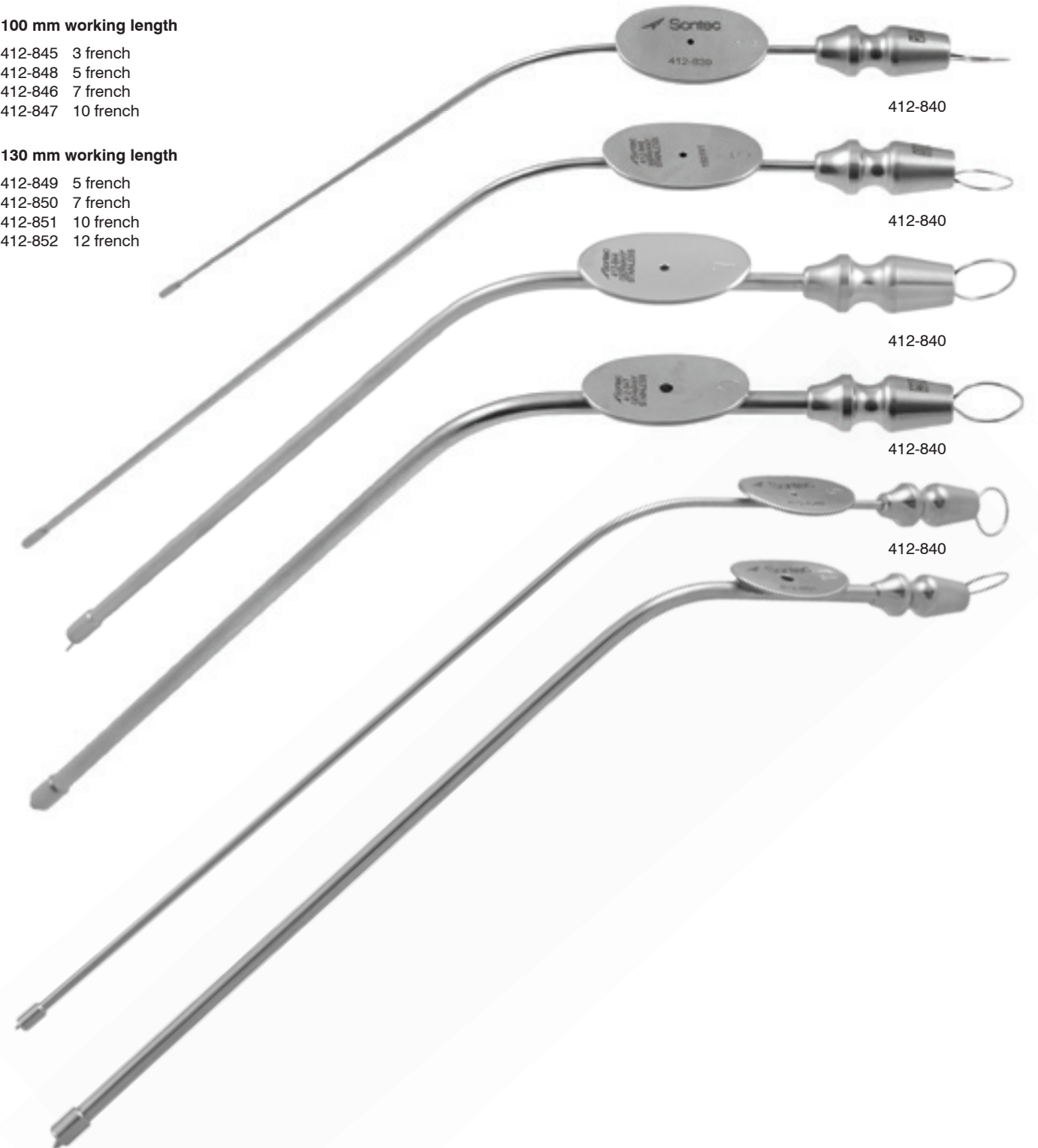

**Fukushima Suction**

Tapered tube shaft / teardrop finger control / 5" (12.7 cm) working length

- 180-404S 4 fr
- 180-405S 5 fr
- 180-406S 6 fr
- 180-407S 7 fr
- 180-408S 8 fr
- 180-409S 9 fr
- 180-410S 10 fr
- 180-411S 11 fr
- 180-412S 12 fr

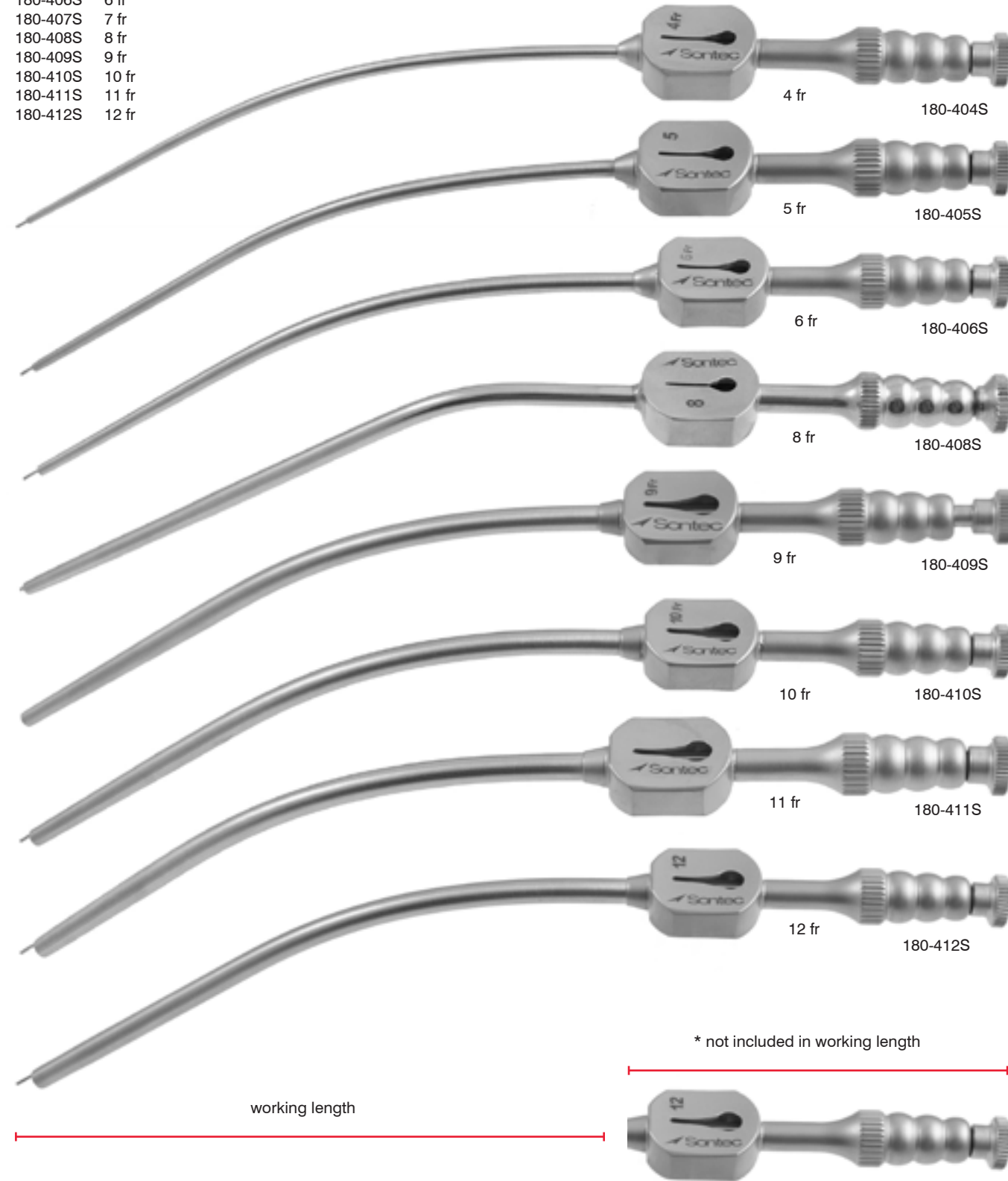

**Fukushima Suction**

Tapered tube shaft / teardrop finger control / 7" (18 cm) working length

- 180-403 3 fr
- 180-404 4 fr
- 180-405 5 fr
- 180-406 6 fr
- 180-407 7 fr
- 180-408 8 fr
- 180-409 9 fr
- 180-410 10 fr
- 180-411 11 fr
- 180-412 12 fr

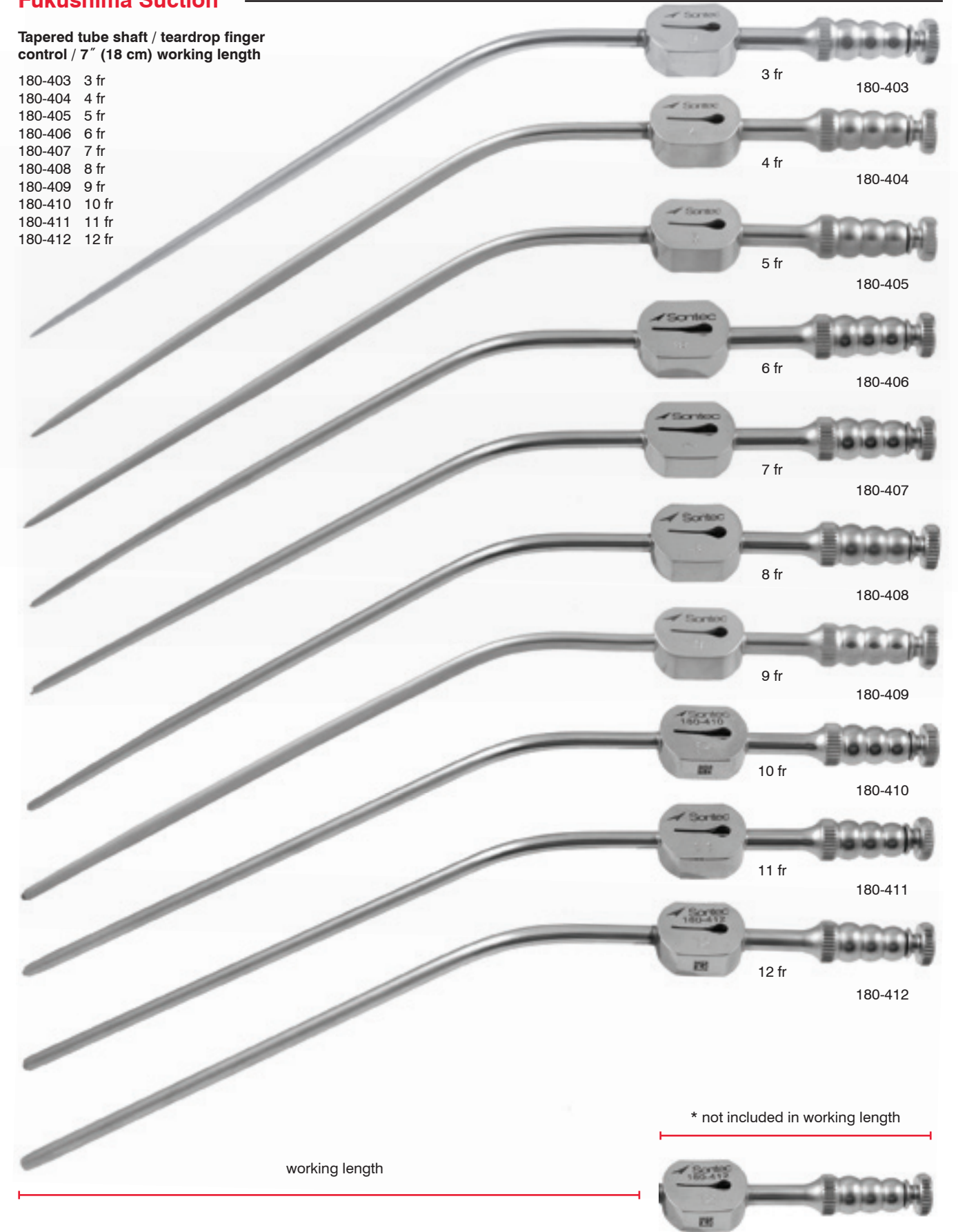

**Sontec Neuro Suction**

tapered tubing for increased flow / short shaft / 3 hole finger control / 2 3/4" (7 cm)

- 412-853 1.2mm tip
- 412-854 2mm tip
- 412-855 2.5mm tip

Medium shaft / 3 hole finger control / 4" (10 cm)

- 412-856 1.2mm tip
- 412-857 2mm tip
- 412-858 2.5mm tip

Long shaft / 3 hole finger control / 5 1/2" (14 cm)

- 412-859 1.2mm tip
- 412-860 2mm tip
- 412-861 2.5mm tip



**Barnes Mini Suction Tube**

- 412-7081 1.5 mm tip
- 412-7082 1.7 mm tip
- 412-7083 2 mm tip
- 412-7084 3 mm tip

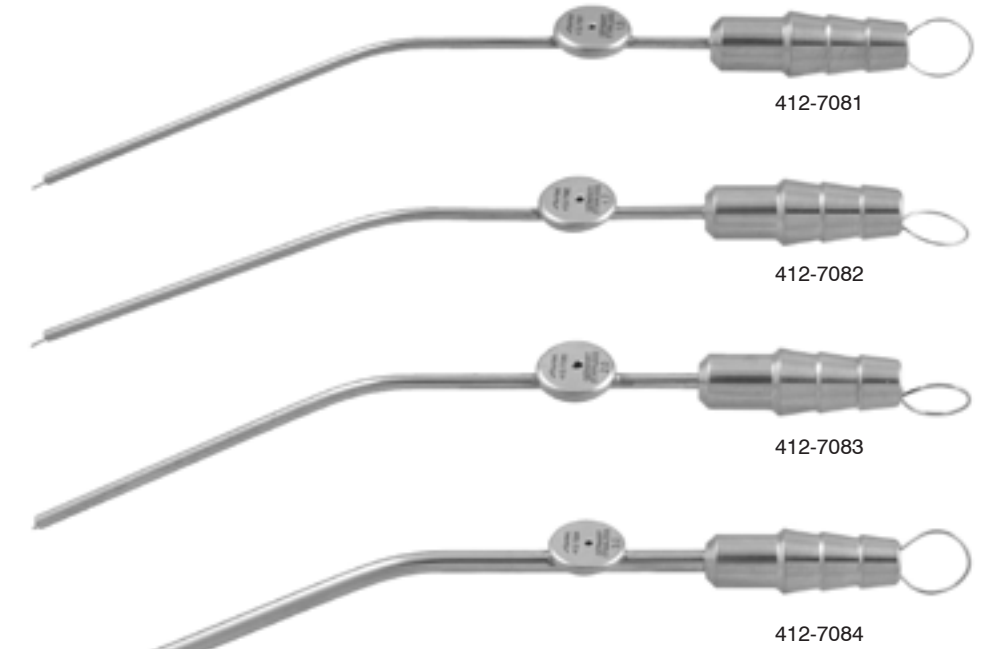

**Baron Suction**

Finger cut-off hole to control suction / angled / 4" (10 cm)

- 412-710 3 french
- 412-712 4 french
- 412-713 5 french
- 412-714 7 french

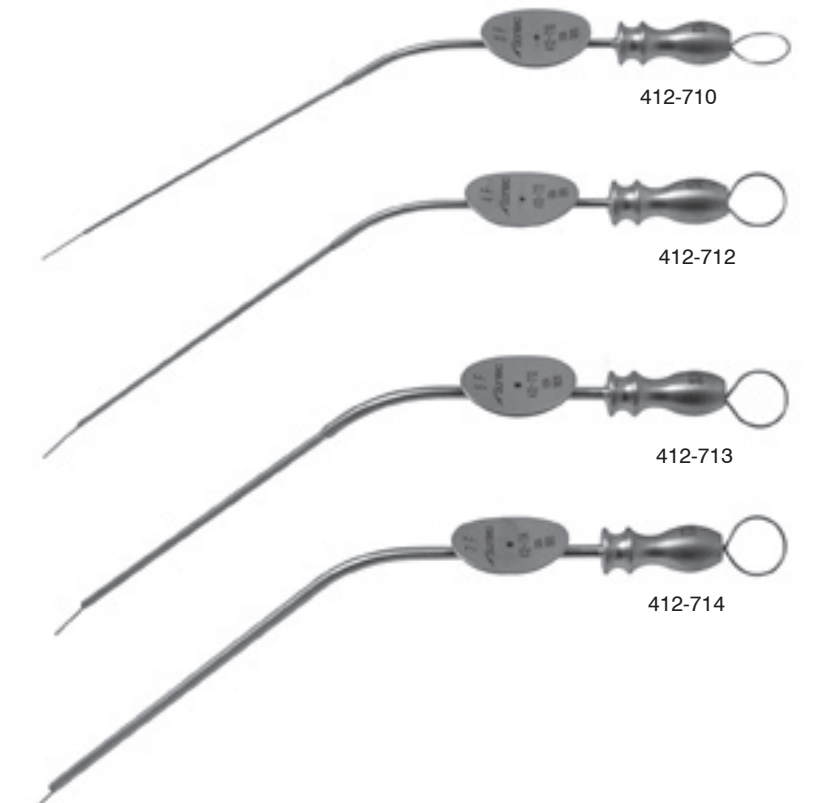

**Pashley-Frazier Suction**

**Curved tip / 7" (18 cm)**

- 1463-501 7 french curved right
- 1463-500 7 french curved left
- 1463-503 8 french curved right
- 1463-504 8 french curved left
- 1463-506 9 french curved right
- 1463-507 9 french curved left

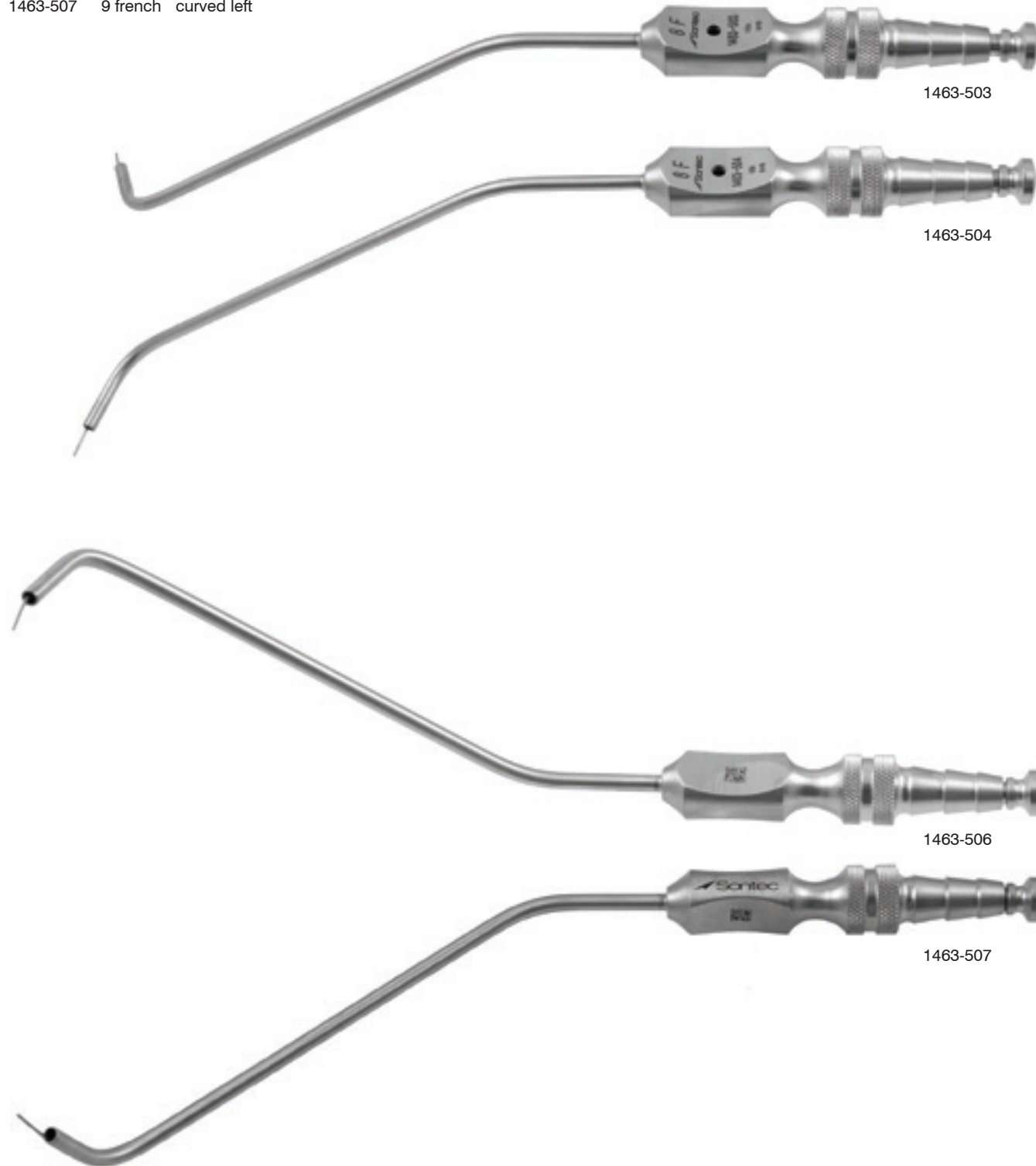

**Modified Ferguson-Frazier Suction**

**Fenestrated oval tip**

- 412-685F 11 french angled
- 412-686H 12 french angled with hook lip



**Bayonet Suction Tube**

**Top finger control / 3 3/8" working length**

- 412-900 5 french
- 412-902 7 french
- 412-904 9 french

**Right finger control / 3 3/8" working length**

- 412-906 5 french
- 412-908 7 french
- 412-910 9 french

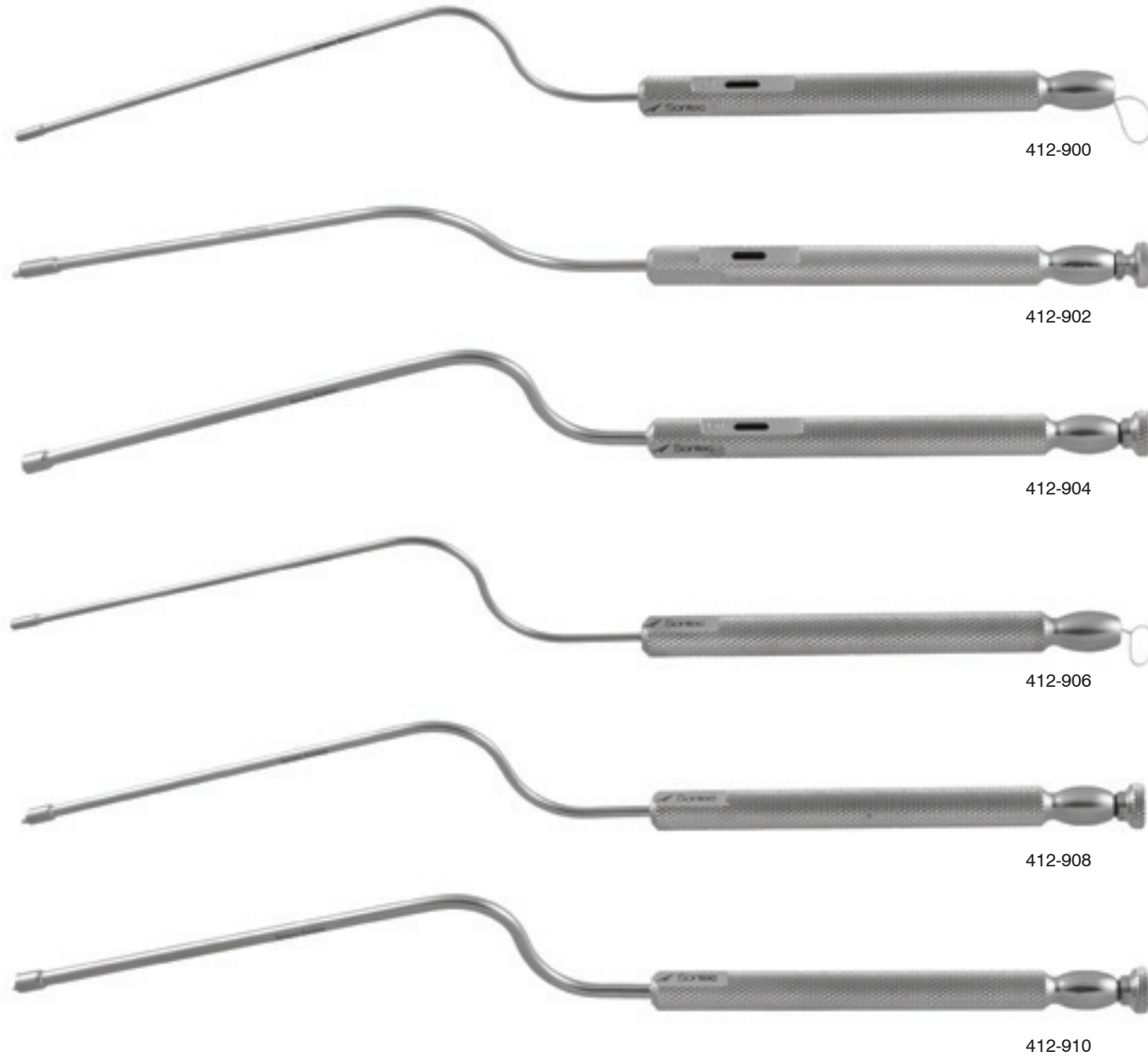

**Suction Nerve Retractor**

**7 french / 8" (20.3 cm)**

- 412-7256 6 mm
- 412-7257 7 mm
- 412-7258 8 mm

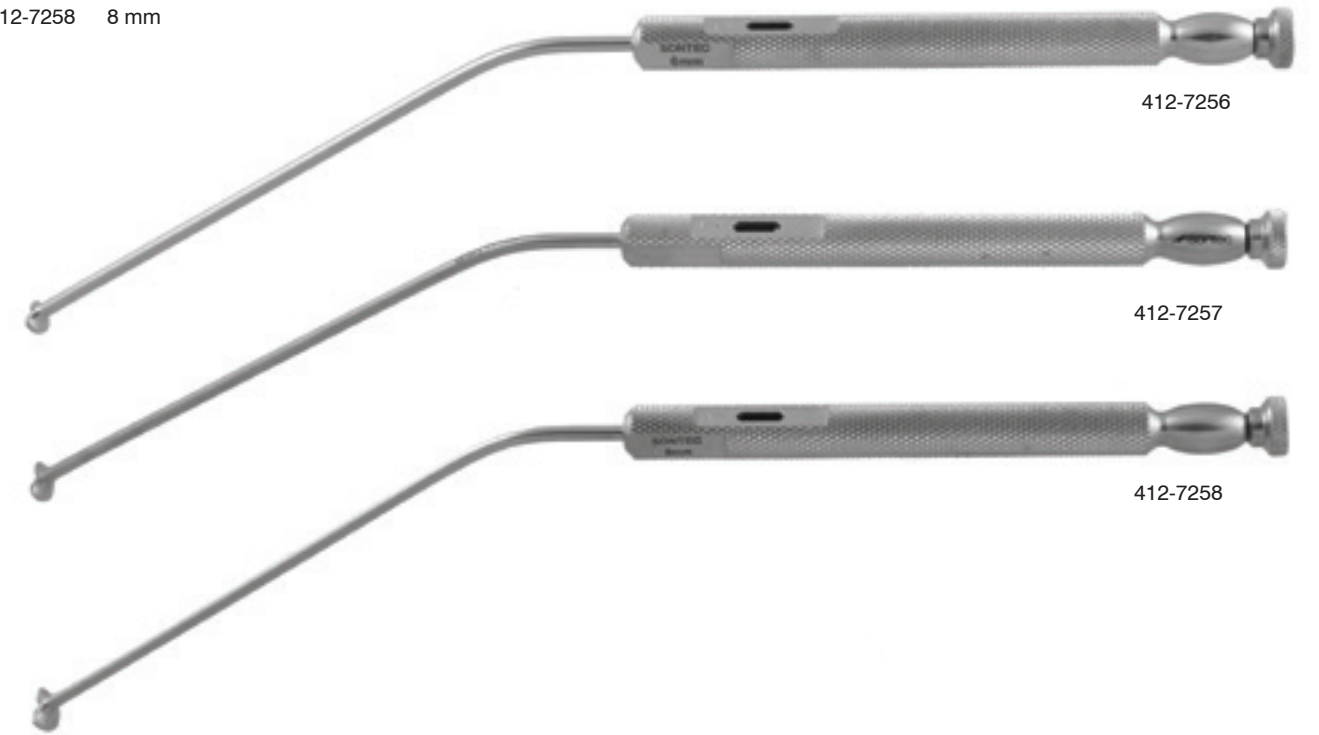

**Papavero Cannula Suction**

**Angled / 7" (18 cm)**

- 412-671 8 french



**Rosen Suction Tips**

Luer LK Angle / overall length 100mm / 65 mm working length

- 412-737-11 11 gauge
- 412-737-13 13 gauge
- 412-737-14 14 gauge
- 412-737-15 15 gauge
- 412-737-16 16 gauge
- 412-737-17 17 gauge
- 412-737-18 18 gauge
- 412-737-19 19 gauge
- 412-737-20 20 gauge
- 412-737-21 21 gauge
- 412-737-22 22 gauge
- 412-737-24 24 gauge
- 412-737-25 25 gauge
- 412-737-26 26 gauge

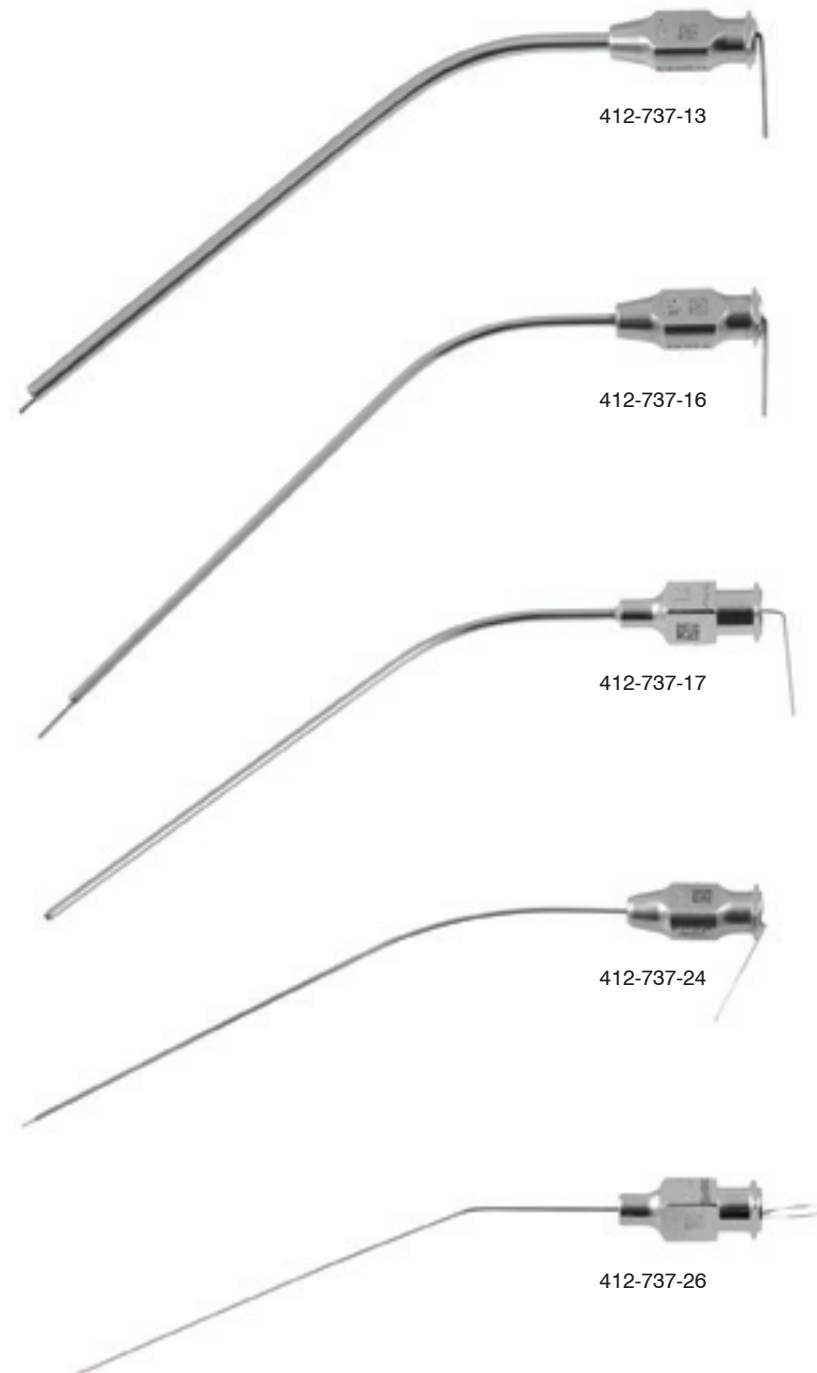

**Wullstein Ear Suction Tube**

7" working length / 9 1/4" overall length

- 412-738-11 11 FR O.D. x 8 FR I.D.
- 412-738-12 12 FR O.D. x 9 FR I.D.
- 412-738-13 13 FR O.D. x 10 FR I.D.

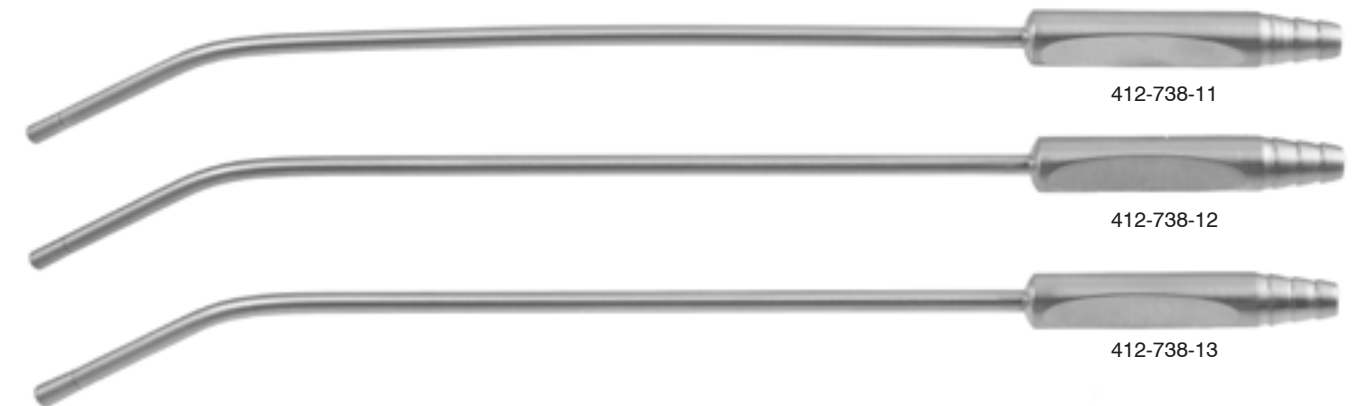

**House Cutoff Suction Adapter**

2" (5 cm)

412-738-50

Universal handles are necessary for Rosen and Schmidt Suction tubes



412-738-50

**Kurtz Cutt-Off Suction Adapter**

2.2" (5.5 cm)

- 412-738-55 chrome plated
- 412-738-55S stainless steel

Universal handles are necessary for Rosen and Schmidt Suction tubes



412-738-55



412-738-55S

**Wullstein Suction Handle**

4 1/4" (11 cm)

412-738 male luer coupling 3mm

Universal handles are necessary for Rosen and Schmidt Suction tubes



412-738

**Schmid Suction Tips**

6" (15 cm)

- 412-736-1
- 412-736-2
- 412-736-3
- 412-736-4

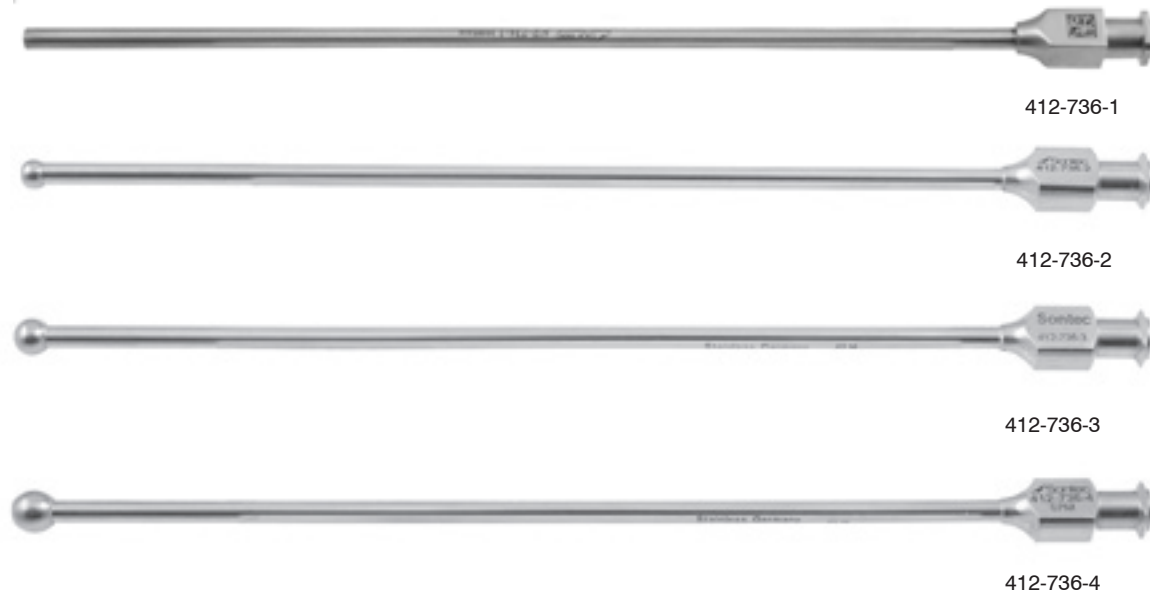

**Suction Irrigation Tube**

5 mm / with stylet / 8" (20 cm)

- 412-830 4 french x 8 french



**House-Baron Suction**

With multi port / 5" (12.5 cm)

- 412-728 5 french
- 412-728B 7 french

7" (18 cm)

- 412-729 5 french
- 412-729B 7 french

11" (28 cm)

- 412-727A 5 french
- 412-727B 7 french



**House Irrigator/Suction**

With thumb plate and cutoff (bypass hole) / 70mm working length / 4 1/2" (11.5 cm)

- 412-715A 2.5 french x 4 french
- 412-715C 4 french x 5 french

85mm working length / 5" (13 cm)

- 412-715 2 french x 2.5 french

95mm working length / 5 1/2" (14cm)

- 412-715B 2.5 french x 4 french
- 412-7151B 3 french x 4 french
- 412-715D 4 french x 5 french
- 412-716 5 french x 7 french
- 412-716A 6 french x 8 french
- 412-717 7 french x 10 french
- 412-718 8 french x 12 french
- 412-719 12 french x 14 french

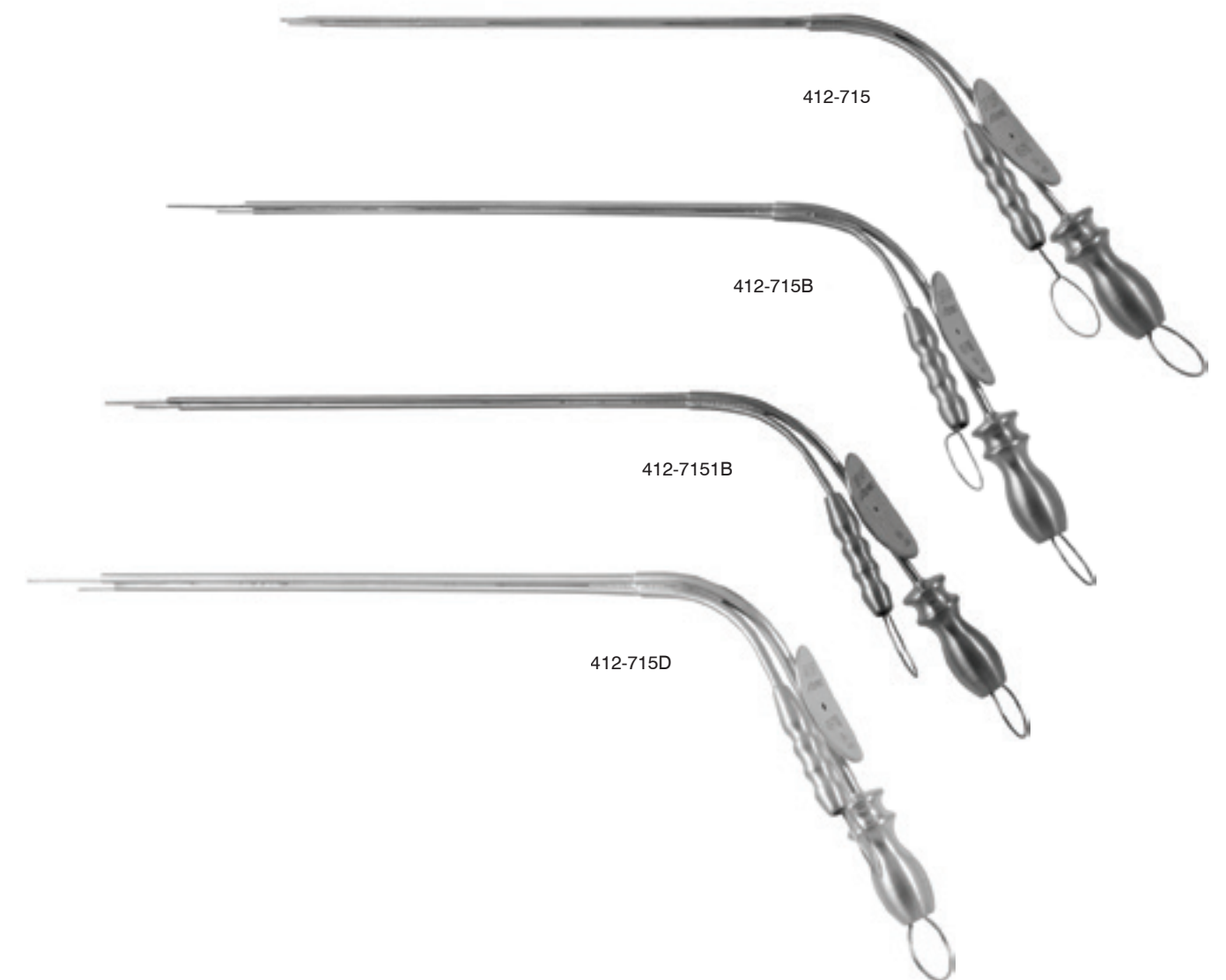

**Sontec Micro Pediatric Suction**

**For pediatric Use**

2700-300	40°	3.25 mm	long fluted tip	4 1/4"
2700-301	45°	3.25 mm	fluted tip	4 3/4"
2700-302	40°	5 mm	fluted tip	4 3/4"
2700-304	55°	7 mm	fluted tip	4 3/4"
2700-306	50°	3.25 mm	fluted tip	4 1/4"

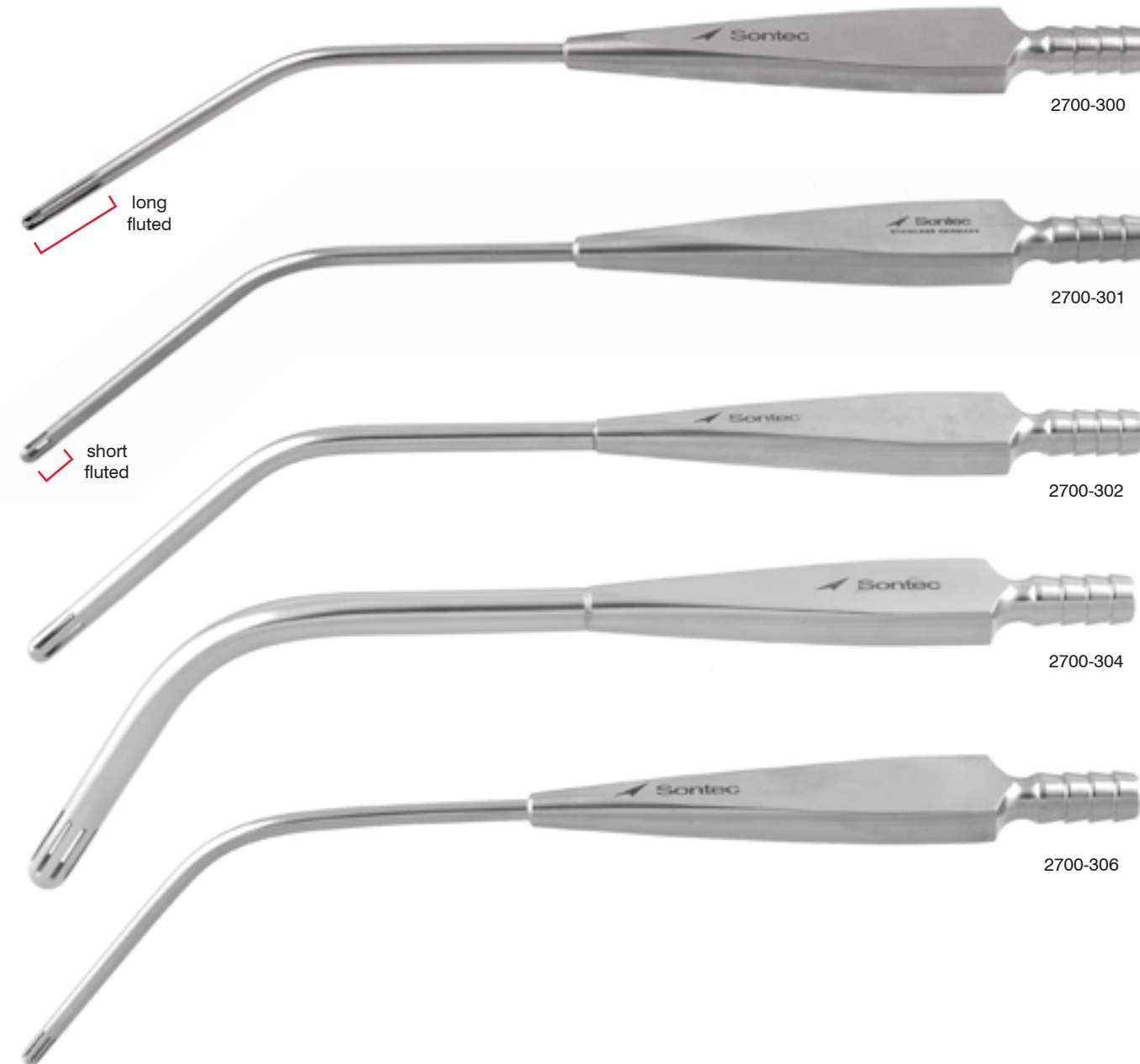

**Sontec Micro Pediatric Suction**

**For pediatric use / removable fluted tip**

2700-301R	45°	3.25 mm tip	4 3/4"
2700-303R	45°	3.25 mm tip	3 1/4"



**Sontec Micro Pediatric Suction**

For pediatric use / removable fenestrated tip

- 2700-307R 45° 5 mm tip 3 3/4"
- 2700-308 55° 3.5 mm tip 3 3/4"
- 2700-308R 45° 3.5 mm tip 3 1/2"



2700-307R



2700-308R



2700-308

**Andrews Pynchon Suction**

Stainless / 9 1/2" (24 cm)

- 180-432 3.0 mm
- 180-433 4.2 mm
- 180-436 5.0 mm standard

Chrome handle / standard 5 mm / 9 1/2" (24 cm)

180-439



180-432

**Anthony Suction**

4 mm tip / 10" (25.5 cm)

180-440



180-440

**Braun-Ralph Suction**

5mm suction tube / 70° angle with 7 mm Ø 40 mm long fluted tip / 10" (25.5 cm)

2700-309



2700-309

**Yankauer Suction**

Stainless Steel / 11 3/4" (30 cm)

180-448



With universal fiber optic light guide / stainless steel / 11 1/4" (28.5 cm)

180-449 2mm



Stainless steel / 16" (41 cm)

180-451 2mm



**Heartline Ross Sump Sucker**

Swivel head

- 2700-390 adult 4.8mm x 7.5mm O.D. x 43mm length
- 2700-392 child 4.8mm x 6.5mm O.D. x 32.5mm length
- 2700-394 infant 3.2mm x 5mm O.D. x 22.5mm length



**Heartline Ross Ventricular Vent**

Swivel head

- 2700-395 adult 4.8mm x 7.5mm O.D. x 51mm length
- 2700-396 child 4.8mm x 6mm O.D. x 37.5mm length
- 2700-397 infant 3.2mm x 5mm O.D. x 24mm length



**Poole Suction**

8 3/4" (22 cm)

- 180-424 cvd 23 french
- 180-422 str 30 french



**Baby Poole Suction**

Curved / 17 french / 8" (20.3 cm)  
180-420



180-420

**Poole Suction Deluxe**

With cut off valve / 30 french / 10 1/4" (26.04 cm)  
180-427



180-427

**Buie Suction Tube**

With finger valve / 16" (40.5 cm)  
508-523 15 french



508-523

**Adson Suction**

Curved tip  
412-720 12 french 5" (12.5 cm)  
412-724 12 french 8" (20 cm)



412-720

**Killian (Von Eicken) Suction**

Curved / 6" (15 cm)  
412-815 4 mm end short curve  
412-810 4 mm end full long curve  
412-805 3 mm end short curve  
412-800 3 mm end long curve



412-805



412-800



412-815



412-810

**Sontec Perfusion Cannula Suction**

For pediatric Use

- 412-740 style #1
- 412-741 style #2

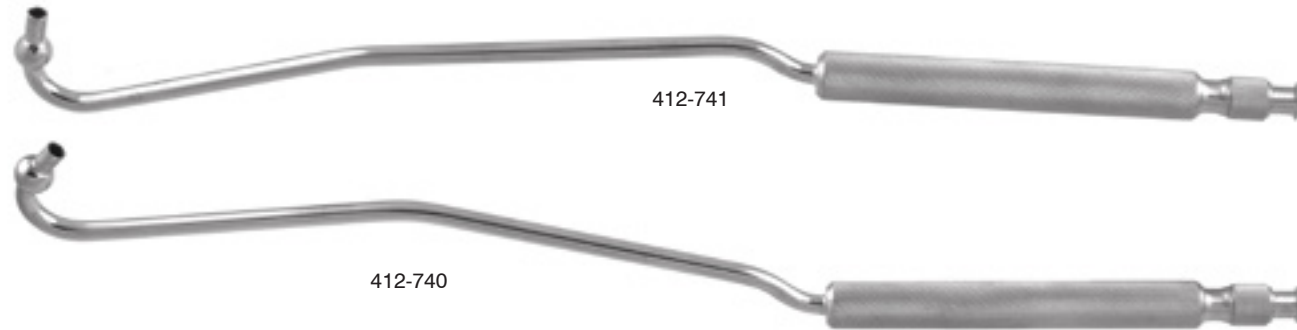

**Coupland Suction Set**

6 1/2" (16.5 cm)

412-672-SET  
set includes:

- 412-673 tip #1 1.5 mm wide
- 412-674 tip #2 2.0 mm wide
- 412-675 tip #3 2.5 mm wide
- 412-676 tip #4 3.5 mm wide
- 412-672H handle



handle only

412-672H

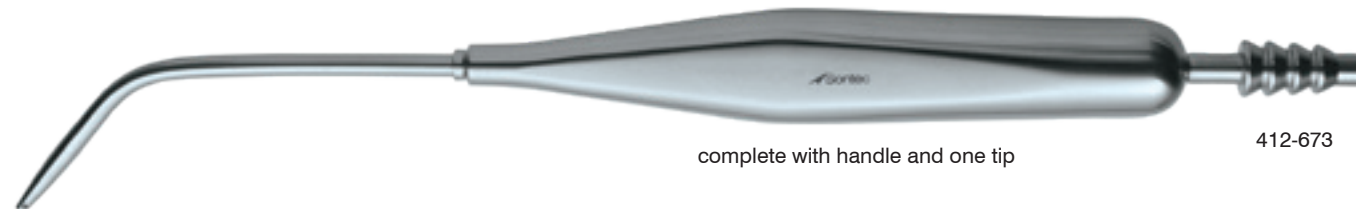

complete with handle and one tip

412-673



412-676



412-675



412-674



412-673

**Pashley Pipe Suction Tube Holding Device**

1463-461



1463-461



 Sontec Instruments®

Orthopedic BONE HOLDING CLAMPS

**Verbrugge Bone Clamp**

**Curved to side / with speedlock**

- 1103-070 6" (15.5 cm)
- 1103-074 7 1/2" (19 cm)
- 1103-075 8 1/4" (21 cm)
- 1103-075D 8 1/4" (21 cm) delicate
- 1103-076 9 1/2" (24 cm)
- 1103-080 10" (25.5 cm)

**Swivel jaw / curved to side/with speedlock**

- 1103-071 5 3/4" (15 cm)
- 1103-073 8" (20.5 cm)
- 1103-077 9" (23 cm)
- 1103-078 10 1/4" (26 cm)
- 1103-079 11 1/4" (29 cm)



1103-076



1103-071

**Verbrugge Bone Clamp**

**Ring handle / with ratchet**

- 1103-068 7" (18 cm)



1103-068

**Verbrugge Bone Clamp**

Reverse jaw / curved to side / with speedlock

1103-071J	5 3/4" (15 cm)
1103-073J	8" (20.5 cm)
1103-077J	9" (23 cm)
1103-078J	10 1/4" (26 cm)
1103-079J	11 1/4" (29 cm)

Reverse speed lock and jaw / curved to side

1103-071L	5 3/4" (15 cm)
1103-073L	8" (20.5 cm)
1103-077L	9" (23 cm)
1103-078L	10 1/4" (26 cm)
1103-079L	11 1/4" (29 cm)



1103-071J



1103-071L

**Ulrich Bone Clamp**

With speedlock / straight

305-367S*	7 1/8" (18.25 cm)
305-368	9" (23 cm)
305-369	10 1/2" (27 cm)

Curved to side

305-365	5 1/4" (13.5 cm)
305-365M*	5 1/2" (14 cm)
305-366	6 1/2" (16.5 cm)
305-367*	7 1/8" (18.25 cm)
305-368A	9" (23 cm)
305-369A	10 1/2" (27 cm)

\* micro jaws



305-365M



305-367



305-367S

**Verbrugge-Rogalski Bone Clamp**

With speedlock / 1.5 mm jaw / 4" (10 cm)

1103-069



1103-069

**Kern Hybrid Bone Clamp**

With speedlock / fenestrated head / 4 3/4" (12 cm)

305-344A



305-344A

**Kern Bone Clamp**

Fenestrated jaw / with ratchet

- 305-332 4 3/4" (12 cm)
- 305-334 5 1/2" (14 cm)
- 305-328 6 1/4" (15.9 cm)
- 305-338 7" (18 cm)
- 305-336 8 1/2" (21.5 cm)



Fenestrated jaw  
Side view

With ratchet

- 305-347 13" (33 cm)



305-332



305-347

**Stefan Mini Bone Holding Forceps**

Curved / 4 mm opening / mini

- 1103-003 4" (10 cm) with speedlock
- 1103-004 4" (10 cm) with ratchet
- 1103-005 5 1/2" (14 cm) with ratchet

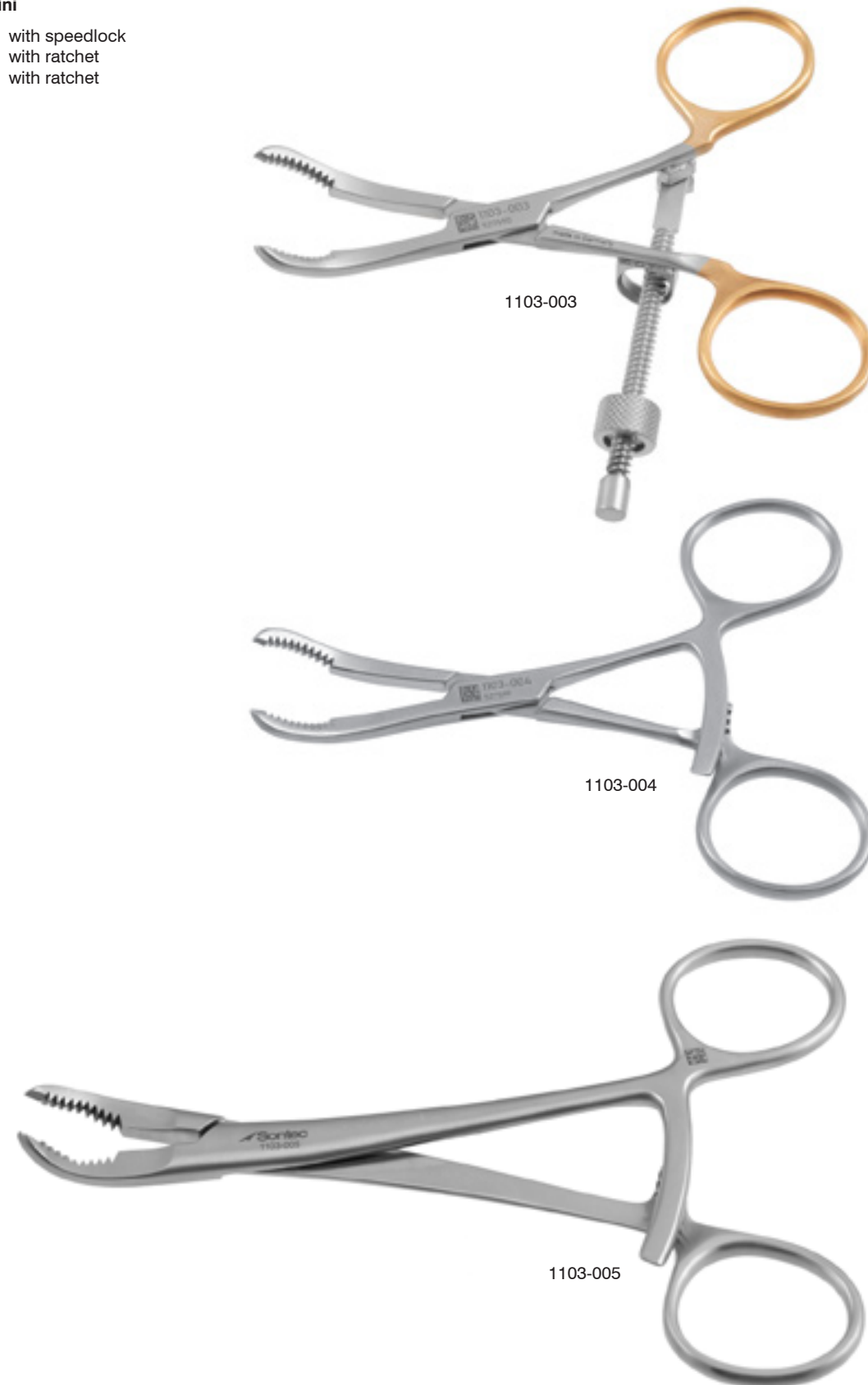

**Stefan Bone Holding Forceps**

Curved / with speed lock

- 1103-006 5 1/2" (14 cm)
- 1103-008 6" (15.5 cm)
- 1103-010 7" (18 cm)
- 1103-011 9 1/2" (24 cm)



**Sequestrum Sontec Bone Forceps**

Serrated jaws / 8" (20.3 cm)

- 1103-013 straight
- 1103-014 curved



**Angus Bone Holding Forceps**

6" (15.5 cm)

- 1103-015 with ratchet
- 1103-017 with speedlock



**Taylor-Dingmann Bone Clamp**

angled / 7 1/2" (19 cm)

- 1100-451 with speedlock
- 1100-452 with ratchet



**Babcock Bone Holding Clamp**

Angled / with ratchet / 7 3/4" (19.7 cm)  
1103-065



**Mini Doolen Bone Holding Clamp**

1.5 mm wide jaw / angled / 5" (12.7 cm)  
1103-843 with speedlock  
1103-844 with ratchet

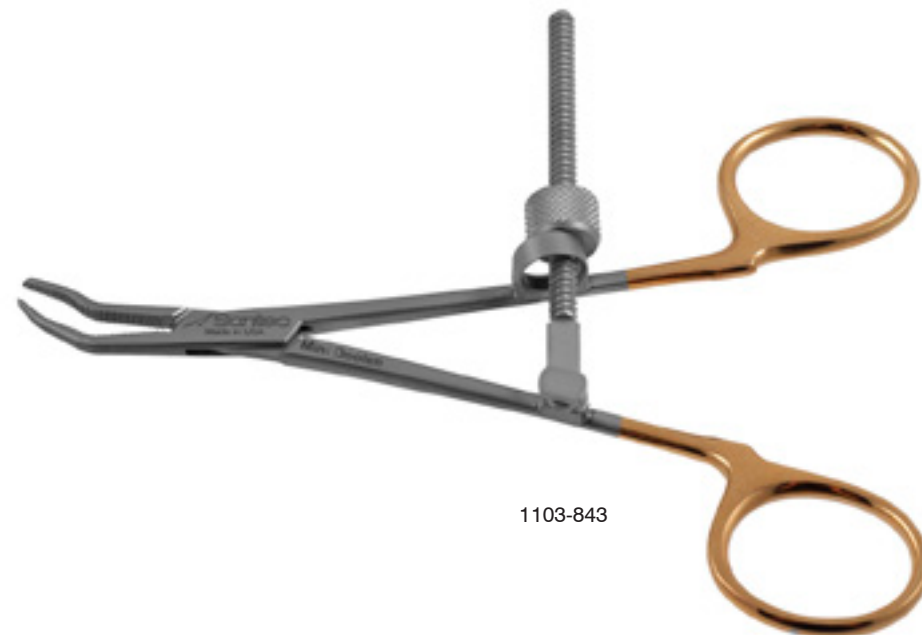

**Sesamoidectomy Bone Clamp**

Strong curve / 6 1/2" (16.5 cm) / with ratchet  
1103-050

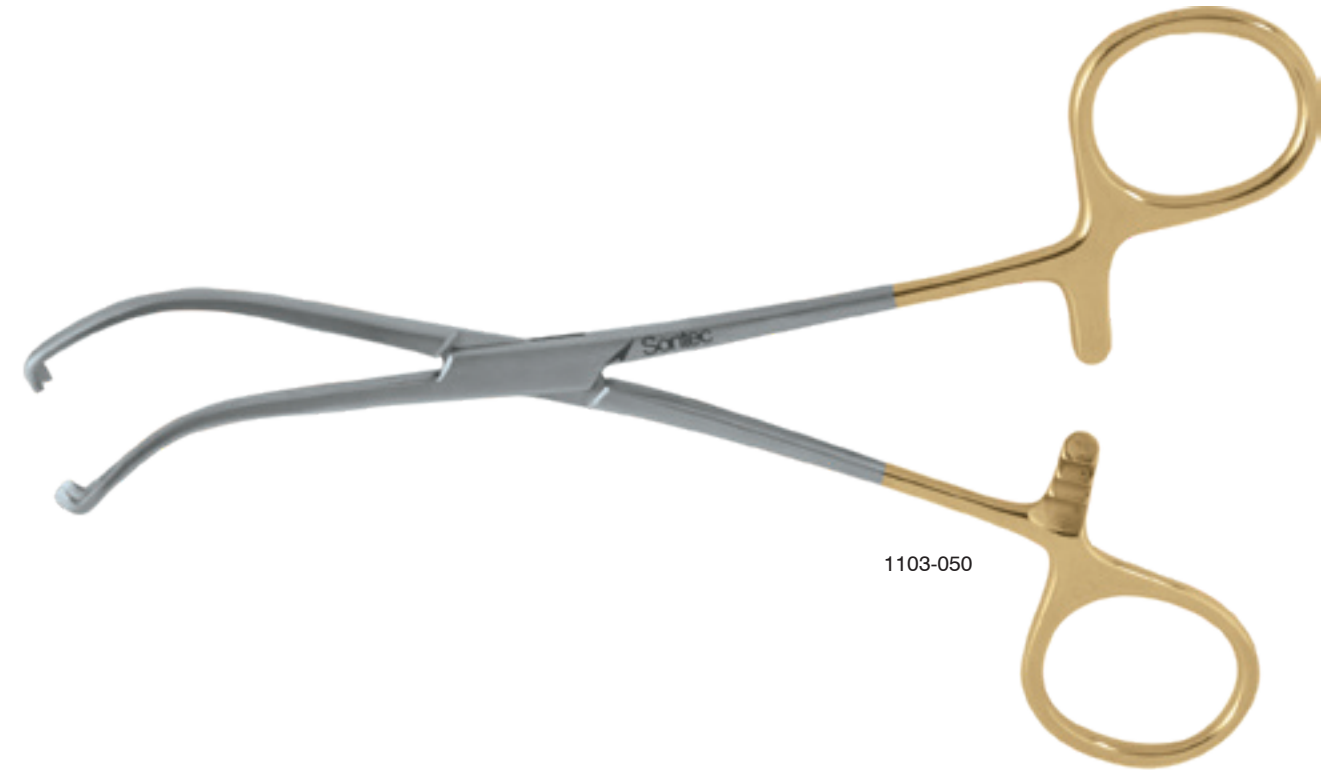

**Doolen Bone Holding Clamp**

2mm wide jaw / 5.5" (14cm)

- 1103-845 str w/ speedlock
- 1103-846 ang w/ speedlock
- 1103-846R ang w/ ratchet

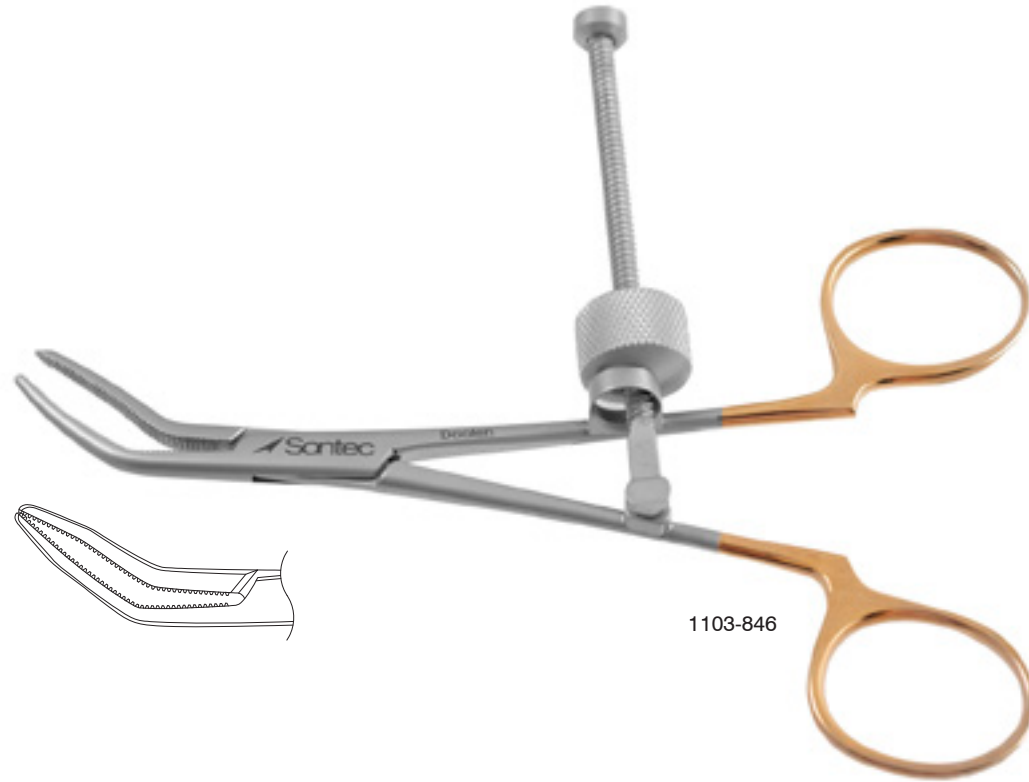

**Doolen Bone Holding Clamp**

3mm wide jaw / angle jaw / 7" (18 cm)

- 1103-856 with speedlock
- 1103-856R with ratchet

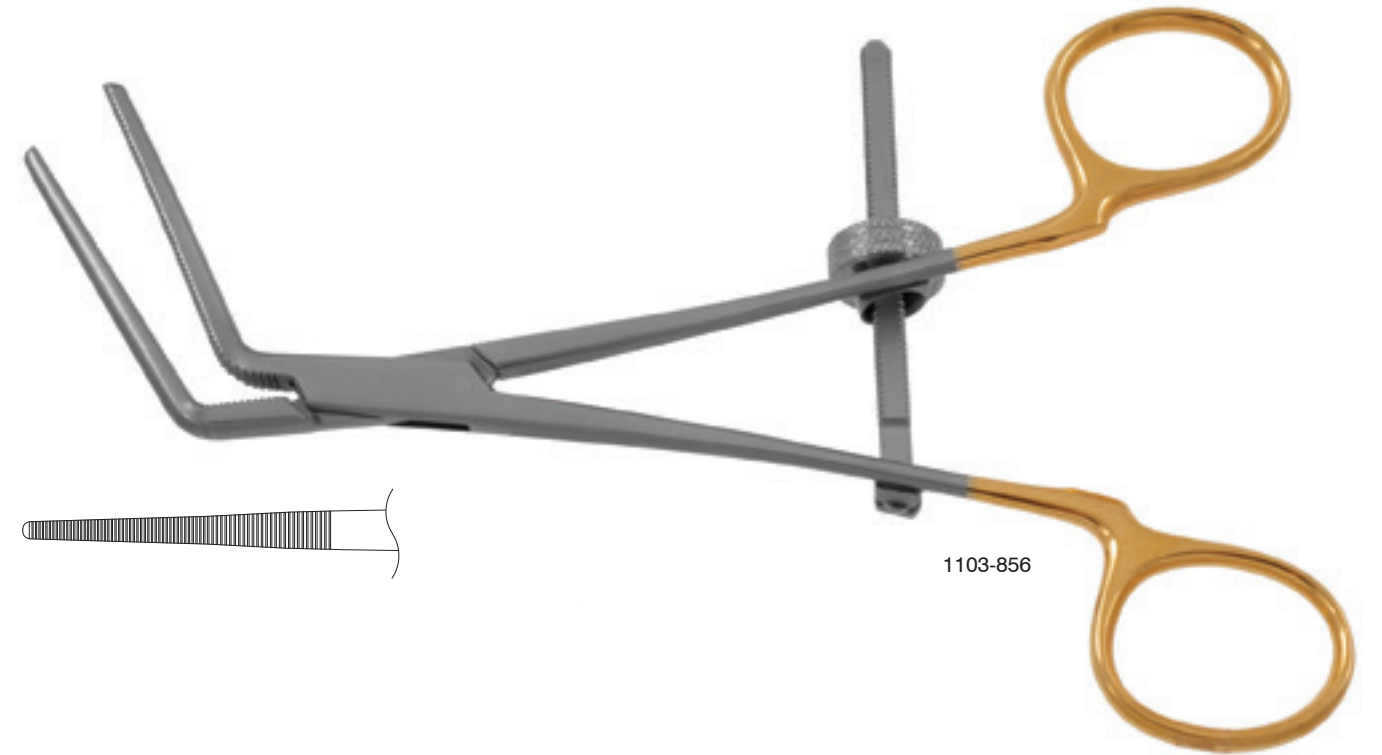

**KUV Richards Bone Clamp**

With ratchet / 9" (23 cm)

- 1103-067



**Bishop Bone Clamp**

With ratchet / 12 1/2" (31.8 cm)

305-380



305-380

**Patella 2 x 2 Prong Bone Clamp**

With speed lock / 7 1/4" (18.5 cm)

1103-215



1103-215

**Lowman Bone Holding Clamp**

1 x 1 prongs

- 305-475 4 3/4" (12 cm)
- 305-480 7 1/4" (18.5 cm)
- 305-485 8" (20.5 cm)

1 x 2 prongs

- 305-460 4 3/4" (12 cm)
- 305-465 7 1/4" (18.5 cm)
- 305-470 8" (20.5 cm)



305-460

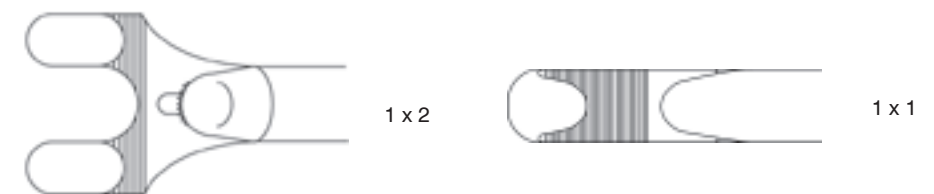

1 x 2

1 x 1

**Lowman Bone Clamp**

2 x 2 prongs on bone clamp

- 305-490 7 1/4" (18.5 cm)
- 305-495 8" (20 cm)



305-490

**Lambert-Lowman Bone Holding Clamp**

2 x 2 prongs / swivel jaw

305-496 7 1/4" (18.5 cm)

305-497 8" (20.5 cm)



**Gersten Traction Bar**

For Lowman Bone Clamps

305-505



**Ulrich Swivel Jaw Bone Clamp**

With speed lock / 10 1/2" (27 cm)

305-370 straight

305-370A angled

305-370B curved to side 1 x 2 prong





 Sontec Instruments®

Orthopedic BONE REDUCTION CLAMPS

**Bone Reduction Clamp Extra Large**

Oversized / extra-long ratchet / 12" (30 cm)

- 1103-049 extra-long prongs
- 1103-049L extra-long shanks



1103-049



1103-049L

**AO-Type Bone Reduction Clamp**

With speedlock / short tips

- 1103-051 8" (21 cm)

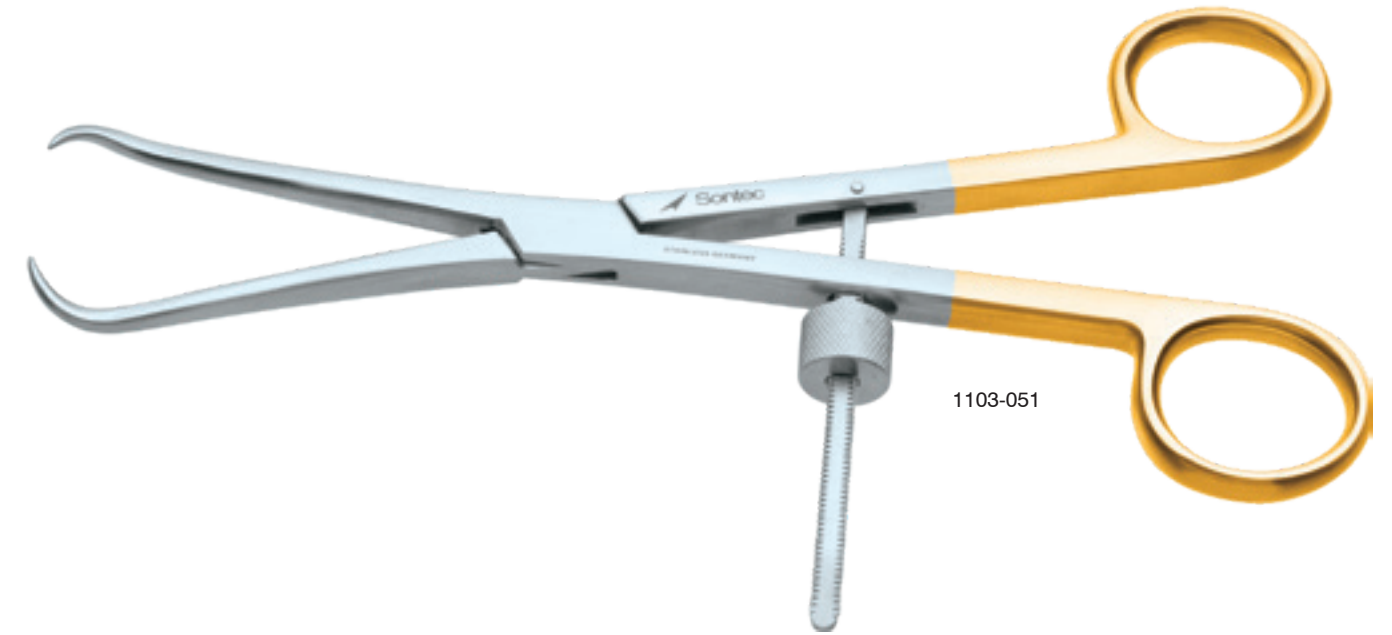

1103-051

**Kistler Manus Bone Reduction Clamp**

6 1/8" (15 cm)

- 1103-033



1103-033

**Reil Bone Holding Forceps**

Angled / 6 3/4" (17.1 cm)

1103-020

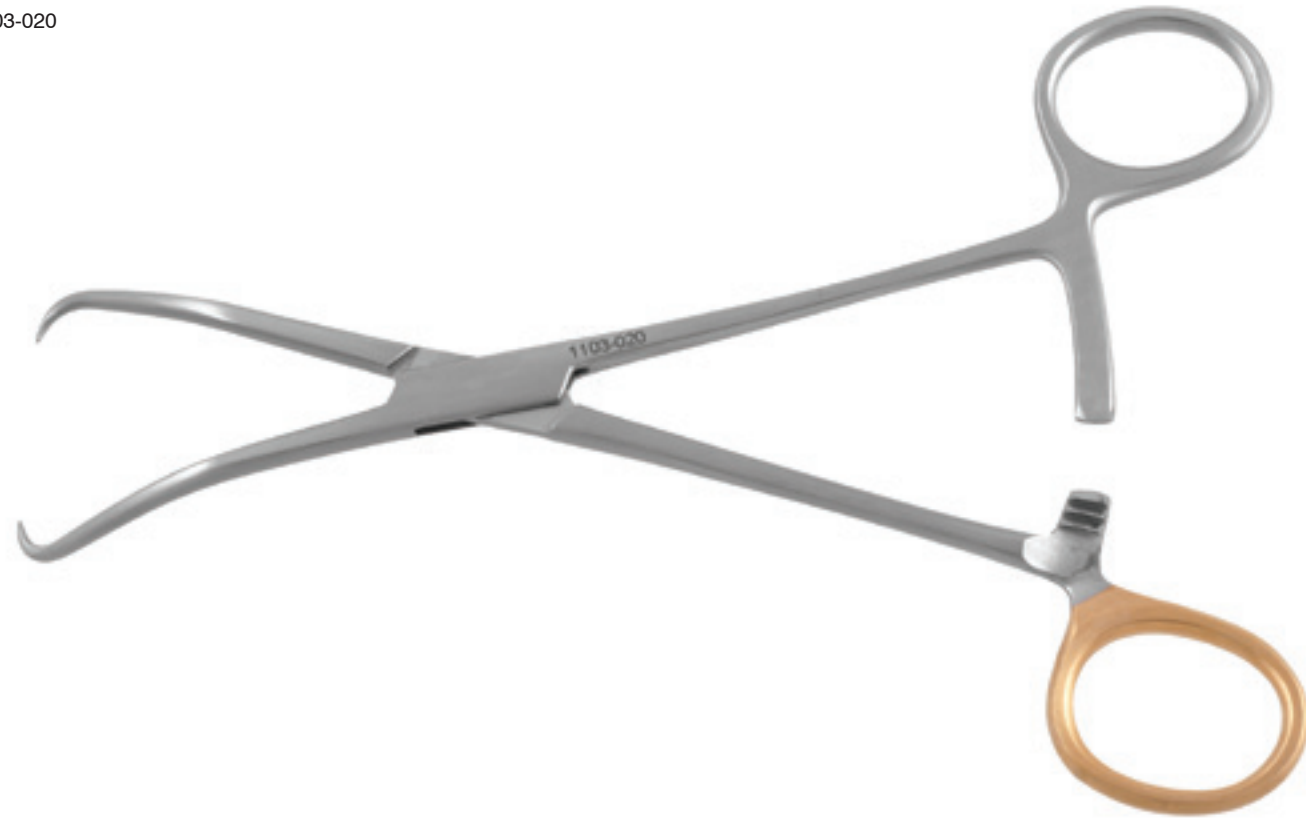

**Bone Reduction Clamp**

With speedlock

1103-039S 7" (17.8 cm)  
1103-048 8" (20 cm)

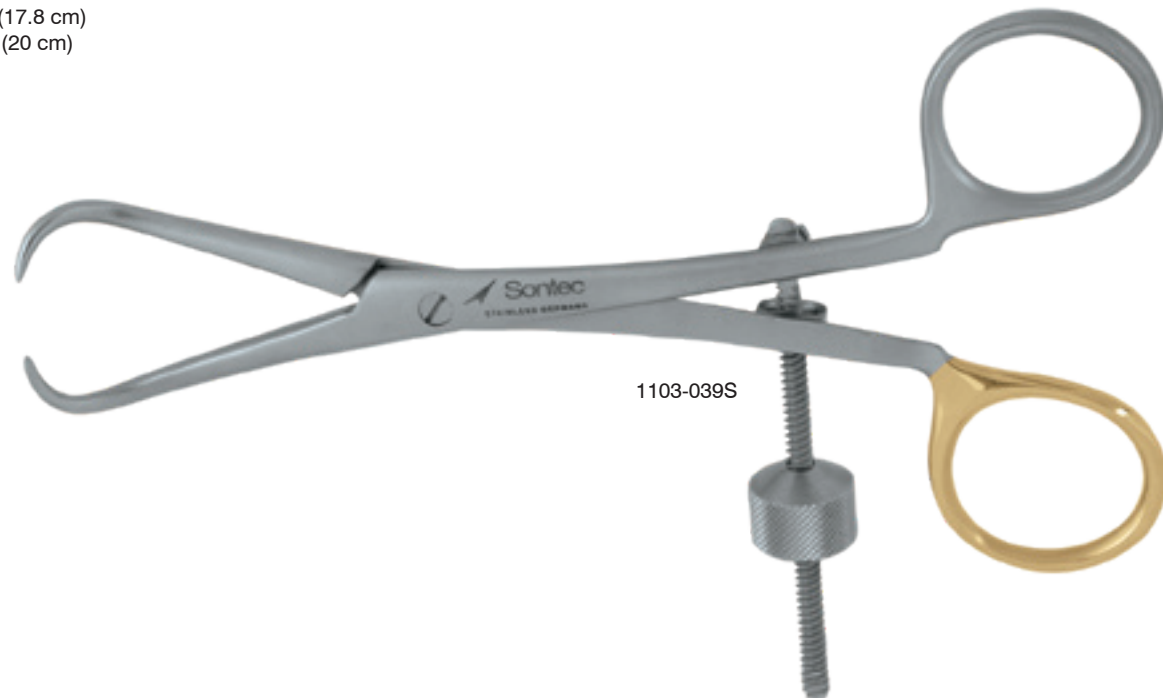

**Bone Reduction Clamp**

With ratchet

1103-039L\* 6" (15 cm) long double ratchet  
1103-039N\* 7" (17.8 cm) long double ratchet  
1103-045 8" (20 cm) extra long ratchet

\* Other sizes available

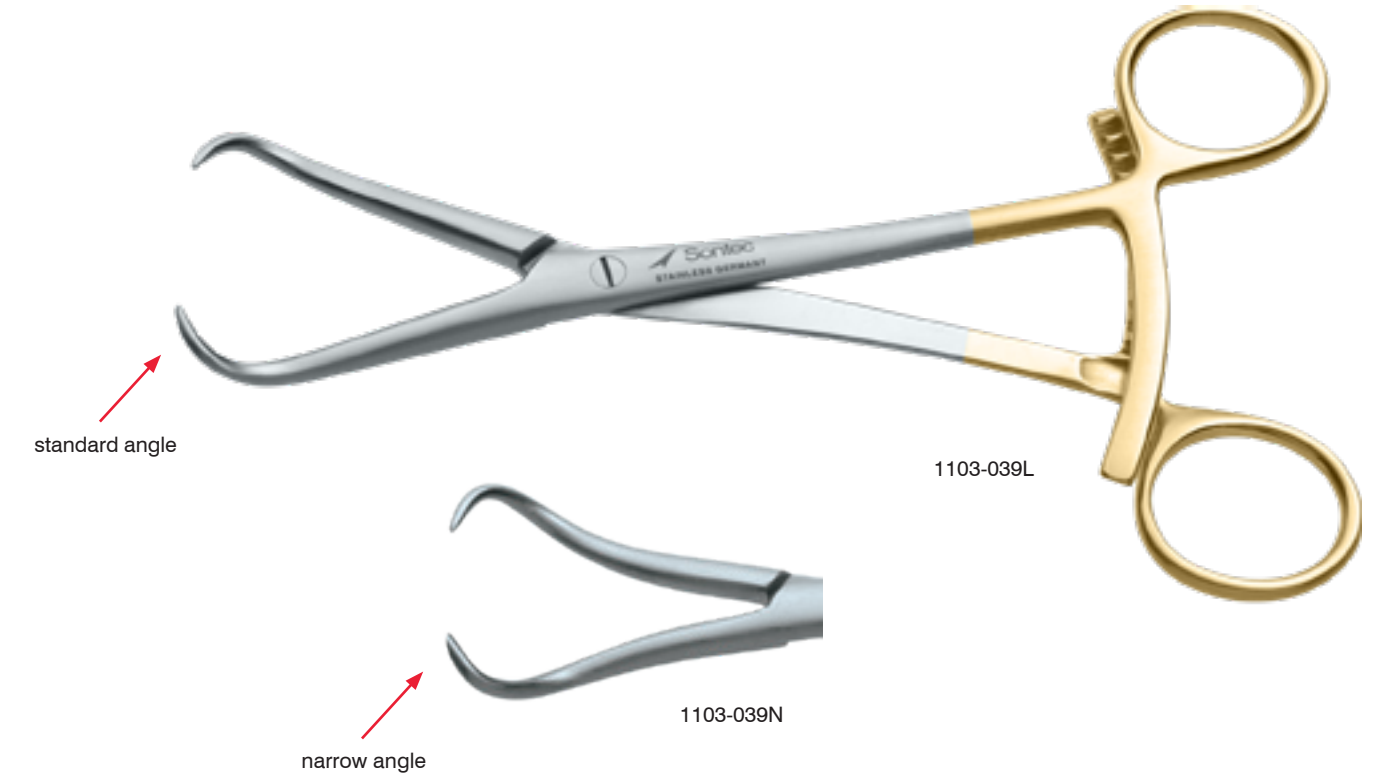

standard angle

1103-039L

narrow angle

1103-039N



1103-045

**Kristler Manus Bone Reduction Clamp**

With speed lock / serrated jaw / 6 1/8"

1103-0331



1103-0331

**Bone Reduction K-Wire Guide Clamp**

With double long ratchet / with 1.8 mm ID guide cylinder with serrated foot

- 1103-0391 with 10 mm k-wire guide 6" (15 cm)
- 1103-0453 with 12 mm k-wire guide 8" (20 cm)
- 1103-0454 with 15 mm k-wire guide 8" (20 cm)



1103-0453

**Raleigh Bone Reduction Clamp**

7 mm / 5 1/2" (14 cm)

- 1103-024 with ratchet
- 1103-023 with speed lock



1103-024

**Locke Bone Reduction Clamp**

With long ratchet / 4 mm / 6" (15.2 cm)

1103-027



1103-027

**Locke CSU Bone Reduction Clamp**

1x2 teeth tips with contoured serrated jaws / 6" (15 cm)

- 1103-021 straight with ratchet
- 1103-021A curved with ratchet
- 1103-023A curved with speedlock
- 1103-023B straight with speedlock

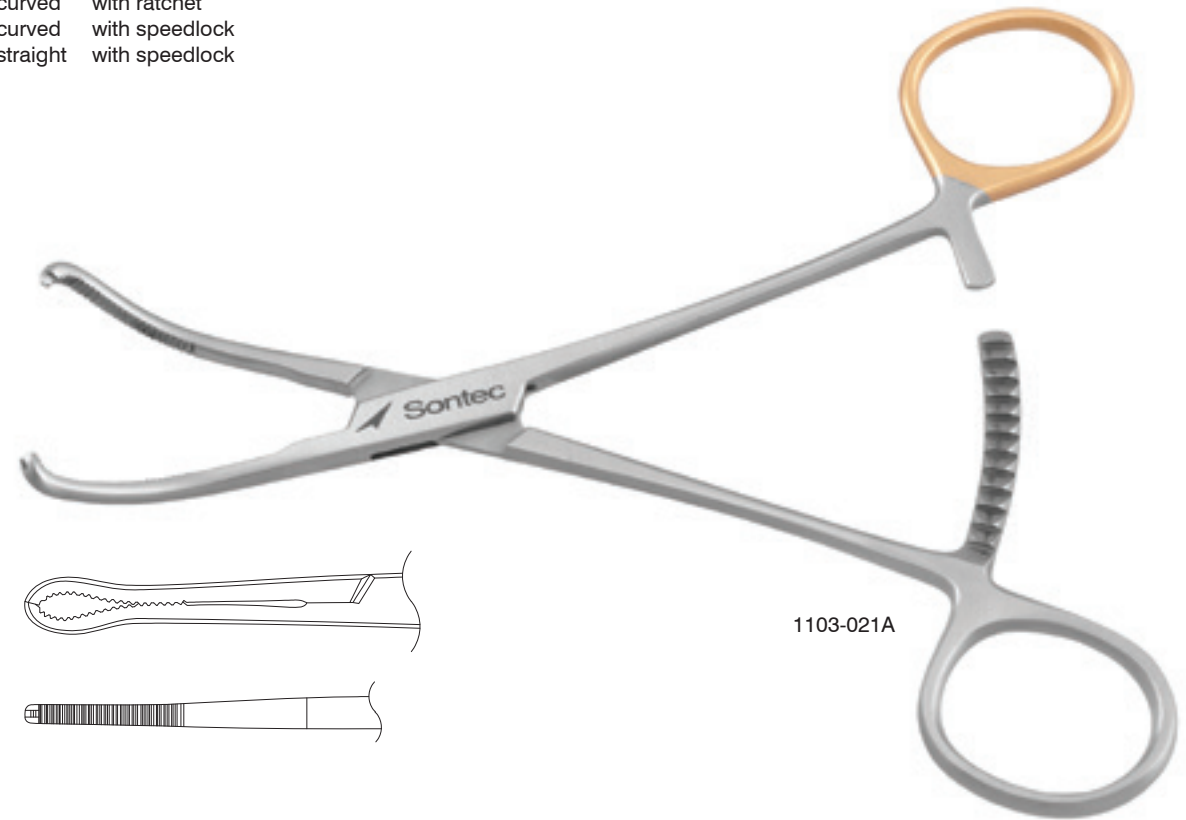

1103-021A

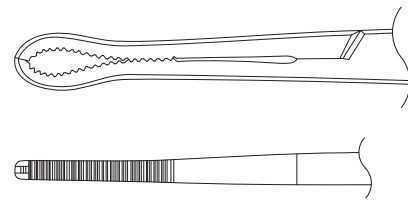

1103-023A

**Raleigh Bone Holding Forceps**

- 1103-040A 3 mm 5 1/2" with ratchet
- 1103-040B 5 mm 5 1/2" with ratchet
- 1103-040C 12 mm 7" with speedlock
- 1103-040AS 3 mm 5 1/2" with speedlock
- 1103-040BS 5 mm 5 1/2" with speedlock



1103-040A



1103-040B



1103-040C

**Lewin Bone Reduction Clamp**

**Serrated**

1100-426 7" (18 cm)  
1100-426M 7 1/2" (19 cm) modified serrations

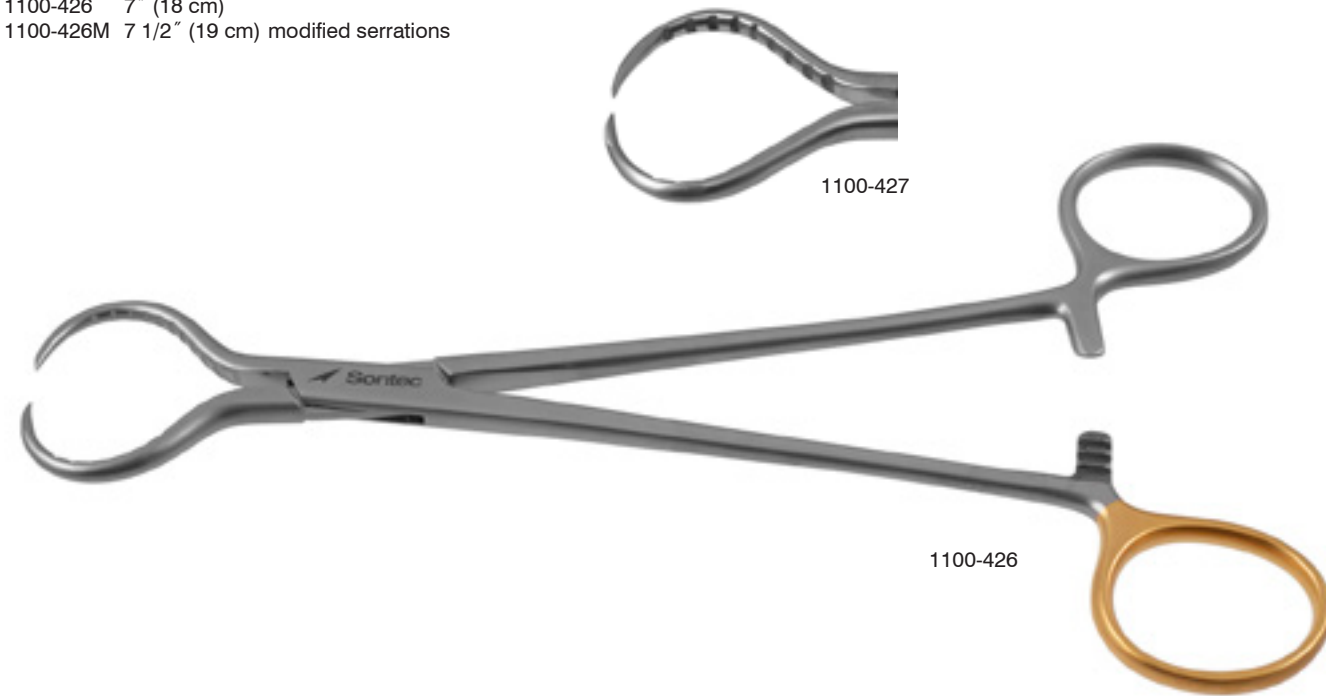

**Bone Reduction Clamp**

**With K-wire guide / 5 1/4" (13.5 cm)**

1103-044 with ratchet  
1103-044S with speed lock

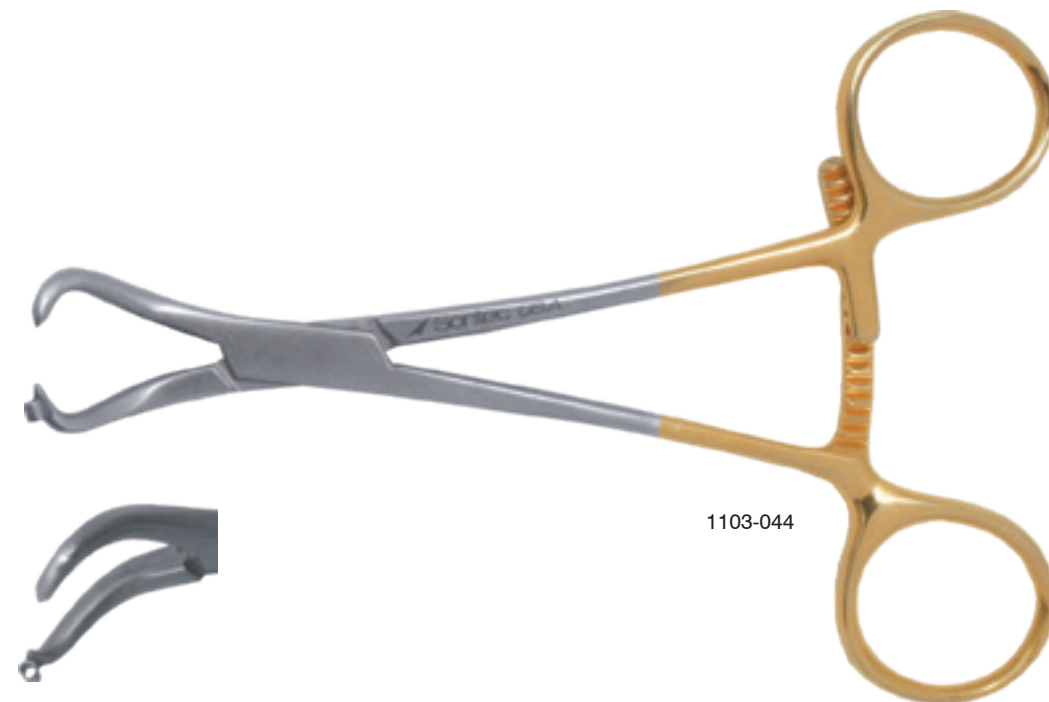

**Bone Holding Forceps**

**With 0.9 mm K-wire guide / curved / 6 3/4" (17.1 cm)**

1103-088 with ratchet

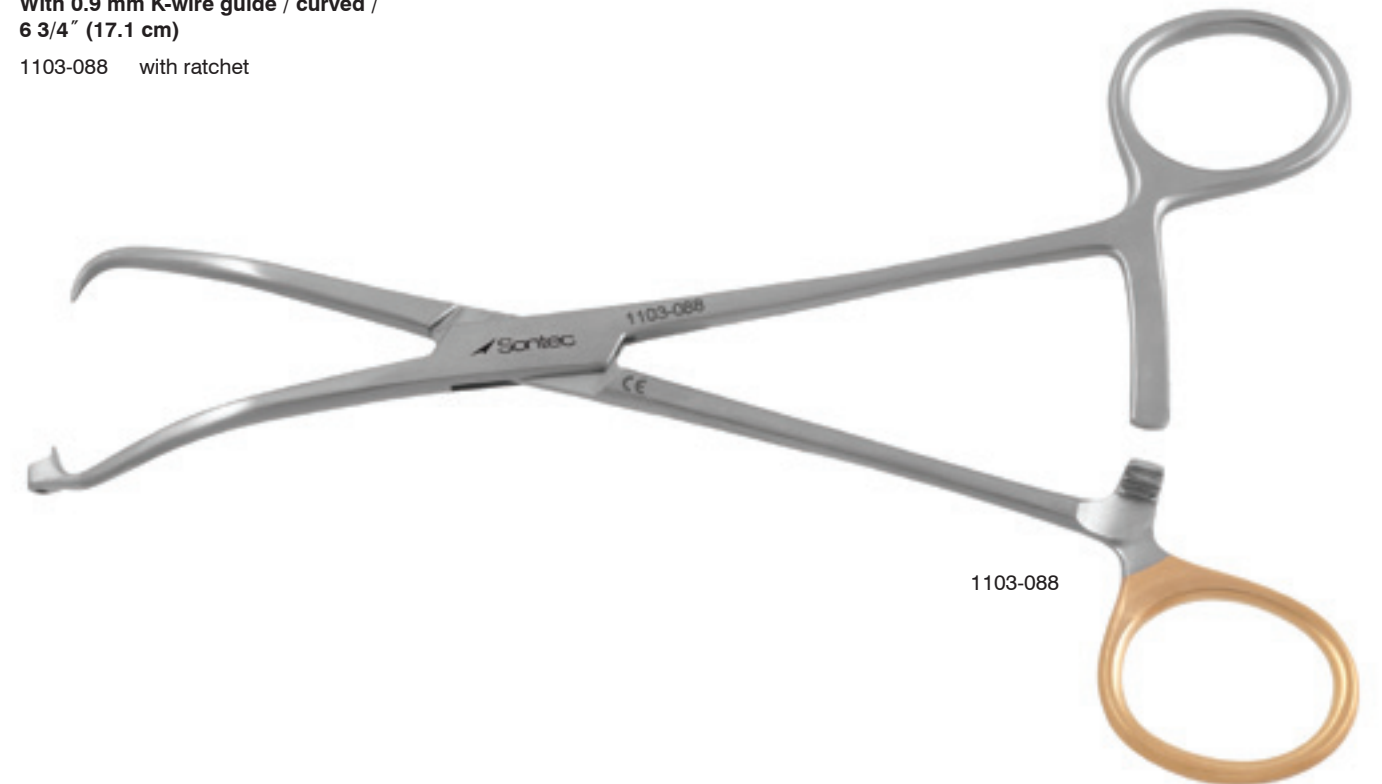

**Deluxe Bone Reduction Clamp**

**Serrated jaws / with ratchet / 5 1/4" (13.3 cm)**

1103-046

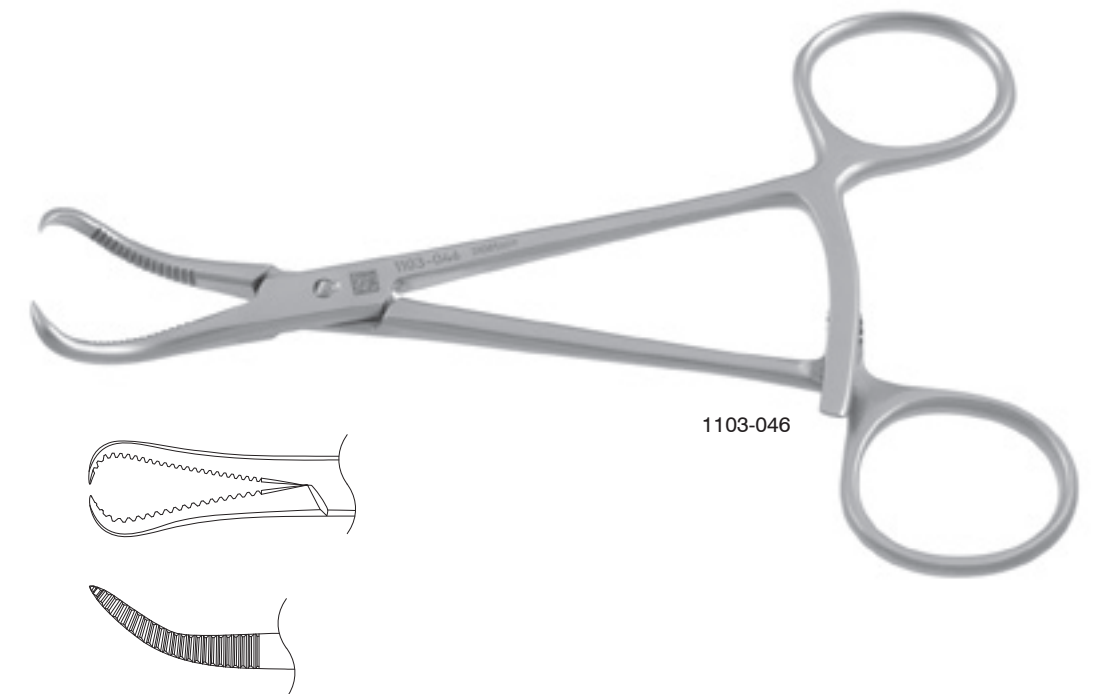

**Bone Reduction Clamp**

**With extra long ratchet**

- 1103-040 5 1/8" (13.25 cm)
- 1103-040R 5 1/8" (15.2 cm) longer ratchet
- 1103-042 7" (18 cm)

**With speedlock**

- 1103-041 5 1/8" (13.25 cm)
- 1103-0425 6 1/8"
- 1103-043 6 1/2" (16.5 cm)

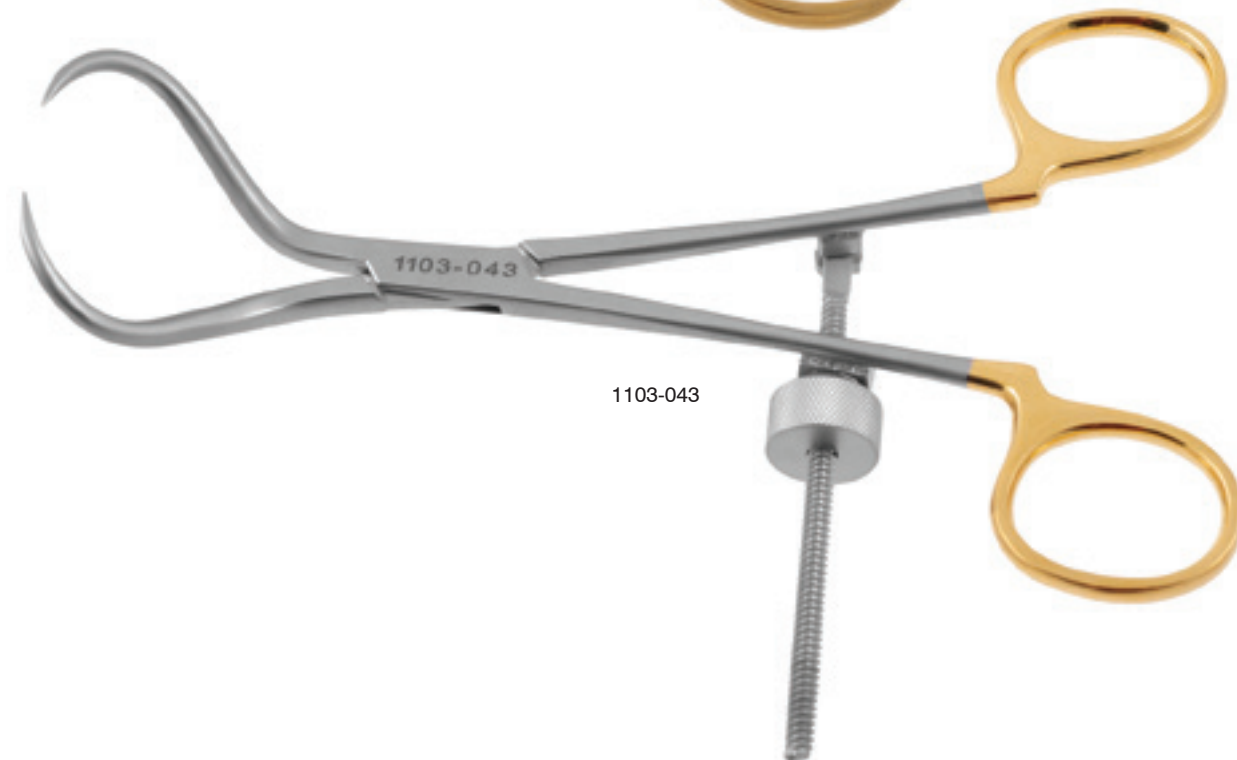

**Bone Reduction Clamp**

**AO types**

- 1103-041A 8" (20.5 cm)
- 1103-041B 6" (15 cm)
- 1103-041C 10" (25.5 cm)

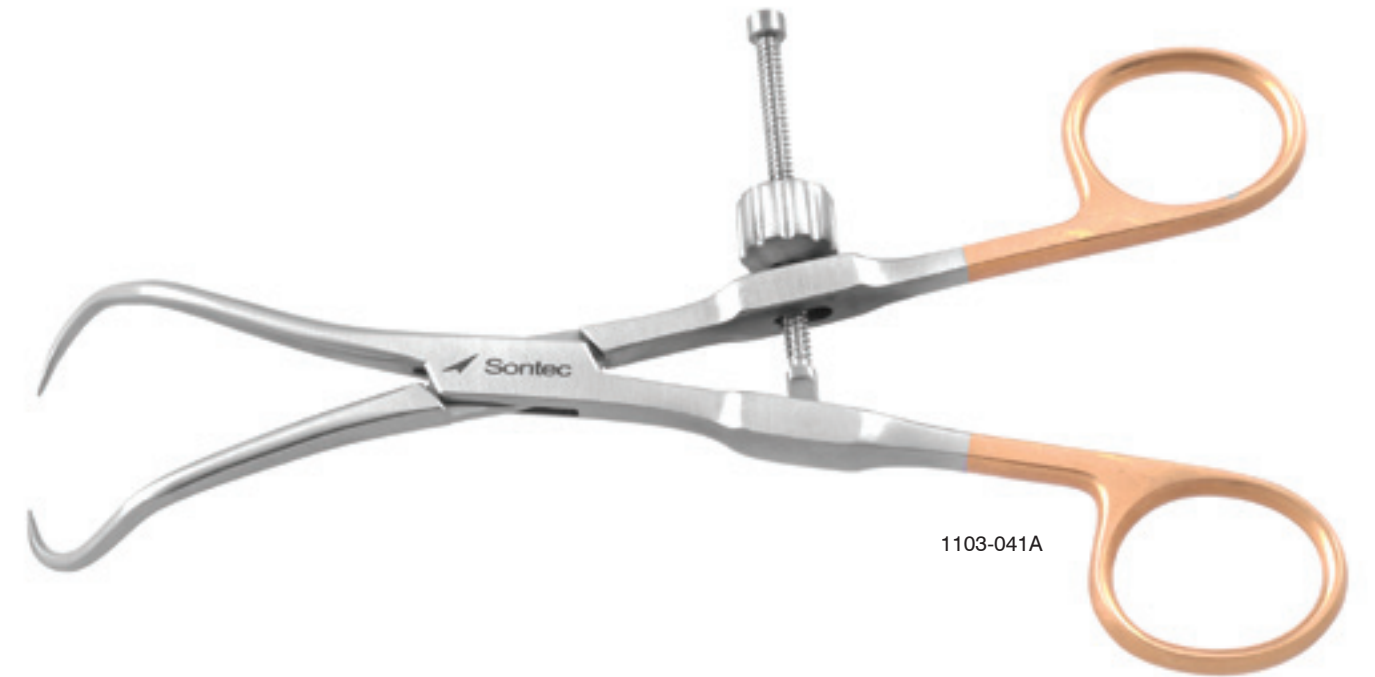

**Ikuta Bone Clamp**

5" (13 cm)

1103-054A	2.0 mm	straight
1103-054B	2.0 mm	curved
1103-054C	3.0 mm	straight
1103-054D	3.0 mm	curved



1103-054C



1103-054D

**Schroeder Vulsellum Bone Reduction Clamp**

9 3/4" (24 cm)

1103-055	str	with speedlock
1103-056	cvd up	with speedlock
1103-057	cvd up	with speedlock
1103-060	str	with ratchet
1103-061	cvd up	with ratchet
525-364	cvd sideways	with ratchet

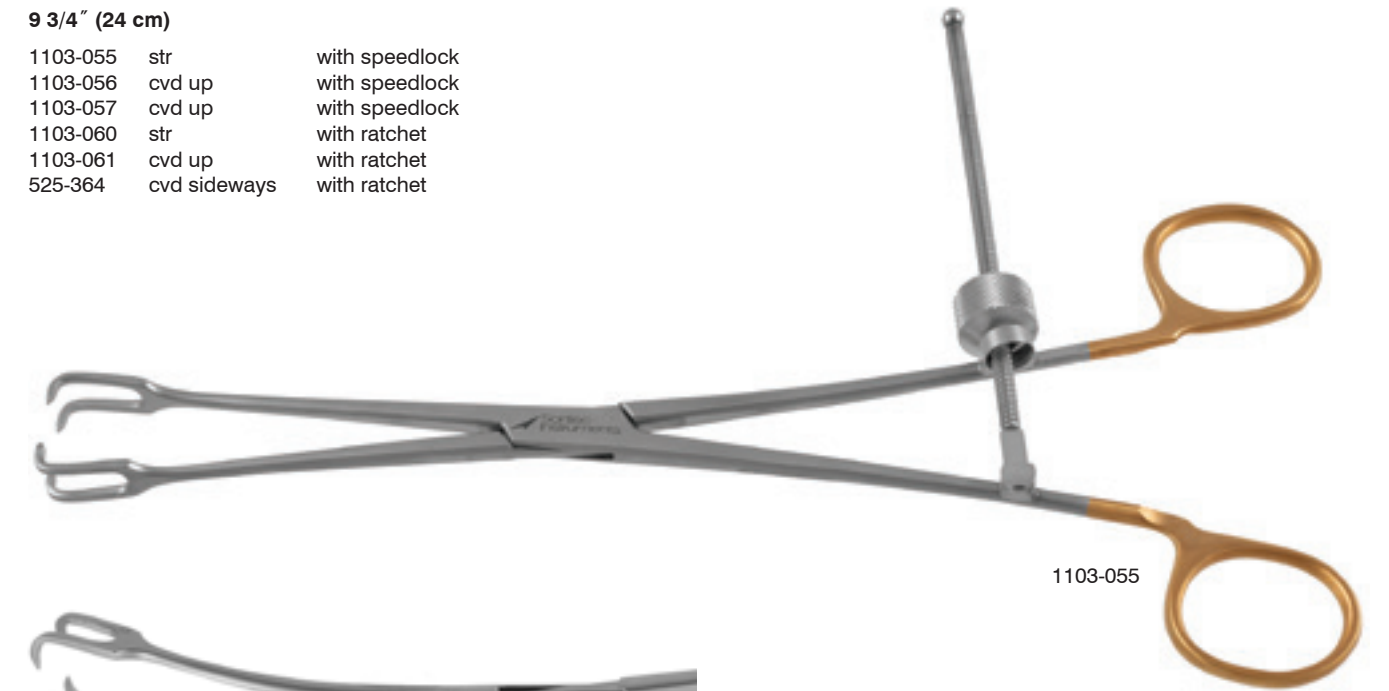

1103-055



1103-057



1103-060



525-364

**Sontec®-Condial Reduction Clamp**

8" (20.5 cm)

1103-036 speedlock  
1103-036R ratchet



**Micro Bone Reduction Clamp**

1103-037 3 3/4" (9.5 cm) with plate holding tip  
1103-037A 4 3/4" (12 cm)



**Bone Reduction Clamp**

With speedlock / 3 3/4" (9.5 cm)

1103-037S



**Redler Reposition Reduction Clamp**

With K-wire guide / 1.6 mm / 5 1/4" (13.5 cm)  
1103-031



1103-031

**Plate & Bone Reduction Forceps**

With long ratchet / 4 3/4" (12 cm)  
1103-038



1103-038

**Hip Reduction Clamp**

With speed lock

- 1106-019 7 3/4"
- 1106-020 10"
- 1106-022 10" 3 balls spikes
- 1106-023 10" asymmetric 3 balls spikes
- 1106-024 10" asymmetric



1106-019



1106-022



1106-023



1106-024



**Martin Cartilage Clamp**

- 350-866 5 3/4" (14.6 cm)
- 350-867 6 1/2" (16.5 cm)
- 350-869 7" (18 cm)
- 350-871 8" (20 cm)



350-867

**Bircher-Ganske Cartilage Clamp**

- 8" (20.5 cm)
- 350-884 straight
- 350-885 curved



350-884

**CSU Meniscus Clamp**

- 5 3/4" (14.5 cm)
- 1103-204 str
- 1103-204A angled



1103-204



1103-204A

**Sontec Meniscus Clamp**

Serrated grooved jaws middle weight / 5 3/8" (13.5 cm)

- 1103-202 str
- 1103-203 angled

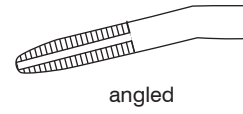

1103-202

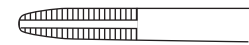

**Sontec Delicate Meniscus Clamp**

Heavy serrated jaws with gap / 5 3/8" (13.5 cm)

- 1103-202D straight
- 1103-203D angled



1103-202D

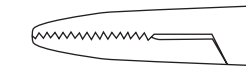

1103-203D

**DeBakey Meniscus Clamp**

Autraumatic jaw / 3 cm jaw / 5 1/2" (14 cm)

142-199 str



3.0 mm DeBakey tip

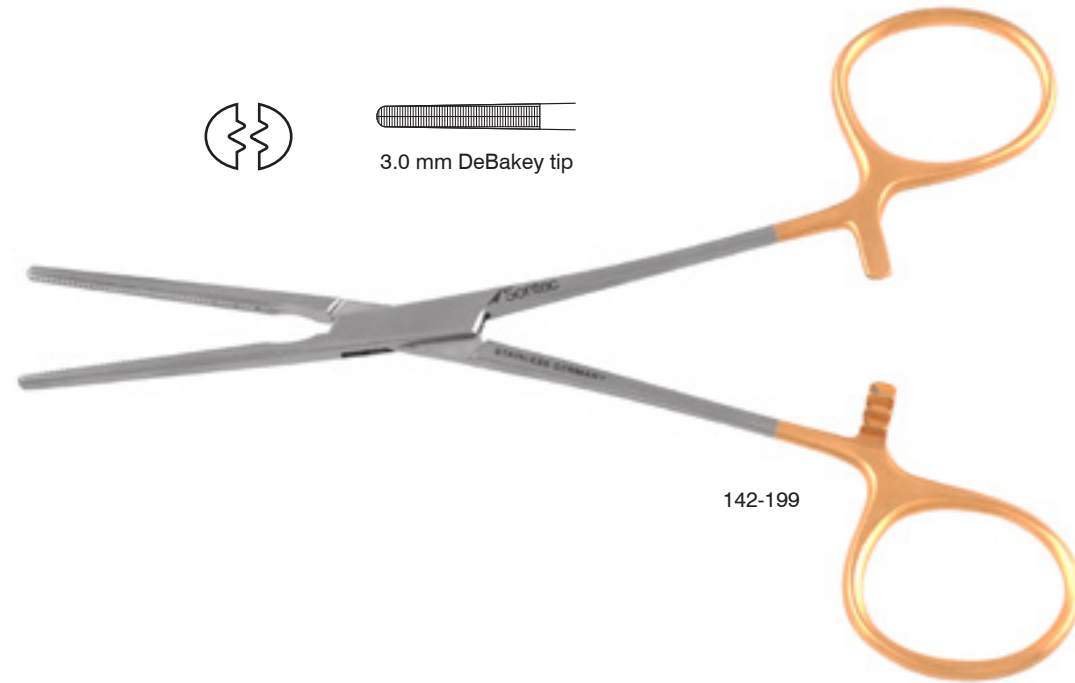

142-199

**Sontec Mesh Meniscus Clamp**

Fenestrated jaws / 7 1/4" (18.5 cm)

350-880 15 teeth with 1 x 2



350-880

**DeBakey Mosquito Forceps**

6" (15 cm)

2200-403 straight

2200-405 curved

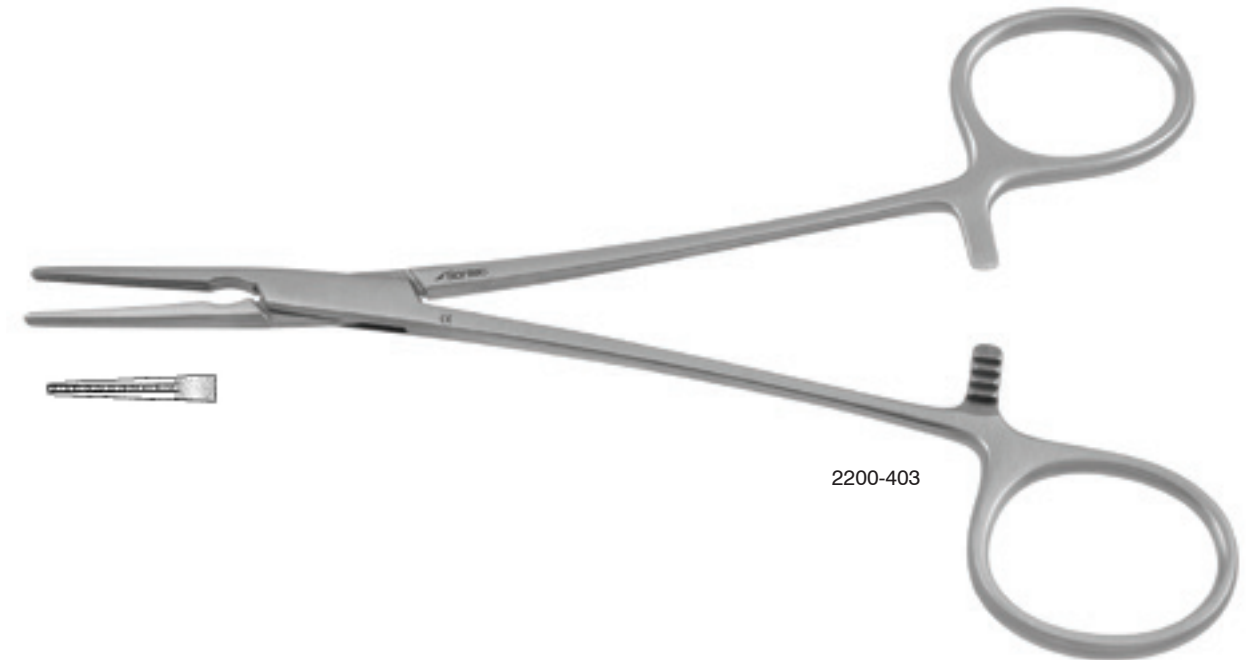

2200-403

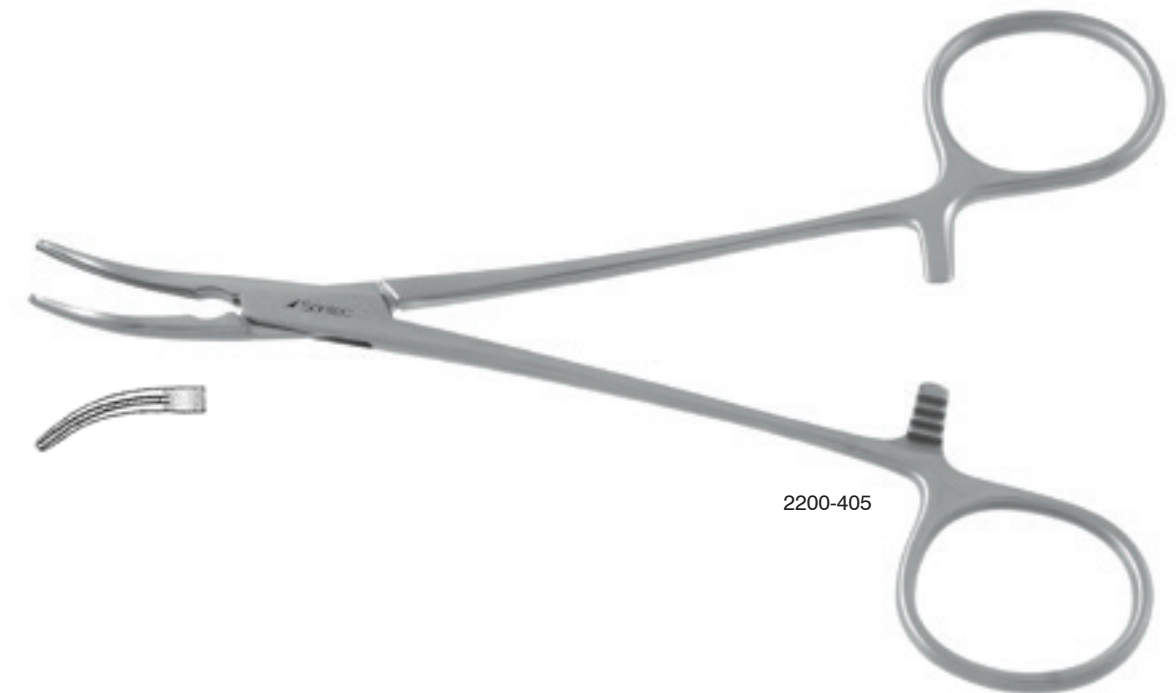

2200-405



 Sontec Instruments®

Orthopedic CURETTES

**Stille Curette**

**Flat handle / round cup**

1103-263	2 mm	6 1/2"
1103-264	3 mm	6 1/2"
1103-265	4 mm	6 1/2"
1103-266	5 mm	7 3/4"
1103-267	6 mm	7 3/4"
1103-268	7 mm	7 3/4"
1103-269	8 mm	7 3/4"
1103-270	10 mm	8"
1103-271	12 mm	8"
1103-272	14 mm	8"

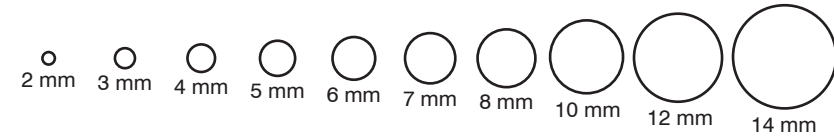

**Bruns Round Cup Curette**

**Round cup / straight / 6 3/4" (17 cm)**

320-708	size 00000
320-709	size 0000
320-710	size 000
320-711	size 00
320-712	size 0
320-713	size 1
320-714	size 2
320-715	size 3
320-716	size 4
320-717	size 5
320-718	size 6

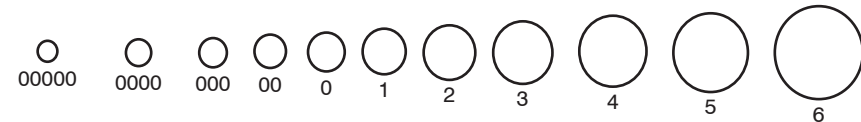

**Bruns Oval Cup Curette**

**Oval cup / straight / 6 3/4" (17 cm)**

320-808	size 00000
320-809	size 0000
320-810	size 000
320-811	size 00
320-812	size 0
320-813	size 1
320-814	size 2
320-815	size 3
320-816	size 4
320-817	size 5
320-818	size 6

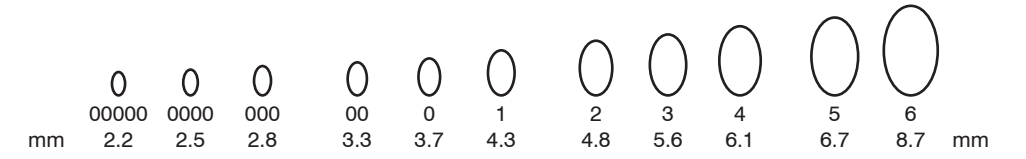

**Oval cup / straight / 9" (23 cm)**

320-827	size 00000
320-829	size 0000
320-830	size 000
320-831	size 00
320-832	size 0
320-833	size 1
320-834	size 2
320-835	size 3
320-836	size 4
320-837	size 5
320-838	size 6



**Oval cup / angled / 9" (23 cm)**

320-848	size 00000
320-849	size 0000
320-850	size 000
320-851	size 00
320-852	size 0
320-853	size 1
320-854	size 2
320-855	size 3
320-856	size 4
320-857	size 5
320-858	size 6



**Bruns Oval Cup Curette**

Oval cup / straight / phenolic handle /  
6 3/4" (17 cm)

- 320-810P size 000
- 320-811P size 00



320-810P



320-811P

**Bruns Solid Hexagonal Curette**

Angled / solid hexagonal handle / oval / 9" (22.9 cm)

- 320-870A size 000
- 320-871A size 00
- 320-872A size 0
- 320-873A size 1
- 320-874A size 2
- 320-875A size 3
- 320-876A size 4
- 320-877A size 5
- 320-878A size 6

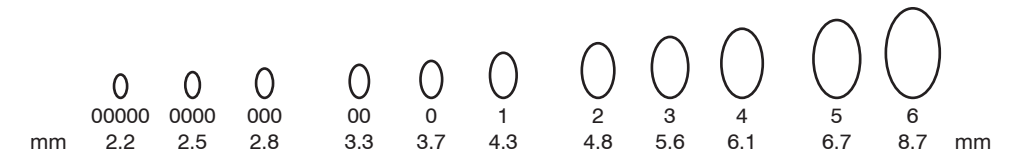

320-870A



320-876A

**Bruns Hexagonal Handle Curette**

Solid hexagonal handle / 9" (23 cm)

- 320-870 size 000
- 320-871 size 00
- 320-872 size 0
- 320-873 size 1
- 320-874 size 2
- 320-875 size 3
- 320-876 size 4
- 320-877 size 5
- 320-878 size 6

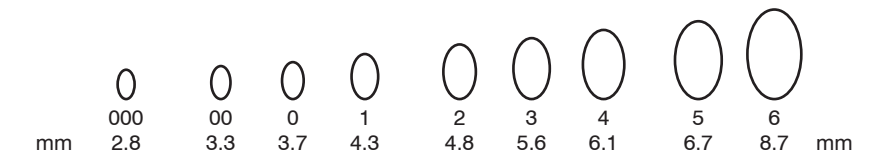

320-876

**Cone Ring Curette**

Aluminum handle / inside ring diameter / 9" (23 cm)

- 320-952 3mm straight
- 320-955 3mm angle
- 320-951 6mm straight
- 320-954 6mm angle
- 320-950 8mm straight
- 320-953 8mm angle

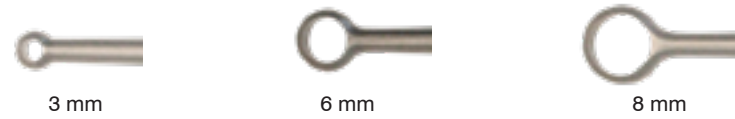

320-953

**Hatt Spoon Curette**

Solid hexagonal handle / 9" (23 cm)

- 320-778 10 mm
- 320-779 15 mm
- 320-780 20 mm



320-780

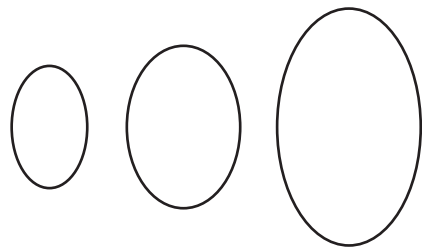

10 mm    15 mm    20 mm

**Bruns Ring Curette**

9" (23 cm)

- 1271-145 5 mm inside ring diameter
- 1271-147 8 mm inside ring diameter
- 1271-146 10 mm inside ring diameter



1271-145

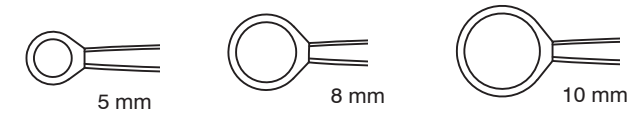

**Volkman Curette**

Double-ended / oval cup - oval cup

- 320-941 5 1/2" (14 cm)
- 320-942 6 1/2" (16.5 cm)
- 320-948 8" (20.5 cm)

Double-ended / round cup - oval cup

- 320-940 5" (13 cm)
- 320-944 6 1/2" (16.5 cm)
- 320-946 8" (20.5 cm)



320-941



320-940

**Jansen Curette**

Sharp / double-ended / 6" (15 cm)

- 320-761 straight round cups
- 320-760 20° double-angled oval cups



320-761



320-760



 Sontec Instruments®

Orthopedic ELEVATORS

**Freer Periosteal Elevator**

Double-ended / square handle / straight / 4.5 mm tip / sharp/blunt / 7 3/4"

1100-798S

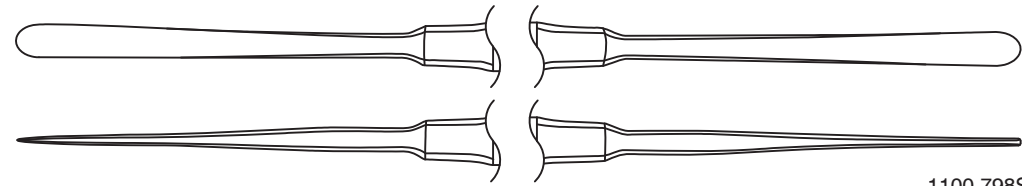

1100-798S

Double-ended / square handle / curved / 4.5 mm tip / sharp/blunt

1100-798 7 3/4"

1100-798G 8 1/2"

1100-798F 8 3/4"



1100-798

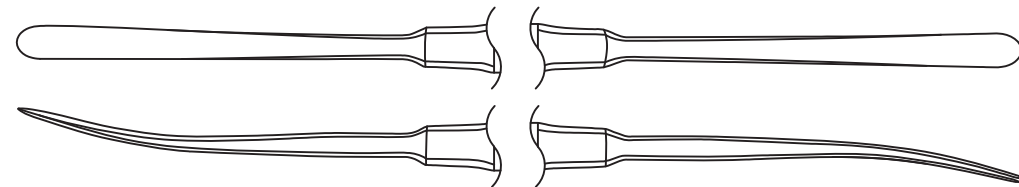

Double-ended / square handle / curved / 6.5 mm tip / sharp/blunt

1100-798A 7 3/4"

1100-798E 8 3/4"



1100-798A

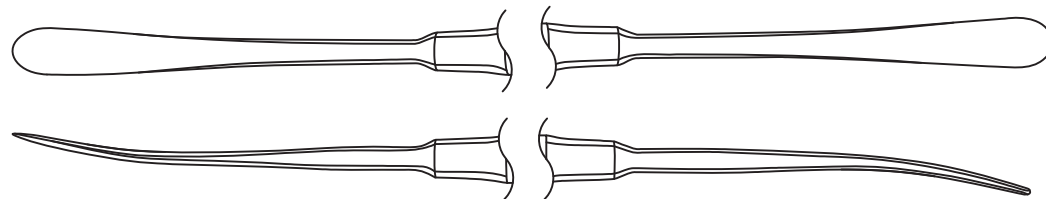

**Freer Periosteal Elevator**

Double-ended / round handle / curved / sharp/blunt / 7 1/2"

1100-798B 5 mm tip

1100-798C 6.7 mm tip



1100-798B

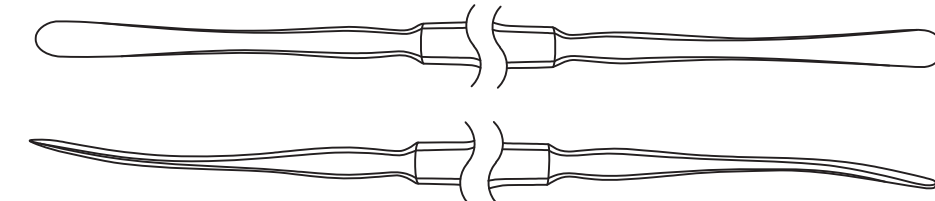

1100-798C

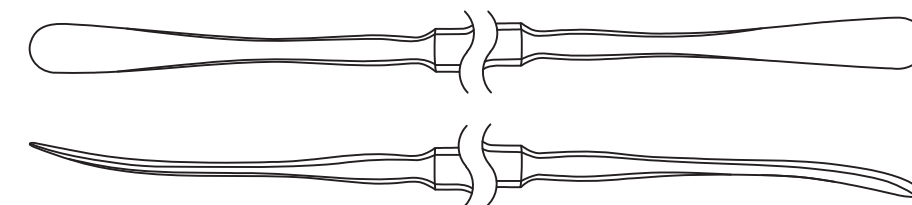

Double-ended / knurled round handle / curved / 4.5 mm tip / sharp/blunt / 6 3/4"

1100-798D



1100-798D

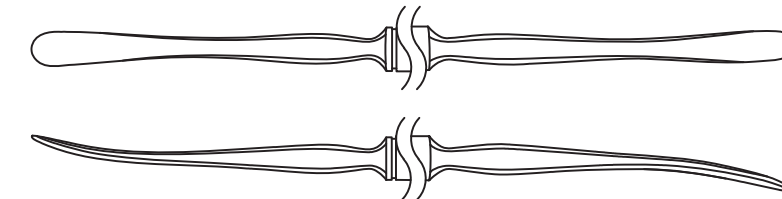

**Freer Periosteal Elevator**

Double-ended / round handle / curved / 3.5 mm tip / sharp / 7 1/4" / 1100-798H

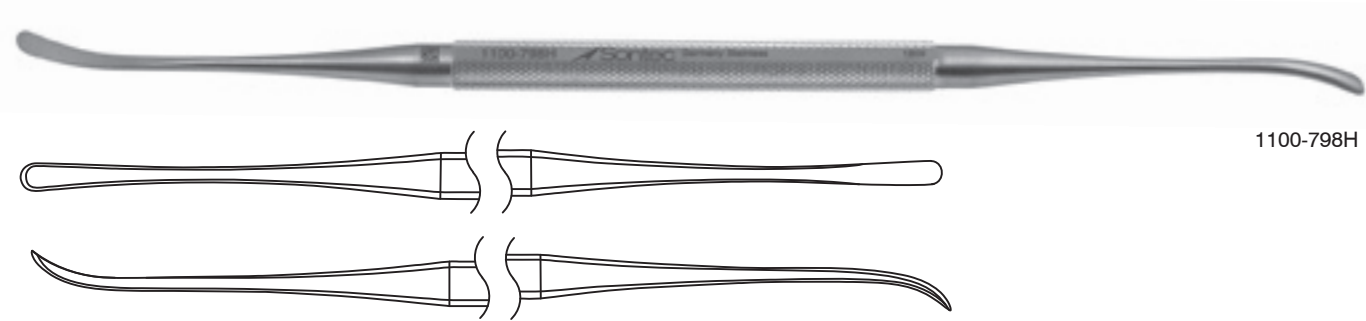

1100-798H

**Adson Periosteal Elevator**

Single-ended / 6 1/2" (16.5 cm)  
 412-520 str chisel edge  
 412-522 cvd blunt  
 412-524 cvd semi-sharp  
 412-526 str semi-sharp



412-520

412-522

412-524

412-526

**Love Adson Periosteal Elevator**

Single-ended / 6 3/4" (16.5 cm)  
 412-528 cvd semi-sharp



412-528

**Langenbeck Periosteal Elevator**

Single-ended / 8" (20 cm)  
 335-205 narrow blunt tip 6 mm  
 335-207 wide sharp tip 17 mm

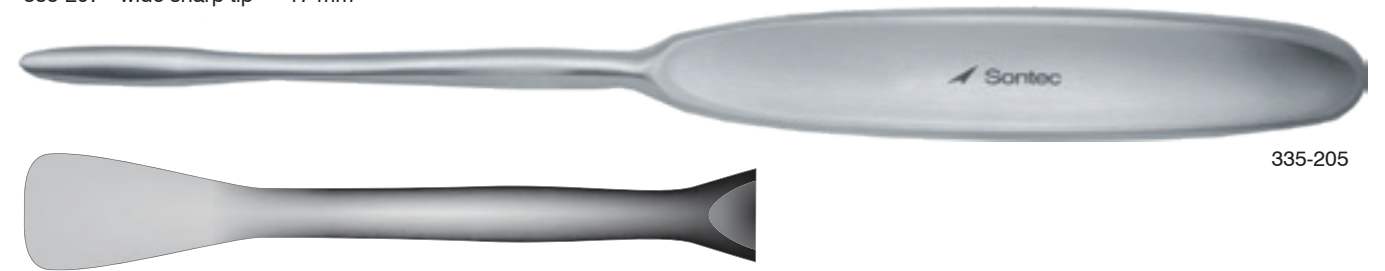

335-205

335-207

**Hoen Periosteal Elevator**

7 mm tip / 6 1/4" (16 cm)  
 412-530



412-530

**Lane Periosteal Elevator**

Single-ended / 7 1/2" (19 cm)  
 335-210 narrow semi-sharp tip 6 mm  
 335-212 wide semi-sharp tip 10 mm



335-210

335-212

**McIlwraith Periosteal Elevator**

Single-ended / 7 1/2" (19 cm)

- 1404-870 sharp
- 1404-871 sharp phenolic handle



1404-870



1404-871

**Key Periosteal Elevator**

6 3/4" (17 cm)

- 335-135 1/8" tip
- 335-136 1/4" tip
- 335-137 3/8" tip

7 1/2" (19 cm)

- 335-138 1/2" tip
- 335-139 5/8" tip



8" (20.5 cm)

- 335-140 3/4" tip

8 3/8" (21.5 cm)

- 335-141 1" tip



335-135



335-136



335-137



335-139

**Joker Periosteal Elevator**

Blunt / curved / 6" (15.5 cm)

412-518



412-518

**Williger Periosteal Elevator**

Sharp / 6 1/4"

- 412-5374 4 mm
- 412-5375 5 mm
- 412-53765 6.5 mm
- 412-5377 7 mm



412-53765

**Sayre Elevator**

Double-ended / 6 1/2" (16.5 cm)

- 1100-512 sharp/blunt
- 1100-512B blunt/blunt



1100-512

**Piermattei Shoulder Elevator**

Single-ended / 9" (23 cm)

1103-210



1103-210

**Sedillot Elevator**

18 mm tip / 7 1/2" (19 cm)

335-226



335-226

**Sontec A O Type Elevator / Raspatory**

Phenolic handles / 7 1/2" (19 cm)

335-250	6 mm tip	str	flat edge
335-254	3 mm tip	slight curve	round edge
335-255	3 mm tip	slight curve	flat edge
335-260	6 mm tip	slight curve	flat edge
335-265	6 mm tip	slight curve	round edge



335-250



335-255



335-260



335-265

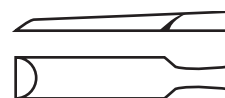

335-250

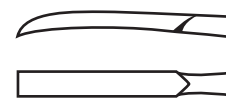

335-255



335-260



335-265

**Sontec A O Type Elevator / Raspatory**

Phenolic handles / 8" (20 cm)

335-270	13 mm tip	angled	flat edge
335-275	14 mm tip	str	round edge
335-280	14 mm tip	cvd	round edge
335-285	20 mm tip	str	round edge



335-270



335-275



335-280



335-285

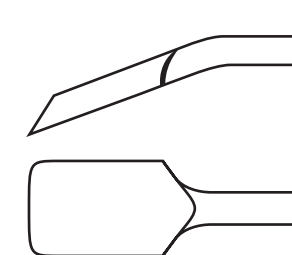

335-270

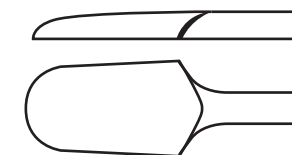

335-275

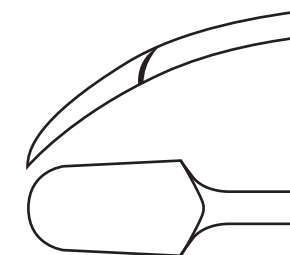

335-280

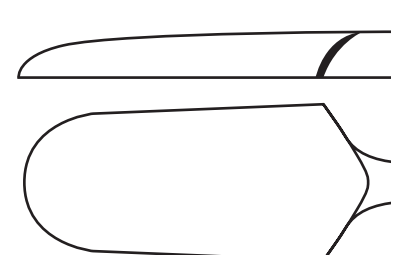

335-285



 Sontec Instruments®

Orthopedic GOUGES

**Smith-Petersen Gouge**

**Straight / 8" (20.5 cm)**

- 330-630 6 mm (1/4") tip
- 330-631 9 mm (3/8") tip
- 330-632 13 mm (1/2") tip
- 330-633 16 mm (5/8") tip
- 330-634 19 mm (3/4") tip
- 330-635 25 mm (1") tip
- 330-636 32mm (1 1/4") tip



330-634

**Curved / 8" (20.5 cm)**

- 330-640 6 mm (1/4") tip
- 330-641 9 mm (3/8") tip
- 330-642 13 mm (1/2") tip
- 330-643 16 mm (5/8") tip
- 330-644 19 mm (3/4") tip
- 330-645 25 mm (1") tip
- 330-646 32mm (1 1/2")tip

**Cobb Type Spinal Gouge**

**11" (20.5 cm)**

- 330-650 straight
- 330-651 medium curve
- 330-652 strong curve
- 330-653 reverse curve



330-652

**Sontec Micro Gouge**

**5 1/2" (14 cm)**

- 475-803 3mm
- 475-804 4mm
- 475-805 5mm
- 475-806 6mm



475-804



475-805



475-806

**Mini Lexer Gouge**

**7" (18 cm)**

- 330-020 4 mm tip
- 330-021 6 mm tip
- 330-022 8 mm tip
- 330-023 10 mm tip
- 330-024 12 mm tip



330-020



330-021



330-022

**Lexer Gouge**

**8 3/4" (22.5 cm)**

- 330-030 7 mm tip
- 330-031 10 mm tip
- 330-032 15 mm tip
- 330-033 20 mm tip
- 330-034 25 mm tip
- 330-035 30 mm tip

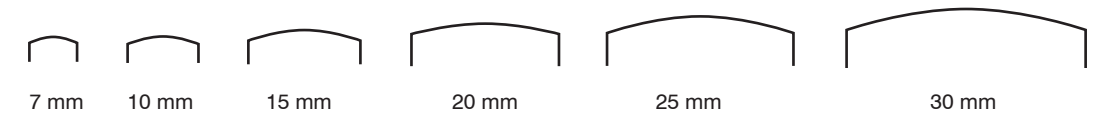

330-030



330-032



330-034

**Hibbs Gouge**

**Straight / 9 1/2" (24.1 cm)**

- 330-590 1/4"
- 330-591 3/8"
- 330-592 1/2"
- 330-593 5/8"
- 330-594 3/4"
- 330-595 7/8"
- 330-596 1"
- 330-597 1 1/8"
- 330-598 1 1/4"
- 330-599 1 1/2"



330-591

**Curved / 9 1/2" (24.1 cm)**

- 330-600 1/4"
- 330-601 3/8"
- 330-602 1/2"
- 330-603 5/8"
- 330-604 3/4"
- 330-605 7/8"
- 330-606 1"
- 330-607 1 1/8"
- 330-608 1 1/4"
- 330-609 1 1/2"

**Hibbs Chisel**

**Straight / 9 1/2" (24.1 cm)**

- 330-500 1/4"
- 330-511 3/8"
- 330-512 1/2"
- 330-513 5/8"
- 330-514 3/4"
- 330-515 7/8"
- 330-516 1"
- 330-517 1 1/8"
- 330-518 1 1/4"
- 330-519 1 1/2"



330-517

**Curved / 9 1/2" (24.1 cm)**

- 330-530 1/4"
- 330-531 3/8"
- 330-532 1/2"
- 330-533 5/8"
- 330-534 3/4"
- 330-535 7/8"
- 330-536 1"
- 330-537 1 1/8"
- 330-538 1 1/4"
- 330-539 1 1/2"

**Sontec Chisel**

**Curved / 7 1/4" (18.4 cm)**

- 330-460 7 mm



330-460

**Straight / 7 1/4" (18.4 cm)**

- 330-462 6 mm
- 330-464 8 mm
- 330-466 10 mm
- 330-468 12 mm
- 330-470 16 mm
- 330-472 22 mm



330-464



330-466



330-468



330-470



330-472



 Sontec Instruments®

Orthopedic OSTEOTOMES

**Smith Peterson Osteotome**

**Straight / 8" (20.5 cm)**

330-610	1/4"
330-611	3/8"
330-612	1/2"
330-613	5/8"
330-614	3/4"
330-615	1"
330-616	1 1/4"



330-611



330-612

**Smith Peterson Osteotome**

**Curved / 8" (20.5 cm)**

330-620	1/4"
330-621	3/8"
330-622	1/2"
330-623	5/8"
330-624	3/4"
330-625	1"
330-626	1 1/4"



330-621



330-623



330-624



330-625



330-626

**Hibbs Osteotome**

**Straight / 9 1/2" (24 cm)**

- 330-550 1/4"
- 330-551 3/8"
- 330-552 1/2"
- 330-553 5/8"
- 330-554 3/4"
- 330-555 7/8"
- 330-556 1"
- 330-557 1 1/8"
- 330-558 1 1/4"
- 330-559 1 1/2"

**Curved / 9 1/2" (24 cm)**

- 330-570 1/4"
- 330-571 3/8"
- 330-572 1/2"
- 330-573 5/8"
- 330-574 3/4"
- 330-575 7/8"
- 330-576 1"
- 330-577 1 1/8"
- 330-578 1 1/4"
- 330-579 1 1/2"

330-550



330-551



330-552



330-553



330-571



330-572



330-573



**Lambotte Osteotome**

**Straight / 9" (23 cm)**

- 330-660 1/4" (6 mm)
- 330-661 1/2" (13 mm)
- 330-662 3/4" (19 mm)
- 330-663 1" (25 mm)
- 330-664 1 1/4" (32 mm)
- 330-665 1 1/2" (38 mm)

**Curved / 9" (23 cm)**

- 330-670 1/4" (6 mm)
- 330-671 1/2" (13 mm)
- 330-672 3/4" (19 mm)
- 330-673 1" (25 mm)
- 330-674 1 1/4" (32 mm)
- 330-675 1 1/2" (38 mm)

330-660

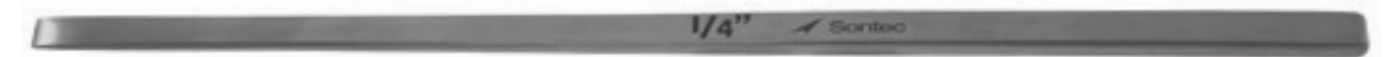

330-661

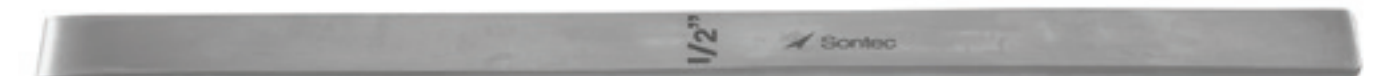

330-662



330-665



330-670



330-671



**West Osteotome**

**Square handle**

330-708	4 mm	6 1/2" (16.5 cm)
330-708A	6 mm	7 1/2" (19 cm)



**Hand Surgery Osteotome**

**Straight / 5" (13 cm)**

1103-281	3/32" (2 mm)
1103-280	1/8" (3 mm)
1103-282	5/32" (4 mm)
1103-283	1/4" (6 mm)
1103-284	5/16" (8 mm)
1103-285	13/32" (10 mm)
1103-286	15/32" (12 mm)
1103-287	9/16" (14 mm)
1103-288	19/32" (15 mm)
1103-289	3/4" (19 mm)
1103-291	5/8" (16 mm)
1103-292	11/16" (18 mm)
1103-293	13/16" (20 mm)



**Curved / 5" (13 cm)**

1103-281C	3/32" (2 mm)
1103-280C	1/8" (3 mm)
1103-282C	5/32" (4 mm)
1103-283C	1/4" (6 mm)
1103-284C	5/16" (8 mm)
1103-285C	13/32" (10 mm)
1103-286C	15/32" (12 mm)
1103-287C	9/16" (14 mm)
1103-288C	19/32" (15 mm)
1103-289C	3/4" (19 mm)
1103-291C	5/8" (16 mm)
1103-292C	11/16" (18 mm)
1103-293C	13/16" (20 mm)

**Sheehan Osteotome**

**6 1/4" (16 cm)**

330-882	2 mm
330-883	3 mm
330-884	4 mm
330-885	5 mm
330-886	6 mm
330-887	7 mm
330-888	8 mm
330-889	9 mm
330-890	10 mm
330-891	11 mm
330-892	12 mm
330-895	15 mm



**Hoke Osteotome**

**Hex handle / straight / 5" (12.5 cm)**

330-690	1/8" (3 mm)
330-691	3/16" (4 mm)
330-692	1/4" (6 mm)
330-693	5/16" (8 mm)
330-694	3/8" (10 mm)
330-695	1/2" (13 mm)
330-696	5/8" (16 mm)



**Curved / 5" (12.5 cm)**

330-700	1/8" (3 mm)
330-701	3/16" (4 mm)
330-702	1/4" (6 mm)
330-703	5/16" (8 mm)
330-704	3/8" (10 mm)
330-705	1/2" (13 mm)
330-706	5/8" (16 mm)



**Cottle Plastic Osteotome**

Specially designed edge / heavy type / with end stop platform / with no corners on blade / 7" (18 cm)

- 330-849A 3/32" (2 mm)
- 330-849B 5/32" (4 mm)
- 330-849C 9/32" (7 mm)
- 330-849D 11/32" (9 mm)
- 330-849E 15/32" (12 mm)



330-849A



330-849B



330-849C



330-849D



330-849E

**Stille Osteotome**

Hexagonal handle / 8" (20.5 cm)

- 330-730 13/32" (10 mm)
- 330-731 9/16" (14 mm)
- 330-732 23/32" (18 mm)
- 330-733 7/8" (22 mm)



330-730



330-731



330-733

**Hardt Micro Cartilage Osteotome Set (with tray)**

**5 1/8" (13.25 cm)**

330-799-SET includes:

- 330-801M 3/32" (2 mm)
- 330-802M 5/32" (4 mm)
- 330-803M 1/4" (6 mm)
- 330-804M 5/16" (8 mm)
- 330-805M 13/32" (10 mm)
- 330-806M 15/32" (12 mm)
- 330-807M 19/32" (15 mm)

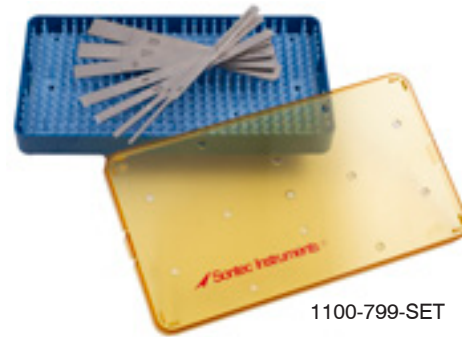

1100-799-SET



1100-800M-SET

**6 3/4" (17 cm)**

330-800M-SET includes:

- 330-790M 3/32" (2 mm)
- 330-791M 5/32" (4 mm)
- 330-792M 1/4" (6 mm)
- 330-793M 5/16" (8 mm)
- 330-794M 13/32" (10 mm)
- 330-795M 15/32" (12 mm)
- 330-796M 19/32" (15 mm)

1103-723 7 1/2" x 4" x 3/4" tray with silicone mat, autoclavable

Hardt Osteotomes also available individually



330-801M

330-802M

330-803M

330-804M

330-805M

330-806M

330-807M

**Sontec-Cottle Osteotome Set**

**Graduated markings / 7" (18 cm)**

1100-479-SET set includes:

7 osteotomes and tray  
2 mm, 3 mm, 4 mm, 6 mm,  
8 mm, 10 mm, 12 mm

- 1100-479K 2 mm
- 1100-479M 3mm
- 1100-479L 4 mm
- 1100-479A 6 mm
- 1100-479B 8 mm
- 1100-479C 10 mm
- 1100-479D 12 mm
- 1100-479E 14 mm
- 1100-479F 16 mm
- 1100-479G 18 mm
- 1100-479N 19mm
- 1100-479J 20 mm
- 1100-479H 22 mm

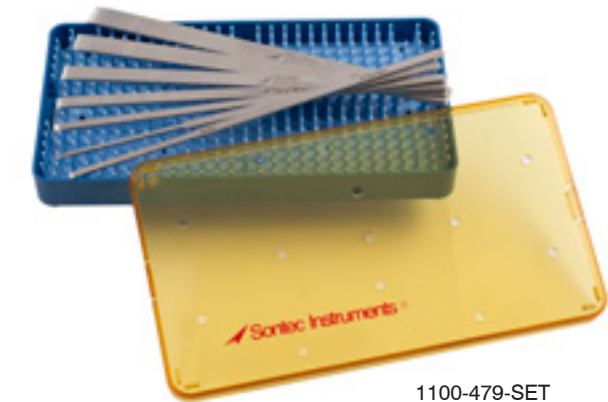

1100-479-SET

1103-723 7 1/2" x 4" x 3/4" tray with silicone mat, autoclavable

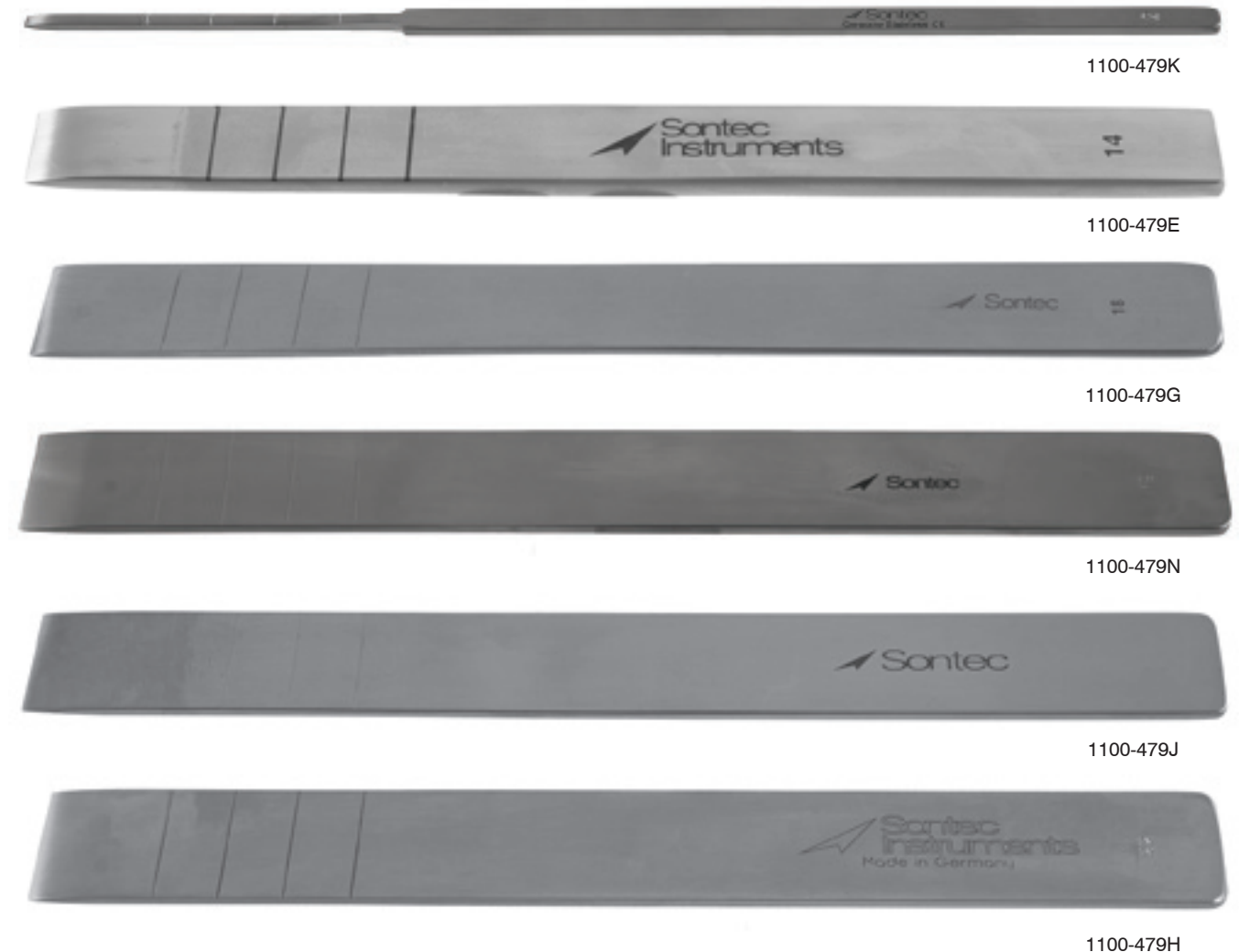

1100-479K

1100-479E

1100-479G

1100-479N

1100-479J

1100-479H

**Hardt Micro Ceramitec Osteotome**

6 3/4" (17 cm)

- 330-790MB 2 mm
- 330-791MB 4 mm
- 330-792MB 6 mm
- 330-793MB 8 mm
- 330-794MB 10 mm
- 330-795MB 12 mm
- 330-796MB 15 mm



330-791MB



330-792MB

**Mini Lexer Osteotome**

Small handle / 7" (18 cm)

- 330-001 4 mm tip
- 330-002 6 mm tip
- 330-003 8 mm tip
- 330-004 10 mm tip
- 330-005 12 mm tip

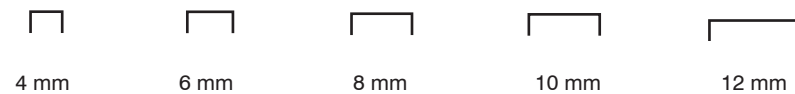

330-005

**Lexer Osteotome**

Large handle / 8 3/4" (22.5 cm)

- 330-010 7 mm tip
- 330-011 10 mm tip
- 330-012 15 mm tip
- 330-013 20 mm tip
- 330-014 25 mm tip
- 330-015 30 mm tip



330-015



**Lexer Osteotome**

Large handle / 12" (30.5 cm)

- 330-016 10 mm tip
- 330-017 12 mm tip
- 330-018 15 mm tip

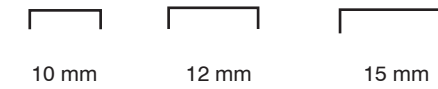

330-016

**Obwegeser Split Osteotome**

8 3/4" (22.5 cm)

- 330-120 8 mm tip
- 330-125 12 mm tip
- 330-130 16 mm tip
- 330-135 20 mm tip



330-130

**Obwegeser Wedge Osteotome**

8 3/4" (22.5 cm)

- 330-100 8 mm tip
- 330-105 12 mm tip
- 330-110 16 mm tip



330-100



 Sontec Instruments®

Orthopedic MALLETS

**Sontec Combo Nylon Mallet**

1" head diameter / removable heads / 7 3/8" (18.75 cm)

1100-462S deluxe mallet with one nylon head

**Sold separately**

1100-462SH stainless steel head for deluxe mallet

1100-463S nylon head for deluxe mallet



1100-462S



1100-462SH



1100-463S

**Sontec Double Nylon Mallet**

Light-weight / 7 3/8" (18.7 cm) / 7 oz.

330-808



**Sontec Micro Mallet**

3/4" head diameter / 6 1/2" (16.5 cm)

330-817 stainless steel convex/flat combo 4 oz.

330-819 lead filled head no recoil 5.6 oz.



330-819

**Mead Mallet**

3/4" head diameter / 7 1/2" (19 cm) / 8 oz. head  
/ w/replacement nylon caps

330-814

**Replacement caps**

330-814R

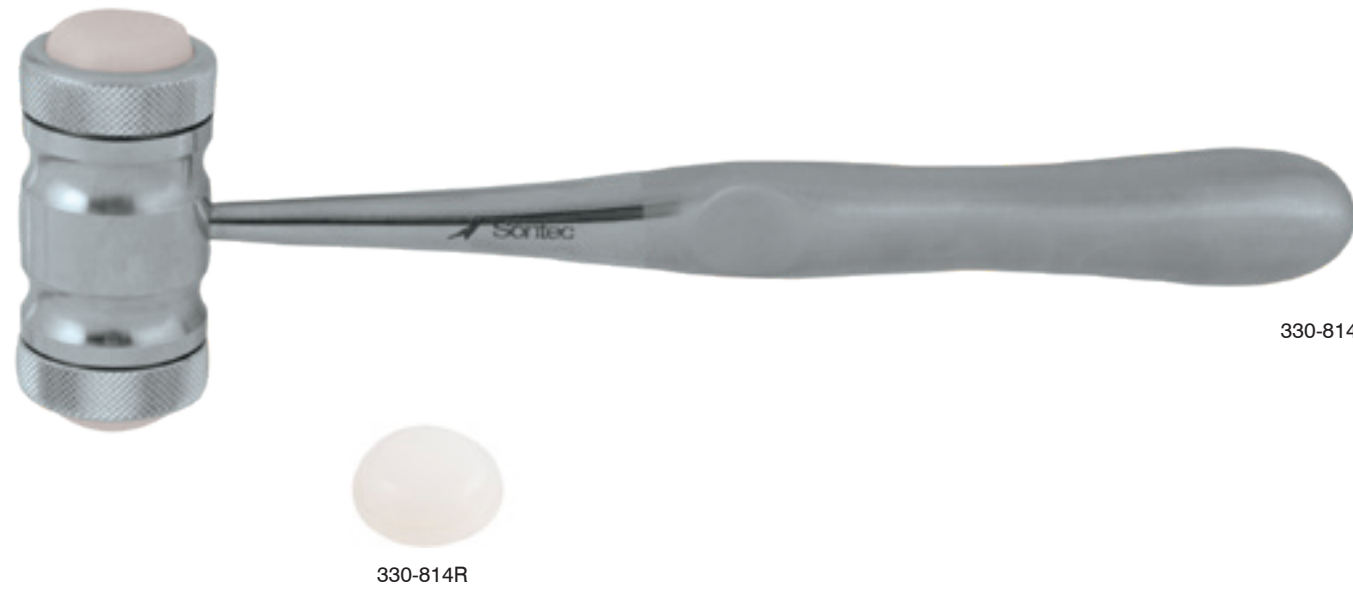

**Brass Head Mallet**

7 3/4" (20 cm)

330-811



**Large Sontec Combo Mallet**

1 1/2" head / replaceable heads / 8" (20.5 cm)

330-824

330-824S stainless & nylon head

**Replaceable heads / 1 1/2" (3.8 cm)**

330-824NH nylon

330-824SH stainless steel



330-824NH

330-824SH



330-824

**Cottle Mallet**

Convex flat combo / 7 1/2" (19.1 cm)

1100-461S stainless steel head



1100-461S

**Collin Lucae Mallet**

Solid head / 210 grams /  
30mm Ø / 8 1/4" (21 cm)

330-818



330-818

**USA Model Mallet**

1" diameter / 1 lb USA model / 7 1/4" (18.4 cm)

330-833



**Sontec Large Mallet**

10 3/4" (26.5 cm)

330-835 1 pound (450 g)  
330-834 2 pounds (900 g)



330-835



330-834

**Heavyweight Mallet**

1 1/2" head diameter / 7 1/4" (18.5 cm)  
330-832 1.72 lbs



330-832

**AO Type Mallet**

Fenestrated handle / AO type / 9" (23 cm)  
330-839



330-839

**Sontec Large Handle Mallet**

**Ribbed phenolic handle**  
330-840 10 1/4" (26 cm) 1 3/4" head dia. 3 lbs  
330-842 10 1/4" (26 cm) 1 1/4" head dia.



330-840

**Sontec Large Handle Mallet**

**Ergonomic phenolic handle / 1 1/4" head diameter**  
330-841 8 3/4" (22 cm)



330-841

**No Recoil Mallet**

**One sided nylon head / no recoil**

330-823 9 3/4" (25 cm) 500 g 35mm diameter head  
 330-827 9" (23cm) 300 g 27mm diameter head



330-823



330-827

**Phenolic Spinal Mallet**

**10 1/4" (26.5 cm)**

330-844 35 mm 150 g  
 330-845 45 mm 240 g  
 330-846 50 mm 330 g

**9 1/2" (24 cm) / Steinbach style**

330-847 60 mm 400 g



330-844



330-847



 Sontec Instruments®

Orthopedic MENISCOTOMES & KNIVES

**Femoral Head Disarticulator Knife**

**Curved**

1103-211 Small 5 1/2" (14 cm)  
1103-213 Large 7 1/2" (19 cm)



1103-211



1103-213

**V Blade Meniscotome**

**Flat handle / 6 3/4" (17 cm)**

1103-206

**Curved / 8" (20.5 cm)**

1103-209



1103-206

**Mini V-Blade Meniscotome**

**Flat handle / 6 3/4" (17 cm)**

1103-2063 3mm



1103-2063

**Foerner Sesamoid Knife Elevator**

**Single end / curved / 5 mm tip**

1404-875 6 1/4" (16 cm)

1404-875L 7 1/4" (18.4 cm) heavy



1404-875



1404-875L

**Rosin Root Meniscotome**

Curved "V" blade / 6 1/4" (16 cm)  
350-836



350-836

**Piermattei Smillie Meniscotome**

6 3/4" (17 cm)  
1103-205



1103-205

**Smillie Meniscotome**

Straight blade / 6 3/4" (17 cm)  
1103-208



1103-208

**Smillie Meniscus Knife**

Curved / "V" tip / 8" (20.3 cm)  
350-838



350-838

**Braake Tendon Knife**

Angled down / carbon coated  
shaft / 7" (18 cm)  
1271-183



1271-183

**Nixon XXL Banana Knife**

Double sided / wide blade / serrated / 9" (23 cm)  
1271-139C curved  
1271-139D straight



1271-139C



1271-139D



 Sontec Instruments®

Orthopedic PIN-PULLERS, DRIVERS & BENDERS

**Vickers Easy Driver / Bender / Puller**

To drive, bend & pull K-wire / 5 1/2" (14 cm)

1103-179

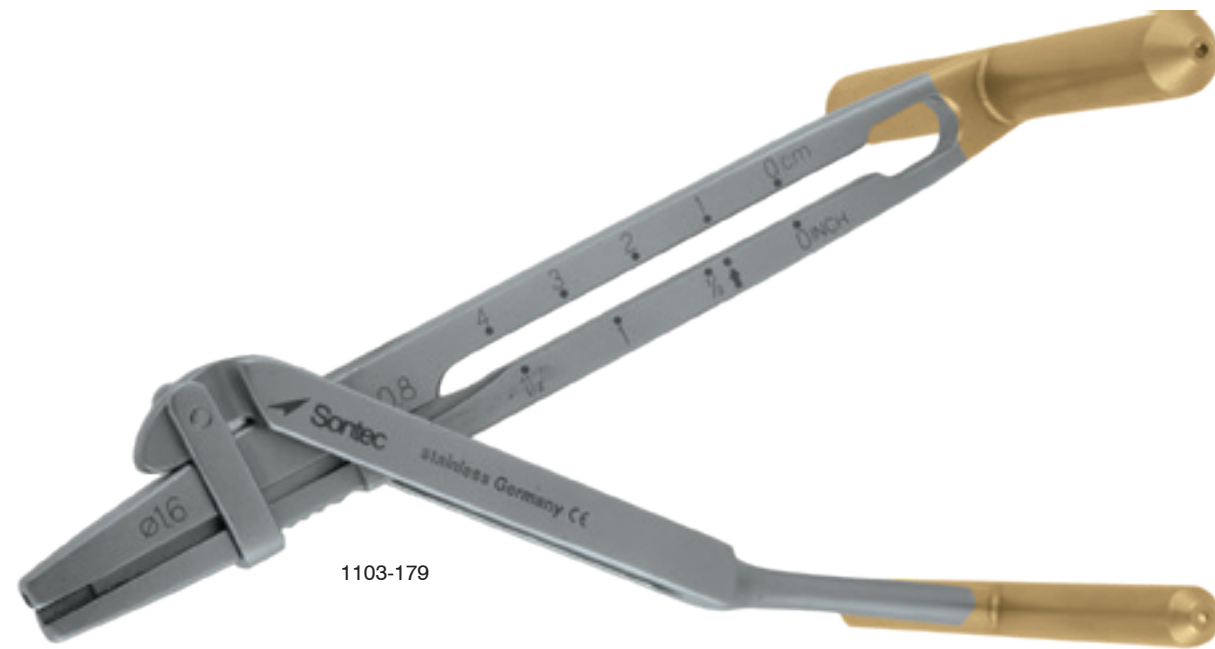

1103-179

**Black Vickers K-Wire Pin Bender**

3 1/2" (9 cm)

1103-178A 1 mm Ø (0.035") x 1.2 mm Ø (0.045")

1103-178C 1.4 mm Ø (0.054") x 1.6 mm Ø (0.062")



1103-178A



1103-178C

**Pin Driver & Bone Tamp**

Single-ended flat tip with 1 mm raised circular lip / 3 1/2" (9 cm) in length

1103-2011 1.5 mm tip

1103-201A 2 mm tip

1103-201B 3 mm tip

1103-201C 4 mm tip

1103-201D 5 mm tip

1103-201E 6 mm tip

1103-201F 8 mm tip

1103-201G 10 mm tip

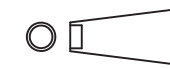

1103-201A

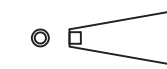

1103-2011



1103-201D



1103-201B



1103-201C

**Sontec Pin Driver / Bender**

Bends K-wire and pins

- 1103-201 2 mm / 2.3 mm 5" (13 cm)
- 1106-199 2 mm / 3.2 mm 6" (15.5 cm)

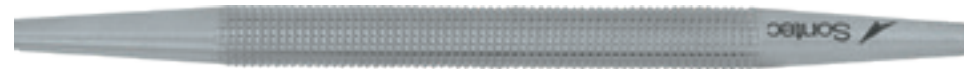

1103-201



1106-199

**Peterson Fully Cannulated Pin Bender**

Double-ended with concave tips / specially cannulated through entire length for better leverage

- 1103-201J 2 mm tip / 2.3 mm tip 5" (13 cm)
- 1103-201H 2 mm tip / 3.2 mm tip 5 3/4" (14 cm)



1103-201J



1103-201H

**Pin Bender Double-Ended**

Bends K-wire / 4 1/2" (11.5 cm)

- 1106-196 1.6 mm tip / 2.0 mm tip
- 1106-198 0.8 mm tip / 1.25 mm tip



1106-196



1106-198

**Pin Bender Double-Ended**

Bends K-wire / 0.9 mm (0.035") / 1.6 mm (0.062") / 1.1 mm (0.045") / 1.4 mm (0.054") / 4 1/2" (11.5 cm)

- 1106-206



1106-206

**Piermattei Pin Bender / Driver**

3 1/2" (9 cm)  
1103-200

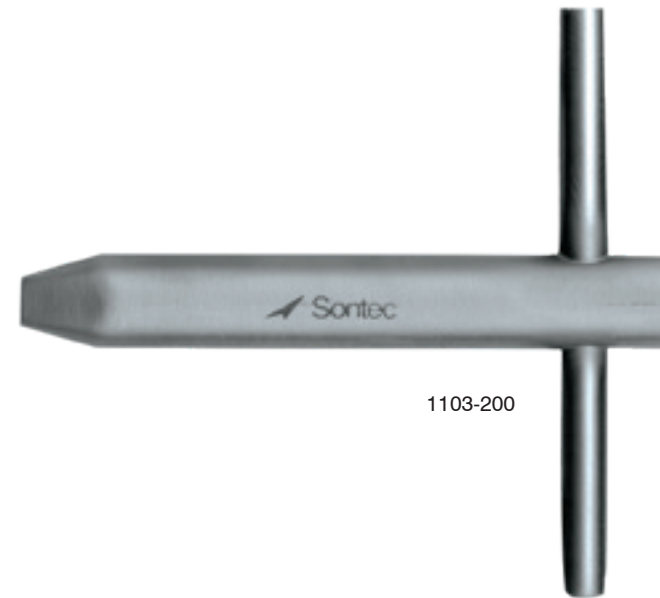

1103-200

**Steinman Pin Puller**

Pulls pins from 1/8" (3.2 mm)  
/ 5 1/2" (14 cm)  
1106-124

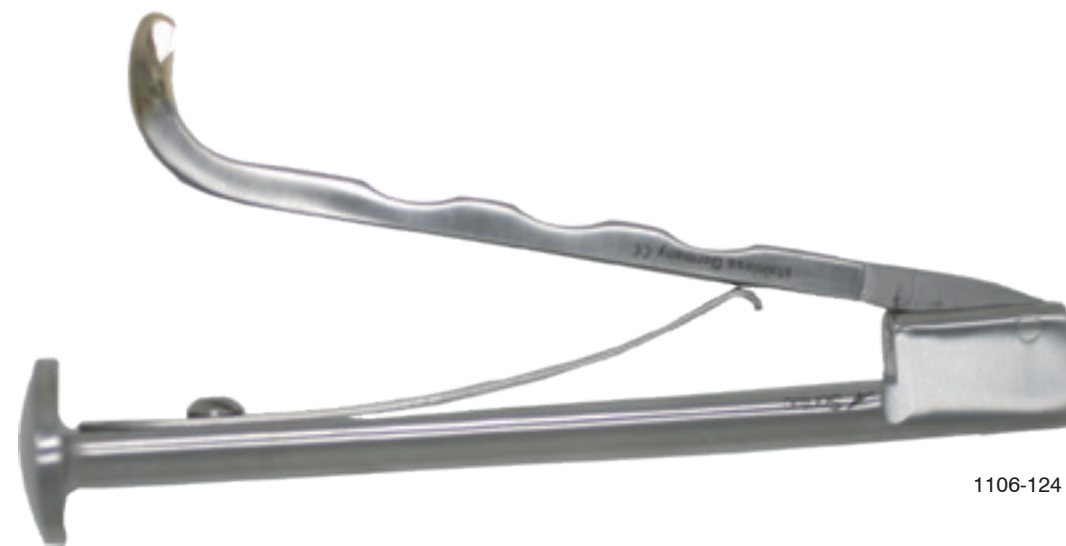

1106-124

**Parallel Wire Extraction Pliers**

Cuts wire up to 1.6 mm MAX

- 1103-125 4 1/2" (11.5 cm) with TC cutter
- 1103-126 6 1/2" (16.5 cm) with TC cutter
- 1103-126R 6 1/2" (16.5 cm) with TC cutter rainbow
- 1103-127 7 1/4" (18.5 cm) with TC cutter
- 1103-127A 7 1/2" (19 cm) without TC cutter



1103-125



1103-127



1103-127A

**Pin Pulling Double Action Pliers**

TC serrated / double-action / 7" (18 cm)

- 1100-533 2 mm
- 1100-533A 3 mm
- 1100-532 4 mm
- 1100-536 6 mm



**Pin Puller**

Grooved serrated jaws / with adjustable screw

- 1103-122 5 1/2"
- 1103-123 7"



**HERCULES® GRIP Pin Puller**

Over 40% less power required / 7" (18 cm)

- 355-182 3 mm
- 355-183 6 mm

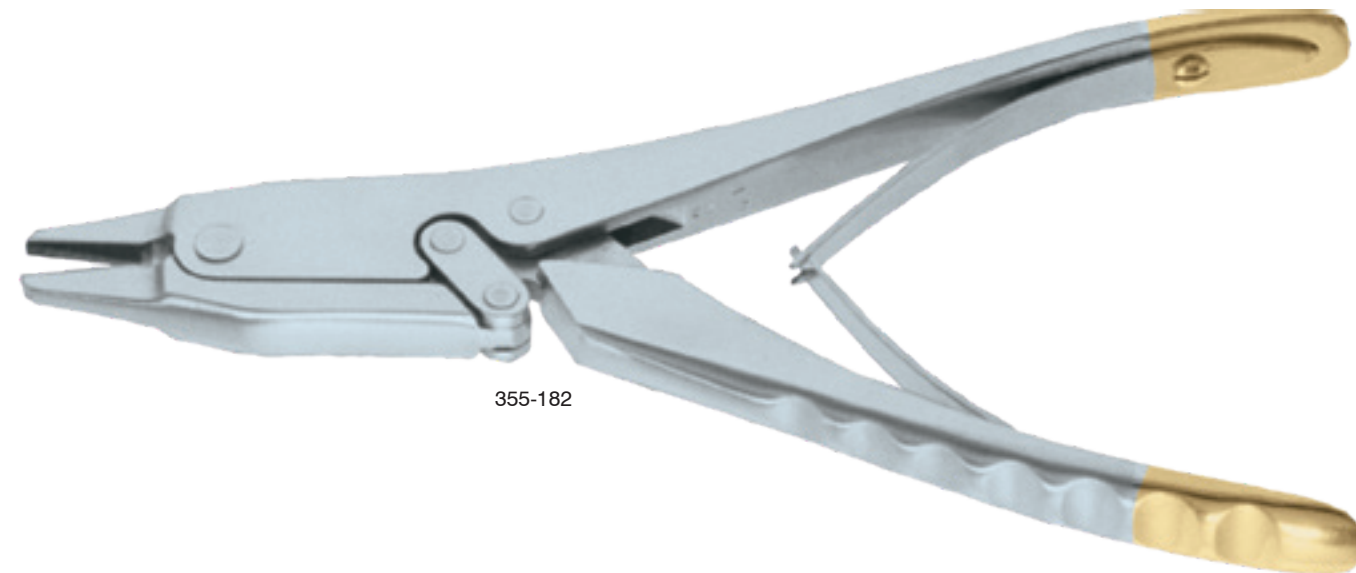



 Sontec Instruments®

Orthopedic PLATE BENDERS & BENDING IRONS

**Mini Plate Bending Iron**

Small plates / bends plates 1.5 and smaller / 4 3/4" (12 cm)

1106-197



1106-197

**Small Plate Bending Iron**

Used in pairs / 5 1/2" (14 cm)

1106-200 bends plates 2.7 mm  
1106-205 bends plates 3.5 mm



1106-200



1106-205

**Standard Plate Bending Iron**

Bends standard plates / with four rod holes / 9 1/2" (24 cm)

1106-210



1106-210

**Plate Bending Iron**

Bends plates laterally / 2.7 mm contours plates / use in pairs / 6 1/4" (16 cm)

1106-207



1106-207

**Plate Bending Iron Lateral & Contour**

Bends plates 3.5 mm & 4.5 mm / 7 1/2" (19 cm)

1106-212



1106-212

**Plate Bending Pliers**

Rotatable anvil

355-244 10" (25 cm)



355-244

**Plate Bending Table Top Press**

Bends plates up to 6 mm / rotatable anvil / 17" (43 cm) in length

1106-185



1106-185

**Lateral Plate Bending Pliers**

Bends 2.7 mm x 3.5 mm / contours plates /  
10 1/4 (26 cm)

355-245



355-245

**Whale Nose Plate Bending Pliers**

Bends small plates up to 2.7 mm / 7 3/4" (19.5 cm)  
355-230

Bends large plates up to 3.5 mm / 9 1/2" (24 cm)  
355-235



**AO Type Bending Pliers Set**

For straight plates / with 2 anvils / 10" (25.4 cm)  
/ comes with 355-236N & 355-236B  
355-236-SET

**Plates for Bending Pliers**

- 355-236A for small plates
- 355-236B for broad plates
- 355-236N for narrow plates



355-236A



355-236B



355-236N





 Sontec Instruments®

Orthopedic RETRACTORS

**Gelpi Deep Angle Retractor**

- 1100-629A 3 1/2"(9 cm)
- 1100-628A 4 1/2"(11.5 cm)
- 1100-628C 5 1/2"(14 cm)
- 1100-631 6 3/4"(17.5 cm)
- 1100-631S 6 3/4"(17.5 cm)
- 4.5 mm prong 3 cm deep
- 1100-631A 7 1/2"(19 cm)
- 1100-631B 8" (20 cm)

\* Custom blunt or shortened tips available upon request



1100-628C

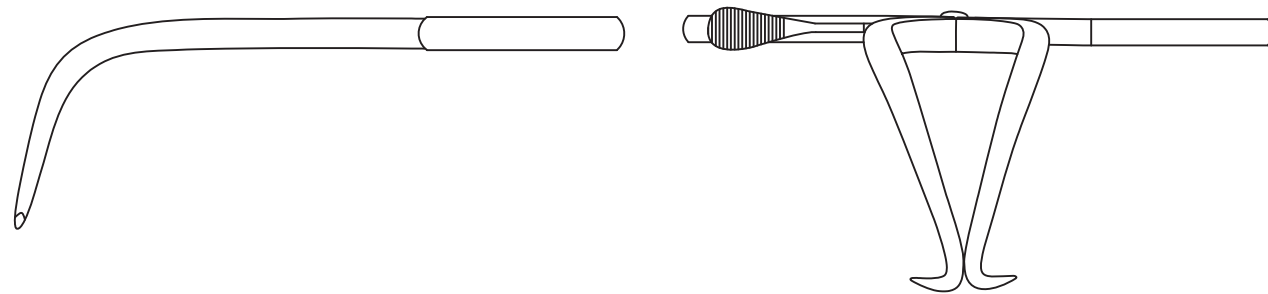

**Gelpi Retractor**

Deep half angle / 7 1/2" (19 cm)

- 1100-6315 sharp
- 1100-6317 blunt

\* Custom blunt or shortened tips available upon request

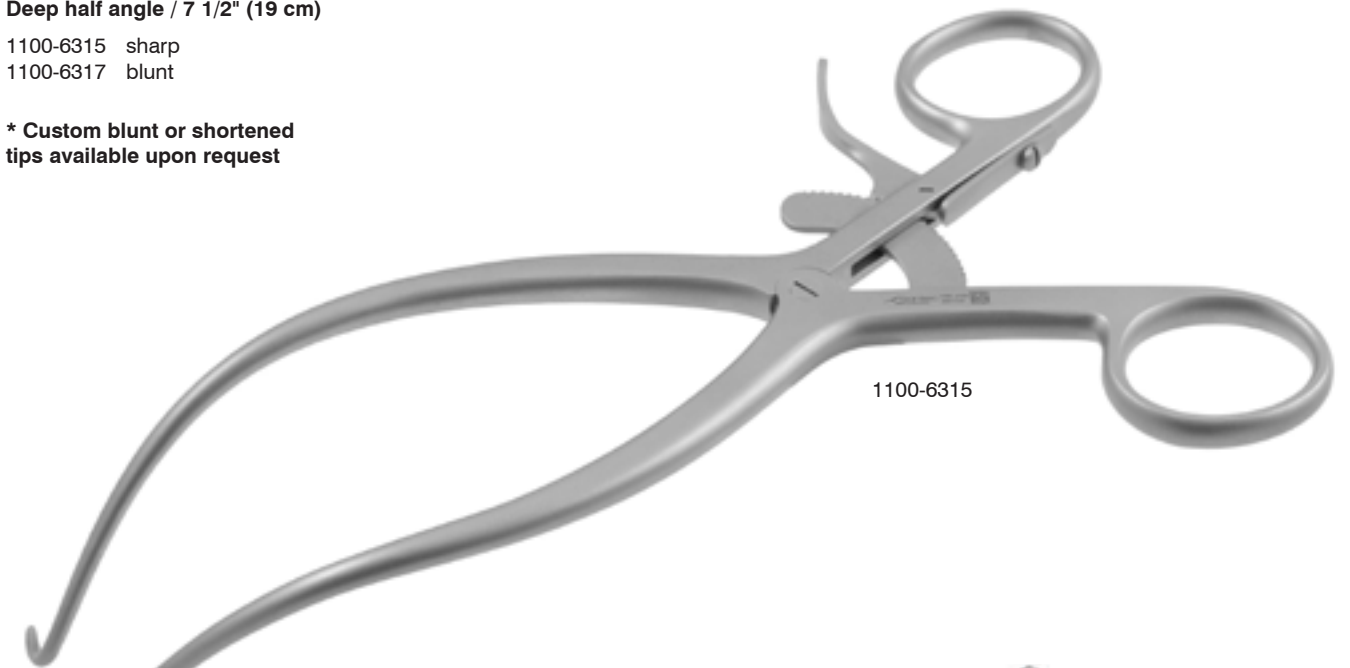

1100-6315

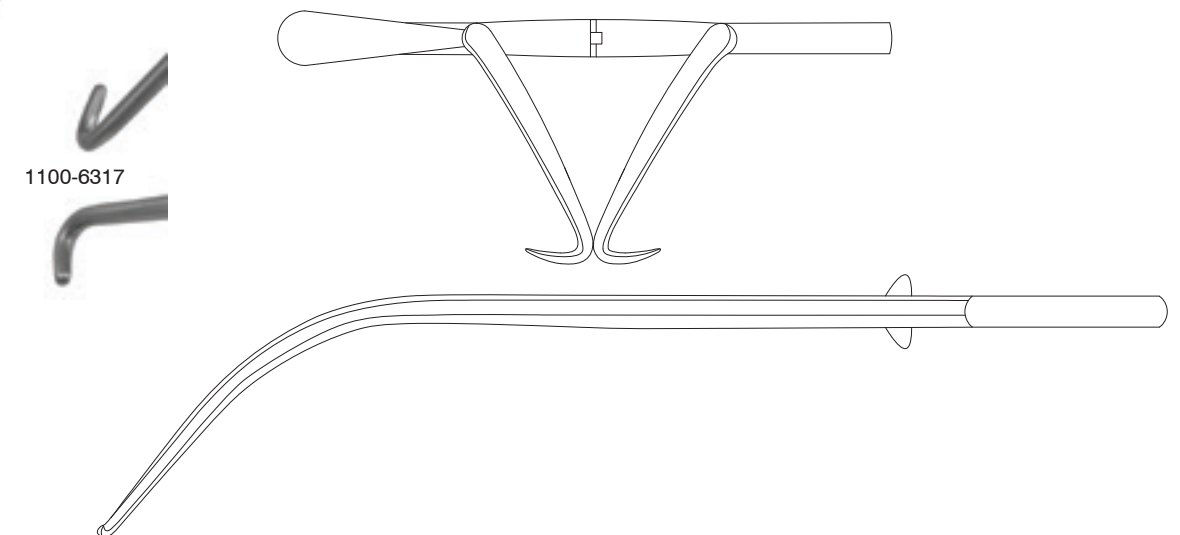

1100-6317

**Gelpi Neroma (Crossover) Retractor**

1100-633A	4 1/2" (11.5 cm)	
1100-633B	3 1/2" (9 cm)	
1100-633	5 1/2" (14 cm)	
1100-633C	6 1/2" (16.5 cm)	
1100-633D	7 1/2" (19 cm)	
1100-633E	3 1/2" (9 cm)	heavy

**Enclosed ratchet version**

1100-633BR	3 1/2" (9 cm)
------------	---------------

\* Custom blunt or shortened tips available upon request



enclosed ratched



1100-633A

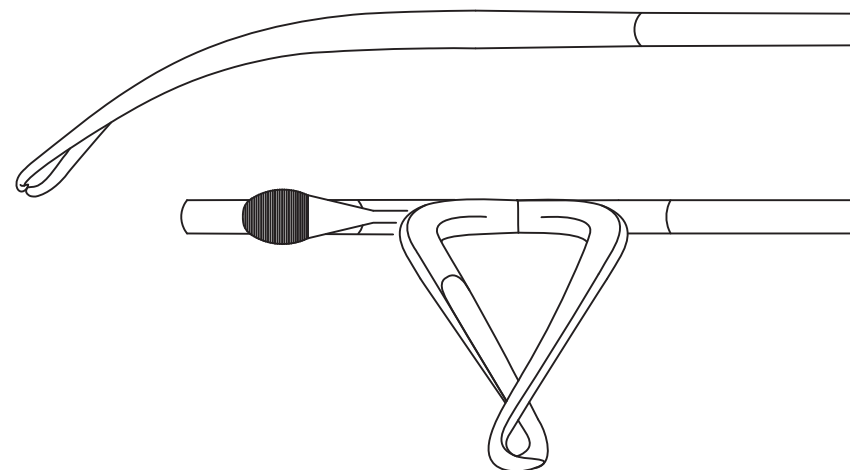

**Gelpi Deep Angle Neroma (Crossover) Retractor**

**Deep angle**

1100-633H	3 1/2" (9 cm)
1100-633G	4 1/2" (11.5 cm)
1100-633F	5 1/2" (14 cm)
1100-633I	6 1/2" (16.5 cm)
1100-632R	6 3/4" (17.5 cm)
1100-630N	7 1/2" (19 cm)
1100-631N	8" (20 cm)

**Enclosed ratchet / deep angle**

1100-633HR	3 1/2" (9 cm)
1100-633GR	4 1/2" (11.5 cm)
1100-633FR	5 1/2" (14 cm)

\* Custom blunt or shortened tips available upon request



enclosed ratched



1100-633G

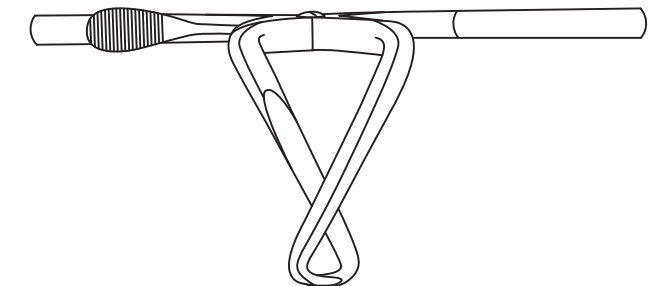
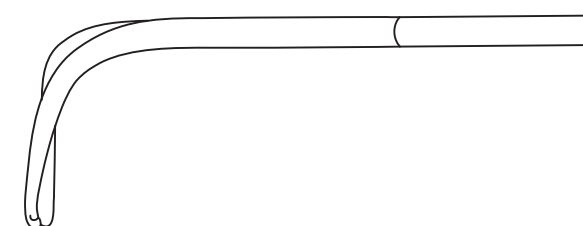

**Gelpi Classic Retractor**

2 cm across / angle medium blunt tips / 6" (15.2 cm)

1100-632AB

\* Custom blunt or shortened tips available upon request

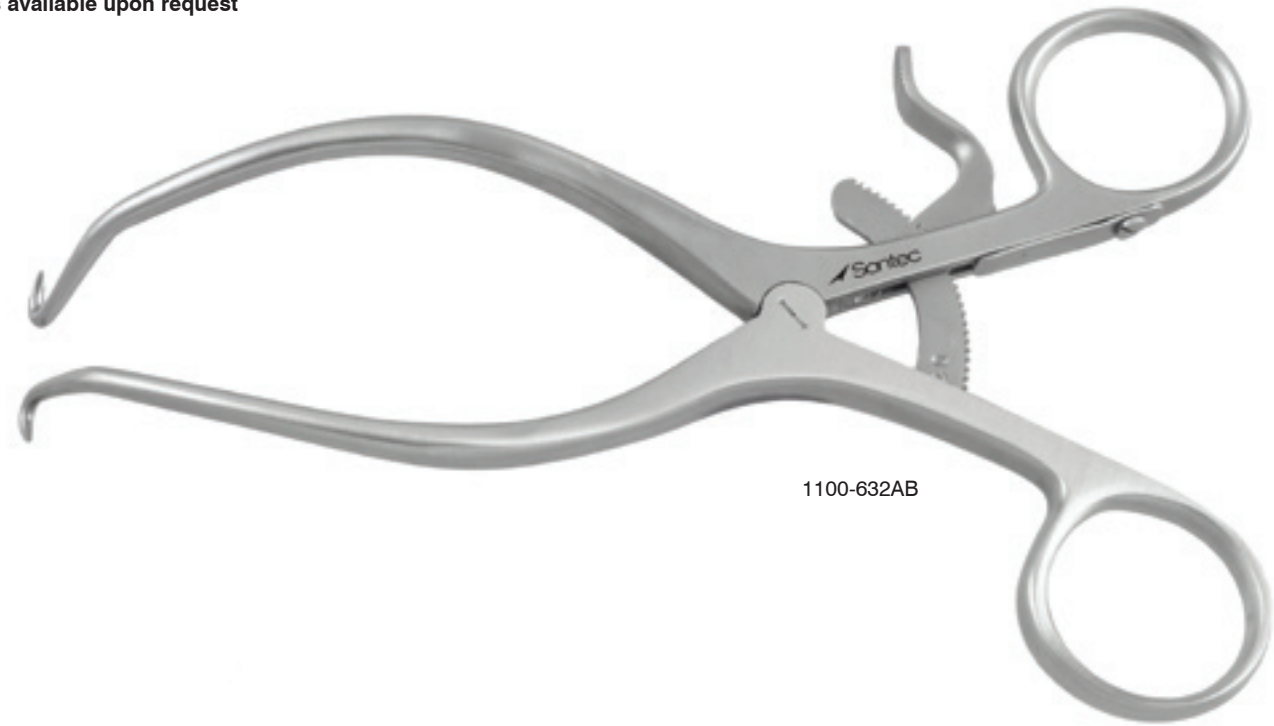

1100-632AB

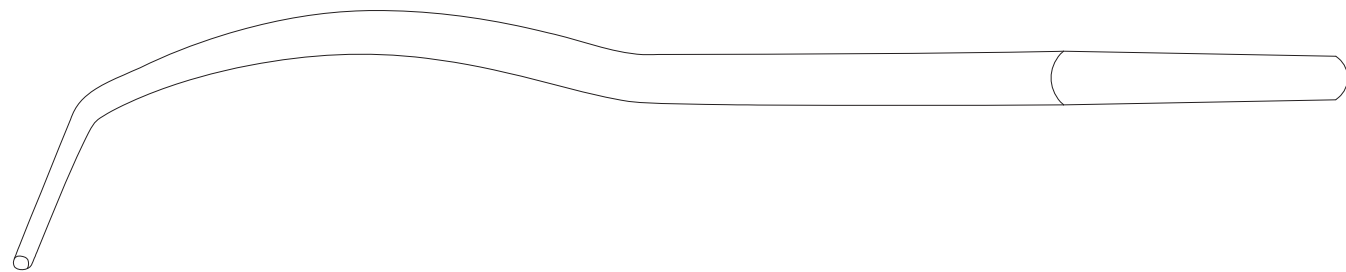
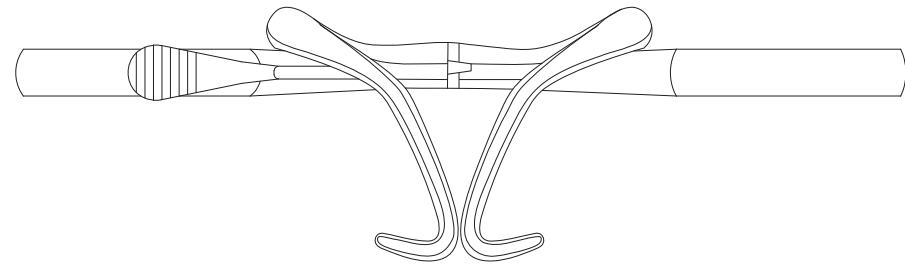

**Gelpi Classic Retractor**

**Standard**

1100-629	3 1/2" (9 cm)	micro
1100-629L	3 1/2" (9 cm)	lightweight
1100-628	3 3/4" (9.5 cm)	heavy
1100-629B	4 1/2" (11.5 cm)	
1100-6280	4 1/2" (11.5 cm)	heavy
1100-628B	5 1/2" (14 cm)	
1100-632	6 1/2" (16.5 cm)	
1100-630	7 1/2" (19 cm)	
1100-630A	8" (20 cm)	

\* Custom blunt or shortened tips available upon request

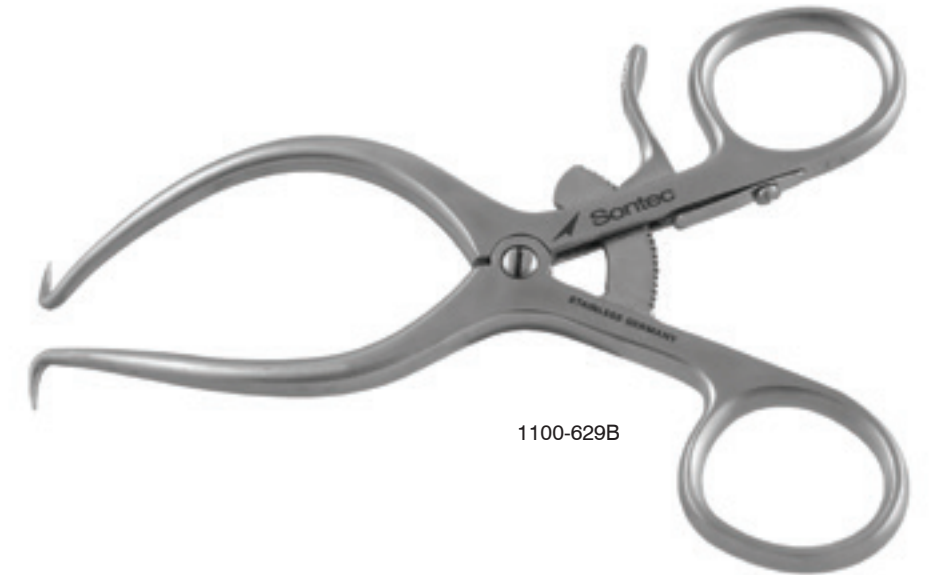

1100-629B

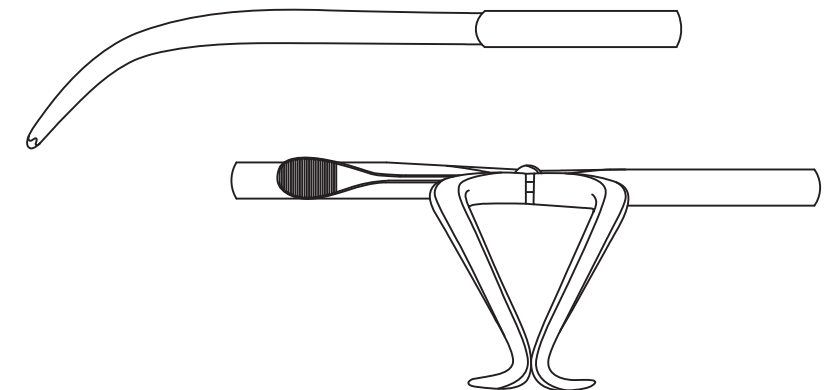

**Gelpi Retractor**

Enclosed ratchet / 7 1/2" (19.1 cm)

1100-630ER

\* Custom blunt or shortened tips available upon request



1100-630ER



**Gelpi Retractor**

Angle medium blunt tips / with enclosed ratchet

1100-632ABR-7 2 cm deep angle 7"

1100-632ABR-8 3 cm deep angle 8"

\* Custom blunt or shortened tips available upon request

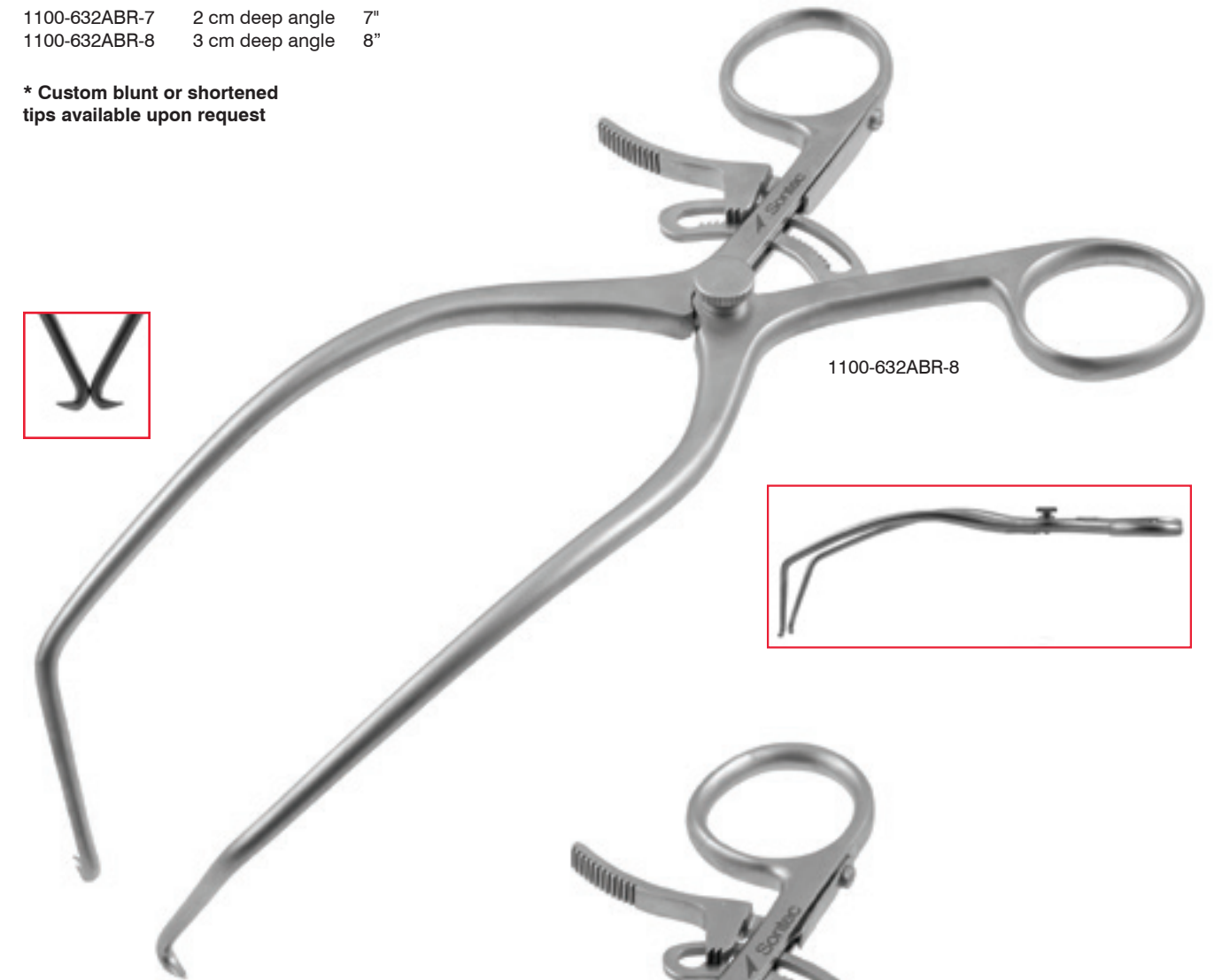

1100-632ABR-8

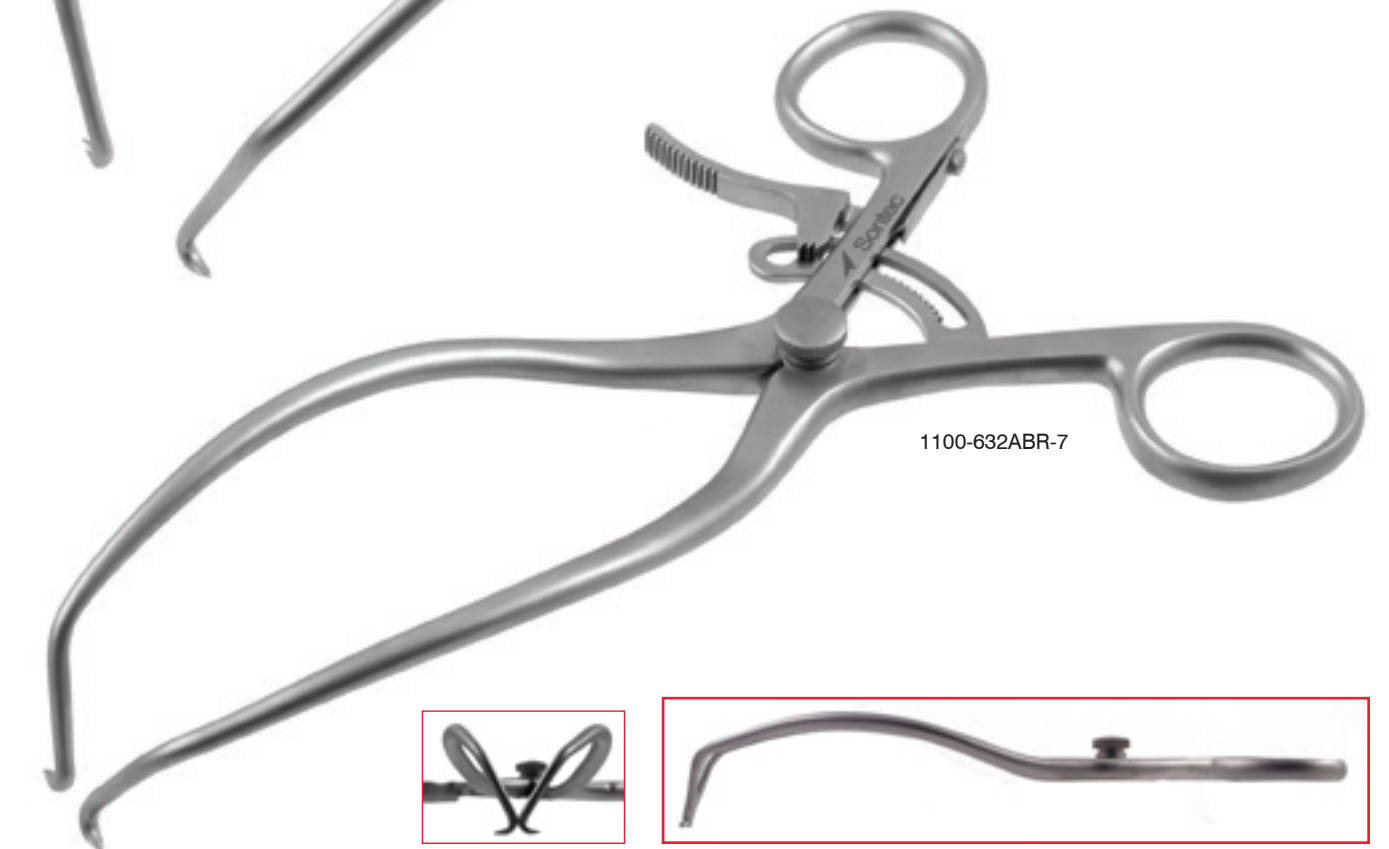

1100-632ABR-7



**Gelpi 1st Generation Deep Angle Retractor**

**Original deep angle**

1100-629G	3 1/2" (9 cm)
1100-628G	4 1/2" (11.5 cm)
1100-632G	5 1/2" (14 cm)
1100-631G	6 1/2" (16.5 cm)
1100-630G	7 1/2" (19 cm)

**Original deep angle with enclosed ratchet**

1100-629GR	3 1/2" (9 cm)
1100-628GR	4 1/2" (11.5 cm)
1100-632GR	5 1/2" (14 cm)
1100-631GR	6 1/2" (16.5 cm)
1100-630GR	7 1/2" (19 cm)

\* Custom blunt or shortened tips available upon request

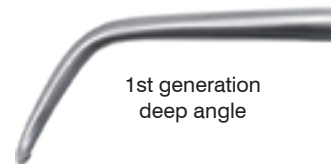

1st generation deep angle



1100-628G



1100-629GR

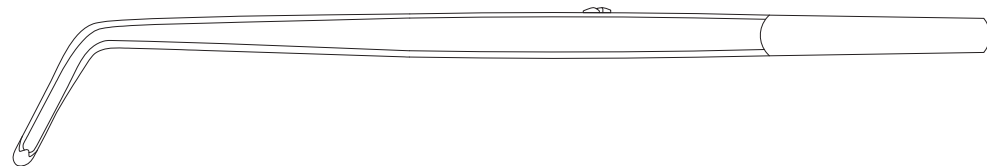
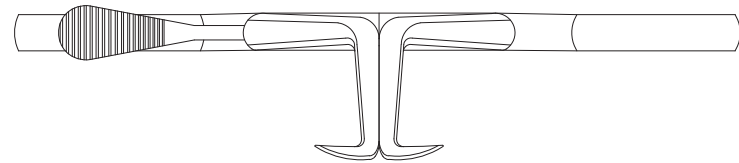

**Gelpi Offset Arm Left & Right**

**3 1/2"**

1100-6332	left 5/8" (17mm) x 1" (25mm)
1100-6333	right 1" (25mm) x 5/8" (17mm)

**4 1/2"**

1100-6282	left 7/8" (22mm) x 1 1/4" (32mm)
1100-6283	right 1 1/4" (32mm) x 7/8" (22mm)

**5 1/2"**

1100-6292	left 1" (25mm) x 1 1/2" (38mm)
1100-6293	right 1 1/2" (38mm) x 1" (25mm)

**6 1/2"**

1100-6312	left 1 5/8" (42mm) x 2 1/8" (53mm)
1100-6313	right 2 1/8" (53mm) x 1 5/8" (42mm)

**7 1/2"**

1100-6322	left 1 1/4" (32mm) x 2 1/4" (57mm)
1100-6323	right 2 1/4" (57mm) x 1 1/4" (32mm)

**8"**

1100-6334	left 2" (51mm) x 2 1/2" (67mm)
1100-6335	right 2 1/2" (67mm) x 2" (51mm)

\* Custom blunt or shortened tips available upon request



1100-6322

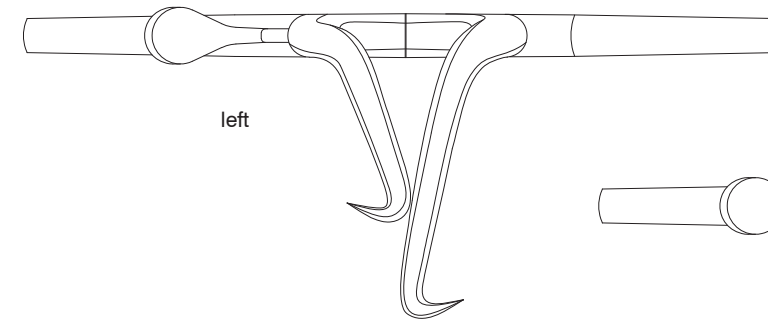

left

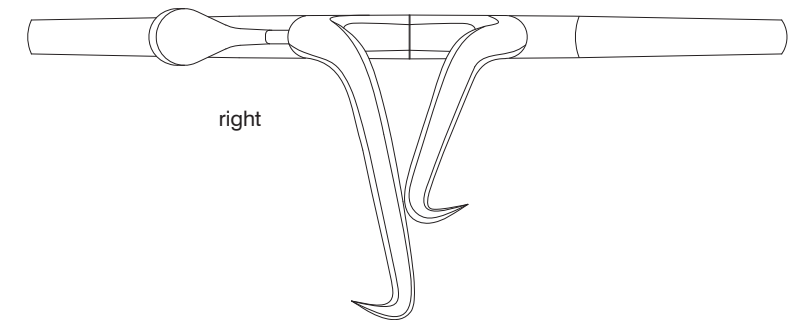

right

**Gelpi Retractor**

Parallel prongs with blunt tips / 6 1/2" (16.5 cm)  
1100-631M

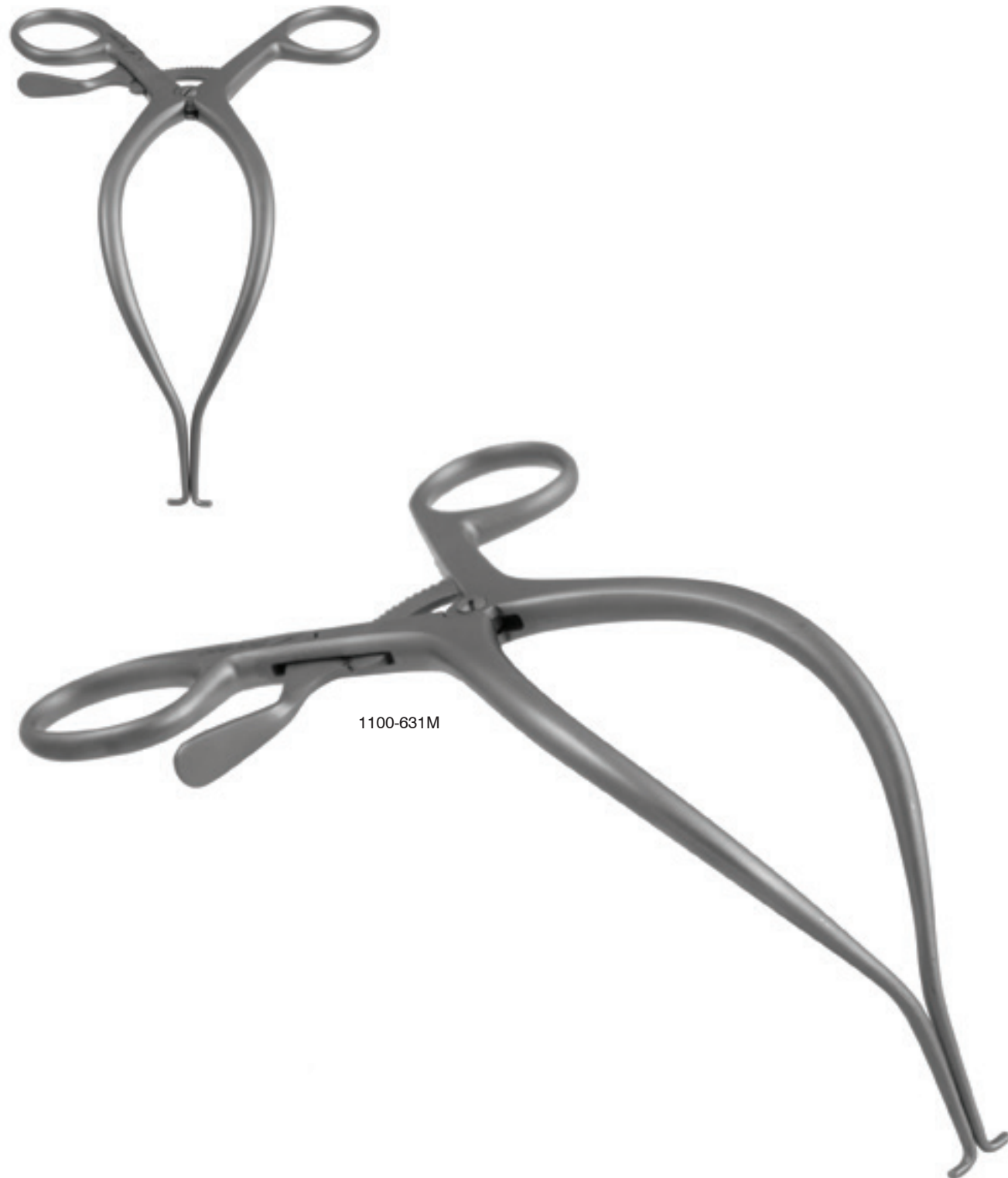

**Foremann Kwire Distractor**

417-062	small closed arms	6"
417-062A	small outspread arms	6"
417-062B	large closed arms	8 1/4"
417-062C	large outspread arms	8 1/4"

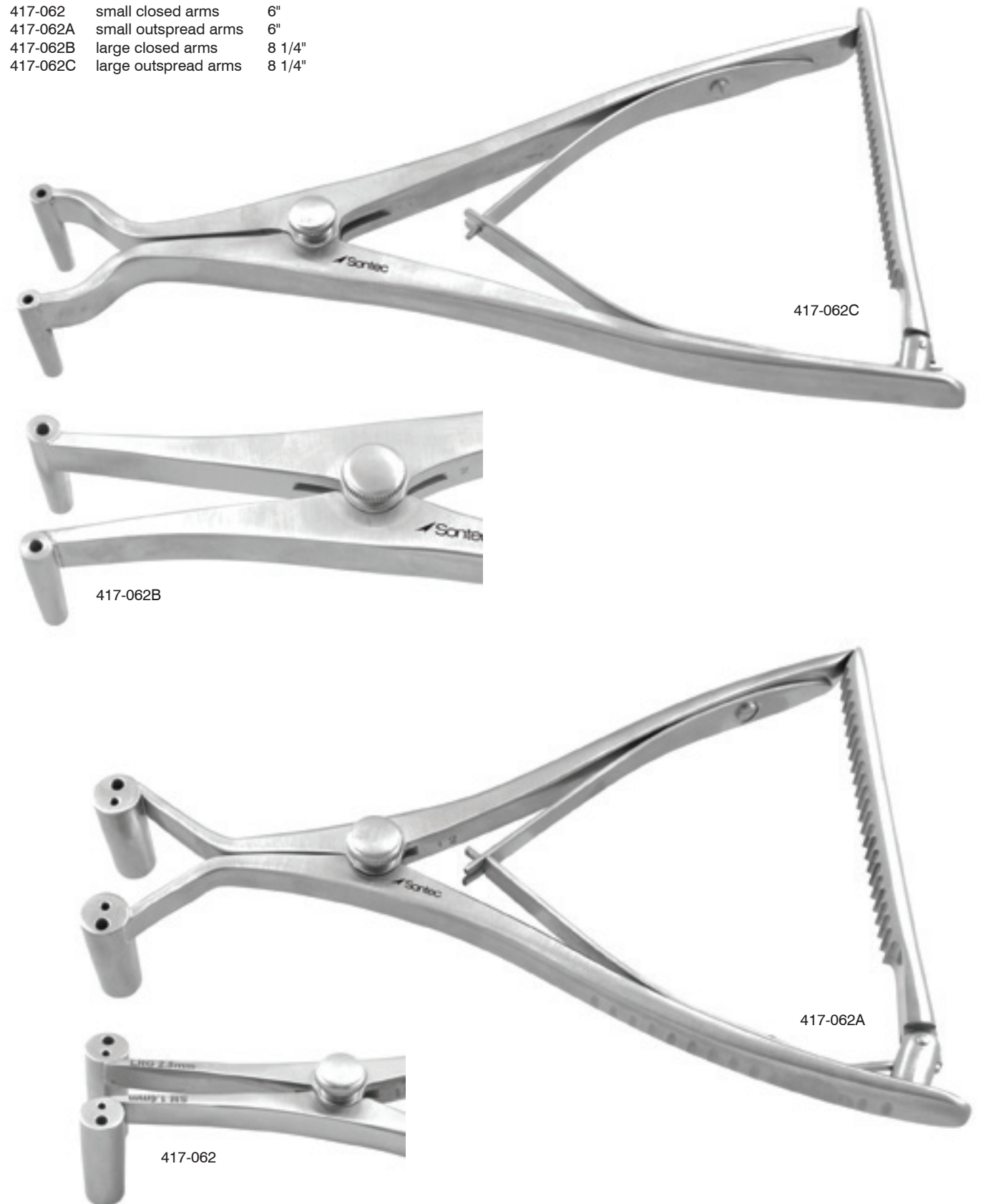

**Foremann Kwire Distractor**

Tapered arms / 7 1/2" (19.1 cm)

417-062D



417-062D

**Mini Foremann Distractor**

Tapered arms / 5" (12.7 cm)

417-061



417-0621

**Davis Stifle Retractor**

With speed lock / 6 3/4" (17 cm)  
1103-290

\* Custom blunt or shortened tips available upon request



1103-290

**Allen Inge Stifle Retractor**

With speed lock / 11" (27.9 cm)  
1103-297

\* Custom blunt or shortened tips available upon request



1103-297

**Inge Neroma Retractor**

With crossover tip / 6 1/2" (16.5 cm)  
417-048 with speedlock  
417-048R with ratchet

\* Custom blunt or shortened tips available upon request



417-048



417-048R

**Mini Inge Neroma Retractor**

With crossover tip / speed lock / 5" (12.7 cm)

417-0482

\* Custom blunt or shortened tips available upon request



417-0482

**Mini Inge Neroma Ceramitec Retractor**

With crossover tip / speed lock / 5" (12.7 cm)

417-0482B

\* Custom blunt or shortened tips available upon request



417-0482B

**Wellace Stifle Retractor**

Improved retraction / turn-key action

1100-635 standard

1100-635C crossover style



1100-635



1100-635C

**Sisson Spring Retractor**

Sharp / 1 x 1 prongs / with ratchet / 4" (10 cm)

220-114

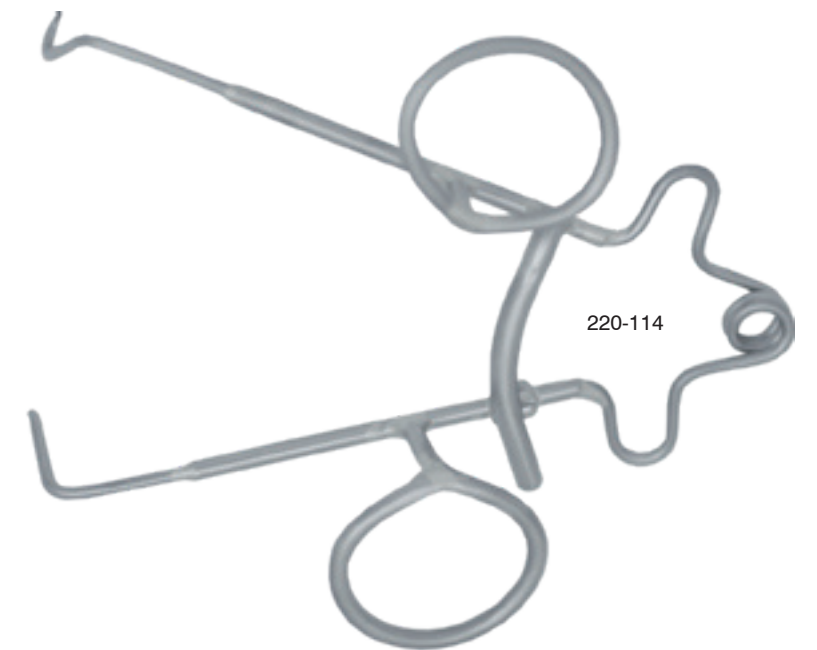

220-114

**Vickers Self-Retaining Retractor**

220-220	solid blades	3 1/8 (8 cm)
220-222	2 blunt blades	2 7/8 (7 cm)
220-224	3 blunt blades	3 1/2 (9 cm)

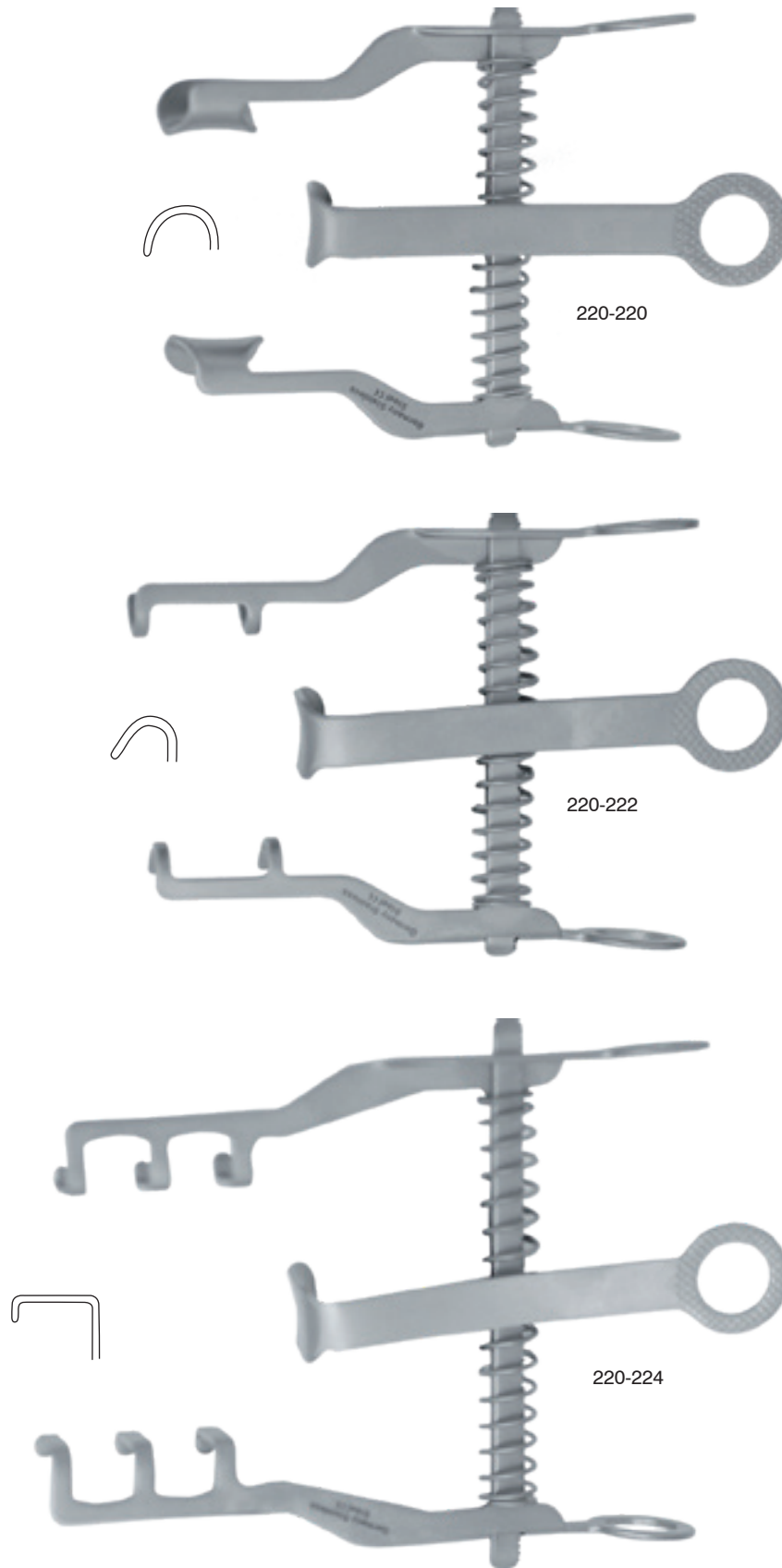

**Finsen Self-Retaining Retractor**

**2 x 3 prongs**

220-128	sharp	2" (5 cm)	
220-126	blunt	2" (5 cm)	
220-136	blunt	3 1/8" (7.5 cm)	

**3 x 4 prongs**

220-132	sharp	2 3/4" (7 cm)	
220-130	blunt	2 3/4" (7 cm)	
220-140	sharp	2 3/4" (7 cm)	with adjustment screw
220-138	blunt	2 3/4" (7 cm)	with adjustment screw

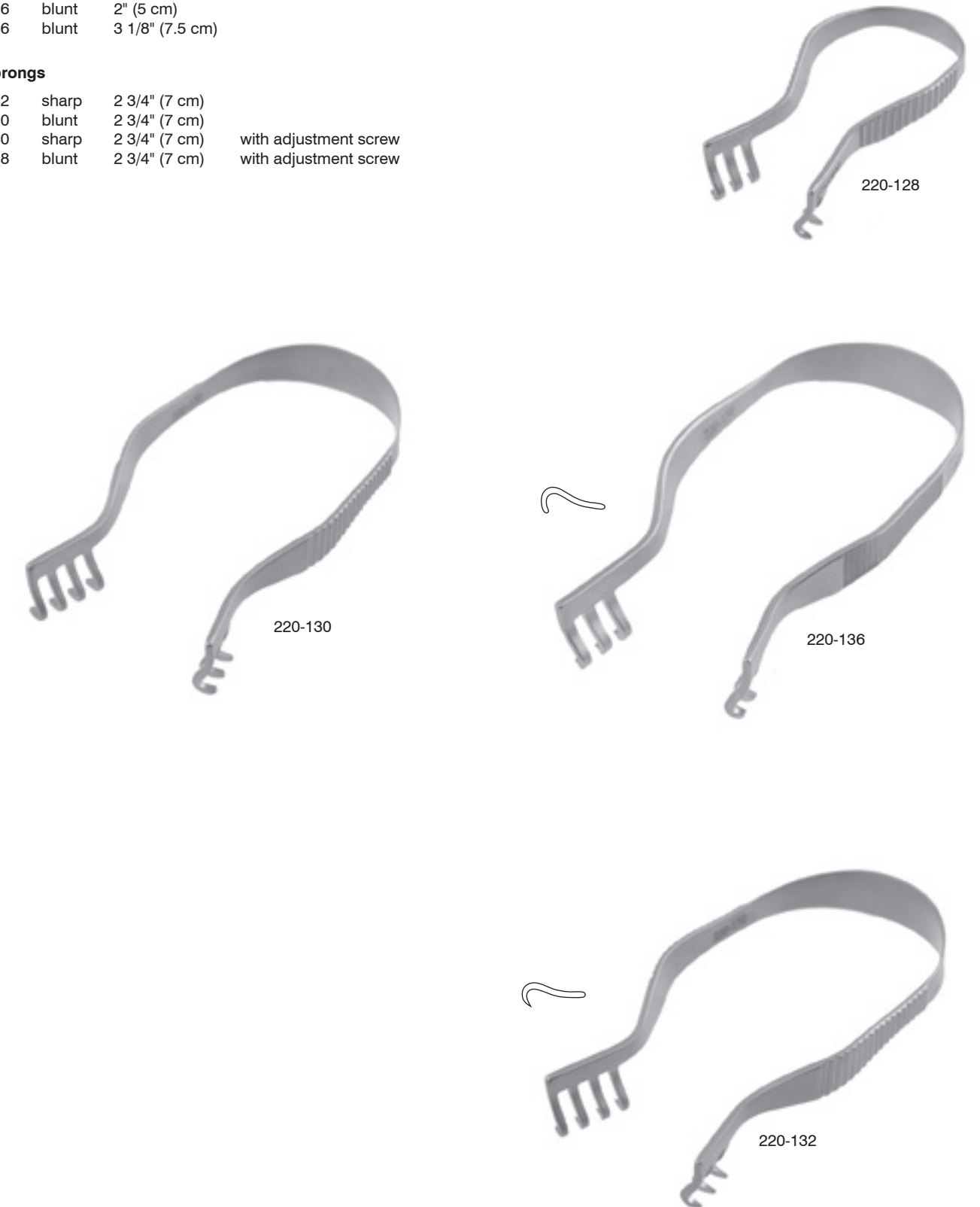

## Charnley Initial Incision Retractor

### Round frame set

9-15-450-02-SET

Complete set includes the following:

9-15-452-20	round frame	
9-15-452-02	small blade	25mm x 65mm
9-15-452-08	large blade	25mm x 50mm
9-15-452-12	weight with chain	

### Square frame set

9-15-460-02-SET

Complete set includes the following:

9-15-462-20	square frame	
9-15-462-02	small blade	25mm x 38mm
9-15-462-08	large blade	25mm x 44mm
9-15-462-12	weight with chain	

### Additional blades are also available

#### Small blades

9-15-462-18	25mm x 25mm
9-15-462-21	25mm x 50mm
9-15-462-23	25mm x 57mm
9-15-462-22	25mm x 63mm
9-15-462-07	25mm x 75mm
9-15-462-14	25mm x 101mm
9-15-462-16	25mm x 127mm
9-15-462-27	25mm x 114mm

#### Large blades

9-15-462-19	25mm x 25mm
9-15-462-26	25mm x 50mm
9-15-462-24	25mm x 57mm
9-15-462-09	25mm x 63mm
9-15-462-13	25mm x 75mm
9-15-462-15	25mm x 101mm
9-15-462-17	25mm x 127mm
9-15-462-28	25mm x 114mm

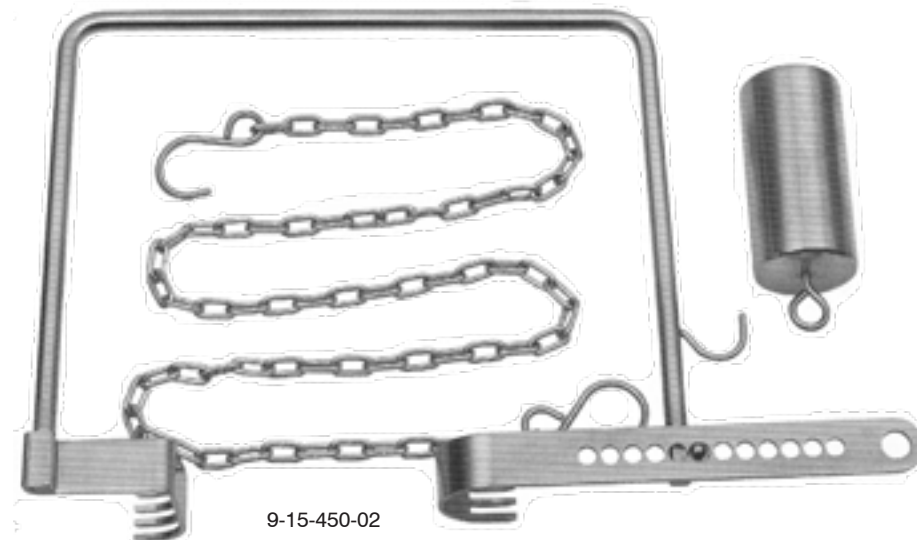

9-15-450-02

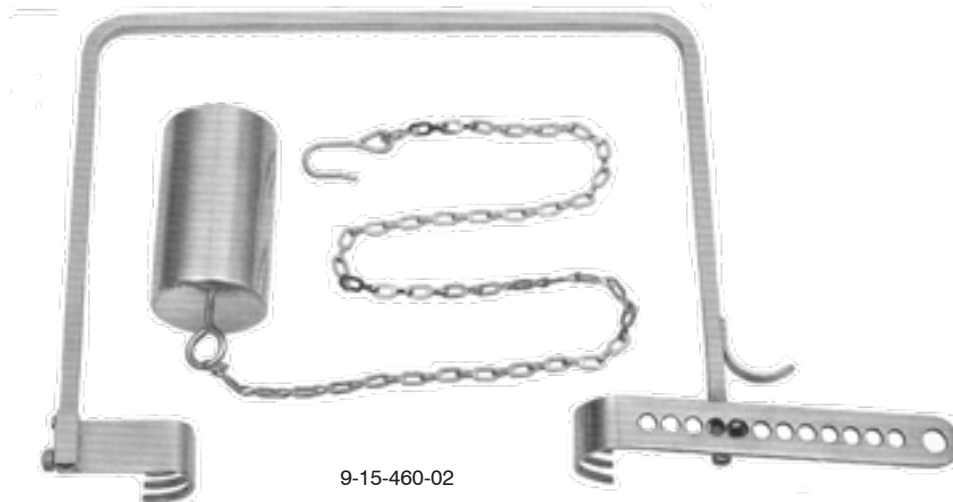

9-15-460-02

## Slocum Type Army Navy Retractor

### Double ended

6 1/2" (16.5 cm)

207-259



207-259

## Taylor Spinal Retractor

### 7 1/4" (18.5 cm)

417-070 1 1/4" x 3" blade

### 8" (20.5 cm)

417-072 1 1/4" x 4" blade



417-072

## Kujat Shoulder Retractor

207-520 30 mm blade

207-525 35 mm blade



207-520

**Murphy-Lane Bone Skid**

Double ended / 1 1/4" cup & 3/4" cup / 12" (30.5 cm)

310-160



310-160

**Aufranc Cobra Retractor**

10 1/2" (26 cm)

- 1100-682 sharp serrated tip
- 1100-684 blunt serrated tip
- 1100-686 blunt smooth tip
- 1100-687 pointed smooth tip

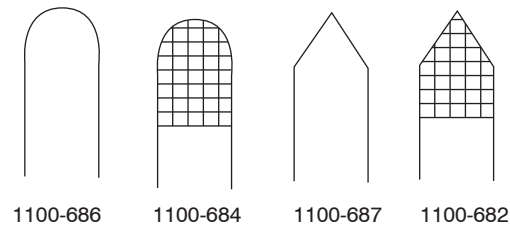

1100-686

**Sontec Stifle Thrust Lever**

- 1100-6691 8 3/8"
- 1100-6692 11"



1100-6691

1100-6692

**Lahey Retractor**

7 3/4" (20 cm)

207-300



207-300

**Mathieu Retractor**

Set of 2 / double ended / 1 end with 2 prongs / 8" (20.3 cm)

207-254



207-254

**Hibbs Retractor**

Sharp teeth / 9 1/4" (23.5 cm)

- 207-389 25 mm w x 50 mm d
- 207-390 26 mm w x 75 mm d
- 207-391 25 mm w x 100 mm d



207-389



207-390



207-391

**Meyering Retractor**

- 207-415 large blade 3 1/2" x 2" x 9 1/2"
- 207-413 medium blade 3" x 1" x 9 1/2"
- 207-411 small blade 2" x 5/8" x 9 1/2"



207-413



207-415

**Malleable Ribbon Retractor**

Hollow Grip Handle

- 207-482 3/4" wide blade
- 207-484 1" wide blade
- 207-486 1 1/4" wide blade
- 207-488 1 1/2" wide blade
- 207-490 2" wide blade



207-486



207-488



207-490

**Malleable Ribbon Retractor**

**Malleable**

- 207-454 1/4" x 7"
- 207-455 3/8" x 7"
- 207-456 1/2" x 7"
- 207-460 5/8" x 7"
- 207-461 3/4" x 7"
- 207-462 1" x 7"
- 207-463 3/4" x 13"
- 207-464 1" x 13"
- 207-465 1 1/4" x 13"
- 207-466 1 1/2" x 13"
- 207-467 2" x 13"
- 207-468 2 1/2" x 13"
- 207-469 3" x 13"
- 207-470 3 1/2" x 13"
- 207-471 4" x 13"
- 207-472 5" x 13"
- 207-474 1 3/4" x 13"
- 207-473 2 3/4" x 13"



207-454



207-462



207-465



207-468

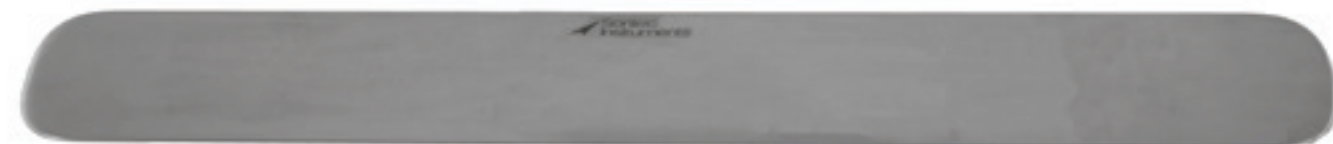

207-474



207-473

**Volkman Retractor**

**Sharp / 4 1/2" (11.5 cm)**

- 1100-648 2 prong
- 1100-650 3 prong
- 1100-652 4 prong
- 1100-654 6 prong



1100-648

**Sharp / 8" (20 cm)**

- 1100-656 2 prong
- 1100-658 3 prong
- 1100-662 6 prong



1100-650

**Sharp / 8 1/2" (22 cm)**

- 1100-660 4 prong



1100-652

**Blunt / 4 1/2" (11.5 cm)**

- 1100-648B 2 prong
- 1100-650B 3 prong
- 1100-652B 4 prong
- 1100-654B 6 prong

**Blunt / 8 1/2" (22 cm)**

- 1100-656B 2 prong
- 1100-658B 3 prong
- 1100-660B 4 prong
- 1100-662B 6 prong

**Sharp / 8 3/4" (23 cm)**

- 214-052 4 prong



1100-660



1100-662



214-052

**Senn Retractor**

Double-ended / 6 1/4" (16 cm)

- 1100-668 sharp
- 1100-668B blunt
- 1100-668T sharp titanium



**Senn Retractor**

Blue electro coated / Double-ended / 6 1/4" (16 cm)

- 1100-669 sharp
- 1100-669B blunt



**Ragnell Retractor**

Double-ended / 6" (15 cm)

- 205-849



**Ragnell Retractor**

Blue coated / double-ended / 6" (15 cm)

- 205-849B



**Richardson Retractor**

9 1/2" overall length / loop grip handle

- 207-338 1" x 3/4"
- 207-340 1" x 1 1/4"
- 207-342 1 1/2" x 1 1/2"
- 207-345 2" x 3/4"



9 1/4" overall length / hollow grip handle

- 207-333 2" x 3/4"

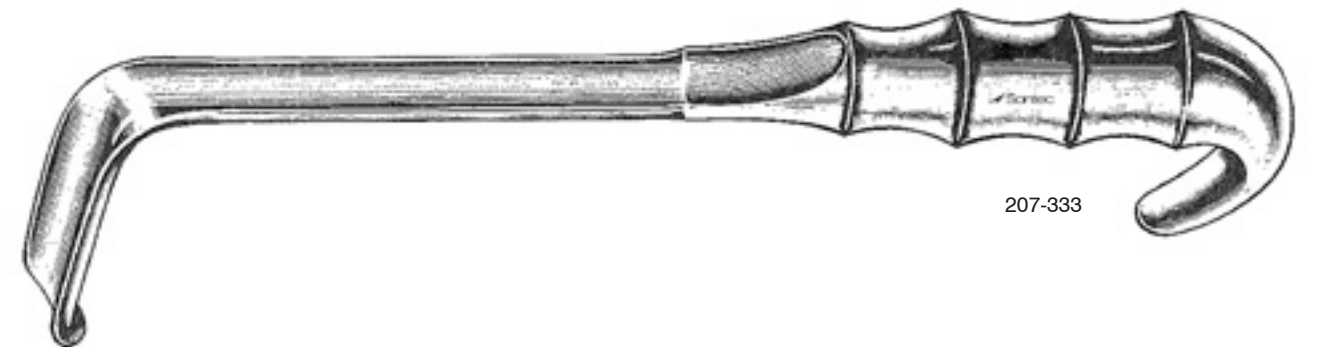

11" overall length / lamb grip handle

- 207-326 1" x 3/4"
- 207-328 1 1/4" x 1"
- 207-330 1 1/2" x 1 1/2"



**Senn Retractor**

Double-ended / 6 1/4" (16 cm)

- 1100-668 sharp
- 1100-668B blunt
- 1100-668T sharp titanium



1100-668B



1100-668T

**Senn Retractor**

Blue electro coated / Double-ended / 6 1/4" (16 cm)

- 1100-669 sharp
- 1100-669B blunt



1100-669



1100-669B

**Ragnell Retractor**

Double-ended / 6" (15 cm)

205-849



205-849

**Ragnell Retractor**

Blue coated / double-ended / 6" (15 cm)

205-849B



205-849B

**Richardson Retractor**

9 1/2" overall length / loop grip handle

- 207-338 1" x 3/4"
- 207-340 1" x 1 1/4"
- 207-342 1 1/2" x 1 1/2"
- 207-345 2" x 3/4"



207-340

9 1/4" overall length / hollow grip handle

- 207-333 2" x 3/4"

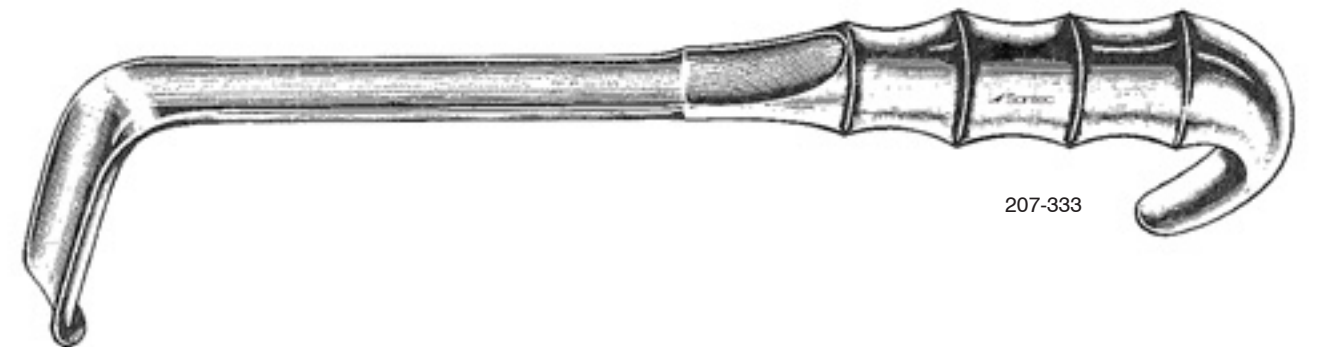

207-333

11" overall length / lamb grip handle

- 207-326 1" x 3/4"
- 207-328 1 1/4" x 1"
- 207-330 1 1/2" x 1 1/2"



207-326

**Richardson-Eastman Retractor**

207-319-SET set of two, one large and one small  
 207-321 small 10" (25 cm)  
 207-323 large 11" (28 cm)



207-319-SET

**Kelly Retractor**

Hollow grip handle / 9 1/2" (24 cm)

207-358 1 1/2" x 2"  
 207-360 2" x 2 1/2"  
 207-362 2 1/2" x 3"  
 207-364 3" x 3 1/2"



207-364

**Kelly Lamb Retractor**

10" overall length

207-350 1 1/2" x 2"  
 207-352 2" x 2 1/2"  
 207-354 2 1/2" x 3"  
 207-356 3" x 3 1/2"



207-350

**U.S. Army-Navy Retractor**

Set of 2 / 8 1/2" (21.5 cm)

1100-670



1100-670

**U.S. Army-Navy Retractor**

Set of 2 / blue electro coated / 8 1/2" (21.5 cm)

1100-670B



1100-670B

**Sontec-Hohmann Elevator Retractor**

**Fenestrated head / 2 prong tip / curved**

310-177 11 1/4" (30 cm) 22 mm tip

**Radically curved head / sharp tip / curved**

310-178 11 1/2" (30 cm) 22 mm tip

**Fenestrated head / proximal tibia type / 2 prong tip / curved**

310-179 12 1/4" (31 cm) 40 mm tip

**Extra long 16" / radically curved head / sharp tip / curved**

310-180 16" (40.5 cm)

**Radically curved contoured head 120° / sharp**

310-182 13" (33 cm) 40mm tip



310-177 310-178 310-179 310-182 310-180

**Sontec-Hohmann Elevator Retractor**

**Extra long tip / C-shaped handle**

310-171 10 1/4" 24 mm tip

**Radically curved / fenestrated head / sharp tip**

310-173 10 1/4" 22 mm tip

**Radically curved / contoured head / sharp tip**

310-174 12" 40 mm tip

**Extra wide tip**

310-176 10 3/4" 33 mm tip



310-171 310-173 310-174 310-176

**Hohman Elevator Retractor**

**8 1/2" (21.5 cm)**

1100-671 8 mm blade

**9 1/4" (23.5 cm)**

1100-672 10 mm blade  
 1100-673 18 mm blade  
 1100-674 25 mm blade  
 1100-675 43 mm blade  
 1100-676 70 mm blade

**9 1/2" (24 cm) / with extra long tip**

1100-671E 8 mm blade  
 1100-672E 10 mm blade  
 1100-673E 18 mm blade



1100-674



1100-675



1100-673E

**Sontec-Hohman Retractor**

**Radical bend / 25 mm tip / 10 1/2" (27 cm)**

1100-677



1100-677

**Mini Hohman Elevator Retractor**

**6 1/4" (16 cm)**

1100-6780 2.5 mm blade  
 1100-679 4 mm blade  
 1100-678 6 mm blade  
 1100-680 8 mm blade



1100-6780



1100-679



1100-678



1100-680



**Sontec Lane Lever Elevator**

**Ring handle style 30-100 lbs**

1100-6696



**Hip & Knee Retractor**

With Handle / 10" (25.5 cm)  
207-405



207-405

**Lead Hand Stabilizing Restrainer**

48-0339 pediatric 9 3/4" (25cm)  
48-0340 adult 14 1/2" (37cm)



48-0340



 Sontec Instruments®

Orthopedic Spinal LAMINA SPREADERS

**Platypus Micro Inge Lamina Spreader**

Platypus tip / 7" (17.8 cm)  
417-049



**Inge Lamina Spreader**

With unique selection of tips /  
adult size / 9 1/2" (24 cm)  
417-060 standard tip  
417-060A tip A  
417-060B tip B  
417-060C tip C  
417-060D tip D  
417-060E tip E

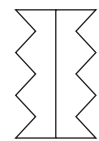

adult standard tip

**Inge Lamina Spreader**

With unique selection of tips / pediatric  
/ 6 1/2" (16.5 cm)

417-064 standard tip  
417-064A tip A  
417-064B tip B  
417-064C tip C  
417-064D tip D micro tip 1mm wide  
417-064E tip E smooth  
417-064F flat delicate, cross  
serrated tips with  
calibrated ratchet

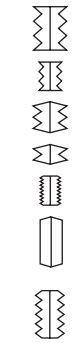

child standard tip

tip A

tip B

tip C

tip D

tip E

tip F



417-064D  
Fine Serrations

417-064A

417-064

417-064E

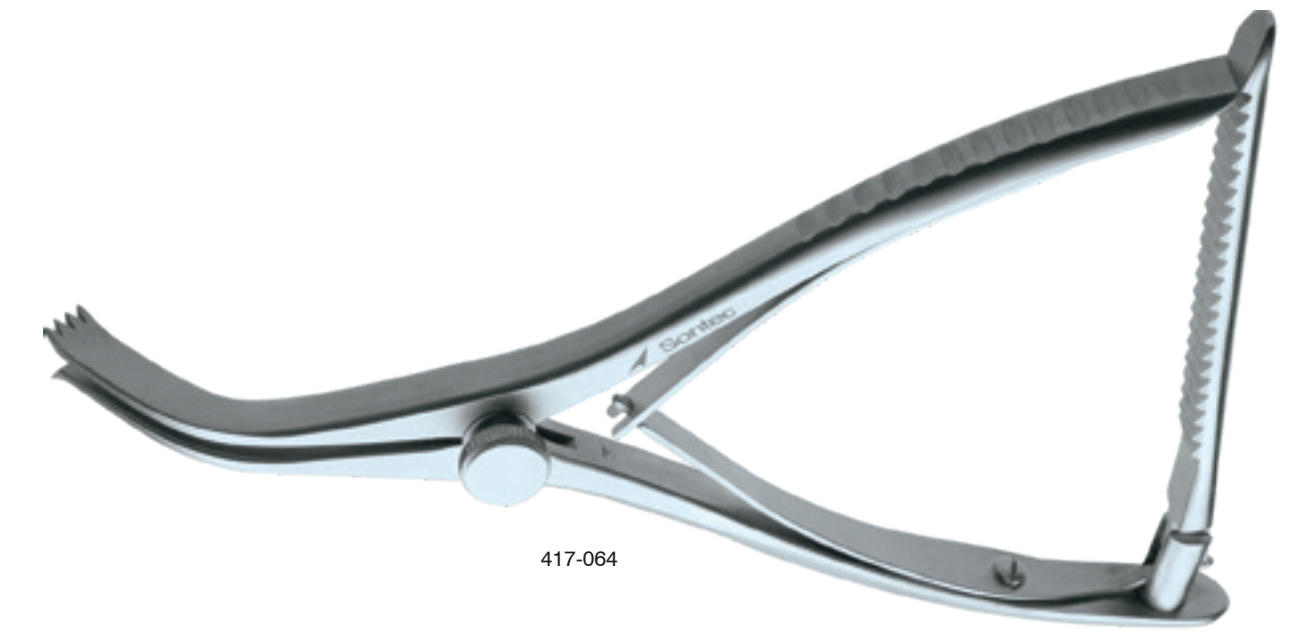
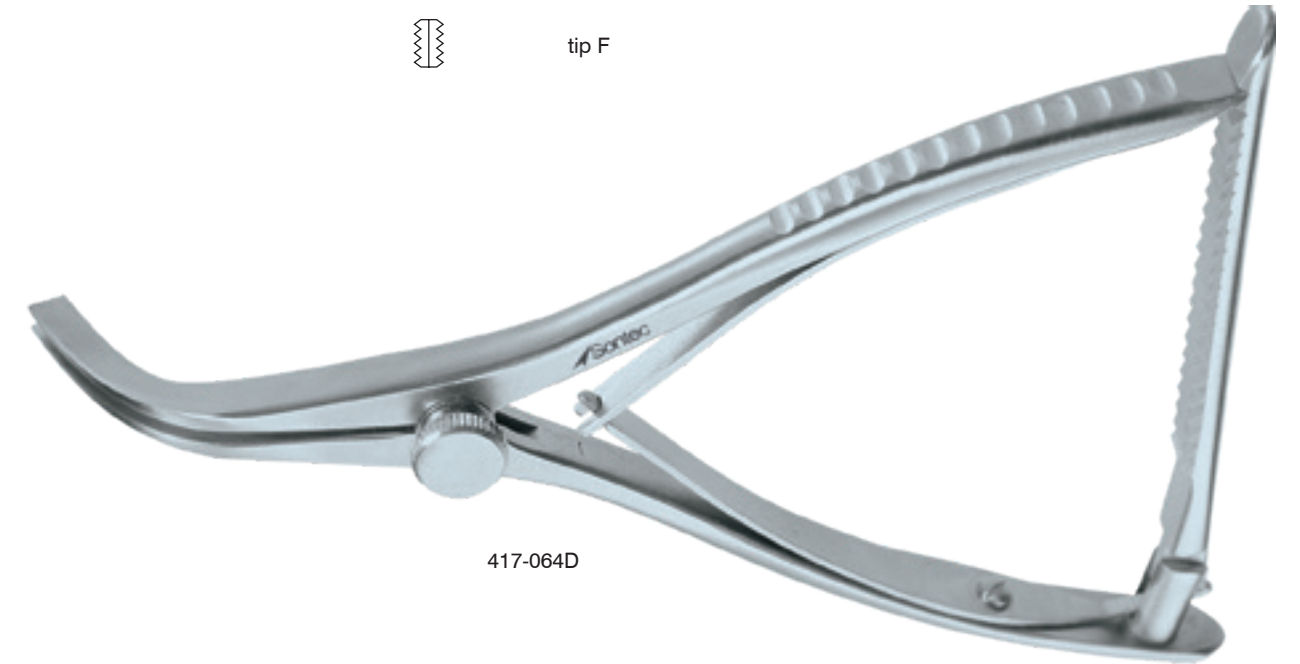

**Micro Inge Lamina Spreader**

“tip D” / with speed lock

417-063 micro 1 mm serrated tips

\* also available with ratchet design



**Inge Lamina Spreader Extra Large Retractor**

Leverage shaped concave blades / 11" (28 cm)

417-057 large 16 mm tip concave jaws

417-056 small 11mm tip

417-056D micro tip 1 mm tip

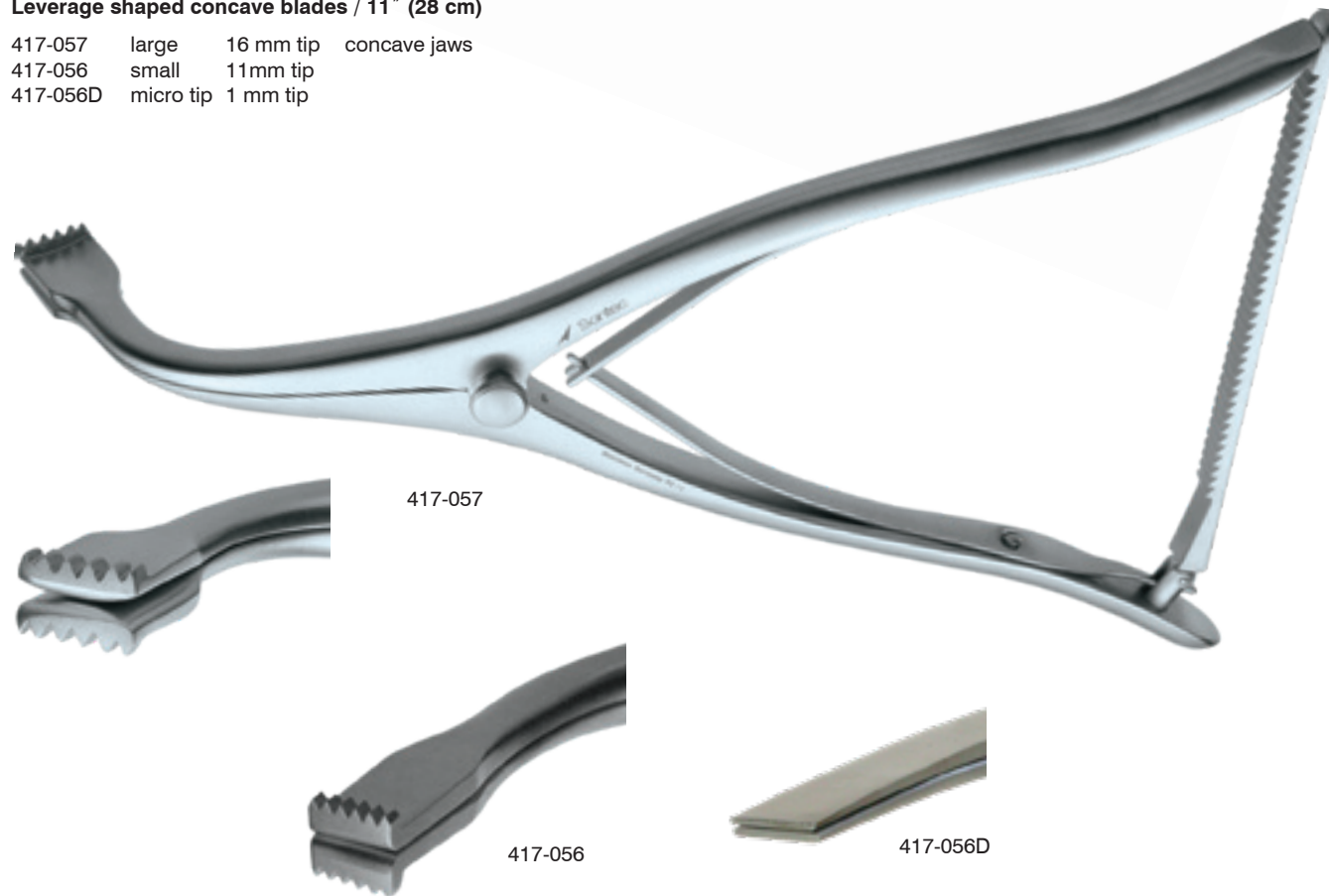

**Inge Micro Ring Handle Lamina Spreader**

With ratchet / 6 1/4" (16 cm)

417-046 4x4 mm tip

417-047 1.5x4 mm tip

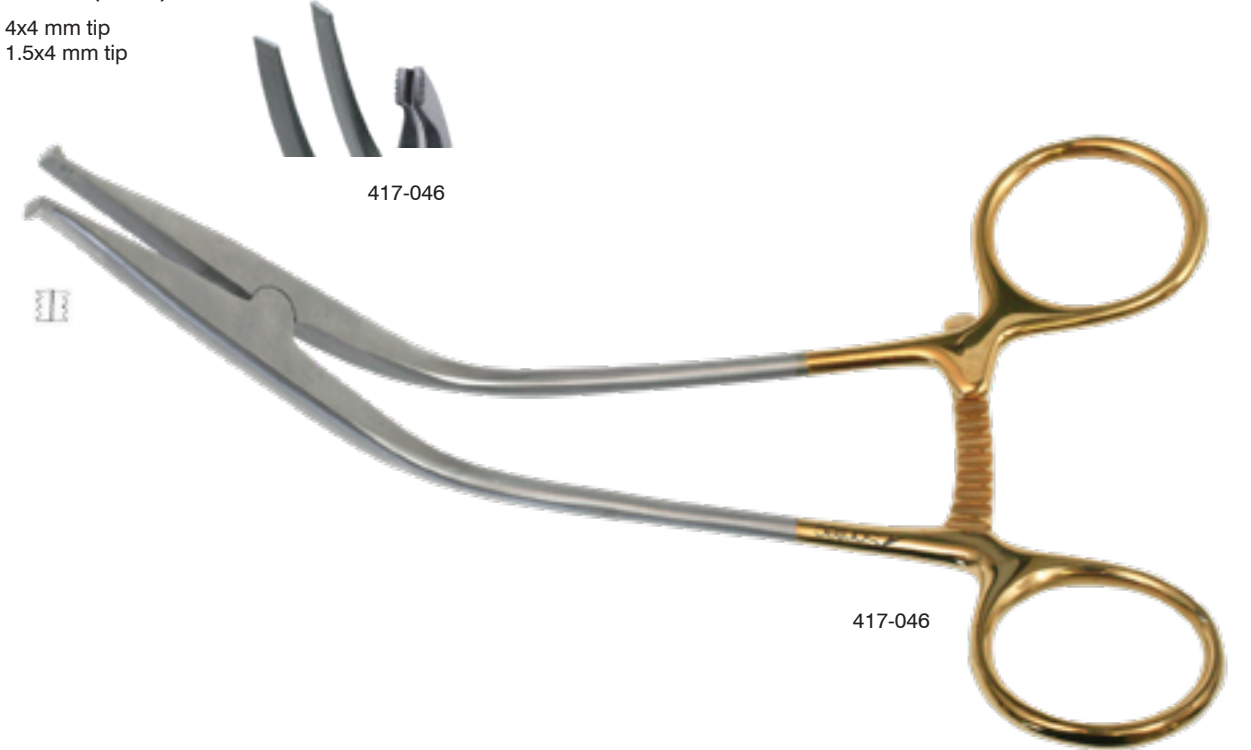

**Cloward Vertebral Cervical Spreader Retractor**

416-137



416-137

**Cloward Lamina Spreader**

52-1301 6 1/4" (15.9 cm)



52-1301

**Inge Lamina Retractor**

**Classic jaws / with speedlock**

417-055	3.5" working length	10 3/4" overall length
417-055L	5" working length	12" overall length
417-055S	1.5" working length	8" overall length

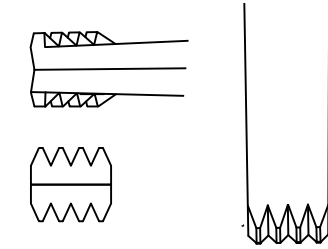

417-055L



417-055S



 Sontec Instruments®

Orthopedic ROD HOLDERS & BENDERS

**Rod Holder Kern Type**

With ratchet / 10" (25.5 cm) / round jaw,  
with threaded hole / holds rods up to 6 mm

355-222

Prism jaw / holds rods 5 mm & 5.5 mm

355-223

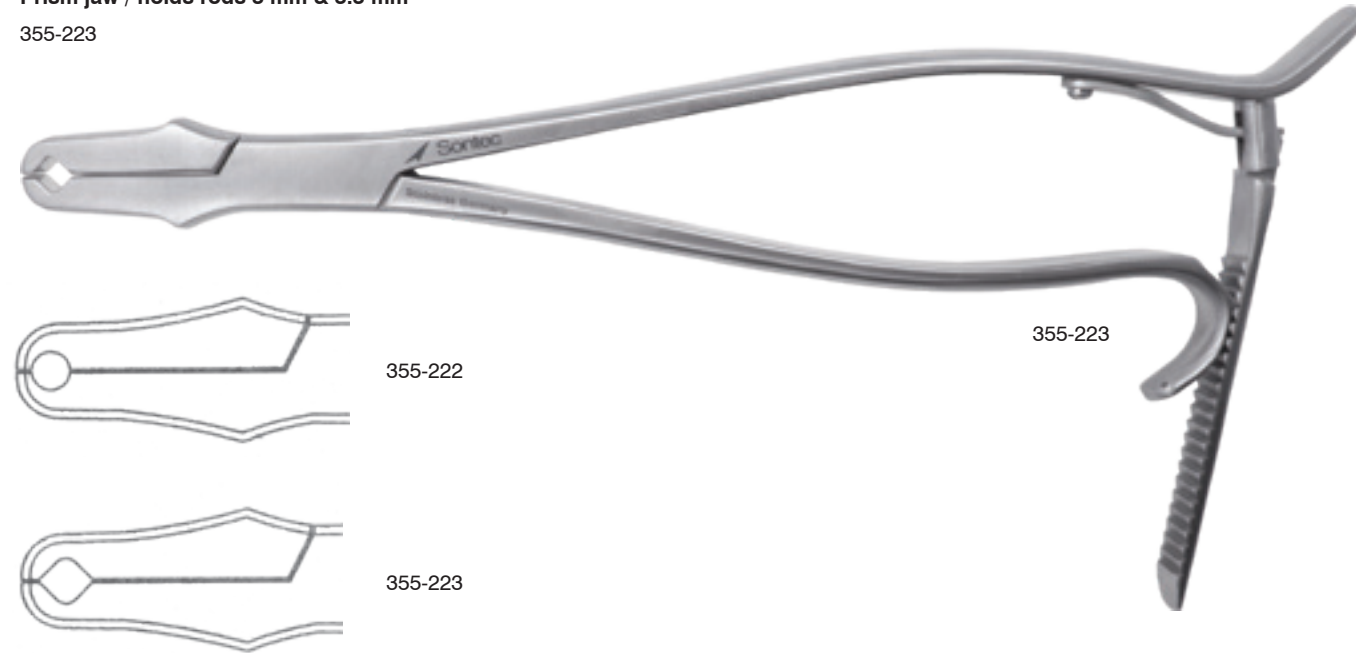

**Ferris Smith Rod Holder**

For Ø 5.5 rods / 7" (17.8 cm)

355-226



**Mini Rod Holder**

7" (17.8 cm)

355-2213 5.5 mm

8 1/4" ( 21 cm)

355-221 2.5 mm

355-2215 5.5 mm

8 3/4" ( 22 cm)

355-2214 5.0 mm

355-2217 5.5 mm

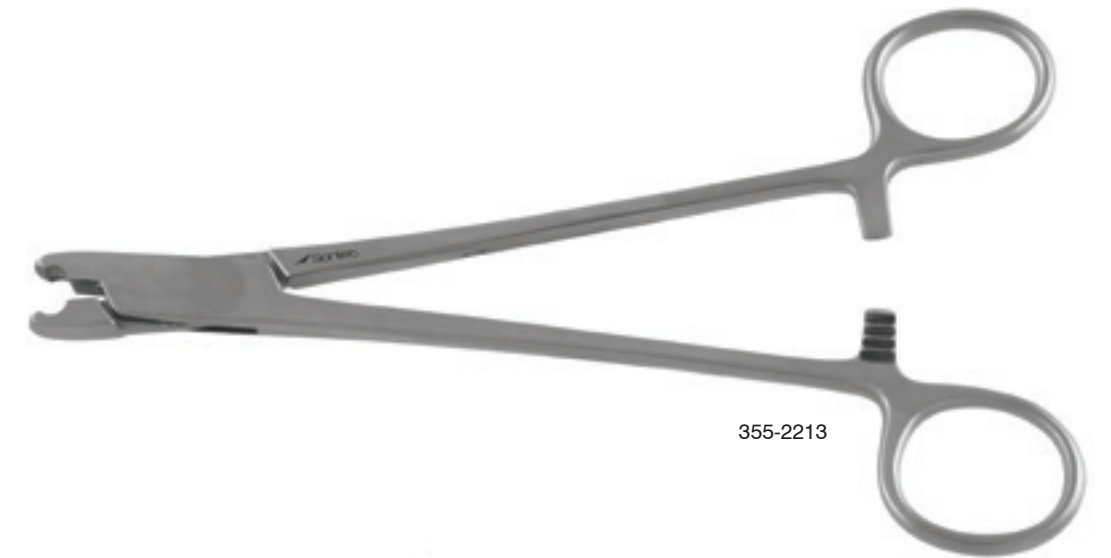

**Rod Gripping Pliers**

Adjustable to accommodate all  
Rod sizes / 8 3/4" ( 22cm)

1103-134



1103-134

**Wire Bender**

Bends and stabilizes  
K-wire / cuts wire up to  
1.6 mm / 7 1/2" (19 cm)

1103-156



1103-156

**Rod Bender Small**

Double sided / 7" (18 cm)

355-238 fits 3mm and 4mm rods

355-239 universal 3mm and 4mm rods

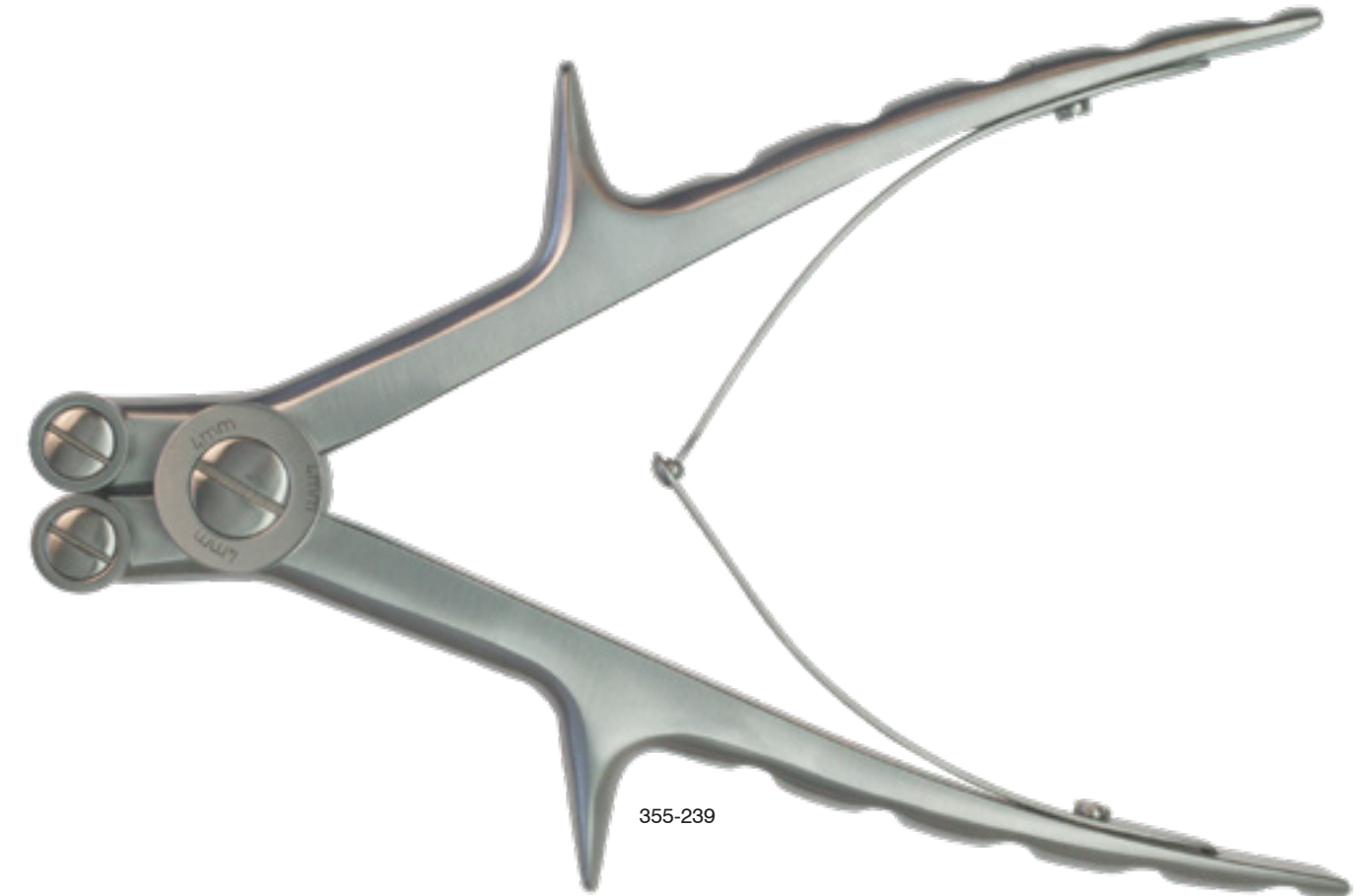

355-239



355-238

**Rod Bender Large**

11" (28 cm)

355-240 bends rods up to 7 mm  
355-241 bends rods up to 5.5 mm



355-240

**Aderer Wire Bending Pliers**

5 3/4" (14.5 cm)

1103-120



1103-120

**Waldsachs Universal Pin Bender Pliers**

6" (15 cm)

1103-138  
1103-1381 TC



1103-138



1103-1381



 Sontec Instruments®

Orthopedic SCREWDRIVERS

**Hexagonal Screw Driver**

**Screw drivers / phenolic handle**

1106-261	2.5 mm	7" (18cm)
1106-263	3.5 mm	7" (18 cm)
1106-270	2.5 mm	7 3/4" (20 cm)
1106-260	2.5 mm	9" (23 cm)
1106-262	3.5 mm	9" (23 cm)
1106-271	2.5 mm	9" (23 cm)

**Universal screw driver sleeve**

1106-270S



1106-263



1106-270S



sleeve and screw drivers sold separately

**Phenolic handle / 10 1/2" (27 cm)**

1106-257	2.5mm	screw driver w/ sleeve
1106-258	2.5mm	screw driver
1106-259		sleeve



1106-258



1106-259



1106-257

**A.O. Type Universal Screw Driver**

**Screw drivers / 5" (13 cm)**

1106-280	AO type tap handle
1106-281	AO type tap handle swivel

**Screw driver shaft**

1106-283	1.5 mm
1106-285	2.5 mm
1106-284	3.5 mm



1106-281



1106-285



1106-281 with 2.5mm shaft and universal sleeve

**Lubra® Screw Driver**

**Phenolic Handle / 6 3/4" (17 cm)**

1106-965	flat head
1106-967	hex head

**Phenolic handle / 10" (25 cm)**

1106-264	single slot
1106-266	cruciform
1106-268	phillips



1106-967

**AO Type Universal Screwdriver Set**

1106-2881 Set includes:

- |           |  |                |
|-----------|--|----------------|
| 1106-288  | AO type tap handle swivel                | 4 1/4" (11 cm) |
| 1106-289A | 1.5mm hex screwdriver shaft              | 2" (5 cm)      |
| 1106-289B | 1.5mm cruciform hex screwdriver shaft    | 2" (5 cm)      |
| 1106-289C | universal sleeve mini screwdriver shafts | 1.5 mm         |



1106-288



sleeve and screw drivers sold separately



1106-289C



1106-289A



1106-289B

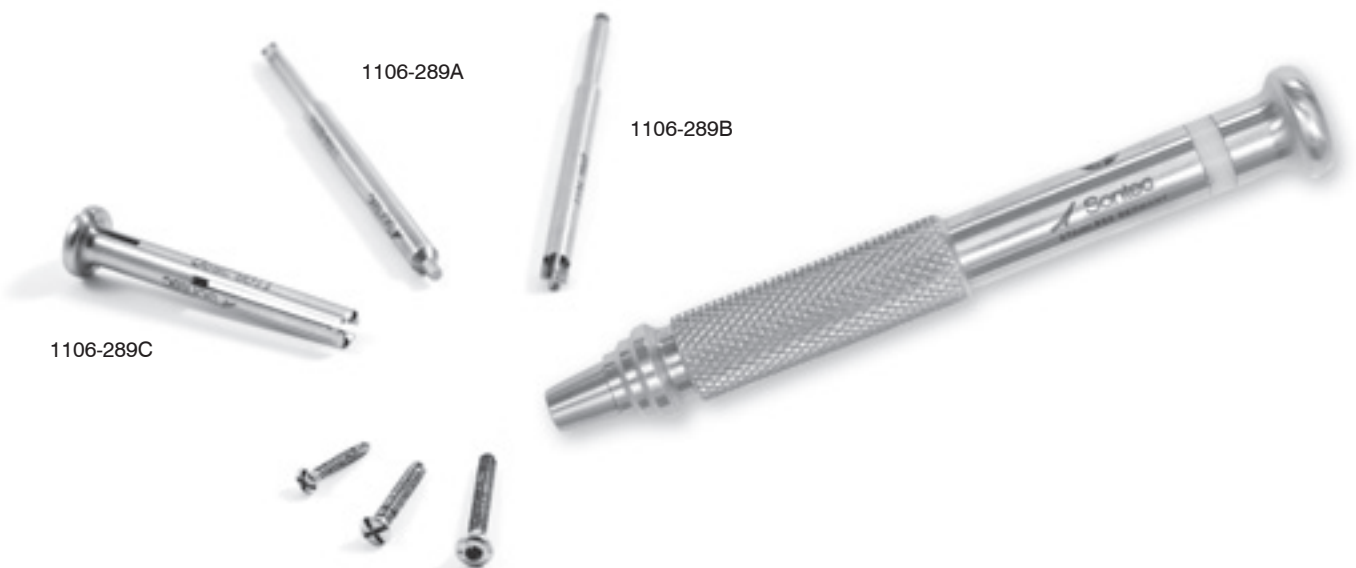

1106-289A

1106-289B

1106-289C

**Screw Holding Forceps**

For titanium and stainless steel screws / 5 3/4" (14.6 cm)

136-801T



136-801T



 Sontec Instruments®

Orthopedic DRILLS, DRILL GUIDES & CHUCKS

**Sontec I.M. Pin Chuck**

Stainless steel keyed drill chuck

- 1103-190 3/8"
- 1103-191 5/16"

Key for Sontec I.M. pin chuck

- 1103-185K for 3/8" chuck
- 1103-184K for 5/16" chuck

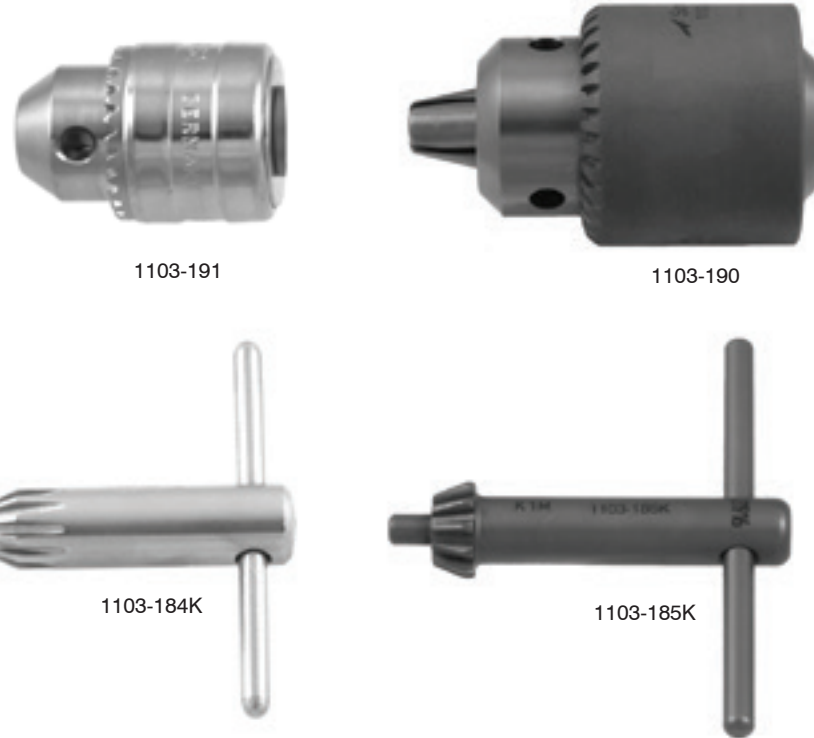

**Sontec Hybrid I.M. Pin Chuck**

Stainless steel universal use with or without key drill chuck

- 1103-193 3/8"

Key for 3/8" hybrid chuck

- 1103-193K

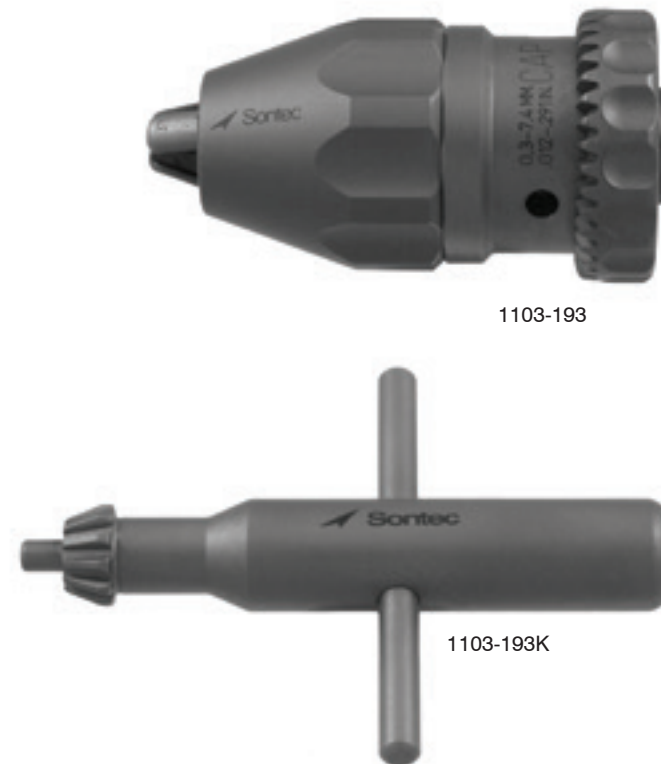

**Sontec Keyless I.M. Pin Drill Chuck**

Stainless steel chuck with lock system

- 1103-194 3/8"

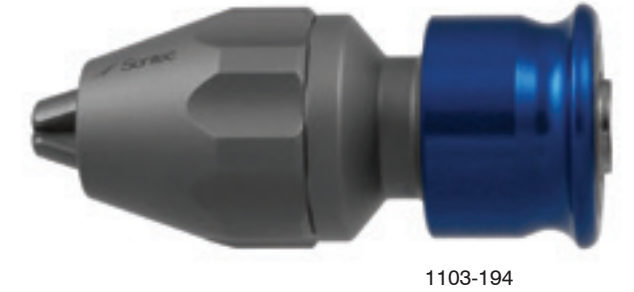

**Sontec I.M. Pin Chuck Aluminum Handle**

- 1103-190H for 3/8" chuck
- 1103-191H for 5/16" chuck



**Sontec I.M. Pin Chuck T-Handle**

1103-185T



1103-185T

**Power Drill Adapter for Sontec I.M. Pin Chuck**

For 5/16"

1103-176



1103-176

**Sontec I.M. Pin Chuck Extensions**

1103-187 extension handle to protect against sharp end of pin being exposed  
 1103-186X key extension handle for IM Pin chuck key leverage device



1103-187



1103-186X

**Sontec I.M. Pin Chuck Set**

**with aluminum handle**

1103-184-SET

Set includes:

- 1103-191 stainless steel 5/16" chuck
- 1103-184K key
- 1103-191H aluminum handle
- 1103-187 extension handle

1103-185-SET

Set includes:

- 1103-190 stainless steel 3/8" chuck
- 1103-185K key
- 1103-190H aluminum handle
- 1103-187 extension handle



**Sontec I.M. Pin Chuck Set**

**with t-handle**

1103-184T-SET

Set includes:

- 1103-191 stainless steel 5/16" chuck
- 1103-184K key
- 1103-185T t-handle

1103-185T-SET

Set includes:

- 1103-190 stainless steel 3/8" chuck
- 1103-185K key
- 1103-185T t-handle



**Sontec Hybrid I.M. Pin Chuck Set**

**with aluminum handle**

1103-193-SET

Set includes:

- 1103-193 stainless steel 3/8" keyed or keyless drill chuck
- 1103-193K key
- 1103-190H aluminum handle
- 1103-187 extension handle

**with t-handle**

1103-193T-SET

Set includes:

- 1103-193 stainless steel 3/8" keyed or keyless drill chuck
- 1103-193K key
- 1103-185T t-handle



**Sontec Keyless I.M. Pin Chuck Set**

**with aluminum handle**

1103-194-SET

Set includes:

- 1103-194 stainless steel 3/8" keyless chuck
- 1103-190H aluminum handle
- 1103-187 extension handle

**with t-handle**

1103-194T-SET

Set includes:

- 1103-194 stainless steel 3/8" keyless chuck
- 1103-185T t-handle



**K-Wire Pin Driver**

Cannulated for K-wire / 6 3/8" (15.5 cm)

1103-180  
1103-180T titanium



1103-180



1103-180T

**Universal Drill Guide**

With adjustable spiked head and 3 different sized interchangeable guide tubes

1103-168-SET  
Set include:  
1103-168 Universal Drill Guide body with spike  
1103-16820 2.0 mm guide tube  
1103-16827 2.7 mm guide tube  
1103-16835 3.5 mm guide tube

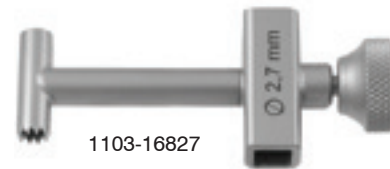

1103-16827



1103-16835

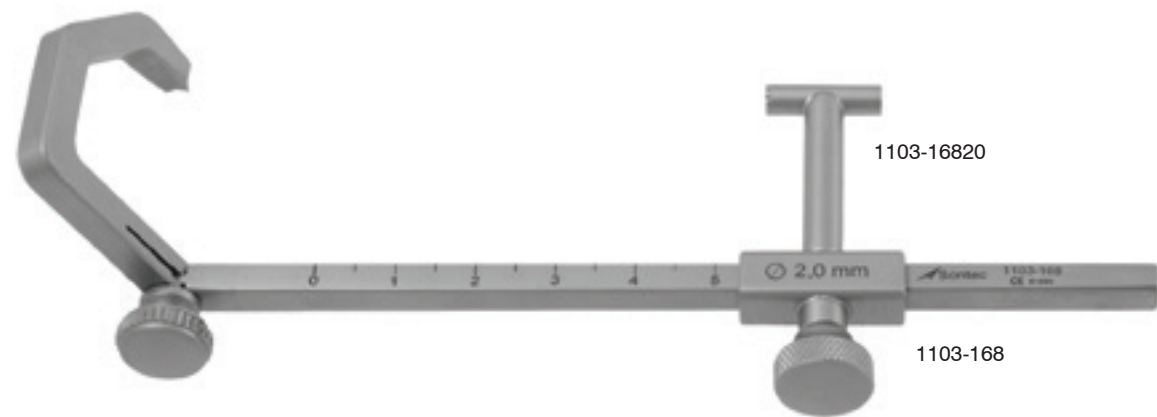

1103-16820

1103-168

**Tap Sleeve & Insert Drill Sleeve Set**

1103-162S-SET set includes:  
1103-161 Taylor Universal drill guide handle  
1103-162A tap sleeve 4.5 mm  
1103-162B insert drill sleeve for 3.2 mm

\* The toothed tip prevents slipping on the bone



1103-162S



1103-162B

1103-162A

1103-161

**3 / 1 Drill Guide**

For drill 2 mm / double ended

1103-162C tap sleeve 4.5 mm



1103-162C

**Tap/ Drill Sleeve**

Double ended

1103-162D 3.5 mm x 2.5 mm  
1103-162E 2.7 mm x 2.0 mm



**Micro Tap/ Drill Sleeve**

2.5 mm / single ended

1103-162M



**Taylor Drill Guide**

1103-1625 small reducer 3.2 mm / 1.6 mm  
1103-1626 large reducer 7 mm / 3.2 mm  
1103-1627 handle / reducer 9.5 mm / 7 mm



**Countersink Bit Cannulated**

1106-384 3.5 / 4.0 mm screws  
1106-385 4.5 mm screws



**Measuring Gauge**

For cannulated screws / 3.5 mm & 4.5 mm

1106-375



**AO Tap Cannulated**

1106-387 for 4.5 mm screws 7"  
1106-388 for 3.5 mm screws 4 1/4"



**Drill Bit Quick Coupling**

4.5 mm Ø 195 mm

1106-391



**Double Drill Guide**

4.5 / 3.2 mm  
1103-1624



**Double Drill Guide**

2.7 / 1.25 mm  
1103-1623



**Parallel Drill Guide**

For 1.6 mm wire / 4.5 mm cannulated screws  
1103-1622 small reducer



**Bone Tunnel Borer**

7" (18 cm)  
1106-848 2.7 mm

\* Stainless Steel, small handle, attached drill bit. Used to create bone tunnel quickly and easily without having to set upon a complete orthopedic drill.



1106-848

**Valkyrie Mach Holder / Drill Guide**

1103-1601



1103-1601



 Sontec Instruments®

Orthopedic SPECIALTY

**Depth Gauge**

6 1/4" (16 cm) /  
Screw size 2.4 - 4.0 /  
10 mm - 60 mm

355-162



355-162

8 3/4" (22 cm) /  
Screw size 3.5 - 6.5 /  
10 mm - 90 mm

355-163



355-163

Screw size 3.5 - 6.5 /  
10 mm - 120 mm

355-163L



355-163L

1.) Scale

a.) Scale gradations  
please mark your desired scale design

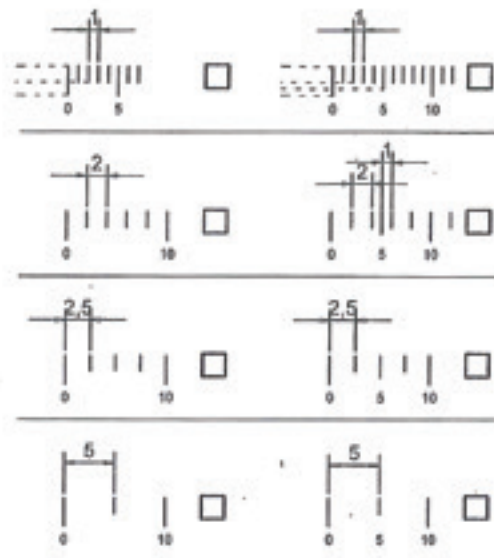

b.) length of scale \_\_\_mm  
                                  \_\_\_mm

c.) customized scale (please add your drawing)

2.) Distance dimension of zero-point to the tip distance

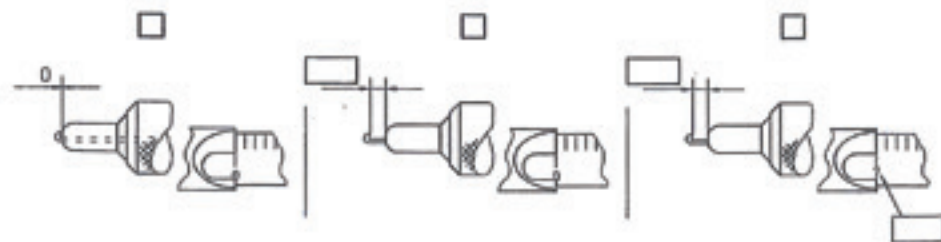

**Depth Gauge EZ Clean**

355-170	1.2/1.5mm	screw size 0-30mm
355-171	2.0/2.4mm	screw size 0-30mm
355-171L	2.0/2.4mm	screw size 0-50mm
355-172	2.7mm	screw size 0-50mm
355-173	3.5/4.0mm	screw size 0-50mm
355-173L	3.5/4.0mm	screw size 0-80mm



355-170



355-171



355-171L



355-172



355-173



355-173L

**Mini Depth Gauge**

Screw size 1.5 / 10 mm - 30 mm  
355-161



355-161

**Cloward Depth Gauge**

7" (17.8 cm) / up to 45 mm  
355-161



355-164

**Taylor Micro Arthroscopic Pick**

Straight / 1.2 mm / 8" (20 cm)  
1271-120



1271-120

**T-Handle Bone Hook**

T-shaped phenolic handle /  
sharp tip / 7" (18 cm) shaft  
320-936



320-936

**Bone Scraper Set**

Includes bone grater attachment 1.0  
mm / 1.5 mm / 2.0 mm / 11" (28 cm)

355-272 two legs  
355-273 four legs

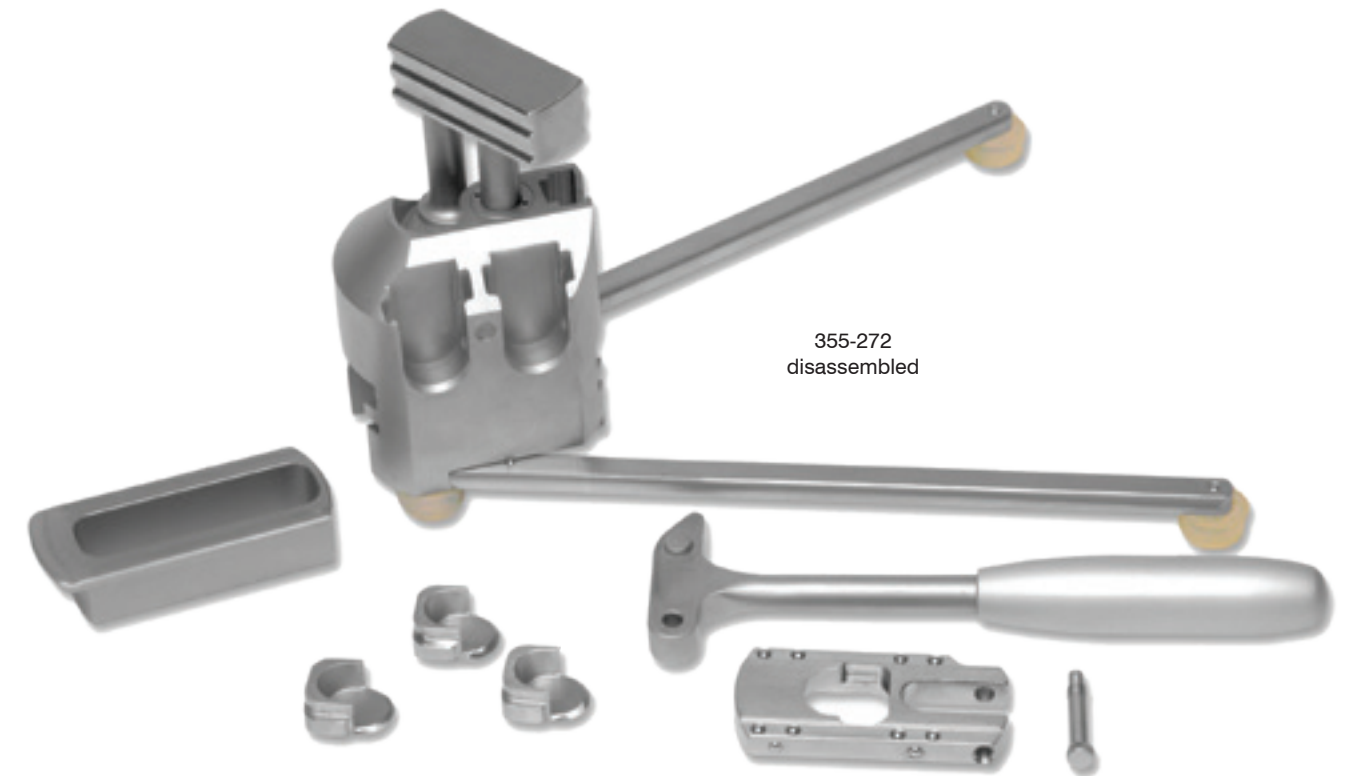

355-272  
disassembled

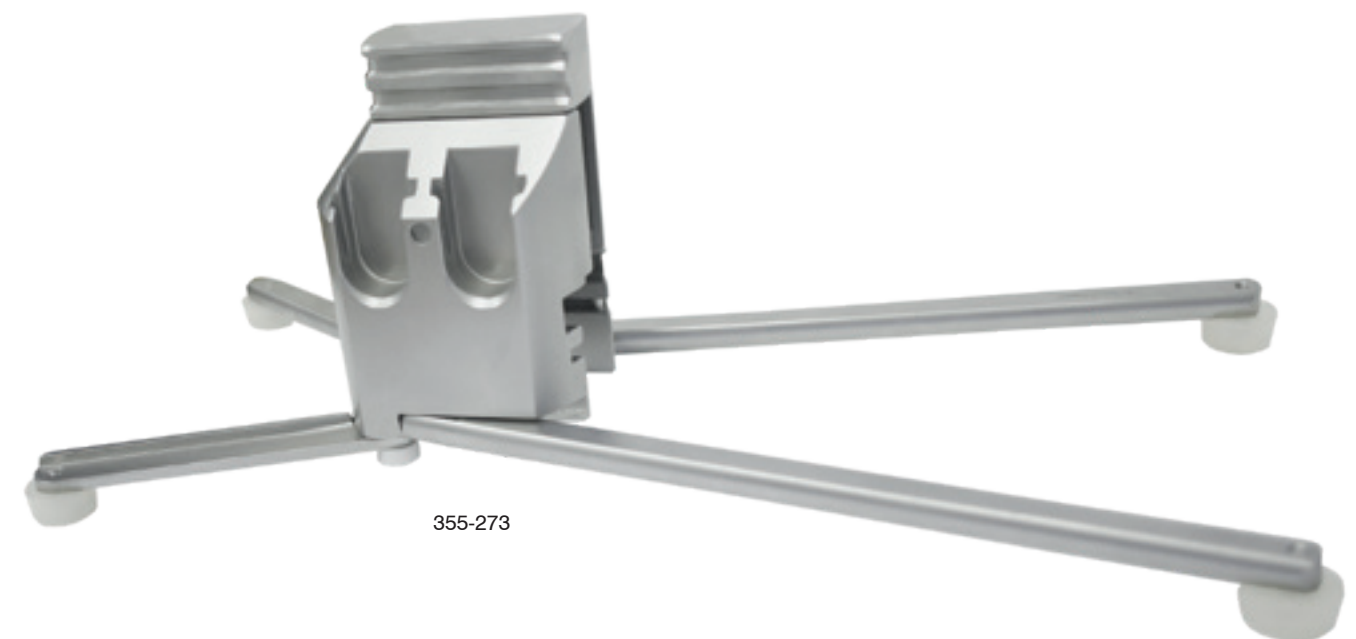

355-273

**Liska Awl**

T- handle / 3" shaft  
1271-342



1271-342

**Perthes Awl**

6" (15 cm)  
1271-340



1271-340

**Daniel Nasal Awl**

6 1/4" (10.8 cm)  
467-414



467-414

**Sontec 3 Prong Cast Spreader**

9" (23 cm)  
240-700



240-700

**Henning Cast Spreader**

10 3/4" (23 cm)  
240-695



240-695

**Lumbar & Cervical Impactor**

335-390	6.5 mm x 11.5 mm		8 1/2" (21.6 cm)
335-391	6 mm x 12.55 mm	narrow	8 3/4" (22.2 cm)
335-392	4.3 mm x 10 mm	micro lateral offset without heel	7" (17.8 cm)
335-393	4.3 mm x 10 mm	micro lateral offset with heel	7" (17.8 cm)
335-396	10 mm x 13 mm	micro lateral offset	8 3/4" (22.2 cm)
335-397	7 mm x 12.5 mm	guarded micro lateral	8 3/4" (22.2 cm)
335-398	10 mm x 13 mm	lateral wide	8 3/4" (22.2 cm)
335-399	7 mm x 12.5 mm	lateral wide	8 3/4" (22.2 cm)



335-390



335-391



335-392



335-393



335-396



335-397



335-398



335-399

**Hibbs Bone Chip Packer**

Hex handle / 10" (25.5 cm)

335-400	2 mm x 10 mm
335-404	6 mm x 10 mm
335-406	6 mm x 19 mm



335-400



335-404

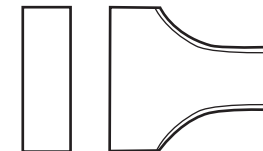

335-406

**Lumbar Implant Holder/ Disk Marker**

Phenolic handle / sharp with 6mm bead tip / 12" (30.5 cm)

335-380



335-380

**Bone Tamp**

8" (20 cm)

- 1103-197A 5 mm
- 1103-197B 8 mm
- 1103-197C 12 mm



1103-197A`



1103-197B



1103-197C

**Bayonet / 5 mm / 9 1/2" (24.1 cm)**

1103-195



1103-195

**Bone Mill Set**

- 355-270 bone mill (overall length 17")
- 355-275 table C-clamp for stationary positioning of bone mill
- 355-280 large (4.2 mm) cutting cylinder
- 355-285 small (3.2 mm) cutting cylinder
  
- 355-290 complete set



355-270

355-275

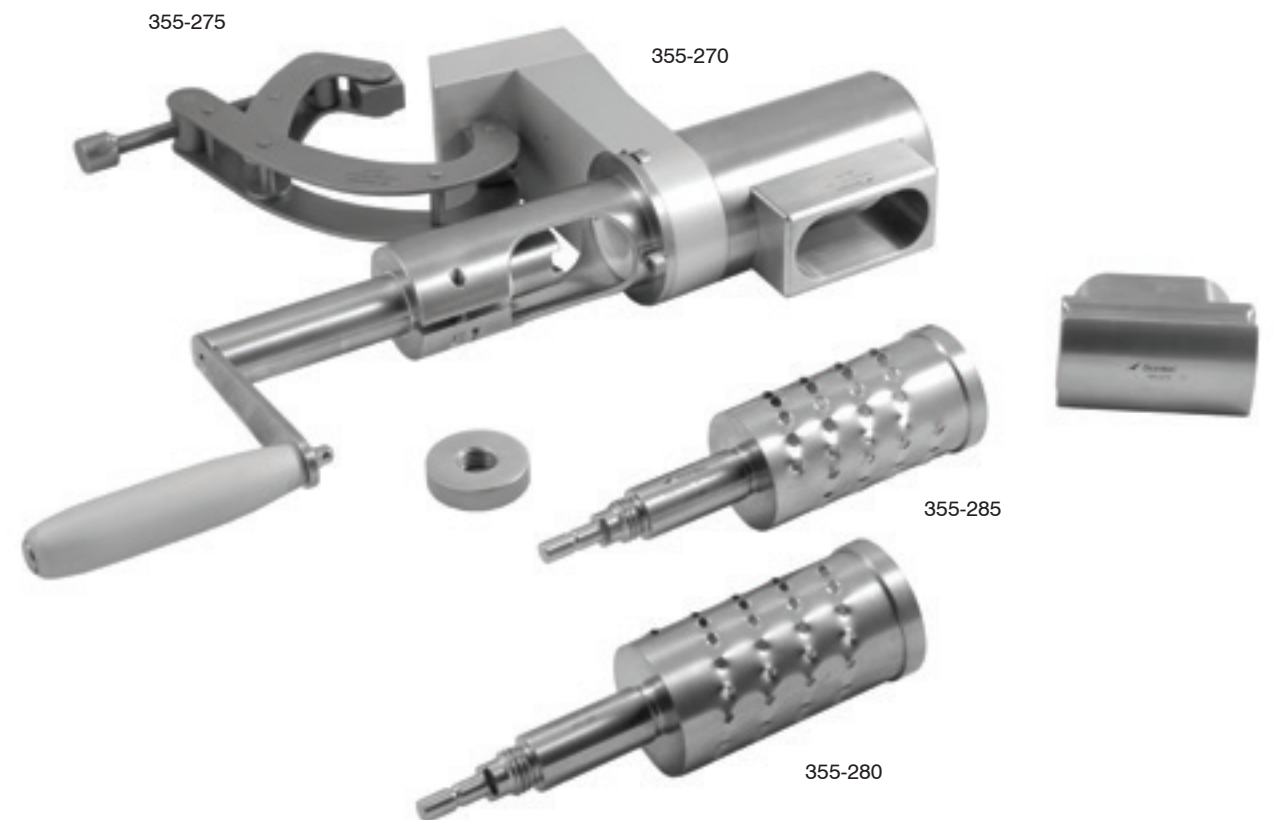

355-275

355-270

355-285

355-280

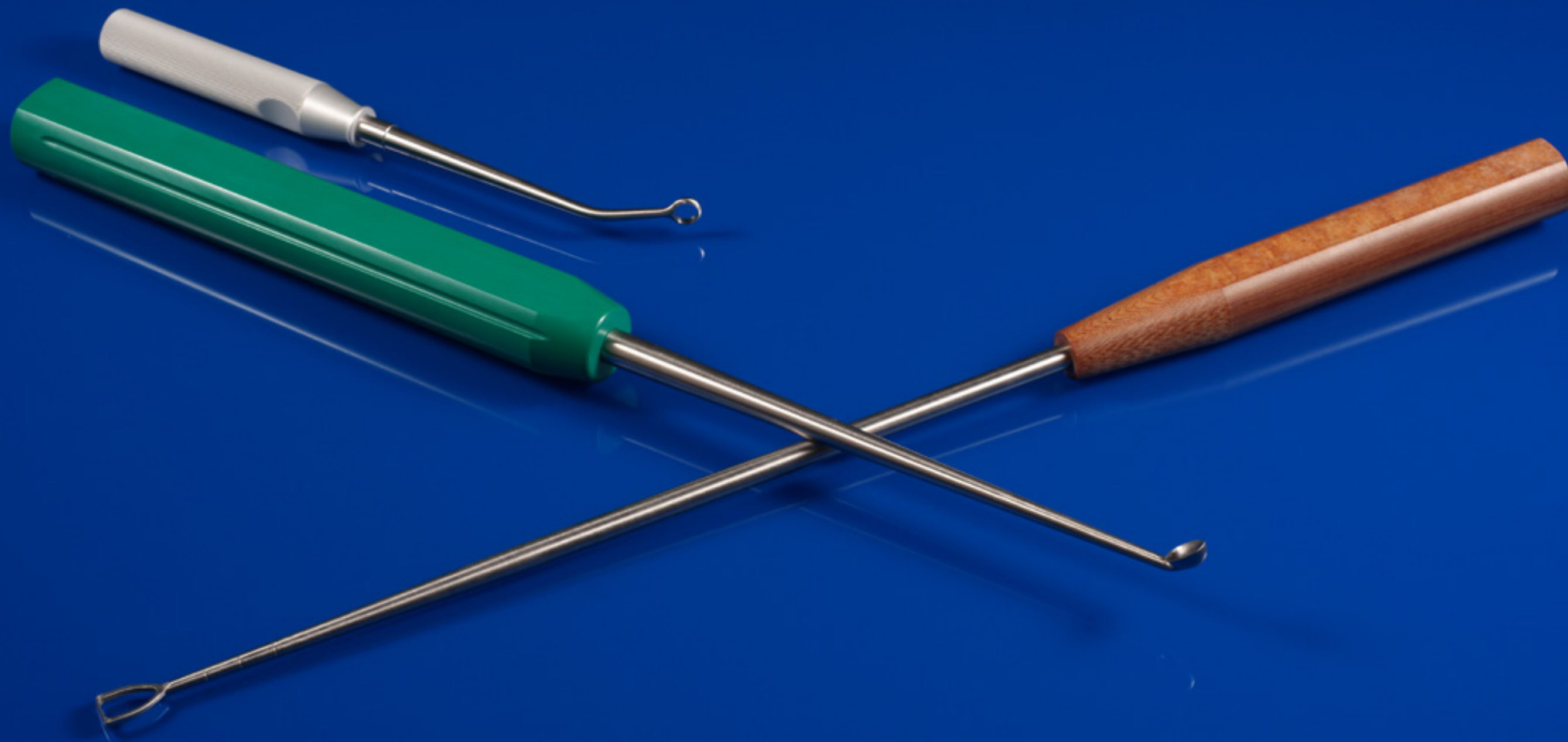

 Sontec Instruments®

Orthopedic Spinal Neuro CURETTES

**Lampert Curette**

Thin neck / oval cup / straight / 8" (20.5 cm)

- 320-826T size 000000
- 320-827T size 00000
- 320-829T size 0000
- 320-830T size 000
- 320-831T size 00
- 320-832T size 0
- 320-833T size 1
- 320-834T size 2



Thin neck / oval cup / angled / 8" (20.5 cm)

- 320-847T size 000000
- 320-848T size 00000
- 320-849T size 0000
- 320-850T size 000
- 320-851T size 00
- 320-852T size 0
- 320-853T size 1
- 320-854T size 2



320-827T



320-834T

**Bayonet Curette Titanium**

Bending Hypophysis Enucleator / 8 3/4" (22 cm)

413-040



413-040

**Bayonet Ring Curette Titanium**

8 3/4" (22.2 cm)

- 413-060 2.5 mm 45° up angle
- 413-061 3.0 mm 45° up angle
- 413-062 2.5 mm 40° down angle
- 413-063 3.0 mm 40° down angle
- 413-064 2.5 mm 90° up angle
- 413-065 3.0 mm 90° up angle



10 1/4" (25.26 cm)

- 413-050 3.0 mm 90° up angle
- 413-051 3.0 mm 90° down angle
- 413-052 2.25 mm 45° up angle

11" (28 cm)

- 413-055 3.0 mm 90° up angle
- 413-057 3.0 mm 40° down angle
- 413-058 2.25 mm 45° up angle

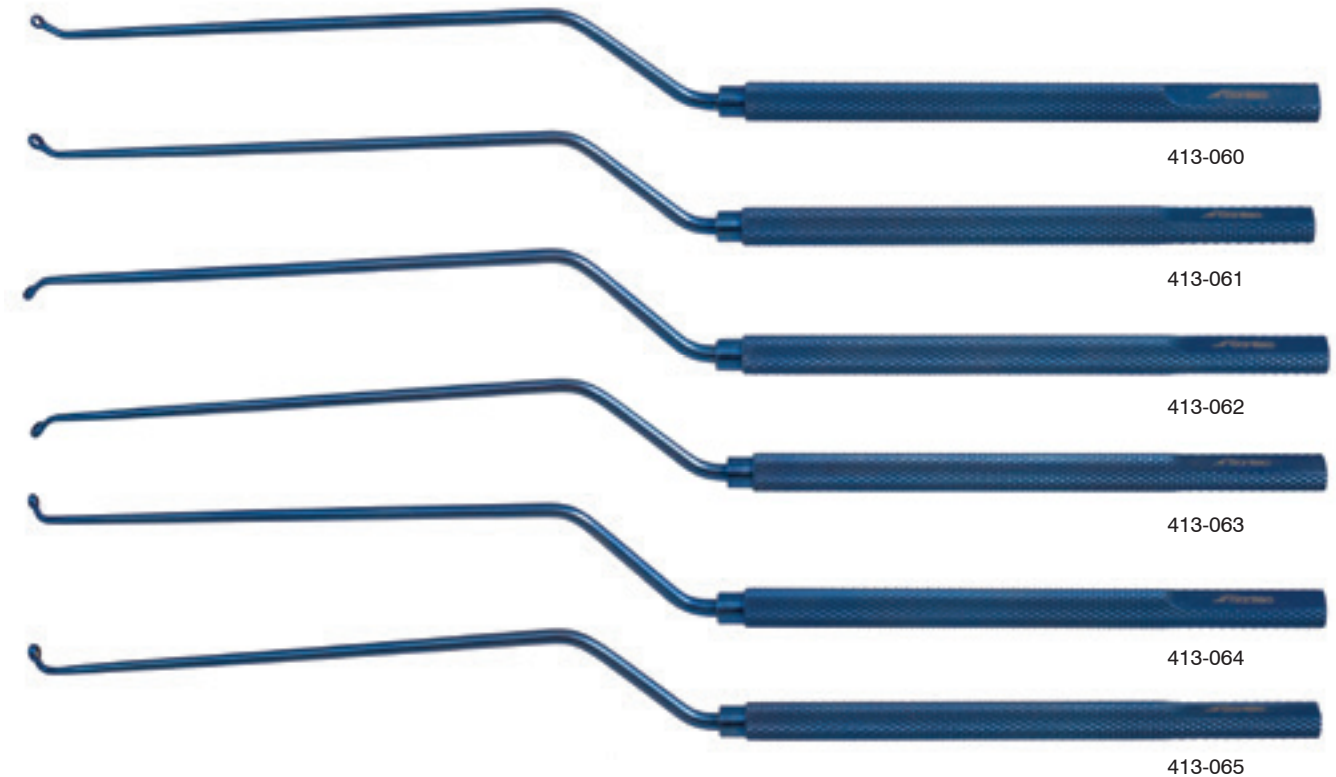

413-060

413-061

413-062

413-063

413-064

413-065

**Neuro Ring Curette**

Titanium / 8 1/4" (21 cm) / straight

- 413-044 2 mm
- 413-045 3 mm



413-044

**Down Pushing Curette**

Phenolic handle / 10 mm x 5 mm /  
9" handle / 15" (38 cm) / 380 mm

320-879



320-879

**O'Brien Curette**

Phenolic handle / 9"  
handle / 15" (38 cm)

320-924A 8mm  
320-924B 11 mm



320-924A

**Charnley Curette**

Phenolic handle / 9" handle /  
15" (38 cm) / 380 mm

320-869L large  
320-869S small



320-869L

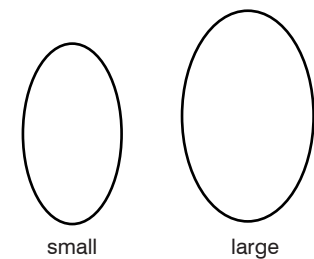

small

large

**Tear Drop Spinal Curette**

Phenolic handle / 52 mm x 12 mm /  
11" (27.9 cm)

320-958 straight  
320-959 angled 15°

Phenolic handle / 52 mm x 12 mm /  
17" (43.2 cm)

320-960 straight  
320-962 angled 15°



320-958



320-960



320-962

**Spinal Curette**

Phenolic handle / straight / 11" (28 cm)

- 320-866 size 000
- 320-859 size 00
- 320-860 size 0
- 320-861 size 1
- 320-862 size 2
- 320-863 size 3
- 320-864 size 4
- 320-865 size 5



320-862



320-865



320-866

Phenolic handle / angled / 11" (28 cm)

- 320-866A size 000
- 320-859A size 00
- 320-860A size 0
- 320-861A size 1
- 320-862A size 2
- 320-863A size 3
- 320-864A size 4
- 320-865A size 5

**Extra Long Spinal Curette**

Phenolic handle / extra long / angled / 13" (33 cm)

- 320-920 size 0



320-920



**USA Curette**

Phenolic handle / oval cup / 5" handle / 11" (28 cm)

- 320-687 size 5/0
- 320-686 size 4/0
- 320-678 size 3/0
- 320-679 size 2/0
- 320-680 size 0
- 320-681 size 1
- 320-682 size 2
- 320-683 size 3
- 320-684 size 4
- 320-685 size 5



320-684



320-679

Phenolic handle / straight / 5" handle / 10" (25.5 cm) / 250 mm

- 320-922A size 2
- 320-922B size 3
- 320-922C size 4



320-922C



320-922B

Phenolic handle / angled / 5" handle / 10" (25.5 cm) / 250 mm

- 320-923A size 2
- 320-932B size 3
- 320-923C size 4

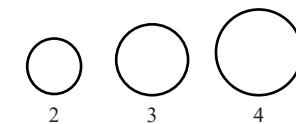

**Cone Ring Two Handed Curette**

Phenolic handle / straight / 15" (38 cm) / 380 mm

- 320-881A size 1
- 320-881B size 2
- 320-881C size 3
- 320-881D size 4



Phenolic handle / angled / 15" (38 cm) / 380 mm

- 320-882A size 1
- 320-882B size 2
- 320-882C size 3
- 320-882D size 4

320-881C

Phenolic handle / lateral angled / 15" (38 cm) / 380 mm

- 320-883A size 1
- 320-883B size 2
- 320-883C size 3
- 320-883D size 4

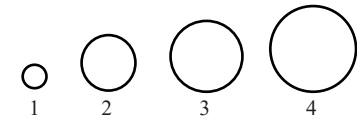

320-883C

**Cone Ring Two Handed Curette**

Phenolic handle / 9mm / 14 1/2" (37 cm) / 370 mm

- 320-615 straight
- 320-617 40° lateral



320-615

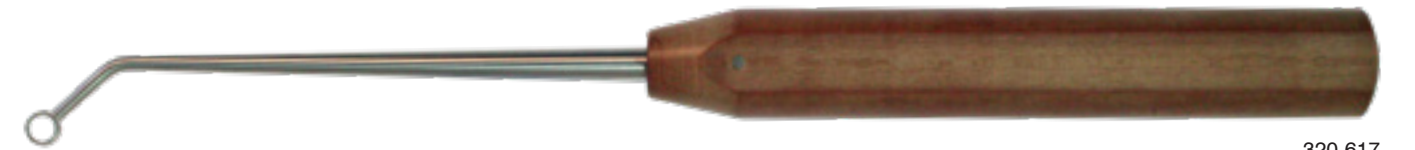

320-617

Black handle / 9mm / 14 1/2" (37 cm) / 370 mm

- 320-615B straight
- 320-617B 40° lateral



**Two Handed Curette**

**Phenolic handle / serrated cup / 6mm x 9mm / 14 1/2" (37 cm)**

- 320-621 straight
- 320-622 30d up
- 320-623 45d cvd left
- 320-624 45d cvd right
- 320-625 90d



320-625

**Black handle / serrated cup / 6 mm x 9 mm / 14 1/2" (37 cm)**

- 320-621B straight
- 320-622B 30d up
- 320-623B 45d cvd left
- 320-624B 45d cvd right
- 320-625B 90d



\* Available in a green handle



320-621B



straight



30d up



45d curved left



45d curved right



90d

**Two Handed Curette**

**Black handle / 90° / 18" (45.7 cm)**

- 320-584 2 mm
- 320-585 3.8 mm
- 320-586 8 mm

**Black handle / 30° / 18" (45.7 cm)**

- 320-580 2 mm
- 320-581 2.8 mm
- 320-582 4 mm oval
- 320-583 7 mm

**Black handle / straight / 18" (45.7 cm)**

- 320-587 3 mm
- 320-588 7 mm

**Tear Drop Curette**

**Black handle / 11 mm teardrop / 18" (45.7 cm)**

- 320-589 straight
- 320-590 15 degree angled



320-588



320-587



320-580



320-581



320-582



320-583



320-584



320-585



320-586



320-589



320-590

**Long Handle Curette**

**Sharp / black handle / 16 1/2" (41.9 cm)**

- 320-626B teardrop
- 320-629B #3 angled
- 320-630B #6 angled

**Sharp / green handle / 16 1/2" (41.9 cm)**

- 320-626G teardrop
- 320-629G #3 angled
- 320-630G #6 angled



320-626G



320-626B



320-629G



320-630G



320-626G



320-626B

**Two Handed Large Grip Curette**

**Phenolic handle / oval cup / straight / 7" handle / 13" (33 cm)**

- 320-658 size 3/0
- 320-659 size 2/0
- 320-660 size 0
- 320-661 size 1
- 320-662 size 2
- 320-663 size 3
- 320-664 size 4
- 320-665 size 5
- 320-666 size 6
- 320-667 size 7

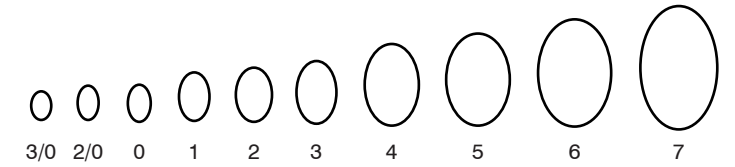

320-663

**Phenolic handle / oval cup / straight / 9" handle / 15" (38 cm)**

- 320-638 size 3/0
- 320-639 size 2/0
- 320-640 size 0
- 320-641 size 1
- 320-642 size 2
- 320-643 size 3
- 320-644 size 4
- 320-645 size 5
- 320-646 size 6
- 320-647 size 7



320-639

**Phenolic handle / oval cup / straight / 7 1/2" handle / 16" (40.5 cm)**

- 320-670 size 5



**Phenolic handle / oval cup / with teeth / 9" handle / 15" (38 cm) / 380 mm**

- 320-634T size 4
- 320-636T size 6



320-636T



**Micro Spinal Curette**

Phenolic handle / straight / 4.5" handle / 9.5" (24 cm) / 240 mm

- 320-889A size 6/0
- 320-889B size 5/0
- 320-889C size 4/0
- 320-889D size 3/0
- 320-889E size 2/0
- 320-889F size 0



Straight



Angled



Rev. Angled

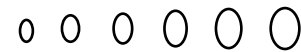

6/0 5/0 4/0 3/0 2/0 0

Phenolic handle / angled / 4.5" handle / 9.5" (24 cm) / 240 mm

- 320-888A size 6/0
- 320-888B size 5/0
- 320-888C size 4/0
- 320-888D size 3/0
- 320-888E size 2/0
- 320-888F size 0

Phenolic handle / rev. angled / 4.5" handle / 9.5" (24 cm) / 240 mm

- 320-887A size 6/0
- 320-887B size 5/0
- 320-887C size 4/0
- 320-887D size 3/0
- 320-887E size 2/0
- 320-887F size 0



320-889A



320-889B



320-889D

**Micro Axial Bayonet Regular Length Curette**

Phenolic handle / straight / 4.5" handle / 9.5" (24 cm) / 240 mm

- 320-886A size 6/0
- 320-886B size 5/0
- 320-886C size 4/0
- 320-886D size 3/0
- 320-886E size 2/0
- 320-886F size 0



320-886C



320-886E

Phenolic handle / angled / 4.5" handle / 9.5" (24 cm) / 240 mm

- 320-885A size 6/0
- 320-885B size 5/0
- 320-885C size 4/0
- 320-885D size 3/0
- 320-885E size 2/0
- 320-885F size 0

Phenolic handle / rev. angled / 4.5" handle / 9.5" (24 cm) / 240 mm

- 320-884A size 6/0
- 320-884B size 5/0
- 320-884C size 4/0
- 320-884D size 3/0
- 320-884E size 2/0
- 320-884F size 0



Straight



Angled



Rev. Angled

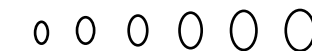

6/0 5/0 4/0 3/0 2/0 0

**Micro Axial Bayonet Long Curette**

Phenolic handle / long shaft / straight / bayonet / 5" handle / 12" (32 cm)

- 320-803A 1 mm
- 320-803B 2 mm
- 320-803C 3 mm
- 320-803D 4 mm
- 320-803E 5 mm
- 320-803F 6 mm

Phenolic handle / long shaft / angled / bayonet / 5" handle / 12" (32 cm)

- 320-804A 1 mm
- 320-804B 2 mm
- 320-804C 3 mm
- 320-804D 4 mm
- 320-804E 5 mm
- 320-804F 6 mm

Phenolic handle / long shaft / rev. angled / bayonet / 5" handle / 12" (32 cm)

- 320-805A 1 mm
- 320-805B 2 mm
- 320-805C 3 mm
- 320-805D 4 mm
- 320-805E 5 mm
- 320-805F 6 mm



320-804C



320-805B

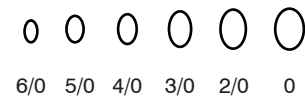
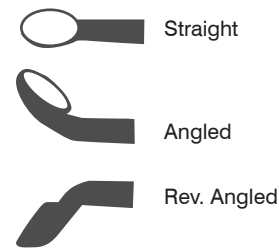

**Micro Axial Bayonet Extra Long Curette**

Phenolic handle / long shaft / straight / bayonet/ 5" handle / 14" (35.5 cm)

- 320-800A 1 mm
- 320-800B 2 mm
- 320-800C 3 mm
- 320-800D 4 mm
- 320-800E 5 mm
- 320-800F 6 mm

Phenolic handle / long shaft / angled / bayonet / 5" handle / 14" (35.5 cm)

- 320-801A 1 mm
- 320-801B 2 mm
- 320-801C 3 mm
- 320-801D 4 mm
- 320-801E 5 mm
- 320-801F 6 mm

Phenolic handle / long shaft / rev. angled / bayonet / 5" handle / 14" (35.5 cm)

- 320-802A 1 mm
- 320-802B 2 mm
- 320-802C 3 mm
- 320-802D 4 mm
- 320-802E 5 mm
- 320-802F 6 mm



320-801E



320-802D

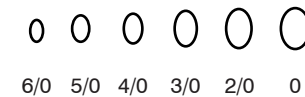
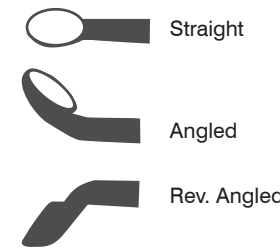

**Spinal Fusion Curette**

**Oval cup / 9" (23 cm)**

320-866-9-000	straight	size 000
320-866-9-00	straight	size 00
320-860-9-0	straight	size 0
320-861-9-1	straight	size 1
320-862-9-2	angled	size 2
320-863-9-3	straight	size 3
320-864-9-4	angled	size 4
320-865-9-5	straight	size 5
320-867-9-6	angled	size 6

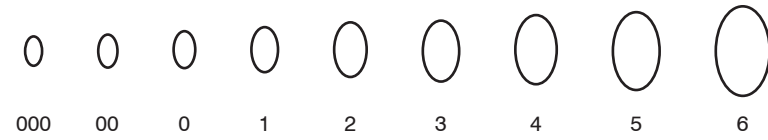

320-866-9-00

**Anterior Spinal Curette**

**Hollow knurled handle / oval cup / straight / 15" (38 cm)**

320-868-15-00	straight	size 00
320-868-15-1	straight	size 1
320-868B-15-6	bayonet	size 6



320-868-15-1



320-868-15-6

**Cobb Spinal Curette**

**Hollow knurled handle / oval cup / straight / 11" (28 cm)**

320-896	size 000
320-897	size 00
320-898	size 0
320-899	size 1
320-900	size 2
320-901	size 3
320-902	size 4
320-903	size 5
320-904	size 6

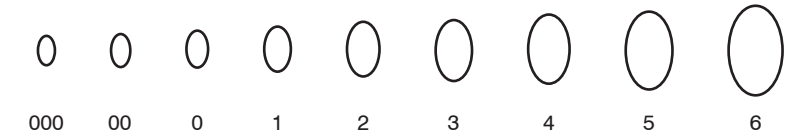

**Hollow knurled handle / oval cup / angled / 11" (28 cm)**

320-910	size 000
320-911	size 00
320-912	size 0
320-913	size 1
320-914	size 2
320-915	size 3
320-916	size 4
320-917	size 5
320-918	size 6



320-896



320-913



 Sontec Instruments®

Orthopedic TREPHINE

**Nested Trocar Set**

6 1/2" (16.5 cm)

190-246 set includes:  
6 french  
9 french  
13 french  
17 french  
handle & cover

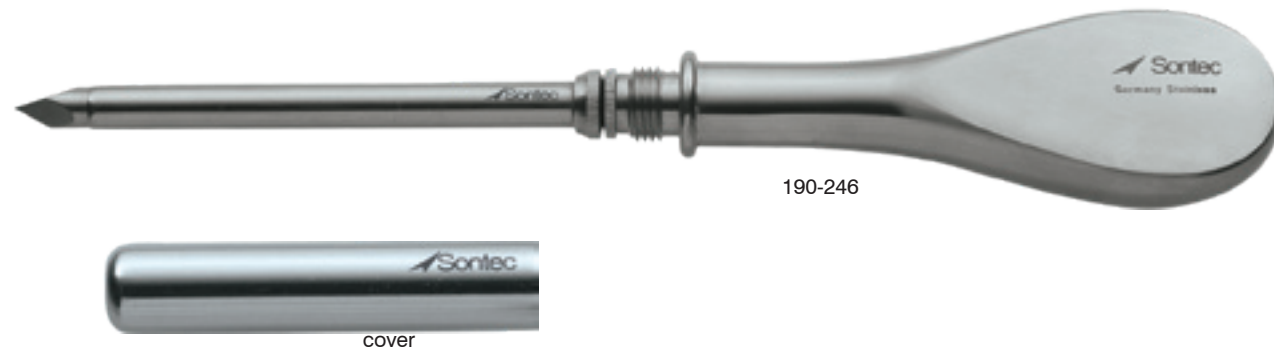
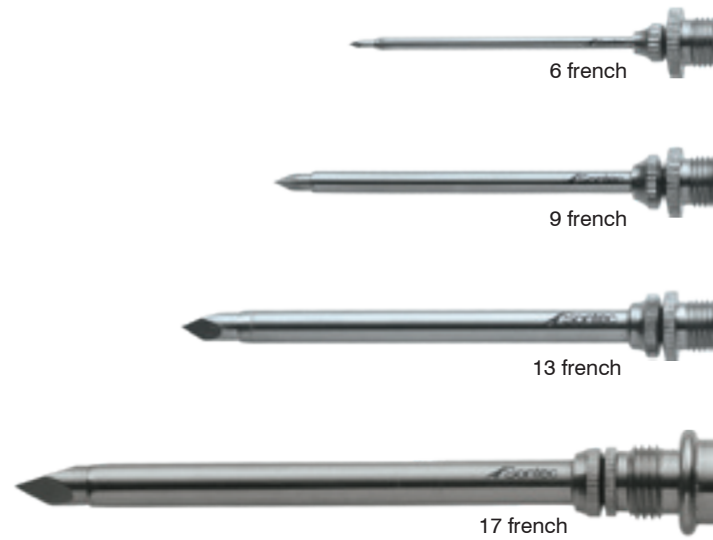

**Michele Trephine**

1100-460T	1/8" / 3 mm	special diameter
1100-460S	3/16" / 5 mm	
1100-460M	7/32" / 6 mm	
1100-460L	5/16" / 8 mm	
1100-460E	13/32" / 10 mm	
1100-460X	15/32" / 12 mm	

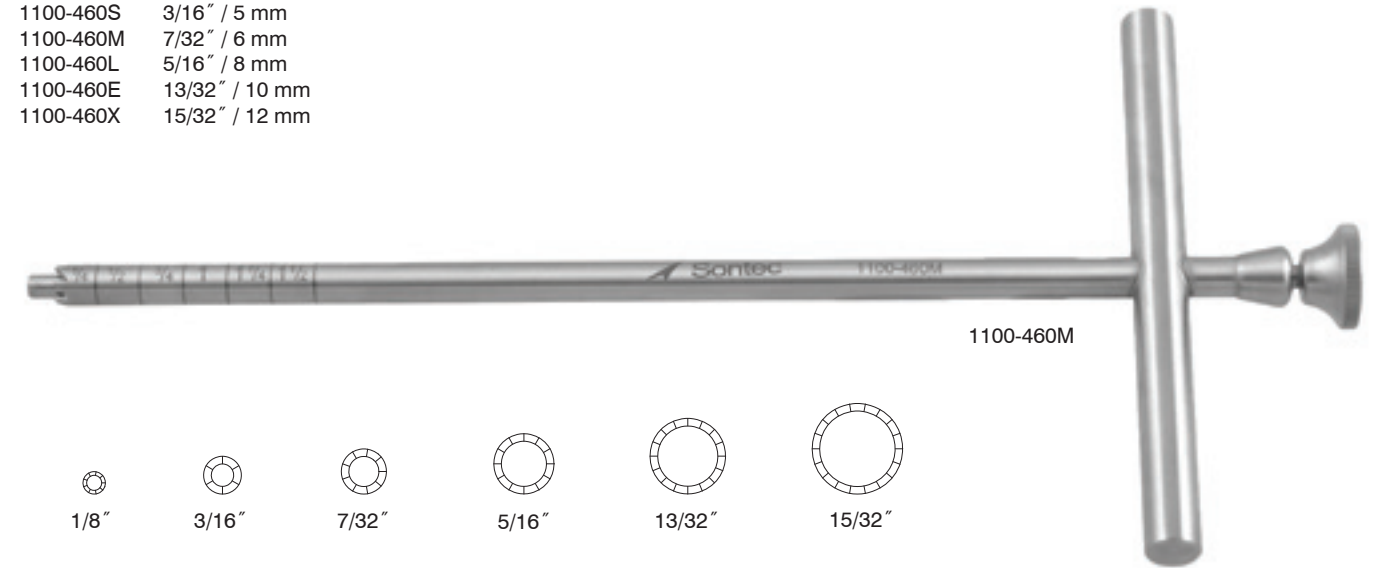

**Galt Trephine**

419-378	1/2" / 13 mm
419-380	5/8" / 16 mm
419-382	3/4" / 19 mm
419-384	7/8" / 22 mm
419-386	1" / 25 mm

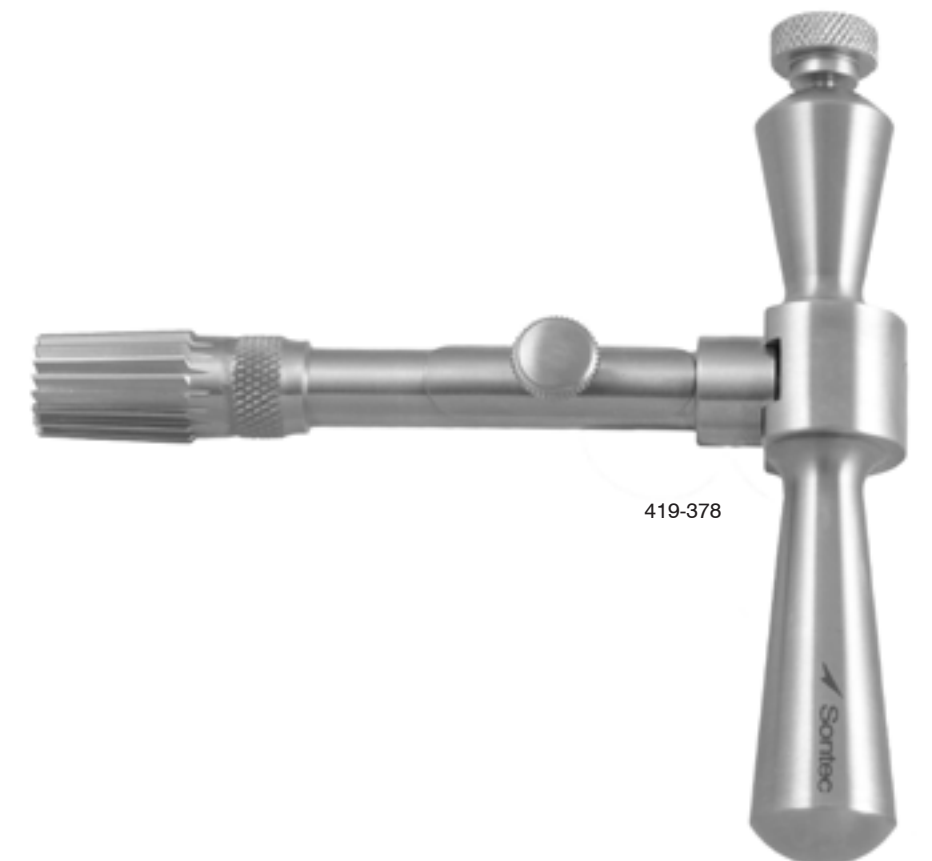

**Shepard Ram Obturator**

5 1/2" (14 cm)

- SC94-0412 5 mm
- SC94-0417 6 mm
- SC94-0422 8 mm



**Shepard Trocar**

5 1/2" (14 cm)

- SC94-0411 5 mm
- SC94-0416 6 mm
- SC94-0421 8 mm

**Shepard Cylindrical Osteotome**

5" (13 cm)

- SC94-0410 5 mm
- SC94-0415 6 mm
- SC94-0420 8 mm



**Shepard Cross Pin**

4 1/2" (11.5 cm)

- SC94-0405



**Plug Cutter**

With Obturator / 4 1/2" (11.4 cm)

- 419-392 3 mm/ 5 mm

With Obturator / 6 1/2" (16.5 cm)

- 419-393 5 mm/ 7 mm
- 419-394 7 mm/ 9 mm
- 419-395 10 mm/ 12 mm
- 419-396 12 mm/ 14 mm
- 419-397 20 mm/ 22 mm
- 419-398 22 mm/ 25 mm



**Bespoke Wroblewski Bone Trepine**

O/D 8 mm I/D 6 mm

- 419-388





 Sontec Instruments®

Orthopedic VISE GRIP PLIERS

**Wire Extraction Pliers**

7" (18 cm)

1106-130	cross-serrated	6 mm	grooved jaw
1106-131	cross-serrated	3 mm	
1106-132	serrated	3 mm	



1106-131

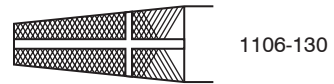

1106-130



1106-131



1106-132

**Pin Pulling Pliers**

TC / one grooved jaw / 3 mm tip / 5 1/2" (14 cm)

1106-140



1106-140

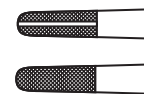

**Needle Nose Pliers**

Stainless

1103-144	5 1/2" (14 cm)	
1103-145	6" (15 cm)	delicate
1106-133	7 3/4" (20 cm)	



1103-144



1103-145



1106-133

**Needle Nose Locking Pliers**

- 1103-137S 8 5/8" (21.75 cm)
- 1103-137M 10" (25 cm)
- 1103-137L 11 3/4" (29.5 cm)



**Slap Hammer/Hip Dislodger**

Modified / locking pliers / with slide hammer  
355-300



**Vise Grip Pliers**

Locking adjustable jaws

- 1103-133S 7" (18 cm)
- 1103-133M 8" (20 cm)
- 1103-133L 9 1/2" (24 cm)



**Slip Joint Pliers**

Stainless

- 1103-142 6" (15 cm)
- 1103-141 8" (20 cm)





 Sontec Instruments®

Orthopedic WIRE PASSERS

**Sontec Single End Wire Passer**

Phenolic handle / 45 mm / 9" (22 cm)

1103-166

70 mm / 10 1/2" (27 cm)

1103-166X

45 mm / 8 3/8" (21.5 cm)

1103-167

Phenolic handle / with thick tubing wall /

9" (23 cm)

1103-165

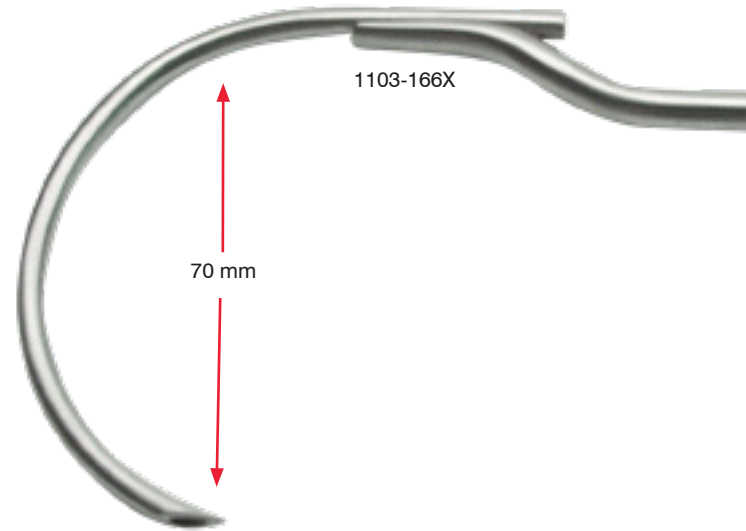

**Hybrid Herbst Wire Passer**

Phenolic handle / single end / 10 1/2" (26.7 cm)

1103-1661 45mm

1103-1662 70mm



**Herbst-Doolen Wire Passer**

Double-ended / small / medium / 5 1/2"  
(14 cm) / for 20-26 gauge wire

1103-841



1103-841

**Herbst Wire Passer**

Double-ended / 5 1/2" (14 cm)  
/ for 18-26 gauge wire

1103-160



1103-160

**Avian Mini Wire Passer**

For 22-26 gauge wire

1103-848 single ended 22 gauge 4 1/2"

1103-848S single ended 26 gauge 4 1/2"

1103-847 double ended 22-26 gauge 5"



1103-848



1103-847



 Sontec Instruments®

Orthopedic WIRE PIN CUTTERS

**Wire Side Cutter**

TC

1103-115	5 3/4" (14.5 cm)	cuts wire up to 1.0 mm
1100-528	7 1/2" (19 cm)	cuts wire up to 1.6 mm
1100-528D	8" (20 cm) Deluxe	cuts wire up to 1.6 mm



1103-115

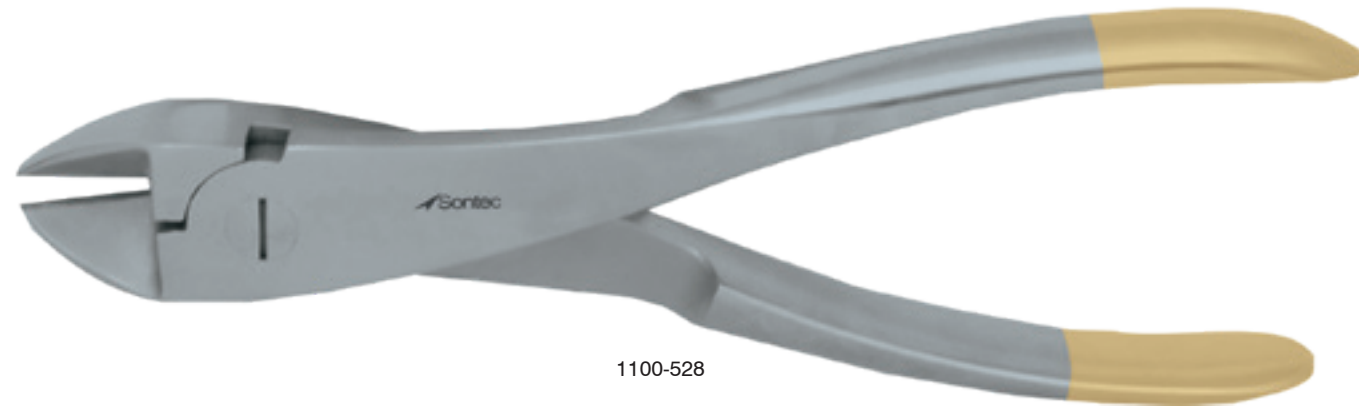

1100-528

**Plate Cutter for Titanium Plates**

Cuts up to 1.8 mm MAX / 6 1/2" (16.5 cm)

355-219



355-219

**Wire End Cutter**

TC / cuts wire up to 1.5 mm / 5 3/4" (14.5 cm)

1103-110

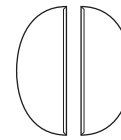

1103-110

**TC Pin Cutter**

Cuts pins up to 2 mm / 6 1/2" (16.5 cm)

355-196



355-196

**End Pin Cutter**

Cannulated / cuts pins up to 1.6 mm / single action / 7 1/2" (19 cm)

1103-109  
1103-108 TC



1103-109

**Large Plate & Pin Cutter**

Cuts stainless steel wire & plates up to 3.5 mm / replacement jaws available / 9 1/2" (24 cm)

1103-104

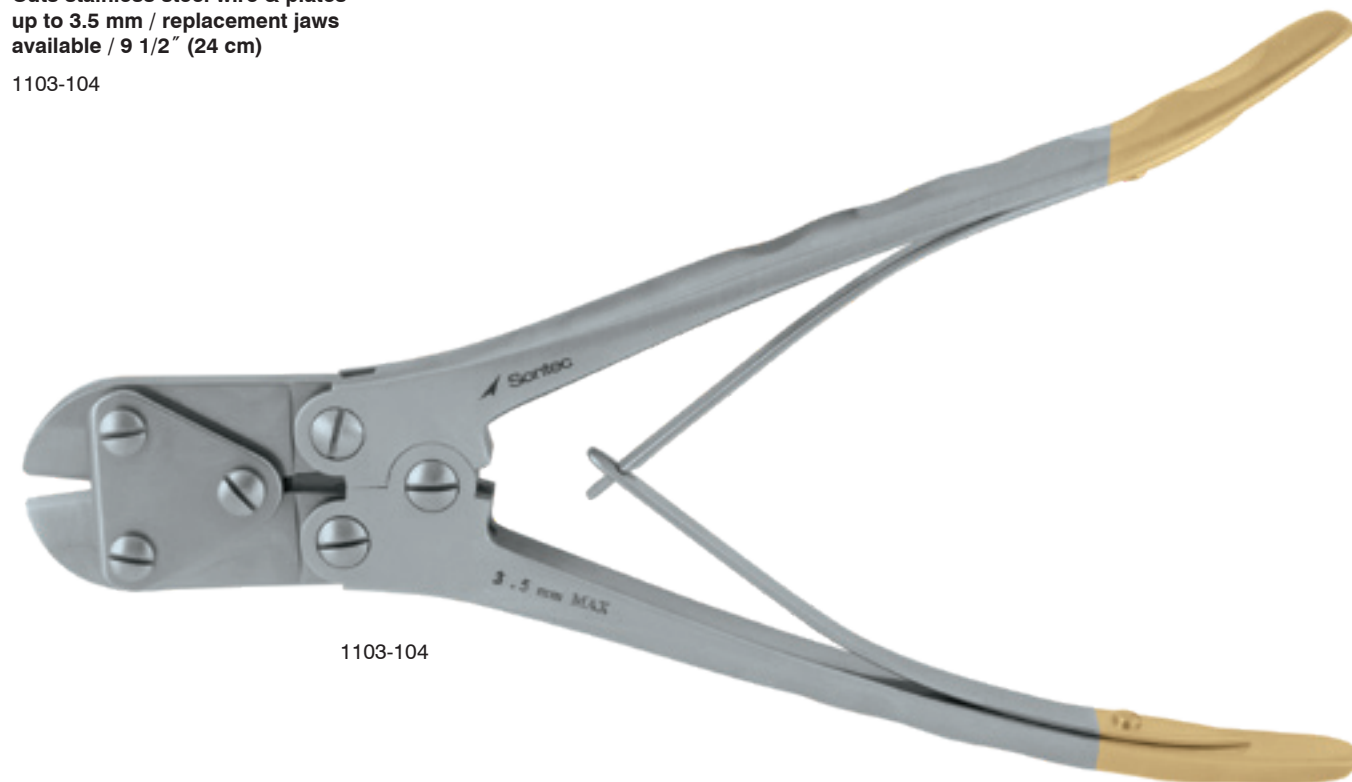

1103-104

**GOLD-CUT HERCULES® Pin Cutter**

Cuts pins up to 3 mm / exchangeable TC blades / over 40% less power required / exchangeable rubber jaws / fully sterilizable / 9" (23 cm)

355-189 wire cutter  
355-190 TC Blades Replacement Set  
355-193 Rubber Jaws Replacement Set

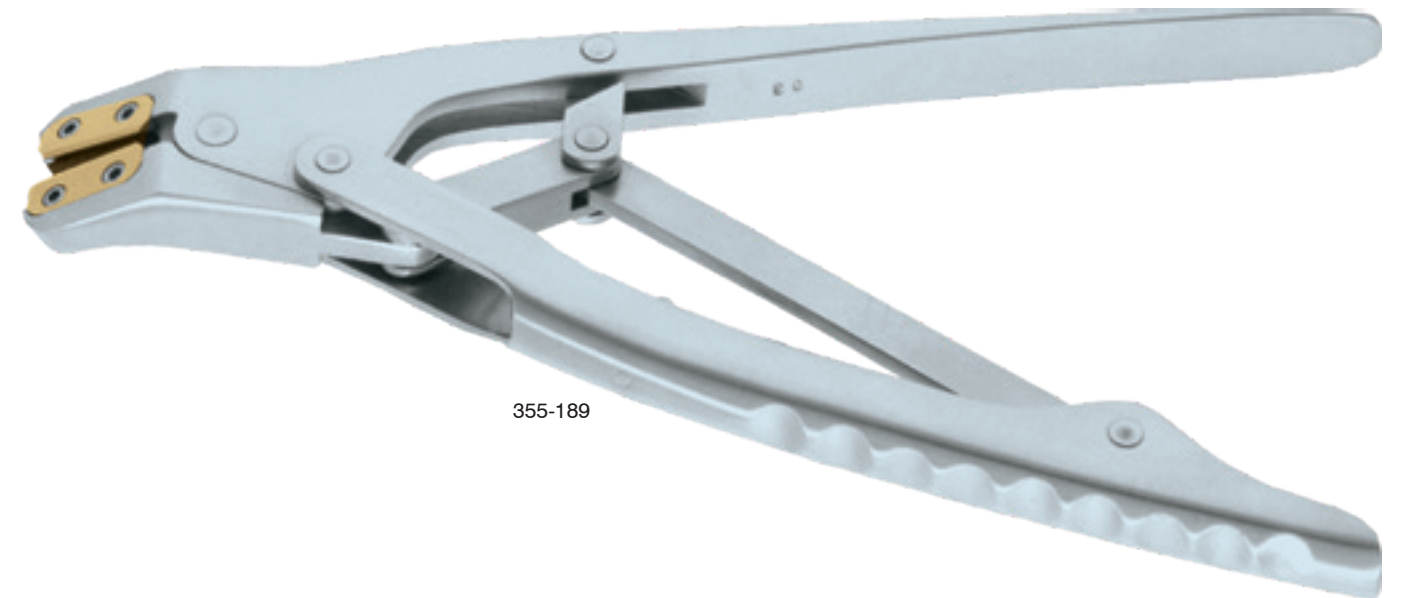

355-189

**The Big GOLD-CUT HERCULES® Pin Cutter**

Cuts pins 2.5 mm - 4.0 mm / exchangeable TC Blades / over 40% less power required / exchangeable rubber jaws / fully sterilizable / 11" (28 cm)

355-191 wire cutter  
355-192 TC Blades Replacement Set  
355-193 Rubber Jaws Replacement Set

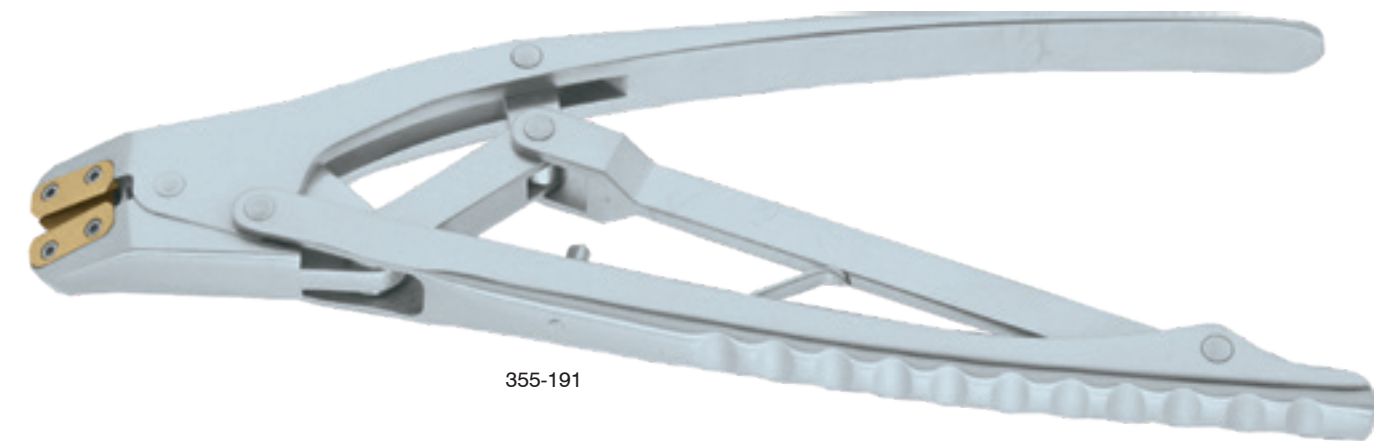

355-191

**Baby GOLD-CUT HERCULES® Pin Cutter**

Cuts pins up to 2.2 mm / exchangeable TC blades / over 40% less power required / exchangeable rubber jaws / fully sterilizable / 7" (18 cm)

- 355-187 left-handed
- 355-186 right-handed
- 355-188 TC Blades Replacement Set
- 355-193 Rubber Jaws Replacement Set

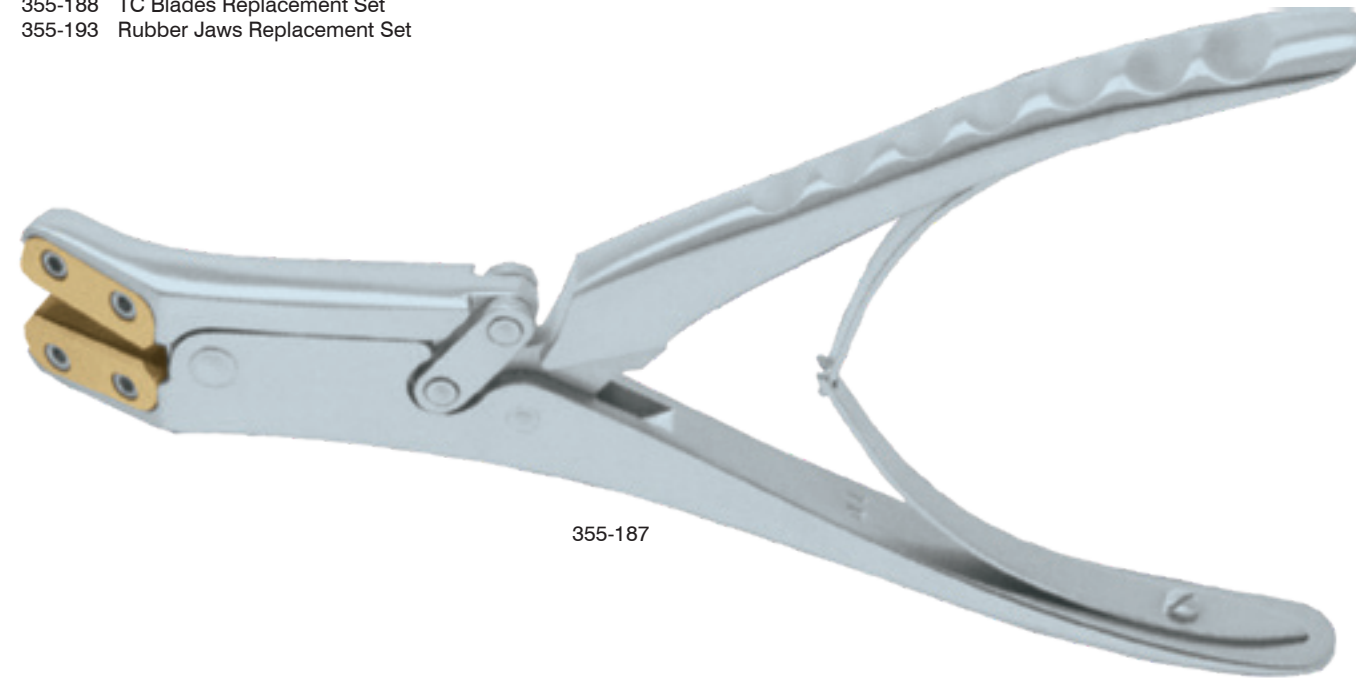

355-187

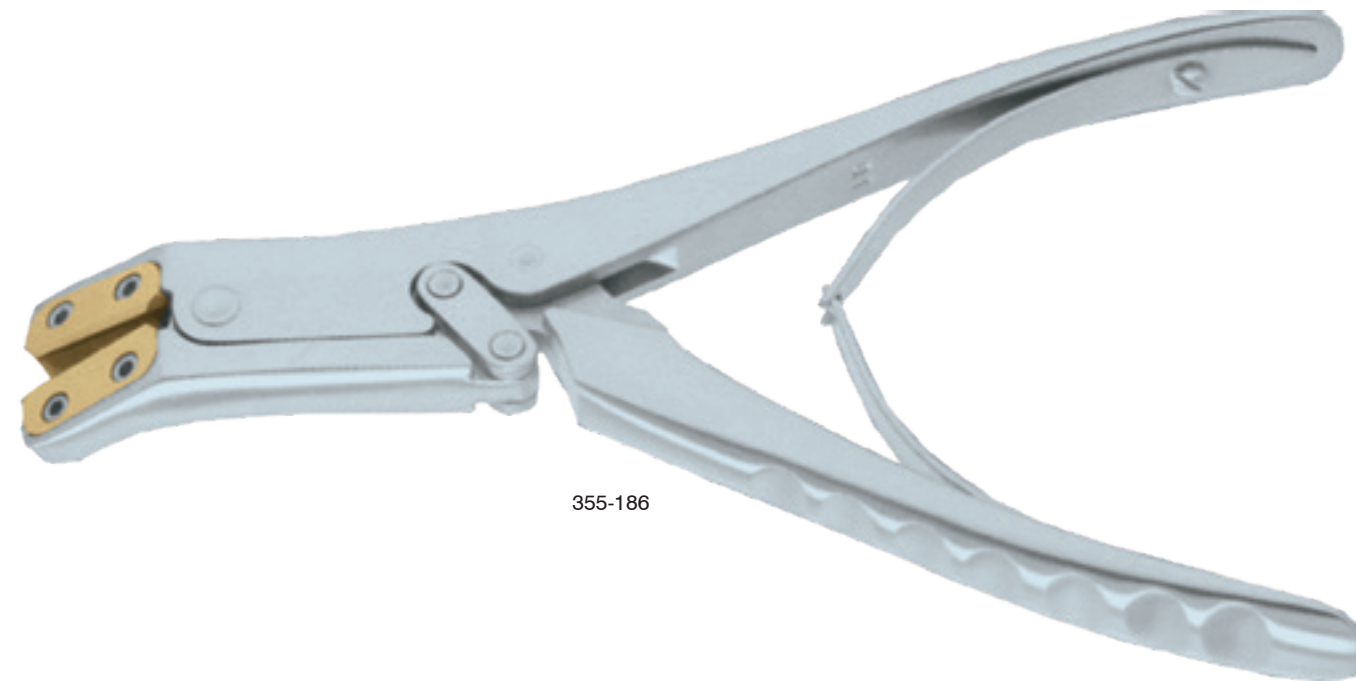

355-186

**Double Action Wire Cutter**

Cuts wire up to 1.6 mm / TC / 6 1/4" (16 cm)

1100-530A



1100-530A

**Micro Double Action Wire Cutter**

Cuts wire up to 1.6 mm / TC / 6 1/2" (16.5 cm)

1100-531



**Large Pin / Bolt Cutter**

Cuts pins up to 6.3 mm / replaceable jaws

355-212	non-removable handles	22 1/2"
355-213	compact removable handles	18 1/2"
355-214	removable handles	22 1/2"

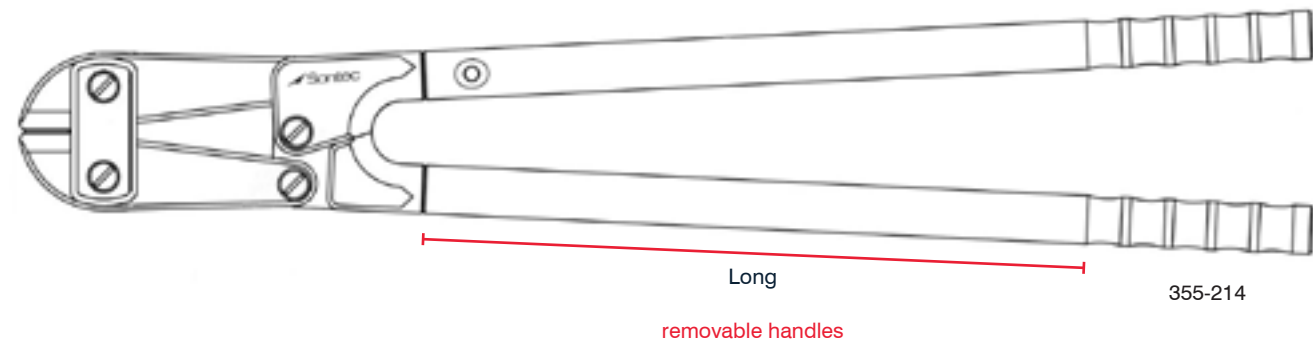
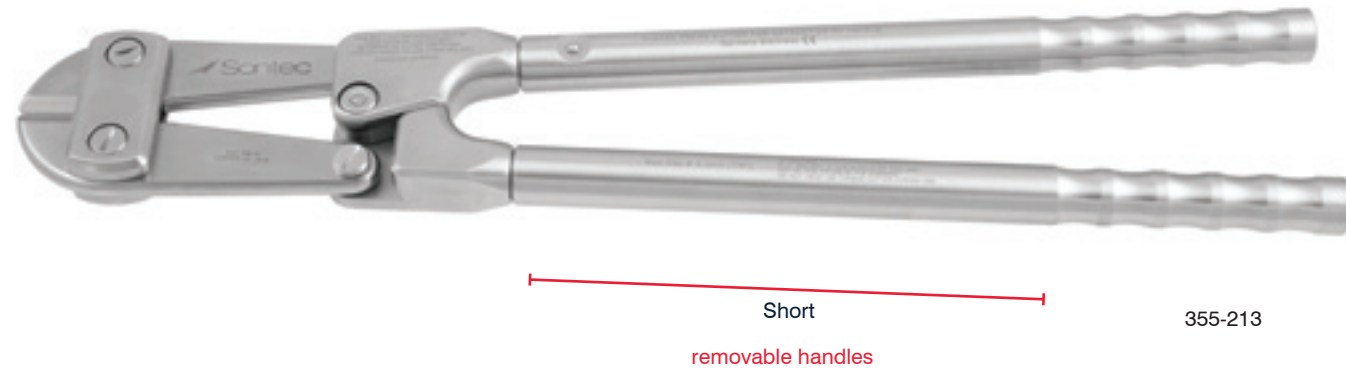
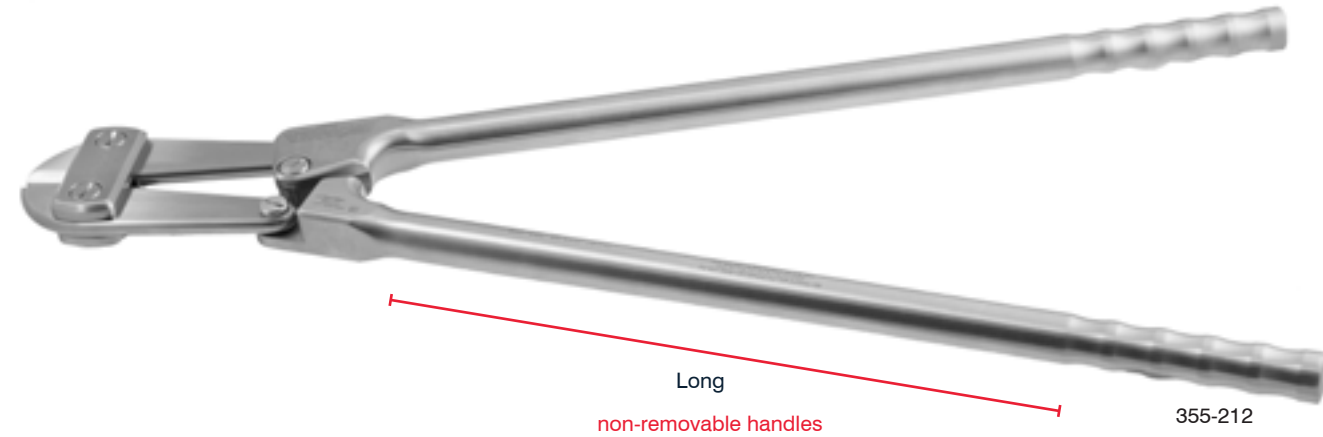

**TC Pin Cutter**

Cuts pins up to 6.0 mm / replaceable jaws

1103-140	19" (48 cm)	special order
1103-140A	19" (48 cm)	handles are removable for smaller autoclaves

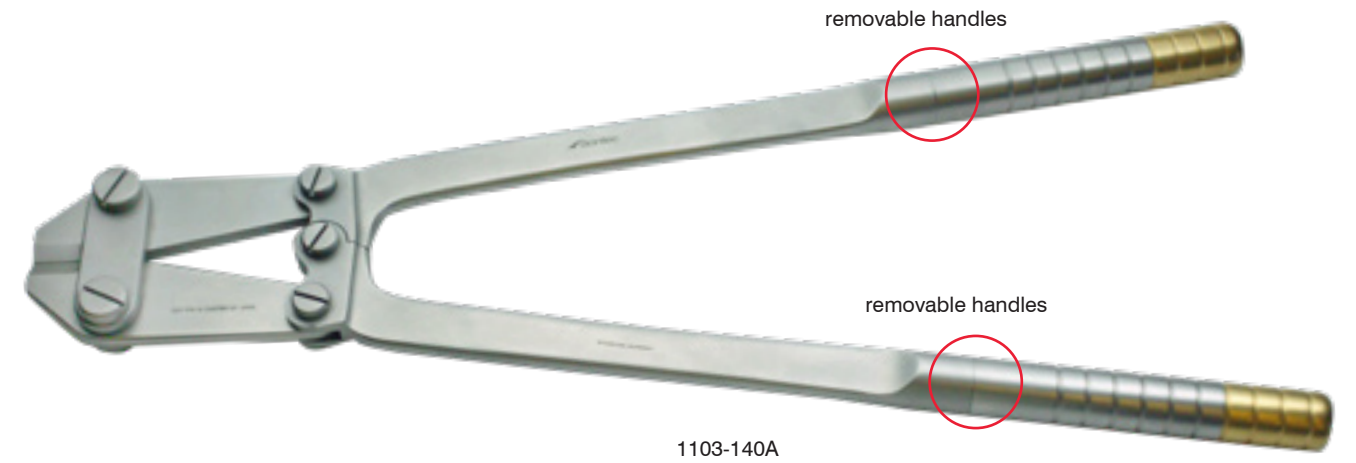

**Pin Cutter Specialty Harden Jaws**

Cuts pins up to 4 mm

1103-140J	15" (38 cm)
-----------	-------------



**Double Action Wire Cutter**

Angled to the side / TC

1100-529 7 1/4" (18 cm)

Cuts wire up to 1.6 mm / TC

1100-530 7" (18 cm)



1100-529

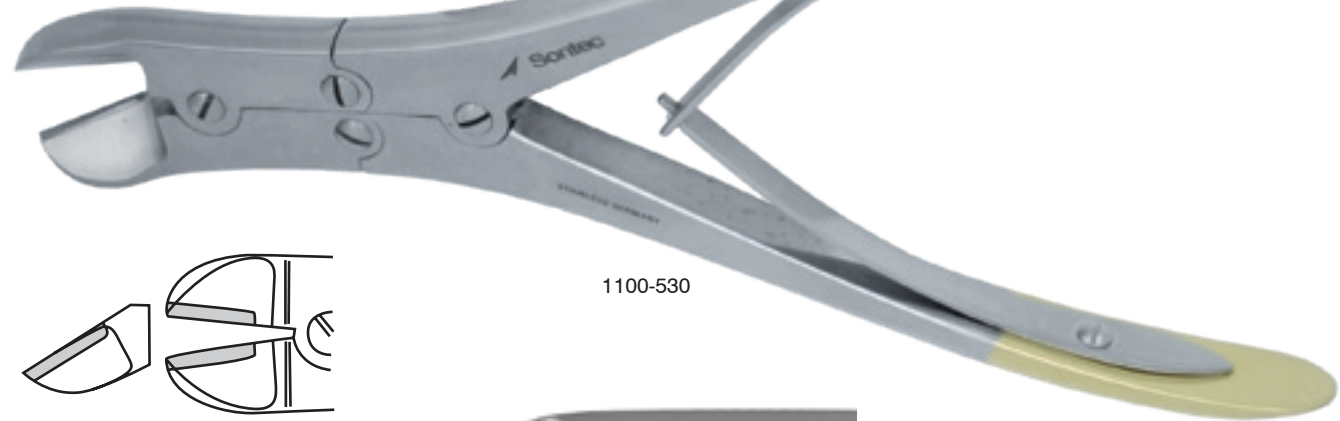

1100-530

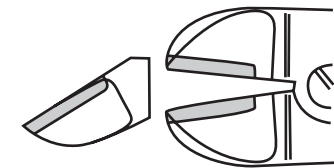

TC / Cuts wire up to 2.2 mm / 8 3/4" (22 cm)

1103-102 15° angle

1103-103V 30° angle



CUT PIN IN CENTER OF JAW

1103-102

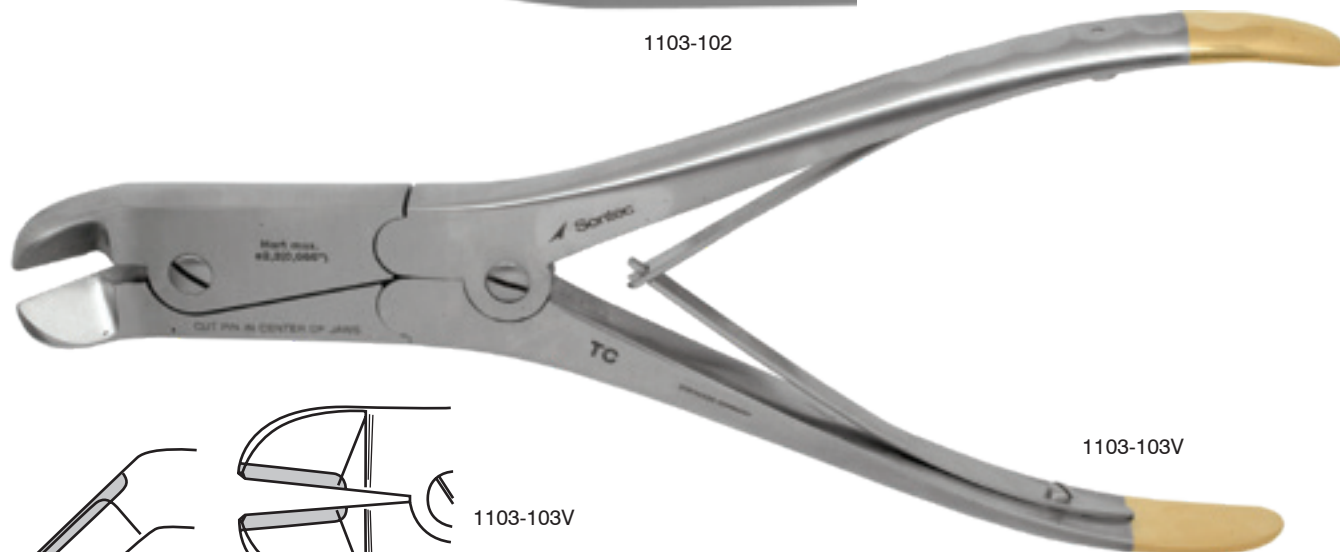

1103-103V

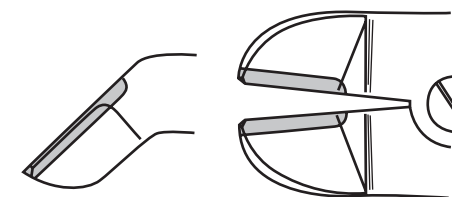

1103-103V

**Sontec Pin Cutter**

With TC inserts / max cap ø 4 mm / 15" (38 cm)

355-209



355-209

**Pin End Cutter**

Cuts pins up to 3 mm / 10" (25 cm)

355-202

Cuts pins up to 4.7 mm / 14" (35.5 cm)

355-210

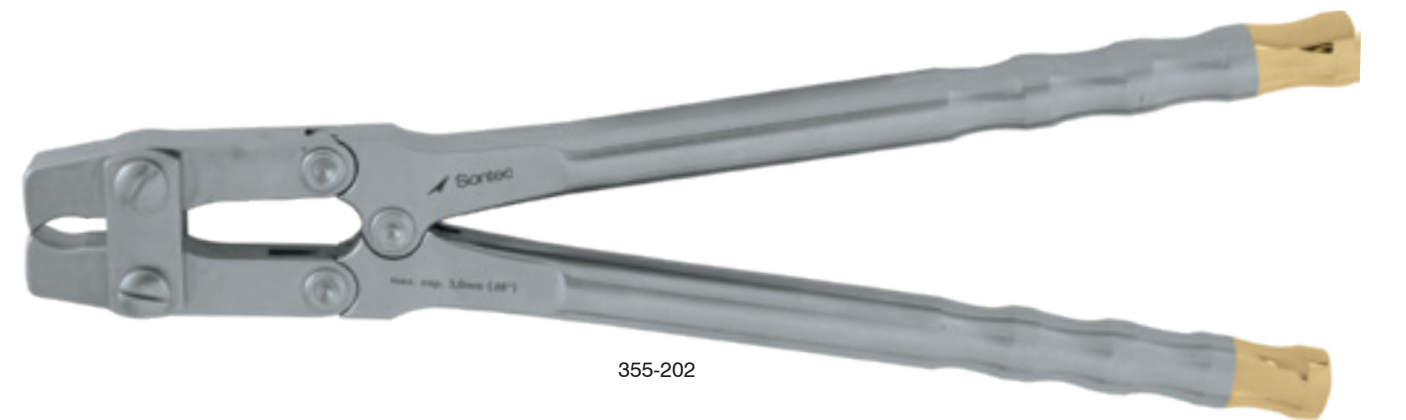

355-202

**Rod Cutter**

Cuts rods  $\varnothing$ 2.5 mm,  $\varnothing$ 3.0 mm,  
 $\varnothing$ 3.5 mm / 11 1/2" (29.2 cm)

355-207



355-207

**Rod Flush Cutter**

With removable handle / cuts rods  $\varnothing$ 4.5  
mm,  $\varnothing$ 5.5 mm,  $\varnothing$ 6.35 mm / 22" (57 cm)

355-211



355-211



**Wire End Cutter**

TC / double-action / 7"  
(18 cm)

1103-107

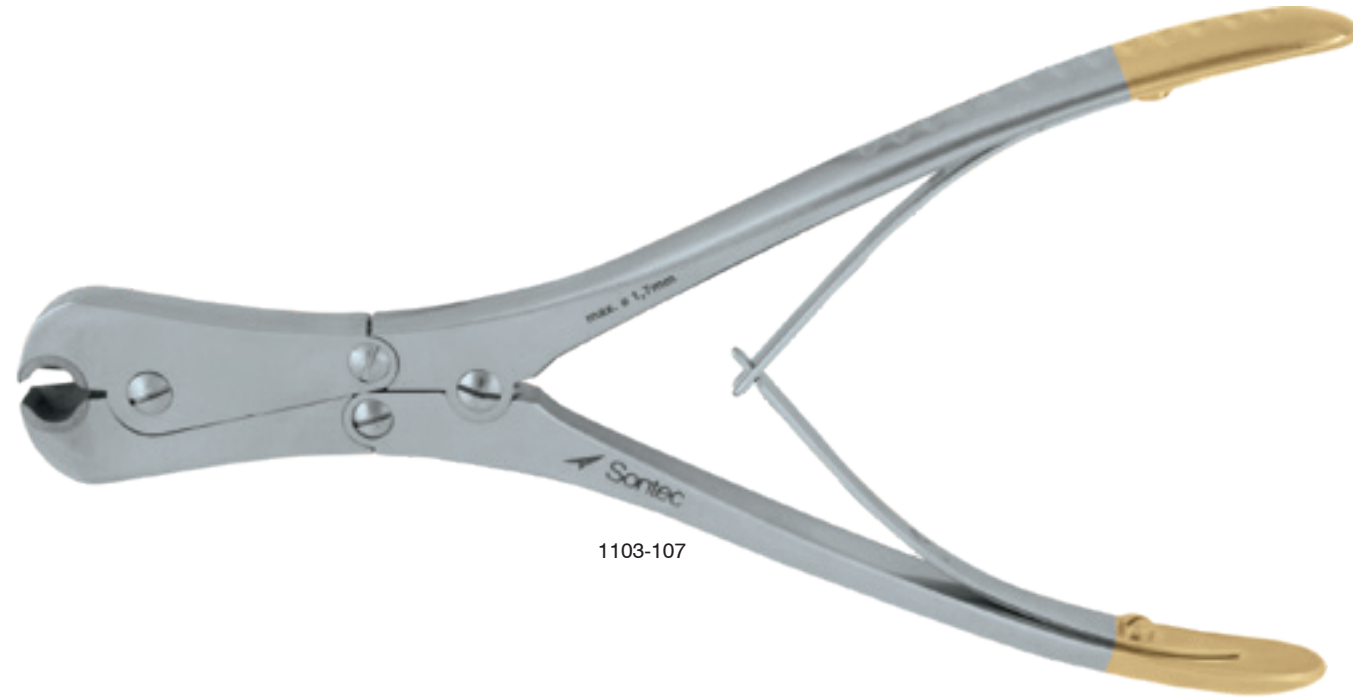

1103-107

**Flush Cut Pin Cutter**

With enclosed cutting design /  
cuts pins up to 4 mm / 12" (30 cm)

1103-117

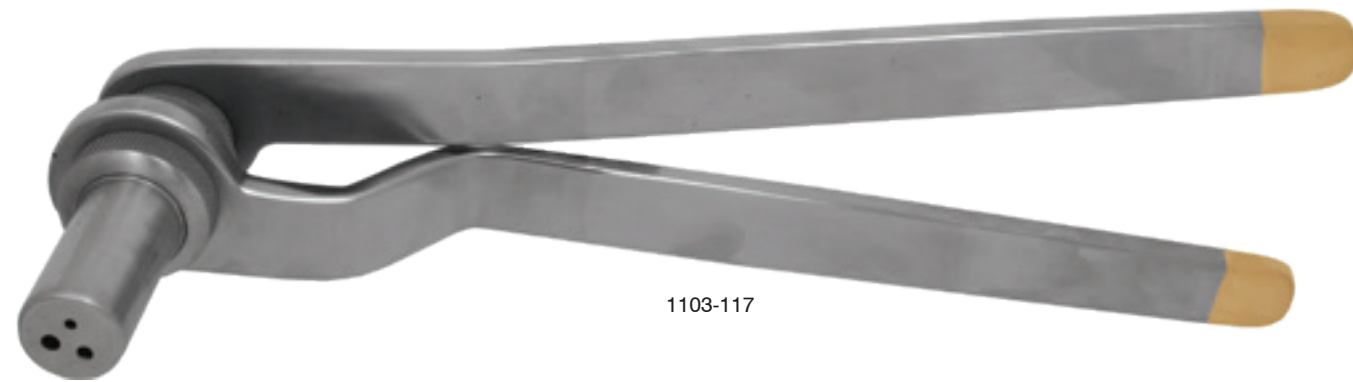

1103-117

**Wire End Cutter**

TC / double-action / cuts wire  
up to 1.5 mm / 6 1/4" (16 cm)

1103-105 mini

TC / double-action / Cuts wire  
up to 2.5 mm / 8 1/2" (21.5 cm)

1103-100 extra large



1103-105

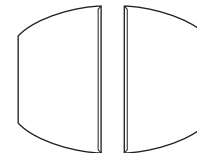

1103-100

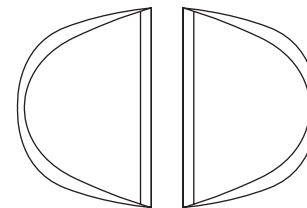

**GOLD-CUT HERCULES® Front & Side Pin Cutter**

Cuts pins up to 1.6 mm / over 40% less power required / exchangeable TC blades with integrated rubber jaws / fully sterilizable / 7" (18 cm)

355-198 front & side cutter  
355-199 TC inserts with Rubber Jaws Replacement Set

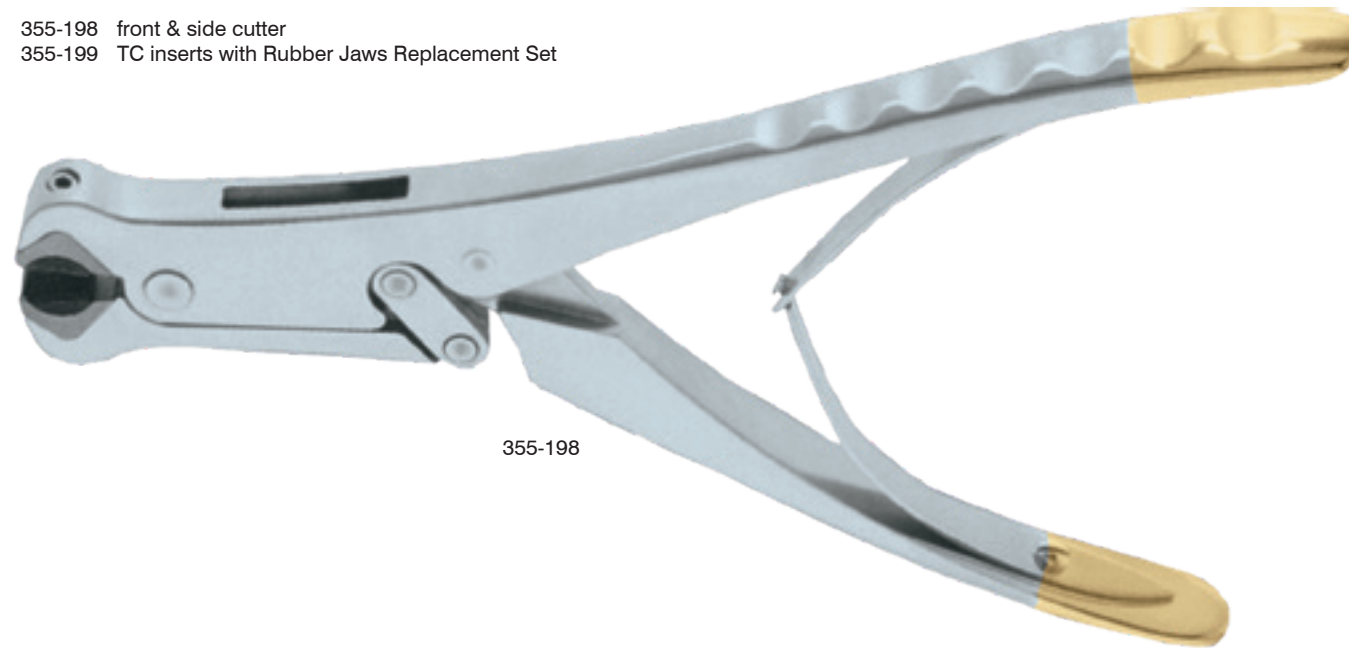

355-198

**TC Blades Replacement Set For Hercules Wire Cutter**

1 pair of TC blades / 1 pair of screws / 1 allen wrench

355-190 for 355-189  
355-192 for 355-191

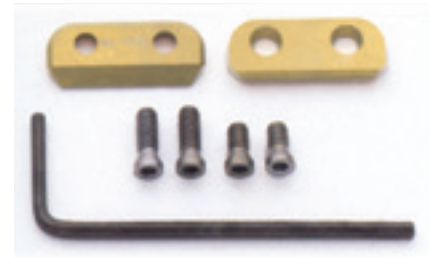

**Rubber Jaws Replacement Set for Hercules Wire Cutter**

1 pair of rubber jaws / 1 pair of screws

355-193 for 355-189 and 355-191



**TC Inserts with Rubber Jaws Replacement Set for Hercules Front & Side Cutter**

1 pair of TC inserts with rubber jaws / 1 pair of screws / 1 allen wrench

355-199 for 355-198



**Table Top Rod Cutter**

Max capacity 6.4 mm (1/4") / select pin size dial selector / cuts pins flush

355-206



355-206



 Sontec Instruments®

Orthopedic WIRE TWISTERS

**Rubio Wire Twister Needle Holder**

Heavy / TC / 5 1/4" (13 cm)  
1103-147



**Obwegeser Wire Twister Needle Holder**

Special order / 5 3/4" (15 cm)  
2300-599

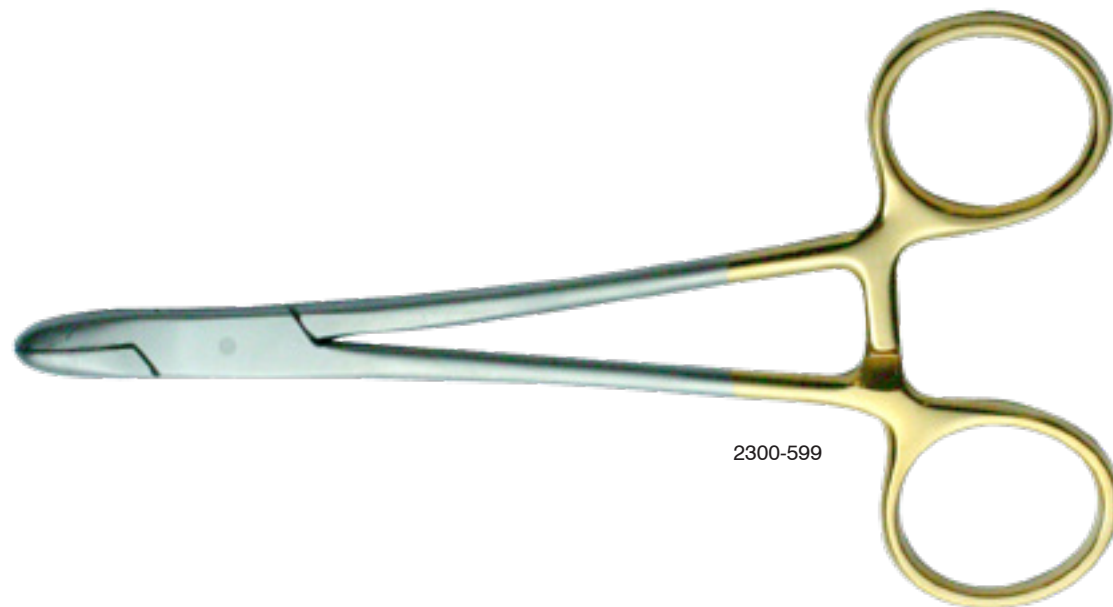

**Sternal Wire Twister Needle Holder**

Broad jaw / TC serrated / can be used as a wire twister  
/ suggested suture size sternal needles and smaller  
1103-154S 5 1/8" (13 cm)  
1103-152 7" (18 cm)  
1103-153 7 3/4" (19.5 cm)



TC Serrated



**New Orleans Wire Twister Needle Holder**

TC serrated / suggested suture size 2-0 and smaller  
2300-600 rounded 6" (15 cm)  
2300-602 blunt 6" (15 cm)  
2300-601 rounded 7" (18 cm)  
2300-604 blunt 7" (18 cm)  
2300-606 rounded 8" (20.5 cm)  
2300-607 blunt 8" (20.5 cm)



rounded



blunt

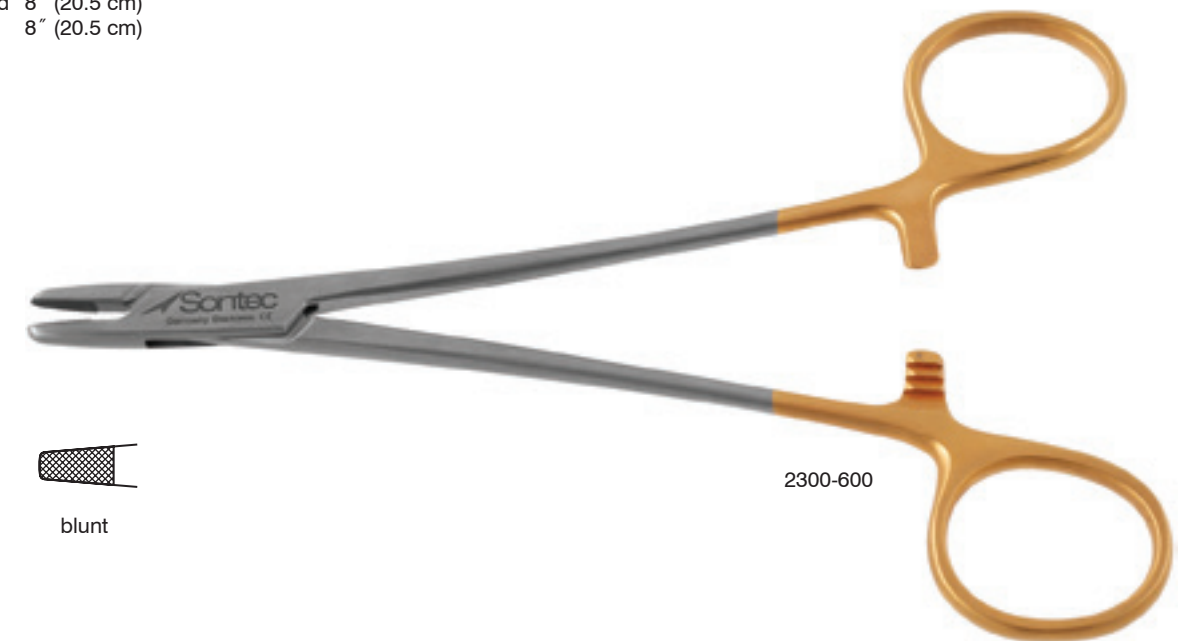

**Anti-Buckle Wire Twister**

TC serrated / w/ guard  
1103-159 7 1/4" (18.5 cm)

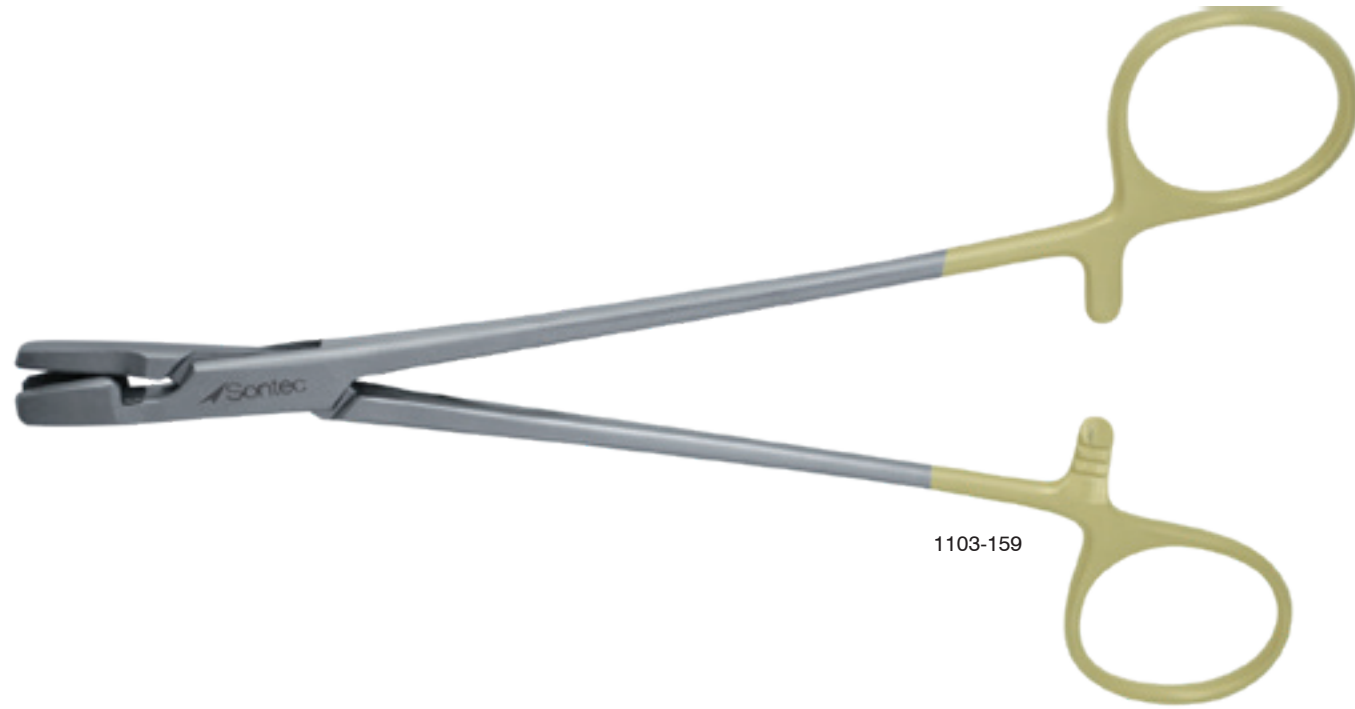

1103-159

**Axel Wire Twister**

Needle holder style / with hole / 6 3/4" (17.1 cm)  
1103-155

Rounded jaw / with hole / heavy duty XXL  
1103-1551 7 1/4" (18.4 cm)  
1103-1552 8" (20.3 cm)

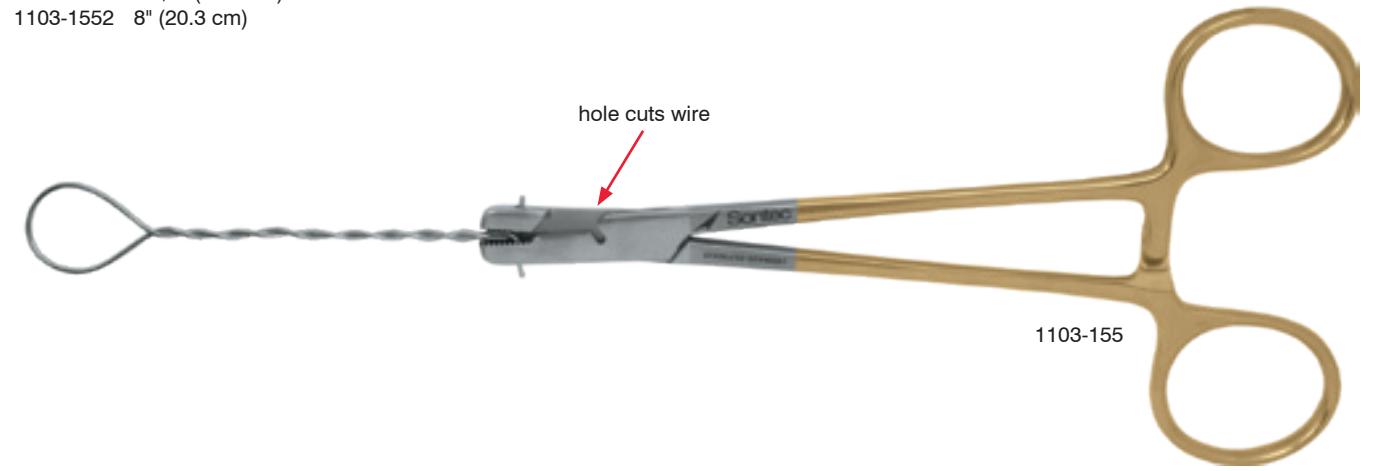

1103-155

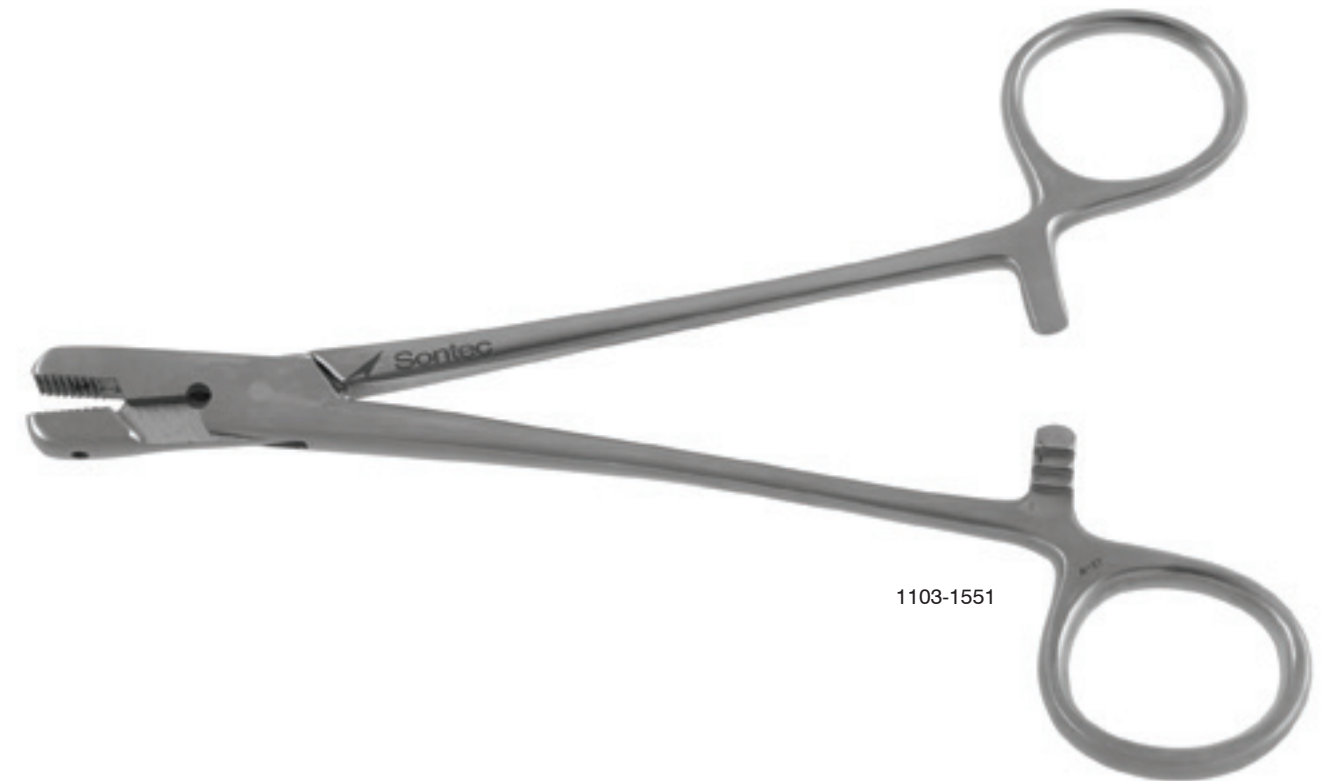

1103-1551

**Wire Twister**

Needle holder style / with hole / 7" (18 cm)  
1103-150



**Mini Jet Wire Twister Needle Holder**

Mayo needle holder style / TC serrated / 6 1/2" (16.5 cm)  
1103-158M

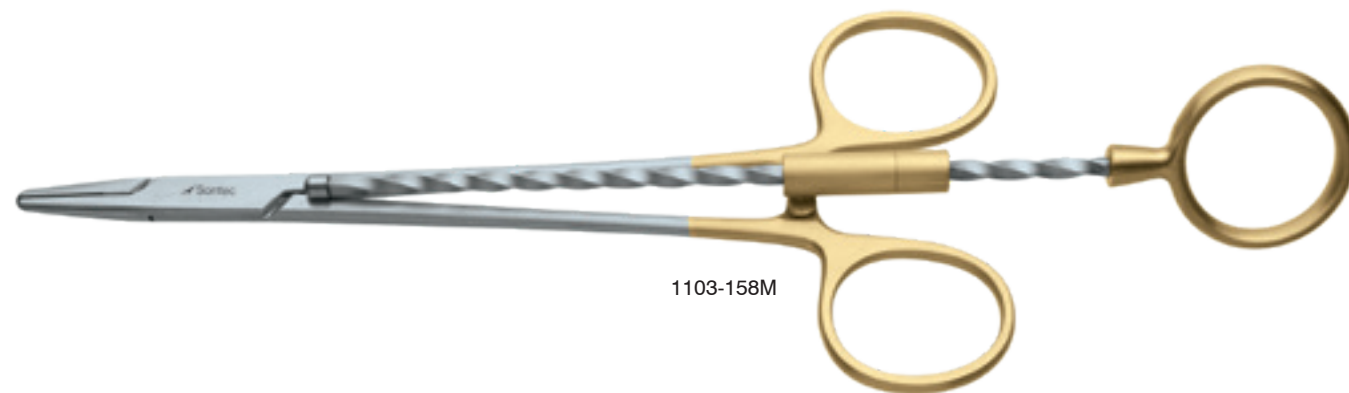

**TC Jet Wire Twister Corkscrew Design Heavy Needle Holder**

Broad jaw / 7" (17.8 cm)  
1103-152A



**Cerclage Torpedo Type Wire Twister**

Stainless / 5" (12.5 cm)  
1100-496



**Bio-Met Wire Twister**

Aluminum handle / 6" (15 cm)  
1103-158B



1103-158B

**Bio-Met Type Wire Twister**

6" (15 cm)  
1103-171



1103-171

**Loute Wire Twister**

Stainless / precise adjustment capabilities / 8 1/2" (22 cm)  
1100-496L

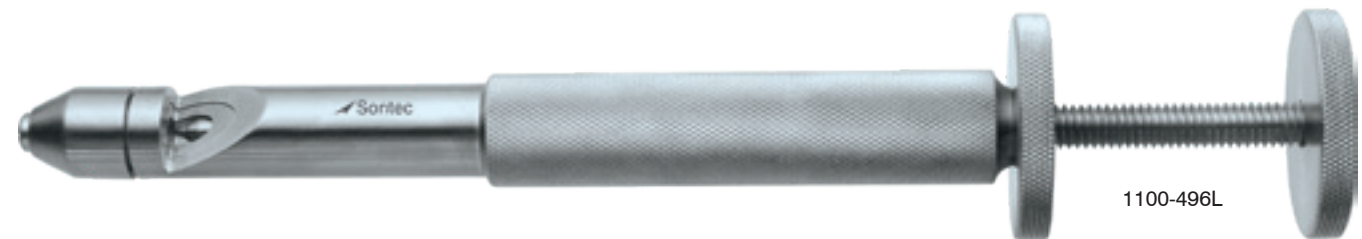

1100-496L

**Jet Wire Twister**

Automatic / 8" (20 cm) / with cutter  
1103-158



1103-158

Spring loaded with ratchet / 11" (28 cm)  
/ without cutter  
1103-158S



1103-158S

**Cerclage Double Torpedo Type Wire Twister**

Stainless / phenolic handle / 9 3/4" (25 cm)  
1100-496D

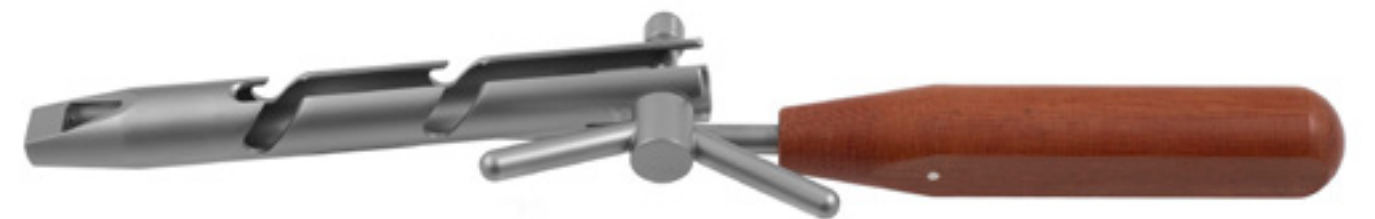

1100-496D



 Sontec Instruments®

ARTHROSCOPIC

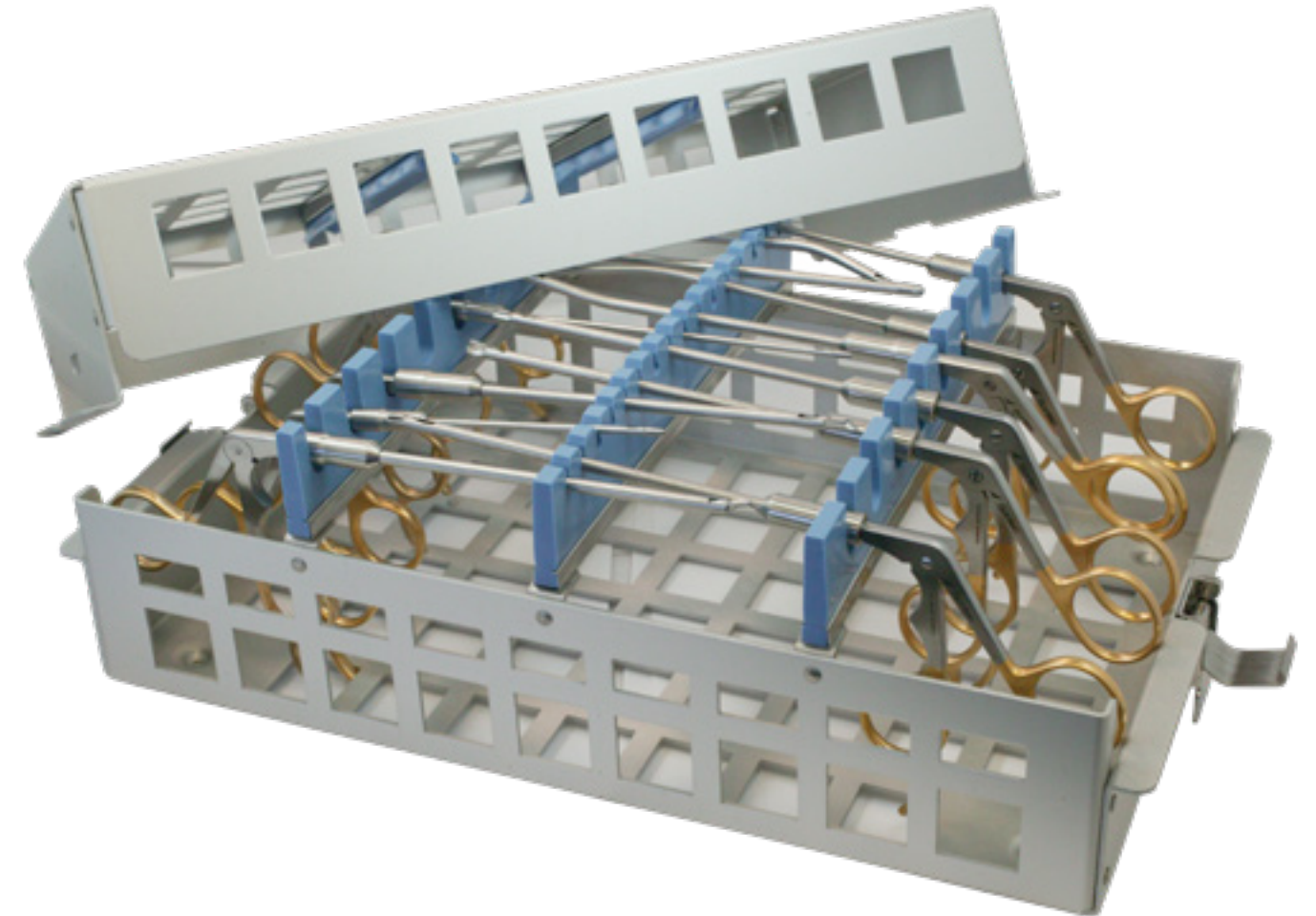

**Complete Arthroscopic sets (including tray) are available upon request. Please contact Sontec for more information.**

**Items shown are examples only. Customer must choose which 16 items to include in the set.**

**Restrictions apply 18-3318 tray only**

**Arthroscopic Hook Punch**

7" (18 cm)

2.7mm - custom size / please call Sontec for availability

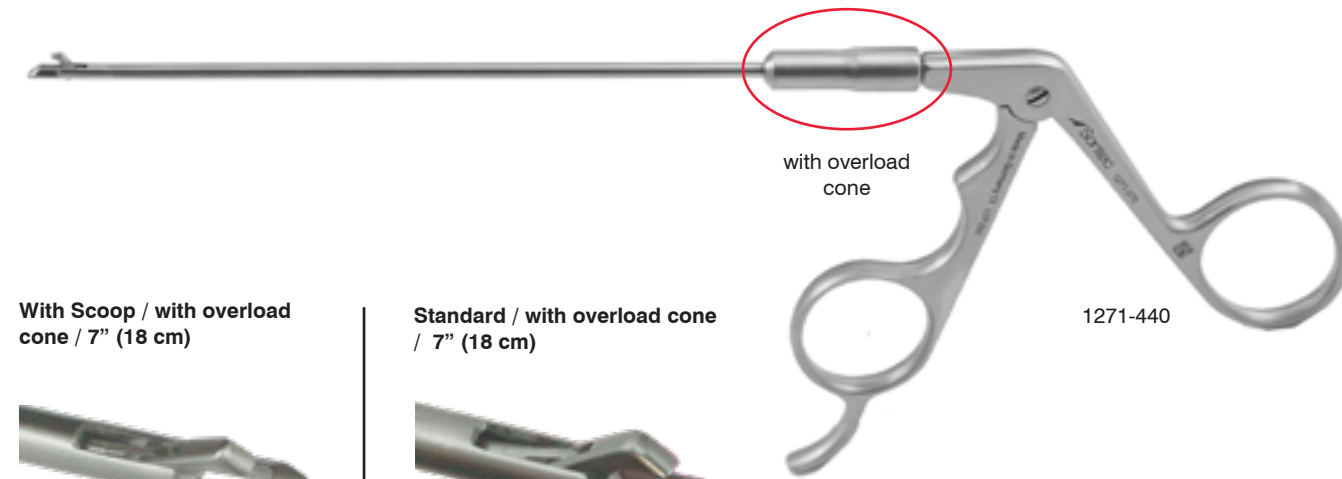

with overload cone

1271-440

**With Scoop / with overload cone / 7" (18 cm)**



**Standard / with overload cone / 7" (18 cm)**



**2.7 mm**

- 1271-370 straight
- 1271-371 30° left
- 1271-372 30° right
- 1271-373 45° left
- 1271-374 45° right
- 1271-375 15° curved up

**2.7 mm**

- 1271-420 straight
- 1271-421 30° left
- 1271-422 30° right
- 1271-423 45° left
- 1271-424 45° right
- 1271-425 15° curved up

**3.4 mm**

- 1271-380 straight
- 1271-381 30° left
- 1271-382 30° right
- 1271-383 45° left
- 1271-384 45° right
- 1271-385 15° curved up

**3.4 mm**

- 1271-430 straight
- 1271-431 30° left
- 1271-432 30° right
- 1271-433 45° left
- 1271-434 45° right
- 1271-435 15° curved up

**4.5 mm**

- 1271-390 straight
- 1271-391 30° left
- 1271-392 30° right
- 1271-393 45° left
- 1271-394 45° right
- 1271-395 15° curved up

**4.5 mm**

- 1271-440 straight
- 1271-441 30° left
- 1271-442 30° right
- 1271-443 45° left
- 1271-444 45° right
- 1271-445 15° curved up

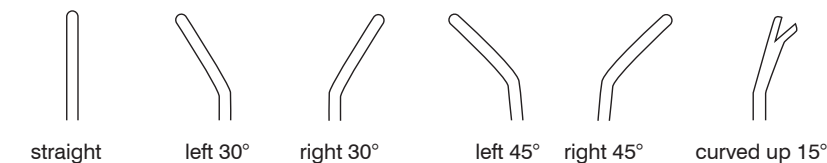

**Arthroscopic Mini Low Profile Hook Punch**

7" (18 cm)

2.7mm - custom size / please call Sontec for availability

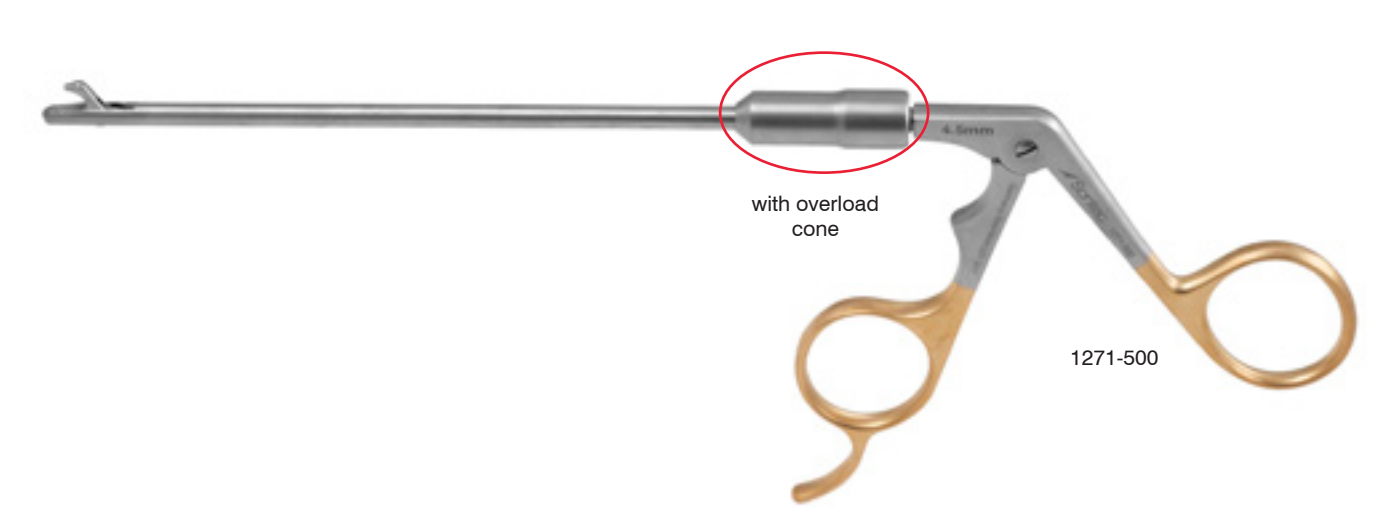

with overload cone

1271-500

**Hook**

**With mini jaw / with overload cone**



**2.7 mm**

- 1271-480 straight
- 1271-481 30° left
- 1271-482 30° right
- 1271-483 45° left
- 1271-484 45° right
- 1271-485 15° curved up

**3.4 mm**

- 1271-490 straight
- 1271-491 30° left
- 1271-492 30° right
- 1271-493 45° left
- 1271-494 45° right
- 1271-495 15° curved up

**4.5 mm**

- 1271-500 straight
- 1271-501 30° left
- 1271-502 30° right
- 1271-503 45° left
- 1271-504 45° right
- 1271-505 15° curved up

**Square Standard**

**With overload cone**



**2.7 mm**

- 1271-350 straight
- 1271-351 30° left
- 1271-352 30° right
- 1271-353 45° left
- 1271-354 45° right
- 1271-355 15° curved up

**3.4 mm**

- 1271-360 straight
- 1271-361 30° left
- 1271-362 30° right
- 1271-363 45° left
- 1271-364 45° right
- 1271-365 15° curved up

**Basket Standard**

**With overload cone**



**3.4 mm**

- 1271-400 straight
- 1271-401 30° left
- 1271-402 30° right
- 1271-403 45° left
- 1271-404 45° right

**4.5 mm**

- 1271-410 straight
- 1271-411 30° left
- 1271-412 30° right
- 1271-413 45° left
- 1271-414 45° right

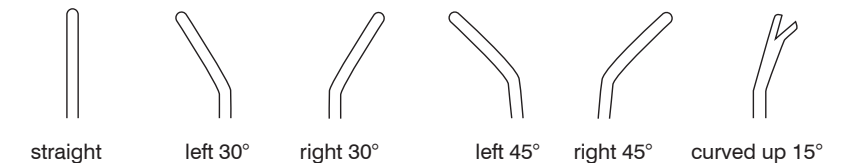

**Arthroscopic Low Profile Toothed Punch**

7" (18 cm)

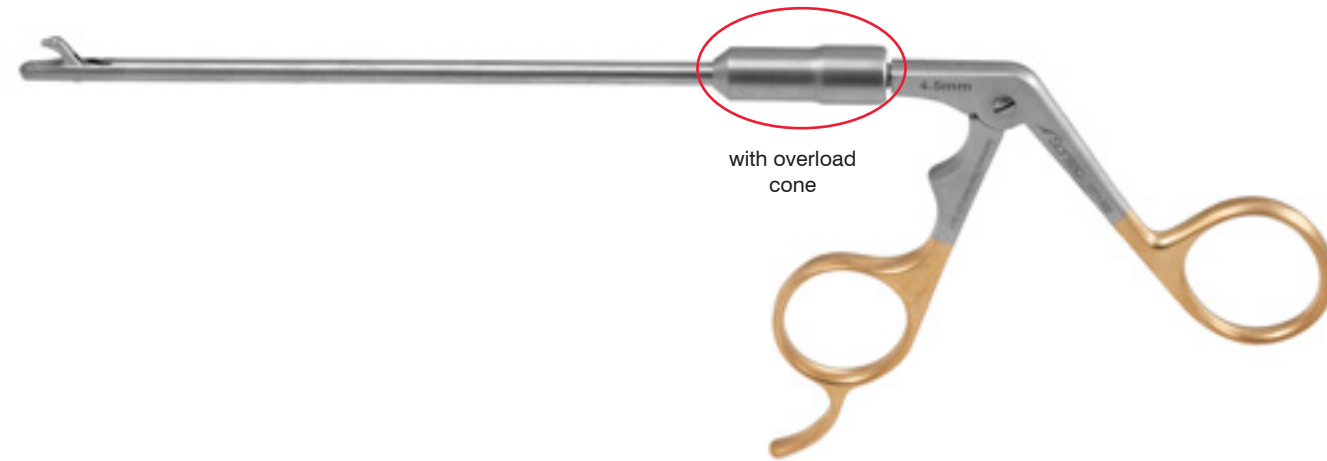

**Punch**

Square bite / curved up / with overload cone

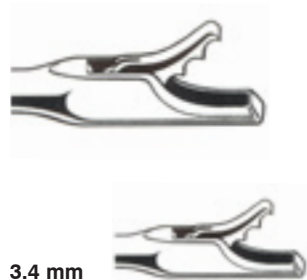

- 3.4 mm**
- 1271-510 straight
  - 1271-511 30° left
  - 1271-512 30° right
  - 1271-513 45° left
  - 1271-514 45° right
  - 1271-515 15° curved up

**Punch**

Square bite / curved up 15° / with overload cone



- 3.4 mm**
- 1271-520 straight
  - 1271-521 30° left
  - 1271-522 30° right
  - 1271-523 45° left
  - 1271-524 45° right
  - 1271-525 15° curved up

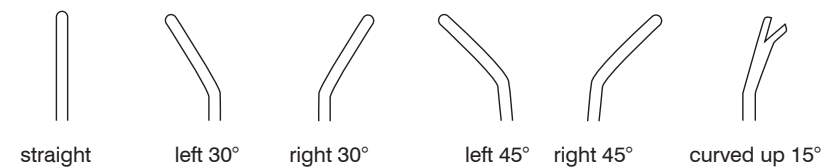

**Arthroscopic Right Left Side Punch**

With overload cone / 7" (18 cm)



**Standard / 3.4 mm jaw**



**Left angled**

- 1271-530 straight
- 1271-531 30° left
- 1271-532 30° right
- 1271-533 45° left
- 1271-534 45° right
- 1271-535 15° curved up

**Standard / 3.4 mm jaw**



**Right angled**

- 1271-540 straight
- 1271-541 30° left
- 1271-542 30° right
- 1271-543 45° left
- 1271-544 45° right
- 1271-545 15° curved up

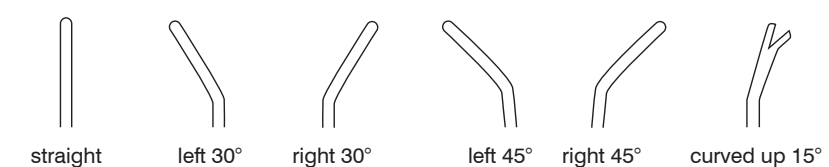

**Arthroscopic Metzenbaum Hook Scissors**

7" (18 cm)

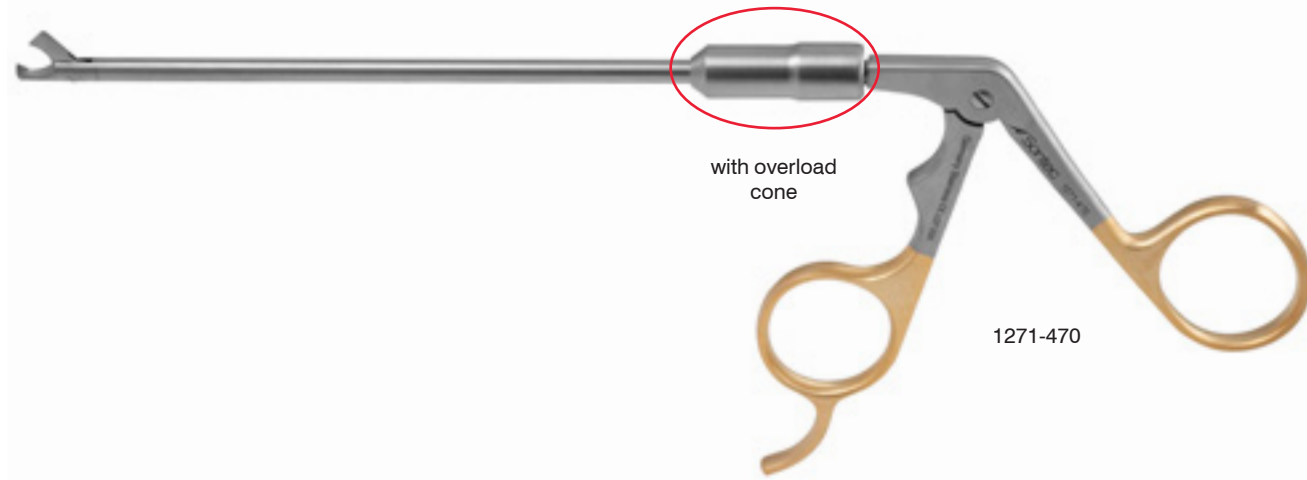

with overload cone

1271-470

**Hook Scissors / with overload cone**



**2.7 mm**

- 1271-450 straight
- 1271-451 30° left
- 1271-452 30° right
- 1271-453 45° left
- 1271-454 45° right

**3.4 mm**

- 1271-460 straight
- 1271-461 30° left
- 1271-462 30° right
- 1271-463 45° left
- 1271-464 45° right

**4.5 mm**

- 1271-470 straight
- 1271-471 30° left
- 1271-472 30° right
- 1271-473 45° left
- 1271-474 45° right

**Straight / with overload cone / metzenbaum blades**



**3.4 mm**

- 1271-550 straight
- 1271-551 30° left
- 1271-552 30° right
- 1271-553 45° left
- 1271-554 45° right
- 1271-555 15° curved up

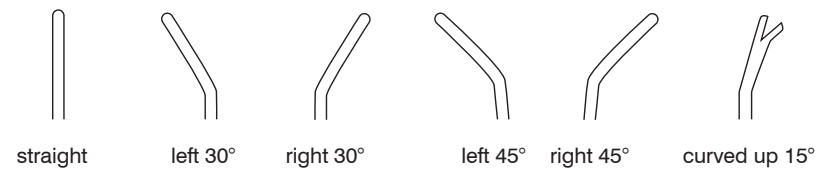

**Arthroscopic, Forceps, Biopsy & Grasping Rongeur Forceps**

**Biopsy grasper forceps / tubular shaft / serrated bite**

- 1271-020 2.0 mm cup 4" (10 cm) shaft
- 1271-016 2.7 mm cup 4" (10 cm) shaft
- 1271-018 3.4 mm cup 4" (10 cm) shaft
- 1271-021 2.0 mm cup 6" (15.5 cm) shaft
- 1271-021A 2.0 mm cup 6" (15.5 cm) shaft rear actuator hand

\* Available in 4.5 mm, please ask for details

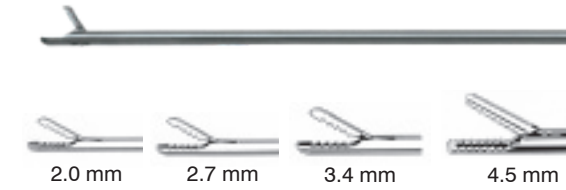

**Tubular 4" (10 cm) shaft / 2.0 mm cup**

- 1271-005 grasping forceps
- 1271-005A grasping forceps rear actuator handle 6"
- 1271-006 fine scissors
- 1271-007 basket punch
- 1271-008 round punch





















All tubular shaft instruments available upon request with rear actuator handles

1271-005A

**Arthroscopic Punch & Scissors**

Overload cone for added strength / 5 3/4" (14.5 cm)  
shaft measurement is from jaw to overload cone

		Straight	Left 30°	Right 30°	Left 45°	Right 45°	wCurved Up 15°
							
<b>Square Punch</b>	2.7 mm 	1271-350	1271-351	1271-352	1271-353	1271-354	1271-355
	3.4 mm 	1271-360	1271-361	1271-362	1271-362	1271-364	1271-365
<b>Hook Punch with Scop</b>	2.7 mm 	1271-370	1271-371	1271-372	1271-373	1271-374	1271-375
	3.4 mm 	1271-380	1271-381	1271-382	1271-383	1271-384	1271-385
	4.5 mm 	1271-390	1271-391	1271-392	1271-393	1271-394	1271-395
<b>Basket Punch</b>	3.4 mm 	1271-400	1271-401	1271-402	1271-403	1271-404	
	4.5 mm 	1271-410	1271-411	1271-412	1271-413	1271-414	
<b>Hook Punch</b>	2.7 mm 	1271-420	1271-421	1271-422	1271-423	1271-424	1271-425
	3.4 mm 	1271-430	1271-431	1271-432	1271-433	1271-434	1271-435
	4.5 mm 	1271-440	1271-441	1271-442	1271-443	1271-444	1271-445
<b>Hook Scissors</b>	2.7 mm 	1271-450	1271-451	1271-452	1271-453	1271-454	
	3.4 mm 	1271-460	1271-461	1271-462	1271-463	1271-464	
	4.5 mm 	1271-470	1271-471	1271-472	1271-473	1271-474	



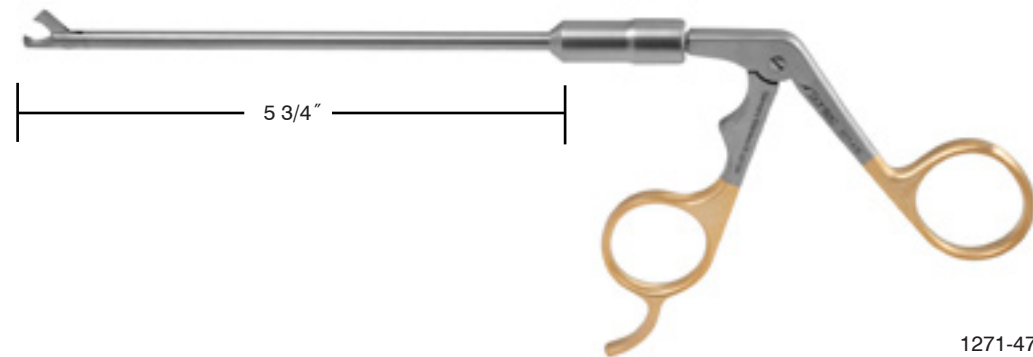











continues on next page



1271-470

**Arthroscopic Punch Rongeur**

Overload cone for added strength / 5 3/4" (14.5 cm)  
shaft measurement is from jaw to overload cone

		Straight	Left 30°	Right 30°	Left 45°	Right 45°	wCurved Up 15°
							
<b>Hook Punch with Mini Jaw</b>	2.7 mm 	1271-480	1271-481	1271-482	1271-483	1271-484	1271-485
	3.4 mm 	1271-490	1271-491	1271-492	1271-493	1271-494	1271-495
	4.5 mm 	1271-500	1271-501	1271-502	1271-503	1271-504	1271-505
<b>Square Bite / curved up</b>	3.4 mm 	1271-510	1271-511	1271-512	1271-513	1271-514	1271-515
<b>Square Bit / curved up 15°</b>	3.4 mm 	1271-520	1271-521	1271-522	1271-523	1271-524	1271-525
<b>Side punch / left</b>	3.4 mm 	1271-530	1271-531	1271-532	1271-533	1271-534	1271-535
<b>Side Punch / right</b>	3.4 mm 	1271-540	1271-541	1271-542	1271-543	1271-544	1271-545
<b>Scissor, / straight</b>	3.4 mm 	1271-550	1271-551	1271-552	1271-553	1271-554	1271-555

**Arthroscopic Grasping Forceps**

Overload cone / available with or without ratchet /  
5 3/4" (14.5 cm) shaft

<b>Grasping Forcep</b>								
	2.7 mm		1271-060	1271-061	1271-062	1271-063	1271-064	1271-085
	3.4 mm		1271-065	1271-066	1271-067	1271-068	1271-069	1271-086
	4.5 mm		1271-070	1271-071	1271-072	1271-073	1271-074	1271-087
	3.4 mm / 1x2 tth		1271-610	1271-611	1271-612	1271-613	1271-614	1271-615
	4.5 mm / 1x2 tth		1271-620	1271-621	1271-622	1271-623	1271-624	1271-625
<b>Grasping Forcep with ratchet</b>								
	2.7 mm		1271-060R	1271-061R	1271-062R	1271-063R	1271-064R	1271-085R
	3.4 mm		1271-065R	1271-066R	1271-067R	1271-068R	1271-069R	1271-086R
	4.5 mm		1271-070R	1271-071R	1271-072R	1271-073R	1271-074R	1271-087R
	3.4 mm / 1x2 tth		1271-640	1271-641	1271-642	1271-643	1271-644	1271-645
	4.5 mm / 1x2 tth		1271-650	1271-651	1271-652	1271-653	1271-654	1271-655
<b>Biopsy &amp; Grasping Forceps</b>								
	2.7 mm		1271-090	1271-091	1271-092	1271-093	1271-094	1271-095
	3.4 mm		1271-101	1271-102	1271-103	1271-104	1271-105	1271-106
	4.5 mm		1271-107	1271-108	1271-109	1271-110	1271-111	1271-112

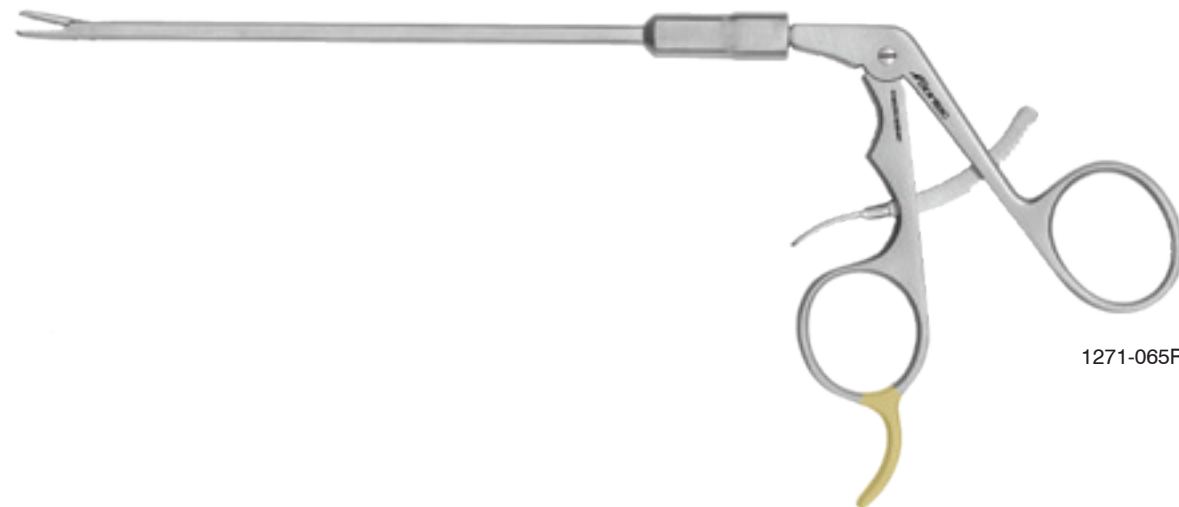

1271-065R

**Arthroscopic Grasping Forceps**

Overload cone / for small joints / available with or  
without ratchet / 4" (10 cm) shaft

<b>Grasping Forcep</b>								
	2.7 mm		1270-060	1270-061	1270-062	1270-063	1270-064	1270-085
	3.4 mm		1270-065	1270-066	1270-067	1270-068	1270-069	1270-086
	4.5 mm		1270-070	1270-071	1270-072	1270-073	1270-074	1270-087
<b>Grasping Forcep with ratchet</b>								
	2.7 mm		1270-060R	1270-061R	1270-062R	1270-063R	1270-064R	1270-085R
	3.4 mm		1270-065R	1270-066R	1270-067R	1270-068R	1270-069R	1270-086R
	4.5 mm		1270-070R	1270-071R	1270-072R	1270-073R	1270-074R	1270-87R
<b>Biopsy &amp; Grasping Forceps</b>								
	2.7 mm		1270-090	1270-091	1270-092	1270-093	1270-094	1270-095
	3.4 mm		1270-101	1270-102	1270-103	1270-104	1270-105	1270-106
	4.5 mm		1270-107	1270-108	1270-109	1270-110	1270-111	1270-112



1270-060

**Arthroscopic Biopsy Grasping Forceps**

**Straight / 2.7 mm jaw / overload cone / with ratchet / 4" (10 cm) shaft**  
1270-090R

**Straight / 2.7 mm jaw / overload cone / with ratchet / 7" (18 cm) shaft**  
1271-090R



**Arthroscopic Biopsy Grasping Forceps**

**Overload cone / 3.4 mm jaw / available with or without ratchet / 4" (18 cm) shaft**  
1270-101R

**Overload cone / 3.4 mm jaw / available with or without ratchet / 7" (18 cm) shaft**  
1271-101R



**Arthroscopic Biopsy Grasping Forceps**

**Straight / 4.5 mm jaw / overload cone / with ratchet / 3 1/4" (8.25 cm) working shaft length**  
1270-107R

**Straight / 4.5 mm jaw / overload cone / with ratchet / 7" (18 cm) working shaft length**  
1271-107R



**Suction Arthroscopic Cut Through Punch Rongeur**

**5° up / 4" (20 cm) shaft / comes with stylus**  
1271-040 2.5 mm jaw

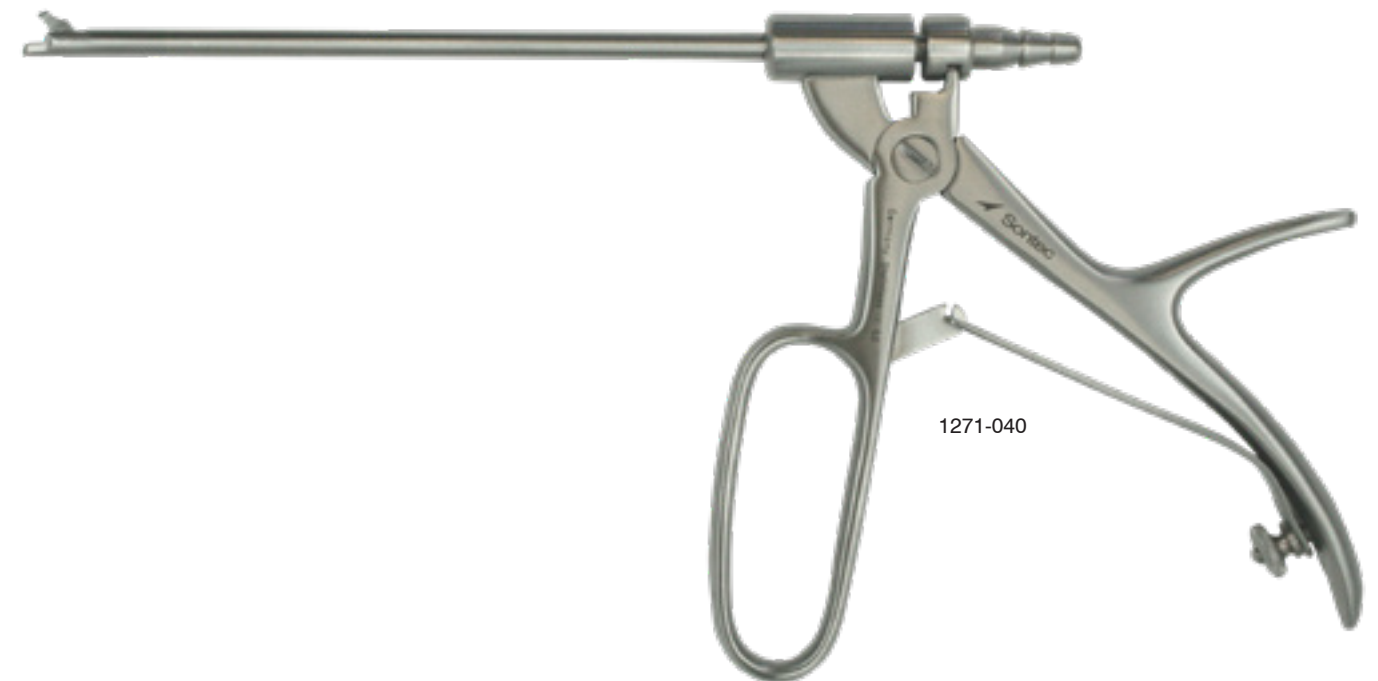

**Suction Arthroscopic Cut Through Punch Rongeur**

5° up / 5 mm Ø shaft / 140 mm working length

1271-042 3 mm jaw



**McIlwraith Suction Arthroscopic Cut Through Punch Rongeur**

5° up / 5" shaft / extra long bore 5 mm I.D.

1271-041 5 mm jaw



**Arthroscopic Needle Holder**

With clean flush port / TC serrated jaw / curved

1271-113



**Hook Punch**

2.7 mm / straight / with overload cone / 5" (12.7 cm)

1271-426



**Arthroscopic Maxi Grasper**

Large serrated teeth / crab claw jaws / open center jaw 18 mm elliptical gap when jaws are fully closed / 7" (18 cm)

404-765



404-765

**Arthroscopic Mini Grasper**

Serrated upper jaw with smooth lower jaw / crab claw jaw / 18 mm jaw / 6" (15.2 cm)

404-764



404-764

**Meniscus Grasping Forceps**

Axial, ring handled grip / serrated jaw / 1 x 2 teeth / 7" (18 cm)

- 1404-852 straight
- 1404-854 curved left
- 1404-853 curved right



1404-852

1404-853

1404-854

**Rotary Arthroscopic Scissors**

- 1273-100 hook left 20°
- 1273-101 hook right 20°
- 1273-103 hook right 60°
- 1273-105 hook left 60°



1273-100

1273-103

**Triangle Handle Arthroscopic Meniscotome, Hook, Probe & Knife**

9 1/4" (23.5 cm) / triangle handle

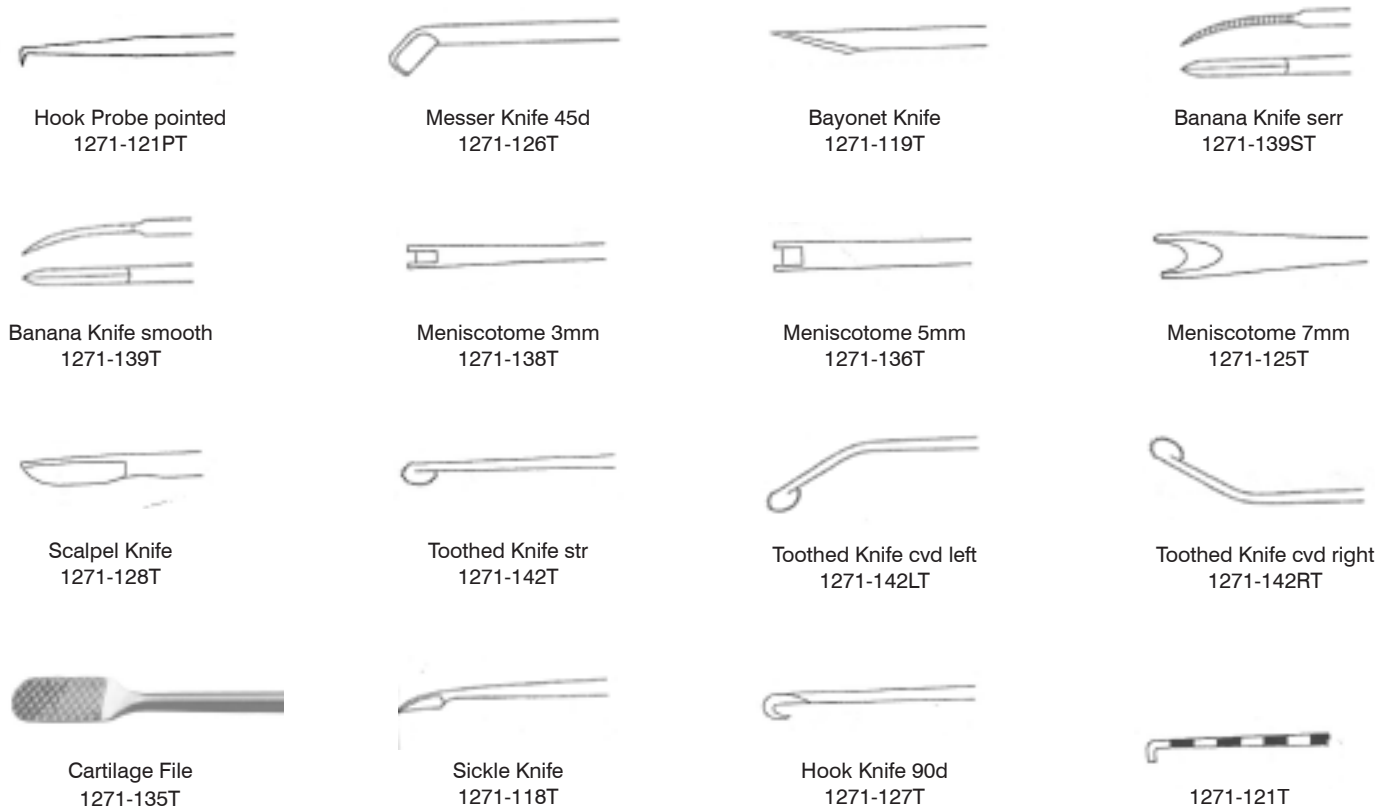

**Arthroscopic Meniscotomes Hook, Probe & Knife**

9" (23 cm) / knurled handle sold separately



**Arthroscopic Meniscotomes Hook, Probe & Knife**

9" (23 cm) / handle sold separately / fit universal handle / choose either knurled handle or universal handle-shaft combination

1271-143 universal handle sold separately 4 3/4"  
 1271-143L universal handle extra long 8" special order



1271-143



1271-143L



Sickle 1271-118U



Bayonet 1271-119U



Meniscotome 1271-125U



45° 1271-126U



Hook 1271-127U



Scalpel 1271-128U



Meniscotome 1271-136U



Meniscotome 1271-138U



Banana 1271-139U



Banana Serrated 1271-139SU



Toothed 1271-142U

**Arthroscopic Curette & Ring Curette**

9 1/4" (23.5 cm) / triangle handle

1271-116T 30 degrees  
 1271-148S 3 mm ring tip  
 1271-148T 7 mm ring tip 30°

9 1/4" (23.5 cm) / triangle handle / 30°

1271-149 5 mm ring tip



1271-116T



1271-148S



1271-148T



1271-149

**Knurled handle / 3 mm / 9" (23 cm)**

1271-115 30° curved curette  
 1271-140 right angled sharp ring tip

**"U" Fit universal handle / 3 mm / 9" (23 cm)**

1271-116U 30° curved curette  
 1271-140U right angled sharp ring tip

**Universal handle sold separately**

1271-143 universal handle sold separately



1271-115

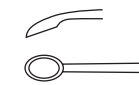

1271-115



1271-140



1271-143

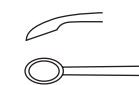

1271-116U



1271-140U

**Arthroscopic Hook Probe**

9" (23 cm)

1271-121	3.5 mm	knurled handle
1271-122	2.5 mm	knurled handle
1271-122U	2.5 mm	for universal handle
1271-121U	3.5 mm	for universal handle
1271-1204U	4 mm	for universal handle
1271-120U	5 mm	for universal handle

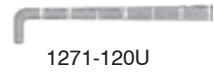
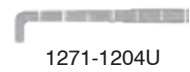
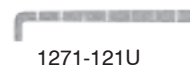
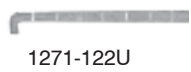

**Arthroscopic Rasp**

Item numbers followed by "U" fit universal handle / 9" (23 cm)

1271-134	
1271-143	universal handle sold separately

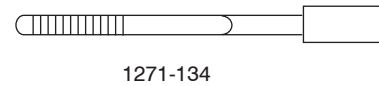

**Arthroscopic Hook Probe with Conical Handle**

3.5 mm tip

1271-121A	4 1/2"
1271-121B	6"
1271-121C	7 1/2"

4 mm tip Ø

1271-1218	8 1/4"
-----------	--------



**McIlwraith Arthroscopic Hook Probe**

Graduated / light / 9 1/2" (24 cm)

1271-129



Graduated / heavy / 10 1/2" (26 cm)

1271-130



Phenolic handle / 10 1/4" (26 cm)

1271-130PH



**Taylor Micro Arthroscopic Hook Probe & Pick**

1.2mm / 8" (20 cm)

1271-120	straight
1271-123	curved

3 mm hook / 1 mm ball tip / lightweight type handle / 8 1/2" (21.5 cm)

1271-123LW



### Arthroscopic Rasp

Item numbers followed by "U" fit universal handle / 4x6 mm / 9" (23 cm)

- 1271-133U straight
- 1271-133AU 15° angle
- 1271-143 universal handle sold separately

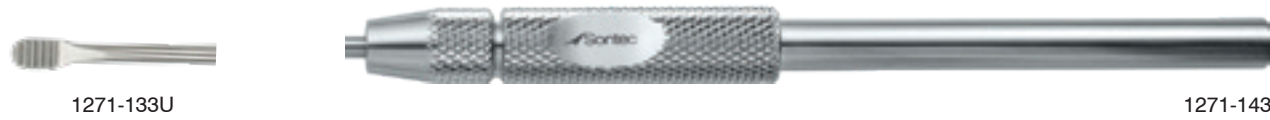

### Chondro Pick

Silicone handle / 6 mm Ø shaft / 125 mm working length / 9" (23 cm) overall length

Specifically designed for the treatment of micro fracture cartilage defects on large and medium joints

- 1271-315 straight
- 1271-316 25° angled tip
- 1271-317 40° angled tip
- 1271-318 60° angled tip
- 1271-319 90° angled tip



### Bone Pick Micro Fracture

Phenolic handle / 30° tip

- 1271-320 6 7/8" (17.5 cm) mini
- 1271-330 7 1/2" (19 cm) peterson
- 1271-325 10 3/4" (27.5cm) equine

Phenolic handle / 60° tip

- 1271-321 6 7/8" (17.1 cm)
- 1271-322 7 1/2" (19.1 cm)
- 1271-326 10 3/4" (27.3 cm)

Phenolic handle / 90° tip

- 1271-323 6 7/8" (17.1 cm)
- 1271-324 7 1/2" (19.1 cm)
- 1271-327 10 3/4" (27.3 cm)



### Inflow Cannula Set

Set includes a sharp and blunt cannula

- SC95-0300-SET 4.5 mm includes infusion adapter complete set
- SC95-0305 4.5 mm infusion adapter only
- SC95-0302-SET 5.5 mm includes infusion adapter complete set
- SC95-0306 5.5 mm infusion adapter only

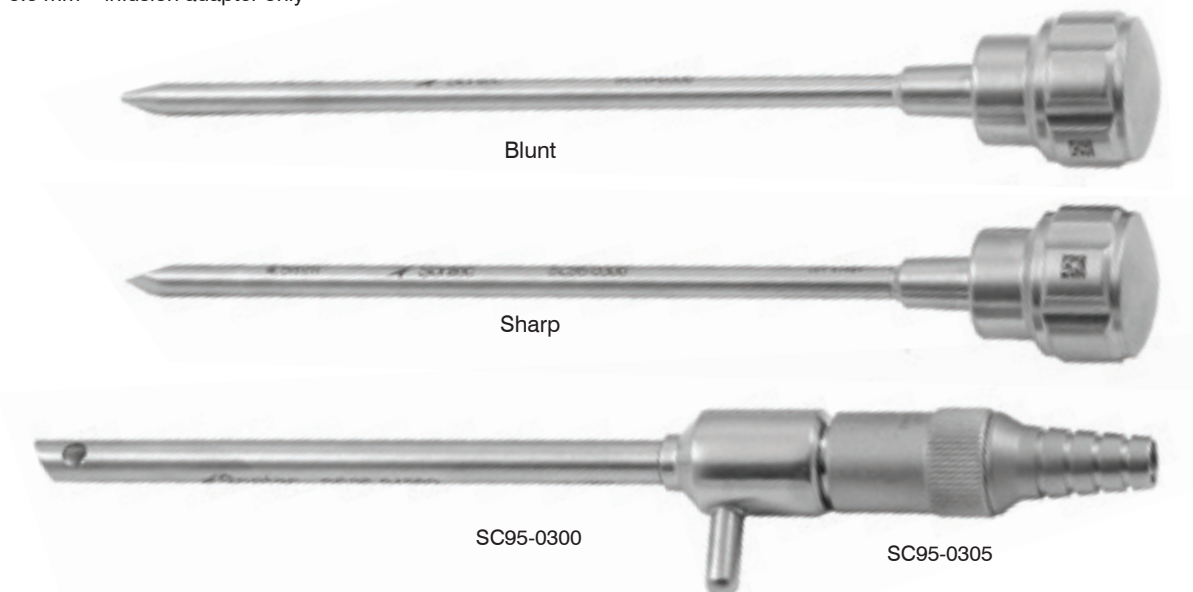

**Egress Cannula Set**

Cutting obturator / lateral irrigation holes / 2 3/4" (7 cm) working length / set includes a sharp and blunt cannula

SC95-0310-SET	3.2 mm diameter	without stop cock	special order
SC95-0315-SET	3.2 mm diameter	with stop cock	
SC95-0415-SET	4.5 mm diameter	with stop cock	

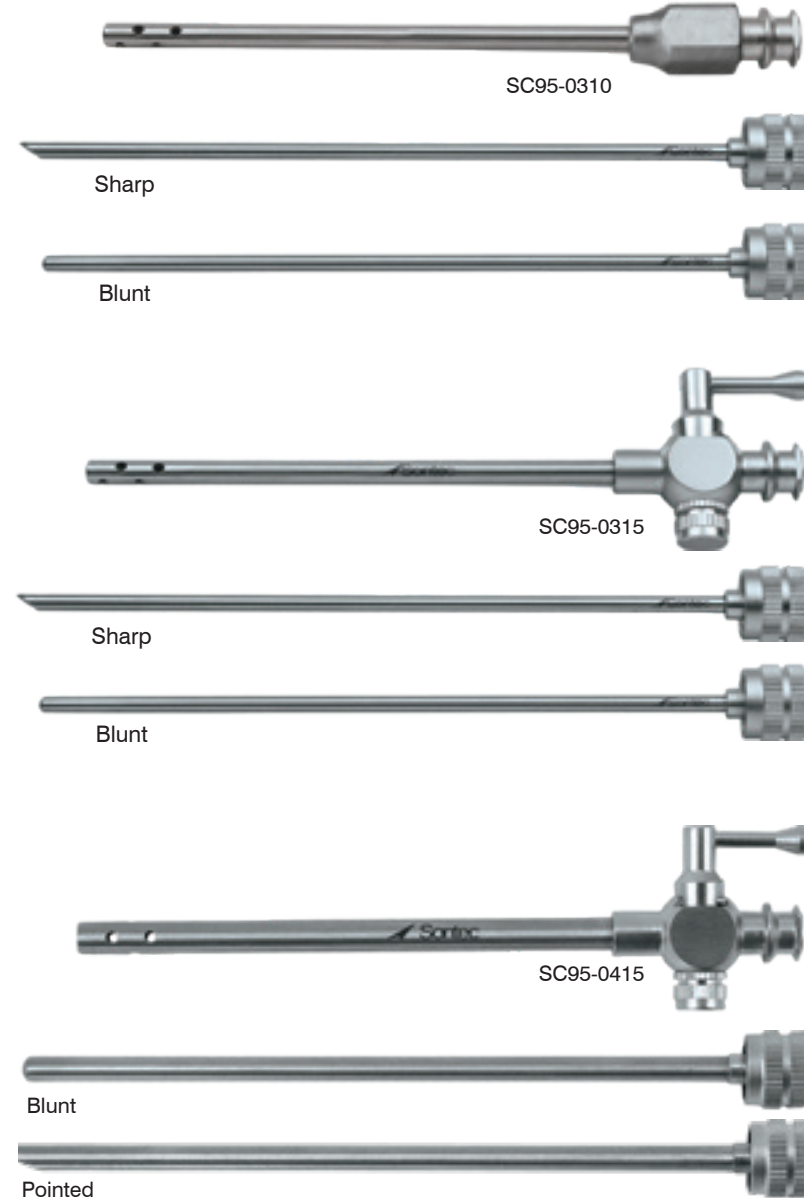

**Egress Cannula Set**

With conical obturator / 6" (15.2 cm) working length

SC94-0312	3.1 mm ID
SC94-0313	4.1 mm ID
SC94-0314	5.1 mm ID
SC94-0315	6.1 mm ID
SC94-03157	7.1 mm ID
SC94-03158	8.1 mm ID
SC94-03159	9.1 mm ID

With Conical obturator / 12" (30.5 cm) working length

SC94-0316	3.1 mm ID
SC94-0317	4.1 mm ID
SC94-0318	5.1 mm ID
SC94-0319	6.1 mm ID
SC94-0320	7.1 mm ID
SC94-0321	8.1 mm ID
SC94-0322	9.1 mm ID

\* CUSTOM - specify size (diameter & length) when ordering

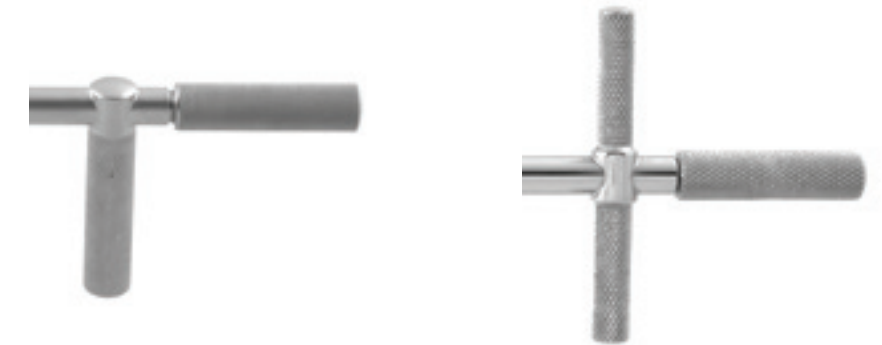

available with T-handle or L-handle shown above



**Arthroscopic Switch Stick**

8 3/4"

1271-117-1	1.1mm
1271-117-5	2.4mm
1271-117-2	2.9mm
1271-117	3.2mm
1271-117-3	3.7mm

Set of 5 / 8 3/4"

1271-117-4 sizes in set:

1.1mm
2.4mm
2.9mm
3.2mm
3.7mm



1271-117

### Small Joint Arthroscopic Cannula Switch Stick Set

Complete with 4 cannulas, 4 switch sticks, cannulated obturator, and lightweight anodized case

SC95-0425

\*Instruments are also available separately

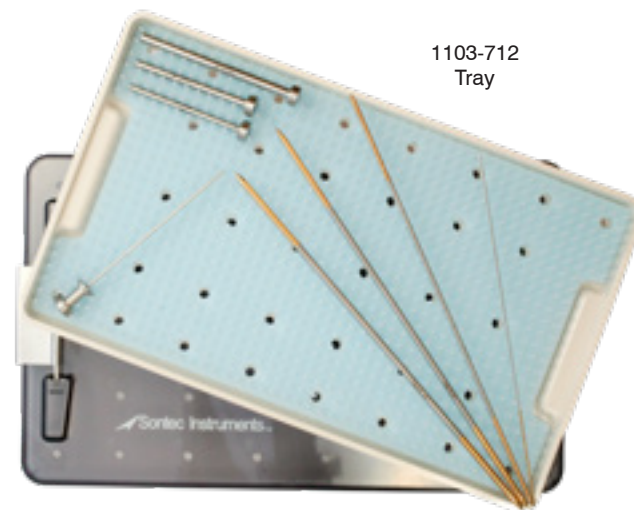

1103-712  
Tray

### Small Joint Arthroscopic Cannula

SC95-0421	2.9 mm	2 1/2" (6.5cm)
SC95-0422	3.7 mm	2 1/2" (6.5cm)
SC95-0423	4.3 mm	3 1/4" (8.3cm)
Sc95-0424	5.1 mm	3 1/4" (8.3cm)

### Arthroscopic Cannulated Obturator

Small joint / 1.3 mm / 4 1/2" (11.5cm)

SC95-0420



SC95-0421

SC95-0422

SC95-0423

SC95-0424

### Arthroscopic Switch Stick

1271-117	3.2mm	8 3/4" (22 cm)
1271-117-1	1.1mm	7" (18cm)
1271-117-2	2.9mm	8 3/4 (22cm)
1271-117-3	3.7mm	8 3/4 (22cm)
1271-117-4	complete switch stick set	



1271-117

1271-117-1

1271-117-2

1271-117-3

SC95-0420

### Small Joint Complete Arthroscopic Set

Includes the following instruments

Sc95-0427 complete set

\* instruments are also available separately

Item Number	Description				
1271-020	grasping biopsy forcep	2 mm	serrated	4" (10 cm)	
1271-090	grasping biopsy forcep	2.7 mm	straight	7" (18 cm)	overload cone
1271-060R	grasping forcep with ratchet	2.7 mm	straight	7" (18 cm)	overload cone
1271-480	hook punch with mini jaws	2.7 mm	straight	7" (18 cm)	overload cone
1271-143	universal anthro handle	125 mm			
1271-127U	universal hook probe	3 mm	90°		
1271-139U	universal banana knife				
1271-122U	universal hook probe	2.5 mm	graduated		
1271-121U	universal hook probe	3.5 mm	graduated		
1271-142U	universal toothed knife		straight		
1271-140U	universal ring curette	3 mm	angled		
SC95-0315	irrigation cannula	3.2 mm			with stop cock
1271-117-1	arthroscopic switch stick	1.1 mm		8" (20.3 cm)	
1271-117-2	arthroscopic switch stick	2.9 mm		8" (20.3 cm)	
1271-117-3	arthroscopic switch stick	3.7 mm		8" (20.3 cm)	
SC95-0420	cannulated obturator	1.3 mm		4" (10 cm)	small joint
SC95-0421	arthroscopic cannula	2.9 mm		2 1/4" (6 cm)	small joint
SC95-0422	arthroscopic cannula	3.7 mm		2 1/4" (6 cm)	small joint
SC95-0423	arthroscopic cannula	4.3 mm		3 1/4" (8 cm)	small joint

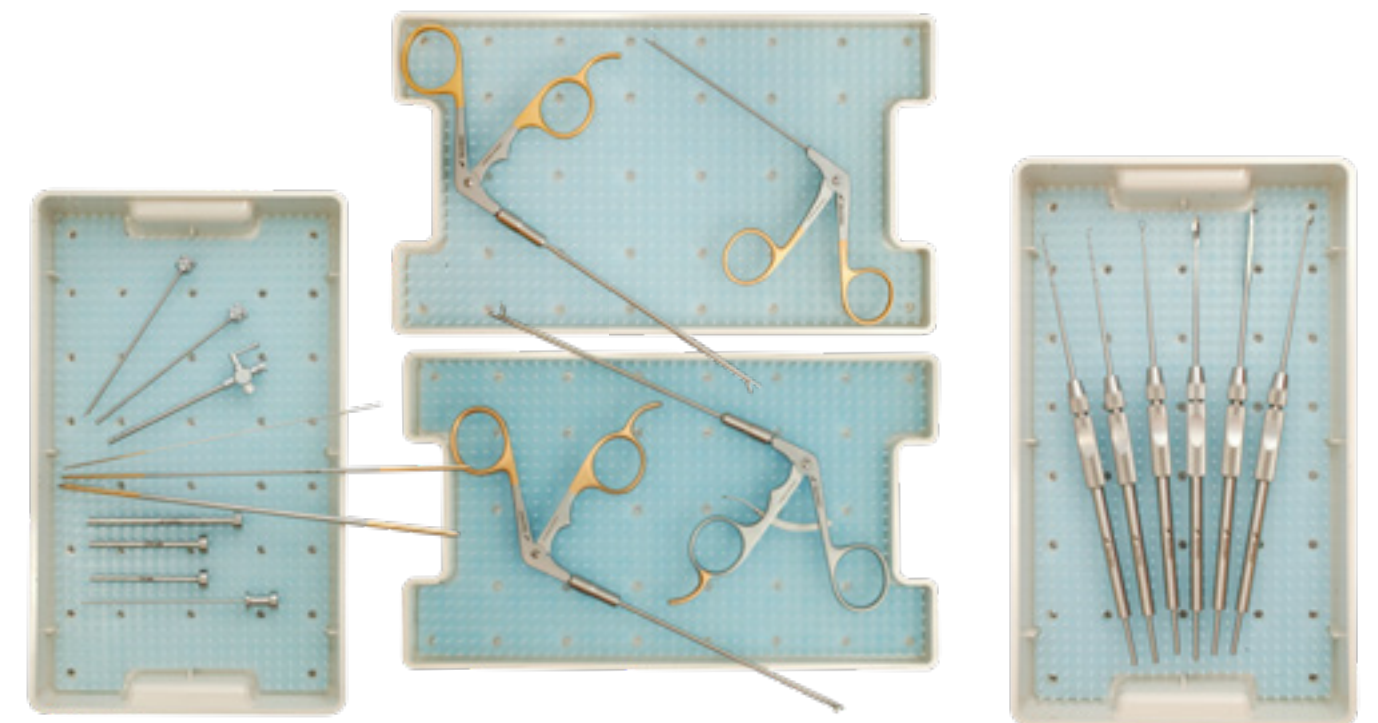

KNEE INSTRUMENTS

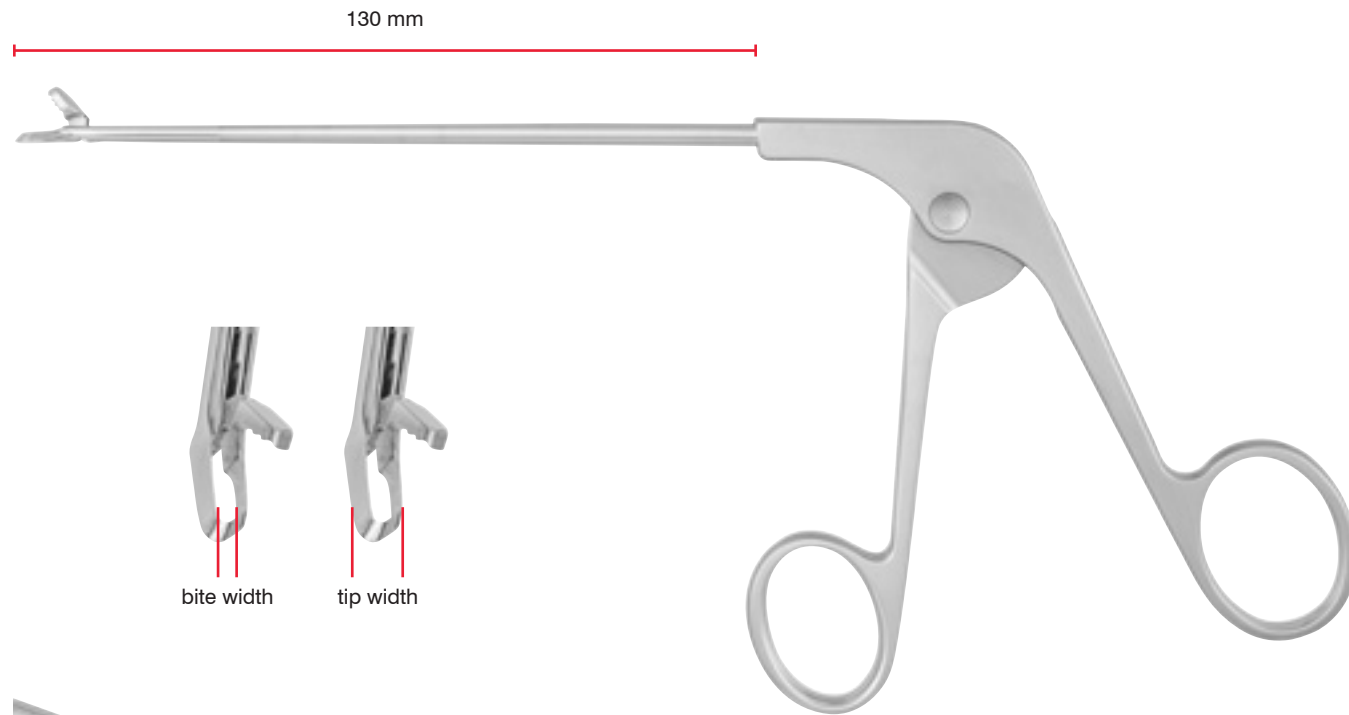

**Straight:** The primary style for direct approach

**Upbiter:** Angled at tip increased access to the posterior meniscus

**Upswept:** Angled shaft follows the contour of the condyle and keeps the cutting surface parallel to the tibial plateau

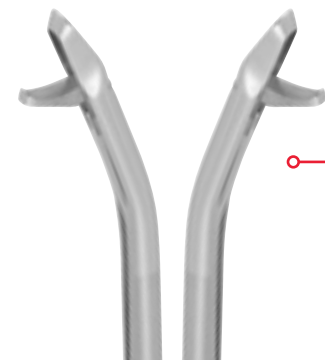

**Curved left and curved right:** Angled to reach the anterior and posterior meniscus

KNEE INSTRUMENTS

Classic Handle

Scissors, basket punches and graspers are equipped with our traditional classic handle



Slide Lock Handle

All graspers are equipped with this infinite position locking handle design



Ergonomic Handle

Selected punches, scissors and graspers are equipped with this ergonomic handle design



Rotatable Handle

Available on rotary basket punches and scissors



**KNEE INSTRUMENTS**

**Punch**

The Basket Punch provides a maximum tissue resection by its wave tooth and wide bite

**Basket Punch / small / 5" straight shaft / 2.5 mm bite width / 4.15 mm tip width**

- 1273-202 classic handle
- 1273-203 ergonomic handle



**Basket Punch / small / upbiter / 5" straight shaft up / 2.5 mm bite width / 4.15 mm tip width**

- 1273-204 classic handle
- 1273-205 ergonomical handle



**Basket Punch / medium / 5" shaft / 3.2 mm bite width / 5.05 mm tip width / straight tip**

- 1273-210 straight shaft classic handle
- 1273-211 straight shaft ergonomic handle
- 1273-214 curved left shaft classic handle
- 1273-215 curved left shaft ergonomic handle
- 1273-212 curved right shaft classic handle
- 1273-213 curved right shaft ergonomic handle
- 1273-216 upswept shaft classic handle
- 1273-217 upswept shaft ergonomic handle



**Basket Punch / medium / upbiter / 5" shaft / 3.20 mm bite width / 5.05 mm tip width**

- 1273-220 straight shaft classic handle
- 1273-221 straight shaft ergonomic handle
- 1273-224 curved left shaft classic handle
- 1273-225 curved left shaft ergonomic handle
- 1273-222 curved right shaft classic handle
- 1273-223 curved right shaft ergonomic handle
- 1273-226 upswept shaft classic handle
- 1273-227 upswept shaft ergonomic handle



**Basket Punch / large / 5" straight shaft / 4.50 mm bite width / 6.15 mm tip width**

- 1273-228 classic handle
- 1273-229 ergonomic handle



**Basket Punch / large / upbiter / 5" straight shaft / 4.50 mm bite width / 6.15 mm tip width**

- 1273-230 classic handle
- 1273-231 ergonomic handle



**Basket Punch / upbiter / diagonal cut / 5" shaft / 3.20 mm bite width / 5.05 mm tip width**

- 1273-232 curved left shaft classic handle
- 1273-233 curved left shaft ergonomic handle
- 1273-234 curved right shaft classic handle
- 1273-235 curved right shaft ergonomic handle



**KNEE INSTRUMENTS**

**Punch**

Combines wide bite with the thinnest possible tip to provide optimum maneuverability under the condyle

**Gawsling Basket Punch / small / 5" shaft / 2.50 mm bite width / 4.15 mm tip width**

- 1273-172 straight shaft classic handle
- 1273-173 straight shaft ergonomic handle
- 1273-174 curved right shaft classic handle
- 1273-175 curved right shaft ergonomic handle
- 1273-176 curved left shaft classic handle
- 1273-177 curved left shaft ergonomic handle
- 1273-178 upswept shaft classic handle
- 1273-179 upswept shaft ergonomic handle



**Gawsling Basket Punch / small / upbiter / 5" straight shaft / 2.50 mm bite width / 4.15 mm tip width**

- 1273-148 classic handle
- 1273-149 ergonomic handle



**Gawsling Basket Punch / medium / 5" shaft / 3.20 mm bite width / 5.00 mm tip width**

- 1273-140 straight shaft classic handle
- 1273-142 straight shaft ergonomic handle
- 1273-136 curved left shaft classic handle
- 1273-141 curved left shaft ergonomic handle
- 1273-134 curved right shaft classic handle
- 1273-139 curved right shaft ergonomic handle
- 1273-138 upswept shaft classic handle
- 1273-143 upswept shaft ergonomic handle



**Gawsling Basket Punch / medium / upbiter / 5" shaft / 3.20 mm bite width / 5.00 mm tip width**

- 1273-133 straight shaft classic handle
- 1273-181 straight shaft ergonomic handle
- 1273-145 curved left shaft classic handle
- 1273-183 curved left shaft ergonomic handle
- 1273-144 curved right shaft classic handle
- 1273-182 curved right shaft ergonomic handle
- 1273-147 upswept shaft classic handle
- 1273-184 upswept shaft ergonomic handle



**Gawsling Basket Punch / large / 5" straight shaft / 4.50 mm bite width / 6.15 mm tip width**

- 1273-185 classic handle
- 1273-186 ergonomic handle



**Gawsling Basket Punch / large / upbiter / 5" straight shaft / 4.50 mm bite width / 6.15 mm tip width**

- 1273-187 classic handle
- 1273-188 ergonomic handle



**Gawsling Punch Elevator / 5" straight shaft / 3.20 mm bite width / 5.00 mm tip width**

- 1273-189 classic handle
- 1273-190 ergonomic handle



**KNEE INSTRUMENTS**

**Punch**

The small aggressive tip provides excellent maneuverability and multiple plane cutting capability in the tightest joint

**Basket Punch / slim style / 5" shaft / 1.67 mm bite width / 2.89 mm tip width**

1273-320	straight shaft	classic handle
1273-321	straight shaft	ergonomic handle
1273-322	upswept shaft	classic handle
1273-323	upswept shaft	ergonomic handle



**Basket Punch / slim style / 5" shaft / 1.67 mm bite width / 2.89 mm tip width**

1273-326	straight shaft	45° angled left	classic handle
1273-327	straight shaft	45° angled left	ergonomic handle
1273-324	straight shaft	45° angled right	classic handle
1273-325	straight shaft	45° angled right	ergonomic handle



**Hook Punch / slim style / upbiter / 5" shaft / 1.67 mm bite width / 2.89 mm tip width**

1273-330	straight shaft	classic handle
1273-331	straight shaft	ergonomic handle
1273-334	curved left shaft	classic handle
1273-335	curved left shaft	ergonomic handle
1273-332	curved right shaft	classic handle
1273-333	curved right shaft	ergonomic handle



**Punch**

The lowest profile tip with the largest bite offers the most versatile instrument available

**Basket Punch / oval / 5" shaft / 4.39 mm bite width / 6.57 mm tip width**

1273-238	straight shaft	classic handle
1273-239	straight shaft	ergonomic handle
1273-242	curved left shaft	classic handle
1273-243	curved left shaft	ergonomic handle
1273-240	curved right shaft	classic handle
1273-241	curved right shaft	ergonomic handle
1273-244	upswept shaft	classic handle
1273-245	upswept shaft	ergonomic handle



**Basket Punch / oval / upbiter / 5" shaft / 4.39 mm bite width / 6.57 mm tip width**

1273-248	straight shaft	classic handle
1273-247	straight shaft	ergonomic handle
1273-252	curved left shaft	classic handle
1273-251	curved left shaft	ergonomic handle
1273-250	curved right shaft	classic handle
1273-249	curved right shaft	ergonomic handle
1273-254	upswept shaft	classic handle
1273-253	upswept shaft	ergonomic handle



**KNEE INSTRUMENTS**

**Punch**

These instruments have a flexible purpose due to their different sizes

**Basket Punch Scoop / 5" shaft / 1.59 mm bite width / 3.25 mm tip width**

1273-256	1.0 mm straight shaft	classic handle
1273-257	1.0 mm straight shaft	ergonomic handle
1273-262	1.0 mm upswept shaft	classic handle
1273-263	1.0 mm upswept shaft	ergonomic handle
1273-260	1.3 mm curved left shaft	classic handle
1273-261	1.3 mm curved left shaft	ergonomic handle
1273-258	1.3 mm curved right shaft	classic handle
1273-259	1.3 mm curved right shaft	ergonomic handle



**Basket Punch Scoop / 1.3 mm / upbiter / 5" shaft / 1.59 mm bite width / 3.27 mm tip width**

1273-266	straight shaft	classic handle
1273-265	straight shaft	ergonomic handle
1273-270	curved left shaft	classic handle
1273-269	curved left shaft	ergonomic handle
1273-268	curved right shaft	classic handle
1273-267	curved right shaft	ergonomic handle



**Basket Punch Scoop / 5" shaft / 1.59 mm bite width**

1273-278	3.27 mm tip width	1.3 mm upswept shaft	classic handle
1273-280	3.27 mm tip width	1.3 mm upswept shaft	ergonomic handle
1273-277	3.88 mm tip width	1.5 mm straight shaft	classic handle
1273-279	3.88 mm tip width	1.5 mm straight shaft	ergonomic handle



**Basket Punch Scoop / downbiter / 5" straight shaft / 1.59 mm bite width / 3.27 mm tip width**

1273-281	1.3 mm shaft	classic handle
1273-282	1.3 mm shaft	ergonomic handle



**Basket Punch Scoop / upbiter / 5" shaft**

1273-276	1.59 mm bite width	3.88 mm tip width	1.5 mm upswept shaft	classic handle
1273-275	1.59 mm bite width	3.88 mm tip width	1.5 mm upswept shaft	ergonomic handle
1273-272	1.77 mm bite width	3.58 mm tip width	2.7 mm straight shaft	classic handle
1273-271	1.77 mm bite width	3.58 mm tip width	2.7 mm straight shaft	ergonomic handle
1273-274	2.03 mm bite width	3.76 mm tip width	3.4 mm straight shaft	classic handle
1273-273	2.03 mm bite width	3.76 mm tip width	3.4 mm straight shaft	ergonomic handle



**Basket Punch Scoop / upbiter / 5" straight shaft / 1.59 mm bite width / 3.88 mm tip width**

1273-283	classic handle
1273-284	ergonomic handle



**Basket Punch / short cut / 5" straight shaft / 1.67 mm bite width / 3.32 mm tip width**

1273-200	classic handle
1273-201	ergonomic handle



**KNEE INSTRUMENTS**

**Punch**

The meniscal elevator with the extended lip of the lower jaw assists to slide easily under a tight meniscus

**Basket Punch / meniscal elevator / 5" straight shaft / 1.60 mm bite width / 3.20 mm tip width / 1.3 mm shaft**

- 1273-290 classic handle
- 1273-291 ergonomic handle



**Basket Punch / meniscal elevator / upbiter / 5" straight shaft / 1.60 mm bite width / 3.20 mm tip width / 1.3 mm shaft**

- 1273-292 classic handle
- 1273-293 ergonomic handle



**Punch**

The blunt tip enables this instrument to get into the posterior horn for flush trimming of the meniscus

**Hook Punch / blunt nose 1.0 mm / 5" shaft / 1.67 mm bite width / 3.32 mm tip width**

- 1273-362 straight shaft classic handle
- 1273-363 straight shaft ergonomic handle
- 1273-368 upswept shaft classic handle
- 1273-369 upswept shaft ergonomic handle
- 1273-366 curved left shaft classic handle
- 1273-367 curved left shaft ergonomic handle
- 1273-364 curved right shaft classic handle
- 1273-365 curved right shaft ergonomic handle



**Punch**

The short jaw and the gradually tapered shaft permit the tip to open wide for cutting in tight posterior compartments

**Posterior Basket Punch / 5" shaft / 2.18 mm bite width / 4.00 mm tip width / straight tip**

- 1273-300 straight shaft classic handle
- 1273-301 straight shaft ergonomic handle
- 1273-304 curved left shaft classic handle
- 1273-305 curved left shaft ergonomic handle
- 1273-302 curved right shaft classic handle
- 1273-303 curved right shaft ergonomic handle
- 1273-306 upswept shaft classic handle
- 1273-307 upswept shaft ergonomic handle



**Posterior Basket Punch / upbiter / 5" shaft / 2.18 mm bite width / 4.00 mm tip width**

- 1273-310 straight shaft classic handle
- 1273-311 straight shaft ergonomic handle
- 1273-314 curved left shaft classic handle
- 1273-315 curved left shaft ergonomic handle
- 1273-312 curved right shaft classic handle
- 1273-313 curved right shaft ergonomic handle



**Punch**

The backbiting capability of this punch offers the most direct access to the anterior meniscus

**Basket Punch Unicorn / 5" straight shaft / 2.38 mm bite width / 5.58 mm tip width**

- 1273-296 left cut classic handle
- 1273-297 left cut ergonomic handle
- 1273-294 right cut classic handle
- 1273-295 right cut ergonomic handle



**KNEE INSTRUMENTS**

**Punch**

This punch offers an effective angle for the anterior meniscus. The tip allows successive bites, ideal for balancing the meniscal rim.

**Rotary Basket Punch / 5" straight shaft / 90° jaw / rotatable handle /**

- 1273-287 2.20 mm bite width 4.10 mm tip width 2.2mm shaft angled left
- 1273-286 2.20 mm bite width 4.10 mm tip width 2.2mm shaft angled right
- 1273-289 3.40 mm bite width 5.30 mm tip width 3.4mm shaft angled left
- 1273-288 3.40 mm bite width 5.30 mm tip width 3.4mm shaft angled right



**Rongeur**

Enables cutting and removal of tissue particularly useful in ACL surgery

**Rongeur Raptor / 5" straight shaft**

- 1273-376 classic handle
- 1273-377 ergonomic handle



**Punch**

The small bite size allows for increased visibility and consistently provides a clean shear cut

**Scissors Punch / 5" shaft / 1.20 mm bite width / 2.80 mm tip width / straight tip**

- 1273-340 straight shaft classic handle
- 1273-341 straight shaft ergonomic handle
- 1273-344 curved left shaft classic handle
- 1273-345 curved left shaft ergonomic handle
- 1273-342 curved right shaft classic handle
- 1273-343 curved right shaft ergonomic handle



**Scissors Punch / upbiter / 5" shaft / 1.20 mm bite width / 2.80 mm tip width**

- 1273-129 straight shaft classic handle
- 1273-347 straight shaft ergonomic handle
- 1273-132 curved left shaft classic handle
- 1273-351 curved left shaft ergonomic handle
- 1273-130 curved right shaft classic handle
- 1273-349 curved right shaft ergonomic handle



**Scissors**

Teeth on the top hook of the instrument prevent tissue from slipping off and allows a clean cut

**Hook Scissors / 5" shaft**

- 1273-354 straight shaf classic handle
- 1273-355 straight shaft ergonomic handle
- 1273-358 curved left shaft classic handle
- 1273-359 curved left shaft ergonomic handle
- 1273-356 curved right shaft classic handle
- 1273-357 curved right shaft ergonomic handle



**KNEE INSTRUMENTS**

**Scissors**

Ideal for manipulation of all aspects of the meniscus because of its unique sideways cutting action and ability to fit into tight areas

**Rotary Hook Scissors / 5" straight shaft / 20° / rotatable handle**

- 1273-361 angled left
- 1273-360 angled right



**Rotary Scissors serrated / 5" straight shaft / 20° / rotatable handle**

- 1273-353 angled left
- 1273-352 angled right



**Rotary Hook Scissors / 5" straight shaft / 60° / rotatable handle**

- 1273-131 angled left
- 1273-137 angled right



**Forceps**

Ideal for manipulation of all aspects of the meniscus because of its unique sideways cutting action and ability to fit into tight areas

**Grasping Forceps / 1x2 teeth / 5" straight shaft / slide-lock handle**

- 1273-115



**Grasping Forceps / cupped / serrated / 5" straight shaft / slide-lock handle**

- 1273-380 2.7 mm
- 1273-381 3.4 mm



**Grasping Forceps Alligator / upbiter / 5" shaft / 2.7 mm / slide-lock handle**

- 1273-382 straight shaft
- 1273-383 upswept shaft



**Grasping Forceps Crocodile / 5" shaft / 2.7 mm / slide-lock handle**

- 1273-112 straight shaft
- 1273-110 upswept shaft



**Grasping Forceps Alligator / 5" shaft / 3.4 mm / slide-lock handle**

- 1273-384 straight shaft
- 1273-385 upswept shaft



**Tissue Grasping Forceps / 5" straight shaft / slide-lock handle**

- 1273-386 without channel
- 1273-387 with 2 mm channel



**KNEE INSTRUMENTS**



SMALL JOINT INSTRUMENTS

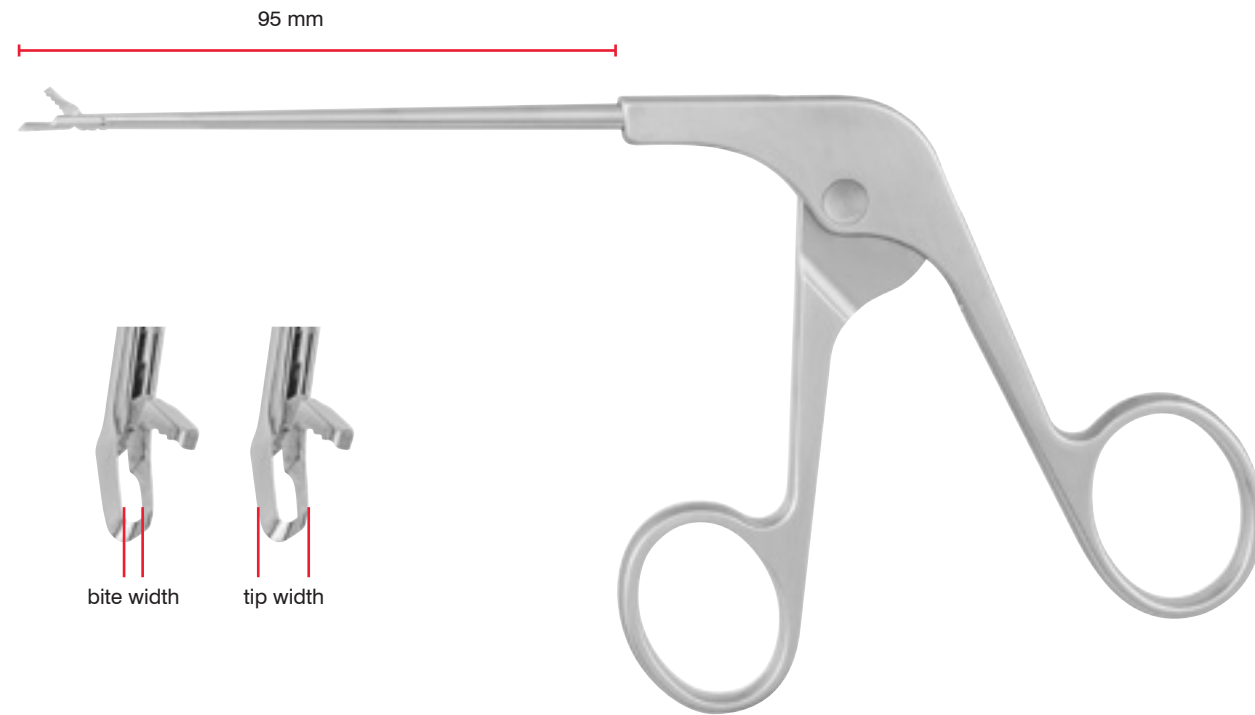

**Straight:** The primary style for direct approach

**Upbiter:** Angled up at the tip

**Upswept:** Angled up on the shaft

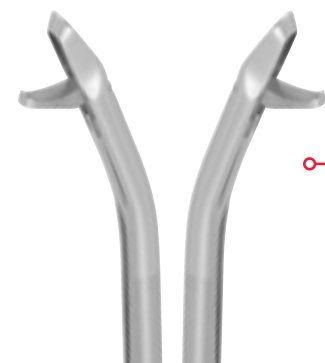

**Curved left and curved right:** Curved on the shaft left or right

SMALL JOINT INSTRUMENTS

Classic Handle

Scissors, basket punches and graspers are equipped with our traditional classic handle



Slide Lock Handle

All graspers are equipped with this infinite position locking handle design



**SMALL JOINT INSTRUMENTS**

Designed especially for small joints, these instruments have shorter stems and smaller jaws to provide ideal access for the elbow, wrist and ankle

**Punch**

**Punch / oval Jr. / 3 3/4" shaft / 2.30 mm bite width / 3.50 tip width / classic handle**

- 1273-151 straight shaft
- 1273-153 left Cvd Shaft
- 1273-152 right Cvd Shaft



**Basket Punch / Jr. / 3 3/4" straight shaft / 2.30 mm bite width / 3.50 tip width / classic handle**

- 1273-150
- 1273-150L left curved shaft



**Basket Punch / Jr. / upbiter / 3 3/4" straight shaft / 2.30 mm bite width / 3.50 tip width / classic handle**

- 1273-154



**Basket Punch / blunt Jr. / 3 3/4" straight shaft / 1.70 mm bite width / 3.00 tip width / classic handle**

- 1273-155



**Scissors**

**Hook Scissors / 3 3/4" straight shaft / classic handle**

- 1273-156



**Rongeur**

**Rongeur Raptor / Jr. / 3 3/4" straight shaft / classic handle**

- 1273-161



**Forceps**

**Grasping Forceps Alligator / Jr. / 3 3/4" straight shaft / slide-lock handle**

- 1273-122



**Grasping Forceps Alligator / Jr. / 1x2 teeth / 3 3/4" shaft / slide-lock handle**

- 1273-123



**SHOULDER INSTRUMENTS**

155 mm

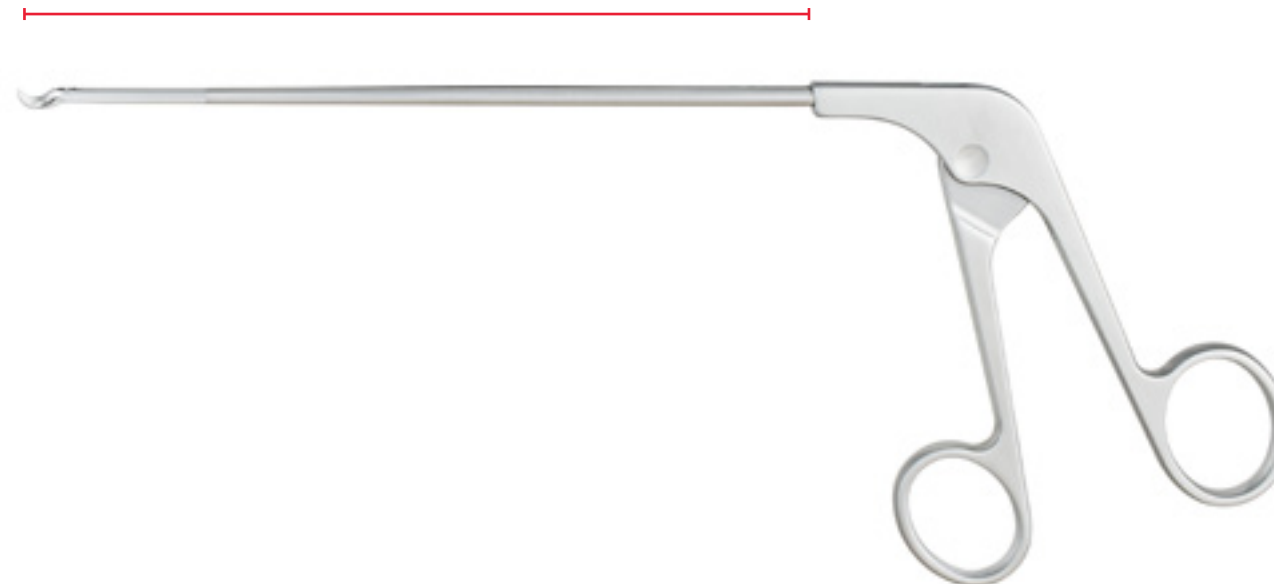

**Straight:** The primary style for direct approach

**Upbiter:** Angled up at the tip

**Upswept:** Angled up on the shaft

**Curved left and curved right:** Curved on the shaft left or right

SHOULDER INSTRUMENTS

Classic Handle

Scissors, basket punches and graspers are equipped with our traditional classic handle



Slide Lock Handle

All graspers are equipped with this infinite position locking handle design



Positioning Handle



SHOULDER INSTRUMENTS

Hook

Clever Suture Hook / 6" straight shaft

- 1273-408 green handle pointed tip left
- 1273-407 red handle pointed tip right



Sixter Suture Hook / 6" straight shaft

- 1273-410 green handle tip turned left
- 1273-409 red handle tip turned right



**SHOULDER INSTRUMENTS**

These instruments were designed specifically for the shoulder area. The low-profile and highly sharpened tip allows easy passage through tissue in order to retrieve or apply a suture. Also the instruments for grasping the engagement is facilitated by the shape of the jaw.

**Forceps**

**Bird Beak Suture Hook Forceps / 6" straight shaft / classic handle**

1273-401



**Bird Beak Suture Hook Forceps / 6" straight shaft / classic handle**

1273-403 45° angled left jaw  
1273-402 45° angled right jaw



**Bird Beak Suture Hook Forceps / upbiter / 6" straight shaft / classic handle**

1273-404 20° up jaw  
1273-405 40° up jaw



**Grasper**

**Suture Retriever Grasper / serrated / 6" straight shaft / slide-lock handle**

1273-415



**Suture Retriever Grasper / serrated / 6" straight shaft / slide-lock handle**

1273-418 45° angled left jaw  
1273-417 45° angled right jaw



**Suture Retriever Grasper / serrated / 15° angled up jaw / 6" straight shaft / slide-lock handle**

1273-416



**King Suture Retriever Grasper / cross-serrated / 6" straight shaft / slide-lock handle**

1273-420



**Forceps**

**Tissue Grasping Forceps / 6" straight shaft / slide-lock handle**

1273-422



**SHOULDER INSTRUMENTS**

**Punch**

**Suture Punch / 6" straight shaft / classic handle**

1273-424



**Hook**

**Double Hook Suture Hook / 6" straight shaft / classic handle**

1273-426



**Hook**

**Sliding Suture Hook / 6" straight shaft / positioning handle**

1273-428



HIP INSTRUMENTS

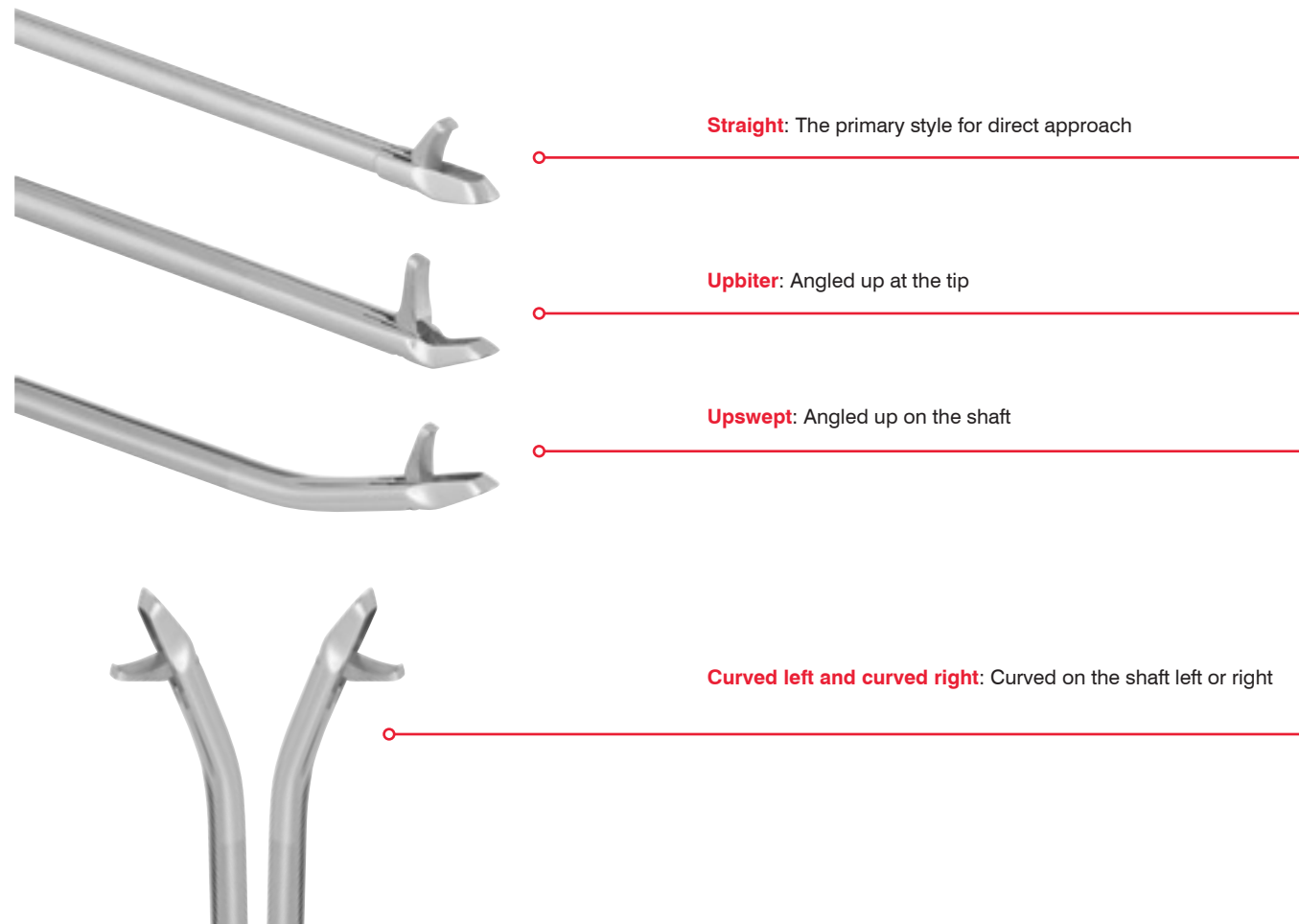
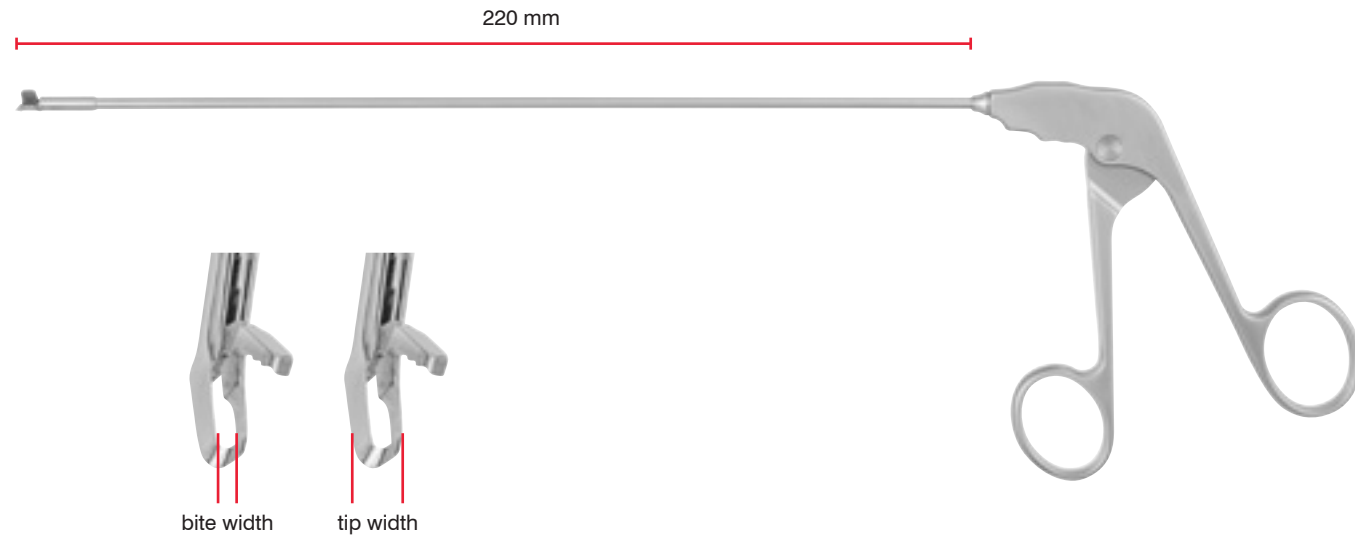

HIP INSTRUMENTS

Classic Handle

Scissors, basket punches and graspers are equipped with our traditional classic handle



Slide Lock Handle

All graspers are equipped with this infinite position locking handle design



Rotatable Handle

Available on rotary basket punches and scissors



**HIP INSTRUMENTS**

These instruments were specifically designed with the additional challenges of hip arthroscopy in mind. Their extra length and low profile offer excellent access to the hip joint.

**Punch**

Hook Punch small / 8 1/4" straight shaft / 1.67 mm bite width / 2.89 tip width / classic handle  
1273-440



Hook Punch small / upbiter / 8 1/4" straight shaft / 1.67 mm bite width / 2.89 tip width / classic handle  
1273-441



Basket Punch small / 8 1/4" straight shaft / 1.67 mm bite width / 2.89 tip width / classic handle  
1273-435 45° down left  
1273-434 45° down right



Gawsling Punch medium / 8 1/4" straight shaft / 3.20 mm bite width / 5.00 tip width / classic handle  
1273-431  
1273-433 upswept shaft



Gawsling Punch medium / upbiter / 8 1/4" straight shaft / 3.20 mm bite width / 5.00 tip width / classic handle  
1273-432



Basket Punch unicorn / 8 1/4" straight shaft / 2.38 mm bite width / 5.58 tip width / classic handle  
1273-437 left cut  
1273-436 right cut



**Rongeur**

Rongeur Raptor / 8 1/4" straight shaft / classic handle  
1273-447



**Punch**

Rotary Basket Punch / 2.2 mm 8 1/4" straight shaft / 2.20 mm bite width / 4.10 tip width / rotatable handle  
1273-439 90° angled left jaw  
1273-438 90° angled right jaw



**HIP INSTRUMENTS**

**Forceps**

Grasping Forceps / 1x2 teeth / 8 1/4" straight shaft / slide-lock handle  
1273-442



Grasping Forceps / cupped / serrated / 8 1/4" straight shaft / slide-lock handle  
1273-443 2.7 mm shaft  
1273-444 3.4 mm shaft



Grasping Forceps Alligator / 8 1/4" straight shaft / slide-lock handle  
1273-445



**Arthroscopic Crocodile Grasping Forceps**

**Straight / 2.7 mm jaw / 5" (13 cm) shaft**

- 1273-112 with locking mechanism
- 1273-113 without locking mechanism



**Arthroscopic Rottweiler Loosebody Grasping Forceps**

**With locking mechanism / 1 x 2 teeth / 2.7 mm / 6 1/2" (16.5 cm)**

- 1273-114 with locking mechanism
- 1273-1141 without locking mechanism



**Rottweiler Junior Loosebody Grasping Forceps**

With locking mechanism / straight / 1 x 2 teeth / 2.7 mm / 5" (12.7 cm)  
1273-115



**Arthroscopic Velociraptor Biopsy Forceps**

Straight / 3.4 mm jaw / 5" (13 cm) shaft  
1273-162



**Arthroscopic Velociraptor Junior Biopsy Forceps**

Straight / 2.7 mm jaw / 3 1/2" (9 cm) shaft  
1273-171

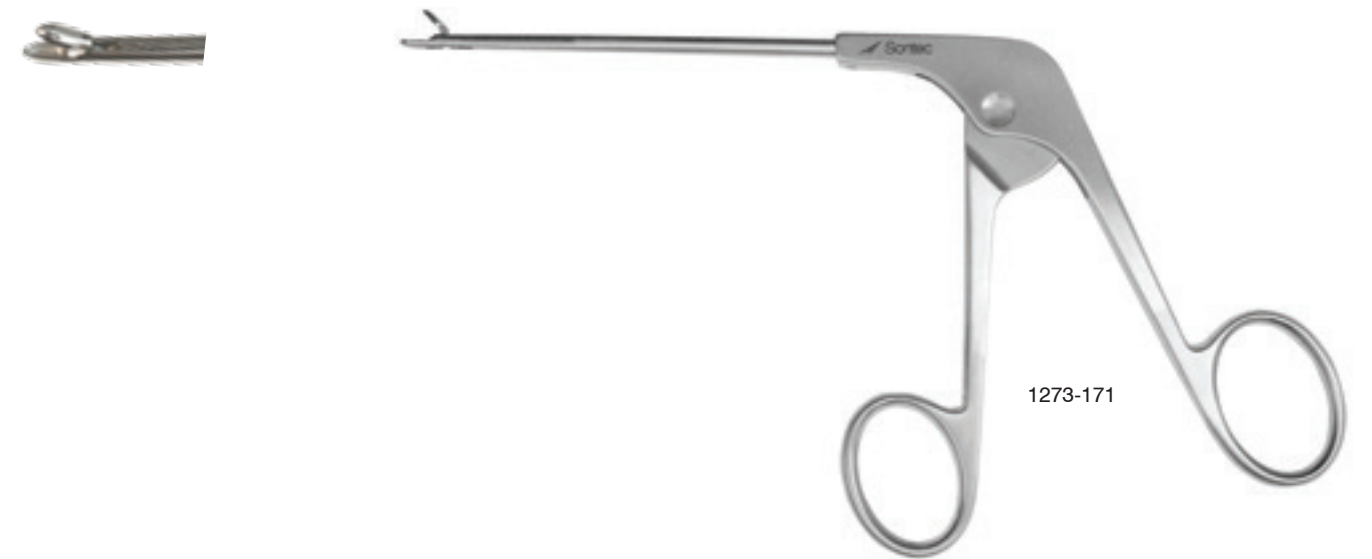

**Arthroscopic Gawling Basket Punch**

---

Up-bite / 3.2 mm jaw / 6 1/2" (16.5 cm) shaft  
1273-146



**Arthroscopic Saber Scissor Punch**

---

Straight / 2.7 mm / 6 1/2" (16.5 cm) shaft  
1273-135





 Sontec Instruments®

Bone & NAIL CUTTING Forceps

**Liston Bone Cutting Forceps**

**5 1/2" (14 cm)**

- 315-765 straight
- 315-775 angled

**6 1/2" (16.5 cm)**

- 315-766 straight
- 315-776 angled

**7 1/2" (19 cm)**

- 315-767 straight
- 315-777 angled
- 315-779 angled to side

**8 1/2" (21.5 cm)**

- 315-768 straight
- 315-778 angled



315-776

**Ruskin-Liston Bone Cutting Forceps**

**Double-action**

- 1103-092 straight 5 3/4" (14.5 cm)
- 1103-093 angled 5 3/4" (14.5 cm)
- 1103-094 straight 7 1/4" (18.5 cm)
- 1103-095 angled 7 1/4" (18.5 cm)

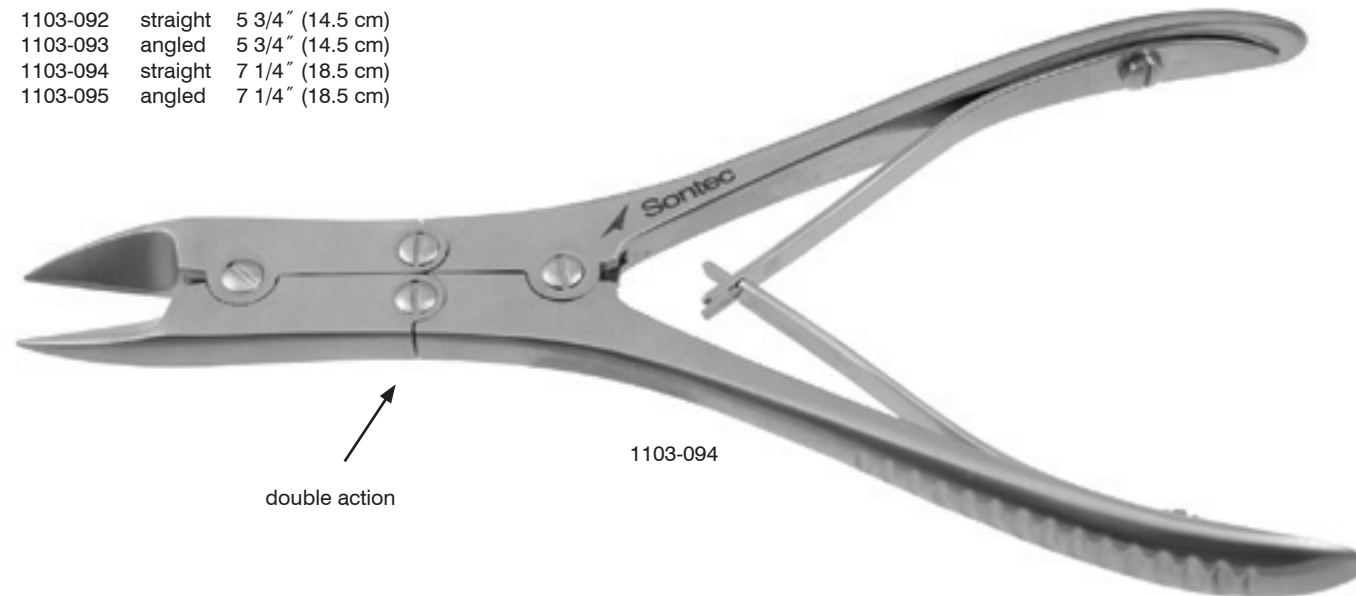

1103-094

**Councilman Bone Cutter**

**15" (38 cm)**

- 315-762



315-762

**Stille-Liston Bone Cutting Forceps**

**Double-action / 9" (23 cm)**

- 315-752 angled up

**Double-action / 10 1/2" (26 cm)**

- 315-754 straight
- 315-756 angled

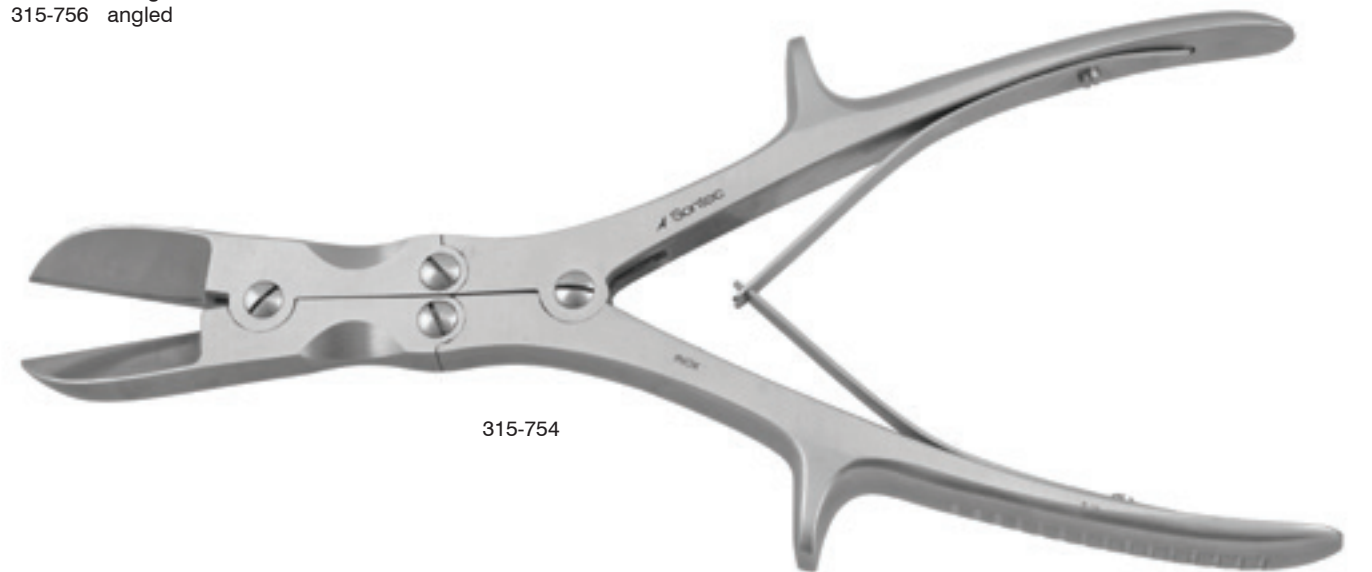

315-754

**McIndoe Bone Cutting Forceps**

Double-action / angled / 7 1/4" (18.5 cm)  
315-781

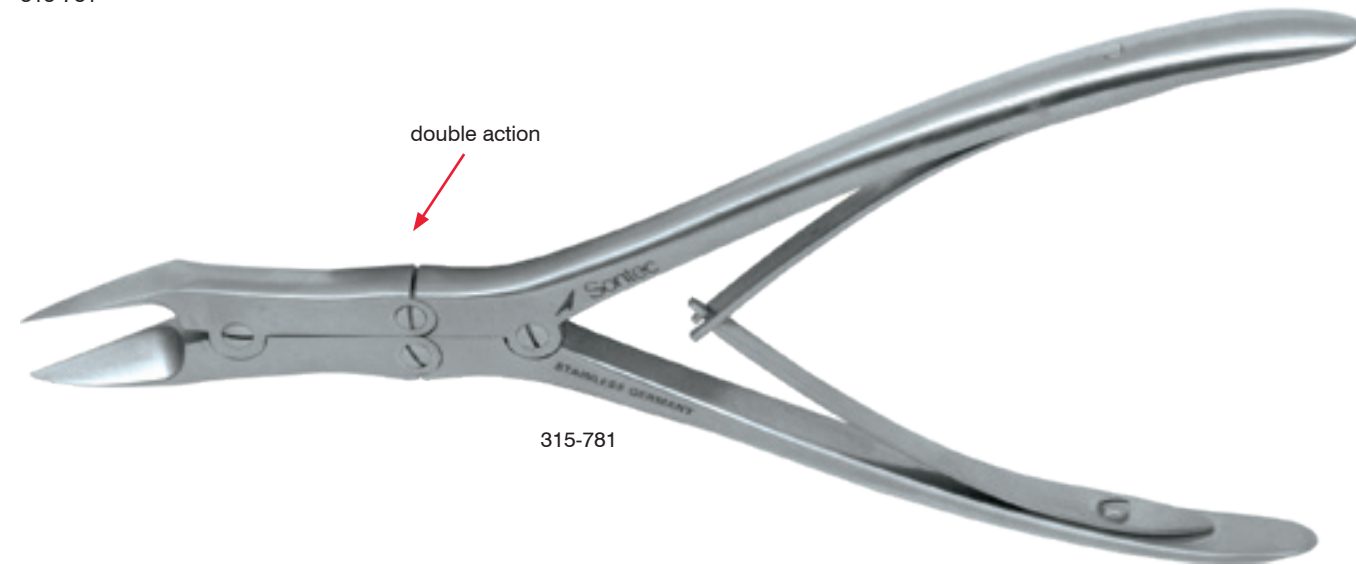

315-781

**Tissue Nipper**

- 199-220 6 mm 4" (10 cm)
- 199-221 9 mm 4" (10 cm)
- 199-222 11 mm 4 1/2" (11.5 cm)
- 199-223 14 mm 5" (13 cm)



199-220

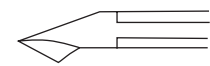

199-220



199-221

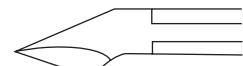

199-222



199-223

**Tissue and Cuticle Nipper**

Convex jaw / 4" (10 cm)  
199-240

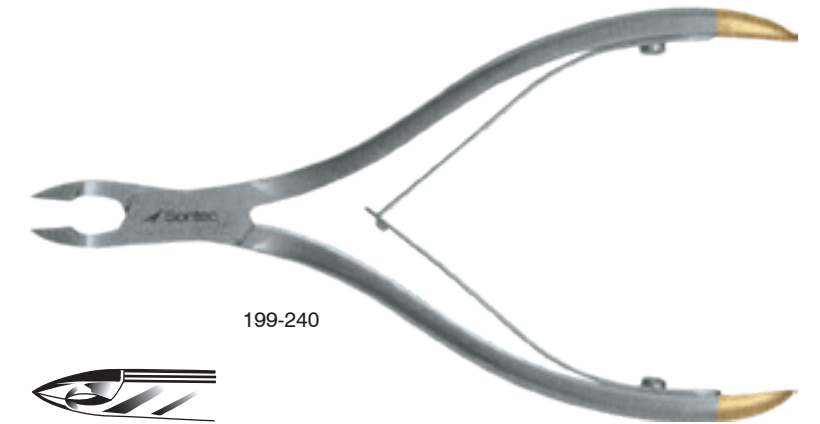

199-240



**Nail Splitter Forcep**

- Straight / tapered**
- 199-276 4" (10 cm)
  - 199-277 4 1/2" (11.5 cm)
  - 199-278 5" (13 cm)
  - 199-279 6" (15 cm)
  - 199-280 4 1/2" (11.5 cm) delicate



199-276

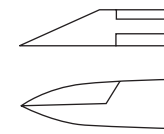

199-276

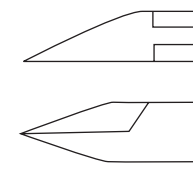

199-277

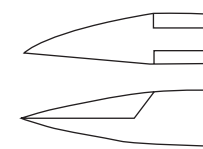

199-280

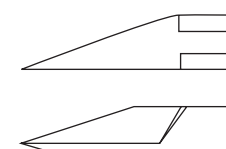

199-278

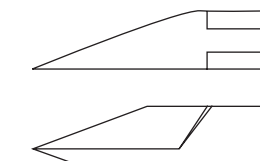

199-279

**Stille-Horsley Bone Cutter**

S-shaped / up-angle jaw / 10 1/2" (26.7 cm)  
315-760



315-760

**Short Jaw Nail Splitter**

199-283 5" (13 cm)  
199-284 6" (15 cm)

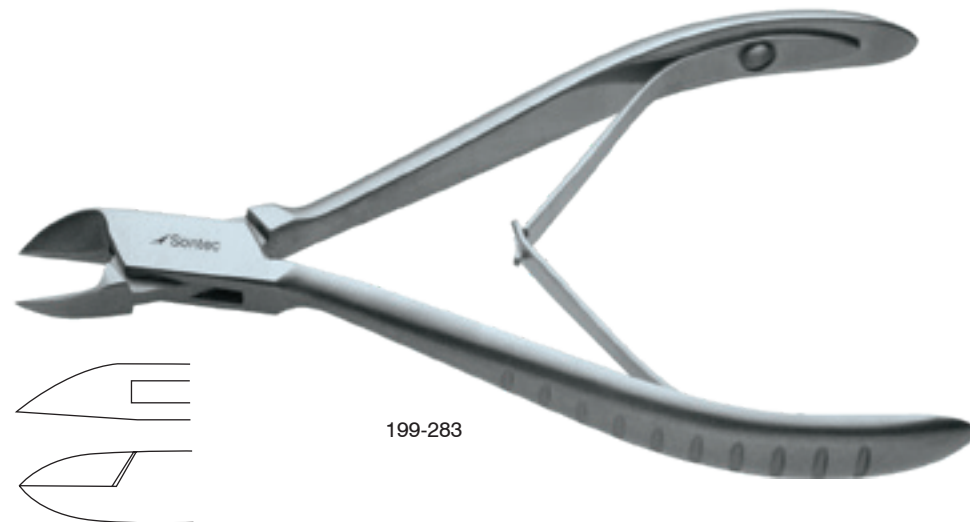

199-283

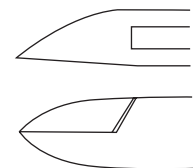

**Nail Nipper**

Concave / narrow / 5" (13 cm)  
199-218

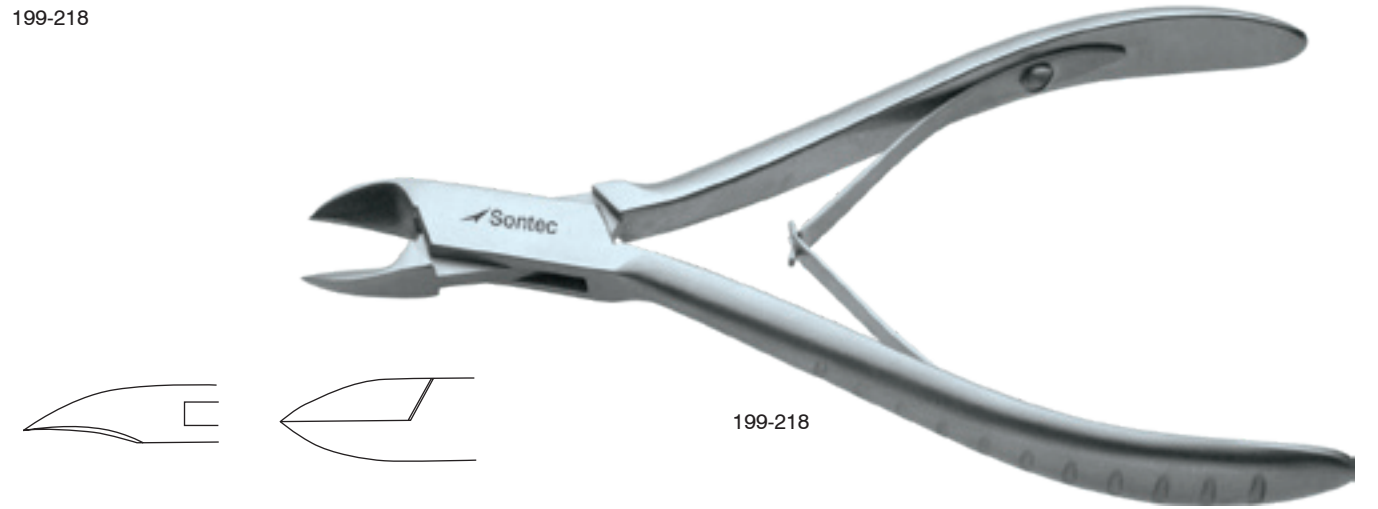

199-218



**Nail Splitter**

199-271 4" (10 cm)  
199-272 4 1/2" (11.5 cm)  
199-273 5" (13 cm)  
199-275 5" (13 cm) narrow  
199-274 6" (15 cm)

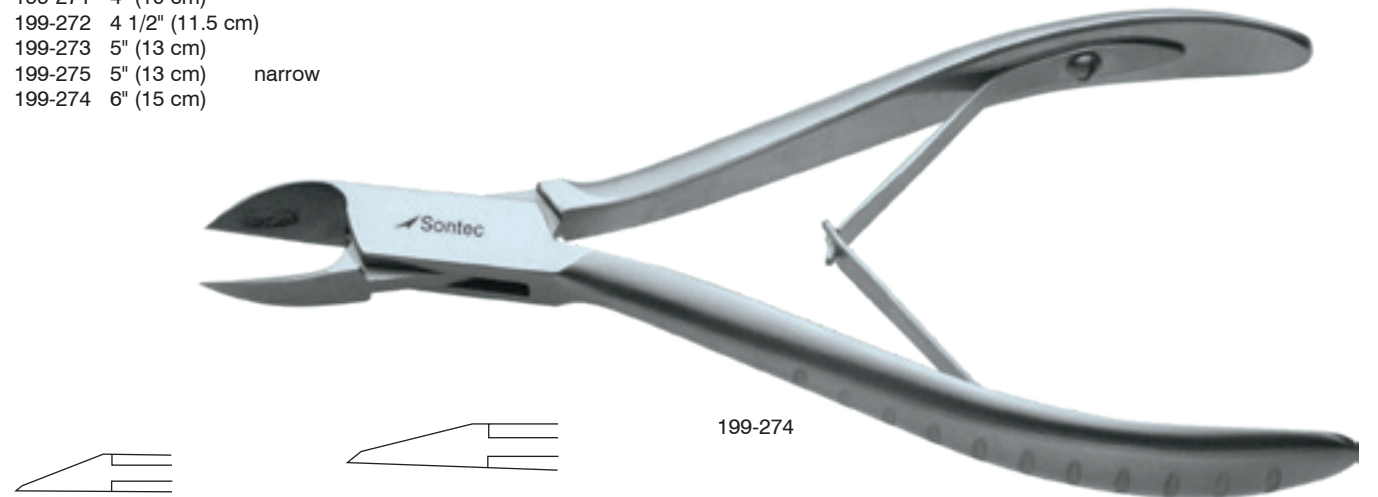

199-274

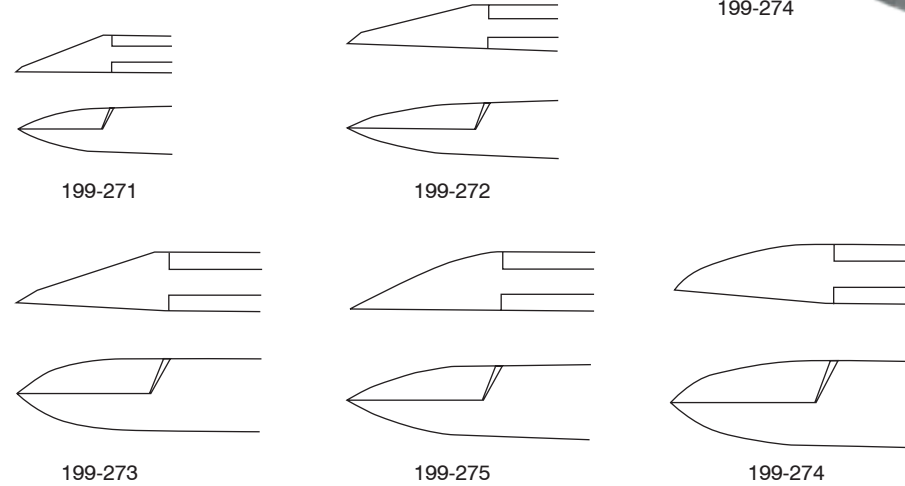

**Pigtooth Nipper**

5 1/2" (14 cm)  
1100-765

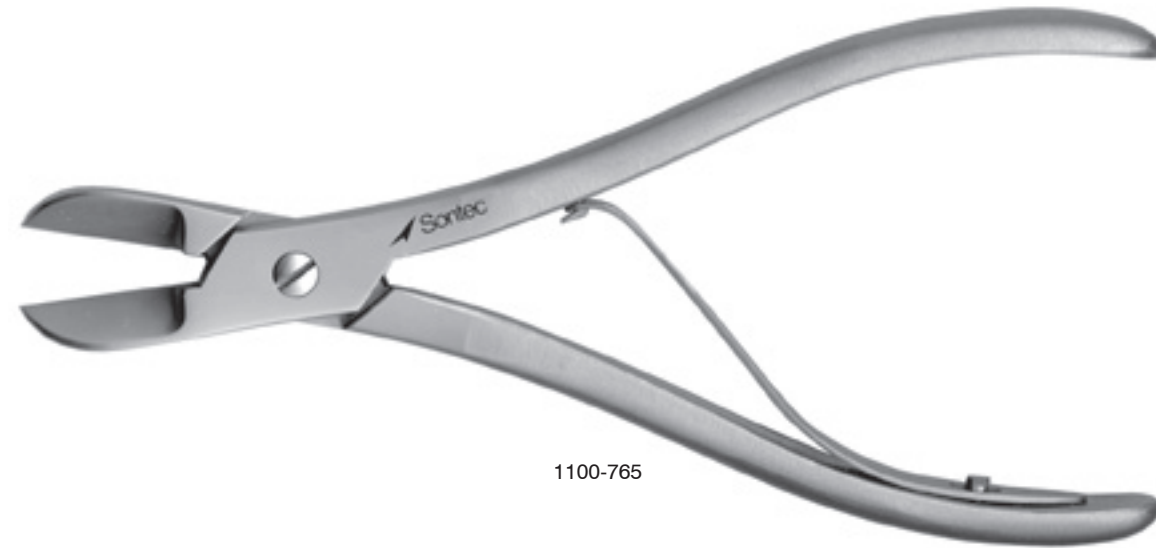

1100-765

**Heavy Nail Nipper**

199-212 5 1/2" (14 cm) concave  
199-216 5 1/2" (14 cm) straight  
199-214 6 1/2" (16.5 cm) concave



199-214

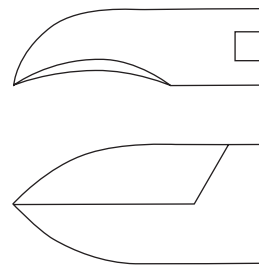

199-212  
199-214

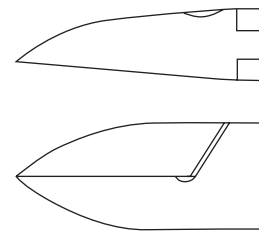

199-216

**Ingrown Nail Forcep**

Straight / anvil pattern / narrow  
blade / 5" (13 cm)  
199-282

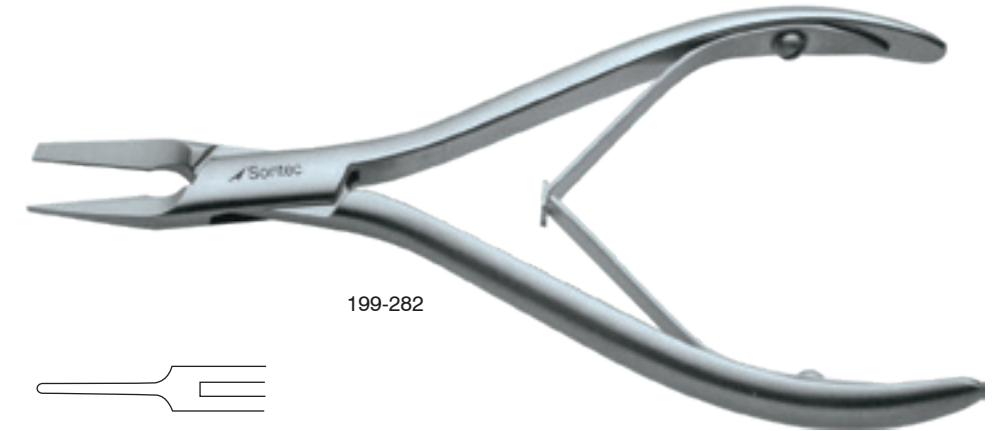

199-282

**Bone Cutter / Nail Nipper**

Double-action / 6" (15 cm)  
1103-090



1103-090

**Concave Nail Nipper**

Barrel spring / chrome / 4 1/2" (11.4 cm)  
199-207

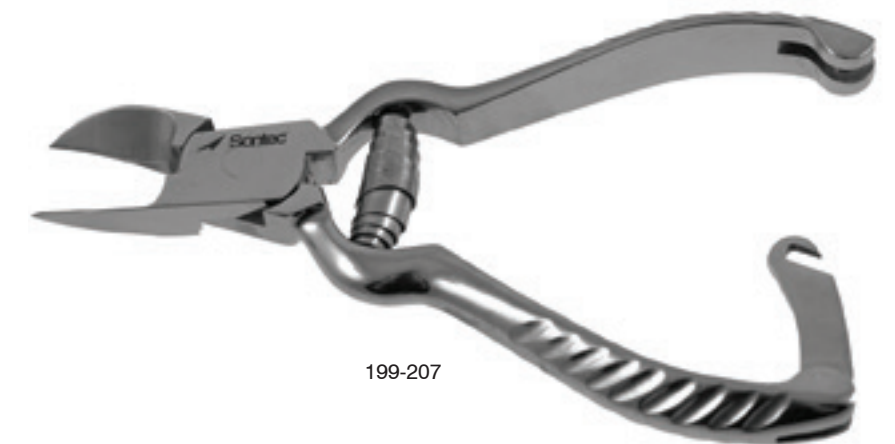

199-207

**Ingrown Nail Splitting Scissors**

Straight / 1 blade serrated / 6 3/4" (17.1 cm)  
1103-613



**Nail Nipper**

5 1/2" (14 cm)  
199-211 str  
199-213 cvd

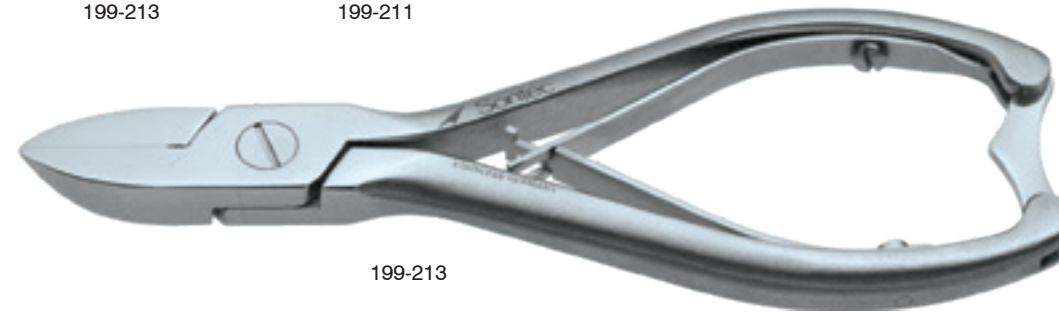
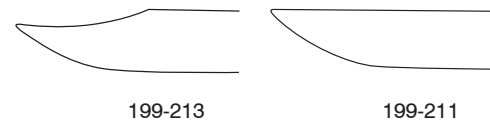

**White Toe Nail Scissor**

4 1/2" (11.5 cm)  
1100-766



**Feline Nail Cutter**

Smaller / 3" (7.5 cm)  
1100-759



**Avian Nail Trimmer**

Blue ring handle / 3 3/4" (9.5 cm)  
1103-615





 Sontec Instruments®

Kerrison RONGEURS

**Universal Klick Kerrison Rongeur Set with Tray**

- 404-608-SET Set  
 Classic Standard Set includes:  
 404-6081 1 mm 40° 8" shaft  
 404-6082 2 mm 40° 8" shaft  
 404-6083 3 mm 40° 8" shaft  
 404-6084 4 mm 40° 8" shaft  
 404-6085 5 mm 40° 8" shaft  
 404-6086 2 universal handles

18-3564 tray only

To configure you own personalized set, refer to "Kerrison Section" > "Kerrison Universal Rotating 360° Rongeur" for all possible options

\*different size shafts available up request



**Kerrison Universal Rotating 360° Rongeur**

**Special**

404-606B handle \*special order

**Bayonet shaft / black ceramic / 12 1/2" (31.8 cm)**

- 404-6061B 1 mm bite 40°  
 404-6062B 2 mm bite 40°  
 404-6063B 3 mm bite 40°

**Endoscopic / black ceramic / 16" (40.6 cm)**

404-6063EB 3 mm bite 40°

**Quick trigger release / shaft locks in 8 positions through a 360° rotation / 8" (20cm) shaft**

- 404-6082B 2 mm bite 40° up curved with tissue ejector  
 404-6082C 2 mm bite 40° down curved with tissue ejector  
 404-60825E 2.5 mm bit 40°  
 404-6083B 3 mm bite 40° up curved with tissue ejector  
 404-6083E 3 mm bite 40° endoscopic

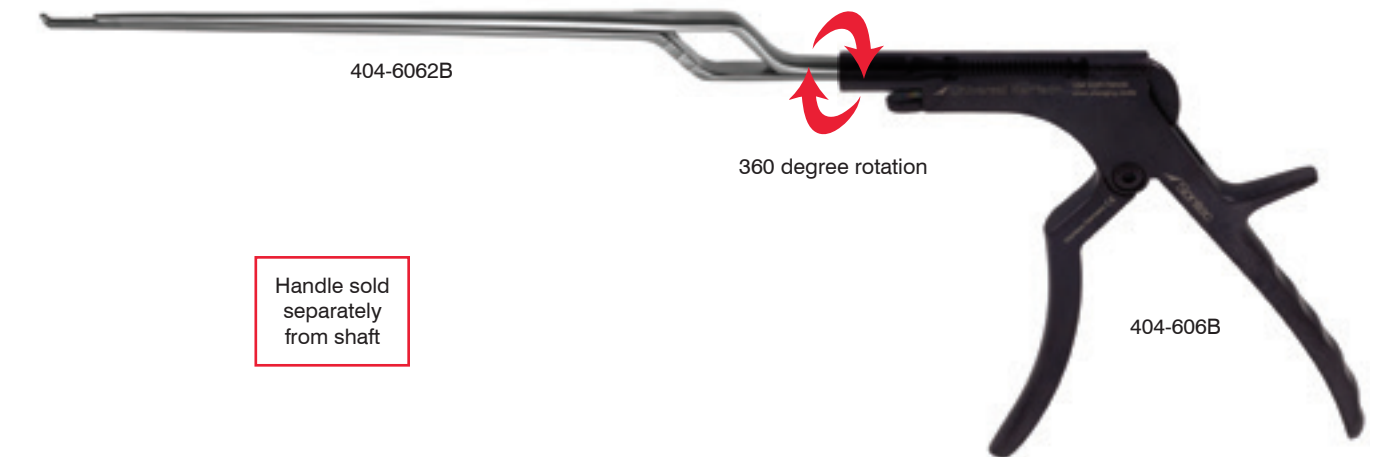
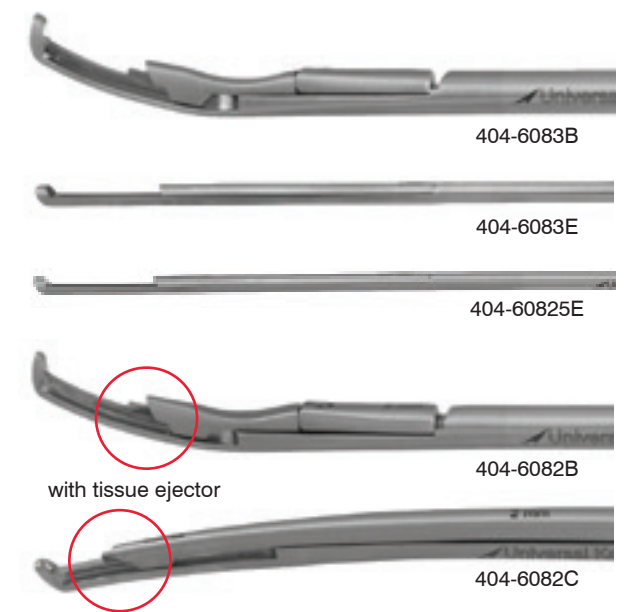

Handle sold separately from shaft

**Kerrison Universal Rotating 360° Rongeur**

Quick trigger release / with tissue ejector / shaft locks in 8 positions through a 360° rotation / 8" (20cm) shaft / 40°

- 404-606 handle
- 404-605 full set includes: handle all 40° sizes 8", all 90° sizes 8"
- 404-6081 1 mm bite
- 404-6082 2 mm bite
- 404-6083 3 mm bite
- 404-6084 4 mm bite
- 404-6085 5 mm bite

With tissue ejector / 10" (25.5cm) shaft

- 404-606 handle
- 404-607 full set- includes: handle all 40° sizes 10", all 90° sizes 10"
- 404-6086 1 mm bite
- 404-6087 2 mm bite
- 404-6088 3 mm bite
- 404-6089 4 mm bite
- 404-6090 5 mm bite

7" (17.5cm) shaft

- 404-6091 0.8 mm bite
- 404-6093 1.5 mm bite

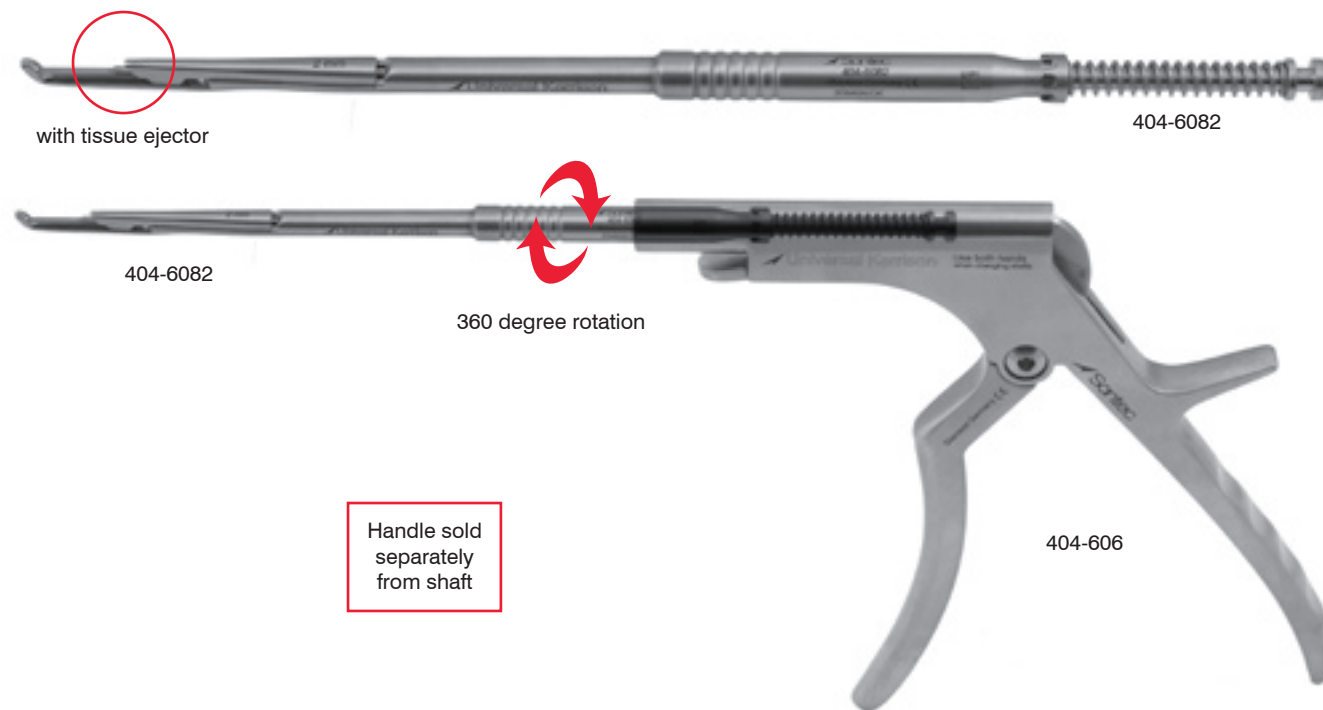

**Kerrison Universal Rotating 360° Rongeur**

Quick trigger release / with tissue ejector / shaft locks in 8 positions through a 360° rotation / 8" (20cm) shaft / 90°

- 404-606 handle
- 404-605 full set includes: handle all 40° sizes 8", all 90° sizes 8"
- 404-6071 1 mm bite 90°
- 404-6072 2 mm bite 90°
- 404-6073 3 mm bite 90°
- 404-6074 4 mm bite 90°
- 404-6075 5 mm bite 90°

With tissue ejector / 10" (25.5cm) shaft

- 404-606 handle
- 404-607 full set- includes: handle all 40° sizes 10", all 90° sizes 10"
- 404-6076 1 mm bite 90°
- 404-6077 2 mm bite 90°
- 404-6078 3 mm bite 90°
- 404-6079 4 mm bite 90°
- 404-6080 5 mm bite 90°

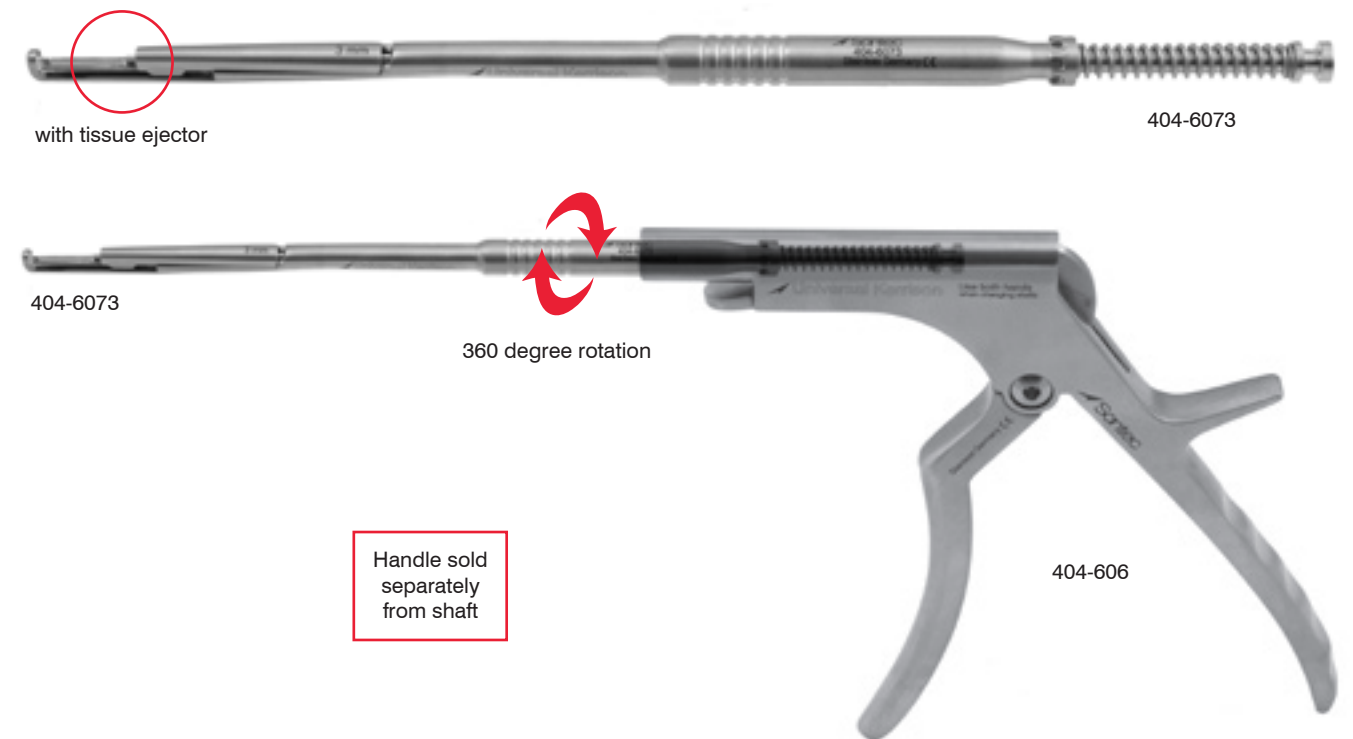

**Kerrison Universal Rotating 360° Rongeur Handle**

- 404-606 stainless steel
- 404-606B black ceramic
- 404-606SB black ceramic silicone handle



404-606



404-606SB



404-606B

**Sontec Beatty Foraminotomy Rongeur**

**7 3/4" (19.5 cm) shaft / curved up**

- 404-461 2 mm bite
- 404-462 3 mm bite
- 404-463 4 mm bite

**7 3/4" (19.5 cm) shaft / curved down**

- 404-450 2 mm bite
- 404-451 3 mm bite
- 404-452 4 mm bite

\* Also available with rounded footplate



slightly curved up



curved up

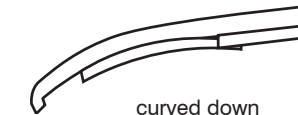

curved down



404-462

**Beatty Foraminotomy Rongeur**

Black ceramic coating / 8" (20.3 cm) shaft / slightly curved up

- 404-461B 2 mm bite
- 404-462B 3 mm bite
- 404-463B 4 mm bite

\* Also available with rounded footplate

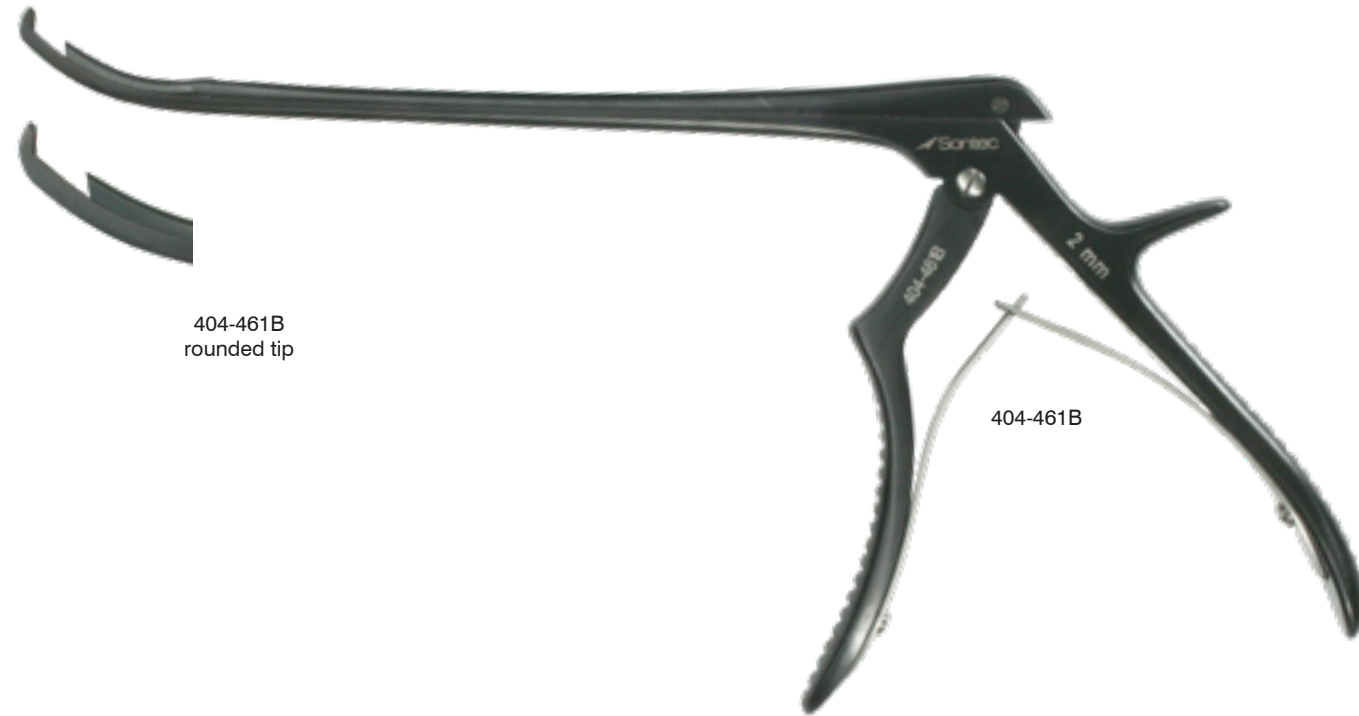

**Kerrison 40° Rongeur**

Black ceramic coated / thin footplate punch / 10 mm opening

	Bite Width	Length of Shaft		
		6" / 15 cm	7" / 18 cm	8" / 21 cm
40° Up-Angle	1 mm	404-490B	404-539B	404-400B
	1.5 mm		<b>NEW SIZE</b> 404-5391	
	2 mm	404-491B	404-540B	404-402B
	2.5 mm		<b>NEW SIZE</b> 404-5401	
	3 mm	404-492B	404-541B	404-404B
	4 mm	404-493B	404-542B	404-406B
	5 mm	404-494B	404-543B	404-408B
	6 mm	404-495B	404-544B	404-410B



**Kerrison 90° Rongeur**

Black ceramic coated / 10 mm opening

	Bite Width	Length of Shaft		
		6" / 15 cm	7" / 18 cm	8" / 21 cm
Up-Bite	1 mm	404-470B	404-519B	404-412B
	2 mm	404-471B	404-520B	404-414B
	3 mm	404-472B	404-521B	404-416B
	4 mm	404-473B	404-522B	404-418B
	5 mm	404-474B	404-523B	404-420B
	6 mm	404-475B	404-524B	404-422B



404-520B

**Kerrison 90° Rongeur**

Thin footplate-punch / ceramic coating

	Bite Width	Length of Shaft		
		6" / 15 cm	7" / 18 cm	8" / 21 cm
90° Down-Bite	1 mm	404-480B	404-530B	404-424B
	2 mm	404-481B	404-525B	404-426B
	3 mm	404-482B	404-526B	404-428B
	4 mm	404-483B	404-527B	404-430B
	5 mm	404-484B	404-528B	404-432B
	6 mm	404-485B	404-529B	404-434B



404-526B

**Kerrison 40° Laminectomy/Lumbar Rongeur**

Black ceramic coating / 8" (20 cm) shaft / wide mouth 15 mm jaw opening / with & without ejection pin

	Bite Width	w/Ejector Pin	wo/Ejector Pin	wo/Ejector Pin Stainless Steel
40° Up-Angle	1 mm		404-337B	404-332
	2 mm	404-332B	404-338B	404-333
	3 mm	404-333B	404-339B	404-334
	4 mm	404-334B	404-340B	404-335
	5 mm	404-335B	404-341B	



**Kerrison 40° Rongeur**

Thin footplate-punch / 10 mm opening

	Bite Width	Length of Shaft		
		6" / 15 cm	7" / 18 cm	8" / 21 cm
40° Up-Angle	1 mm	404-490	404-539	404-400
	2 mm	404-491	404-540	404-402
	3 mm	404-492	404-541	404-404
	4 mm	404-493	404-542	404-406
	5 mm	404-494	404-543	404-408
	6 mm	404-495	404-544	404-410



**Kerrison 90° Rongeur**

Thin footplate punch / 10 mm opening / up

	Bite Width	Length of Shaft		
		6" / 15 cm	7" / 18 cm	8" / 21 cm
Up-Bite	1 mm	404-470	404-519	404-412
	2 mm	404-471	404-520	404-414
	3 mm	404-472	404-521	404-416
	4 mm	404-473	404-522	404-418
	5 mm	404-474	404-523	404-420
	6 mm	404-475	404-524	404-422



404-520

**Sontec Kerrison Rongeur 90° Down Bite Rongeur**

Thin footplate / 10mm opening down

	Bite Width	Length of Shaft		
		6" / 15 cm	7" / 18 cm	8" / 21 cm
90° Down Bite	1 mm	404-480	404-530	404-424
	2 mm	404-481	404-525	404-426
	3 mm	404-482	404-526	404-428
	4 mm	404-483	404-527	404-430
	5 mm	404-484	404-528	404-432
	6 mm	404-485	404-529	404-434



404-524

**Sontec Kerrison 40° Rongeur**

Thin footplate / 10 mm opening / down

	Bite Width	Length of Shaft	
		7" / 18 cm	8" / 21 cm
	1 mm	404-5301	404-553
	2 mm	404-5302	404-554
	3 mm	404-5303	404-556
	4 mm	404-5304	404-557
	5 mm	404-5305	404-558
	6 mm	404-5306	404-559



**Kerrison 40° Rongeur**

Black and gold ceramic coating / thin footplate-punch / up / 8" (20.3 cm)

	Bite Width	Metal
		Black/Gold
	1 mm	404-400BG
	2 mm	404-402BG
	3 mm	404-403BG
	4 mm	404-404BG
	5 mm	404-405BG



**Kerrison Bayonet 40° Rongeur**

Thin footplate / 10 mm opening / 8" (20 cm) shaft / with & without ejection pin

	Bite Width	With Pin	Without Pin
40° Up-Angle	1 mm	NA	404-401
	2 mm	404-4052	404-409
	3 mm	404-405	404-4033
	4 mm	404-4054	404-407
	5 mm	404-4055	404-403



**Kerrison Bayonet 40° Rongeur**

Black ceramic coating / thin footplate / 10 mm opening / 8" (20 cm) shaft / with & without ejection pin

	Bite Width	With Pin	Without Pin
40° Up-Angle	1 mm	NA	404-401B
	2 mm	404-4052B	404-409B
	3 mm	404-405B	404-4033B
	4 mm	404-4054B	404-407B
	5 mm	404-4055B	404-403B



**Kerrison Bayonet Foraminotomy Rongeur**

Curved up / 10" (25.4 cm) shaft







- 404-468 2 mm jaw with thin footplate
- 404-4683 3 mm jaw with thin footplate
- 404-4684 4 mm jaw with thin footplate



**Kerrison Convertible 40° Rongeur**

8" (20.3 cm) shaft / 10 mm opening / without  
ejection pin / ejector pin for 3 mm sizes and  
longer only

- \* Other tip sizes & lengths available upon request.
- \* Swing system for easy cleaning
- \* Sizes available 4-6 mm with pin

		Bite Width		
40° Up-Angle		1 mm	404-337C	without pin
		2 mm	404-338C	without pin
		3 mm	404-339C	with pin
		4 mm	404-340C	with pin
		5 mm	404-341C	with pin
		6 mm	404-342C	with pin

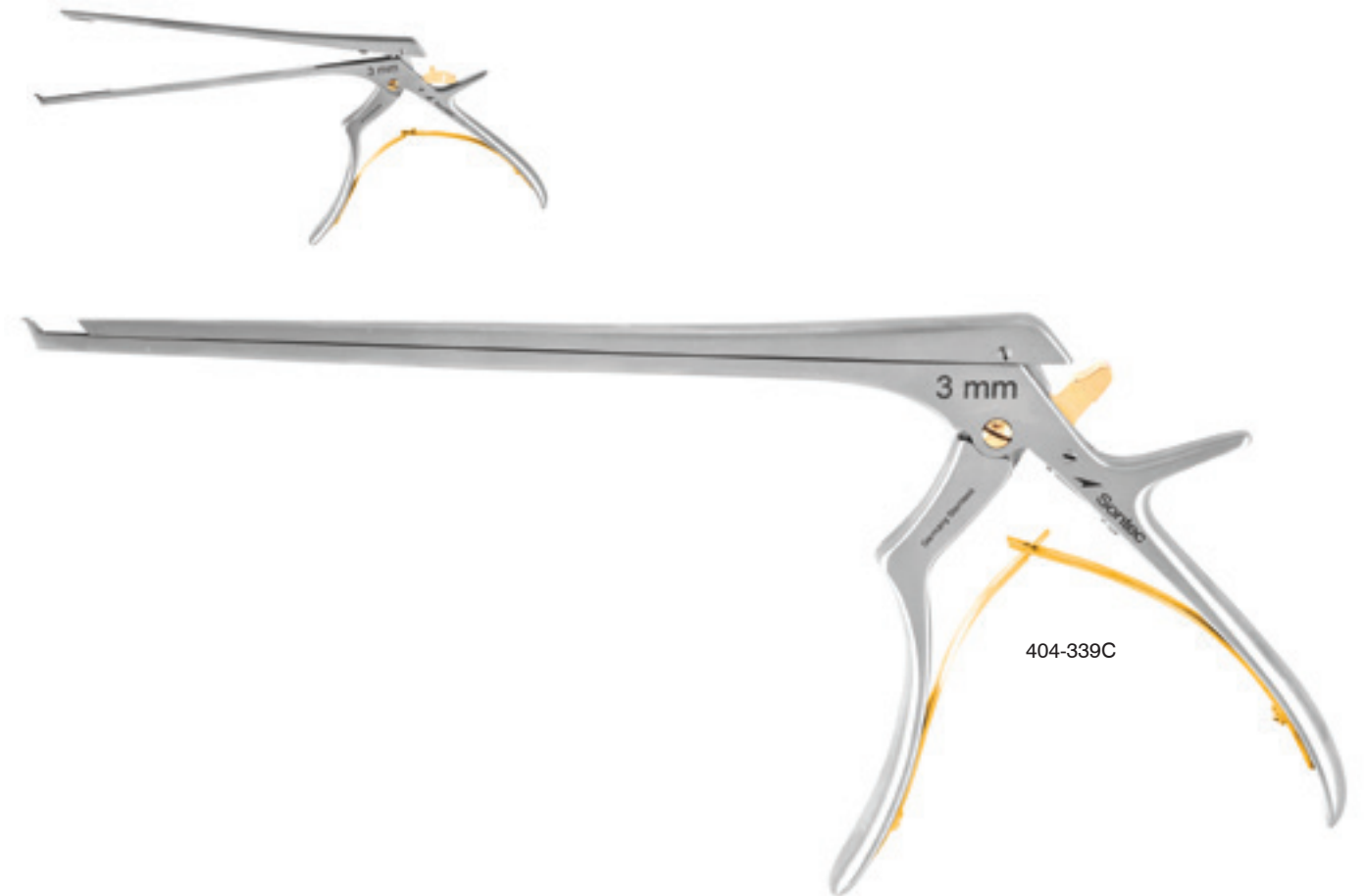

**Kerrison 40° Rongeur Titanium**

7" (18 cm)  
2603-541 3 mm



2603-541

**Sontec Kerrison 40° Rongeur**

10 mm opening / up / with ejection pin

	Bite Width	Length of Shaft	
		7" / 18 cm	8" / 21 cm
40° Up-Angle	2 mm	404-540EJ	404-402EJ
	3 mm	404-541EJ	404-404EJ
	4 mm	404-542EJ	404-406EJ
	5 mm	404-543EJ	404-408EJ



404-542EJ

ejector pin

**Kerrison Punch (Occular-plasti) 90° Rongeur**

**4" (10 cm) shaft**

16-2100	1.0 mm	wide up
16-2101	1.5 mm	wide up
16-2102	2.0 mm	wide up
16-2106	2.5 mm	wide up
16-2103	3.0 mm	wide up
16-2104	3.0 mm	wide down
16-2105	4.0 mm	wide down
16-2107	4.0 mm	wide up

**Black ceramic coating / 4" (10 cm) shaft**

16-2101B	1.5 mm	wide up
16-2102B	2 mm	wide up



16-2101



16-2103



16-2105



16-2107



16-2102



16-2104



16-2106



**Kerrison Punch (Occular-plasti) 40° Rongeur**

**4" (10 cm) shaft**

16-2096	1.0 mm wide
16-2097	1.5 mm wide
16-2098	2.0 mm wide
16-2099	3.0 mm wide

**Black ceramic coating / 4" (10 cm) shaft**

16-2096B	1.0 mm wide
16-2097B	1.5 mm wide
16-2098B	2.0 mm wide

		Bite Width	
40° Up-Angle		1 mm	16-2096
		1.5 mm	16-2097
		2 mm	16-2098
		3 mm	16-2099



16-2098

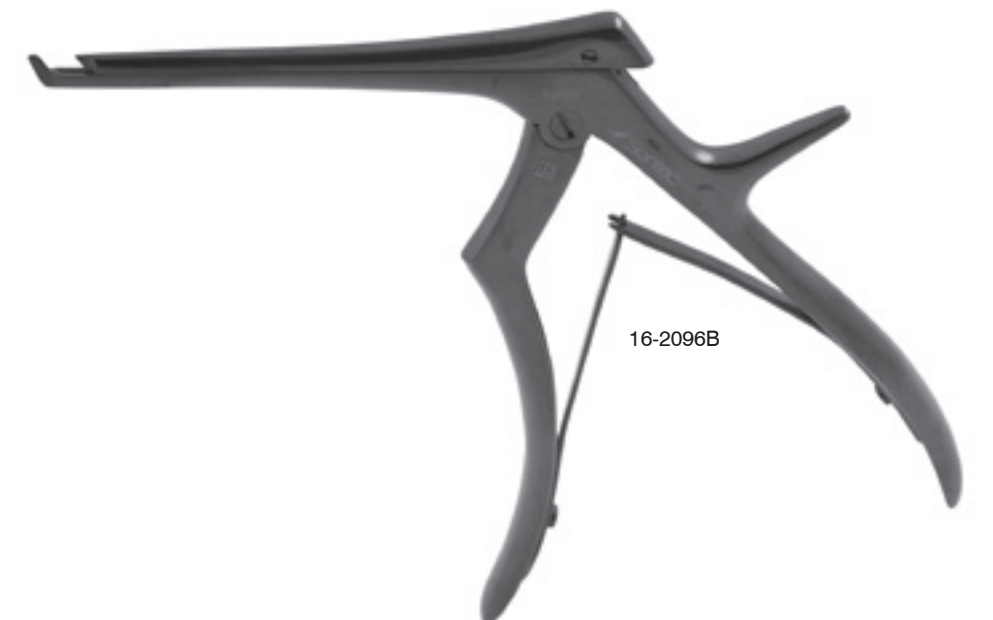
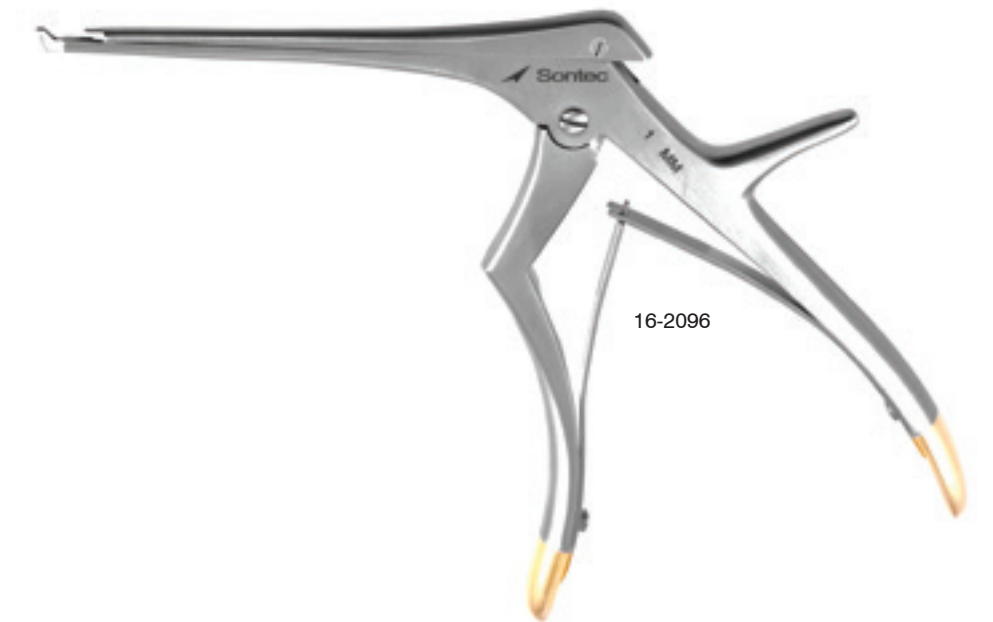

**Sontec Kerrison Rongeur**

40° / easy clean / 8" (20.3 cm)

- 404-400E 1 mm
- 404-402E 2 mm with ejector pin
- 404-404E 3 mm with ejector pin
- 404-406E 4 mm with ejector pin
- 404-408E 5 mm with ejector pin

	Bite Width	With Pin	Without Pin
40° Up-Angle 	1 mm	NA	404-400E
	2 mm	404-402E	NA
	3 mm	404-404E	NA
	4 mm	404-406E	NA
	5 mm	404-408E	NA



**Rongeurs Tray**

Anodized aluminum tray / 9" x 13" x 6"

18-3562



18-3562



## Care and Maintenance for the Universal Rotating 360° Kerrison Rongeur Shafts & Handles

The Universal Rotating 360° Kerrison Rongeur shafts are comprised of four parts:  
 A: outside shaft with frontal jaw blade  
 B: Inner shaft with threading at the tip  
 C: Back side blade/ jaw with screw port at the end  
 D: spring

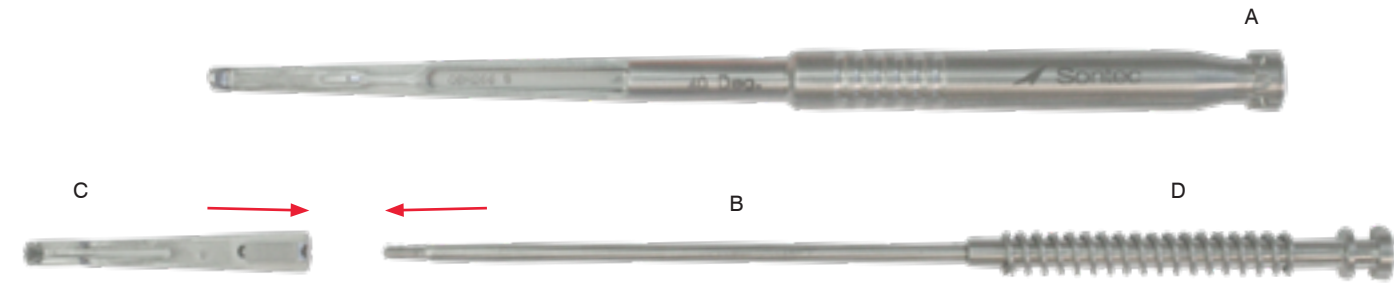

Slide inner shaft (B) through outer shaft (A).  
 Then screw jaw (C) into inner shaft (B).



Screw inner shaft (B) and jaw (C) completely together (only after Inner shaft (B) and outer shaft (A) are together.)

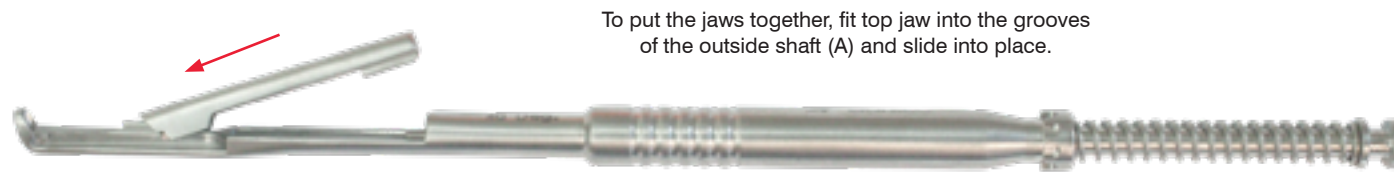

To put the jaws together, fit top jaw into the grooves of the outside shaft (A) and slide into place.

Use the grooves on the outside shaft (A) and the back side jaw/ blade (C) to fit the two parts into position.



This is the point where the jaw/ blade (C) and inner shaft (B) are screwed together. You must make sure the two parts are fully screwed together for the Rongeur to work properly.

### RELEASING SHAFT

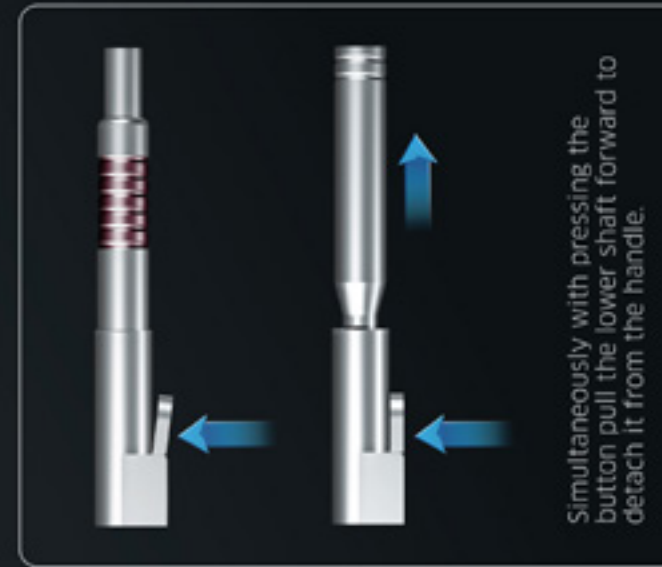

Simultaneously with pressing the button pull the lower shaft forward to detach it from the handle.

### INSERTING SHAFT

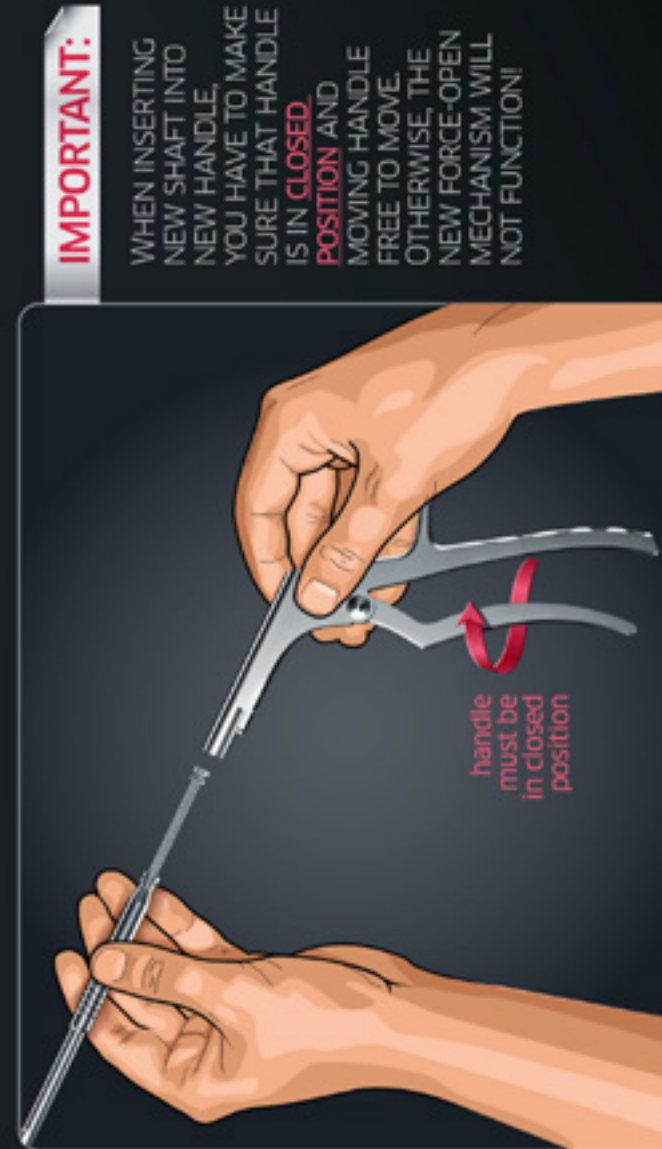

**IMPORTANT:**

WHEN INSERTING NEW SHAFT INTO NEW HANDLE, YOU HAVE TO MAKE SURE THAT HANDLE IS IN **CLOSED POSITION** AND MOVING HANDLE FREE TO MOVE. OTHERWISE, THE NEW FORCE-OPEN MECHANISM WILL NOT FUNCTION!

handle must be in closed position

low and the positive results are almost immediately visible.

For detailed information regarding training and available additional instruction see the contacts on the back cover of this brochure.

This new kind of Kerrison's approach, besides significant financial savings simplifies the entire working process. Your productivity will not be affected by a very short training period. The costs of migration to this new product are very

Click Kerrison punches are suitable for all kinds of shafts: Straight, Bayonet, Curved up and down. You do not need to keep a large stock of Kerrisons, only the shafts are necessary.



 Sontec Instruments®

Pistol Grip RONGEURS

**Weil-Blakesley Rongeur**

**Pointed elliptical fenestrated jaw / 4 1/2" (11.5 cm) shaft**

- 404-767 3 x 8 mm jaw
- 404-768 4 x 12 mm jaw
- 404-769 5 x 12.5 mm jaw
- 404-770 6 x 13 mm jaw

**Pointed elliptical fenestrated jaw / 45° / 4 1/2" (11.5 cm) shaft**

- 404-766 3 x 8 mm jaw
- 404-771 4 x 12 mm jaw
- 404-772 5 x 12.5 mm jaw

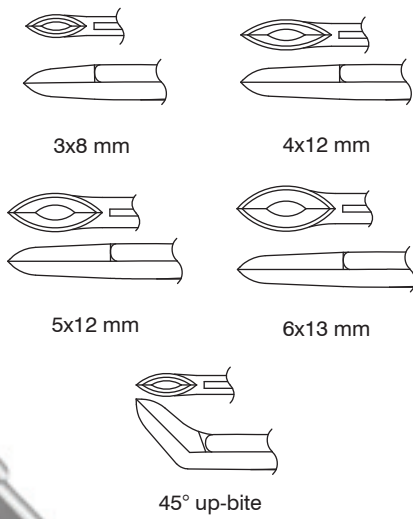

404-767

**Weil Nasal Rongeur**

**5 mm bite / 4 1/4" (10.5 cm) shaft**

- 468-548 straight
- 468-550 45° angled up



468-548

468-550

468-550

**Wilde Ethmoid Rongeur**

**Rounded elliptical fenestrated jaw / 4 1/2" (11.5 cm) shaft**

- 468-600 3x8 mm jaw
- 468-610 4x12 mm jaw
- 468-620 5x12.5 mm jaw

**Rounded elliptical fenestrated jaw / 45° up-bite / 4 1/2" (11.5 cm) shaft**

- 468-606 3x8 mm jaw
- 468-616 4x12 mm jaw
- 468-622 5x12.5 mm jaw

**Rounded elliptical fenestrated jaw / 3x8.0 mm jaw / with suction / 4 1/2" (11.5 cm) shaft**

- 468-636 straight
- 468-638P 45° up-bite

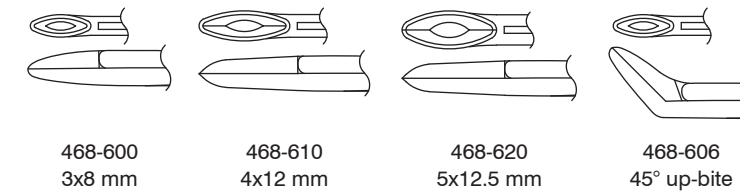

468-600  
3x8 mm

468-610  
4x12 mm

468-620  
5x12.5 mm

468-606  
45° up-bite



468-600

468-636

**Wilde Ethmoid Arthroscopic Rongeur**

Fenestrated jaw / 7" (17.8 cm) shaft / 2.5 mm

- 404-774 straight
- 404-775 up-bite
- 404-776 down-bite



**Ethmoid Pediatric Rongeur**

2.5 mm micro jaw / 3 3/4" (9.5 cm) shaft

- 468-580 straight
- 468-585 45° up-angle
- 468-590 90° up-angle



468-590



468-585

**Blakesley-Ethmoid Rongeur**

3.5 mm jaw / 4 1/4" (11 cm) shaft

- 468-680 45° up-angle
- 468-682 90° up-angle



468-682



468-680

**Blakesley Ethmoid Rongeur**

4.5 mm x 11 mm fenestrated jaw / 4 1/4" (10.8 cm)

- 468-684 40° angle
- 468-686 90° up-angle



468-686

**Williams-Sontec Rongeur**

For arthroscopy & discectomy / very sharp / 2 mm x 5 mm jaw / 1 x 2 teeth / 5 1/2" (14 cm) shaft

404-824



actual size



404-824

**Mcllwraith Basket Cutter Rongeur**

5" (12.5 cm)

1404-857 2.5 mm x 8 mm jaw

1404-858 3.5 mm x 8 mm jaw



actual size



1404-857

**Mcllwraith Arthroscopic Scissors Rongeur**

Scissor action / serrated / 1 mm x 14 mm cup / 5" (12.5 cm) shaft

1404-855



1404-855

**Mcllwraith-Peapod Rongeur**

Longer shaft available by special order



404-783

**Straight / 5 1/2" (14 cm) shaft**

404-782 2.2 mm x 6 mm jaw cup

**Up-angled / 5 1/2" (14 cm) shaft**

404-783 2.2 mm x 6 mm jaw cup small

404-784 3 mm x 6 mm jaw cup medium

404-785 4 mm x 6 mm jaw cup large

**Peapod-McIlwraith Rongeur**



**Straight / 3.2 mm x 6 mm jaw cup / 5 1/2" (14 cm)**

1404-866

**Bailey Rongeur**



**3 x 6 mm, 4 1/2" (11.4 cm)**

- 440-308 straight
- 440-309 25° down
- 440-310 70° down
- 440-311 90° down
- 440-312 45° left
- 440-313 45° right



440-309



440-310



440-311



440-312



440-313

**Peapod Extended Shaft Rongeur**

**Up-angled / 6 1/4" (16 cm) shaft**

- 404-779 2.2 mm x 6 mm jaw cup small
- 404-780 3 mm x 6 mm jaw cup medium
- 404-781 4 mm x 6 mm jaw cup large



**Selverstone Peapod Rongeur**

**Straight / 2 mm x 5 mm jaw / 6" (15.5 cm) shaft**

404-789



**Takahashi Rongeur**

**2.5 mm x 10 mm jaw cup / straight**

- 404-786 3 1/2" (9 cm) shaft
- 404-787 4 1/2" (11.5 cm) shaft
- 404-788 5 1/2" (14 cm) shaft

**3 mm x 10 mm jaw cup / 4 1/2" (11.5 cm) shaft**

- 404-788U up-angled
- 404-7871 straight

**3 mm x 8 mm oval jaw cup / straight**

- 404-7885 5 1/2" (14 cm) shaft

**3.5 mm x 10 mm jaw cup / straight**

- 404-7875 4" (10 cm) shaft



404-788U



404-7871



404-7875

**McIlwraith Cup Rongeur**

**Round cup / straight / 7" (18 cm) shaft**

- 1404-845A 2 mm cup
- 1404-845B 4 mm cup
- 1404-845D 6 mm cup

**Round cup / up-angled / 7" (18 cm) shaft**

- 1404-846A 2 mm cup
- 1404-846B 4 mm cup
- 1404-846D 6 mm cup



1404-846D



1404-845A



1404-845D

**Sheen Fragment Retriever Forceps**

**Low profile / 7" (18 cm)**

- 469-035



469-035

**Cushing Pituitary Rongeur**

**2 mm x 10 mm bite**

404-712	straight	5" (13 cm) shaft
404-714	up-angled	5" (13 cm) shaft
404-716	down-angled	5" (13 cm) shaft
404-719	straight	7" (18 cm) shaft
404-721	up-angled	7" (18 cm) shaft
404-723	down-angled	7" (18 cm) shaft
404-711	straight	12" (30.5 cm) shaft
404-711U	up	12" (30.5 cm) shaft
404-711D	down	12" (30.5 cm) shaft

bite size  
  
 2 x 10 mm



404-719



404-721



404-723

**Love-Gruenwald Pituitary Rongeur**

**3 mm x 10 mm bite**

404-727	straight	5" (13 cm) shaft
404-729	up-angled	5" (13 cm) shaft
404-731	down-angled	5" (13 cm) shaft
404-734	straight	7" (18 cm) shaft
404-736	up-angled	7" (18 cm) shaft
404-737	down-angled	7" (18 cm) shaft
404-738	straight	12" (30.5 cm) shaft
404-738U	up	12" (30.5 cm) shaft
404-738D	down	12" (30.5 cm) shaft

bite size  
  
 3 x 10 mm



404-727



404-729



404-734

**Schlesinger (Cloward) Rongeur**

**Serrated bite / straight / 6" (15 cm) shaft**

- 404-754 2 mm x 10 mm bite
- 404-755 3 mm x 10 mm bite
- 404-755L 3 mm x 10 mm bite
- 404-756 4 mm x 10 mm bite
- 404-761 6 mm x 10 mm bite

7" shaft

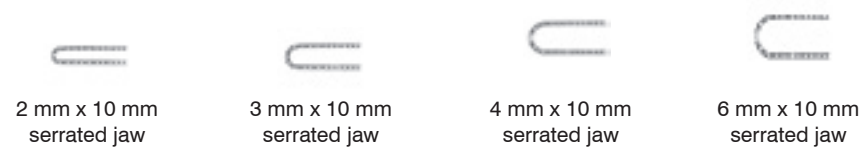

Longer shaft available by special order

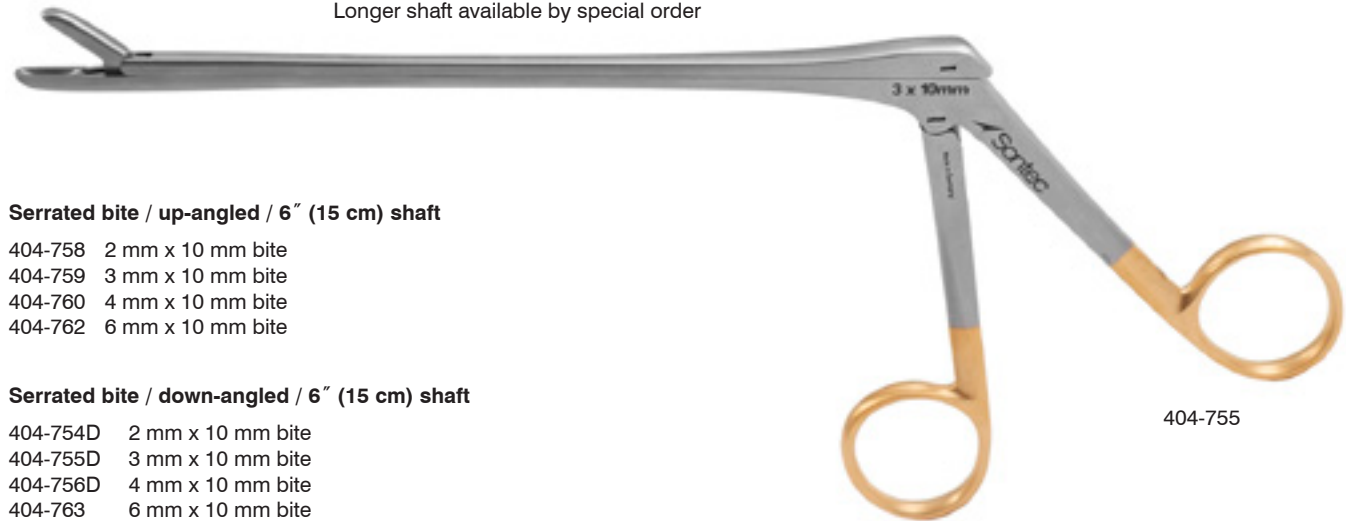

**Serrated bite / up-angled / 6" (15 cm) shaft**

- 404-758 2 mm x 10 mm bite
- 404-759 3 mm x 10 mm bite
- 404-760 4 mm x 10 mm bite
- 404-762 6 mm x 10 mm bite

**Serrated bite / down-angled / 6" (15 cm) shaft**

- 404-754D 2 mm x 10 mm bite
- 404-755D 3 mm x 10 mm bite
- 404-756D 4 mm x 10 mm bite
- 404-763 6 mm x 10 mm bite

**Spurling Pituitary Rongeur**

**4 mm x 10 mm bite**

- 404-740 straight 5" (12.5 cm) shaft
- 404-742 up-angled 5" (12.5 cm) shaft
- 404-744 down-angled 5" (12.5 cm) shaft
- 404-747 straight 7" (18 cm) shaft
- 404-749 up-angled 7" (18 cm) shaft
- 404-751 down-angled 7" (18 cm) shaft
- 404-739 straight 12" (30.5 cm) shaft
- 404-739U up angle 12" (30.5 cm) shaft
- 404-739D down angle 12" (30.5 cm) shaft

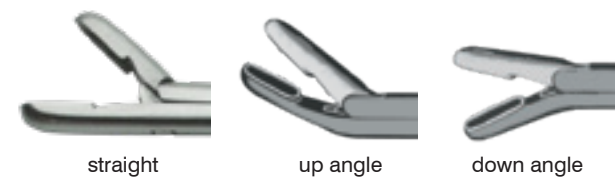

**NEW EASY CLEAN**

**Cushing Pituitary Rongeur**

**Easy clean / straight / 2 mm x 10 mm jaw / 7" (17.8 cm)**

404-719E



**Love Gruenwald Pituitary Rongeur**

**Easy clean / straight / 3 mm x 10 mm jaw / 7" (17.8 cm)**

404-734E



**Spurling Pituitary Rongeur**

**Easy clean / straight / 4 mm x 10 mm jaw / 7" (17.8 cm)**

404-747E



**Caspar Grasping Rongeur**

**Straight / 5 1/2" (14 cm) shaft**

- 53-0510 2 mm x 12 mm jaw
- 53-0512 3 mm x 12 mm jaw
- 53-0514 4 mm x 14 mm jaw
- 53-0516 5 mm x 14 mm jaw
- 53-0518 6 mm x 16 mm jaw

**Straight / 6 1/4" (16 cm) shaft**

- 53-0520 2 mm x 12 mm jaw
- 53-0522 3 mm x 12 mm jaw
- 53-0524 4 mm x 14 mm jaw
- 53-0526 5 mm x 14 mm jaw
- 53-0528 6 mm x 16 mm jaw

**Straight / 7 1/4" (18.5 cm)**

- 53-0530 2 mm x 12 mm jaw
- 53-0532 3 mm x 12 mm jaw
- 53-0534 4 mm x 14 mm jaw
- 53-0536 5 mm x 14 mm jaw
- 53-0538 6 mm x 16 mm jaw

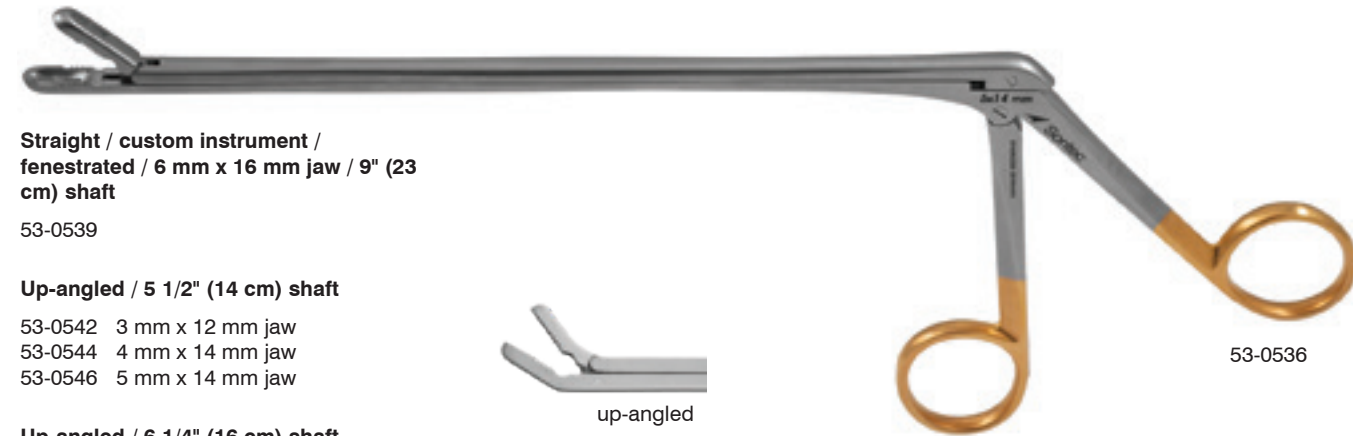

**Straight / custom instrument / fenestrated / 6 mm x 16 mm jaw / 9" (23 cm) shaft**

53-0539

**Up-angled / 5 1/2" (14 cm) shaft**

- 53-0542 3 mm x 12 mm jaw
- 53-0544 4 mm x 14 mm jaw
- 53-0546 5 mm x 14 mm jaw



up-angled  
actual size

**Up-angled / 6 1/4" (16 cm) shaft**

- 53-0552 3 mm x 12 mm jaw
- 53-0554 4 mm x 14 mm jaw
- 53-0556 5 mm x 14 mm jaw

**Up-angled / 7 1/4" (18.5 cm) shaft**

- 53-0560 2 mm x 12 mm jaw
- 53-0562 3 mm x 12 mm jaw
- 53-0564 4 mm x 14 mm jaw
- 53-0566 5 mm x 14 mm jaw

**Down-angled / 5 1/2" (14 cm) shaft**

- 53-0572 3 mm x 12 mm jaw
- 53-0574 4 mm x 14 mm jaw







down-angled  
actual size

**Down-angled / 6 1/4" (16 cm) shaft**

- 53-0582 3 mm x 12 mm jaw
- 53-0584 4 mm x 14 mm jaw

**Down-angled / 7 1/4" (18.5 cm) shaft**

- 53-0590 2 mm x 12 mm jaw
- 53-0592 3 mm x 12 mm jaw
- 53-0594 4 mm x 14 mm jaw

-  2 mm x 12 mm
-  3 mm x 12 mm
-  4 mm x 14 mm
-  5 mm x 14 mm
-  6 mm x 16 mm

53-0536

**Ferris-Smith Arthroscopic Rongeur**

**4 mm x 6 mm / 7" (18 cm) shaft**

- 404-813 round jaw
- 404-814 square jaw

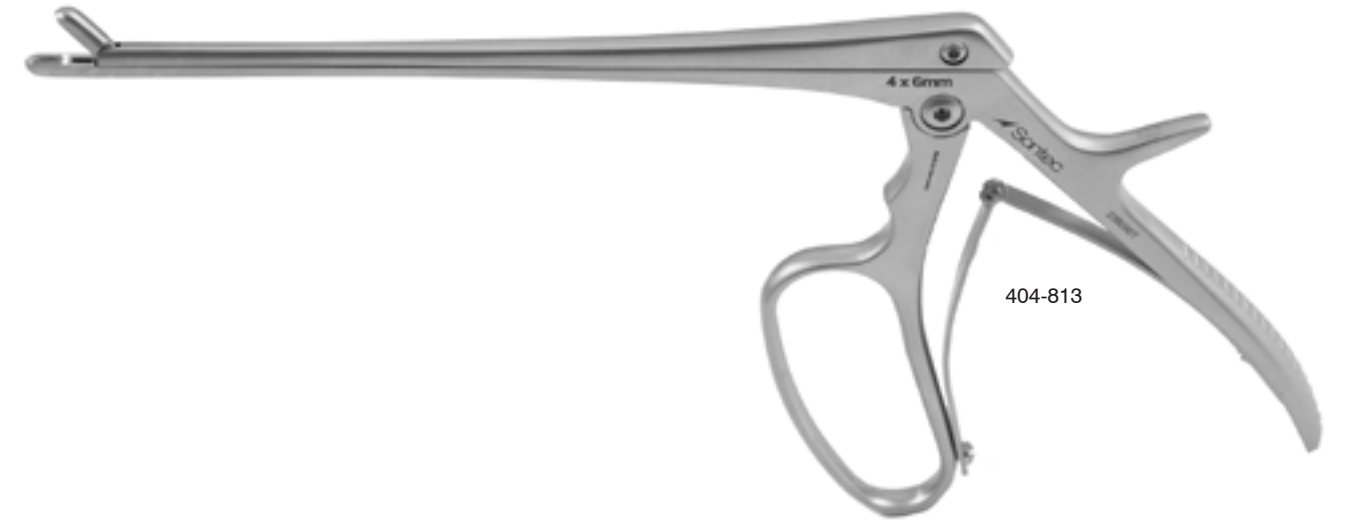

404-813



404-814

**Ferris-Smith Arthroscopic Rongeur**

**Low profile / straight / 7" (18 cm) shaft**

404-790LP	2 mm x 10 mm bite	
404-791LP	3 mm x 10 mm bite	
404-792LP	4 mm x 10 mm bite	
404-793LP	4 mm x 8 mm bite	
404-796LP	5 mm x 10 mm bite	
404-794LP	6 mm x 10 mm bite	
404-795LP	6 mm x 12 mm bite	
404-795SLP	6 mm x 12 mm bite	serrated

**Low profile / up-angled / 7" (18 cm) shaft**

404-800LP	2 mm x 10 mm bite	
404-801LP	3 mm x 10 mm bite	
404-802LP	4 mm x 10 mm bite	
404-803LP	6 mm x 10 mm bite	

**Low profile / down-angled / 7" (18 cm) shaft**

404-810LP	2 mm x 10 mm bite	
404-811LP	3 mm x 10 mm bite	
404-812LP	4 mm x 10 mm bite	



404-792LP



404-800LP

**Ferris-Smith Arthroscopic Rongeur**

**Straight / 7" (18 cm) shaft**

404-790	2 mm x 10 mm bite	
404-791	3 mm x 10 mm bite	
404-792	4 mm x 10 mm bite	
404-792B	4 mm x 10 mm bite	Ceramitec
404-793	4 mm x 8 mm bite	
404-792S	4 mm x 10 mm bite	serrated
404-796	5 mm x 10 mm bite	
404-794	6 mm x 10 mm bite	
404-795	6 mm x 12 mm bite	

**Straight / 8" (20.5 cm) shaft / special order**

404-825	2 mm x 10 mm bite	
404-826	3 mm x 10 mm bite	
404-827	4 mm x 10 mm bite	
404-828	5 mm x 10 mm bite	
404-829	6 mm x 10 mm bite	

**Straight / 9" (23 cm) shaft**

404-7929	4 mm x 10 mm bite	
404-7929LP	4 mm x 10 mm bite	low profile
404-7959	6 mm x 12 mm bite	

**Up-angled / 7" (18 cm) shaft**

404-800	2 mm x 10 mm bite	
404-801	3 mm x 10 mm bite	
404-802	4 mm x 10 mm bite	
404-802S	4 mm x 10 mm bite	serrated
404-803	6 mm x 10 mm bite	

**Up-angled / 8" (20.5 cm) shaft / special order**

404-830	2 mm x 10 mm bite	
404-831	3 mm x 10 mm bite	
404-832	4 mm x 10 mm bite	
404-833	5 mm x 10 mm bite	
404-834	6 mm x 10 mm bite	

\*special order

**Down-angled / 7" (18 cm) shaft**

404-810	2 mm x 10 mm bite	
404-811	3 mm x 10 mm bite	
404-812	4 mm x 10 mm bite	

**Down-angled / 8" (20.5 cm) shaft / special order**

404-835	2 mm x 10 mm bite	
404-836	3 mm x 10 mm bite	
404-837	4 mm x 10 mm bite	
404-838	5 mm x 10 mm bite	
404-839	6 mm x 10 mm bite	

\*special order

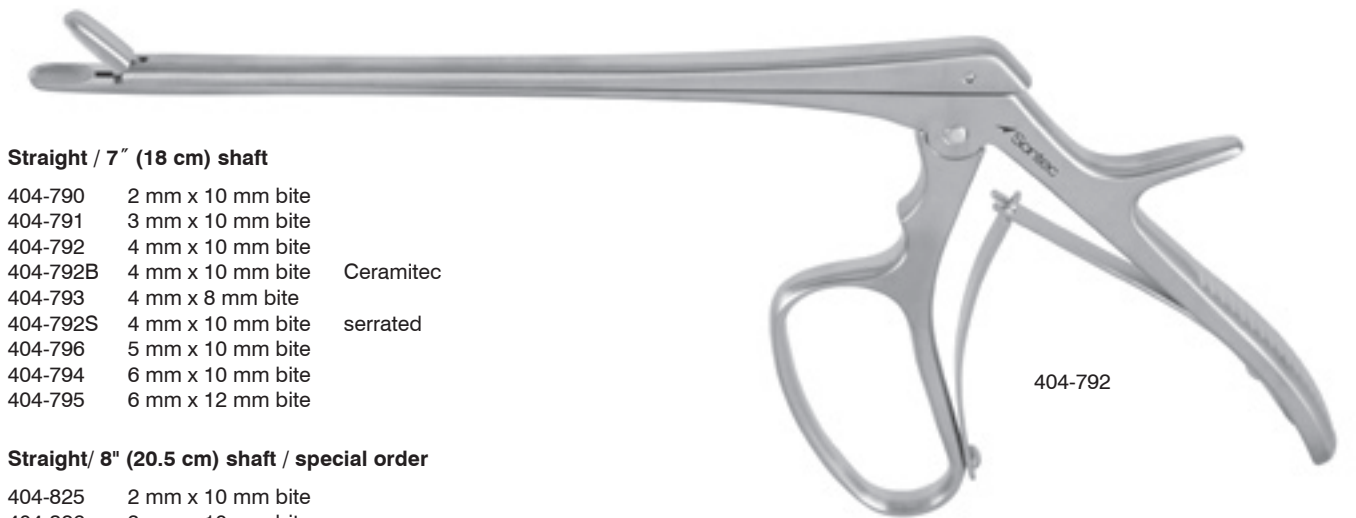

404-792



404-792B



404-792

404-802S

404-792S

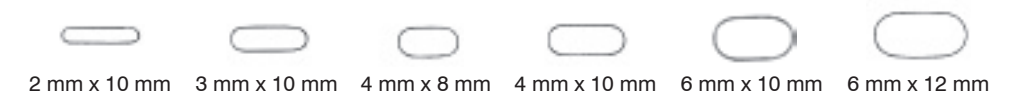

2 mm x 10 mm

3 mm x 10 mm

4 mm x 8 mm

4 mm x 10 mm

6 mm x 10 mm

6 mm x 12 mm

**Ferris-Smith Rongeur**

With Kerrison handle / straight / 4 mm x 8 mm / 7" (18 cm) shaft

404-793K



**Ferris-Smith Wilde Rongeur**

Straight / powerful, low profile, tapered Wilde jaw design / 5 mm x 10 mm bite / 7" (18 cm) shaft

404-777



**Ferris-Smith Arthroscopic Ultra-Low Profile Rongeur with Enhanced Jaw Power**

5 mm x 10 mm / straight jaw

404-797 with fenestrated jaw

404-798 without fenestrated jaw



**Ferris-Smith Spinal Extended Shaft Rongeur**

Extra long shaft / straight / 12" (30.5 cm) shaft

404-822 4mm x 10mm bite serrated

404-823 3mm x 10mm bite

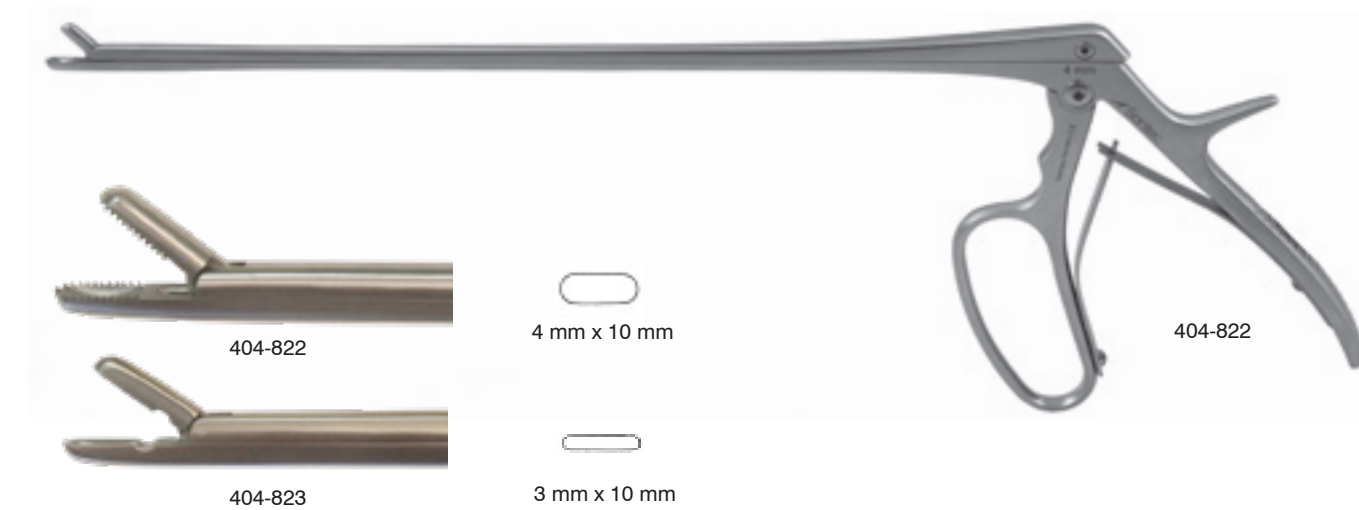

**Ferris-Smith Arthroscopic Rongeur Bayonet**

Straight / 4 x 10 mm / 7" working length / 10" overall length

404-469



**Hoen Grasping Forceps**

1 x 2 teeth / 5 1/2" (14 cm) shaft

1404-862



**Decker Micro Rongeur**

2 mm x 6 mm bite

- 469-053 straight 3 1/2" (9 cm) shaft
- 469-056 straight 6" (15 cm) shaft
- 469-057 cvd right 6" (15 cm) shaft
- 469-058 cvd left 6" (15 cm) shaft
- 469-055 angled up 6" (15 cm) shaft

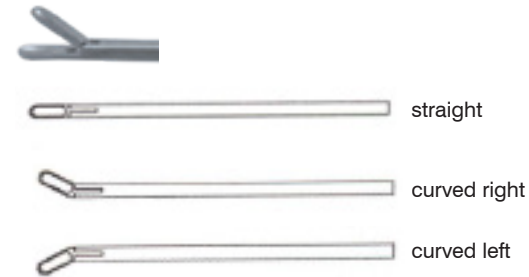

**McIlwraith Arthroscopic Grasping Rongeur**

Heavy duty / 1 x 2 teeth / 6 1/2" (16.5 cm) shaft

- 1404-860 4 mm x 10 mm jaw
- 1404-865 3.4 mm x 10 mm standard
- 1404-861 3 mm x 10 mm jaw delicate



1404-860



1404-861

**Micro Neuro Biopsy Rongeur**

2.6 mm tip / 10 1/4" WL

1271-089



1271-089

**McIlwraith Arthroscopic Grasping Rongeur**

Straight / 4 mm round cup / 4" (10.2 cm) shaft

1404-842



1404-842



 Sontec Instruments®

Orthopedic DOUBLE ACTION RONGEURS

**Ruskin Rongeur**

**Double action / 6" (15.5 cm)**

315-585	2 mm jaw	str
315-587	2 mm jaw	cvd
315-590	3 mm jaw	str
315-588	3 mm jaw	slight curve
315-589	3 mm jaw	full curve
315-586	4 mm jaw	str
315-593	4 mm jaw	cvd

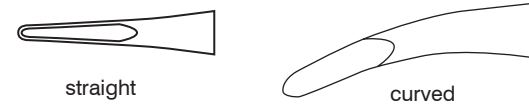

**Double action / 7 1/4" (18.5 cm)**

315-610	5 mm jaw	str
315-612	5 mm jaw	cvd
315-614	6 mm jaw	str
315-616	6 mm jaw	cvd

**Double action / 5 mm / 9 1/2" (23.1 cm)**

315-619	str
315-621	cvd

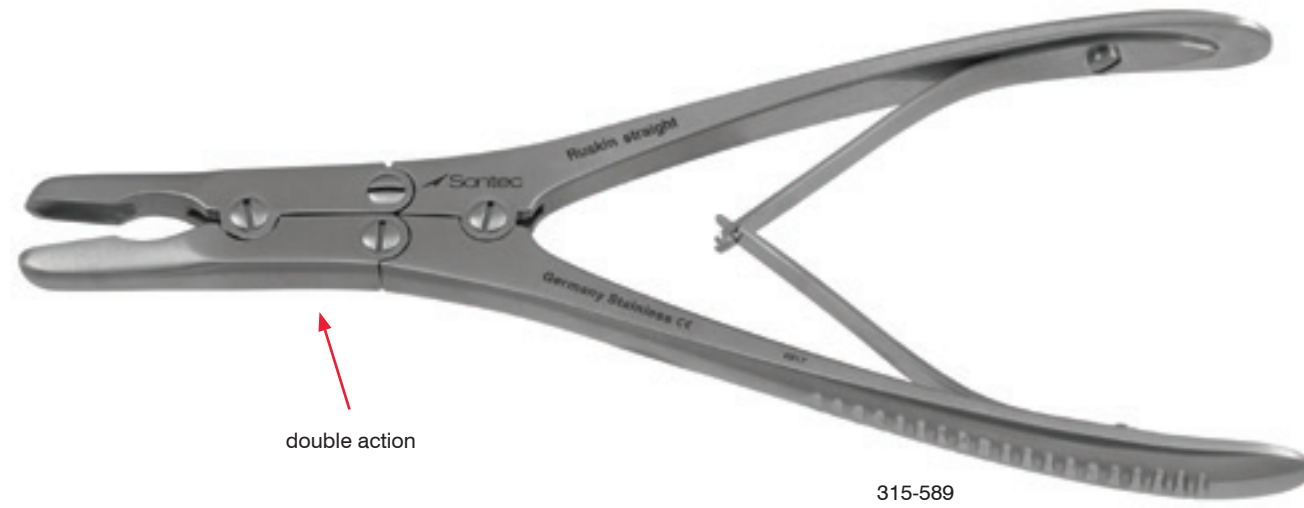
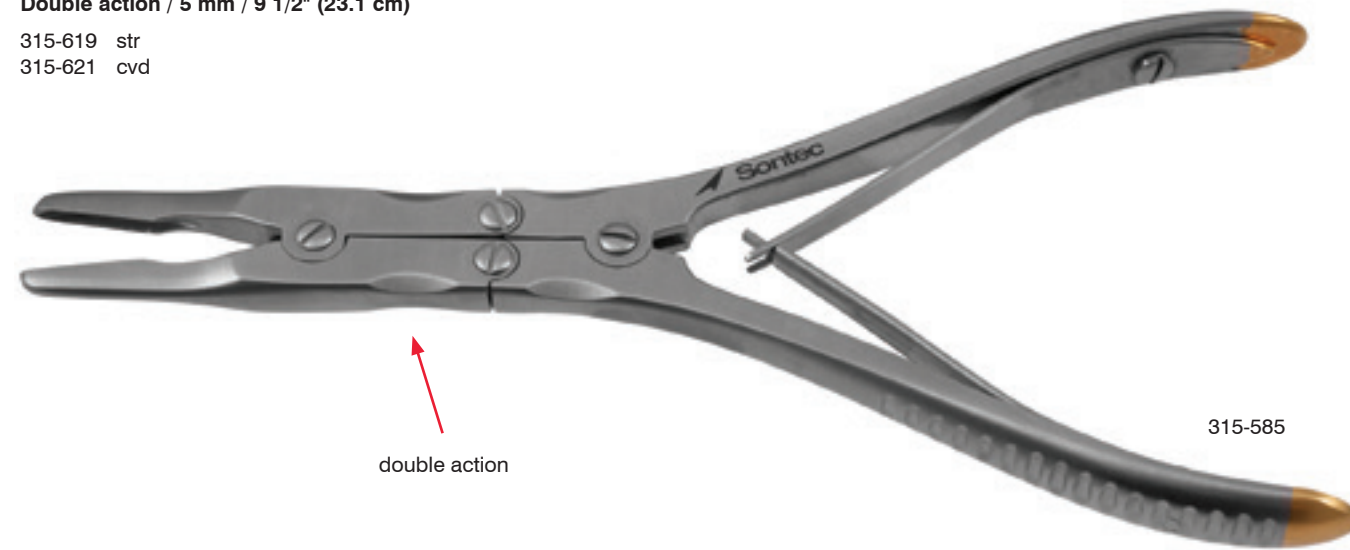

**Black Ruskin Rongeur**

**Curved / double action / ceramic coated / 4 mm / 7 1/4" (18.5 cm)**

315-595

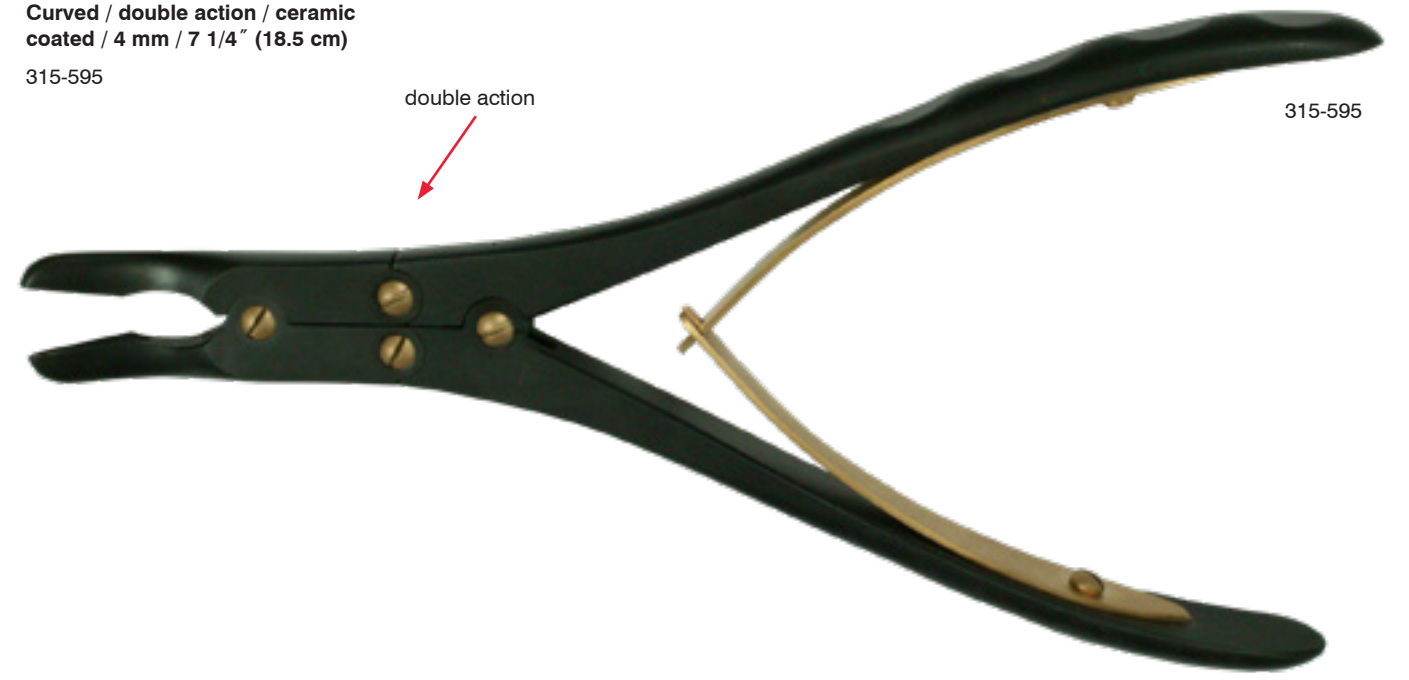

**Kleinert-Kutz Duckbill Synovectomy Rongeur**

**Double action / 2 mm x 10 mm jaw / curved to side / 6" (15.5 cm)**

315-622

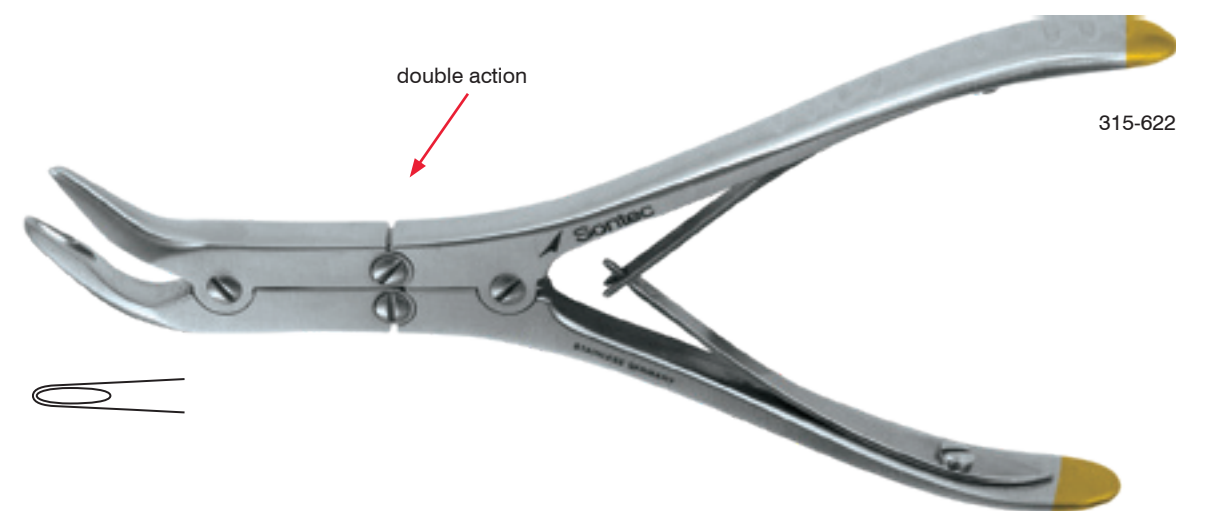

**Ruskin Duckbill Rongeur**

Double action / 5 mm jaw / curved to side / 7 1/4" (18.5 cm)

315-620

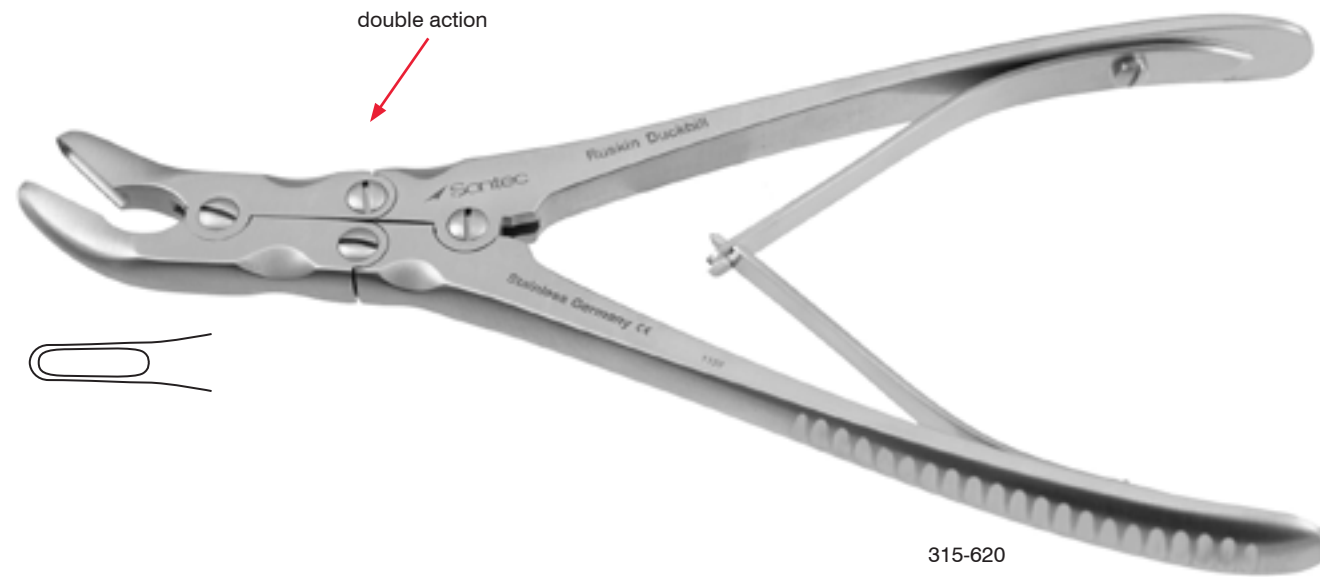

**Zaufel-Jansen Rongeur**

Double-action / 4 mm jaw / 7" (18 cm)

315-600

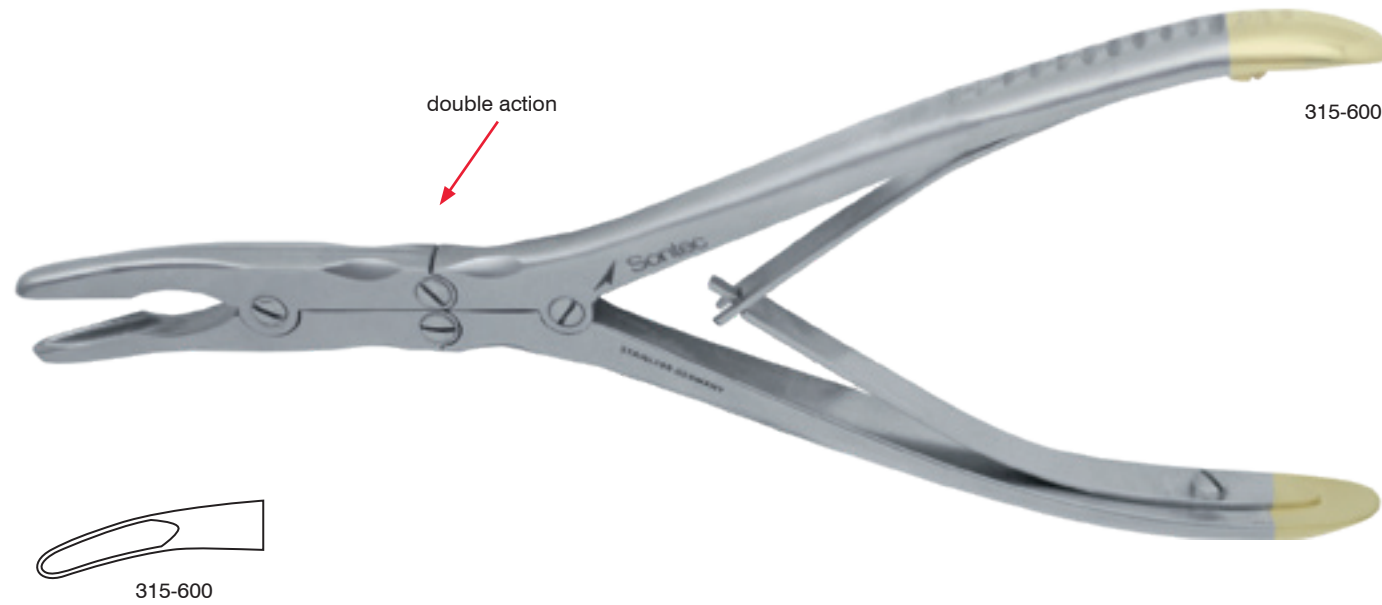

**Beyer Rongeur**

Double-action / curved / 7" (18 cm)

- 315-597 2.3 mm jaw
- 315-598 3.0 mm jaw
- 315-599 4.0 mm jaw

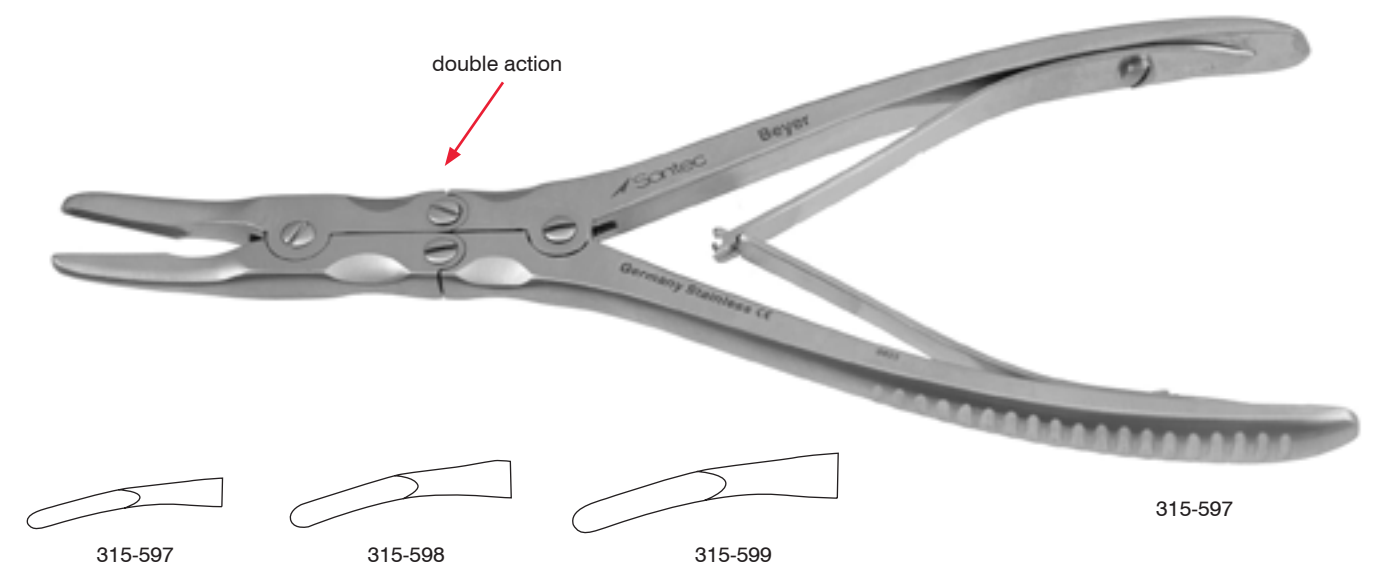

**Smith-Peterson Sontec Streamlined Laminectomy Rongeur**

Unique delicate shape / modified model / double action / curved / 3 mm jaw / 7 1/2" (19 cm)

315-691



**Smith-Peterson Laminectomy Rongeur**

**Stout model / 3 mm jaw / 7 1/2" (19 cm)**

- 315-685 straight
- 315-689 slight curve
- 315-687 full curve

**Standard / 3 mm jaw / 9 1/2" (24 cm)**

- 315-686 straight
- 315-688 slight curve
- 315-690 full curve

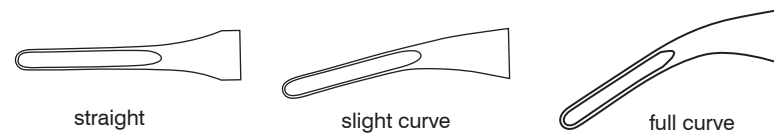

**Leksell Duckbill Rongeur**

**Double action / curved to side / 9" (23 cm)**

- 315-674 3 mm x 16 mm jaw
- 315-671 4 mm x 16 mm jaw
- 315-673 5 mm x 16 mm jaw
- 315-677 6 mm x 16 mm jaw
- 315-679 7 mm x 16 mm jaw
- 315-680 8 mm x 16 mm jaw

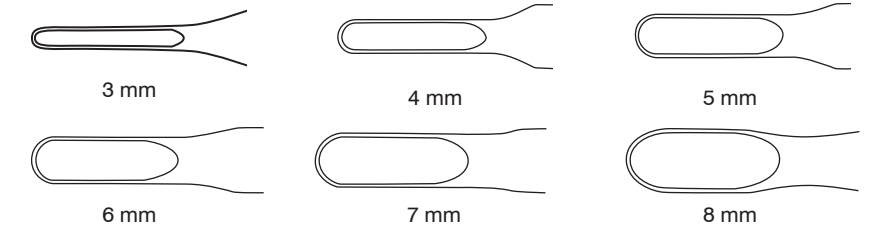

**Double action / curved to side / full curve / 9" (23 cm)**

- 315-676 3 mm x 16 mm jaw
- 315-672 4 mm x 16 mm jaw
- 315-675 5 mm x 13 mm jaw
- 315-678 6 mm x 16 mm jaw
- 315-681 7 mm x 16 mm jaw
- 315-682 8 mm x 16 mm jaw

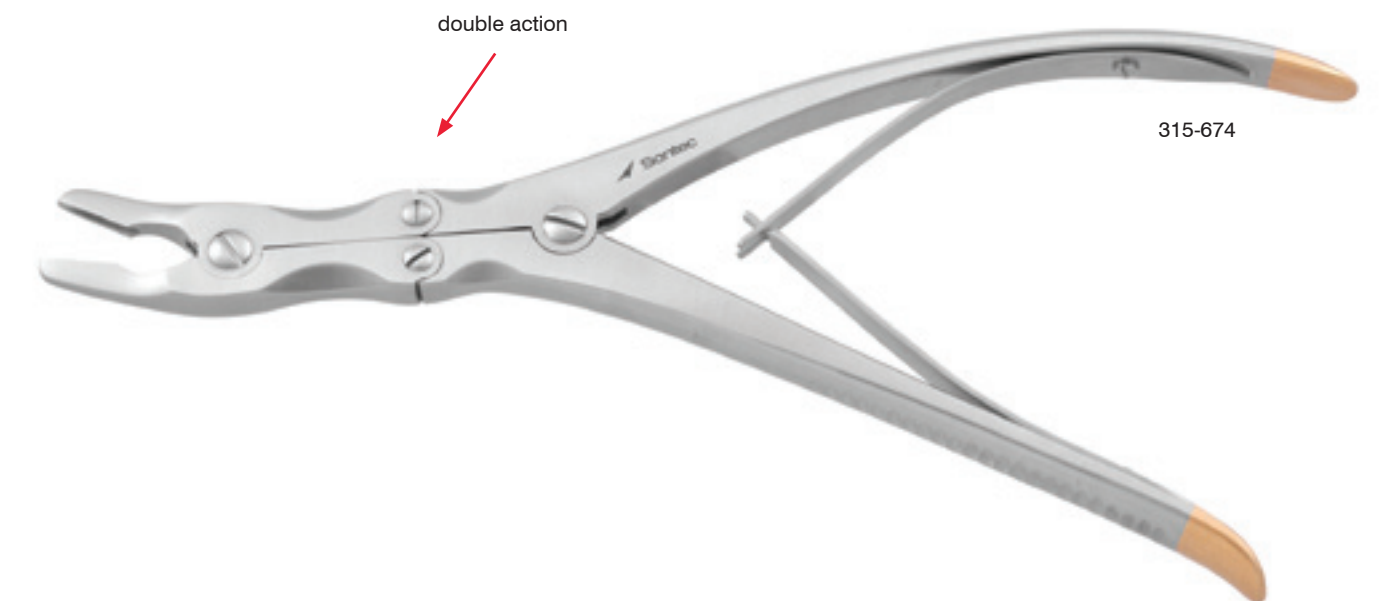
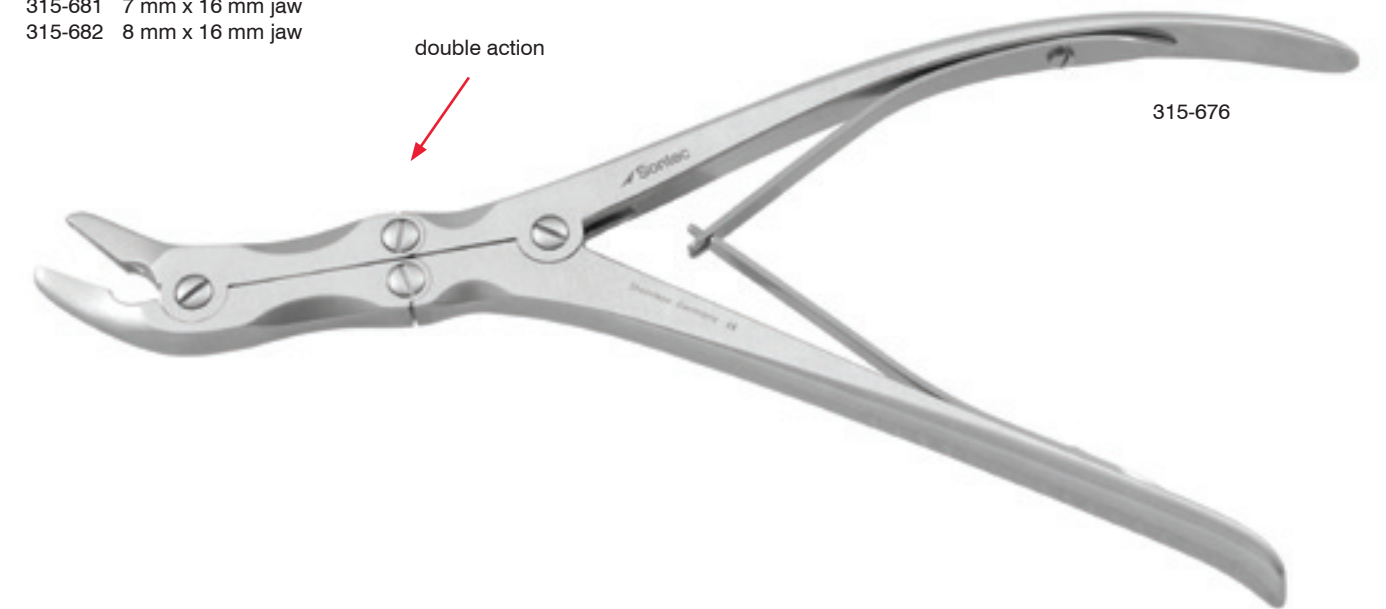

**Marquardt Neuro Rongeur**

Unique delicate shape / curved / double action / 2 mm jaw / 7 3/4" (19.7 cm)

315-697



315-697

**Leksell Bayonet Rongeur**

4 mm jaw / 8 3/4" (22 cm)

315-669 left  
315-670 right

4 mm jaw / ceramic coated / 8 3/4" (22 cm)

315-669B left  
315-670B right



315-670B

**Echlin Duckbill Rongeur**

Double action / curved to side / 9" (23 cm)

315-657 2 x 12mm bite  
315-659 3 x 12mm bite  
315-661 4 x 12mm bite

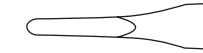

315-657



315-659



315-661

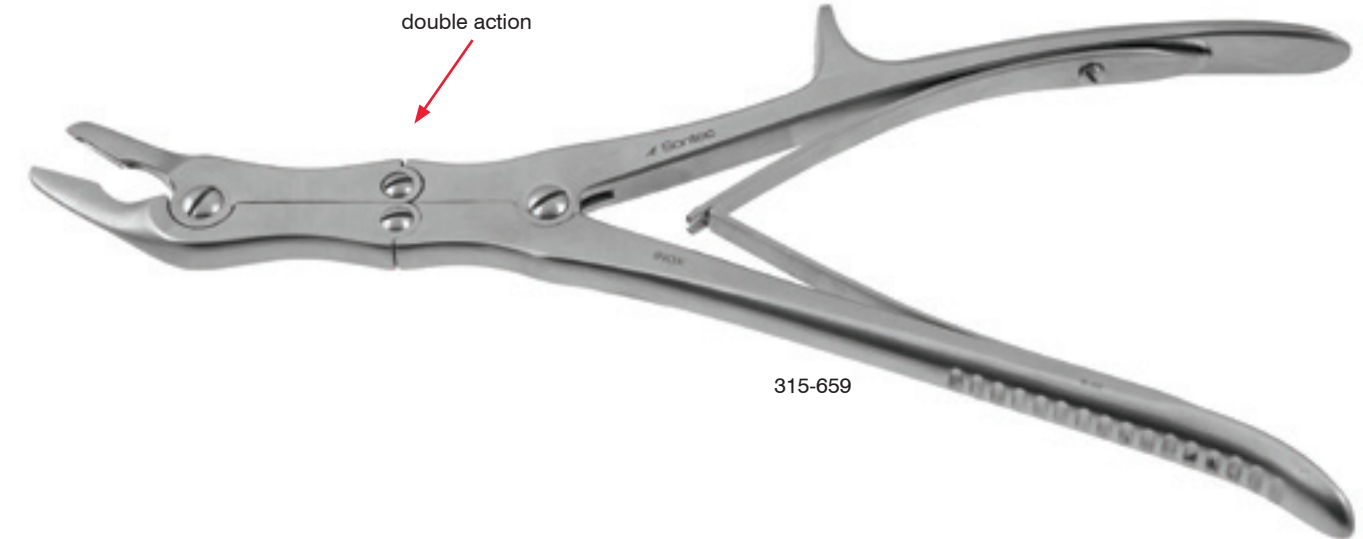

315-659



315-661

**Stille-Luer Rongeur**

**Double-action / 10 mm x 22 mm jaw**

- 315-640 str 8 3/4" (22.2 cm)
- 315-642 cvd 8 3/4" (22.2 cm)
- 315-646 str 10 1/2" (26 cm)
- 315-648 cvd 10 1/2" (26 cm)

**Double-action / 10 mm x 16 mm jaw  
/ curved to the side**

- 315-653 8 3/4" (22.2 cm)

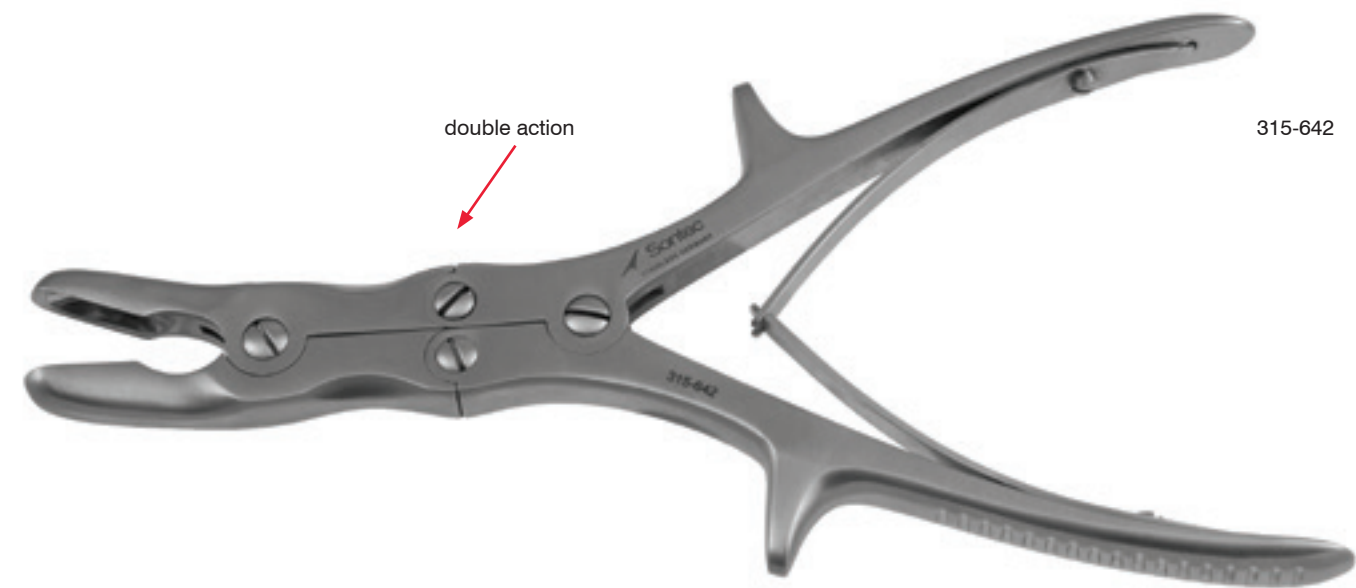
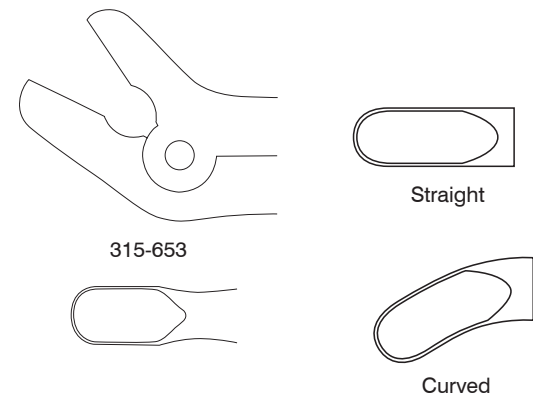

**Stille-Luer Rongeur**

**Double-action / 17 mm x 22 mm jaw  
/ 8 1/2" (21.6 cm)**

- 315-649 str
- 315-650 cvd

**Double-action / 17 mm x 25 mm jaw  
/ 10 1/2" (26.7 cm)**

- 315-651 str
- 315-6512 cvd



315-649

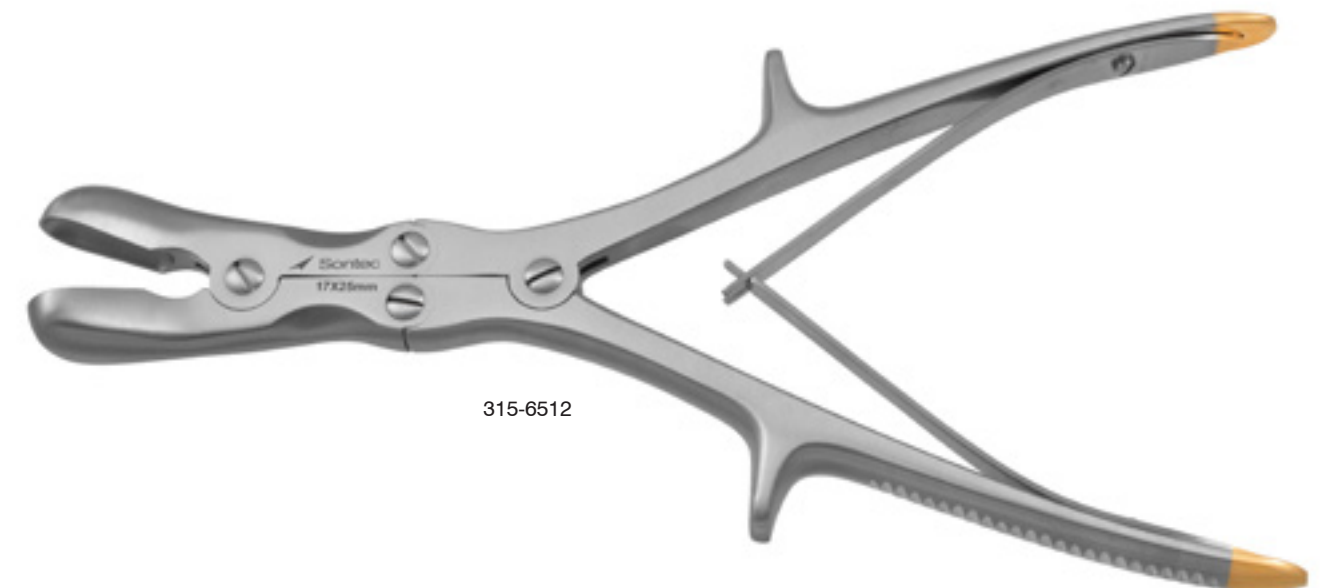

315-6512

**Stille-Luer Duckbill Rongeur**

Double-action / curved to side / 6 x 16 mm bite / 9" (22.9 cm)

315-652 standard  
315-652B black coated

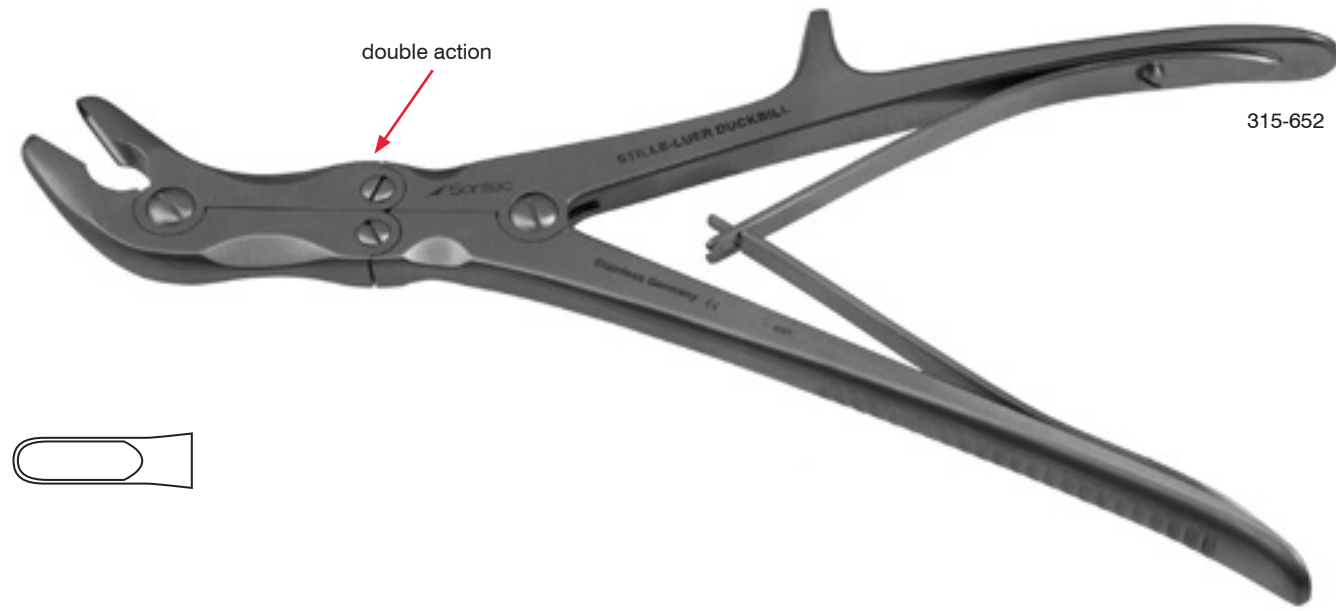

315-652

**Semb Bone Rongeur**

17 mm x 14 mm bite / 9" (22.9 cm)

315-639



315-639

**Stille-Luer Echlin Duckbill Rongeur**

Double action / curved to side / 6 x 15mm bite / 9" (23 cm)  
315-664

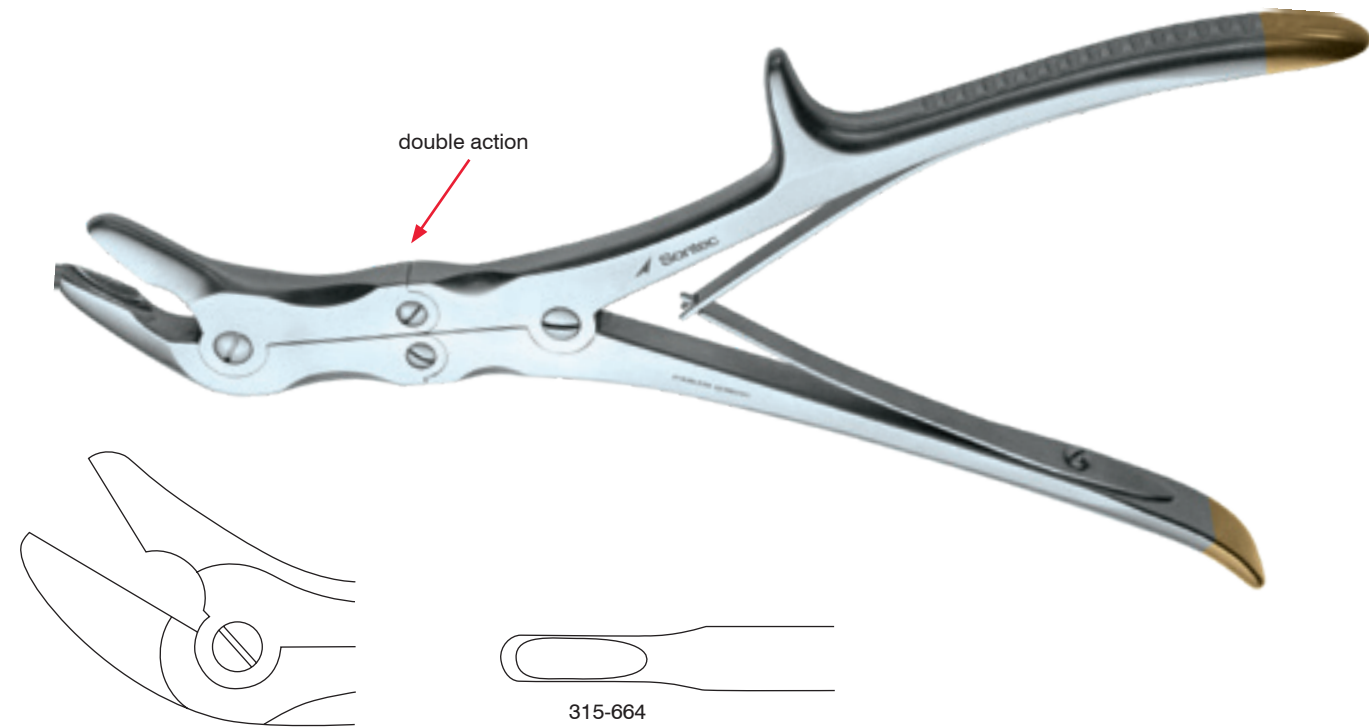

**Stille-Luer Echlin Duckbill Bayonet Rongeur**

Double angle jaw / 5 mm / right / 9" (23 cm)  
315-655



**Leksell Extended Bone Rongeur**

Light curve / 5 mm jaw / 15 3/4" (40 cm)  
1100-549



**Sypert Extended Rongeur**

Curved only / 14" (35.5 cm)  
1100-557B 4 x 16mm bite  
1100-557 5 x 16mm bite  
1100-557C 8 x 16mm bite  
1100-557D 12 x 16mm bite

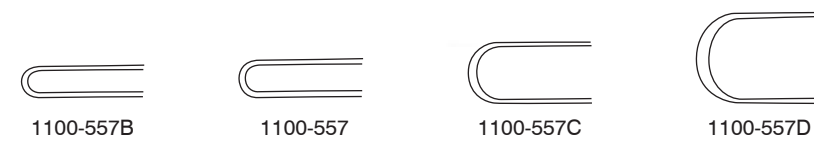



 Sontec Instruments®

Orthopedic SINGLE ACTION RONGEURS

**Mini Neuro Rongeur**

5 1/2" (14 cm)

- 1106-080 str 0.75 mm jaw
- 1106-082 cvd 0.75 mm jaw
- 1106-084 str 1.0 mm jaw
- 1106-086 cvd 1.0 mm jaw
- 1100-577S str 1.3 mm jaw
- 1100-577 cvd 1.3 mm jaw



1100-576

1.4 mm jaw / 6" (15 cm)

- 1100-574 str
- 1100-576 cvd

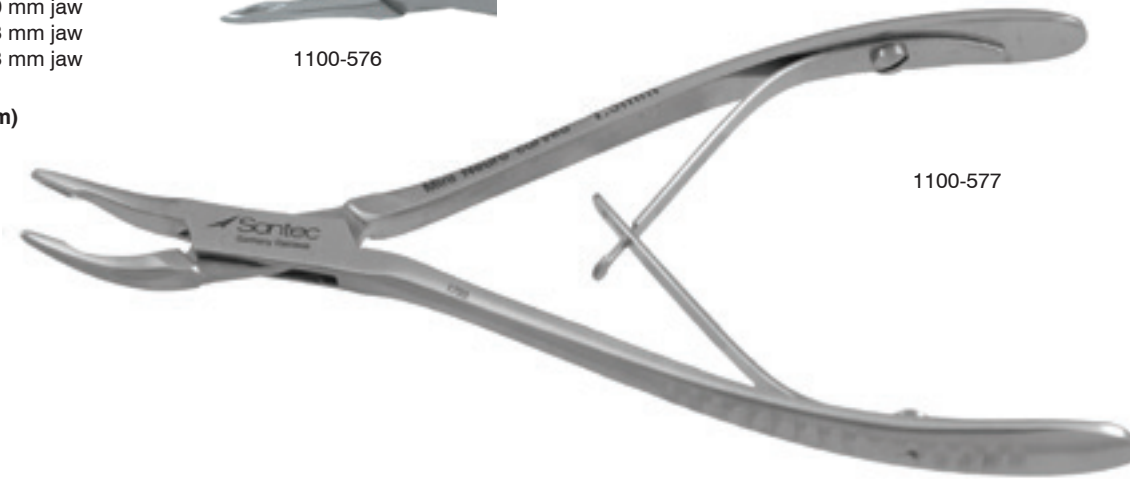

1100-577

**Mini Neuro Premier Rongeur**

0.5 mm tip / 5 1/2" (14 cm)

- 1106-091 str
- 1106-092 cvd



1106-091



1106-092

**Micro Friedman Ring Handle Rongeur**

5 1/2" (14 cm)

- 1106-076 1.3 mm straight
- 1106-077 1.3 mm curved
- 1106-078 1.3 mm full curved
- 1106-079 2.0 mm curved
- 1106-0791 2.0 mm full curved



1106-077



1106-078



1106-079



1106-0791

**Kleinert-Kutz Rongeur**

2 mm x 6 mm jaw / 5 1/4" (13 cm)

- 315-581 slight curve
- 315-580 full curve



315-581



315-581



315-580

**Micro Friedman Rongeur**

1.5 mm x 5 mm jaw / 5 1/2" (14 cm)

- 315-505S str
- 315-505C 30° angle
- 315-505 90° angle



**Mini Friedman Rongeur**

2 mm x 8 mm jaw / 5 1/2" (14 cm)

- 1106-070 str
- 1106-075 cvd



**Shearer Chickenbill Rongeur**

Curved / 3 mm x 12 mm jaw

- 315-511 5 1/2" (14 cm)
- 315-513 6 1/2" (16.5 cm)
- 315-515 7" (18 cm)



**Hakansson Rongeur**

2.5 mm x 12 mm jaw / curved / 6 1/4" (16cm)

- 1103-230



**Stellbrink Rongeur**

2 mm x 8 mm jaw / 6 1/2" (16.5 cm)

- 315-566 slight curve
- 315-567 full curve



**Classic Lempert Rongeur**

2.5 mm x 10 mm jaw

- 315-542 straight 6 1/4" (16 cm)
- 315-544 curved 6 1/4" (16 cm)
- 315-548 straight 7 1/2" (19 cm)
- 315-550 curved 7 1/2" (19 cm)



\* Additional Rongeurs available. Please call for styles, sizes & details



**Sontec Lempert Rongeur**

2.5 mm jaw / 6 1/2" (16.6 cm)

- 1100-542 straight
- 1100-544 curved



**Jeurs Lempert Neuro Rongeur**

Curved to side / 2.5 mm jaw / 7 1/2" (19 cm)

1100-578

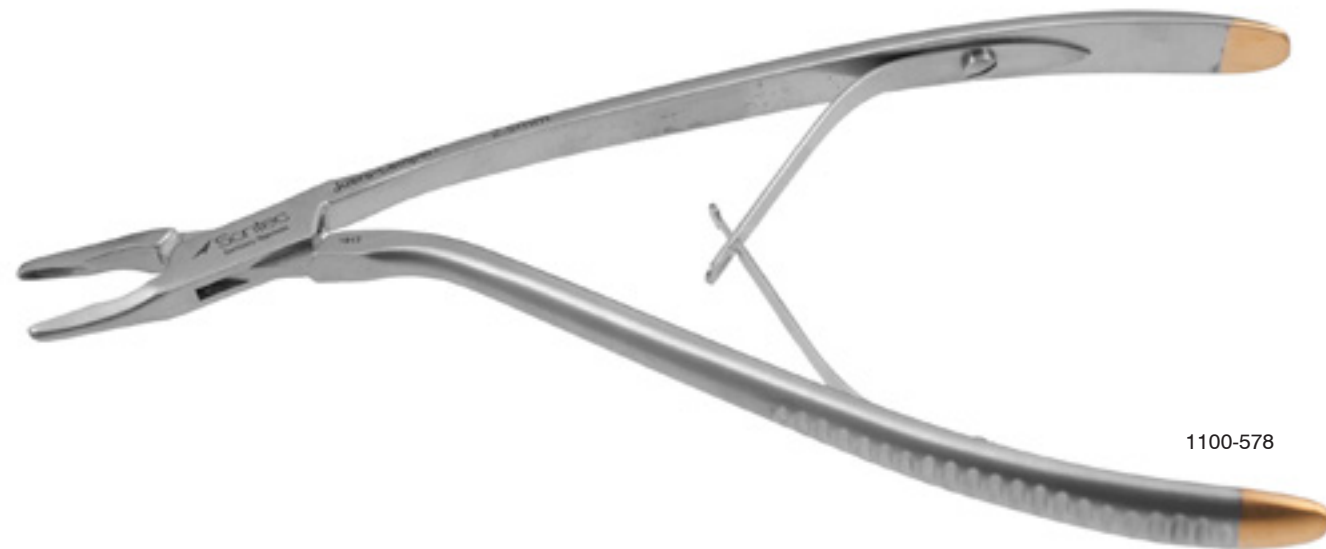

1100-578

**Levesque Neuro Rongeur**

Curved to side / low profile / extra delicate / 1.3 mm jaw / 7 1/2" (19 cm)

1100-578A

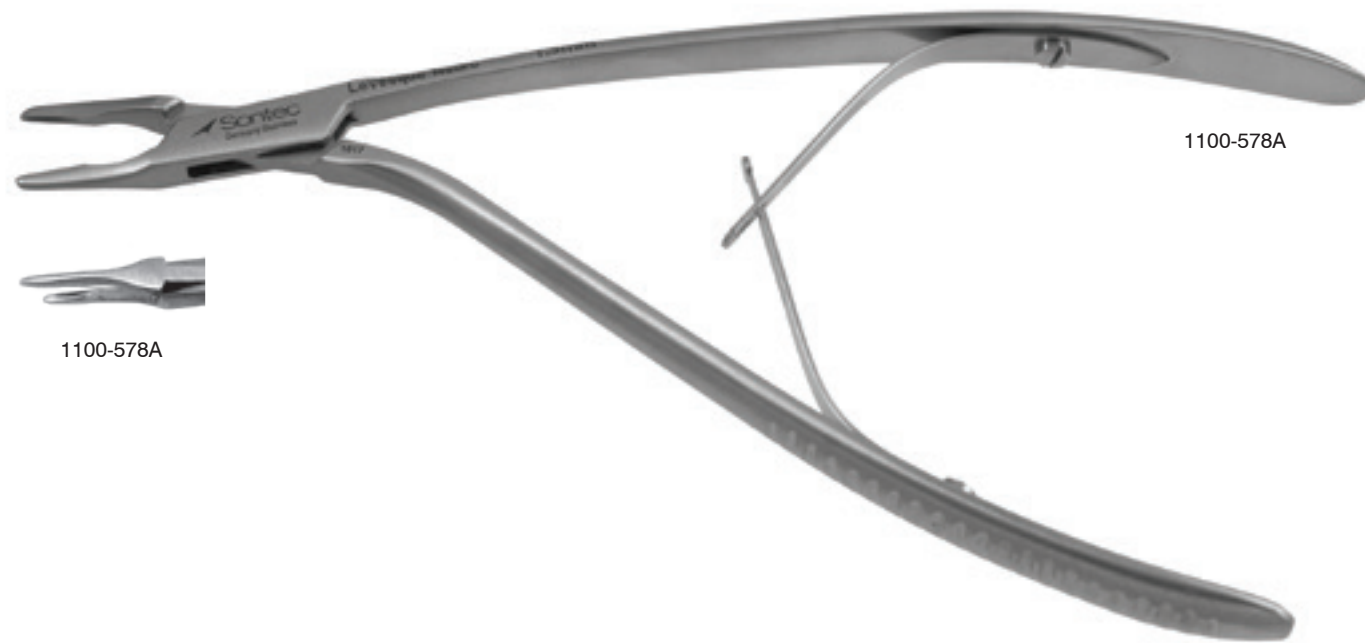

1100-578A

1100-578A

**Cicherelli Rongeur**

3 mm x 12 mm jaw / full curve / 6 1/2" (16.5 cm)

315-559



315-559

**Cleveland Rongeur**

Curved

315-526 5 1/2" (14 cm)

315-527 6 3/4" (17cm)



315-527

**Bane Single Action Rongeur**

Curved / 7" (17.8 cm)

315-538 small 4 mm bite  
315-540 large 5 mm bite



315-540

**Blumenthal Rongeur**

Tapered jaw / delicate / 4 1/2" (11.5 cm)

315-500M 30° angle  
315-501M 45° angle

Curved / 2.5 mm x 10 mm jaw / 6" (15 cm)

315-500 30° angle  
315-501 45° angle

Curved / 2.5 mm x 10 mm jaw / 7" (15 cm)

315-499 30° angle



315-501M

**Mead Rongeur**

Curved / 4 mm x 15 mm jaw  
/ 6 1/2" (16.5 cm)

315-495



315-495

**Olivecrona Rongeur**

3 mm x 18 mm jaw / curved / 8" (20.3cm)

315-630



315-630

**Defourmental Rongeur**

Straight / 7" (18 cm)

315-524



315-524

**Bacon Duckbill Rongeur**

Single-action / curved to side / 4.5 mm x 14 mm jaw / 8" (20 cm)

315-569



315-569



**Hartman Rongeur**

4.5 mm x 12 mm jaw / 5 3/4" (14.5 cm)

- 315-530 str
- 315-532 half curve
- 315-534 full curve



315-530



315-532



315-534



315-530



315-534

**Cushing Rongeur**

6 mm x 14 mm jaw / 8" (20.5 cm)

- 315-574 straight
- 315-576 curved

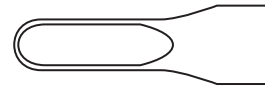

315-574



315-576

Serrated jaw / 6 mm x 14 mm jaw / 8" (20.5 cm)

- 315-572 straight
- 315-573 curved



315-574



315-572

**Adson Rongeur**

7 mm x 15 mm bite / 8" (20 cm)

- 315-564 straight
- 315-565 curved to side



315-565



315-564





 Sontec Instruments®

RASPS

**Double-Ended Rasp**

Single-sided / 7" (18 cm)

1103-224



**Sontec® Fomon Rasp**

Double-ended / four-sided / 8 1/2" (21.5 cm)

- 1100-492 straight
- 1100-492A straight fine
- 1100-492B one end concave
- 1100-492C one end convex

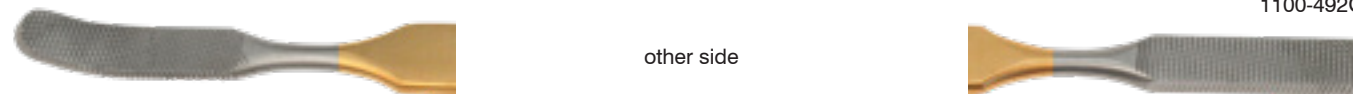
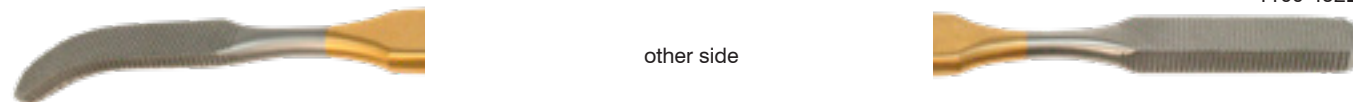

**Fomon Rasp**

Double ended / single-sided / 8 1/2" (21.5 cm)

- 1100-492F straight
- 1100-492G one side concave
- 1100-492D one side convex



**Foman TC Insert Rasp**

TC / double-ended / single-sided / 8 1/2" (21.5 cm)

- 345-289 9 / 10
- 345-287 7 / 8
- 345-285 5 / 6
- 345-283 3 / 4
- 345-282 2 / 3
- 345-281 1 / 2

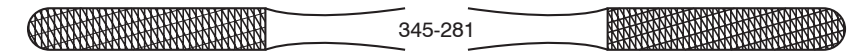
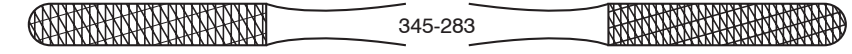
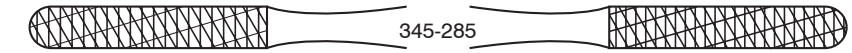
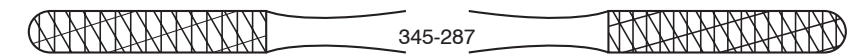
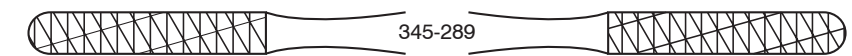

**Foman TC Insert Rasp Angled**

TC / double ended / single sided / angled

- 345-281A 1 / 2
- 345-283A 3 / 4
- 345-285A 5 / 6
- 345-287A 7 / 8
- 345-289A 9 / 10



345-281A



345-283A



345-285A



345-287A



345-289A

**Foman Rasp**

Serrated / double ended / single sided / 8" (20.3 cm)

- 345-290 1 / 2
- 345-291 3 / 4
- 345-292 5 / 6
- 345-293 7 / 8
- 345-294 9 / 10



345-290



345-291



345-292



345-293



345-294

**Foman Rasp**

TC serrated / single ended / 9" (22.9 cm)

- 345-2951 #1
- 345-2952 #2
- 345-2953 #3
- 345-2954 #4
- 345-2955 #5
- 345-2956 #6
- 345-2957 #7
- 345-2958 #8
- 345-2959 #9
- 345-2950 #10



345-2951



345-2951 345-2952 345-2953 345-2954 345-2955 345-2956 345-2957 345-2958

**Foman "R" Rasp**

Double ended / TC / 8  
1/4" (21 cm)  
345-279



**Polokoff Bone Rasp Double-Ended Single-Sided**

1103-241 5.5 mm / 6 mm 8"  
1103-242 3 mm / 4 mm 7 1/2"



**Howard Bone Rasp Double-Ended Single-Side**

7 1/8"  
1103-223 #12  
1103-225 #12A  
1103-226 #12CA



**Miller Bone Rasp Double-Ended Single-Sided Serrated**

7"  
345-241 5 mm / 6 mm #33  
345-242 3 mm / 4 mm #64  
1103-233 6 mm / 7 mm #10

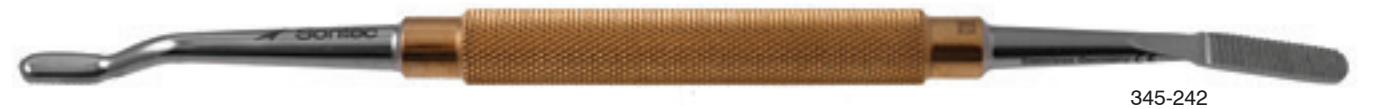

**Miller Bone Rasp Double-Ended Single-Sided**

7 1/2"  
1103-229 6 mm / 7 mm #45



**Miller Rasp**

Concave / single  
ended / TC / 8"  
(20.25 cm)  
345-305



**Sontec-Miller TC Insert Rasp**

Double-ended / TC / 7 1/8" (18.25 cm)  
345-300 serrated  
345-302 cross-serrated



**Miller Cross Serrated Rasp**

Double-ended / cross-serrated / up & down rasping / 7 1/8" (18.25 cm)

- 1103-232 4 mm & 4 mm wide
- 1100-490C 5 mm & 6 mm wide
- 1103-225C 5 mm & 7 mm wide
- 1100-491 6 mm & 7 mm wide

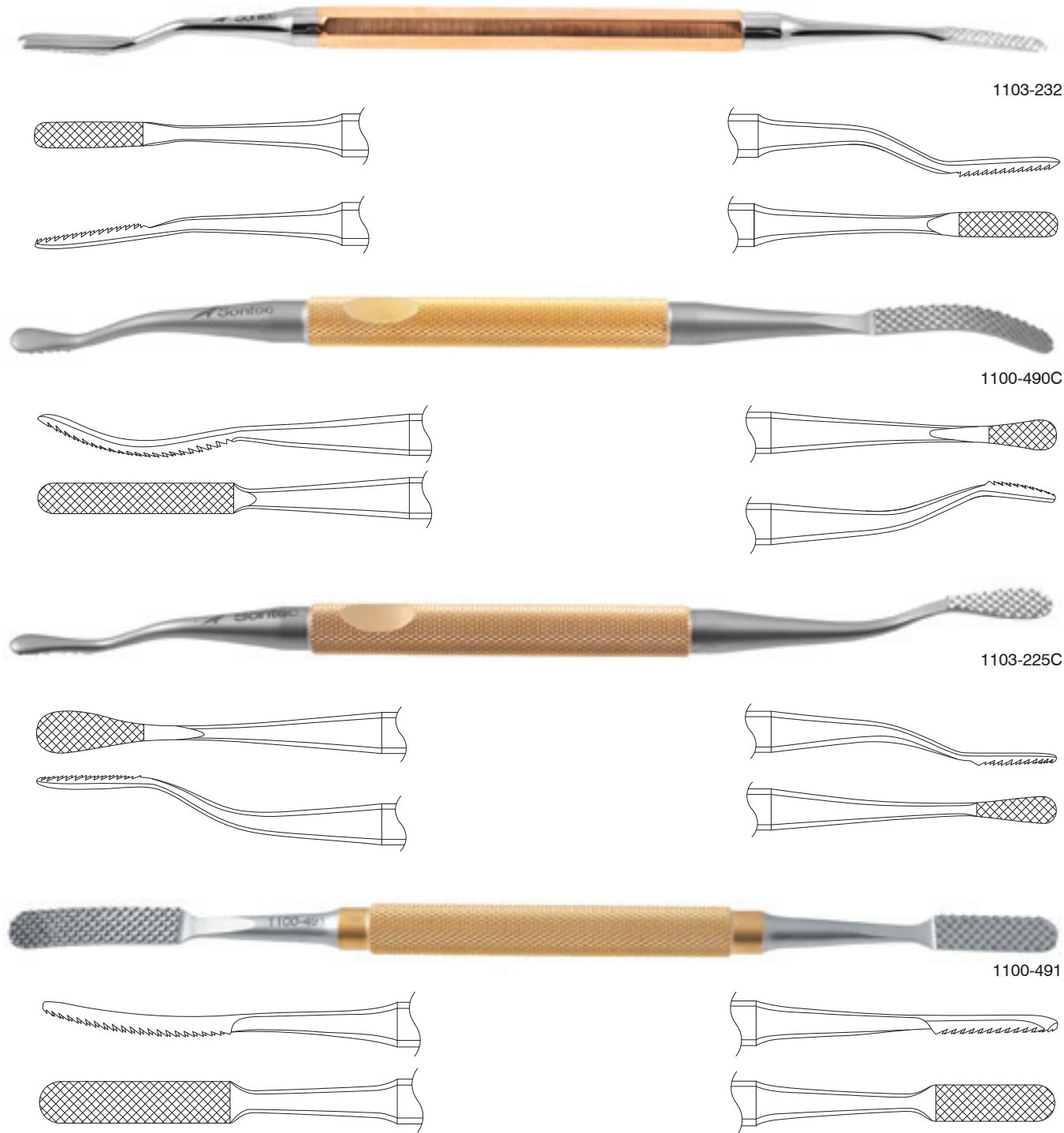

**Miller Parallel Serrated Rasp**

Double-ended / regular cut / down rasping / 7 1/8" (18.25 cm)

- 1103-228 4 mm & 4 mm wide
- 1100-490 5 mm & 5 mm wide
- 1103-238 5 mm & 7 mm wide
- 1103-236 5 mm & 8 mm wide
- 1103-237 6 mm & 7 mm wide

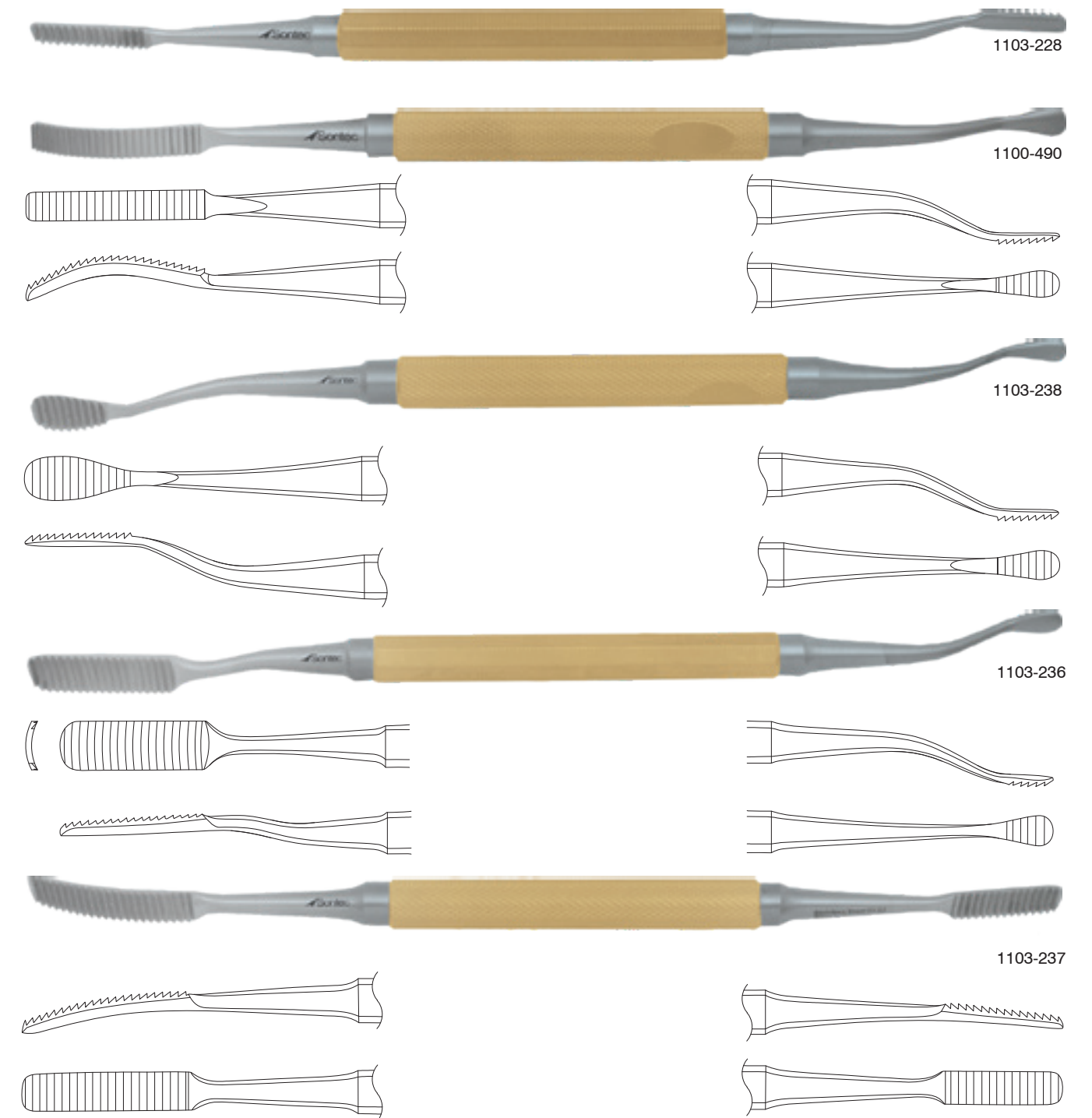

**Sontec Micro Rasp**

Single-ended / double-sided / 5 1/2" (14 cm)

- 345-265 straight 2.1 mm x 30 mm x 1 mm
- 345-264 curved 3.2 mm x 30 mm x 2.5 mm

Single-ended / single-sided / special order

- 345-266 5 1/2" (14 cm) 3 mm x 30 mm x 2.0 mm
- 345-267 7" (18 cm) 3 mm x 30 mm x 2.0 mm



345-265



345-264



345-266

**Nail Rasp**

Single-sided / 6 3/4" (17 cm)

- 345-243



345-243

**Maltz Single-Ended Rasp**

Single-sided / 7" (18 cm)

- 345-310 reverse
- 345-311 forward cut

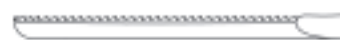

345-310 (reverse)



345-311 (forward cut)



345-310



345-311

**Rhinoplasty Rasp**

Straight / 7 3/4" (20 cm)

- 345-312 teeth down
- 345-314 teeth up



345-312



345-314

**Maltz Improved Double Ended Rasp**

Single-sided / up & down rasping / 8 1/4" (21 cm)

- 1103-235



1103-235

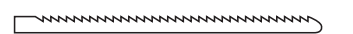
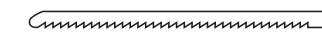

**McCollough Twist Fomon Raspatory**

Double-Ended-Single-Ended / TC / 8 1/2" (21.6 cm)

- 345-350 #2/3
- 345-352 #4/6



345-352

**Putti Bone Rasp**

- 345-220 leaflet / leaflet 10 1/2" (26.7 cm)
- 345-218 conical / leaflet 12" (30.5 cm)



345-218

**Putti Bone Rasp**

Round blade / T-handle / 12" (30.5 cm)

345-224



345-224

**Putti Bone Rasp**

Single-ended / phenolic handle

345-226 leaflet 9 3/4" (24.8 cm)

345-228 conical 10" (25.4 cm)



345-226



345-228

**Single Side Rasp**

8" / phenolic handle / flat

345-222 straight 0.5" x 1.5" tip



345-222

**Combination Bone Rasp**

With 3 interchangeable heads

1100-485-SET

set includes the following:

- 1100-485 combination bone rasp handle only
- 1100-4851 combination bone rasp round tip only
- 1100-4852 combination bone rasp putti leaflet only
- 1100-4853 combination bone rasp flat round tip only



1100-485



1100-4851

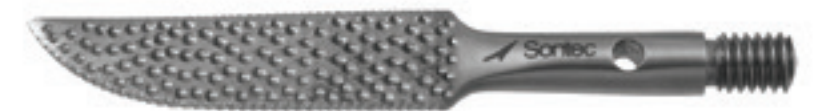

1100-4852



1100-4853

**Gallaher Bone Rasp Set**

7 1/8" (18.25 cm)

- 77-0450 str
- 77-0451 convex curve
- 77-0452 concave curve

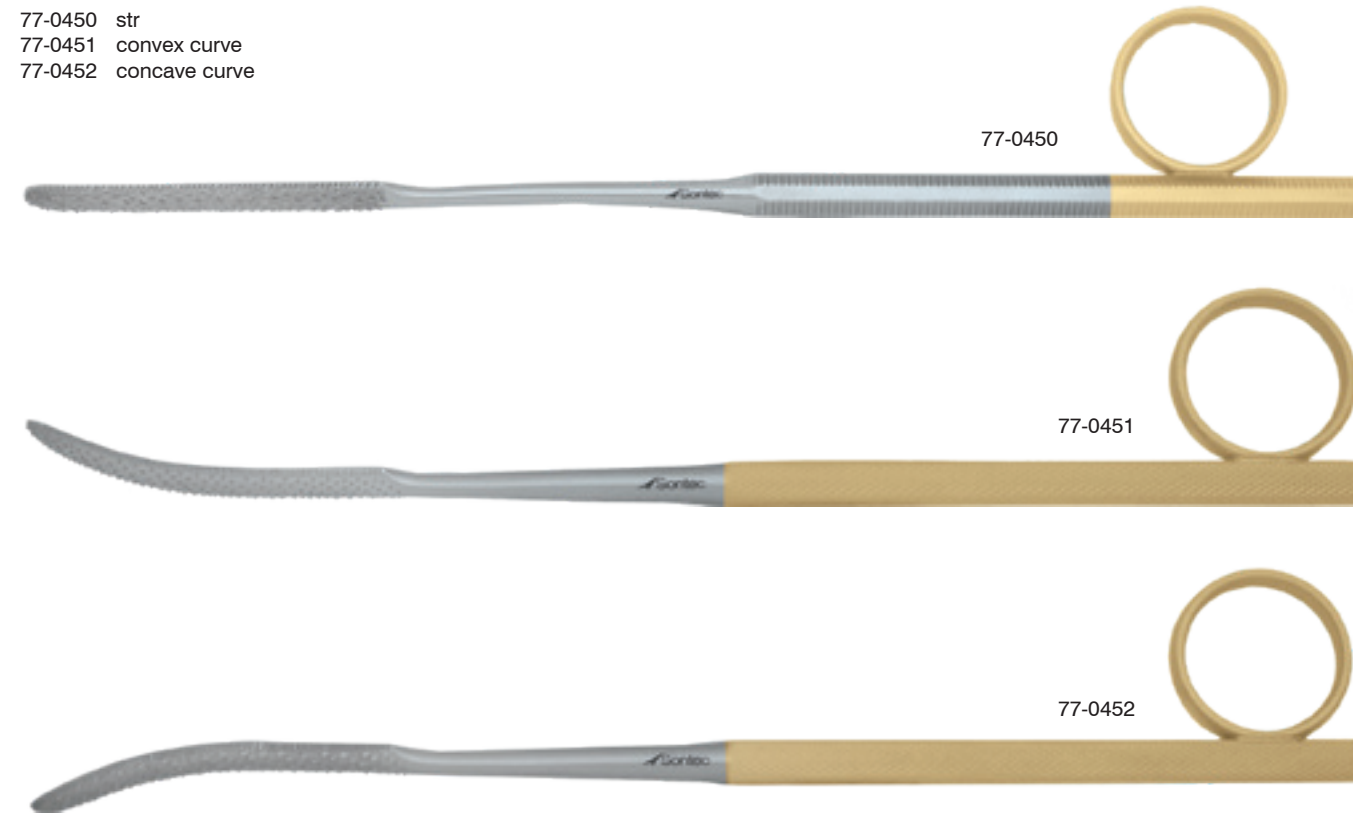

**Good Bone Rasp**

Conical / 6 1/2" (16.5 cm)

- 345-263 straight
- 345-262 curved

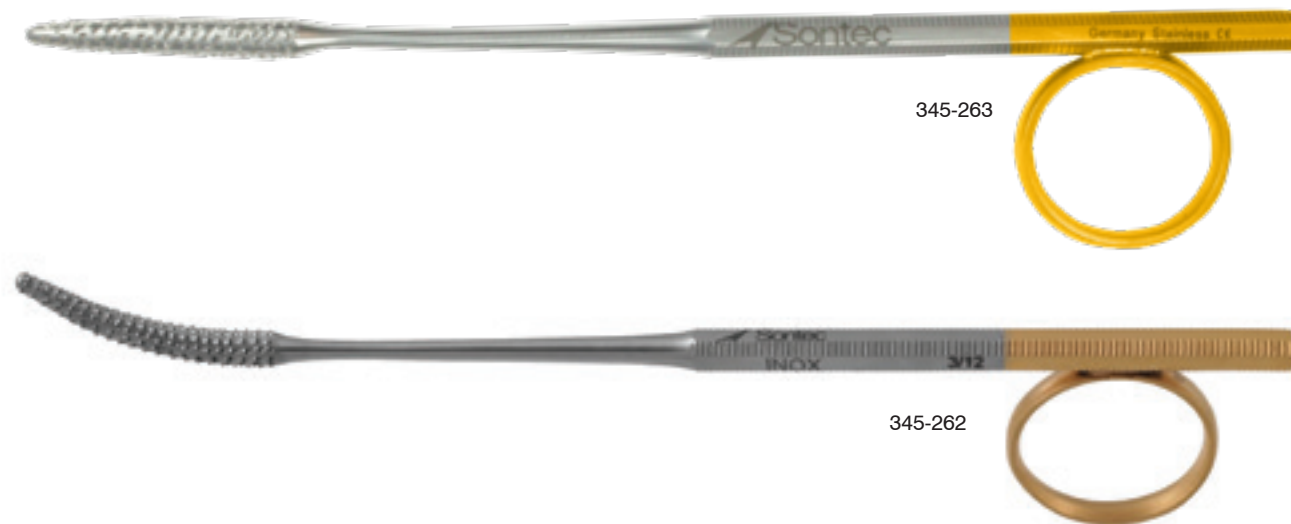

**Sontec Ear Rasp Set**

Serrated / 6" (15.2 cm)

- 475-596 curved left
- 475-598 curved right

7 1/4" (18.5 cm)

- 475-610 curved right
- 475-605 curved right serrated
- 475-600 curved left serrated
- 475-615 set of all three

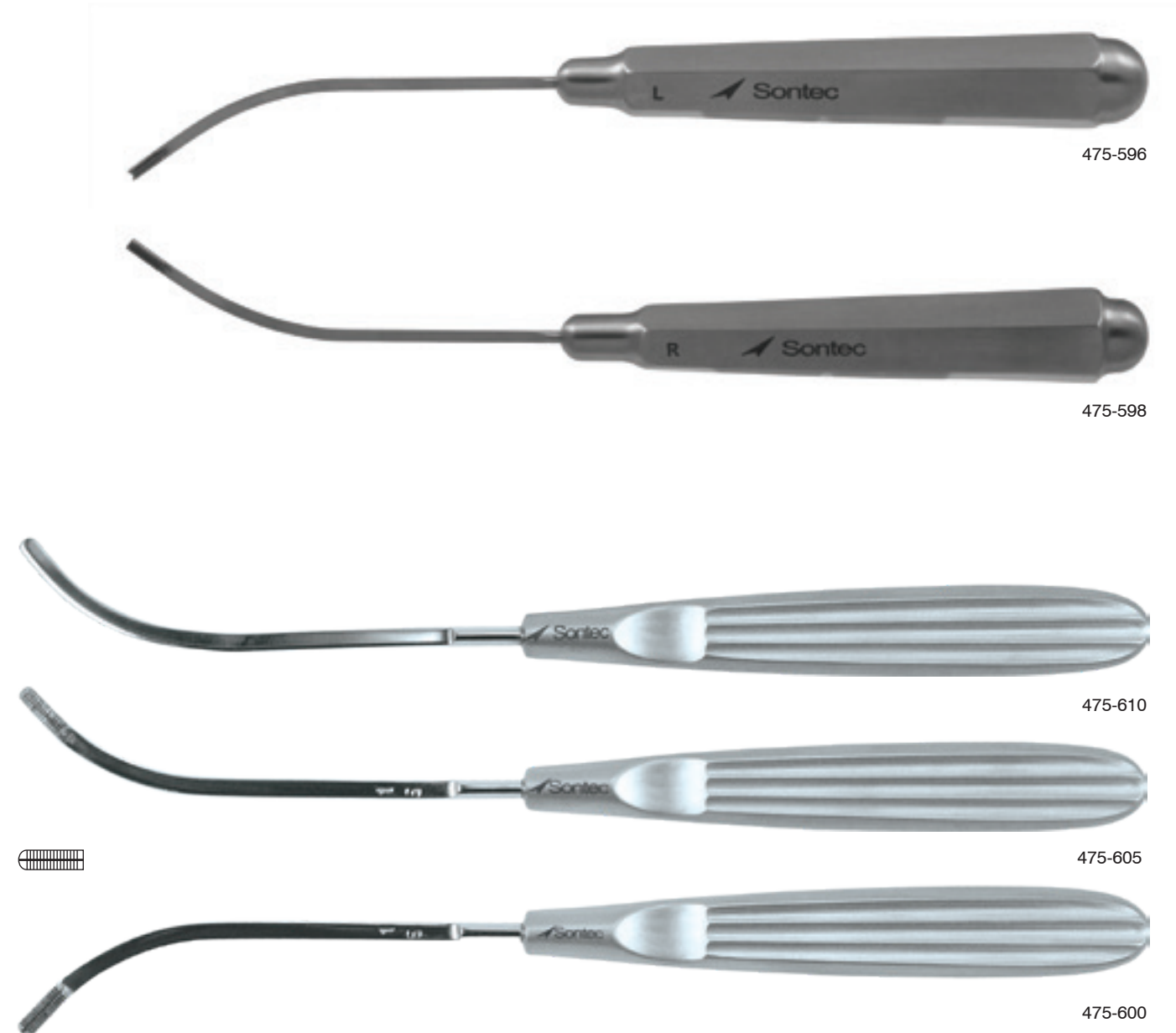

**Kistler Ear Cartilage Rasp**

Curved / 6 1/2" (16.5 cm)

475-618L left  
475-618R right



475-618L



475-618R

**Glabella Masing Rasp**

TC / 7 3/4" (19.5 cm)

345-340



345-340

**Sontec Glabella Pull Push Curved Tip Rasp**

Single-ended / curved / 7 1/2" (19 cm)

345-342 teeth cut down pull  
345-344 teeth cut up push



345-342



345-344

**Sontec Patella Raspatory**

#4 / TC insert / 7 1/8" (18 cm)

345-247



345-247

**Masing Rasp**

Single ended / straight  
/ TC / 7 3/4" (19.5 cm)

345-289R course  
345-338 fine



345-289R



345-338

**Sontec Diamond Surface Rasp**

7 3/8" (18 cm)

345-345 straight  
345-346 curved



345-345



345-346

**Obwegeser Fenestrated Serrations Rasp**

Double-ended / flat, straight / infinity cut / 7 1/2" (19 cm)

345-320 fine grit  
345-322 medium grit



345-322

Double-ended / flat, curved / infinity cut / 7 1/2" (19 cm)

345-324 fine grit  
345-326 medium grit



345-326

Double-ended / concave / infinity cut / 7 1/2" (19 cm)

345-330 fine grit  
345-332 medium grit



345-332

**Sontec®-Glabella Sculpting TC Insert Rasp**

TC / 7" (18 cm)

345-246



345-246

**Webster Glabella Sculpting Rasp**

TC serrated tip / 4 mm x 8 mm / 8 1/4" (21 cm)

345-246A



345-246A

**Obwegeser Solid Fine Grit Nasal Rasp**

Double-ended / 7 1/2" (19 cm)

345-320S straight  
345-324S curved



345-320S



345-324S

**Sontec Spinal File/Rasp**

Phenolic handle / TC / 10" (25.4 cm)  
/ curved

345-270



345-270

Phenolic handle / cross-serrated /  
straight / 6.5 mm / 15" (38 cm)

345-216



345-216

Black plastic handle / 6 mm

345-216B straight 15" (38.1 cm)

345-215B angled 14 1/2" (36.8 cm)



345-216B



345-215B

**Long Handle File**

Black plastic handle /  
square file / 18" (45.7 cm)

320-591 straight

320-592 15° angle

Black plastic handle / round  
file / straight / 18" (45.7 cm)

320-593



320-591



320-593



320-592

**JPS Bone File**

8 3/4" (22.2 cm)

345-217



back



front

345-217



 Sontec Instruments®

Headlights & Cameras

**Sontec Elite Wireless LED Headlight**

Includes: 2 batteries, sterilizable lever, universal transformer with adapters, lightweight carrying case, wireless LED headlight and operator manual

100-5500 LED 5500 30,000 lux output at 16" / 40 cm distance



**Sontec Elite Wireless LED Headlight**

Includes: 2 batteries, sterilizable lever, universal transformer with adapters, lightweight carrying case, wireless LED headlight and operator manual

100-9500 LED 9500 70,000 lux output at 16" / 40 cm distance



### Sontec LED Plus+ Headlight

Up to 4.25 hours of runtime per battery / 10 - 100 mm @ 400 mm working distance of sport control / > 40,000 lux @ 30 cm of illumination / > 50,000 hours of LED Life / 3.6 hours for normal recharge time / 2 hours of quick recharge time for 3 hours of maximum intensity

Warranty  
2 years on LED Headlight  
1 year on Battery Pack  
SIL-2410



### Sontec Magnum LED Headlight

12 oz./350 grams of battery and holster weight / 10 oz./300 grams of headlamp weight / 3 intensity levels of 30k lux, 50k lux & 70k lux, all @ 12"/30 cm / 75k lux of light output @ 12" / 2 hours, for 8 hours of maximum intensity for quick recharge time / 7 hours of continuous operation at Hi intensity for operating time / headband is lightweight comfortable with washable foam inserts

Warranty  
2 years on LED Headlight  
1 year on Battery Pack  
SIL-2399



## Sontec proCam 4K Micro Camera System

4k UHD, 30 fps video resolution / 8/13 mpx resolution still / 32 x 28 x 23 mm size without lens / 23 grams body weight ONLY / 3x built-in zoom / UHD video, high resolution, documentation for strength / USB 2 connection / standard 16 mm, Hi magnification 25 mm UHD, wide angle 12 mm and 8 mm lenses / compatible with Windows, Mac and Android

SIL-2480

\*headlight sold separately



## Index

T136-688	134	16-2106	690	100-5500	778
9-15-450-02-SET	460	16-2107	690	100-9500	779
9-15-452-02	460	16-2760	139	103-109	32
9-15-452-08	460	18-3120	15	103-110	32
9-15-452-12	460	18-3121	15	103-111	32
9-15-452-20	460	18-3122	15	103-115	33
9-15-460-02-SET	460	18-3123	15	103-117	33
9-15-462-02	460	18-3209	23	103-119	33
9-15-462-07	460	18-3213	21	105-540	37
9-15-462-08	460	18-3214	21	105-541	37
9-15-462-09	460	18-3215	21	105-542	37
9-15-462-12	460	18-3270	23	105-543	37
9-15-462-13	460	18-3505	10	105-544	37
9-15-462-14	460	18-3510	10	105-550	37
9-15-462-15	460	18-3515	10	105-551	37
9-15-462-16	460	18-3519	10	105-552	37
9-15-462-17	460	18-3520	11	105-553	37
9-15-462-18	460	18-3525	11	105-570	37
9-15-462-19	460	18-3530	11	105-571	37
9-15-462-20	460	18-3560	14	105-572	37
9-15-462-21	460	18-3562	693	105-573	37
9-15-462-22	460	18-3564	16, 668	105-574	37
9-15-462-23	460	18-8301	56	105-575	37
9-15-462-24	460	19-1801	48	105-576	37
9-15-462-26	460	20-0847	236	105-577	37
9-15-462-27	460	20-0848	236	105-578	37
9-15-462-28	460	20-0871	236	105-579	37
12-9200	52	20-0874	236	105-580	37
12-9300	52	48-0339	479	105-581	37
12-9300D	52	48-0340	479	105-590	37
12-9305	52	52-1301	486	105-600	37
12-9310	52	53-0510	712	105-602	37
12-9310D	52	53-0512	712	105-610	37
12-9315	52	53-0514	712	105-612	37
12-9316	52	53-0516	712	105-614	37
12-9318	52	53-0518	712	105-616	37
12-9320	53	53-0520	712	105-618	37
12-9325	53	53-0522	712	105-620	37
12-9330	53	53-0524	712	105-622	37
12-9335	53	53-0526	712	105-624	37
12-9340	55	53-0528	712	105-626	37
12-9400	54	53-0530	712	105-628	37
12-9425	54	53-0532	712	105-630	37
12-9450	54	53-0534	712	105-632	37
12-9500	57	53-0536	712	105-640	37
12-9600	55	53-0538	712	105-642	37
12-9630	55	53-0542	712	105-644	37
14-6560	136	53-0544	712	105-646	37
14-6562	136	53-0546	712	105-650	37
14-6564	136	53-0552	712	105-652	37
16-2096	691	53-0554	712	105-654	37
16-2096B	691	53-0556	712	105-656	37
16-2097	691	53-0560	712	105-660	37
16-2097B	691	53-0562	712	105-662	37
16-2098	691	53-0564	712	105-664	37
16-2098B	691	53-0566	712	105-666	37
16-2099	691	53-0574	712	105-670	37
16-2100	690	53-0582	712	105-672	37
16-2101	690	53-0584	712	105-674	37
16-2101B	690	53-0590	712	105-676	37
16-2102	690	53-0592	712	105-686	37
16-2102B	690	53-0594	712	105-688	37
16-2103	690	77-0450	768	105-690	37
16-2104	690	77-0451	768	105-692	37
16-2105	690	77-0452	768	105-694	37

105-696	37	125-639	34	136-634	120
105-700	38	125-640	34	136-636	120
105-702	38	125-642	34	136-637	120
105-704	38	125-644	34	136-639	120
105-706	38	125-646	34	136-640	120
105-708	38	125-655	34	136-641	120
105-710	38	125-656	34	136-642	120
105-712	38	125-657	34	136-643	120
105-714	38	125-658	34	136-644	120
105-716	38	125-659	34	136-645	120
105-720	37	125-661	34	136-646	120
105-722	37	125-662	34	136-648	120
105-723	37	125-663	34	136-649	120
105-724	37	125-664	34	136-650	120
105-725	37	125-666	34	136-652	120
105-726	37	125-667	34	136-653	120
105-727	37	125-668	34	136-659	136
105-730	36	125-669	34	136-659D	136
105-732	36	125-670	34	136-660	131
105-734	36	125-671	34	136-660A	131
105-736	36	125-673	34	136-661	131
105-738	36	125-674	34	136-662	131
105-742	36	125-675	34	136-662T	131
105-744	36	125-676	34	136-663	131
105-746	36	127-226	35	136-664	133
105-748	36	127-227	35	136-664D	133
105-750	36	127-228	35	136-665	133
105-780	36	127-229	35	136-666	128
105-781	36	134-240	162	136-667	128
105-782	36	134-242	162	136-668	128
105-783	36	134-243	164	136-668A	129
105-784	36	134-245	164	136-669	128
105-785	36	134-247	165	136-671A	137
105-786	36	134-248	165	136-671B	137
105-787	36	134-267	164	136-671C	137
105-789	36	134-268	165	136-671D	137
105-790	36	134-276	162	136-672	128
105-791	36	134-277	164	136-674	129
105-791A	36	134-277M	164	136-674D	129
105-792	36	134-278	164	136-675	136
105-793	36	134-278M	164	136-676	128
105-794	36	134-280	164	136-677	136
105-796	36	134-280M	164	136-678	131
105-797	36	134-281	164	136-678L	131
105-798	36	134-281M	164	136-678P	136
105-799	36	134-282A	164	136-679	129
105-7951	36	134-282B	164	136-679S	131
117-555	49	136-578	123	136-680	126
117-559	46	136-580	123	136-682	128
117-560	45	136-590	124	136-682P	128
117-561	45	136-600	122	136-683	128
117-564	45	136-602	122	136-684	126
117-566	45	136-605	122	136-686	135
117-576A	47	136-607	122	136-686C	135
117-577	44	136-610	122	136-686D	135
117-578	44	136-612T	117	136-687	135
117-582	45	136-613	122	136-688	135
117-583	47	136-615	122	136-688S	135
117-585	48	136-616T	117	136-688T	134
117-588	48	136-617	122	136-689	135
117-593	48	136-619	122	136-690	109
117-594	49	136-621	120	136-691	109
117-602	49	136-624	120	136-692	109
117-5781	44	136-626	120	136-694	109
125-634	34	136-626F	120	136-695	109
125-635	34	136-629	120	136-697	135
125-636	34	136-632	120	136-698	135
125-637	34	136-632B	120	136-699	129
125-638	34	136-633	120	136-700	135

136-701	118	140-364	118	180-451	310
136-702	118	140-366	118	190-246	550
136-704	118	140-368	118	199-207	663
136-706	118	140-369	118	199-211	664
136-708	118	140-372	108	199-212	662
136-711	119	140-374	108	199-213	664
136-712	119	140-376	117	199-214	662
136-730	115	140-376B	118	199-216	662
136-732	115	140-378	117	199-218	661
136-735	115	140-379	117	199-220	658
136-737	115	140-382	119	199-221	658
136-738	115	140-389	106	199-222	658
136-740	115	140-500	123	199-223	658
136-742	115	140-502	123	199-240	659
136-746	115	140-504A	122	199-271	661
136-748	115	140-504B	122	199-272	661
136-766	109	140-505T	122	199-273	661
136-767	109	140-512	119	199-274	661
136-769	109	140-514	119	199-275	661
136-771	109	140-517	117	199-276	659
136-773	109	140-517G	117	199-277	659
136-775	109	140-517M	117	199-278	659
136-776	109	140-519	117	199-279	659
136-787	157	140-519G	117	199-280	659
136-798	158	140-519M	117	199-282	663
136-801T	501	140-3032	130	199-283	660
136-6508	120	140-3042	130	199-284	660
136-6601	131	140-3821	119	199-365	126
136-6621T	131	142-103	110	199-365S	126
136-6741	127	142-104	110	199-365T	126
136-6861	133	142-106	110	199-368	126
136-6891	135	142-107	110	205-849	468, 470
140-198	131	142-108	110	205-849B	468, 470
140-201	132	142-110	110	207-254	463
140-202	130	142-111	110	207-259	461
140-203	130	142-112	110	207-300	463
140-204	132	142-113	110	207-319-SET	472
140-205	132	142-114	110	207-321	472
140-207	130	142-199	362	207-323	472
140-220	157	180-403	295	207-326	469, 471
140-220B	158	180-404	295	207-328	469, 471
140-222B	158	180-404S	294	207-330	469, 471
140-273	115	180-405	295	207-333	469, 471
140-297	132, 133	180-405S	294	207-338	469, 471
140-297T	126	180-406	295	207-340	469, 471
140-298	132	180-406S	294	207-342	469, 471
140-298T	126	180-407	295	207-345	469, 471
140-299	132	180-407S	294	207-350	473
140-301	132	180-408	295	207-352	473
140-302	129	180-408S	294	207-354	473
140-302D	129	180-409	295	207-356	473
140-302F	129	180-409S	294	207-358	472
140-302T	127	180-410	295	207-360	472
140-303	130	180-410S	294	207-362	472
140-303F	129	180-411	295	207-364	472
140-304	130	180-411S	294	207-389	464
140-304F	130	180-412	295	207-390	464
140-304T	126	180-412S	294	207-391	464
140-305	130	180-420	312	207-405	478
140-305F	130	180-422	311	207-411	465
140-306	130	180-424	311	207-413	465
140-307	130	180-427	312	207-415	465
140-309	130	180-432	309	207-454	466
140-350	118	180-433	309	207-455	466
140-352	118	180-436	309	207-456	466
140-354	118	180-439	309	207-460	466
140-358	118	180-440	309	207-461	466
140-360	118	180-448	310	207-462	466
140-362	118	180-449	310	207-463	466

207-464	466	305-369A	321	315-614	724
207-465	466	305-370	335	315-616	724
207-466	466	305-370A	335	315-619	724
207-467	466	305-370B	335	315-620	726
207-468	466	305-380	332	315-621	724
207-469	466	305-460	333	315-622	725
207-470	466	305-465	333	315-630	749
207-471	466	305-470	333	315-639	735
207-472	466	305-475	333	315-640	732
207-473	466	305-480	333	315-642	732
207-474	466	305-485	333	315-646	732
207-482	465	305-496	334	315-648	732
207-484	465	305-497	334	315-649	733
207-486	465	305-910	163	315-650	733
207-488	465	310-160	462	315-651	733
207-490	465	310-171	475	315-652	734
214-052	467	310-173	475	315-652B	734
220-114	457	310-174	475	315-653	732
220-126	459	310-176	475	315-655	736
220-128	459	310-177	474	315-657	731
220-130	459	310-178	474	315-659	731
220-132	459	310-179	474	315-661	731
220-136	459	310-180	474	315-664	736
220-138	459	310-182	474	315-669	730
220-140	459	315-495	749	315-669B	730
220-220	458	315-505	742	315-670	730
220-222	458	315-505C	742	315-670B	730
220-224	458	315-505S	742	315-671	729
230-337	277	315-511	743	315-672	729
230-338	277	315-513	743	315-673	729
230-347	278	315-515	743	315-674	729
230-352	276	315-524	750	315-675	729
230-354	276	315-526	747	315-676	729
230-357	276	315-527	747	315-677	729
230-360	276	315-530	751	315-678	729
230-365	275	315-532	751	315-679	729
230-371	266	315-534	751	315-680	729
230-372	266	315-538	748	315-681	729
230-373	266	315-540	748	315-682	729
230-374	267	315-542	745	315-685	728
230-375	267	315-544	745	315-686	728
230-376	268	315-548	745	315-687	728
230-378	268	315-550	745	315-688	728
230-405	264	315-559	747	315-689	728
230-406N	265	315-564	753	315-690	728
230-406T	265	315-565	753	315-691	727
230-445	273	315-566	744	315-697	730
230-480	270	315-567	744	315-752	657
230-486	270	315-569	750	315-754	657
230-4901	273	315-572	752	315-756	657
240-695	523	315-573	752	315-760	660
240-700	523	315-574	752	315-762	657
303-490	333	315-576	752	315-765	656
303-495	333	315-580	741	315-766	656
305-328	323	315-581	741	315-767	656
305-332	323	315-585	724	315-768	656
305-334	323	315-586	724	315-775	656
305-336	323	315-587	724	315-776	656
305-338	323	315-588	724	315-777	656
305-344A	322	315-589	724	315-778	656
305-347	323	315-590	724	315-779	656
305-365	321	315-593	724	315-781	658
305-365M	321	315-595	725	315-6512	733
305-366	321	315-597	727	320-580	539
305-367	321	315-598	727	320-581	539
305-367S	321	315-599	727	320-582	539
305-368	321	315-600	726	320-583	539
305-368A	321	315-610	724	320-584	539
305-369	321	315-612	724	320-585	539

320-586	539	320-760	371	320-835	367
320-587	539	320-761	371	320-835T	369, 530
320-588	539	320-778	370	320-836	367
320-589	539	320-779	370	320-837	367
320-590	539	320-780	370	320-838	367
320-591	260, 775	320-800A	545	320-847	530
320-592	260, 775	320-800B	545	320-848	367
320-593	260, 775	320-800C	545	320-848T	530
320-615	537	320-800D	545	320-849	367
320-617	537	320-800E	545	320-849T	530
320-621	538	320-800F	545	320-850	367
320-622	538	320-801A	545	320-850T	530
320-623	538	320-801B	545	320-851	367
320-624	538	320-801C	545	320-851T	530
320-625	538	320-801D	545	320-852	367
320-626B	540	320-801E	545	320-852T	530
320-626G	540	320-801F	545	320-853	367
320-627B	202	320-802A	545	320-853T	530
320-627G	202	320-802B	545	320-854	367
320-628B	202	320-802C	545	320-854T	530
320-628G	202	320-802D	545	320-855	367
320-629B	540	320-802E	545	320-855T	369
320-629G	540	320-802F	545	320-856	367
320-630B	540	320-803A	544	320-857	367
320-630G	540	320-803B	544	320-858	367
320-634T	541	320-803C	544	320-859	534
320-636T	541	320-803D	544	320-859A	534
320-638	541	320-803E	544	320-860	534
320-639	541	320-803F	544	320-860-9-0	546
320-640	541	320-804A	544	320-861	534
320-641	541	320-804B	544	320-861-9-1	546
320-642	541	320-804C	544	320-861A	534
320-643	541	320-804D	544	320-862	534
320-644	541	320-804E	544	320-862-9-2	546
320-645	541	320-804F	544	320-862A	534
320-646	541	320-805A	544	320-863	534
320-647	541	320-805B	544	320-863-9-3	546
320-658	541	320-805C	544	320-863A	534
320-659	541	320-805D	544	320-864	534
320-660	541	320-805E	544	320-864-9-4	546
320-661	541	320-805F	544	320-864A	534
320-662	541	320-808	367	320-865	534
320-663	541	320-809	367	320-865-9-5	546
320-664	541	320-810	367	320-865A	534
320-665	541	320-810P	368	320-866	534
320-666	541	320-811	367	320-866-9-000	546
320-667	541	320-811P	368	320-866A	534
320-670	541	320-812	367	320-867-9-6	546
320-678	535	320-813	367	320-868-15-00	546
320-679	535	320-814	367	320-868-15-1	546
320-680	535	320-815	367	320-868B-15-6	546
320-681	535	320-816	367	320-869L	532
320-682	535	320-817	367	320-869S	532
320-683	535	320-818	367	320-870	369
320-684	535	320-826T	530	320-870A	369
320-685	535	320-827	367	320-871	369
320-686	535	320-827T	530	320-871A	369
320-687	535	320-829	367	320-872	369
320-708	366	320-829T	530	320-872A	369
320-709	366	320-830	367	320-873	369
320-710	366	320-830T	530	320-873A	369
320-711	366	320-831	367	320-874	369
320-712	366	320-831T	530	320-874A	369
320-713	366	320-832	367	320-875	369
320-714	366	320-832T	530	320-875A	369
320-715	366	320-833	367	320-876	369
320-716	366	320-833T	530	320-876A	369
320-717	366	320-834	367	320-877	369
320-718	366	320-834T	530	320-877A	369

320-878	369	320-920	534	330-472	387
320-878A	369	320-922A	535	330-500	386
320-879	532	320-922B	535	330-511	386
320-881A	536	320-922C	535	330-512	386
320-881B	536	320-923A	535	330-513	386
320-881C	536	320-923C	535	330-514	386
320-881D	536	320-924A	532	330-515	386
320-882A	536	320-924B	532	330-516	386
320-882B	536	320-932B	535	330-517	386
320-882C	536	320-936	520	330-518	386
320-882D	536	320-940	371	330-519	386
320-883A	536	320-941	371	330-530	386
320-883B	536	320-942	371	330-531	386
320-883C	536	320-944	371	330-532	386
320-883D	536	320-946	371	330-533	386
320-884A	543	320-948	371	330-534	386
320-884B	543	320-950	370	330-535	386
320-884C	543	320-951	370	330-536	386
320-884D	543	320-952	370	330-537	386
320-884E	543	320-953	370	330-538	386
320-884F	543	320-954	370	330-539	386
320-885A	543	320-955	370	330-550	392
320-885B	543	320-958	533	330-551	392
320-885C	543	320-959	533	330-552	392
320-885D	543	320-960	533	330-553	392
320-885E	543	320-962	533	330-554	392
320-885F	543	325-130	18	330-555	392
320-886A	543	330-001	400	330-556	392
320-886B	543	330-002	400	330-557	392
320-886C	543	330-003	400	330-558	392
320-886D	543	330-004	400	330-559	392
320-886E	543	330-005	400	330-570	392
320-886F	543	330-010	400	330-571	392
320-887A	542	330-011	400	330-572	392
320-887B	542	330-012	400	330-573	392
320-887C	542	330-013	400	330-574	392
320-887D	542	330-014	400	330-575	392
320-887E	542	330-015	400	330-576	392
320-887F	542	330-016	401	330-577	392
320-888A	542	330-017	401	330-578	392
320-888B	542	330-018	401	330-579	392
320-888C	542	330-020	385	330-590	386
320-888D	542	330-021	385	330-591	386
320-888E	542	330-022	385	330-592	386
320-888F	542	330-023	385	330-593	386
320-889A	542	330-024	385	330-594	386
320-889B	542	330-030	385	330-595	386
320-889C	542	330-031	385	330-596	386
320-889D	542	330-032	385	330-597	386
320-889E	542	330-033	385	330-598	386
320-889F	542	330-034	385	330-599	386
320-896	547	330-035	385	330-600	386
320-897	547	330-100	401	330-601	386
320-898	547	330-105	401	330-602	386
320-899	547	330-110	401	330-603	386
320-900	547	330-120	401	330-604	386
320-901	547	330-125	401	330-605	386
320-902	547	330-130	401	330-606	386
320-903	547	330-135	401	330-607	386
320-904	547	330-450	57	330-608	386
320-910	547	330-452	57	330-609	386
320-911	547	330-454	57	330-610	390
320-912	547	330-456	57	330-611	390
320-913	547	330-460	387	330-612	390
320-914	547	330-462	387	330-613	390
320-915	547	330-464	387	330-614	390
320-916	547	330-466	387	330-615	390
320-917	547	330-468	387	330-616	390
320-918	547	330-470	387	330-620	391

330-621	391	330-791MB	400	335-205	377
330-622	391	330-792M	398	335-207	377
330-623	391	330-792MB	400	335-210	377
330-624	391	330-793M	398	335-212	377
330-625	391	330-793MB	400	335-226	379
330-626	391	330-794M	398	335-250	380
330-630	384	330-794MB	400	335-254	380
330-631	384	330-795M	398	335-255	380
330-632	384	330-795MB	400	335-260	380
330-633	384	330-796M	398	335-265	380
330-634	384	330-796MB	400	335-270	381
330-635	384	330-799-SET	398	335-275	381
330-636	384	330-800M-SET	398	335-280	381
330-640	384	330-801M	398	335-285	381
330-641	384	330-802M	398	335-320	201
330-642	384	330-803M	398	335-322	201
330-643	384	330-804M	398	335-324	201
330-644	384	330-805M	398	335-325	201
330-645	384	330-806M	398	335-326	201
330-646	384	330-807M	398	335-326A	201
330-650	384	330-808	405	335-326B	201
330-651	384	330-811	406	335-326C	201
330-652	384	330-814	406	335-326D	201
330-653	384	330-814R	406	335-326E	201
330-654	200	330-817	405	335-327A	201
330-654A	200	330-818	408	335-327B	201
330-655	200	330-819	405	335-327C	201
330-655A	200	330-823	412	335-327D	201
330-656	200	330-824	407	335-327E	201
330-656A	200	330-824NH	407	335-350	202
330-657	200	330-824S	407	335-355	202
330-657A	200	330-824SH	407	335-360	202
330-658	200	330-827	412	335-380	525
330-658A	200	330-832	410	335-390	524
330-660	393	330-833	408	335-391	524
330-661	393	330-834	409	335-392	524
330-662	393	330-835	409	335-393	524
330-663	393	330-839	410	335-396	524
330-664	393	330-840	411	335-397	524
330-665	393	330-841	411	335-398	524
330-670	393	330-842	411	335-399	524
330-671	393	330-844	413	335-400	525
330-672	393	330-845	413	335-404	525
330-673	393	330-846	413	335-406	525
330-674	393	330-847	413	345-215B	774
330-675	393	330-849A	396	345-216	774
330-690	395	330-849B	396	345-216B	774
330-691	395	330-849C	396	345-217	261, 775
330-692	395	330-849D	396	345-218	765
330-693	395	330-849E	396	345-220	765
330-694	395	330-882	394	345-224	766
330-695	395	330-883	394	345-226	766
330-696	395	330-884	394	345-228	766
330-700	395	330-885	394	345-241	761
330-701	395	330-886	394	345-242	761
330-702	395	330-887	394	345-243	764
330-703	395	330-888	394	345-246	773
330-704	395	330-889	394	345-246A	773
330-705	395	330-890	394	345-247	771
330-706	395	330-891	394	345-262	768
330-708	394	330-892	394	345-263	768
330-708A	394	330-895	394	345-264	764
330-730	397	335-135	378	345-265	764
330-731	397	335-136	378	345-266	764
330-732	397	335-137	378	345-267	764
330-733	397	335-138	378	345-270	774
330-790M	398	335-139	378	345-279	760
330-790MB	400	335-140	378	345-281	757
330-791M	398	335-141	378	345-281A	758

345-282	757	355-162	518	400-101	154
345-283	757	355-163	518	400-103	154
345-283A	758	355-163L	518	400-105	154
345-285	757	355-170	519	400-107	154
345-285A	758	355-171	519	400-109	154
345-287	757	355-171L	519	400-111	154
345-287A	758	355-172	519	400-113	154
345-289	757	355-173	519	400-115	154
345-289A	758	355-173L	519	400-293	154
345-289R	761	355-182	428	400-294	154
345-290	759	355-183	428	400-358	156
345-291	759	355-186	572	400-359	156
345-292	759	355-187	572	400-360	156
345-293	759	355-188	572	400-361	156
345-294	759	355-189	571	400-362	156
345-300	761	355-190	571, 582	400-363	156
345-302	761	355-191	571	400-364	156
345-305	761	355-192	571, 582	400-365	156
345-310	764	355-193	571, 572, 582	400-419T	191
345-311	764	355-196	569	400-420T	190, 191
345-312	765	355-198	582	400-421T	190
345-314	765	355-199	582	400-422T	190
345-320	772	355-202	577	400-423T	190
345-320S	773	355-206	583	400-428	49
345-322	772	355-207	578	400-428A	49
345-324	772	355-209	577	400-431T	194
345-324S	773	355-210	577	400-436T	194
345-326	772	355-211	579	400-437T	194
345-330	772	355-212	574	400-438T	194
345-332	772	355-213	574	400-445	178
345-338	771	355-214	574	400-445C	178
345-340	770	355-219	568	400-445L	178
345-342	770	355-221	491	400-446	178
345-344	770	355-222	490	400-446L	178
345-345	771	355-223	490	400-447	178
345-346	771	355-226	490	400-447L	178
345-350	765	355-230	436	400-448	178
345-352	765	355-235	436	400-448L	178
345-2950	759	355-236A	437	400-461T	182
345-2951	759	355-236B	437	400-462T	182
345-2952	759	355-236N	437	400-463T	182
345-2953	759	355-236-SET	437	400-464T	182
345-2954	759	355-238	493	400-465T	182
345-2955	759	355-239	493	404-340C	687
345-2956	759	355-240	494	404-341C	687
345-2957	759	355-241	494	404-342C	687
345-2958	759	355-244	433	404-400	679
345-2959	759	355-245	435	404-400B	675
345A-P16	40	355-250	232	404-400BG	683
345A-PAG1	40	355-272	521	404-400E	692
345B-16	40	355-273	521	404-402	679, 689
345B-G1	40	355-300	558	404-402B	675
345F-CT22	41	355-2213	491	404-402BG	683
345P-MX16	40	355-2214	491	404-402E	692
345P-MXG1	40	355-2215	491	404-403BG	683
345P-RP08	41	355-2217	491	404-404	679, 689
345P-RP22	41	400-050	156	404-404B	675
350-805	95	400-050T	156	404-404BG	683
350-807	95	400-070	154	404-404E	692
350-836	418	400-071	154	404-405BG	683
350-838	418	400-074	154	404-406	679, 689
350-866	358	400-075	154	404-406B	675
350-867	358	400-076	154	404-406E	692
350-869	358	400-077	154	404-408	679, 689
350-871	358	400-080	155	404-408B	675
350-880	362	400-091	154	404-408E	692
350-884	358	400-093	154	404-410	679
350-885	358	400-095	154	404-410B	675
355-161	520	400-097	154	404-412	680

404-412B	676	404-495B	675	404-739	710
404-414	680	404-519	680	404-739D	710
404-414B	676	404-519B	676	404-739U	710
404-416	680	404-520	680	404-740	710
404-416B	676	404-520B	676	404-742	710
404-418	680	404-521	680	404-744	710
404-418B	676	404-521B	676	404-747	710
404-420	680	404-522	680	404-747E	711
404-420B	676	404-522B	676	404-749	710
404-422	680	404-523	680	404-751	710
404-422B	676	404-523B	676	404-754	710
404-424	681	404-524	680	404-754D	710
404-424B	677	404-524B	676	404-755	710
404-426	681	404-525	681	404-755D	710
404-426B	677	404-525B	677	404-755L	710
404-428	681	404-526	681	404-756	710
404-428B	677	404-526B	677	404-756D	710
404-430	681	404-527	681	404-758	710
404-430B	677	404-527B	677	404-759	710
404-432	681	404-528	681	404-760	710
404-432B	677	404-528B	677	404-761	710
404-434	681	404-529	681	404-762	710
404-434B	677	404-529B	677	404-763	710
404-450	673	404-530	681	404-764	612
404-451	673	404-530B	677	404-765	612
404-452	673	404-539	679, 687	404-766	698
404-461	673	404-539B	675, 678, 684, 685	404-767	698
404-461B	674	404-540	679, 687, 689	404-768	698
404-462	673	404-540B	675, 678, 684, 685	404-769	698
404-462B	674	404-541	679, 687, 689	404-770	698
404-463	673	404-541B	675, 678, 684, 685	404-771	698
404-463B	674	404-542	679, 689	404-772	698
404-468	686	404-542B	675, 678, 684, 685	404-774	700
404-469	718	404-543	679, 689	404-775	700
404-470	680	404-543B	675, 678, 684, 685	404-776	700
404-470B	676	404-544	679	404-777	716
404-471	680	404-544B	675	404-779	705
404-471B	676	404-553	682	404-780	705
404-472	680	404-554	682	404-781	705
404-472B	676	404-556	682	404-782	703
404-473	680	404-557	682	404-783	703
404-473B	676	404-558	682	404-784	703
404-474	680	404-559	682	404-785	703
404-474B	676	404-605	670, 671	404-786	706
404-475	680	404-606	670, 671, 672	404-787	706
404-475B	676	404-606B	669, 672	404-788	706
404-480	681	404-606SB	672	404-788U	706
404-480B	677	404-607	670, 671	404-789	705
404-481	681	404-608-SET	668	404-790	715
404-481B	677	404-711	708	404-790LP	714
404-482	681	404-711D	708	404-791	715
404-482B	677	404-711U	708	404-791LP	714
404-483	681	404-712	708	404-792	715
404-483B	677	404-714	708	404-792B	715
404-484	681	404-716	708	404-792LP	714
404-484B	677	404-719	708	404-792S	715
404-485	681	404-719E	711	404-793	715
404-485B	677	404-721	708	404-793K	716
404-490	679	404-723	708	404-793LP	714
404-490B	675	404-727	709	404-794	715
404-491	679	404-729	709	404-794LP	714
404-491B	675, 678, 684, 685	404-731	709	404-795	715
404-492	679	404-734	709	404-795LP	714
404-492B	675, 678, 684, 685	404-734E	711	404-795SLP	714
404-493	679	404-736	709	404-796	715
404-493B	675, 678, 684, 685	404-737	709	404-796LP	714
404-494	679	404-738	709	404-797	717
404-494B	675, 678, 684, 685	404-738D	709	404-798	717
404-495	679	404-738U	709	404-800	715

404-800LP	714	404-6088	670	412-609	245
404-801	715	404-6089	670	412-610	246
404-801LP	714	404-6090	670	412-612	246
404-802	715	404-6091	670	412-614	246
404-802LP	714	404-6093	670	412-615	183
404-802S	715	404-7871	706	412-616T	184
404-803	715	404-7875	706	412-618T	186
404-803LP	714	404-7885	706	412-620	250
404-810	715	404-7929	715	412-621	250
404-810LP	714	404-7929LP	715	412-622	250
404-811	715	404-7959	715	412-623	250
404-811LP	714	404-60825E	669	412-624A	250
404-812	715	412-414	186	412-624B	250
404-812LP	714	412-415	186	412-625A	250
404-813	713	412-422	187	412-625B	250
404-814	713, 717	412-436	184	412-671	301
404-822	717	412-438	184	412-672H	314
404-823	717	412-440	184	412-672-SET	314
404-824	702	412-442	184	412-673	314
404-825	715	412-442L	179	412-674	314
404-826	715	412-442R	179	412-675	314
404-827	715	412-443	178	412-676	314
404-828	715	412-444	179	412-677I	291
404-829	715	412-444KL	179	412-677L	289
404-830	715	412-444KR	179	412-677M	288
404-831	715	412-444L	179	412-678	286
404-832	715	412-444LT	179	412-678I	291
404-833	715	412-444T	179	412-678L	289
404-834	715	412-445A	180	412-678M	288
404-835	715	412-445AL	180	412-679	286, 291
404-836	698	412-445ALT	181	412-679I	291
404-837	715	412-445AT	181	412-679L	289
404-838	715	412-445B	180	412-680	286, 291
404-839	715	412-445BL	180	412-680I	291
404-4683	686	412-445BLT	181	412-680L	289
404-4684	686	412-445BT	181	412-680M	288
404-5301	682	412-445C	180	412-681	286, 291
404-5302	682	412-445CL	180	412-681I	291
404-5303	682	412-445CLT	181	412-681L	289
404-5304	682	412-445CT	181	412-681M	288
404-5305	682	412-445D	180	412-681R	292
404-5306	682	412-445DT	181	412-682	286, 291
404-5391	675	412-445EL	180	412-682I	291
404-5401	675	412-445ELT	181	412-682L	289
404-6061B	669	412-472	237	412-682M	288
404-6062B	669	412-488	178	412-682R	292
404-6063B	669	412-518	379	412-683	286, 291
404-6063EB	669	412-520	376	412-683I	291
404-6071	671	412-522	376	412-683L	289
404-6072	671	412-524	376	412-683M	288
404-6073	671	412-526	376	412-684	286, 291
404-6074	671	412-528	376	412-684I	291
404-6075	671	412-530	377	412-684L	289
404-6076	671	412-545	195	412-684M	288
404-6077	671	412-546	195	412-685	286, 291
404-6078	671	412-547	196	412-685F	299
404-6079	671	412-547T	196	412-685I	291
404-6080	671	412-548	196	412-685L	289
404-6081	670	T412-548	196	412-685M	288
404-6082	670	412-549	196	412-686	286, 291
404-6082B	669	T412-549	196	412-686H	299
404-6082C	669	412-550	196	412-686I	291
404-6083	670	412-551	196	412-686L	289
404-6083B	669	T412-551	196	412-686M	288
404-6083E	669	412-552	196	412-686R	292
404-6084	670	412-552T	196	412-688	286
404-6085	670	412-605	244	412-688M	288
404-6086	670	412-607	245	412-689	286, 290, 291
404-6087	670	412-608	245	412-690	290

412-691	290	412-775	239	413-004S	254
412-692	290	412-776	239	413-005	254
412-694	290	412-777	239	413-005S	254
412-696	290	412-779	238	413-006	255
412-700	290	412-781	238	413-006S	255
412-701	290	412-783	238	413-007	255
412-702	290	412-787	237	413-007S	255
412-704	290	412-789	237	413-008	255
412-705	287	412-790	241	413-008S	255
412-706	290	412-791	241	413-009	255
412-710	297	412-792	241	413-009S	255
412-712	297	412-793	241	413-010	256
412-713	297	412-794	241	413-010S	256
412-714	297	412-795	241	413-011	256
412-715	305	412-796	241	413-011S	256
412-715A	305	412-797	241	413-012	256
412-715B	305	412-798	241	413-012S	256
412-715C	305	412-799	241	413-013	256
412-715D	305	412-800	313	413-013S	256
412-716	305	412-805	313	413-014	256
412-716A	305	412-810	313	413-014S	256
412-717	305	412-815	313	413-015	256
412-718	305	412-830	304	413-015S	256
412-719	305	412-839	293	413-016	257
412-721	247	412-840	293	413-016S	257
412-722	247	412-841	293	413-017	257
412-723	248	412-844	293	413-017S	257
412-724	313	412-845	293	413-018	257
412-727A	304	412-846	293	413-018S	257
412-727B	304	412-847	293	413-019	257
412-728	304	412-848	293	413-019S	257
412-728B	304	412-849	293	413-020	206
412-729	304	412-850	293	413-021	206
412-729B	304	412-851	293	413-022	206
412-736-1	304	412-852	293	413-023	206
412-736-2	304	412-853	296	413-024	206
412-736-3	304	412-854	296	413-030	206
412-736-4	304	412-855	296	413-031	206
412-737-11	302	412-856	296	413-032	206
412-737-14	302	412-857	296	413-033	206
412-737-15	302	412-858	296	413-040	530
412-737-16	302	412-859	296	413-044	531
412-737-17	302	412-860	296	413-045	531
412-737-18	302	412-861	296	413-050	531
412-737-19	302	412-900	300	413-051	531
412-737-20	302	412-902	300	413-052	531
412-737-21	302	412-904	300	413-055	531
412-737-22	302	412-906	300	413-057	531
412-737-24	302	412-908	300	413-058	531
412-737-25	302	412-910	300	416-100	229
412-737-26	302	412-5374	379	416-101	229
412-738	303	412-5375	379	416-102	229
412-738-11	303	412-5377	379	416-103	229
412-738-12	303	412-7081	297	416-104	229
412-738-13	303	412-7082	297	416-105	229
412-738-50	303	412-7083	297	416-106	229
412-738-55	303	412-7084	297	416-130	228
412-738-55S	303	412-7151B	305	416-131	228
412-740	314	412-7256	247, 301	416-132	228
412-741	314	412-7257	247, 301	416-133	228
412-766	240	412-7258	247, 301	416-134	228
412-767	240	412-53765	379	416-135	228
412-768	240	413-001	254	416-136	228
412-769	240	413-001S	254	416-137	486
412-770	239	413-002	254	416-138	228
412-771	239	413-002S	254	416-139	228
412-772	239	413-003	254	416-140	228
412-773	239	413-003S	254	416-141	228
412-774	239	413-004	254	416-150	230, 231

416-152	231	416-522	215	417-0036	225
416-153	231	416-524	215	417-0037	225
416-154	231	416-526	215	417-045	278
416-157	231	416-528	215	417-046	485
416-158	231	416-530	215	417-047	485
416-159	231	416-532	215	417-048	455
416-161	231	416-534	215	417-048R	455
416-162	231	416-536	215	417-049	482
416-163	231	416-538	215	417-0050	225
416-199	233	416-550	216	417-0051	225
416-200	213	416-552	216	417-0052	225
416-201	214	416-554	216	417-0053	225
416-202	214	416-556	216	417-055	487
416-220	217	416-558	216	417-055L	487
416-220B	217	416-559	216	417-055S	487
416-220L	217	416-560	216	417-056	484
416-225	218	416-562	216	417-056D	484
416-230	212	416-564	216	417-057	484
416-250	212	416-566	216	417-058	226
416-260	211	416-568	216	417-058D	226
416-280	210	416-580	219	417-0060	225, 482
416-298	217	416-582	219	417-060A	482
416-299	217	416-584	219	417-060B	482
416-300	220	416-586	219	417-060C	482
416-305	220	416-588	219	417-060D	482
416-312	222	416-590	219	417-060E	482
416-314	222	416-600	281	417-0061	225, 453
416-316	222	416-601	279	417-0062	225, 451
416-330	222	416-602	280	417-062A	451
416-335	222	416-603	279	417-062B	451
416-340	221	416-604	279	417-062C	451
416-342	221	416-605	280	417-062D	452
416-400	216	416-610	281	417-0063	225, 484
416-402	216	416-615	281	417-0064	225, 483
416-404	216	416-650	218	417-064A	483
416-406	216	416-655	218	417-064B	483
416-408	216	416-660	211	417-064C	483
416-410	216	416-680	210	417-064D	483
416-412	216	416-700	213	417-064E	483
416-414	216	416-800	223	417-064F	483
416-416	216	416-801	223	417-070	461
416-418	216	416-802	223	417-072	461
416-420	216	416-803	223	417-088	265
416-422	216	416-804	223	417-098	224
416-424	216	416-805	223	417-0135	225
416-426	216	416-806	223	417-0136	225
416-428	216	416-807	223	417-0137	225
416-450	215	416-808	223	417-0138	225
416-452	215	416-809	223	417-0139	225
416-454	215	416-810	223	417-0140	225
416-456	215	416-820	222	417-0141	225
416-458	215	416-821	222	417-0142	225
416-460	215	416-822	222	417-0143	225
416-462	215	416-823	222	417-0144	225
416-464	215	416-824	222	417-0482	456
416-466	215	416-825	222	417-0482B	456
416-468	215	416-826	222	419-378	551
416-500	215	416-827	222	419-380	551
416-502	215	416-844	227	419-382	551
416-504	215	416-846	227	419-384	551
416-506	215	416-848	227	419-386	551
416-508	215	416-850	227	419-388	553
416-510	215	417-006	225	419-392	553
416-512	215	417-0030	225	419-393	553
416-514	215	417-0031	225	419-394	553
416-516	215	417-0032	225	419-395	553
416-518	215	417-0033	225	419-396	553
416-519	215	417-0034	225	419-397	553
416-520	215	417-0035	225	419-398	553

440-308	704	468-331	78	469-071	73
440-309	704	468-332	79	469-072	73
440-310	704	468-333	79	469-074	73
440-311	704	468-334	80	469-076	73
440-312	704	468-335	80	469-078	73
440-313	704	468-336	81	469-080	87
440-420	195	468-337	81	469-081	87
440-421	195	468-338	82	469-082	87
440-423	195	468-339	82	469-083	87
442-210	104	468-340	77	469-084	87
442-212	104	468-342	77	475-490	134
442-214	104	468-343	77	475-492	134
442-215	104	468-344	77	475-596	769
442-216	104	468-548	698	475-598	769
442-218	104	468-550	698	475-600	769
442-219	104	468-580	700	475-605	769
442-236	101	468-585	700	475-610	769
442-238	101	468-590	700	475-615	769
442-238P	101	468-600	699	475-618L	770
442-239	101	468-606	699	475-618R	770
442-240	101	468-610	699	475-803	384
442-242	106	468-616	699	475-804	384
442-244	106	468-620	699	475-805	384
442-246	106	468-622	699	475-806	384
442-2103	104	468-636	699	502-271	86
442-2123	104	468-638P	699	502-272	86
442-2143	104	468-680	701	502-273	86
467-310	155	468-682	701	502-274	86
467-311	155	468-684	701	502-276	86
467-314T	159	468-686	701	502-277	87
467-315	159	469-009	63	508-523	312
467-317	159	469-010	63	515-505	162
467-317B	155	469-012	63	516-002	85
467-318	159	469-015	65	516-003	85
467-320	155	469-020	68	516-005	85
467-331L	89	469-020S	68	516-006	85
467-331M	89	469-021	68	516-007	85
467-331S	89	469-026	68	516-008	85
467-332	94	469-033T	94	525-364	351
467-333	89	469-035	707	1100-165	120
467-334	92	469-036	61	1100-167	120
467-335	90	469-036B	69	1100-169	120
467-335E	90	469-038	67	1100-179	120
467-336	91	469-039	67	1100-183	101
467-339	74	469-040	61	1100-185	127
467-339U	74	469-041	67	1100-187	120
467-350	93	469-041B	69	1100-328	62
467-352	66	469-041Q	64	1100-328B	72
467-352B	71	469-042Q	64	1100-328L	60
467-414	522	469-044	67	1100-328LB	71
468-169	184	469-046Q	64	1100-328S	63
468-170	184	469-048	61	1100-330	62
468-171	184	469-048B	70	1100-330S	60
468-172	184	469-050	61	1100-331	61
468-181	186	469-050B	70	1100-332	62
468-182	186	469-051	65	1100-333	60
468-183	186	469-053	719	1100-334	60
468-184	186	469-055	719	1100-335S	65
468-185	186	469-056	719	1100-426	346
468-300	157	469-057	719	1100-426M	346
468-321	83	469-058	719	1100-451	327
468-322	83	469-062	87	1100-452	327
468-323	84	469-063	87	1100-460E	551
468-324	84	469-063A	87	1100-460L	551
468-325	83	469-063L	87	1100-460M	551
468-326	83	469-063M	87	1100-460S	551
468-327	84	469-063X	87	1100-460T	551
468-328	84	469-070	73	1100-460X	551
468-330	78	469-070B	73	1100-461S	407

1100-462S	404	1100-628G	448	1100-668T	468, 470
1100-462SH	404	1100-628GR	448	1100-669	468, 470
1100-463S	404	1100-629	445	1100-669B	468, 470
1100-479A	399	1100-629A	440	1100-670	473
1100-479B	399	1100-629B	445	1100-670B	473
1100-479C	399	1100-629G	448	1100-671	476
1100-479D	399	1100-629GR	448	1100-671E	476
1100-479E	399	1100-629L	445	1100-672	476
1100-479F	399	1100-630	445	1100-672E	476
1100-479G	399	1100-630A	445	1100-673	476
1100-479H	399	1100-630ER	446	1100-673E	476
1100-479J	399	1100-630G	448	1100-674	476
1100-479K	399	1100-630GR	448	1100-675	476
1100-479L	399	1100-630N	443	1100-676	476
1100-479M	399	1100-631	440	1100-677	476
1100-479N	399	1100-631A	440	1100-678	477
1100-479-SET	399	1100-631B	440	1100-679	477
1100-485	767	1100-631G	448	1100-680	477
1100-485-SET	767	1100-631GR	448	1100-682	462
1100-490	763	1100-631M	450	1100-684	462
1100-490C	762	1100-631N	443	1100-686	462
1100-491	762	1100-631S	440	1100-710A	88
1100-492	756	1100-632	445	1100-710B	88
1100-492A	756	1100-632AB	444	1100-710C	88
1100-492B	756	1100-632ABR-7	447	1100-712A	88
1100-492C	756	1100-632ABR-8	447	1100-712B	88
1100-492D	757	1100-632G	448	1100-712C	88
1100-492F	757	1100-632GR	448	1100-714A	88
1100-492G	757	1100-632R	443	1100-714B	88
1100-496	591	1100-633A	442	1100-714C	88
1100-496D	593	1100-633B	442	1100-716A	88
1100-496L	592	1100-633BR	442	1100-716B	88
1100-512	379	1100-633C	442	1100-716C	88
1100-529	576	1100-633D	442	1100-718A	88
1100-530	576	1100-633E	442	1100-718B	88
1100-530A	573	1100-633F	443	1100-718C	88
1100-531	573	1100-633G	443	1100-720A	88
1100-532	428	1100-633H	443	1100-720B	88
1100-533	428	1100-633HR	443	1100-720C	88
1100-533A	428	1100-633I	443	1100-722A	88
1100-536	428	1100-635	457	1100-722B	88
1100-542	745	1100-635C	457	1100-722C	88
1100-544	745	1100-636	269	1100-724A	88
1100-549	737	1100-638	269	1100-724B	88
1100-557	737	1100-640	269	1100-724C	88
1100-557B	737	1100-642	269	1100-732	117
1100-557C	737	1100-644	269	1100-733	117
1100-557D	737	1100-644B	269	1100-735F	135
1100-574	740	1100-645B	273	1100-739A	122
1100-576	740	1100-645S	273	1100-739B	122
1100-577	740	1100-646	277	1100-740	44
1100-577S	740	1100-648	467	1100-741	44
1100-578	746	1100-648B	467	1100-742	46
1100-578A	746	1100-650	467	1100-759	665
1100-608	275	1100-650B	467	1100-765	662
1100-616	272	1100-652	467	1100-766	664
1100-617	272	1100-652B	467	1100-769	88
1100-618	272	1100-654	467	1100-770	88
1100-619	272	1100-654B	467	1100-771A	88
1100-620	272	1100-656	467	1100-771B	88
1100-621	272	1100-656B	467	1100-788	35
1100-622	272	1100-658	467	1100-791	203
1100-623	272	1100-658B	467	1100-798	374
1100-624	272	1100-660	467	1100-798A	374
1100-625	272	1100-660B	467	1100-798B	375
1100-628	445	1100-662	467	1100-798C	375
1100-628A	440	1100-662B	467	1100-798D	375
1100-628B	445	1100-668	468, 470	1100-798E	374
1100-628C	440	1100-668B	468, 470	1100-798F	374

1100-798G.....	374	1103-024.....	343, 344	1103-088.....	347
1100-798H.....	376	1103-027.....	343	1103-090.....	663
1100-798S.....	374	1103-031.....	354	1103-092.....	656
1100-858.....	125	1103-033.....	339	1103-093.....	656
1100-859.....	125	1103-036.....	352	1103-094.....	656
1100-860.....	125	1103-036R.....	352	1103-095.....	656
1100-861.....	125	1103-037.....	353	1103-100.....	581
1100-862.....	125	1103-037A.....	353	1103-102.....	576
1100-863.....	125	1103-037S.....	353	1103-103V.....	576
1100-864.....	125	1103-038.....	354	1103-104.....	570
1100-865.....	125	1103-039L.....	341	1103-105.....	581
1100-866.....	45	1103-039N.....	341	1103-107.....	580
1100-868.....	45	1103-039S.....	340	1103-108.....	570
1100-870.....	47	1103-040.....	348	1103-109.....	570
1100-872.....	47	1103-040A.....	345	1103-110.....	569
1100-874.....	125	1103-040AS.....	345	1103-115.....	568
1100-875.....	125	1103-040B.....	345	1103-117.....	580
1100-876.....	125	1103-040BS.....	345	1103-120.....	494
1100-877.....	125	1103-040C.....	345	1103-122.....	429
1100-878.....	125	1103-040R.....	348	1103-123.....	429
1100-879.....	125	1103-041.....	348	1103-125.....	427
1100-880.....	125	1103-041A.....	349	1103-126.....	427
1100-881.....	125	1103-041B.....	349	1103-126R.....	427
1100-4851.....	767	1103-041C.....	349	1103-127.....	427
1100-4852.....	767	1103-042.....	348	1103-127A.....	427
1100-4853.....	767	1103-043.....	348	1103-133L.....	559
1100-6251.....	274	1103-044.....	346	1103-133M.....	559
1100-6252.....	274	1103-044S.....	346	1103-133S.....	559
1100-6253.....	274	1103-045.....	341	1103-134.....	492
1100-6280.....	445	1103-046.....	347	1103-137L.....	558
1100-6282.....	449	1103-048.....	340	1103-137M.....	558
1100-6283.....	449	1103-049.....	338	1103-137S.....	558
1100-6292.....	449	1103-049L.....	338	1103-138.....	495
1100-6293.....	449	1103-050.....	329	1103-140.....	575
1100-6312.....	449	1103-051.....	339	1103-140A.....	575
1100-6313.....	449	1103-054A.....	350	1103-140J.....	575
1100-6315.....	441	1103-054B.....	350	1103-141.....	559
1100-6317.....	441	1103-054C.....	350	1103-142.....	559
1100-6322.....	449	1103-054D.....	350	1103-144.....	557
1100-6323.....	449	1103-055.....	351	1103-145.....	557
1100-6332.....	449	1103-056.....	351	1103-147.....	586
1100-6333.....	449	1103-057.....	351	1103-150.....	590
1100-6334.....	449	1103-060.....	351	1103-152.....	587
1100-6335.....	449	1103-061.....	351	1103-152A.....	591
1100-6691.....	463	1103-065.....	328	1103-153.....	587
1100-6692.....	463	1103-067.....	331	1103-154S.....	587
1100-6696.....	477	1103-068.....	319	1103-155.....	589
1100-6780.....	477	1103-069.....	319, 322	1103-156.....	492
1100-7334.....	117	1103-070.....	318	1103-158.....	593
1100-7335.....	117	1103-071.....	318	1103-158B.....	592
1100-7411.....	44	1103-071J.....	320	1103-158M.....	590
1100-7413.....	46	1103-071L.....	320	1103-158S.....	593
1103-003.....	324	1103-073.....	318	1103-159.....	588
1103-004.....	324	1103-073J.....	320	1103-160.....	564
1103-005.....	324	1103-073L.....	320	1103-161.....	511
1103-006.....	325	1103-074.....	318	1103-162A.....	511
1103-008.....	325	1103-075.....	318	1103-162B.....	511
1103-010.....	325	1103-075D.....	318	1103-162C.....	511
1103-011.....	325	1103-076.....	318	1103-162D.....	512
1103-013.....	326	1103-077.....	318	1103-162E.....	512
1103-014.....	326	1103-077J.....	320	1103-162M.....	512
1103-015.....	326	1103-077L.....	320	1103-162S-SET.....	511
1103-017.....	326	1103-078.....	318	1103-165.....	562
1103-020.....	340	1103-078J.....	320	1103-166.....	562
1103-021.....	344	1103-078L.....	320	1103-166X.....	562
1103-021A.....	344	1103-079.....	318	1103-167.....	562
1103-023.....	343	1103-079J.....	320	1103-168.....	510
1103-023A.....	344	1103-079L.....	320	1103-168-SET.....	510
1103-023B.....	344	1103-080.....	318	1103-170.....	54

1103-171.....	592	1103-241.....	760	1103-811.....	137
1103-176.....	506	1103-242.....	760	1103-811T.....	137
1103-178A.....	423	1103-263.....	366	1103-812.....	136
1103-178C.....	423	1103-264.....	366	1103-812T.....	127
1103-179.....	422	1103-265.....	366	1103-841.....	564
1103-180.....	510	1103-266.....	366	1103-843.....	328
1103-180T.....	510	1103-267.....	366	1103-844.....	328
1103-184K.....	504, 508	1103-268.....	366	1103-845.....	330
1103-184-SET.....	508	1103-269.....	366	1103-846.....	330
1103-184T-SET.....	508	1103-270.....	366	1103-846R.....	330
1103-185K.....	504, 508	1103-271.....	366	1103-847.....	565
1103-185-SET.....	508	1103-272.....	366	1103-848.....	565
1103-185T.....	506, 508, 509	1103-280.....	394	1103-848S.....	565
1103-185T-SET.....	508	1103-280C.....	394	1103-856.....	331
1103-186X.....	507	1103-281.....	394	1103-856R.....	331
1103-187.....	507, 508, 509	1103-281C.....	394	1103-1381.....	495
1103-190.....	504, 508	1103-282.....	394	1103-1551.....	589
1103-190H.....	505, 508, 509	1103-282C.....	394	1103-1552.....	589
1103-191.....	504, 508	1103-283.....	394	1103-1601.....	515
1103-191H.....	505, 508	1103-283C.....	394	1103-1622.....	514
1103-193.....	504, 509	1103-284.....	394	1103-1623.....	514
1103-193K.....	504, 509	1103-284C.....	394	1103-1624.....	514
1103-193-SET.....	509	1103-285.....	394	1103-1625.....	512
1103-193T-SET.....	509	1103-285C.....	394	1103-1626.....	512
1103-194.....	505, 509	1103-286.....	394	1103-1627.....	512
1103-194-SET.....	509	1103-286C.....	394	1103-1661.....	563
1103-194T-SET.....	509	1103-287.....	394	1103-1662.....	563
1103-195.....	526	1103-287C.....	394	1103-2011.....	423
1103-197A.....	526	1103-288.....	394	1103-2063.....	417
1103-197B.....	526	1103-288C.....	394	1103-16820.....	510
1103-197C.....	526	1103-289.....	394	1103-16827.....	510
1103-200.....	426	1103-289C.....	394	1103-16835.....	510
1103-201.....	424	1103-290.....	454	1106-019.....	355
1103-201A.....	423	1103-291.....	394	1106-020.....	355
1103-201B.....	423	1103-291C.....	394	1106-022.....	355
1103-201C.....	423	1103-292.....	394	1106-023.....	355
1103-201D.....	423	1103-292C.....	394	1106-024.....	355
1103-201E.....	423	1103-293.....	394	1106-070.....	742
1103-201F.....	423	1103-293C.....	394	1106-075.....	742
1103-201G.....	423	1103-297.....	454	1106-076.....	741
1103-201H.....	424	1103-0331.....	342	1106-077.....	741
1103-202.....	360	1103-354.....	748	1106-078.....	741
1103-202D.....	361	1103-0391.....	342	1106-079.....	741
1103-203.....	360	1103-0425.....	348	1106-080.....	740
1103-203D.....	361	1103-0453.....	342	1106-082.....	740
1103-204.....	359	1103-0454.....	342	1106-084.....	740
1103-204A.....	359	1103-613.....	664	1106-086.....	740
1103-205.....	418	1103-615.....	665	1106-091.....	740
1103-206.....	416	1103-702.....	20	1106-092.....	740
1103-208.....	418	1103-702D.....	20	1106-124.....	426
1103-209.....	416	1103-703.....	20	1106-130.....	556
1103-210.....	379	1103-705.....	20	1106-131.....	556
1103-211.....	416	1103-708.....	12	1106-132.....	556
1103-213.....	416	1103-709.....	13	1106-133.....	557
1103-215.....	332	1103-710.....	20	1106-140.....	556
1103-223.....	760	1103-712.....	22	1106-185.....	434
1103-224.....	756	1103-715.....	20	1106-190.....	56
1103-225.....	760	1103-716.....	20	1106-196.....	425
1103-225C.....	762	1103-717.....	22	1106-197.....	432
1103-226.....	760	1103-717D.....	22	1106-198.....	425
1103-228.....	763	1103-719.....	19	1106-199.....	424
1103-229.....	761	1103-720.....	19	1106-200.....	432
1103-230.....	743	1103-723.....	20, 398, 399	1106-205.....	432
1103-232.....	762	1103-724.....	20	1106-206.....	425
1103-233.....	761	1103-729.....	233	1106-207.....	433
1103-235.....	765	1103-730.....	35	1106-210.....	432
1103-236.....	763	1103-808.....	136	1106-212.....	433
1103-237.....	763	1103-809.....	136	1106-260.....	498
1103-238.....	763	1103-810.....	136	1106-261.....	498

1106-262	498	1270-092	607	1271-086	606
1106-263	498	1270-093	607	1271-086R	606
1106-264	499	1270-094	607	1271-087	606
1106-266	499	1270-095	607	1271-087R	606
1106-268	499	1270-101	607	1271-089	721
1106-270S	498	1270-101R	608	1271-090	606, 625
1106-271	498	1270-102	607	1271-090R	608
1106-280	499	1270-103	607	1271-091	606
1106-281	499	1270-104	607	1271-092	606
1106-284	499	1270-105	607	1271-093	606
1106-285	499	1270-106	607	1271-094	606
1106-288	500	1270-107	607	1271-095	606
1106-289A	500	1270-107R	609	1271-101	606
1106-289B	500	1270-108	607	1271-101R	608
1106-375	513	1270-109	607	1271-102	606
1106-384	513	1270-110	607	1271-103	606
1106-385	513	1270-111	607	1271-104	606
1106-387	513	1270-112	607	1271-105	606
1106-388	513	1271-005	76, 603	1271-106	606
1106-391	513	1271-005A	76, 603	1271-107	606
1106-400	163	1271-006	76, 603	1271-107R	609
1106-401	163	1271-007	76, 603	1271-108	606
1106-402	163	1271-008	76, 603	1271-109	606
1106-403	163	1271-009	76	1271-110	606
1106-404	163	1271-010	62	1271-111	606
1106-0791	741	1271-011	62	1271-112	606
1106-848	515	1271-012	62	1271-113	610
1106-965	499	1271-013	62	1271-115	617
1106-967	499	1271-016	75, 603	1271-116T	617
1106-2881	500	1271-018	75, 603	1271-116U	617
1270-060	607	1271-020	75, 603, 625	1271-117	623, 624
1270-060R	607	1271-020R	75	1271-117-1	623, 624, 625
1270-061	607	1271-021	75, 603	1271-117-2	623, 624, 625
1270-061R	607	1271-021A	75, 603	1271-117-3	623, 624, 625
1270-062	607	1271-040	609	1271-117-4	623, 624
1270-062R	607	1271-041	611	1271-117-5	623
1270-063	607	1271-042	610	1271-118T	614
1270-063R	607	1271-060	606	1271-119T	614
1270-064	607	1271-060R	606, 625	1271-120	520, 619
1270-064R	607	1271-061	606	1271-120U	618
1270-065	607	1271-061R	606	1271-121	618
1270-065R	607	1271-062	606	1271-121A	618
1270-066	607	1271-062R	606	1271-121B	618
1270-066R	607	1271-063	606	1271-121C	618
1270-067	607	1271-063R	606	1271-121PT	614
1270-067R	607	1271-064	606	1271-121T	614
1270-068	607	1271-064R	606	1271-121U	618, 625
1270-068R	607	1271-065	606	1271-122	618
1270-069	607	1271-065R	606	1271-122U	618, 625
1270-069R	607	1271-066	606	1271-123	619
1270-070	607	1271-066R	606	1271-123LW	619
1270-070R	607	1271-067	606	1271-125T	614
1270-071	607	1271-067R	606	1271-126T	614
1270-071R	607	1271-068	606	1271-127T	614
1270-072	607	1271-068R	606	1271-127U	625
1270-072R	607	1271-069	606	1271-128T	614
1270-073	607	1271-069R	606	1271-129	619
1270-073R	607	1271-070	606	1271-130	619
1270-074	607	1271-070R	606	1271-130PH	619
1270-074R	607	1271-071	606	1271-133AU	620
1270-085	607	1271-071R	606	1271-133U	620
1270-085R	607	1271-072	606	1271-134	618
1270-086	607	1271-072R	606	1271-135T	614
1270-086R	607	1271-073	606	1271-136T	614
1270-087	607	1271-073R	606	1271-138T	614
1270-087R	607	1271-074	606	1271-139C	419
1270-090	607	1271-074R	606	1271-139D	419
1270-090R	608	1271-085	606	1271-139ST	614
1270-091	607	1271-085R	606	1271-139T	614

1271-139U	625	1271-400	599, 604	1271-521	600, 605
1271-140	617	1271-401	599, 604	1271-522	600, 605
1271-140U	617, 625	1271-402	599, 604	1271-523	600, 605
1271-0141	66	1271-403	599, 604	1271-524	600, 605
1271-0142	66	1271-404	599, 604	1271-525	600, 605
1271-142LT	614	1271-410	599, 604	1271-530	601, 605
1271-142RT	614	1271-411	599, 604	1271-531	601, 605
1271-142T	614	1271-412	599, 604	1271-532	601, 605
1271-142U	625	1271-413	599, 604	1271-533	601, 605
1271-0143	66, 617, 618, 620, 625	1271-414	599, 604	1271-534	601, 605
1271-0144	66	1271-420	598, 604	1271-535	601, 605
1271-145	370, 371	1271-421	598, 604	1271-540	601, 605
1271-146	371	1271-422	598, 604	1271-541	601, 605
1271-147	371	1271-423	598, 604	1271-542	601, 605
1271-148S	617	1271-424	598, 604	1271-543	601, 605
1271-148T	617	1271-425	598, 604	1271-544	601, 605
1271-149	617	1271-426	611	1271-545	601, 605
1271-0151	74	1271-430	598, 604	1271-550	602, 605
1271-0152	74	1271-431	598, 604	1271-551	602, 605
1271-0153	74	1271-432	598, 604	1271-552	602, 605
1271-0154	74	1271-433	598, 604	1271-553	602, 605
1271-0156	85	1271-434	598, 604	1271-554	602, 605
1271-183	419	1271-435	598, 604	1271-555	602, 605
1271-315	620	1271-440	598, 604	1271-610	606
1271-316	620	1271-441	598, 604	1271-611	606
1271-317	620	1271-442	598, 604	1271-612	606
1271-318	620	1271-443	598, 604	1271-613	606
1271-319	620	1271-444	598, 604	1271-614	606
1271-320	621	1271-445	598, 604	1271-615	606
1271-321	621	1271-450	602, 604	1271-620	606
1271-322	621	1271-451	602, 604	1271-621	606
1271-323	621	1271-452	602, 604	1271-622	606
1271-324	621	1271-453	602, 604	1271-623	606
1271-325	621	1271-454	602, 604	1271-624	606
1271-326	621	1271-460	602, 604	1271-625	606
1271-327	621	1271-461	602, 604	1271-640	606
1271-330	621	1271-462	602, 604	1271-641	606
1271-340	522	1271-463	602, 604	1271-642	606
1271-342	522	1271-464	602, 604	1271-643	606
1271-350	599, 604	1271-470	602, 604	1271-644	606
1271-351	599, 604	1271-471	602, 604	1271-645	606
1271-352	599, 604	1271-472	602, 604	1271-650	606
1271-353	599, 604	1271-473	602, 604	1271-651	606
1271-354	599, 604	1271-474	602, 604	1271-652	606
1271-355	599, 604	1271-480	599, 605, 625	1271-653	606
1271-360	599, 604	1271-481	599, 605	1271-654	606
1271-361	599, 604	1271-482	599, 605	1271-655	606
1271-362	599, 604	1271-483	599, 605	1271-1204U	618
1271-363	599	1271-484	599, 605	1271-1218	618
1271-364	599, 604	1271-485	599, 605	1273-031	649
1271-365	599, 604	1271-490	599, 605	1273-100	613
1271-370	598, 604	1271-491	599, 605	1273-101	613
1271-371	598, 604	1271-492	599, 605	1273-103	613
1271-372	598, 604	1271-493	599, 605	1273-105	613
1271-373	598, 604	1271-494	599, 605	1273-112	648
1271-374	598, 604	1271-495	599, 605	1273-113	648
1271-375	598, 604	1271-500	599, 605	1273-114	649
1271-380	598, 604	1271-501	599, 605	1273-115	650
1271-381	598, 604	1271-502	599, 605	1273-122	638
1271-382	598, 604	1271-503	599, 605	1273-123	638
1271-383	598, 604	1271-504	599, 605	1273-135	652
1271-384	598, 604	1271-505	599, 605	1273-146	652
1271-385	598, 604	1271-510	600, 605	1273-150	638
1271-390	598, 604	1271-511	600, 605	1273-150L	638
1271-391	598, 604	1271-512	600, 605	1273-151	638
1271-392	598, 604	1271-513	600, 605	1273-152	638
1271-393	598, 604	1271-514	600, 605	1273-153	638
1271-394	598, 604	1271-515	600, 605	1273-154	638
1271-395	598, 604	1271-520	600, 605	1273-155	638

1273-156	638	2200-080	103	2200-152N	106
1273-161	638	2200-081	103	2200-154	108
1273-162	651	2200-085	103	2200-155	108
1273-171	651	2200-090	103	2200-0175	110
1273-1141	649	2200-090P	103	2200-245	99
1404-842	721	2200-091	103	2200-361	111
1404-845A	707	2200-092	103	2200-362	111
1404-845B	707	2200-096	103	2200-362W	111
1404-845D	707	2200-097	103	2200-376	111
1404-846A	707	2200-098	103	2200-377	111
1404-846B	707	2200-098P	103	2200-377W	111
1404-846D	707	2200-099	103	2200-378	111
1404-852	613	2200-099P	103	2200-382	110
1404-853	613	2200-100	103	2200-383	116
1404-854	613	2200-101	102	2200-387	116
1404-855	703	2200-101A	102	2200-389	116
1404-857	702	2200-101F	105	2200-394	116
1404-858	702	2200-102	102	2200-396	116
1404-860	720	2200-102A	102	2200-403	363
1404-861	720	2200-102F	105	2200-405	363
1404-862	612, 718	2200-103	102	2200-0459	113
1404-865	720	2200-103A	103	2200-700	124
1404-866	704	2200-103F	105	2200-750	121
1404-870	378	2200-104	102	2200-752	121
1404-871	378	2200-104F	105	2200-789	116
1404-875	417	2200-105	102	2200-790	116
1404-875L	417	2200-105A	102	2200-0902	103
1463-140	55	2200-105B	102	2200-0912	103
1463-141	55	2200-105C	105	2200-0922	103
1463-142	55	2200-106	103	2200-1112	102
1463-143	55	2200-107	102	2200-1112B	105
1463-461	315	2200-107A	103	2200-1112P	102
1463-500	298	2200-107B	105	2200-1132	102
1463-501	298	2200-107C	103	2200-1132A	103
1463-503	298	2200-107P	102	2200-1132B	105
1463-504	298	2200-108	102	2200-1133	102
1463-506	298	2200-108A	103	2200-1151	153
1463-507	298	2200-108B	105	2200-1365	108
2200-015	110	2200-108P	102	2200-1431	109
2200-016	110	2200-109	102	2200-1441	109
2200-017	110	2200-109B	105	2205-650	114
2200-018	110	2200-110	102	2205-655	114
2200-029	113	2200-110P	102	2300-599	586
2200-030	113	2200-111	102	2300-600	587
2200-032	113	2200-111P	102	2300-601	587
2200-034	113	2200-112	102	2300-602	587
2200-036	113	2200-113	102	2300-604	587
2200-040	113	2200-114	101	2500-313	185
2200-041	113	2200-115	153	2500-313T	185
2200-042	113	2200-117A	153	2500-315	185
2200-043	113	2200-126	115	2500-315T	185
2200-044	113	2200-129	108	2500-320	185
2200-045	113	2200-130	108	2500-320T	185
2200-046	113	2200-131	108	2600-302	127
2200-047	113	2200-132	108	2600-307	127
2200-058	134	2200-133	108	2600-311	127
2200-060	134	2200-134	108	2600-335	116
2200-062	134	2200-135	108	2600-339	116
2200-064	134	2200-136	108	2600-340	99
2200-073B	114	2200-137	108	2600-341	99
2200-073C	114	2200-138	108	2600-345	99
2200-073D	114	2200-140	108	2600-350	98
2200-074	103	2200-141	108	2600-355	100
2200-074B	114	2200-141A	108	2600-357	100
2200-075	103	2200-142	108	2600-359	100
2200-076	103	2200-144	108	2600-361	100
2200-077	103	2200-145	108	2600-362	100
2200-078	103	2200-146	108	2600-364	100
2200-079	103	2200-152	106	2600-365	100

2600-367	100	2601-300	112	2700-416	191
2600-369	100	2602-100	168	2700-418	191
2600-370	100	2602-101	168	2700-420	191
2600-371	100	2602-102	168	2700-422	191
2600-373	100	2602-103	168	2700-424	191
2600-374	100	2602-104	169	2700-426	191
2600-375	100	2602-105	169	2700-428	191
2600-376	100	2602-106	169	2700-431	183
2600-377	100	2602-107	169	2700-432	183
2600-379	100	2602-200	172	2700-433	183
2600-380	112	2602-201	172	2700-450	182
2600-381	112	2602-202	172	2700-451	182
2600-382	112	2602-203	172	2700-470	182
2600-384	107	2602-204	173	2700-470A	182
2600-385	107	2602-205	173	2700-501	178
2600-385S	107	2602-206	173	2700-502	178
2600-387	107	2602-207	173	2700-504	187
2600-388	107	2602-208	173	2700-550NS	147
2600-389	107	2602-209	173	2700-552NS	147
2600-391	121	2602-210	174	2700-554NS	147
2600-392	121	2602-211	174	2700-556NS	147
2600-490	107	2602-212	174	2700-558NS	147
2600-491	107	2602-300	170	2700-560NS	147
2600-492	107	2602-301	170	2700-810	147
2600-492P	107	2602-302	170	2700-812	147
2600-493	107	2602-303	170	2700-814	147
2600-493P	107	2602-304	170	2700-815	147
2600-493P1	107	2602-305	171	2700-817	147
2600-494	107	2602-306	171	2700-819	147
2600-494A	107	2602-307	171	2700-830NS	141
2600-494D	107	2602-308	171	2700-837NS	146
2600-495	107	2602-1031	168	2700-839NS	146
2600-496	107	2602-1051	169	2700-840NS	146
2600-497	107	2602-1201	168	2700-842NS	146
2600-498	99	2603-541	688	2700-844NS	146
2600-499	99	2700-150	194	2700-850NS	146
2600-565	99	2700-152	194	2700-852NS	146
2600-618	271	2700-152T	194	2700-854NS	146
2600-3611	98	2700-153	194	2700-856NS	146
2600-3641	98	2700-154	194	2700-858NS	146
2600-3651	98	2700-154T	194	2700-859NS	146
2600-3714	100	2700-160	195	2700-860NS	146
2600-5860	98	2700-162	195	2700-862NS	145
2600-5862	98	2700-164	195	2700-864NS	145
2600-5863	98	2700-165	195	2700-879NS	144
2601-255	152	2700-166	195	2700-880NS	144
2601-260	149	2700-168	195	2700-881NS	144
2601-262	152	2700-170	195	2700-887	144
2601-264	152	2700-300	306	2700-890NS	144
2601-270	149	2700-301	306	2700-891NS	144
2601-274	149	2700-301R	307	2700-900	138
2601-275	151	2700-302	306	2700-902	138
2601-278	151	2700-303R	307	2700-902F	138
2601-280	150	2700-304	306	2700-903NS	138
2601-282	150	2700-306	306	2700-905	138
2601-283	150	2700-307R	308	2700-906	138
2601-285	150	2700-308	308	2700-908NS	138
2601-288	152	2700-308R	308	2700-915	139
2601-289	152	2700-309	309	2700-918	138
2601-290	148	2700-310	200	2700-920	139
2601-291	148	2700-312	200	2700-922	139
2601-292	148	2700-314	200	2700-924NS	139
2601-293	148	2700-390	311	2700-925	139
2601-294	153	2700-392	311	2700-930	145
2601-295	148	2700-394	311	2700-931	140
2601-295C	148	2700-405	187	2700-940	140
2601-296	148, 149	2700-410	191	2700-947	145
2601-298	149	2700-412	191	2700-955	143
2601-299	149	2700-414	191	2700-959	145

2700-960	143	ST14-K	31
2700-965	141, 143	ST15-20	27
2700-967	143	ST15-F	27
2700-968	143	ST15-F-PMT	27
2700-968NS	144	ST17-F	27
2700-974	142	ST17-F-PMT	27
2700-975	142	ST19-F	27
2700-978	140	ST19-F-PMT	27
2700-983	142	ST32-K	31
2700-984	142	ST43	25
2700-987	142	ST43-2	25
2700-988	142	ST52	30
2700-990	141	ST63	25
2700-990NS	141	ST63-2	25
2700-995	145	ST72-K	31
2700-995NS	145	ST75	30
2700-8581NS	146	ST83	24
2700-8591NS	146	ST83-2	24
2700-8601NS	146	ST100	30
2700-8815NS	144	ST106	30
2700-8915NS	144	ST107	30
2800-450	183	ST148	30
2800-451	183	ST170-0	24
9B-010	39	ST170-2	24
9B-020	39	ST302-2	26
9B-025	39	ST402-2	25
SC94-0312	623	ST602-2	25
SC94-0313	623	ST952	24, 25
SC94-0314	623	ST952-2	25
SC94-0315	623	ST952D-2	24
SC94-0316	623	ST953	24, 25
SC94-0317	623	ST1002	25
SC94-0318	623	ST1002-2	25
SC94-0319	623	ST1082-2	25
SC94-0320	623	ST1202	25
SC94-0321	623	ST1202-2	25
SC94-0322	623	ST1311-2	24, 26
SC94-0410	552	ST1650-2	25
SC94-0412	552	ST2000-2	24, 26
SC94-0415	552	STE902	25
SC94-0417	552	STE1082	25
SC94-0420	552	STE1650	25
SC94-0422	552	STE1654	25
SC94-03157	623	STE2302	25
SC94-03158	623	STE2304	25
SC94-03159	623	STE06062	25
SC95-0305	621	STE06064	25
SC95-0306	621	STE06066	25
SC95-0315	625	STE10062	25
SC95-0420	624, 625	STE10064	25
SC95-0421	624, 625	STE10066	25
SC95-0422	624, 625	STE12062	26
SC95-0423	624, 625	STE12064	26
SC95-0424	624	STE12066	26
SC95-0425	624	STE12102	26
ST2	31	STE12104	24, 26
ST3-926	28	STE12106	26
ST3-927	28	STE20122	26
ST3-929	28	STE20124	24, 26
ST3-930	28	STE20126	24, 26
ST6	27	STP12102	24
ST6G	29	STP12104	24
ST8	27	STP20122	24
ST10	27	STP20124	24
ST10-F	27	STP20126	24
ST10-F-PMT	27	STS12062	26
ST12	27	STS12064	26
ST13-F	27	STS12066	26
ST14G	29	STS12102	26
		STS12104	26

STS12106	26
STS20122	26
STS20124	26
STS20126	26
<b>A</b>	
Abdominal Spatula	236
Adapter	
Power Drill Adapter for Sontec I.M. Pin	
Chuck	506
Aderer Wire Bending Pliers	494
Adson Bipolar Forceps	138
Adson Cerebella Retractor	270
Adson-Derlacki Forceps	133
Adson Dressing Cross-Serrated Forceps	133
Adson Dressing Serrated Forceps	131
Adson Dressing TC Dust Forceps	132
Adson Dressing TC Serrated Platform Forceps	132
Adson Forceps with Skin Hook	134
Adson Harris Ring Tip Forceps	136
Adson-Harris Ring Tip Forceps Titanium	127
Adson Helms Forceps	133
Adson Periosteal Elevator	376
Adson Rongeur	753
Adson Suction	313
Adson Tissue Cross Serrated Forceps	131
Adson Tissue Forceps	128
Adson Tissue Forceps Titanium	126, 127
Adson Tissue Smooth Platform Forceps	129
Adson Tissue TC Dust Platform Forceps	129
Adson Tissue TC Serrated Platform Forceps	130
Allen Inge Stifle Retractor	454
Alligator Forceps	63
Alligator Forceps Tubular Shaft	62
Alligator Forceps with Malleable Shaft	66
Alligator Sterilizing Rack	18
Andrews Pynchon Suction	309
Anterior Spinal Curette	546
Anthony Suction	309
Anti-Buckle Wire Twister	588
AO Tap Cannulated	513
AO Type Bending Pliers Set	437
AO-Type Bone Reduction Clamp	339
AO Type Mallet	410
A.O. Type Universal Screw Driver	499
AO Type Universal Screwdriver Set	500
Arthroscopic	603
Arthroscopic Biopsy Grasping Forceps	608, 609
Arthroscopic Crocodile Grasping Forceps	648
Arthroscopic Curette & Ring Curette	617
Arthroscopic Dilation Needle	624
Arthroscopic Gawsling Basket Punch	652
Arthroscopic Grasping & Biopsy Combo Rongeur Forceps	75
Arthroscopic Grasping Forceps	606, 607
Arthroscopic Hook Probe	618
Arthroscopic Hook Probe with Conical Handle	618
Arthroscopic Hook Punch	598
Arthroscopic Low Profile Toothed Punch	600
Arthroscopic Maxi Grasper	612
Arthroscopic Meniscotomes Hook	615, 616
Arthroscopic Metzenbaum Hook Scissors	

602	
Arthroscopic Mini Grasper	612
Arthroscopic Mini Low Profile Hook Punch	599
Arthroscopic Mini Scissors	603
Arthroscopic Mini Scissors Forceps Biopsy Grasping Forceps	603
Arthroscopic Needle Holder	610
Arthroscopic Punch Rongeur	605
Arthroscopic Punch & Scissors	604
Arthroscopic Rasp	618, 620
Arthroscopic Right Left Side Punch	601
Arthroscopic Rottweiler Loosebody Grasping Forceps	649
Arthroscopic Saber Scissor Punch	652
Arthroscopic Switch Stick	623, 624
Arthroscopic Velociraptor Biopsy Forceps	651
Arthroscopic Velociraptor Junior Biopsy Forceps	651
Aufranc Cobra Retractor	462
Avian Mini Wire Passer	565
Avian Nail Trimmer	665
Awl	
Daniel Nasal Awl	522
Liska Awl	522
Perthes Awl	522
Axel Wire Twister	589
<b>B</b>	
Babcock Bone Holding Clamp	328
Baby GOLD-CUT HERCULES® Pin Cutter	572
Baby Poole Suction	312
Bacon Duckbill Rongeur	750
Bailey Rongeur	704
Bane Single Action Rongeur	748
Barnes Mini Suction Tube	297
Baron Suction	297
Barrier Wrap	
Sontec Instrument Fabric Barrier Wrap 2Ply	33
Basin	
Emesis Basin	27
Basket Standard	599
Bayonet Bipolar Forceps	141
Bayonet Curette Titanium	530
Bayonet Forceps	155
Bayonet Nerve Hook	183
Bayonet Nerve Hook Titanium	184
Bayonet Ring Curette Titanium	531
Bayonet Spinal Knife Handle	49
Bayonet Suction Tube	300
Beasley-Babcock Tissue Forceps	129
Beatty Foraminotomy Rongeur	674
Beaver Blade Chuck Handle #3K	45
Beaver Blade Chuck Handle #3KD	46
Beckman-Adson Retractor	273
Beckman-Eaton Retractor	277
Beckman Retractor	273
Bender	
Black Vickers K-Wire Pin Bender	423
Sontec Pin Driver / Bender	424
Vickers Easy Driver / Bender / Puller	422
Bending Iron	
Mini Plate Bending Iron	432
Plate Bending Iron	433
Plate Bending Iron Lateral & Contour	433

Small Plate Bending Iron	432
Standard Plate Bending Iron	432
Bespoke Wroblewski Bone Trephine	553
Beyer Rongeur	727
Bio-Met Type Wire Twister	592
Bio-Met Wire Twister	592
Biopsy & Grasping Rongeur Forceps	603
Bipolar Bayonet Suction Wide Grip Forceps	147
Bipolar Bayonet Wide Grip Forceps	146
Bipolar Cord	
Reusable Bipolar Cord	143
Bircher-Ganske Cartilage Clamp	358
Bishop Bone Clamp	332
Bit	
Countersink Bit Cannulated	513
Black Monopolar Suction Tube	147
Black Ruskin Rongeur	725
Black Vickers K-Wire Pin Bender	423
Blade	
Blunt Blade	228
Caspar Blunt Smooth Blade	216
Caspar Serrated Lateral Blade	215, 223
Caspar V-Blunt Blade	215
Medial Blade	216
Round Blade	228
Scoville Lumbar Blade	225
Scoville Middle Lumbar Blade	225
SL - Connect Blunt Blade Titanium	219
SL - Connect Lateral Blade Titanium	219
Toothed Blade	229
Blade Holder	
Blake Blade Holder	46
Blade Insert Instrument	
SL - Connect Blade Insert Instrument	218
Blake Blade Holder	46
Blakesley Ethmoid Rongeur	701
Blakesley-Ethmoid Rongeur	701
Blumenthal Rongeur	748
Blunt Blade	228
Bone Chip Packer	
Hibbs Bone Chip Packer	525
Bone Clamp	
Kern Bone Clamp	323
Kern Hybrid Bone Clamp	322
Ulrich Bone Clamp	321
Ulrich Swivel Jaw Bone Clamp	335
Verbrugge Bone Clamp	318, 319, 320
Verbrugge Reverse Jaw Bone Clamp	320
Verbrugge-Rogalski Bone Clamp	322
Bone Cutter / Nail Nipper	663
Bone Forceps	
Sequestrum Sontec Bone Forceps	326
Bone Holding Forcep	
Stefan Bone Holding Forcep	325
Bone Holding Forceps	347
Bone Hook	
T-Handle Bone Hook	520
Bone Mill Set	527
Bone Pick Micro Fracture	621
Bone Reduction Clamp	353
Deluxe Bone Reduction Clamp	347
Schroeder Vulsellum Bone Reduction Clamp	351
Bone Reduction Clamp Extra Large	338
Bone Reduction Forceps	
Plate & Bone Reduction Forceps	354

Bone Reduction K-Wire Guide Clamp	342
Bone Scraper Set	521
Bone Tamp	526
Pin Driver & Bone Tamp	423
Bone Tunnel Borer	515
Bonney Tissue Forceps	123
Borer	
Bone Tunnel Borer	515
Bowl	
Sponge Bowl	30
Braake Tendon Knife	419
Brass Head Mallet	406
Braun Fixed Caliper	55
Braun-Ralph Suction	309
Broli-Adson Forceps	134
Brown-Adson Cooley Forceps	135
Brown-Adson Tissue Forceps	135
Brown-Adson Tissue Forceps Titanium	134
Brown-Cushing Bayonet Forceps	158
Brown Forceps	136
Brown Tissue Forceps	109
Bruns Hexagonal Handle Curette	369
Bruns Oval Cup Curette	367, 368
Bruns Ring Curette	371
Bruns Round Cup Curette	366
Bruns Solid Hexagonal Curette	369
Brush	
Whisk 'R Brush	39
Bryant Mitral Hook Retractor	185
Buie Suction Tube	312
Bunt Forceps Holder Ring	35
<b>C</b>	
Caliper	
Braun Fixed Caliper	55
Castroviejo Caliper	52, 53
House Ear Caliper	55
Jameson Caliper	54
Mini Caliper	54
Neuro Caliper	232
Orthopedic Vernier Caliper	54
Stahl Caliper	55
Thorpe Caliper	54
Camera	
Sontec proCam 4K Micro Camera System	782
Cannula	
Egress Cannula Set	622, 623
Inflow Cannula Set	621
Small Joint Arthroscopic Cannula	624
Carpentier Vascular Hook Titanium	183
Carrier	
Eyebrow Lifting Ligature Carrier	165
Facia Ligature Carrier	165
Sanders Brown Ligature Carrier	165
Carroll Tendon Pulling Forceps	95
Caspar Blade Removal Forceps	217
Caspar Blunt Smooth Blade	216
Caspar Cervical Vertebral Column Quick Release Retractor Frame	218
Caspar Cervical Vertebral Column Retractor Frame	214
Caspar Cervical Vertebral Retractor Frame	210
Caspar Counter Retractor	223
Caspar Distractor Vertebral Retractor	220

Caspar Drill Guide . . . . .	221
Caspar Grasping Rongeur . . . . .	712
Caspar Hand Universal Retractor . . . . .	217
Caspar Lumbar Speculum . . . . .	222
Caspar MIS Cervical Vertebral Column Re- tractor Frame . . . . .	213
Caspar Nerve-Root Retractor . . . . .	227
Caspar Screwdriver . . . . .	222
Caspar Screw Post . . . . .	222
Caspar Serrated Lateral Blade . . . . .	215, 223
Caspar System Complete Set . . . . .	233
Caspar Twist Drill . . . . .	222
Caspar V-Blunt Blade . . . . .	215
Cassio Ligature Carrier . . . . .	162
Castroviejo Body Caliper . . . . .	53
Castroviejo Caliper . . . . .	52, 53
Cast Spreader Henning Cast Spreader . . . . .	523
Catheter Tray & Dome Lid Cover . . . . .	24
Cerclage Double Torpedo Type Wire Twister. 593	
Cerclage Torpedo Type Wire Twister . . . . .	591
Charnley Curette . . . . .	532
Charnley Initial Incision Retractor . . . . .	460
Chisel Hibbs Chisel . . . . .	386
Sontec Chisel . . . . .	387
Chondro Pick . . . . .	620
Chuck Collett Chuck for Knife Handle . . . . .	48
Sontec Hybrid I.M. Pin Chuck . . . . .	504
Sontec I.M. Pin Chuck . . . . .	504
Sontec Keyless I.M. Pin Drill Chuck . . . . .	505
Chuck Handle Beaver Blade Chuck Handle #3K . . . . .	45
Beaver Blade Chuck Handle #3KD . . . . .	46
Chuck Knife Handle #3HL . . . . .	45
Cicherelli Rongeur . . . . .	747
Clamp . . . . .	338
AO-Type Bone Reduction Clamp . . . . .	339
Babcock Bone Holding Clamp . . . . .	328
Bishop Bone Clamp . . . . .	332
Bone Reduction Clamp . . . . .	353
Bone Reduction K-Wire Guide Clamp . . . . .	342
DeBakey Meniscus Clamp . . . . .	362
Doolen Bone Holding Clamp . . . . .	331
Ikuta Bone Clamp . . . . .	350
Kristol Manus Bone Reduction Clamp . . . . .	342
KUV Richards Bone Clamp . . . . .	331
Locke Bone Reduction Clamp . . . . .	343
Mini Doolen Bone Holding Clamp . . . . .	328
Patella 2 x 2 Prong Bone Clamp . . . . .	332
Sontec Delicate Meniscus Clamp . . . . .	361
Sontec Meniscus Clamp . . . . .	360
Sontec Mesh Meniscus Clamp . . . . .	362
Verbrugge Reverse Jaw Bone Clamp . . . . .	320
Classic Lempert Rongeur . . . . .	745
Cleaner Endozime AW Triple Plus . . . . .	40
F*A*C*T*S . . . . .	41
Premixslip . . . . .	40
Prepzyme . . . . .	41
Surgistain . . . . .	40
Cleveland Rongeur . . . . .	747
Cloward Cervical Retractor . . . . .	228, 229
Cloward Depth Gauge . . . . .	520
Cloward Dura Hook . . . . .	186
Cloward Lamina Spreader . . . . .	486
Cloward Vertebral Cervical Spreader Retrac-	

tor . . . . .	486
Coaptation Bipolar Forceps . . . . .	145
Cobb Spinal Curette . . . . .	547
Cobb Spinal Elevator . . . . .	200, 201
Cobb Spinal Elevator with Unique Handle . . . . .	202
Cobb Type Spinal Gouge . . . . .	384
Collett Chuck for Knife Handle . . . . .	48
Collin Lucae Mallet . . . . .	408
Combination Bone Rasp . . . . .	767
Compressor Double-Action Compressor . . . . .	281
Spinal Compressor . . . . .	280, 281
Spinal Distractor/Compressor . . . . .	279
Concave Nail Nipper . . . . .	663
Cone Ring Curette . . . . .	370
Cone Ring Two Handed Curette . . . . .	536, 537
Cooley Vascular Tissue Forceps . . . . .	106
Cord Disposable Bipolar Cord . . . . .	143
CORD-1001 . . . . .	143
CORD-2000 . . . . .	143
Cottle Lower Antrum Forceps . . . . .	157
Cottle Mallet . . . . .	407
Cottle Plastic Osteotome . . . . .	396
Councilman Bone Cutter . . . . .	657
Countersink Bit Cannulated . . . . .	513
Coupland Suction Set . . . . .	314
Coupling Drill Bit Quick Coupling . . . . .	513
Cover Stainless Steel Instrument Tray, Lid Cover & Perforated Nesting Sterilization Instrument Tray . . . . .	24
Tip Cover . . . . .	36
Covers Catheter Tray & Dome Lid Cover . . . . .	24
Stainless Steel Instrument Tray & Lid Cover . . . . .	25, 26
CSU Kloop Neuro Spatula . . . . .	237
CSU Meniscus Clamp . . . . .	359
Culler Neuro Round Handle Hook . . . . .	180
Culler Neuro Round Handle Hook Titanium . . . . .	181
Cup Iodine Cup . . . . .	29
Medicine Cup . . . . .	31
Curette Anterior Spinal Curette . . . . .	546
Arthroscopic Curette & Ring Curette . . . . .	617
Bayonet Curette Titanium . . . . .	530
Bayonet Ring Curette Titanium . . . . .	531
Bruns Hexagonal Handle Curette . . . . .	369
Bruns Oval Cup Curette . . . . .	367, 368
Bruns Ring Curette . . . . .	371
Bruns Round Cup Curette . . . . .	366
Bruns Solid Hexagonal Curette . . . . .	369
Charnley Curette . . . . .	532
Cobb Spinal Curette . . . . .	547
Cone Ring Curette . . . . .	370
Cone Ring Two Handed Curette . . . . .	536, 537
Down Pushing Curette . . . . .	532
Extra Long Spinal Curette . . . . .	534
Hatt Spoon Curette . . . . .	370
Jansen Curette . . . . .	371
Lampert Curette . . . . .	530

Long Handle Curette . . . . .	540
Micro Axial Bayonet Extra Long Curette . . . . .	545
Micro Axial Bayonet Long Curette . . . . .	544
Micro Axial Bayonet Regular Length Cu- rette . . . . .	543
Micro Spinal Curette . . . . .	542
Neuro Ring Curette . . . . .	531
O'Brien Curette . . . . .	532
Rhoton Curette . . . . .	256
Spinal Curette . . . . .	534
Spinal Fusion Curette . . . . .	546
Stille Curette . . . . .	366
Tear Drop Curette . . . . .	539
Tear Drop Spinal Curette . . . . .	533
Two Handed Curette . . . . .	538, 539
Two Handed Large Grip Curette . . . . .	541
USA Curette . . . . .	535
USA Ring Curette . . . . .	535
Volkman Curette . . . . .	371
Cushing Bayonet Bipolar Forceps . . . . .	140
Cushing Bayonet Forceps . . . . .	157
Cushing Bipolar Forceps . . . . .	145
Cushing Brain Depressor Spatula . . . . .	237
Cushing Dressing Bayonet Forceps . . . . .	157
Cushing Dura Hook . . . . .	186
Cushing Forceps Titanium . . . . .	116
Cushing Pituitary Rongeur . . . . .	708, 711
Cushing Rongeur . . . . .	752
Cushing Tying Forceps . . . . .	116
Cutter Large Pin / Bolt Cutter . . . . .	574
Micro Double Action Wire Cutter . . . . .	573
Rod Cutter . . . . .	578
Rod Flush Cutter . . . . .	579
Table Top Rod Cutter . . . . .	583
Cutters Councilman Bone Cutter . . . . .	657
Plate Cutter for Titanium Plates . . . . .	568
Stille-Horsley Bone Cutter . . . . .	660
Cylindrical Osteotome Shepard Cylindrical Osteotome . . . . .	552
<b>D</b> Dandy Nerve Hook . . . . .	184
Daniel Nasal Awl . . . . .	522
Davis Brain Black Silicone Spatula . . . . .	240
Davis Brain Spatula . . . . .	239, 241
Davis Stifle Retractor . . . . .	454
DeBakey-Adson Tissue Forceps . . . . .	127
DeBakey Angled Tissue Forceps . . . . .	103
DeBakey Bayonet Forceps . . . . .	153
DeBakey Ergonomic-Handle Forceps . . . . .	105
DeBakey Ergonomic-Handle Forceps Tita- nium . . . . .	105
DeBakey Forceps Titanium . . . . .	98
DeBakey Meniscus Clamp . . . . .	362
DeBakey Mosquito Forceps . . . . .	363
DeBakey Needle-Pulling Tissue Forceps. 103	
DeBakey Needle Pulling Tissue Forceps Titanium . . . . .	98
DeBakey Premier Knurled Handle Forceps Titanium . . . . .	99
DeBakey Thoracic Forceps . . . . .	104
DeBakey Tissue Forceps . . . . .	102
DeBakey Tissue Forceps Titanium . . . . .	100
DeBakey Vascular Forceps . . . . .	101

DeBakey Vascular Forceps Titanium . . . . .	98
Decker Micro Rongeur . . . . .	719
Defourmental Rongeur . . . . .	750
Deluxe Bone Reduction Clamp . . . . .	347
Depressor Cushing Brain Depressor Spatula . . . . .	237
Depth Gauge . . . . .	518
Depth Gauge EZ Clean . . . . .	519
Deschamps Ligature Carrier . . . . .	164
Dietrich-DeBakey Tissue Forceps . . . . .	101
Dilation Needle . . . . .	624
Disposable Bipolar Cord . . . . .	143
Dissector Lemmon Dissector . . . . .	195
Ochsner-Sontec Straight Dissector . . . . .	194
Olivecrona Dissector . . . . .	195
Rhoton Circular Dissector 45° . . . . .	254
Rhoton Dissector / Raspatory . . . . .	254, 255
Titanium Sontec Dissector . . . . .	195
Yasargil Dissector Raspatory Titanium . . . . .	194
Dissectors Ochsner Dissector . . . . .	194
Distractor Double-Action Distractor . . . . .	281
Foreman Kwire Distractor . . . . .	451, 452
Mini Foreman Distractor . . . . .	453
Spinal Distractor . . . . .	279, 280
Spinal Distractor/Compressor . . . . .	279
Distractor, Foreman Kwire . . . . .	451, 452
Doolen Bone Holding Clamp . . . . .	330, 331
Doolen Neuro Hook . . . . .	178
Double-Action Compressor . . . . .	281
Double-Action Distractor . . . . .	281
Double Action Wire Cutter . . . . .	573, 576
Double Drill Guide . . . . .	514
Double-Ended Rasp . . . . .	756
Down Pushing Curette . . . . .	532
Dressing Jar . . . . .	31
Drill Caspar Twist Drill . . . . .	222
Micro Tap/ Drill Sleeve . . . . .	512
Tap/ Drill Sleeve . . . . .	512
Tap Sleeve & Insert Drill Sleeve Set . . . . .	511
Drill Bit Quick Coupling . . . . .	513
Drill Guide 3 / 1 Drill Guide . . . . .	511
Caspar Drill Guide . . . . .	221
Double Drill Guide . . . . .	514
Parallel Drill Guide . . . . .	514
Taylor Drill Guide . . . . .	512
Universal Drill Guide . . . . .	510
Drill Guides Valkyrie Mach Holder / Drill Guide . . . . .	515
Driver K-Wire Pin Driver . . . . .	510
Piermattei Pin Bender / Driver . . . . .	426
Vickers Easy Driver / Bender / Puller . . . . .	422
Duckbill Ear Alligator Forceps . . . . .	65
Duehrssen Tissue Forceps . . . . .	124
Durrani Dorsal Vein Complex Ligation Needle . . . . .	162
<b>E</b> Echlin Duckbill Rongeur . . . . .	731
Egress Cannula Set . . . . .	622, 623

Electro Blue Coated Cushing Bayonet Tissue Forceps . . . . .	158
Electro Blue Coated DeBakey Forceps . . . . .	105
Electro Blue Coated Potts-Smith Tissue Forceps . . . . .	114
Electro Blue Coated Skinner Tissue Forceps . . . . .	118
Elevator Adson Periosteal Elevator . . . . .	376
Cobb Spinal Elevator . . . . .	200, 201
Cobb Spinal Elevator with Unique Handle . . . . .	202
Freer/Pennington Extra Long Spinal Eleva- tor . . . . .	203
Freer Periosteal Elevator . . . . .	374, 375, 376
Hoen Periosteal Elevator . . . . .	377
Joker Periosteal Elevator . . . . .	379
Key Periosteal Elevator . . . . .	378
Lane Periosteal Elevator . . . . .	377
Langenbeck Periosteal Elevator . . . . .	377
Love Adson Periosteal Elevator . . . . .	376
McIlwraith Periosteal Elevator . . . . .	378
Nelms Suction Elevator . . . . .	200
Piermattei Shoulder Elevator . . . . .	379
Sayre Elevator . . . . .	379
Sedillot Elevator . . . . .	379
Sontec A O Type Elevator / Raspatory . . . . . .	380, 381
Sontec Lane Lever Elevator . . . . .	477
Williger Periosteal Elevator . . . . .	379
Yasargil Bayonet Elevator Titanium . . . . .	200
Elevators Foerner Sesamoid Knife Elevator . . . . .	417
Emesis Basin . . . . .	27
End Cutter Pin End Cutter . . . . .	577
Endozime AW Triple Plus® . . . . .	40
End Pin Cutter . . . . .	570
Entner Ligature Carrier . . . . .	164
Ethmoid Pediatric Rongeur . . . . .	700
Evans Tissue Forceps . . . . .	110
Extensions Sontec I.M. Pin Chuck Extensions . . . . .	507
Extra . . . . .	534
Eyebrow Lifting Ligature Carrier . . . . .	165
<b>F</b> Facia Ligature Carrier . . . . .	165
F*A*C*T*S® . . . . .	41
Feline Nail Cutters . . . . .	665
Femoral Head Disarticulator Knife . . . . .	416
Ferlit Micro Forceps . . . . .	122
Ferris-Smith Arthroscopic Rongeur. 713, 714, 715	
Ferris-Smith Arthroscopic Rongeur Bayonet. 718	
Ferris-Smith Arthroscopic Ultra-Low Profile Rongeur with Enhanced Jaw Power. 717	
Ferris Smith Rod Holder . . . . .	490
Ferris-Smith Rongeur . . . . .	716
Ferris-Smith Spinal Extended Shaft Rongeur . . . . .	717
Ferris-Smith Tissue Forceps . . . . .	119
Ferris-Smith Wilde Rongeur . . . . .	716
File Long Handle File . . . . .	260, 775
Sontec Spinal File/Rasp . . . . .	774
Finger Goniometer . . . . .	53
Finsen Self-Retaining Retractor . . . . .	459
Flush Cut Pin Cutter . . . . .	580
Foerner Sesamoid Knife Elevator . . . . .	417
Foman Rasp . . . . .	759
Foman "R" Rasp . . . . .	760
Foman TC Insert Rasp . . . . .	757
Foman TC Insert Rasp Angled . . . . .	758
Fomon Rasp . . . . .	757
Forcep Side Biting Alligator . . . . .	63
Forceps . . . . .	603
Adson Bipolar Forceps . . . . .	138
Adson-Derlacki Forceps . . . . .	133
Adson Dressing Cross-Serrated Forceps . . . . .	133
Adson Dressing Serrated Forceps . . . . .	131
Adson Dressing TC Dust Forceps . . . . .	132
Adson Dressing TC Serrated Platform Forceps . . . . .	132
Adson Forceps with Skin Hook . . . . .	134
Adson Harris Ring Tip Forceps . . . . .	136
Adson-Harris Ring Tip Forceps Titanium . . . . .	127
Adson Helms Forceps . . . . .	133
Adson Tissue Cross Serrated Forceps . . . . .	131
Adson Tissue Forceps . . . . .	128
Adson Tissue Forceps Titanium . . . . .	126, 127
Adson Tissue Smooth Platform Forceps . . . . .	129
Adson Tissue TC Serrated Platform For- ceps . . . . .	130
Alligator Forceps . . . . .	63
Alligator Forceps Tubular Shaft . . . . .	62
Alligator Forceps with Malleable Shaft . . . . .	66
Arthroscopic Biopsy Grasping Forceps . . . . .	608, 609
Arthroscopic Crocodile Grasping Forceps . . . . .	648
Arthroscopic, Forceps, Biopsy & Grasping Rongeur Forceps . . . . .	603
Arthroscopic Grasping & Biopsy Combo Rongeur Forceps . . . . .	75
Arthroscopic Grasping Forceps . . . . .	606, 607
Arthroscopic Rottweiler Loosebody Grasp- ing Forceps . . . . .	649
Arthroscopic Velociraptor Biopsy Forceps . . . . .	651
Arthroscopic Velociraptor Junior Biopsy Forceps . . . . .	651
Bayonet Bipolar Forceps . . . . .	141
Bayonet Forceps . . . . .	155
Beasley-Babcock Tissue Forceps . . . . .	129
Bipolar Bayonet Suction Wide Grip For- ceps . . . . .	147
Bipolar Bayonet Wide Grip Forceps . . . . .	146
Bone Holding Forceps . . . . .	347
Bonney Tissue Forceps . . . . .	123
Brolhi-Adson Forceps . . . . .	134
Brown-Adson Cooley Forceps . . . . .	135
Brown-Adson Tissue Forceps . . . . .	135
Brown Adson Tissue Forceps Titanium . . . . .	134
Brown-Cushing Bayonet Forceps . . . . .	158

Brown Forceps . . . . .	136
Brown Tissue Forceps . . . . .	109
Carroll Tendon Pulling Forceps . . . . .	95
Caspar Blade Removal Forceps . . . . .	217
Coaptation Bipolar Forceps . . . . .	145
Cooley Vascular Tissue Forceps . . . . .	106
Cottle Lower Antrum Forceps . . . . .	157
Cushing Bayonet Bipolar Forceps . . . . .	140
Cushing Bayonet Forceps . . . . .	157
Cushing Bipolar Forceps . . . . .	145
Cushing Dressing Bayonet Forceps . . . . .	157
Cushing Forceps Titanium . . . . .	116
Cushing Tying Forceps . . . . .	116
DeBakey-Adson Tissue Forceps . . . . .	127
DeBakey Angled Tissue Forceps . . . . .	103
DeBakey Bayonet Forceps . . . . .	153
DeBakey Ergonomic-Handle Forceps . . . . .	105
DeBakey Ergonomic-Handle Forceps Titanium . . . . .	105
DeBakey Forceps Titanium . . . . .	98
Debakey Mosquito Forceps . . . . .	363
DeBakey Needle-Pulling Tissue Forceps . . . . .	103
DeBakey Needle Pulling Tissue Forceps Titanium . . . . .	98
DeBakey Premier Knurled Handle Forceps Titanium . . . . .	99
DeBakey Thoracic Forceps . . . . .	104
DeBakey Tissue Forceps . . . . .	102
DeBakey Tissue Forceps Titanium . . . . .	100
DeBakey Vascular Forceps . . . . .	101
DeBakey Vascular Forceps Titanium . . . . .	98
Dietrich-DeBakey Tissue Forceps . . . . .	101
Duckbill Ear Alligator Forceps . . . . .	65
Duehrssen Tissue Forceps . . . . .	124
Electro Blue Coated Cushing Bayonet Tissue Forceps . . . . .	158
Electro Blue Coated DeBakey Forceps . . . . .	105
Electro Blue Coated Potts-Smith Tissue Forceps . . . . .	114
Electro Blue Coated Skinner Tissue Forceps . . . . .	118
Evans Tissue Forceps . . . . .	110
Ferlit Micro Forceps . . . . .	122
Ferris-Smith Tissue Forceps . . . . .	119
Foreign Body Removal / Grasping Forceps . . . . .	85
Fraenkel Laryngeal Forceps . . . . .	87
Frontal Sinus Giraffe Forceps . . . . .	78, 79, 80, 81, 82, 83, 84
Gerald Bayonet Bipolar Forceps . . . . .	141
Gerald Bayonet Forceps . . . . .	153
Gerald Brown Tissue Forceps . . . . .	106
Gerald Lightweight Micro Tissue Forceps Titanium . . . . .	107
Gerald Tissue Forceps . . . . .	106, 108
Gillies Forceps . . . . .	124
Goodhill Alligator Forceps . . . . .	66
Goodhill Ear Forceps . . . . .	71
Gorney-Adson Forceps . . . . .	127
Greven Alligator Forceps . . . . .	65
Grevenwald (Jansen) Ear Forceps . . . . .	159
Hardy Bayonet Bipolar Forceps . . . . .	141, 145
Hardy Bayonet Coagulation Forceps . . . . .	143
Harris Ring Tip Forceps . . . . .	137
Hartman Alligator Forceps . . . . .	61,

72	
Hartman Ear Forceps . . . . .	93
Hartmann Ear Alligator Forceps . . . . .	90
Hartmann-Nasal Alligator Forceps . . . . .	89
Hartmann-Noyes Alligator Forceps . . . . .	74
Heymann Septum Alligator Forceps . . . . .	89
Hypophyseal Bayonet Forceps . . . . .	156
Jackson / Biopsy Forceps . . . . .	88
Jacobson Micro Bayonet Forceps . . . . .	156
Jansen Bayonet Ear Forceps Titanium . . . . .	159
Jansen Bipolar Forceps . . . . .	144
Jensen Bipolar Bayonet Irrigation Forceps . . . . .	144
Jewelers Bipolar Forceps . . . . .	138, 139
Jewelers-McPherson Bipolar Forceps . . . . .	139
Jurasz Laryngeal Forceps . . . . .	86
Liston Bone Cutting Forceps . . . . .	656
Long Tissue Forceps . . . . .	125
Lucae Ear Forceps . . . . .	155
McGravey Tissue Forceps . . . . .	109
McIndoe Bone Cutting Forceps . . . . .	658
McIndoe Dressing and Tissue Forceps . . . . .	121
McIndoe Forceps Titanium . . . . .	121
McPherson Bipolar Forceps . . . . .	139
Meniscus Grasping Forceps . . . . .	613
Micro Alligator Grasping Forceps . . . . .	71
Micro Bayonet Forceps . . . . .	154
Micro Biopsy Forceps with Flexible Tubular Shaft . . . . .	74
Micro Ear Alligator Forceps . . . . .	68, 69, 70
Micro Gerald Tissue Forceps . . . . .	109
Micro House Alligator Forceps . . . . .	64
Micro House Biopsy Alligator Forceps . . . . .	73
Micro Round Handle 6" Forceps Titanium . . . . .	172
Micro Round Handle Forceps Titanium . . . . .	173
Micro Sontec Alligator Forceps . . . . .	67, 72
Micro Straight Round Handle Forceps Titanium . . . . .	174
Micro Tying Forceps . . . . .	99
Micro Tying Forceps Titanium . . . . .	99
Nadler Coaptation Bipolar Forceps . . . . .	140
Oehler Forceps . . . . .	119
Original DeBakey Forceps . . . . .	101
Potts Cooley Tissue Forceps . . . . .	114
Potts Nevins Forceps . . . . .	115
Potts-Smith Dressing Forceps . . . . .	115
Potts Smith Tissue Forceps . . . . .	113
Potts-Smith Tissue Forceps . . . . .	115
Raleigh Bone Holding Forceps . . . . .	345
Reil Bone Holding Forceps . . . . .	340
Resano Brown Vascular Forceps . . . . .	111
Resano Brown Vascular Forceps Titanium . . . . .	112
Resano Double Action Vascular Forceps Titanium . . . . .	112
Reul Coronary Artery Forceps . . . . .	115
Rottweiler Junior Loosebody Grasping Forceps . . . . .	650
Ruskin-Liston Bone Cutting Forceps . . . . .	656
Russian Adson Micro Forceps . . . . .	137
Russian Tissue Forceps . . . . .	109
Scoville Bayonet Bipolar Forceps . . . . .	143
Scoville Bipolar Forceps . . . . .	144

Screw Holding Forceps . . . . .	501
Selman Tissue Forceps . . . . .	110
Semken Forceps . . . . .	118
Sheen Fragment Retriever Forceps . . . . .	707
Side Biting Alligator Forceps . . . . .	63
Silver Ear Dressing Alligator Forceps . . . . .	91
Singley Tuttle Forceps . . . . .	110
Skinner Tissue Forceps . . . . .	117
Sontec Alligator Forceps . . . . .	60, 62
Sontec D'Errico Tissue Forceps . . . . .	109
Sontec Forceps Holder . . . . .	34
Sontec Micro Alligator Forceps . . . . .	61
Sontec Micro Biopsy Forceps . . . . .	87
Sontec Septal Platform Forceps . . . . .	94
Sontec Septal Platform Forceps Titanium . . . . .	94
Stefan Mini Bone Holding Forceps . . . . .	324
Stille-Adson Dressing Forceps . . . . .	136
Stille-Adson Tissue Forceps . . . . .	136
Stille-Liston Bone Cutting Forceps . . . . .	657
Tenzel Bipolar Forceps . . . . .	139
Thumb Dressing Forceps . . . . .	122
Thumb Forceps Titanium . . . . .	117
Tissue Bipolar Forceps . . . . .	145
Tissue Forceps with TC Inserts . . . . .	117
Tissue Forceps with Teeth . . . . .	120
Titanium Bayonet Bipolar Forceps . . . . .	143
Tobey Ear Dressing Forceps . . . . .	92
Troutman Micro Hook Forceps . . . . .	126
Wangensteen Tissue Forceps . . . . .	110
Wilde Ear Forceps . . . . .	155
Yasargil Atrauma Forceps . . . . .	155
Yasargil Bayonet Bipolar Forceps . . . . .	142
Yasargil Bayonet Forceps Titanium . . . . .	152
Yasargil Forceps Titanium . . . . .	148, 149
Yasargil Micro Bayonet Forceps . . . . .	154
Yasargil Micro Forceps Titanium . . . . .	150, 153
Yasargil Tumor Bayonet Forceps . . . . .	154
Yasargil Tumor Grasping Bayonet Forceps . . . . .	156
Yasargil Tumor Grasping Bayonet Forceps Titanium . . . . .	152
Yasargil Tumor Grasping Forceps Titanium . . . . .	151
Foreign Body Removal / Grasping Forceps . . . . .	85
Fraenkel Laryngeal Forceps . . . . .	87
Frame	
Caspar MIS Cervical Vertebral Column Retractor Frame . . . . .	213
Frazier Angled Suction . . . . .	286, 287, 288, 289
Frazier Dorsey Dura Separator . . . . .	178
Frazier Insulated Suction . . . . .	291
Frazier Lamina Retractor . . . . .	275
Frazier-Rhoton Angled Suction . . . . .	292
Frazier Straight Suction . . . . .	290
Freer/Pennington Extra Long Spinal Elevator . . . . .	203
Freer Periosteal Elevator . . . . .	374, 375, 376
Frontal Sinus Giraffe Forceps . . . . .	78, 79, 80, 81, 82, 83, 84
Frontal Sinus Giraffe Punch . . . . .	77
Fukushima Suction . . . . .	294, 295

**G**

Gallaher Bone Rasp Set . . . . .	768
Galt Trephine . . . . .	551
Gauge	
Cloward Depth Gauge . . . . .	520
Depth Gauge . . . . .	518
Depth Gauge EZ Clean . . . . .	519
Measuring Gauge . . . . .	513
Mini Depth Gauge . . . . .	520
Stahl A/C Lens Gauge . . . . .	55
TPLO Double-Ended Gauge . . . . .	57
Gelpi	
Gelpi Offset Arm Left & Right . . . . .	449
Gelpi 1st Generation Deep Angle Retractor . . . . .	448
Gelpi Classic Retractor . . . . .	444, 445
Gelpi Deep Angle Neroma (Crossover) Retractor . . . . .	443
Gelpi Deep Angle Retractor . . . . .	440
Gelpi Neroma (Crossover) Retractor . . . . .	442
Gelpi Offset Arm Left & Right . . . . .	449
Gelpi Original Spinal Retractor . . . . .	264
Gelpi Retractor . . . . .	441, 446, 447, 450
Gelpi Retractor Titanium . . . . .	265
Gelpi Spinal Retractor . . . . .	265, 266, 267, 275
Gerald Bayonet Bipolar Forceps . . . . .	141
Gerald Bayonet Forceps . . . . .	153
Gerald Brown Tissue Forceps . . . . .	106
Gerald Lightweight Micro Tissue Forceps Titanium . . . . .	107
Gerald Tissue Forceps . . . . .	106, 108
Gersten Traction Bar . . . . .	334
Gillies Forceps . . . . .	124
Glabella Masing Rasp . . . . .	770
GOLD-CUT HERCULES Front & Side Pin Cutter . . . . .	582
GOLD-CUT HERCULES Pin Cutter . . . . .	571
Goniometer	
Finger Goniometer . . . . .	53
Good Bone Rasp . . . . .	768
Goodhill Alligator Forceps . . . . .	66
Goodhill Ear Forceps . . . . .	71
Gorney-Adson Forceps . . . . .	127
Gouge	
Cobb Type Spinal Gouge . . . . .	384
Hibbs Gouge . . . . .	386
Lexer Gouge . . . . .	385
Mini Lexer Gouge . . . . .	385
Sontec Micro Gouge . . . . .	384
Graft Passer Ligature Carrier . . . . .	163
Graham Dura Hook . . . . .	187
Grasper	
Arthroscopic Mini Grasper . . . . .	612
Greven Alligator Forceps . . . . .	65
Gruenwald (Jansen) Ear Forceps . . . . .	159
Gubisch Surgical Pen Replacement Tip . . . . .	49
Gubish Surgical Pen Holder Set . . . . .	48

**H**

Hakansson Rongeur . . . . .	743
Handle	
Kerrison Universal Rotating 360° Rongeur Handle . . . . .	672
Self-Locking 3K Chuck Blade Handle . . . . .	49
Sontec I.M. Pin Chuck Aluminum Handle . . . . .	505
Sontec I.M. Pin Chuck T-Handle . . . . .	506
Sontec Knife Handle #3XXL . . . . .	45
Staley Round Knurled Knife Handle . . . . .	45

Universal Adjustable Angle Knife Handle #3 . . . . .	44
Wide Barrel Grip Knife Handle #3 . . . . .	44
Handles	
Chuck Knife Handle #3HL . . . . .	45
Hand Surgery Osteotome . . . . .	394
Hardt Micro Cartilage Osteotome Set (with bag) . . . . .	398
Hardt Micro Cartilage Osteotome Set (with tray) . . . . .	398
Hardt Micro Ceramitec Osteotome . . . . .	400
Hardy Bayonet Bipolar Forceps . . . . .	141, 145
Hardy Bayonet Coagulation Forceps . . . . .	143
Harris Ring Tip Forceps . . . . .	137
Hartman Alligator Forceps . . . . .	61, 72
Hartman Ear Forceps . . . . .	93
Hartmann Ear Alligator Forceps . . . . .	90
Hartmann Nasal Alligator Forceps . . . . .	89
Hartmann-Noyes Alligator Forceps . . . . .	74
Hartman Rongeur . . . . .	751
Hatt Spoon Curette . . . . .	370
Headlight	
Sontec Elite Wireless LED Headlight . . . . .	778, 779
Sontec LED Plus+ Headlight . . . . .	780
Sontec Magnum LED Headlight . . . . .	781
Heartline Nerve & Vessel Hook . . . . .	183
Heartline Ross Sump Sucker . . . . .	311
Heartline Ross Ventricular Vent . . . . .	311
Heavy Nail Nipper . . . . .	662
Heavyweight Mallet . . . . .	410
Henning Cast Spreader . . . . .	523
Herbst-Doolen Wire Passer . . . . .	564
Herbst Wire Passer . . . . .	564
HERCULES GRIP Pin Puller . . . . .	428
Hess Nerve Retractor . . . . .	250
Hexagonal Screw Driver . . . . .	498
Heyman Septum Alligator Forceps . . . . .	89
Hibbs Bone Chip Packer . . . . .	525
Hibbs Chisel . . . . .	386
Hibbs Gouge . . . . .	386
Hibbs Osteotome . . . . .	392
Hibbs Retractor . . . . .	464
Hip & Knee Retractor . . . . .	478
Hip Reduction Clamp . . . . .	355
HL MIS Retractor Frame Medium . . . . .	214
Hoen Grasping Forceps . . . . .	718
Hoen Periosteal Elevator . . . . .	377
Hohman Elevator Retractor . . . . .	476
Hoke Osteotome . . . . .	395
Holder	
Bunt Forceps Holder Ring . . . . .	35
Ferris Smith Rod Holder . . . . .	490
Holding Device	
Pashley Pipe Suction Tube Holding Device . . . . .	315
Hook . . . . .	599, 614
Arthroscopic Hook Probe . . . . .	618
Bayonet Nerve Hook . . . . .	183
Bayonet Nerve Hook Titanium . . . . .	184
Carpentier Vascular Hook Titanium . . . . .	183
Cloward Dura Hook . . . . .	186
Culler Neuro Round Handle Hook . . . . .	180
Culler Neuro Round Handle Hook Titanium . . . . .	181
Cushing Dura Hook . . . . .	186
Dandy Nerve Hook . . . . .	184
Doolen Neuro Hook . . . . .	178
Graham Dura Hook . . . . .	187

Heartline Nerve & Vessel Hook . . . . .	183
Jacobson Hook . . . . .	255
Krayenbuehl Nerve Hook . . . . .	178
Krayenbuehl Nerve Hook Extra Long Version . . . . .	178
Krayenbuehl Nerve Hook Titanium . . . . .	182
Lucae Ear Hook . . . . .	184
McIlwraith Arthroscopic Hook Probe . . . . .	619
Micro Hook Titanium . . . . .	187
Nerve Hook Titanium . . . . .	186
Rhoton Hook . . . . .	256
Sontec Nerve Hook Titanium . . . . .	182
Taylor Micro Arthroscopic Hook Probe & Pick . . . . .	619
Triangle Handle Arthroscopic Menisectomy, Hook, Probe & Knife . . . . .	614
Wagner Hook . . . . .	186
Yasargil Galea Spring Neuro Hook . . . . .	187
Hook Punch . . . . .	611
Hooks . . . . .	614
Nerve & Vessel Hook Titanium . . . . .	182
Taylor Micro Arthroscopic Hook Probe . . . . .	619
House-Baron Suction . . . . .	304
House Cutoff Suction Adapter . . . . .	303
House Ear Caliper . . . . .	55
House Irrigator/Suction . . . . .	305
Howard Bone Rasp Double-Ended Single-Side . . . . .	760
Hybrid Herbst Wire Passer . . . . .	563
Hypophyseal Bayonet Forceps . . . . .	156
Ikuta Bone Clamp . . . . .	350
Inflow Cannula Set . . . . .	621
Inge Lamina Retractor . . . . .	487
Inge Lamina Spreader . . . . .	482, 483
Inge Lamina Spreader Extra Large Retractor . . . . .	484
Inge Micro Ring Handle Lamina Spreader . . . . .	485
Inge Neroma Retractor . . . . .	455
Ingrown Nail Forcep . . . . .	663
Ingrown Nail Splitting Scissors . . . . .	664
Instrument Tray . . . . .	27
Iodine Cup . . . . .	29
Irrigator	
House Irrigator/Suction . . . . .	305
Jackson / Biopsy Forceps . . . . .	88
Jacobson Button End Hook Probe . . . . .	257
Jacobson Button End Probe . . . . .	256
Jacobson Hook . . . . .	255
Jacobson Hook Probe . . . . .	257
Jacobson Micro Bayonet Forceps . . . . .	156
Jacobson Raspatory/Probe Set . . . . .	191
Jameson Caliper . . . . .	54
Jansen Bayonet Ear Forceps Titanium . . . . .	159
Jansen Bipolar Forceps . . . . .	144
Jansen Curette . . . . .	371
Jar	
Dressing Jar . . . . .	31
Jensen Bipolar Bayonet Irrigation Forceps . . . . .	144
Jet Wire Twister . . . . .	593
Jeurs Lempert Neuro Rongeur . . . . .	746
Jewelers Bipolar Forceps . . . . .	138, 139

Jewelers-McPherson Bipolar Forceps . 139  
 Joker Periosteal Elevator . . . . . 379  
 JPS Bone File . . . . . 261, 775  
 Jurasz Laryngeal Forceps. . . . . 86

**K**

Kelly Retractor . . . . . 472  
 Kern Bone Clamp . . . . . 323  
 Kern Hybrid Bone Clamp . . . . . 322  
 Kerrison  
 Kerrison 40° Rongeur Titanium . . . . . 688  
 Kerrison 40° Laminectomy/Lumbar . 678  
 Kerrison 40° Rongeur . . . . . 675, 679, 683  
 Kerrison 40° Rongeur Titanium . . . . . 688  
 Kerrison 90° Rongeur . . . . . 676, 680  
 Kerrison 90° Rongeur . . . . . 677  
 Kerrison Bayonet 40° Rongeur . 684, 685  
 Kerrison Bayonet Foraminotomy Rongeur . 686  
 Kerrison Convertible 40° Rongeur . . . . . 687  
 Kerrison Punch (Ocular-plasti) 40° Rongeur . 691  
 Kerrison Punch (Ocular-plasti) 90° Rongeur . 690  
 Kerrison Universal Rotating 360° Rongeur . 669, 670, 671  
 Kerrison Universal Rotating 360° Rongeur Handle . . . . . 672  
 Key Periosteal Elevator . . . . . 378  
 Killion (Von Eicken) Suction . . . . . 313  
 Kistler Ear Cartilage Rasp . . . . . 770  
 Kleinert-Kutz Duckbill Synovectomy Rongeur . 725  
 Kleinert-Kutz Rongeur . . . . . 741  
 Knife  
 Arthroscopic Meniscomotomes Hook, Probe & Knife . . . . . 615, 616  
 Braake Tendon Knife . . . . . 419  
 Femoral Head Disarticulator Knife. . . . . 416  
 Nixon XXL Banana Knife . . . . . 419  
 Rosin Root Meniscomotome . . . . . 418  
 Smillie Meniscus . . . . . 418  
 Triangle Handle Arthroscopic Meniscomotome, Hook, Probe & Knife . . . . . 614  
 Knife Handle  
 Bayonet Spinal Knife Handle. . . . . 49  
 Knife Handle #3. . . . . 44  
 Knife Handle #3KL . . . . . 45  
 Knife Handle #3L. . . . . 45  
 Knife Handle #4. . . . . 46  
 Knife Handle #4L. . . . . 47  
 Knife Handle #7. . . . . 47  
 Knife Handle #9. . . . . 48  
 Siegel Knife Handle . . . . . 48  
 Knife Handle #3 . . . . . 44  
 Knife Handle #3KL . . . . . 45  
 Knife Handle #3L . . . . . 45  
 Knife Handle #4 . . . . . 46  
 Knife Handle #4L . . . . . 47  
 Knife Handle #7 . . . . . 47  
 Knife Handle #9 . . . . . 48  
 Knives  
 Smillie Meniscus Knife. . . . . 418  
 Krayenbuehl Nerve Hook . . . . . 178  
 Krayenbuehl Nerve Hook Extra Long Version . 178  
 Krayenbuehl Nerve Hook Titanium. . . . . 182

Kristler Manus Bone Reduction Clamp . 342  
 Kujat Shoulder Retractor. . . . . 461  
 Kurtz Cutt-Off Suction Adapter . . . . . 303  
 KUV Richards Bone Clamp. . . . . 331  
 K-Wire Pin Driver . . . . . 510

**L**

Lahey Retractor. . . . . 463  
 Lambert-Lowman Bone Holding Clamp. 334  
 Lambotte Osteotome . . . . . 393  
 Lamina Spreader  
 Inge Micro Ring Handle Lamina Spreader . 485  
 Lampert Curette . . . . . 530  
 Lane Periosteal Elevator . . . . . 377  
 Langenbeck Periosteal Elevator. . . . . 377  
 Large Pin / Bolt Cutter. . . . . 574  
 Large Sontec Combo Mallet. . . . . 407  
 Lateral Plate Bending Pliers . . . . . 435  
 Lead Hand Stabilizing Restrainer . . . . . 479  
 Leksell Bayonet Rongeur . . . . . 730  
 Leksell Duckbill Rongeur . . . . . 729  
 Leksell Extended Bone Rongeur . . . . . 737  
 Lemmon Dissector . . . . . 195  
 Lever  
 Sontec Stifle Thrust Lever . . . . . 463  
 Levesque Neuro Rongeur. . . . . 746  
 Lewin Bone Reduction Clamp . . . . . 346  
 Lexer Gouge . . . . . 385  
 Lexer Osteotome. . . . . 400, 401  
 Lid Cover & Perforated Nesting Sterilization Instrument Tray. . . . . 24  
 Lids  
 Stainless Steel Instrument Tray & Lid Cover . 26  
 Ligature Carrier  
 Cassio Ligature Carrier . . . . . 162  
 Deschamps Ligature Carrier . . . . . 164  
 Entner Ligature Carrier . . . . . 164  
 Graft Passer Ligature Carrier . . . . . 163  
 Reverdin Needle/Ligature Carrier . . . . . 162  
 Schmiedner-Dick Ligature Carrier . . . . . 164  
 Sontec Reverdin Blunt Needle/Ligature Carrier. . . . . 162  
 Tendon Passer Ligature Carrier. . . . . 163  
 Lighted Smith Nerve Retractor . . . . . 248  
 Liska Awl . . . . . 522  
 Liston Bone Cutting Forceps . . . . . 656  
 Locke Bone Reduction Clamp . . . . . 343  
 Locke CSU Bone Reduction Clamp . 344  
 Long Handle Curette. . . . . 540  
 Long Handle Curette & Elevator. . . . . 540  
 Long Handle File. . . . . 260, 775  
 Long Tissue Forceps . . . . . 125  
 Loute Wire Twister . . . . . 592  
 Love Adson Periosteal Elevator . . . . . 376  
 Love Gruenwald Pituitary Rongeur. . . . . 711  
 Love-Gruenwald Pituitary Rongeur. . . . . 709  
 Love Nerve Root Retractor . . . . . 244, 246  
 Lowman Bone Clamp . . . . . 333  
 Lowman Bone Holding Clamp . . . . . 333  
 Lubra Screw Driver . . . . . 499  
 Lucae Ear Forceps . . . . . 155  
 Lucae Ear Hook . . . . . 184  
 Lumbar & Cervical Impactor. . . . . 524  
 Lumbar Implant Holder/ Disk Marker . 525

**M**

Mach Holders  
 Valkyrie Mach Holder / Drill Guide. . . . . 515  
 Maltz Improved Double Ended Rasp . 765  
 Malleable Ribbon Retractor . . . . . 465, 466  
 Mallet  
 AO Type Mallet . . . . . 410  
 Brass Head Mallet . . . . . 406  
 Collin Lucae Mallet . . . . . 408  
 Cottle Mallet. . . . . 407  
 Heavyweight Mallet . . . . . 410  
 Large Sontec Combo Mallet . . . . . 407  
 Mead Mallet . . . . . 406  
 No Recoil Mallet. . . . . 412  
 Phenolic Spinal Mallet. . . . . 413  
 Sontec Combo Nylon Mallet . . . . . 404  
 Sontec Double Nylon Mallet . . . . . 405  
 Sontec Large Handle Mallet . . . . . 411  
 Sontec Large Pin . . . . . 409  
 Sontec Micro Mallet . . . . . 405  
 USA Model Mallet . . . . . 408  
 Maltz Single-Ended Rasp . . . . . 764  
 Marquardt Neuro Rongeur . . . . . 730  
 Martin Cartilage Clamp. . . . . 358  
 Masing Rasp . . . . . 771  
 Mat  
 Silicone Mat . . . . . 15  
 Mathieu Retractor . . . . . 463  
 McCollough Twist Fomon Raspatory . 765  
 McCullough Retractor Set. . . . . 230, 231  
 McGravey Tissue Forceps . . . . . 109  
 Mcllwraith . . . . . 619  
 Mcllwraith Arthroscopic Grasping Rongeur . 720, 721  
 Mcllwraith Arthroscopic Hook Probe . 619  
 Mcllwraith Arthroscopic Scissors Rongeur . 703  
 Mcllwraith Basket Cutter Rongeur . . . . . 702  
 Mcllwraith Cup Rongeur . . . . . 707  
 Mcllwraith-Peapod Rongeur . . . . . 703  
 Mcllwraith Periosteal Elevator. . . . . 378  
 Mcllwraith Suction Arthroscopic Cut Through Punch Rongeur . . . . . 611  
 McIndoe Bone Cutting Forceps . . . . . 658  
 McIndoe Dressing and Tissue Forceps . 121  
 McIndoe Forceps Titanium. . . . . 121  
 McPherson Bipolar Forceps. . . . . 139  
 Mead Mallet. . . . . 406  
 Mead Rongeur . . . . . 749  
 Measuring Gauge . . . . . 513  
 Medial Blade . . . . . 216  
 Medicine Cup . . . . . 31  
 Medi-Mark™ Tape . . . . . 38  
 Meniscomotome  
 Arthroscopic Meniscomotomes Hook, Probe & Knife . . . . . 615, 616  
 Mini V-Blade Meniscomotome . . . . . 417  
 Piermattei Smillie Meniscomotome . . . . . 418  
 Triangle Handle Arthroscopic Meniscomotome, Hook, Probe & Knife . . . . . 614  
 V Blade Meniscomotome . . . . . 416  
 Meniscus Grasping Forceps. . . . . 613  
 Metal Micro Instrument Tray . . . . . 10, 11  
 Meyerding Retractor . . . . . 465  
 Michele Trephine . . . . . 551  
 Micro Alligator Grasping Forceps. . . . . 71  
 Micro Axial Bayonet Extra Long Curette. 545  
 Micro Axial Bayonet Long Curette . . . . . 544  
 Micro Axial Bayonet Regular Length Curette.

543  
 Micro Bayonet Forceps. . . . . 154  
 Micro Biopsy Forceps with Flexible Tubular Shaft . . . . . 74  
 Micro Bone Reduction Clamp. . . . . 353  
 Micro Double Action Wire Cutter . . . . . 573  
 Micro Ear Alligator Forceps . . . . . 68, 69, 70  
 Micro Friedman Ring Handle Rongeur . 741  
 Micro Friedman Rongeur . . . . . 742  
 Micro Gerald Tissue Forceps . . . . . 109  
 Micro Hook Titanium. . . . . 187  
 Micro House Alligator Forceps . . . . . 64  
 Micro House Biopsy Alligator Forceps. . . 73  
 Micro Inge Lamina Spreader . . . . . 484  
 Micro Lamina Spreader . . . . . 226  
 Micro Neuro Biopsy Rongeur. . . . . 721  
 Micro Round Handle 6" Forceps Titanium . 172  
 Micro Round Handle Forceps Titanium . 173  
 Micro Scissors Long 14 mm Blades Round Handle Titanium . . . . . 168  
 Micro Scissors Small 8 mm Blades Round Handle Titanium . . . . . 169  
 Micro Sontec Alligator Forceps . . . . . 67, 72  
 Micro Spinal Curette . . . . . 542  
 Micro Straight Round Handle Forceps Titanium . . . . . 174  
 Micro Tap/ Drill Sleeve . . . . . 512  
 Micro TCD Round Handle 5 1/2" Needle Holder Titanium . . . . . 170  
 Micro TCD Round Handle 7" Needle Holder Titanium . . . . . 171  
 Micro Tying Forceps . . . . . 99  
 Micro Tying Forceps Titanium. . . . . 99  
 Miller Bone Rasp Double-Ended Single-Sided . . . . . 761  
 Miller Bone Rasp Double-Ended Single-Sided Serrated . . . . . 761  
 Miller Cross Serrated Rasp. . . . . 762  
 Miller Parallel Serrated Rasp. . . . . 763  
 Miller Rasp . . . . . 761  
 Mini Arthroscopic Small Joints Rongeur Set. 76  
 Mini Caliper . . . . . 54  
 Mini Depth Gauge. . . . . 520  
 Mini Doolen Bone Holding Clamp . . . . . 328  
 Mini Foremann Distractor . . . . . 453  
 Mini Friedman Rongeur . . . . . 742  
 Mini Hohman Elevator Retractor. . . . . 477  
 Mini Inge Neroma Ceramitec Retractor . 456  
 Mini Inge Neroma Retractor . . . . . 456  
 Mini Jet Wire Twister Needle Holder . 590  
 Mini Lexer Gouge . . . . . 385  
 Mini Lexer Osteotome. . . . . 400  
 Mini Neuro Premier Rongeur . . . . . 740  
 Mini Neuro Rongeur . . . . . 740  
 Mini Plate Bending Iron. . . . . 432  
 Mini Rod Holder . . . . . 491  
 Mini V-Blade Meniscomotome . . . . . 417  
 Miskimon Cerebellum Retractor. . . . . 278  
 Modified Ferguson-Frazier Suction . 299  
 Mollison Retractor. . . . . 274  
 Murphy Ball End Probe. . . . . 206  
 Murphy-Lane Bone Skid . . . . . 462

**N**

Nadler Coaptation Bipolar Forceps . 140  
 Nail Cutter

Feline Nail Cutter . . . . . 665  
 Nail Nipper . . . . . 661, 664  
 Nail Rasp . . . . . 764  
 Nail Scissor  
 White Toe Nail Scissor. . . . . 664  
 Nail Splitter . . . . . 661  
 Nail Splitter Forcep . . . . . 659  
 Needle  
 Durrani Dorsal Vein Complex Ligation Needle . . . . . 162  
 Reverdin Needle/Ligature Carrier . . . . . 162  
 Sontec Reverdin Blunt Needle/Ligature Carrier. . . . . 162  
 Needle Boat / Spiral Rack. . . . . 35  
 Needle Holder  
 Arthroscopic Needle Holder . . . . . 610  
 Micro TCD Round Handle 5 1/2" Needle Holder Titanium . . . . . 170  
 Micro TCD Round Handle 7" Needle Holder Titanium . . . . . 171  
 Mini Jet Wire Twister Needle Holder . . 590  
 New Orleans Wire Twister Needle Holder . 587  
 Obwegeser Wire Twister Needle Holder . 586  
 Rubio Wire Twister Needle Holder. . . . . 586  
 Sternal Wire Twister Needle Holder. . . 587  
 TC Jet Wire Twister Corkscrew Design Heavy Needle Holder. . . . . 591  
 Needle Nose Locking Pliers . . . . . 558  
 Needle Nose Pliers . . . . . 557  
 Nelms Suction Elevator. . . . . 200  
 Neroma Gelpi Spinal Retractor. . . . . 268  
 Nerve Hook Titanium . . . . . 186  
 Nerve & Vessel Hook Titanium. . . . . 182  
 Nested Trocar Set . . . . . 550  
 Neuro Caliper . . . . . 232  
 Neuro Ring Curette . . . . . 531  
 New Orleans Wire Twister Needle Holder . 587  
 Nipper  
 Tissue and Cuticle Nipper . . . . . 659  
 Nippers . . . . . 662  
 Concave Nail Nipper . . . . . 663  
 Nixon XXL Banana Knife. . . . . 419  
 Non-Perforated Mayo Tray . . . . . 28  
 No Recoil Mallet . . . . . 412

**O**

O'Brien Curette . . . . . 532  
 Obturator  
 Shepard Ram Obturator . . . . . 552  
 Obwegeser Fenestrated Serrations Rasp . 772  
 Obwegeser Solid Fine Grit Nasal Rasp . 773  
 Obwegeser Split Osteotome . . . . . 401  
 Obwegeser Wedge Osteotome . . . . . 401  
 Obwegeser Wire Twister Needle Holder. 586  
 Ochsner Dissector . . . . . 194  
 Ochsner-Sontec Straight Dissector . 194  
 Oehler Forceps . . . . . 119  
 Olivecrona Dissector. . . . . 195  
 Olivecrona Rongeur . . . . . 749  
 Original DeBakey Forceps . . . . . 101  
 Orthopedic Vernier Caliper . . . . . 54  
 Osteotome  
 Cottle Plastic Osteotome . . . . . 396  
 Hand Surgery Osteotome . . . . . 394

Hibbs Osteotome. . . . . 392  
 Hoke Osteotome . . . . . 395  
 Lambotte Osteotome. . . . . 393  
 Lexer Osteotome . . . . . 400, 401  
 Mini Lexer Osteotome . . . . . 400  
 Obwegeser Split Osteotome . . . . . 401  
 Obwegeser Wedge Osteotome. . . . . 401  
 Sheehan Osteotome . . . . . 394  
 Smith Peterson Osteotome . . . . . 390, 391  
 Stille Osteotome . . . . . 397  
 West Osteotome . . . . . 394  
 Osteotomes  
 Hardt Micro Ceramitec Osteotome . . . . 400

**P**

Pants  
 Sontec Scrub Pants . . . . . 32  
 Papavero Cannula Suction . . . . . 301  
 Parallel Drill Guide. . . . . 514  
 Parallel Wire Extraction Pliers . . . . . 427  
 Pashley-Frazier Suction . . . . . 298  
 Pashley Pipe Suction Tube Holding Device . 315  
 Patella 2 x 2 Prong Bone Clamp. . . . . 332  
 Peapod Extended Shaft Rongeur. . . . . 705  
 Peapod-Mcllwraith Rongeur . . . . . 704  
 Penfield Dissector Set. . . . . 196  
 Perforated Mayo Tray . . . . . 27  
 Perthes Awl . . . . . 522  
 Peterson Fully Cannulated Pin Bender . 424  
 Phenolic Spinal Mallet. . . . . 413  
 Pick  
 Bone Pick Micro Fracture . . . . . 621  
 Chondro Pick. . . . . 620  
 Rhoton Pick . . . . . 256  
 Taylor Micro Arthroscopic Hook Probe & Pick. . . . . 619  
 Taylor Micro Arthroscopic Pick . . . . . 520  
 Piermattei Pin Bender / Driver. . . . . 426  
 Piermattei Shoulder Elevator . . . . . 379  
 Piermattei Smillie Meniscomotome . . . . . 418  
 Pig Tail Neuro Hook Probe . . . . . 179  
 Pigtooth Nipper. . . . . 662  
 Pigtooth Nippers . . . . . 662  
 Pin Bender  
 Peterson Fully Cannulated Pin Bender . 424  
 Piermattei Pin Bender / Driver. . . . . 426  
 Pin Bender Double-Ended. . . . . 425  
 Pin Bender Double-Ended . . . . . 425  
 Pin Cutter  
 Baby GOLD-CUT HERCULES Pin Cutter . 572  
 End Pin Cutter . . . . . 570  
 Flush Cut Pin Cutter. . . . . 580  
 GOLD-CUT HERCULES Front & Side Pin Cutter . . . . . 582  
 GOLD-CUT HERCULES Pin Cutter . . . . . 571  
 Large Plate & Pin Cutter . . . . . 570  
 Pin Cutter Specialty Harden Jaws. . . . . 575  
 Sontec Pin Cutter. . . . . 577  
 TC Pin Cutter . . . . . 569, 575  
 The Big GOLD-CUT HERCULES® Pin Cutter . . . . . 571  
 Pin Cutter Specialty Harden Jaws . . . . . 575  
 Pin Driver

Pin Driver & Bone Tamp . . . . .	423
Sontec Pin Driver / Bender . . . . .	424
Pin Driver & Bone Tamp . . . . .	423
Pin End Cutter . . . . .	577
Pin Puller . . . . .	429
HERCULES GRIP Pin Puller . . . . .	428
Pin Puller . . . . .	429
Pin Pulling Double Action Pliers . . . . .	428
Pin Pulling Pliers . . . . .	556
Plate Bending Iron . . . . .	433
Plate Bending Iron Lateral & Contour . . . . .	433
Plate Bending Pliers . . . . .	433
Plate Bending Table Top Press . . . . .	434
Plate & Bone Reduction Forceps . . . . .	354
Plate Cutter for Titanium Plates . . . . .	568
Plater Cutter	
Large Plate & Pin Cutter . . . . .	570
Platipus Micro Inge Lamina Spreader . . . . .	482
Pliers . . . . .	427
Aderer Wire Bending Pliers . . . . .	494
Lateral Plate Bending Pliers . . . . .	435
Needle Nose Locking Pliers . . . . .	558
Needle Nose Pliers . . . . .	557
Pin Pulling Double Action Pliers . . . . .	428
Pin Pulling Pliers . . . . .	556
Plate Bending Pliers . . . . .	433
Rod Gripping Pliers . . . . .	492
Slip Joint Pliers . . . . .	559
Vise Grip Pliers . . . . .	559
Waldsachs Universal Pin Bender Pliers . . . . .	495
Whale Nose Plate Bending Pliers . . . . .	436
Wire Extraction Pliers . . . . .	556
Plug Cutter . . . . .	553
Polokoff Bone Rasp Double-Ended Single-Sided . . . . .	760
Poole Suction . . . . .	311
Poole Suction Deluxe . . . . .	312
Potts Cooley Tissue Forceps . . . . .	114
Potts Nevins Forceps . . . . .	115
Potts-Smith Dressing Forceps . . . . .	115
Potts-Smith Tissue Forceps . . . . .	113
Potts-Smith Tissue Forceps . . . . .	115
Power Drill Adapter for Sontec I.M. Pin Chuck . . . . .	506
Premixslip® . . . . .	40
Prepzyme® . . . . .	41
Press	
Plate Bending Table Top Press . . . . .	434
Probe	
Arthroscopic Hook Probe . . . . .	618
Arthroscopic Hook Probe with Conical Handle . . . . .	618
Arthroscopic Meniscotomes Hook, Probe & Knife . . . . .	615, 616
Jacobson Button End Hook Probe . . . . .	257
Jacobson Button End Probe . . . . .	256
Jacobson Hook Probe . . . . .	257
McIlwraith Arthroscopic Hook Probe . . . . .	619
Murphy Ball End Probe . . . . .	206
Pig Tail Neuro Hook Probe . . . . .	179
Taylor Micro Arthroscopic Hook Probe & Pick . . . . .	619
Triangle Handle Arthroscopic Meniscotome, Hook, Probe & Knife . . . . .	614
Tufts Pigtail Neuro Hook Probe . . . . .	178, 179
Probe & Knife . . . . .	614, 615, 616

**R**

Probes & Knives . . . . .	614
Puller	
Vickers Easy Driver / Bender / Puller . . . . .	422
Punch	
Arthroscopic Gawling Basket Punch . . . . .	652
Arthroscopic Hook Punch . . . . .	598
Arthroscopic Low Profile Toothed Punch . . . . .	600
Arthroscopic Mini Low Profile Hook Punch . . . . .	599
Arthroscopic Punch & Scissors . . . . .	604
Arthroscopic Right Left Side Punch . . . . .	601
Arthroscopic Saber Scissor Punch . . . . .	652
Basket Standard . . . . .	599
Frontal Sinus Giraffe Punch . . . . .	77
Hook . . . . .	599
Hook Punch . . . . .	611
Square Standard . . . . .	599
Punched Hole Gauge Ruler . . . . .	56
Putti Bone Rasp . . . . .	765, 766
<b>R</b>	
Ragnell Retractor . . . . .	468, 470
Raleigh Bone Holding Forceps . . . . .	345
Raleigh Bone Reduction Clamp . . . . .	343
Rasp	
Arthroscopic Rasp . . . . .	618, 620
Combination Bone Rasp . . . . .	767
Double-Ended Rasp . . . . .	756
Foman Rasp . . . . .	759
Foman "R" Rasp . . . . .	760
Foman TC Insert Rasp . . . . .	757
Fomon Rasp . . . . .	757
Glabella Masing Rasp . . . . .	770
Good Bone Rasp . . . . .	768
Howard Bone Rasp Double-Ended Single-Sided . . . . .	760
Kistler Ear Cartilage Rasp . . . . .	770
Maltz Improved Double Ended Rasp . . . . .	765
Maltz Single-Ended Rasp . . . . .	764
Masing Rasp . . . . .	771
Miller Bone Rasp Double-Ended Single-Sided . . . . .	761
Miller Bone Rasp Double-Ended Single-Sided Serrated . . . . .	761
Miller Cross Serrated Rasp . . . . .	762
Miller Parallel Serrated Rasp . . . . .	763
Miller Rasp . . . . .	761
Nail Rasp . . . . .	764
Obwegeser Fenestrated Serrations Rasp . . . . .	772
Polokoff Bone Rasp Double-Ended Single-Sided . . . . .	760
Putti Bone Rasp . . . . .	765, 766
Rhinoplasty Rasp . . . . .	765
Single Side Rasp . . . . .	766
Sontec Diamond Surface Rasp . . . . .	771
Sontec Fomon Rasp . . . . .	756
Sontec Glabella Pull Push Curved Tip Rasp . . . . .	770
Sontec-Glabella Sculpting TC Insert Rasp . . . . .	773
Sontec Micro Rasp . . . . .	764
Sontec-Miller TC Insert Rasp . . . . .	761
Sontec Spinal File/Rasp . . . . .	774
Webster Glabella Sculpting Rasp . . . . .	773

Raspatory	
McCollough Twist Fomon Raspatory . . . . .	765
Rhoton Dissector / Raspatory . . . . .	254, 255
Sontec A O Type Elevator / Raspatory . . . . .	380, 381
Sontec Patella Raspatory . . . . .	771
Yasargil Dissector Raspatory Titanium . . . . .	194
Yasargil Raspatory Titanium . . . . .	191
Rasps	
Foman TC Insert Rasp Angled . . . . .	758
Obwegeser Solid Fine Grit Nasal Rasp . . . . .	773
Redler Reposition Reduction Clamp . . . . .	354
Reduction Clamp	
Redler Reposition Reduction Clamp . . . . .	354
Reil Bone Holding Forceps . . . . .	340
Removers	
Surgical Blade Remover . . . . .	49
Resano Brown Vascular Forceps . . . . .	111
Resano Brown Vascular Forceps Titanium . . . . .	112
Resano Double Action Vascular Forceps Titanium . . . . .	112
Retractor	
Adson Cerebella Retractor . . . . .	270
Allen Inge Stifle Retractor . . . . .	454
Aufranc Cobra Retractor . . . . .	462
Beckman-Adson Retractor . . . . .	273
Beckman-Eaton Retractor . . . . .	277
Bryant Mitral Hook Retractor . . . . .	185
Caspar Cervical Vertebral Column Quick Release Retractor Frame . . . . .	218
Caspar Cervical Vertebral Column Retractor Frame . . . . .	214
Caspar Counter Retractor . . . . .	223
Caspar Distractor Vertebral Retractor . . . . .	220
Caspar Hand Universal Retractor . . . . .	217
Caspar Nerve-Root Retractor . . . . .	227
Charnley Initial Incision Retractor . . . . .	460
Cloward Cervical Retractor . . . . .	228, 229
Cloward Vertebral Cervical Spreader Retractor . . . . .	486
Davis Stifle Retractor . . . . .	454
Finsen Self-Retaining Retractor . . . . .	459
Frazier Lamina Retractor . . . . .	275
Gelpi 1st Generation Deep Angle Retractor . . . . .	448
Gelpi Classic Retractor . . . . .	444, 445
Gelpi Deep Angle Neroma (Crossover) Retractor . . . . .	443
Gelpi Deep Angle Retractor . . . . .	440
Gelpi Neroma (Crossover) Retractor . . . . .	442
Gelpi Original Spinal Retractor . . . . .	264
Gelpi Retractor . . . . .	441, 446, 447, 450
Gelpi Retractor Titanium . . . . .	265
Gelpi Spinal Retractor . . . . .	265, 266, 267, 275
Hess Nerve Retractor . . . . .	250
Hibbs Retractor . . . . .	464
Hip & Knee Retractor . . . . .	478
HL MIS Retractor Frame Medium . . . . .	214
Hohman Elevator Retractor . . . . .	476
Inge Lamina Retractor . . . . .	487
Inge Lamina Spreader Extra Large Retractor . . . . .	484

Inge Neroma Retractor . . . . .	455
Kelly Retractor . . . . .	472
Kujat Shoulder Retractor . . . . .	461
Lahey Retractor . . . . .	463
Lighted Smith Nerve Retractor . . . . .	248
Love Nerve Root Retractor . . . . .	244, 246
Malleable Ribbon Retractor . . . . .	465, 466
McCullough Retractor Set . . . . .	230, 231
Meyerding Retractor . . . . .	465
Mini Hohman Elevator Retractor . . . . .	477
Mini Inge Neroma Ceramitec Retractor . . . . .	456
Mini Inge Neroma Retractor . . . . .	456
Miskimon Cerebellum Retractor . . . . .	278
Mollison Retractor . . . . .	274
Neroma Gelpi Spinal Retractor . . . . .	268
Ragnell Retractor . . . . .	468, 470
Richardson-Eastman Retractor . . . . .	472
Richardson Retractor . . . . .	469, 471
Scoville Nerve Root Retractor . . . . .	251
Senn Retractor . . . . .	468, 470
Sisson Spring Retractor . . . . .	457
Slocum Type Army Navy Retractor . . . . .	461
Sontec-Hohmann Elevator Retractor . . . . .	474, 475
Sontec-Hohman Retractor . . . . .	476
Sontec-Love Nerve Root Retractor . . . . .	245
Sontec Multi-Level Gelpi Retractor . . . . .	276, 278
Sontec Multi-Level Off Set Arms Gelpi Retractor . . . . .	277
Suction Nerve Retractor . . . . .	247, 301
Taylor Spinal Retractor . . . . .	461
Vickers Self-Retaining Retractor . . . . .	458
Volkman Retractor . . . . .	467
Weitlaner Extended Blades Retractor . . . . .	273
Weitlaner Retractor . . . . .	269, 272
Weitlaner Retractor Titanium . . . . .	271
Wellace Stifle Retractor . . . . .	457
Wide Scoville Nerve Root Retractor . . . . .	249
Retractor Frame	
Caspar Cervical Vertebral Retractor Frame . . . . .	210
Scoville Retractor Frame . . . . .	224
U.S. Army-Navy Retractor . . . . .	473
Wide Scoville Nerve Root Retractor . . . . .	249
Retractors	
Beckman Retractor . . . . .	273
Mathieu Retractor . . . . .	463
Retractor, Senn . . . . .	468, 470
Reul Coronary Artery Forceps . . . . .	115
Reusable Bipolar Cord . . . . .	143
Reverdin Needle/Ligature Carrier . . . . .	162
Rhinoplasty Rasp . . . . .	765
Rhoton Circular Dissector 45° . . . . .	254
Rhoton Curette . . . . .	256
Rhoton Dissector / Raspatory . . . . .	254, 255
Rhoton Hook . . . . .	256
Rhoton Micro Neuro Suction . . . . .	293
Rhoton Pick . . . . .	256

Richardson-Eastman Retractor . . . . .	472
Richardson Retractor . . . . .	469, 471
Rod Bender	
Rod Bender Large . . . . .	494
Rod Bender Small . . . . .	493
Rod Bender Large . . . . .	494
Rod Bender Small . . . . .	493
Rod Cutter . . . . .	578
Rod Flush Cutter . . . . .	579
Rod Gripping Pliers . . . . .	492
Rod Holder	
Rod Holder Kern Type . . . . .	490
Rod Holder Kern Type . . . . .	490
Rongeur	
Adson Rongeur . . . . .	753
Arthroscopic Maxi Grasper . . . . .	612
Arthroscopic Punch Rongeur . . . . .	605
Bacon Duckbill Rongeur . . . . .	750
Bailey Rongeur . . . . .	704
Bane Single Action Rongeur . . . . .	748
Beatty Foraminotomy Rongeur . . . . .	674
Beyer Rongeur . . . . .	727
Black Ruskin Rongeur . . . . .	725
Blakesley Ethmoid Rongeur . . . . .	701
Blakesley-Ethmoid Rongeur . . . . .	701
Blumenthal Rongeur . . . . .	748
Caspar Grasping Rongeur . . . . .	712
Cicherelli Rongeur . . . . .	747
Classic Lempert Rongeur . . . . .	745
Cleveland Rongeur . . . . .	747
Cushing Pituitary Rongeur . . . . .	708, 711
Cushing Rongeur . . . . .	752
Decker Micro Rongeur . . . . .	719
Defourmentel Rongeur . . . . .	750
Echlin Duckbill Rongeur . . . . .	731
Ethmoid Pediatric Rongeur . . . . .	700
Ferris-Smith Arthroscopic Rongeur . . . . .	713, 714, 715
Ferris-Smith Arthroscopic Ultra-Low Profile Rongeur with Enhanced Jaw Power . . . . .	717
Ferris-Smith Rongeur . . . . .	716
Ferris-Smith Spinal Extended Shaft Rongeur . . . . .	717
Ferris-Smith Wilde Rongeur . . . . .	716
Hakansson Rongeur . . . . .	743
Hartman Rongeur . . . . .	751
Hoen Grasping Forceps . . . . .	718
Jeurs Lempert Neuro Rongeur . . . . .	746
Kerrison 40° Laminectomy/Lumbar . . . . .	678
Kerrison 40° Rongeur . . . . .	675, 679, 683
Kerrison 90° Rongeur . . . . .	676, 680
Kerrison 90° Rongeur . . . . .	677
Kerrison Bayonet 40° Rongeur . . . . .	684, 685
Kerrison Bayonet Foraminotomy Rongeur . . . . .	686
Kerrison Convertible 40° Rongeur . . . . .	687
Kerrison Punch (Occular-plasti) 40° Rongeur . . . . .	691
Kerrison Punch (Occular-plasti) 90° Rongeur . . . . .	690
Kerrison Universal Rotating 360° Rongeur . . . . .	669, 670, 671
Kleinert-Kutz Duckbill Synovectomy Rongeur . . . . .	725

Kleinert-Kutz Rongeur . . . . .	741
Leksell Bayonet Rongeur . . . . .	730
Leksell Duckbill Rongeur . . . . .	729
Leksell Extended Bone Rongeur . . . . .	737
Levesque Neuro Rongeur . . . . .	746
Love Gruenwald Pituitary Rongeur . . . . .	711
Love-Gruenwald Pituitary Rongeur . . . . .	709
Marquardt Neuro Rongeur . . . . .	730
McIlwraith Arthroscopic Grasping Rongeur . . . . .	720, 721
McIlwraith Arthroscopic Scissors Rongeur . . . . .	703
McIlwraith Basket Cutter Rongeur . . . . .	702
McIlwraith Cup Rongeur . . . . .	707
McIlwraith-Peapod Rongeur . . . . .	703
McIlwraith Suction Arthroscopic Cut Through Punch Rongeur . . . . .	611
Mead Rongeur . . . . .	749
Micro Friedman Ring Handle Rongeur . . . . .	741
Micro Friedman Rongeur . . . . .	742
Micro Neuro Biopsy Rongeur . . . . .	721
Mini Arthroscopic Small Joints Rongeur Set . . . . .	76
Mini Friedman Rongeur . . . . .	742
Mini Neuro Premier Rongeur . . . . .	740
Mini Neuro Rongeur . . . . .	740
Olivecrona Rongeur . . . . .	749
Peapod Extended Shaft Rongeur . . . . .	705
Peapod-McIlwraith Rongeur . . . . .	704
Ruskin Duckbill Rongeur . . . . .	726
Ruskin Rongeur . . . . .	724
Schlesinger (Cloward) Rongeur . . . . .	710
Selverstone Peapod Rongeur . . . . .	705
Semb Bone Rongeur . . . . .	735
Shearer Chickenbill Rongeur . . . . .	743
Smith-Peterson Laminectomy Rongeur . . . . .	728
Smith-Peterson Sontec Streamlined Laminectomy Rongeur . . . . .	727
Sontec Beatty Foraminotomy Rongeur . . . . .	673
Sontec Kerrison 40° Rongeur . . . . .	682, 689
Sontec Kerrison Rongeur . . . . .	692
Sontec Kerrison Rongeur 90° Down Bite Rongeur . . . . .	681
Sontec Lempert Rongeur . . . . .	745
Spurling Pituitary Rongeur . . . . .	710, 711
Stellbrink Rongeur . . . . .	744
Stille-Luer Duckbill Rongeur . . . . .	734
Stille-Luer Echlin Duckbill Bayonet Rongeur . . . . .	736
Stille-Luer Echlin Duckbill Rongeur . . . . .	736
Stille-Luer Rongeur . . . . .	732, 733
Suction Arthroscopic Cut Through Punch Rongeur . . . . .	609, 610
Sypert Extended Rongeur . . . . .	737
Takahashi Rongeur . . . . .	706
Weil Nasal Rongeur . . . . .	698
Wilde Ethmoid Arthroscopic Rongeur . . . . .	700
Wilde Ethmoid Rongeur . . . . .	699
Williams-Sontec Rongeur . . . . .	702
Zaufel-Jansen Rongeur . . . . .	726
Rongeurs	
Ferris-Smith Arthroscopic Rongeur Bayonet . . . . .	718

Weil-Blakesley Rongeur . . . . . 698  
 Rongeurs Tray . . . . . 693  
 Rosen Suction Tips . . . . . 302  
 Rosin Root Meniscotome . . . . . 418  
 Rotary Arthroscopic Scissors . . . . . 613  
 Rotweiler Junior Loosebody Grasping Forceps . . . . . 650  
 Round Blade . . . . . 228  
 Rubber Jaws Replacement Set for Hercules Wire Cutter . . . . . 582  
 Rubio Wire Twister Needle Holder . . . . . 586  
 Ruler  
 Punched Hole Gauge Ruler . . . . . 56  
 Ruskin Duckbill Rongeur . . . . . 726  
 Ruskin-Liston Bone Cutting Forceps . . . . . 656  
 Ruskin Rongeur . . . . . 724  
 Russian Adson Micro Forceps . . . . . 137  
 Russian Tissue Forceps . . . . . 109

**S**

Sanders Brown Ligature Carrier . . . . . 165  
 Sayre Elevator . . . . . 379  
 SC95-0300-SET . . . . . 621  
 SC95-0302-SET . . . . . 621  
 SC95-0310-SET . . . . . 622  
 SC95-0315-SET . . . . . 622  
 SC95-0415-SET . . . . . 622  
 Schiötz Tonometer . . . . . 56  
 Schlesinger (Cloward) Rongeur . . . . . 710  
 Schmid Suction Tips . . . . . 304  
 Schmieden-Dick Ligature Carrier . . . . . 164  
 Schroeder Vulsellum Bone Reduction Clamp . . . . . 351  
 Scissors  
 Arthroscopic Metzenbaum Hook Scissors . . . . . 602  
 Arthroscopic Punch & Scissors . . . . . 604  
 Ingrown Nail Splitting Scissors . . . . . 664  
 Micro Scissors Long 14 mm Blades Round Handle Titanium . . . . . 168  
 Micro Scissors Small 8 mm Blades Round Handle Titanium . . . . . 169  
 Rotary Arthroscopic Scissors . . . . . 613  
 Scoville Bayonet Bipolar Forceps . . . . . 143  
 Scoville Bipolar Forceps . . . . . 144  
 Scoville Lumbar Blade . . . . . 225  
 Scoville Middle Lumbar Blade . . . . . 225  
 Scoville Nerve Root Retractor . . . . . 251  
 Scoville Retractor Frame . . . . . 224  
 Screwdriver  
 Caspar Screwdriver . . . . . 222  
 Screw Driver  
 A.O. Type Universal Screw Driver . . . . . 499  
 Hexagonal Screw Driver . . . . . 498  
 Lubra Screw Driver . . . . . 499  
 Screw Holding Forceps . . . . . 501  
 Screw Post  
 Caspar Screw Post . . . . . 222  
 Sedillot Elevator . . . . . 379  
 Self-Locking 3K Chuck Blade Handle . . . . . 49  
 Selman Tissue Forceps . . . . . 110  
 Selverstone Peapod Rongeur . . . . . 705  
 Semb Bone Rongeur . . . . . 735  
 Semken Forceps . . . . . 118  
 Separator  
 Frazier Dorsey Dura Separator . . . . . 178  
 Sequestum Sontec Bone Forceps . . . . . 326  
 Sesamoidectomy Bone Clamp . . . . . 329

Set  
 AO Type Bending Pliers Set . . . . . 437  
 AO Type Universal Screwdriver Set . . . . . 500  
 Bone Mill Set . . . . . 527  
 Bone Scraper Set . . . . . 521  
 Caspar System Complete Set . . . . . 233  
 Coupland Suction Set . . . . . 314  
 Gallaher Bone Rasp Set . . . . . 768  
 Gubish Surgical Pen Holder Set . . . . . 48  
 Jacobson Raspatory/Probe Set . . . . . 191  
 McCullough Retractor Set . . . . . 230, 231  
 Mini Arthroscopic Small Joints Rongeur Set . . . . . 76  
 Penfield Dissector Set . . . . . 196  
 Rubber Jaws Replacement Set for Hercules Wire Cutter . . . . . 582  
 Small Joint Arthroscopic Cannula Switch Stick Set . . . . . 624  
 Sontec-Cottle Osteotome Set . . . . . 399  
 Sontec Ear Rasp Set . . . . . 769  
 Sontec Hybrid I.M. Pin Chuck Set . . . . . 509  
 Sontec I.M. Pin Chuck Set . . . . . 508  
 Sontec Keyless I.M. Pin Chuck Set . . . . . 509  
 TC Blades Replacement Set For Hercules Wire Cutter . . . . . 582  
 TC Inserts with Rubber Jaws Replacement Set for Hercules Front & Side Cutter . . . . . 582  
 Universal Klick Kerrison Rongeur Set with Tray . . . . . 668  
 Yasargil Raspatory Probe Set . . . . . 191  
 Sets  
 Hardt Micro Cartilage Osteotome Set (with tray) . . . . . 398  
 Shearer Chickenbill Rongeur . . . . . 743  
 Sheehan Osteotome . . . . . 394  
 Sheen Fragment Retriever Forceps . . . . . 707  
 Shepard Cross Pin . . . . . 552  
 Shepard Ram Obturator . . . . . 552  
 Shepard Trocar . . . . . 552  
 Short Jaw Nail Splitter . . . . . 660  
 Side Biting Alligator . . . . . 63  
 Side Biting Alligator Forceps . . . . . 63  
 Siegel Knife Handle . . . . . 48  
 SIL-239 . 781  
 SIL-2410 . . . . . 780  
 SIL-2480 . . . . . 782  
 Silicone Mat . . . . . 15  
 Silver Ear Dressing Alligator Forceps . . . . . 91  
 Single Side Rasp . . . . . 766  
 Singley Tuttle Forceps . . . . . 110  
 Sisson Spring Retractor . . . . . 457  
 Skid  
 Murphy-Lane Bone Skid . . . . . 462  
 Skinner Tissue Forceps . . . . . 117  
 Slap Hammer / Hip Dislodger . . . . . 558  
 SL - Connect Blade Insert Instrument . . . . . 218  
 SL - Connect Blunt Blade Titanium . . . . . 219  
 SL - Connect Lateral Blade Titanium . . . . . 219  
 Slip Joint Pliers . . . . . 559  
 Slocum Type Army Navy Retractor . . . . . 461  
 Small Joint Arthroscopic Cannula . . . . . 624  
 Small Joint Arthroscopic Cannula Switch Stick Set . . . . . 624  
 Small Joint Complete Arthroscopic Set . . . . . 625  
 Small Plate Bending Iron . . . . . 432  
 Smillie Meniscus . . . . . 418  
 Smillie Meniscus Knife . . . . . 418

Smith-Petersen Gouge . . . . . 384  
 Smith-Peterson Laminectomy Rongeur . 728  
 Smith Peterson Osteotome . . . . . 390, 391  
 Smith-Peterson Sontec Streamlined Laminectomy Rongeur . . . . . 727  
 Sontec Alligator Forceps . . . . . 60, 62  
 Sontec A O Type Elevator / Raspatory . 380, 381  
 Sontec Beatty Foraminotomy Rongeur . 673  
 Sontec Brain Spatula . . . . . 238  
 Sontec Chisel . . . . . 387  
 Sontec Combo Nylon Mallet . . . . . 404  
 Sontec-Condial Reduction Clamp . . . . . 352  
 Sontec-Cottle Osteotome Set . . . . . 399  
 Sontec Delicate Meniscus Clamp . . . . . 361  
 Sontec D'Errico Tissue Forceps . . . . . 109  
 Sontec Diamond Surface Rasp . . . . . 771  
 Sontec Double Nylon Mallet . . . . . 405  
 Sontec Ear Rasp Set . . . . . 769  
 Sontec Elite Wireless LED Headlight . 778, 779  
 Sontec Fomon Rasp . . . . . 756  
 Sontec Forcep Holder . . . . . 34  
 Sontec Glabella Pull Push Curved Tip Rasp . 770  
 Sontec-Glabella Sculpting Rasp . . . . . 773  
 Sontec-Glabella Sculpting TC Insert Rasp . 773  
 Sontec-Hohmann Elevator Retractor . 474, 475  
 Sontec-Hohman Retractor . . . . . 476  
 Sontec Hybrid I.M. Pin Chuck . . . . . 504  
 Sontec Hybrid I.M. Pin Chuck Set . . . . . 509  
 Sontec I.M. Pin Chuck . . . . . 504  
 Sontec I.M. Pin Chuck Aluminum Handle . 505  
 Sontec I.M. Pin Chuck Extensions . . . . . 507  
 Sontec I.M. Pin Chuck Set . . . . . 508  
 Sontec I.M. Pin Chuck T-Handle . . . . . 506  
 Sontec Instrument Fabric Barrier Wrap 2Ply . 33  
 Sontec Kerrison 40° Rongeur . . . . . 682, 689  
 Sontec Kerrison Rongeur . . . . . 692  
 Sontec Kerrison Rongeur 90° Down Bite Rongeur . . . . . 681  
 Sontec Keyless I.M. Pin Chuck Set . . . . . 509  
 Sontec Keyless I.M. Pin Drill Chuck . . . . . 505  
 Sontec Knife Handle #3XXL . . . . . 45  
 Sontec Lane Lever Elevator . . . . . 477  
 Sontec Large Handle Mallet . . . . . 411  
 Sontec Large Mallet . . . . . 409  
 Sontec LED Plus+ Headlight . . . . . 780  
 Sontec Lempert Rongeur . . . . . 745  
 Sontec-Love Nerve Root Retractor . . . . . 245  
 Sontec Magnum LED Headlight . . . . . 781  
 Sontec Meniscus Clamp . . . . . 360  
 Sontec Mesh Meniscus Clamp . . . . . 362  
 Sontec Micro Alligator Forceps . . . . . 61  
 Sontec Micro Biopsy Forceps . . . . . 87  
 Sontec Micro Gouge . . . . . 384  
 Sontec Micro Mallet . . . . . 405  
 Sontec Micro Pediatric Suction . . . . . 306, 307, 308  
 Sontec Micro Rasp . . . . . 764  
 Sontec-Miller TC Insert Rasp . . . . . 761  
 Sontec Multi-Level Gelpi Retractor . 276, 278  
 Sontec Multi-Level Off Set Arms Gelpi Retractor . . . . . 277  
 Sontec Nerve Hook Titanium . . . . . 182

Sontec Neuro Suction . . . . . 296  
 Sontec Patella Raspatory . . . . . 771  
 Sontec Perfusion Cannula Suction . . . . . 314  
 Sontec Pin Cutter . . . . . 577  
 Sontec Pin Driver / Bender . . . . . 424  
 Sontec proCam 4K Micro Camera System . 782  
 Sontec Reverdin Blunt Needle/Ligature Carrier . . . . . 162  
 Sontec Scrub Pants . . . . . 32  
 Sontec Septal Platform Forceps . . . . . 94  
 Sontec Septal Platform Forceps Titanium . 94  
 Sontec Sheet Tape . . . . . 37  
 Sontec Single End Wire Passer . . . . . 562  
 Sontec Slim Thermoplastic Instrument Tray . 23  
 Sontec Spinal File/Rasp . . . . . 774  
 Sontec Stifle Thrust Lever . . . . . 463  
 Spatula  
 CSU Kloop Neuro Spatula . . . . . 237  
 Cushing Brain Depressor Spatula . . . . . 237  
 Davis Brain Spatula . . . . . 239, 241  
 Sontec Brain Spatula . . . . . 238  
 Spatulas  
 Davis Brain Black Silicone Spatula . . . . . 240  
 Speculum  
 Caspar Lumbar Speculum . . . . . 222  
 Spinal Compressor . . . . . 280, 281  
 Spinal Curette . . . . . 534  
 Spinal Distractor . . . . . 279, 280  
 Spinal Distractor/Compressor . . . . . 279  
 Spinal Fusion Curette . . . . . 546  
 Sponge Bowl . . . . . 30  
 Spreader  
 Cloward Lamina Spreader . . . . . 486  
 Inge Lamina Spreader . . . . . 482, 483  
 Micro Inge Lamina Spreader . . . . . 484  
 Micro Lamina Spreader . . . . . 226  
 Platipus Micro Inge Lamina Spreader . . 482  
 Spurling Pituitary Rongeur . . . . . 710, 711  
 Square Standard . . . . . 599  
 ST2J . 31  
 ST3J . 31  
 ST4J . 31  
 ST15-20-PMT . . . . . 27  
 Stabilizing Restrainer  
 Lead Hand Stabilizing Restrainer . . . . . 479  
 Stahl A/C Lens Gauge . . . . . 55  
 Stahl Caliper . . . . . 55  
 Stainless Steel Instrument Tray . . . . . 24  
 Stainless Steel Instrument Tray & Lid Cover . 25, 26  
 Staley Round Knurled Knife Handle . . . . . 45  
 Standard Plate Bending Iron . . . . . 432  
 Stefan Bone Holding Forceps . . . . . 325  
 Stefan Mini Bone Holding Forceps . . . . . 324  
 Steinman Pin Puller . . . . . 426  
 Stellbrink Rongeur . . . . . 744  
 Sterilizing Rack  
 Alligator Sterilizing Rack . . . . . 18  
 Sternal Wire Twister Needle Holder . . . . . 587  
 Stille-Adson Dressing Forceps . . . . . 136  
 Stille-Adson Tissue Forceps . . . . . 136  
 Stille Curette . . . . . 366  
 Stille-Horsley Bone Cutter . . . . . 660  
 Stille-Liston Bone Cutting Forceps . . . . . 657  
 Stille-Luer Duckbill Rongeur . . . . . 734

Stille-Luer Echlin Duckbill Bayonet Rongeur . 736  
 Stille-Luer Echlin Duckbill Rongeur . 736  
 Stille-Luer Rongeur . . . . . 732, 733  
 Stille Osteotome . . . . . 397  
 Stringer Forceps Holder . . . . . 35  
 Suction  
 Adson Suction . . . . . 313  
 Andrews Pynchon Suction . . . . . 309  
 Anthony Suction . . . . . 309  
 Baby Poole Suction . . . . . 312  
 Baron Suction . . . . . 297  
 Braun-Ralph Suction . . . . . 309  
 Frazier Angled Suction . . . . . 286, 287, 288, 289  
 Frazier Insulated Suction . . . . . 291  
 Frazier-Rhoton Angled Suction . . . . . 292  
 Frazier Straight Suction . . . . . 290  
 Fukushima Suction . . . . . 294, 295  
 House-Baron Suction . . . . . 304  
 House Irrigator/Suction . . . . . 305  
 Killian (Von Eicken) Suction . . . . . 313  
 Kurtz Cut-Off Suction Adapter . . . . . 303  
 Modified Ferguson-Frazier Suction . . . . . 299  
 Papavero Cannula Suction . . . . . 301  
 Pashley-Frazier Suction . . . . . 298  
 Poole Suction . . . . . 311  
 Poole Suction Deluxe . . . . . 312  
 Rhoton Micro Neuro Suction . . . . . 293  
 Rosen Suction Tips . . . . . 302  
 Schmid Suction Tips . . . . . 304  
 Sontec Micro Pediatric Suction . . . . . 306, 307, 308  
 Sontec Neuro Suction . . . . . 296  
 Sontec Perfusion Cannula Suction . . . . . 314  
 Yankauer Suction . . . . . 310  
 Suction Adapter  
 House Cutoff Suction Adapter . . . . . 303  
 Suction Arthroscopic Cut Through Punch Rongeur . . . . . 609, 610  
 Suction Handle  
 Wullstein Suction Handle . . . . . 303  
 Suction Nerve Retractor . . . . . 247, 301  
 Suction Tube  
 Barnes Mini Suction Tube . . . . . 297  
 Bayonet Suction Tube . . . . . 300  
 Black Monopolar Suction Tube . . . . . 147  
 Buie Suction Tube . . . . . 312  
 Wullstein Ear Suction Tube . . . . . 303  
 Sump Sucker  
 Heartline Ross Sump Sucker . . . . . 311  
 Surgical Blade Remover . . . . . 49  
 Surgistain® . . . . . 40  
 Switch Stick . . . . . 624  
 Arthroscopic Switch Stick . . . . . 623  
 Sypert Extended Rongeur . . . . . 737  
 T  
 T12-9300 . . . . . 52  
 T117-560 . . . . . 45  
 T136-686 . . . . . 134  
 Table Top Rod Cutter . . . . . 583  
 Takahashi Rongeur . . . . . 706  
 Tap  
 AO Tap Cannulated . . . . . 513  
 Tap/ Drill Sleeve . . . . . 512  
 Tape

Medi-Mark™ Tape . . . . . 38  
 Sontec Sheet Tape . . . . . 37  
 Tap Sleeve & Insert Drill Sleeve Set . . . . . 511  
 Taylor-Dingmann Bone Clamp . . . . . 327  
 Taylor Drill Guide . . . . . 512  
 Taylor Micro Arthroscopic Hook Probe . 619  
 Taylor Micro Arthroscopic Hook Probe & Pick . 619  
 Taylor Micro Arthroscopic Pick . . . . . 520  
 Taylor Spinal Retractor . . . . . 461  
 TC Blades Replacement Set For Hercules Wire Cutter . . . . . 582  
 TC Inserts with Rubber Jaws Replacement Set for Hercules Front & Side Cutter . 582  
 TC Jet Wire Twister Corkscrew Design Heavy Needle Holder . . . . . 591  
 TC Pin Cutter . . . . . 569, 575  
 Tear Drop Curette . . . . . 539  
 Tear Drop Spinal Curette . . . . . 533  
 Tendon Passer Ligature Carrier . . . . . 163  
 Tenzel Bipolar Forceps . . . . . 139  
 T-Handle Bone Hook . . . . . 520  
 The Big GOLD-CUT HERCULES Pin Cutter . 571  
 Thermoplastic Instrument Tray . 19, 20, 21  
 Thermoplastic Instrument Trays . . . . . 22  
 Thorpe Caliper . . . . . 54  
 3 / 1 Drill Guide . . . . . 511  
 Thumb Dressing Forceps . . . . . 122  
 Thumb Forceps Titanium . . . . . 117  
 Tip  
 Gubisch Surgical Pen Replacement Tip . 49  
 Tip Cover . . . . . 36  
 Tissue and Cuticle Nipper . . . . . 659  
 Tissue Bipolar Forceps . . . . . 145  
 Tissue Forceps with TC Inserts . . . . . 117  
 Tissue Forceps with Teeth . . . . . 120  
 Tissue Nipper . . . . . 658  
 Titanium Bayonet Bipolar Forceps . . . . . 143  
 Titanium Sontec Dissector . . . . . 195  
 Tobey Ear Dressing Forceps . . . . . 92  
 Tonometer  
 Schiötz Tonometer . . . . . 56  
 Toothed Blade . . . . . 229  
 TPLO Double-Ended Gauge . . . . . 57  
 Tray  
 Catheter Tray & Dome Lid Cover . . . . . 24  
 Instrument Tray . . . . . 27  
 Metal Micro Instrument Tray . . . . . 10, 11  
 Non-Perforated Mayo Tray . . . . . 28  
 Perforated Mayo Tray . . . . . 27  
 Rongeurs Tray . . . . . 693  
 Sontec Slim Thermoplastic Instrument Tray . 23  
 Stainless Steel Instrument Tray, Lid Cover & Perforated Nesting Sterilization Instrument Tray . . . . . 24  
 Thermoplastic Instrument Tray . . . . . 19, 20, 21  
 Thermoplastic Instrument Trays . . . . . 22  
 Universal Kerrison Klick Rongeur Tray for Set . . . . . 16  
 Universal Surgery Tray . . . . . 14  
 Trays  
 Stainless Steel Instrument Tray & Lid Cover . 25

Trephine	
Bespoke Wroblewski Bone Trephine . . . . .	553
Galt Trephine . . . . .	551
Michele Trephine . . . . .	551
Triangle Handle Arthroscopic Meniscotome . . . . .	614
Trocar	
Nested Trocar Set . . . . .	550
Shepard Trocar . . . . .	552
Troutman Micro Hook Forceps . . . . .	126
Tufts Pigtail Neuro Hook Probe . . . . .	178, 179
Two Handed Curette . . . . .	538, 539
Two Handed Large Grip Curette . . . . .	541
<b>U</b>	
Ulrich Bone Clamp . . . . .	321
Ulrich Swivel Jaw Bone Clamp . . . . .	335
Universal Adjustable Angle Knife Handle #3 . . . . .	44
Universal Drill Guide . . . . .	510
Universal Kerrison Klick Rongeur Tray for Set . . . . .	16
Universal Klick Kerrison Rongeur Set with Tray . . . . .	668
Universal Surgery Tray . . . . .	14
USA Curette . . . . .	535
USA Model Mallet . . . . .	408
USA Ring Curette . . . . .	535
U.S. Army-Navy Retractor . . . . .	473
<b>V</b>	
Valkyrie Mach Holder / Drill Guide . . . . .	515
V Blade Meniscotome . . . . .	416
Ventricular Vent	
Heartline Ross Ventricular Vent . . . . .	311
Verbrugge Bone Clamp . . . . .	318, 319, 320
Verbrugge Reverse Jaw Bone Clamp . . . . .	320
Verbrugge-Rogalski Bone Clamp . . . . .	322
Vickers Easy Driver / Bender / Puller . . . . .	422
Vickers Self-Retaining Retractor . . . . .	458
Vise Grip Pliers . . . . .	559
Volkman Curette . . . . .	371
Volkman Retractor . . . . .	467
<b>W</b>	
Wagner Hook . . . . .	186
Waldsachs Universal Pin Bender Pliers . . . . .	495
Wangensteen Tissue Forceps . . . . .	110
Webster Glabella Sculpting Rasp . . . . .	773
Weil-Blakesley Rongeur . . . . .	698
Weil Nasal Rongeur . . . . .	698
Weitlaner Extended Blades Retractor . . . . .	273
Weitlaner Retractor . . . . .	269, 272
Weitlaner Retractor Titanium . . . . .	271
Wellace Stifle Retractor . . . . .	457
West Osteotome . . . . .	394
Whale Nose Plate Bending Pliers . . . . .	436
Whisk 'R Brush™ . . . . .	39
White Toe Nail Scissor . . . . .	664
Wide Barrel Grip Knife Handle #3 . . . . .	44
Wide Scoville Nerve Root Retractor . . . . .	249
Wide Scoville Nerve Root Retractor . . . . .	249
Wilde Ear Forceps . . . . .	155
Wilde Ethmoid Arthroscopic Rongeur . . . . .	700
Wilde Ethmoid Rongeur . . . . .	699
Williams-Sontec Rongeur . . . . .	702
Williger Periosteal Elevator . . . . .	379
Wire Bender . . . . .	492
Wire Bender . . . . .	492
Wire Cutter	
Double Action Wire Cutter . . . . .	573, 576
Wire End Cutter . . . . .	569, 580, 581
Wire Side Cutter . . . . .	568
Wire End Cutter . . . . .	569, 580, 581
Wire Extraction Pliers . . . . .	556
Wire Passer	
Avian Mini Wire Passer . . . . .	565
Herbst-Doolen Wire Passer . . . . .	564
Herbst Wire Passer . . . . .	564
Hybrid Herbst Wire Passer . . . . .	563
Sontec Single End Wire Passer . . . . .	562
Wire Rod Holder & Bender . . . . .	492
Wire Side Cutter . . . . .	568
Wire Twister . . . . .	590
Anti-Buckle Wire Twister . . . . .	588
Axel Wire Twister . . . . .	589
Bio-Met Type Wire Twister . . . . .	592
Bio-Met Wire Twister . . . . .	592
Cerclage Double Torpedo Type Wire Twister . . . . .	593
Cerclage Torpedo Type Wire Twister . . . . .	591
Jet Wire Twister . . . . .	593
Loute Wire Twister . . . . .	592
Mini Jet Wire Twister Needle Holder . . . . .	590
New Orleans Wire Twister Needle Holder . . . . .	587
Obwegeser Wire Twister Needle Holder . . . . .	586
Rubio Wire Twister Needle Holder . . . . .	586
Sternal Wire Twister Needle Holder . . . . .	587
Wire Twister . . . . .	590
Wullstein Ear Suction Tube . . . . .	303
Wullstein Suction Handle . . . . .	303
<b>Y</b>	
Yankauer Suction . . . . .	310
Yasargil Atrauma Forceps . . . . .	155
Yasargil Bayonet Bipolar Forceps . . . . .	142
Yasargil Bayonet Elevator Titanium . . . . .	200
Yasargil Bayonet Forceps Titanium . . . . .	152
Yasargil Dissector Raspatory Titanium . . . . .	194
Yasargil Forceps Titanium . . . . .	148, 149
Yasargil Galea Spring Neuro Hook . . . . .	187
Yasargil Micro Bayonet Forceps . . . . .	154
Yasargil Micro Forceps Titanium . . . . .	150, 153
Yasargil Raspatory Probe Set . . . . .	191
Yasargil Raspatory Titanium . . . . .	191
Yasargil Tumor Bayonet Forceps . . . . .	154
Yasargil Tumor Grasping Bayonet Forceps . . . . .	156
Yasargil Tumor Grasping Bayonet Forceps Titanium . . . . .	152
Yasargil Tumor Grasping Forceps Titanium . . . . .	151
<b>Z</b>	
Zaufel-Jansen Rongeur . . . . .	726



**In Business for Over 50 Years**

Bringing the Highest Quality Surgical  
Instrumentation to the World since 1970



**Sontec Instruments®**

A TRADITION OF FINE SURGICAL INSTRUMENTS

Sontec Instruments, Inc.  
7248 South Tucson Way  
Centennial, Colorado 80112 USA  
Toll-free / 800.821.7496  
Local / 303.790.9411  
Fax / 303.792.2606

[SontecInstruments.com](http://SontecInstruments.com)