



 Sontec Instruments®

ORTHOPEDIC

Dear Customer,

Sontec Instruments, Inc. is a family owned & operated medical company, providing personalized service featuring the finest in surgical instrumentation for over half a century.

Our surgical instruments encompass the entire human anatomy including specialty products specific to small and large animal surgery.

Owner of Sontec Instruments, Dennis Russell Scanlan III and his sons, Johann, Stefan and Angus Scanlan bring with them a lifetime of experience creating the highest quality products made by the world's leading manufacturing facilities featuring, cutting edge robotic technology, handmade workmanship combined with an understanding how to make exactly what our valued customers have come to expect.

Dennis R. Scanlan, III President & CEO and his wife Caron C. Scanlan thank you, for the opportunity to present our specialty Ophthalmology catalog.

Sincerely,



Dennis Russell Scanlan III

Table of Contents

| | |
|--|-----|
| Important Information | 4 |
| STORAGE CASES & CLEANING | 9 |
| KNIFE & BLADE Handles | 43 |
| CALIPERS & RULERS | 51 |
| ALLIGATOR BIOPSY FORCEPS | 59 |
| FORCEPS Flat Handle | 97 |
| Ligature Carriers | 161 |
| Micro HAND SURGERY | 167 |
| Neuro HOOKS | 177 |
| Neuro RASPATORY | 189 |
| Neuro Spinal DISSECTORS | 193 |
| Neuro Spinal ELEVATORS | 199 |
| Neuro Spinal PROBES | 205 |
| Caspar RETRACTORS & DISTRATORS | 209 |
| Brain SPATULAS | 235 |
| Nerve RETRACTORS | 243 |
| Rhoton Jacobson Curette & Dissector Hook Set | 253 |
| Spinal RASPS | 259 |
| Spinal RETRACTORS | 263 |
| SUCTION Selection | 283 |
| Orthopedic BONE HOLDING CLAMPS | 317 |
| Orthopedic BONE REDUCTION CLAMPS | 337 |
| Orthopedic CARTILAGE CLAMPS | 357 |
| Orthopedic CURETTES | 365 |
| Orthopedic ELEVATORS | 373 |
| Orthopedic GOUGES | 383 |
| Orthopedic OSTEOTOMES | 389 |
| Orthopedic MALLETS | 403 |
| Orthopedic MENISCOTOMES & KNIVES | 415 |
| Orthopedic PIN-PULLERS, DRIVERS & BENDERS | 421 |
| Orthopedic PLATE BENDERS & BENDING IRONS | 431 |
| Orthopedic RETRACTORS | 439 |
| Orthopedic Spinal LAMINA SPREADERS | 481 |
| Orthopedic ROD HOLDERS & BENDERS | 489 |
| Orthopedic SCREWDRIVERS | 497 |
| Orthopedic DRILLS, DRILL GUIDES & CHUCKS | 503 |
| Orthopedic SPECIALTY | 517 |
| Orthopedic Spinal Neuro CURETTES | 529 |
| Orthopedic TREPHINE | 549 |
| Orthopedic VISE GRIP PLIERS | 555 |
| Orthopedic WIRE PASSERS | 561 |
| Orthopedic WIRE PIN CUTTERS | 567 |
| Orthopedic WIRE TWISTERS | 585 |
| ARTHROSCOPIC | 595 |
| Bone & NAIL CUTTING Forceps | 655 |
| Kerrison RONGEURS | 667 |
| Pistol Grip RONGEURS | 697 |
| Orthopedic DOUBLE ACTION RONGEURS | 723 |
| Orthopedic SINGLE ACTION RONGEURS | 739 |
| RASPS | 755 |
| Headlights & Cameras | 777 |
| Index | 784 |

IMPORTANT INFORMATION

Guarantee & Repairs Policy

Sontec® surgical instruments are guaranteed to be free of defects in materials and workmanship. Any Sontec® instrument that is defective will be repaired or replaced at our discretion. Instruments not properly cared for, used for unintended purposes, or beyond their designed capacity will not be covered under this guarantee. Our liability under this guarantee is limited to the repair or replacement of the defective merchandise.

Sontec® has its own repair department where most mechanically functional instruments can be returned to like-new condition.

Sontec® performs a variety of repairs, such as replacing worn TC jaws or sharpening scissors. In addition, we complete a comprehensive evaluation of your instruments to determine if further service is required.

For repair service, please send the following directly to the address below:

- Instruments clean, sterilized, securely wrapped and carefully packaged.
- Purchase and/or repair order
- A note with contact and shipping information
- Sending multiple items eliminates \$50 minimum charge

Return Policy

The return of new, unused instruments in their original packaging is accepted within 30 days of purchase with an authorized "Return Merchandise Authorization". Please contact Sontec directly by phone or email with your invoice or proof of purchase in order to obtain your RMA slip and instructions. Restocking fee applies and credit will not be issued for shipping charges or handling fees. Proper credit is not guaranteed without an RMA. Custom, Special Order or Modified items are non-returnable.

Sontec Instruments, Inc.
Toll free: 800.821.7496
Local: 303.790.9411
returns@sontecinstruments.com

Remember

Sontec® offers other catalogs for a variety of surgical instrumentation, including:

- Alligator, Grasping, & Biopsy Forceps
- Avian & Exotic
- Bandage Scissors
- Cardiovascular & Thoracoscopic
- Caspar & Cloward Retractor Systems
- Colon & Rectal
- Cranial Cruciate Ligament Lateral Suture

- System
- Equine (Arthroscopic)
 - Eye
 - Neurology & Orthopedic
 - Orthopedic & Arthroscopic
 - Urology
 - Veterinary Dental
 - Veterinary Eye
 - General Veterinary Instrumentation

Also, if you do not find what you are looking for, please contact us.

Instrument Care

Designed and crafted to exacting specifications, surgical instruments will perform for a number of years, provided they are maintained correctly and used for their intended purpose. A strict maintenance schedule will help reduce the need for premature replacements, thus cutting costs. For proper safeguarding of surgical instruments, please read and share the following information.

- Never substitute sterilization for cleanliness
- Wash brand new instruments prior to the first sterilization
- Remove saline solution, bleach, blood and tissue from instruments quickly and thoroughly
- Always use distilled water for cleaning instruments
- Never use saline solution for cleaning instruments
- Prevent cross-corrosion by separating corroded instruments from other instruments
- Never autoclave econo-grade stainless with superior-grade stainless.
- Always autoclave instruments with box lock open to alleviate pressure at the joint and to prevent fracture
- Lubricate joint and box lock after cleaning with an anti-microbial, water soluble lubricant
- Protect the tips of delicate instruments with protective covers (see page a.)
- Never use an instrument for anything other than its intended use

Additional Safeguarding Guidelines

Scissors and Other Blades

- Perform routine inspections for sharpness, as a blade becomes duller with each stroke (all operating and Mayo scissors should be able to cut through four layers of gauze)
- When blades no longer cut without an excessive amount of force, please return them to Sontec® for sharpening
- The more often a blade is sharpened, the longer it tends to last

Needle Holders

- Repair is necessary when needle holder no longer securely holds needle when locked on the second ratchet tooth, and needle turns easily by hand

Please Note

- We are not responsible for typographical errors in this catalog
- Instruments pictured in this catalog may or may not be to size
- Variations and changes in instrument design are possible
- Pricing is subject to change without notice
- Delivery schedules may vary from original estimates
- Some items are for veterinary use

Contact Info

Sontec Instruments, Inc.
7248 South Tucson Way
Centennial, Colorado 80112, USA
Toll free: 800.821.7496
Local: 303.790.9411
service@sontecinstruments.com
www.sontecinstruments.com

Troubleshooting Guide

| Problem | Cause | Solution |
|---------------------------|--|--|
| Rust | Worn chrome plating on brass instruments | Be aware of plating condition and remove from service when wear is visible. |
| | Cross-corrosion from carbon instruments to stainless steel | Keep carbon steel and stainless steel instruments separated during cleaning and sterilization. |
| | Low grade instruments may not have been passivated | Remove from service. |
| | Autoclave not operating properly | Clean and thoroughly flush water lines in sterilizer according to manufacturer's instructions. Only use distilled water, never tap water, to generate steam. |
| | Organic matter left on instrument after surgery | Remove all blood and tissue before drying. Use distilled water and a nylon brush to clean hard to reach areas. |
| Pitting | Prolonged exposure to corrosive chemicals and/or organic substances | Only use approved cleaning and sterilization solutions. Thoroughly rinse and dry instruments. |
| Orange / Brown Stains | Contaminated sterilizer, high alkaline detergent, cold disinfectants | Clean sterilizer. Use neutral pH solutions. Thoroughly clean, rinse, and dry instruments. |
| Bluish Black Stains | Mixing dissimilar metals during cleaning and sterilization | Separate carbon steel, aluminum, and stainless steel instruments. |
| Rainbow - olored Stains | Chromium oxide stain-result of excessive heat | Send in for polishing and hardness check. |
| Cracked Box Lock | Excessive force, sterilized in the closed position | Replace the instrument. |
| Cracked Jaw on Pin Cutter | Cutting pin at tip of jaws | Replace the instrument. Cut pin in center of jaws. |

Conversion Table

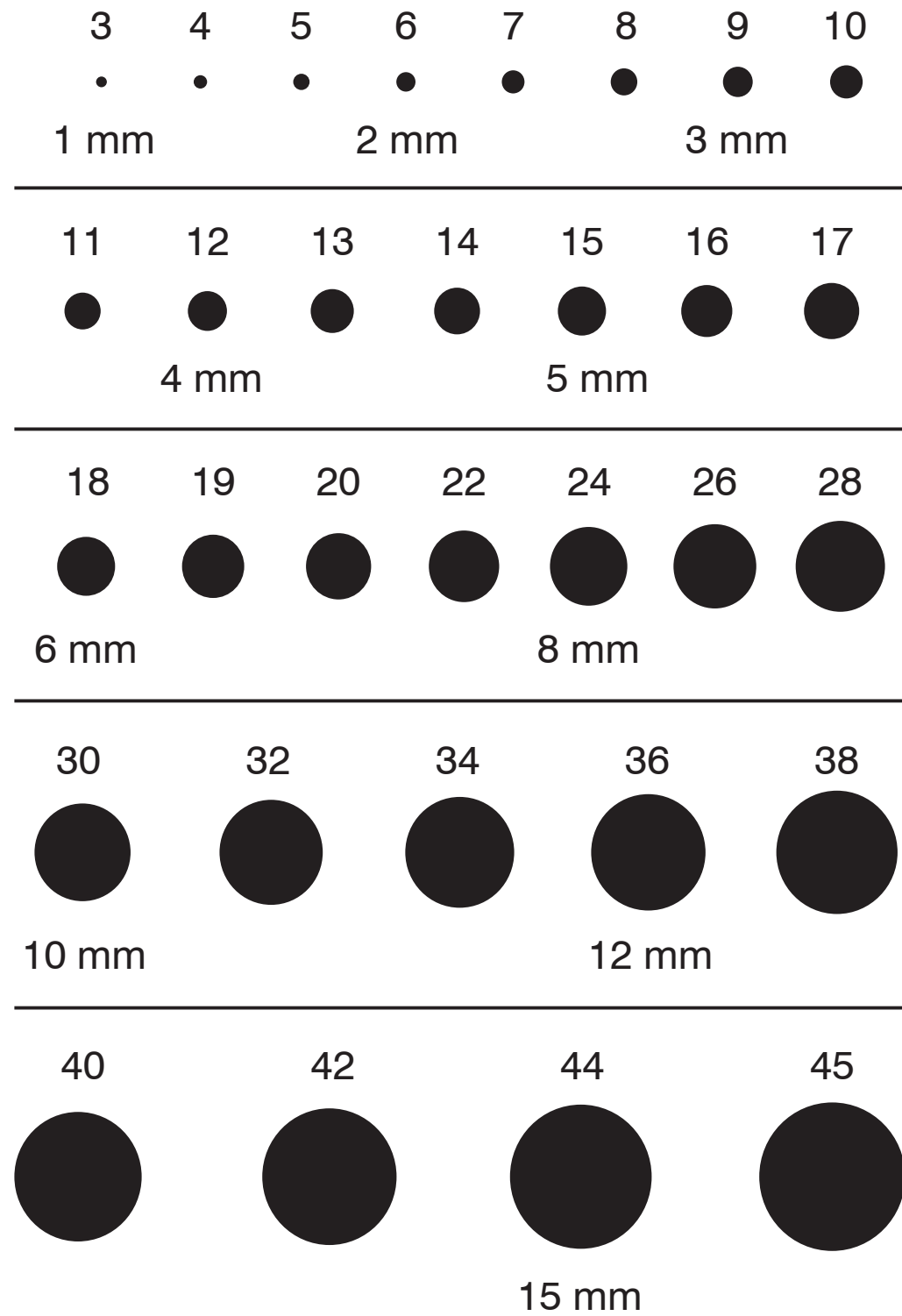

Conversion Table

| Multiply | By | To Obtain |
|-----------------------------|---------|-------------|
| Millimeters | 0.1 | Centimeters |
| Millimeters | 0.03937 | Inches |
| Centimeters | 0.3937 | Inches |
| Centimeters | 0.01 | Meters |
| Centimeters | 10 | Millimeters |
| Inches | 2.540 | Centimeters |
| $1/8'' = 3.175$ millimeters | | |
| $1/4'' = 6.350$ millimeters | | |
| $3/8'' = 9.525$ millimeters | | |
| $1/2'' = 12.70$ millimeters | | |
| $1'' = 25.40$ millimeters | | |

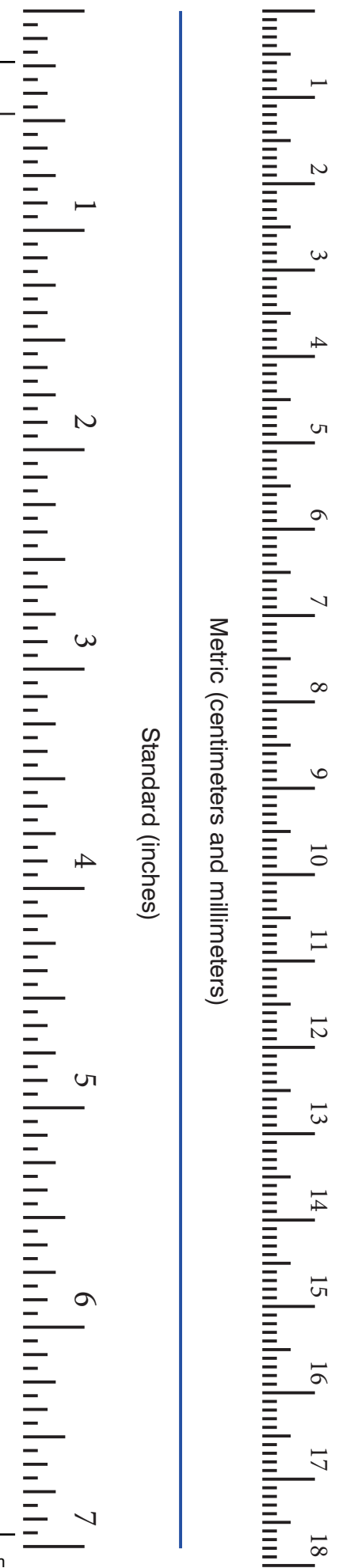

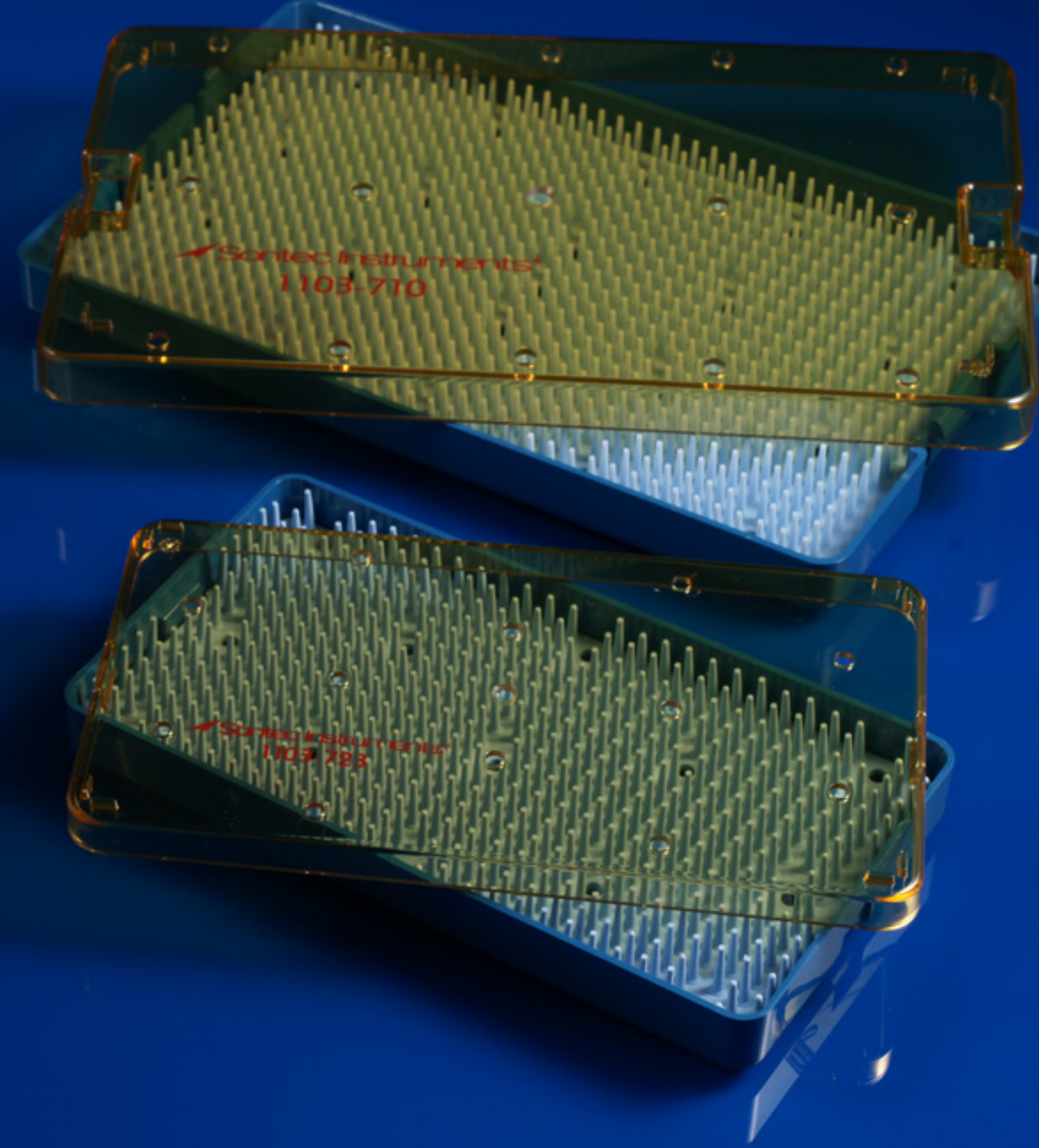
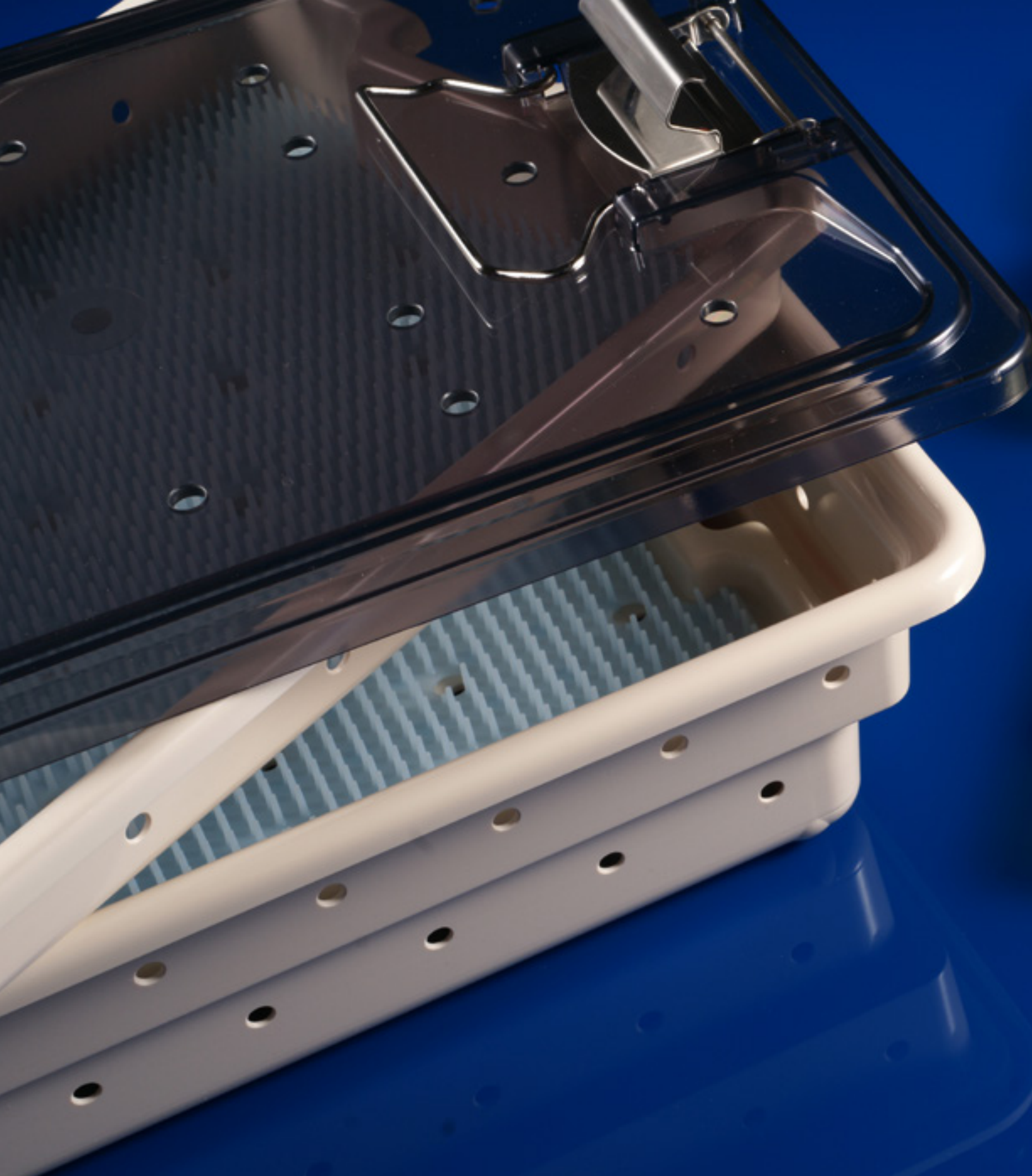

 Sontec Instruments®
STORAGE CASES & CLEANING

Metal Micro Instrument Tray

Single level / includes pin mat and retainers

- 18-3519 10" x 10" x 1.5" (25.5 cm x 25.5 cm x 4 cm)
- 18-3510 10" x 15" x 1.5" (25.5 cm x 38 cm x 4 cm)

* Instruments not included



18-3519



18-3510

Metal Micro Instrument Tray

Double level / includes pin mat and retainers / instruments not included

- 18-3505 10" x 10" x 3" (25.5 cm x 25.5 cm x 8 cm)
- 18-3515 10" x 15" x 3" (25.5 cm x 38 cm x 8 cm) short tray / full height

* Instruments not included



18-3505



18-3515

Metal Micro Instrument Tray

Double level / includes pin mat and retainers

- 18-3520 10.5" x 15" x 2.5" (26.5 cm x 38 cm x 6.5 cm) long tray / half height
- 18-3525 10" x 19.5" x 2.5" (25.5 cm x 49.5 cm x 6.5 cm) short tray / full height
- 18-3530 10.5" x 19.5" x 2.5" (26.5 cm x 49.5 cm x 6.5 cm) long tray / half height

* Instruments not included



18-3520



18-3525



18-3530

Rhoton Instrument Tray

Stainless steel tray

1103-708

* instruments sold as complete set
* or can order individually / separate

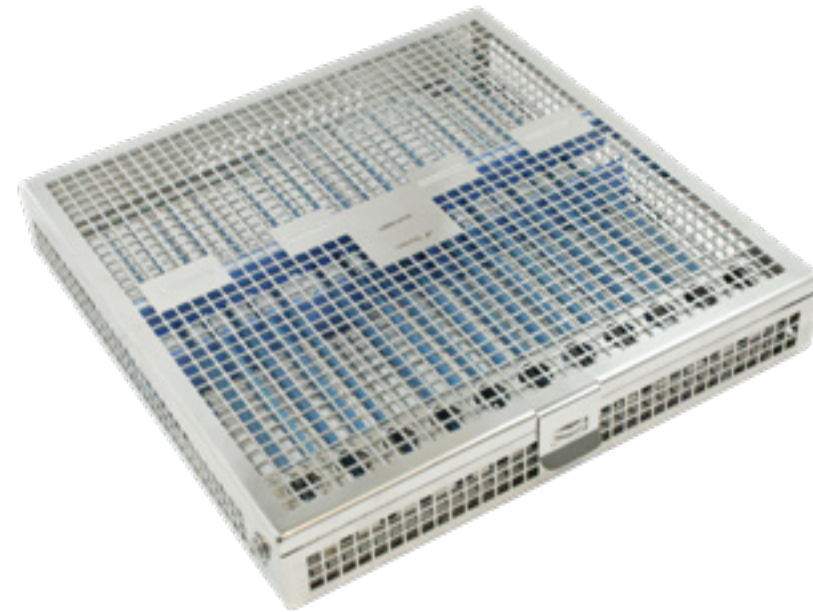

Rhoton Instrument Tray

Stainless solid

1103-709

* instruments sold as complete set
* or can order individually / separate



Universal Surgery Tray

10" x 21.5" x 2.5" / with lid / universal
keyhole brackets

18-3560

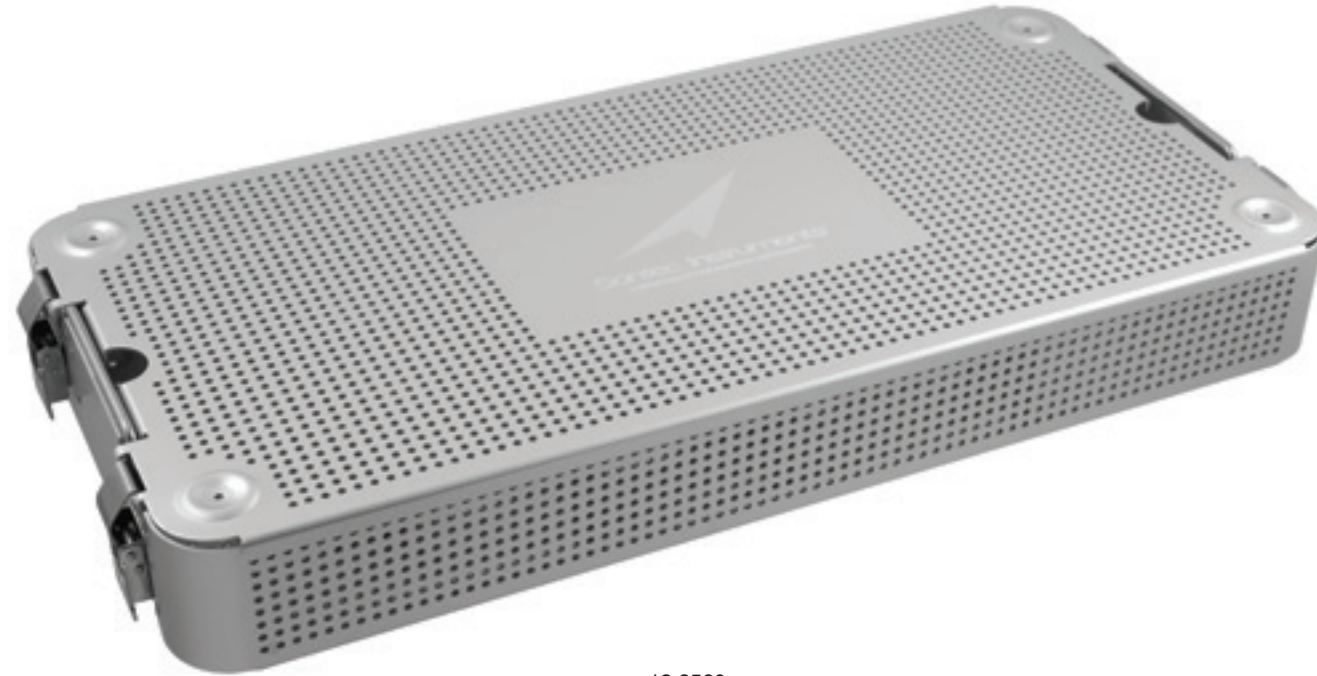

18-3560

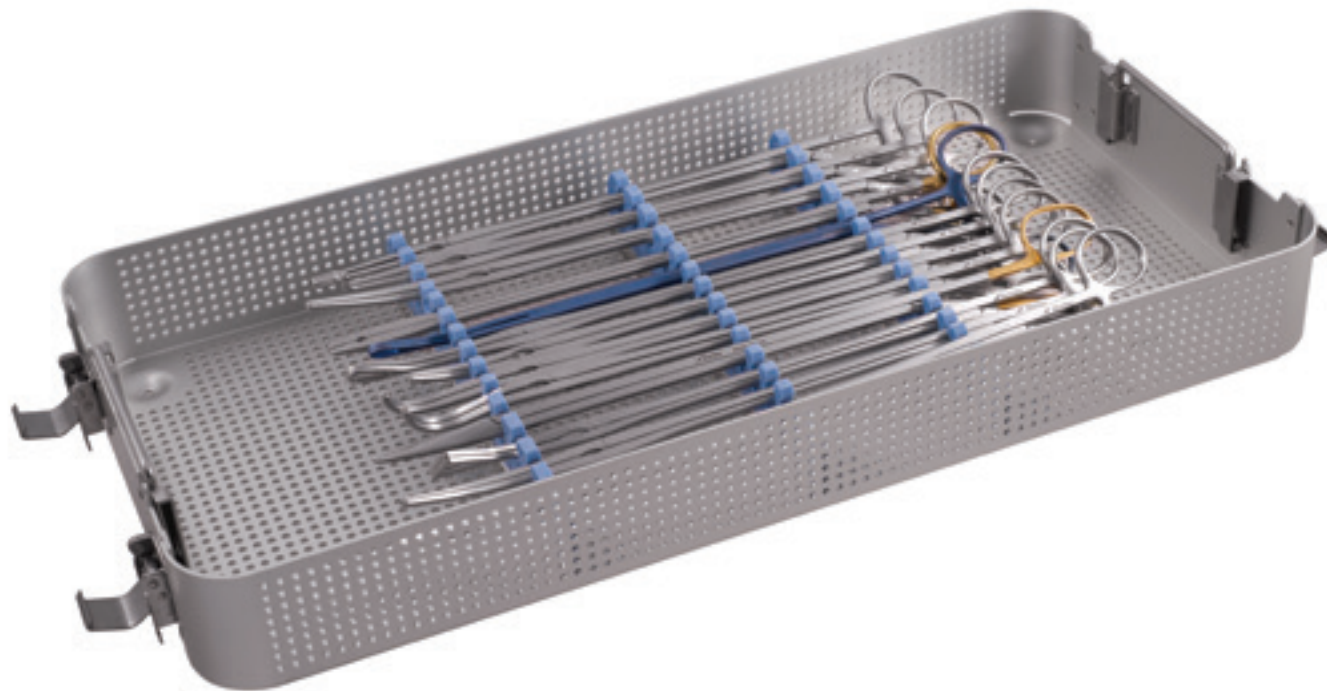

Silicone Mat

For instrument trays / cut to size /
autoclavable

- 18-3120 18" x 13" (46 cm x 33 cm) with holes
- 18-3121 10" x 6" (25.5 cm x 15 cm)
- 18-3122 10" x 15" (25.5 cm x 38 cm)
- 18-3123 13" x 18" (35.5 cm x 48.5 cm)

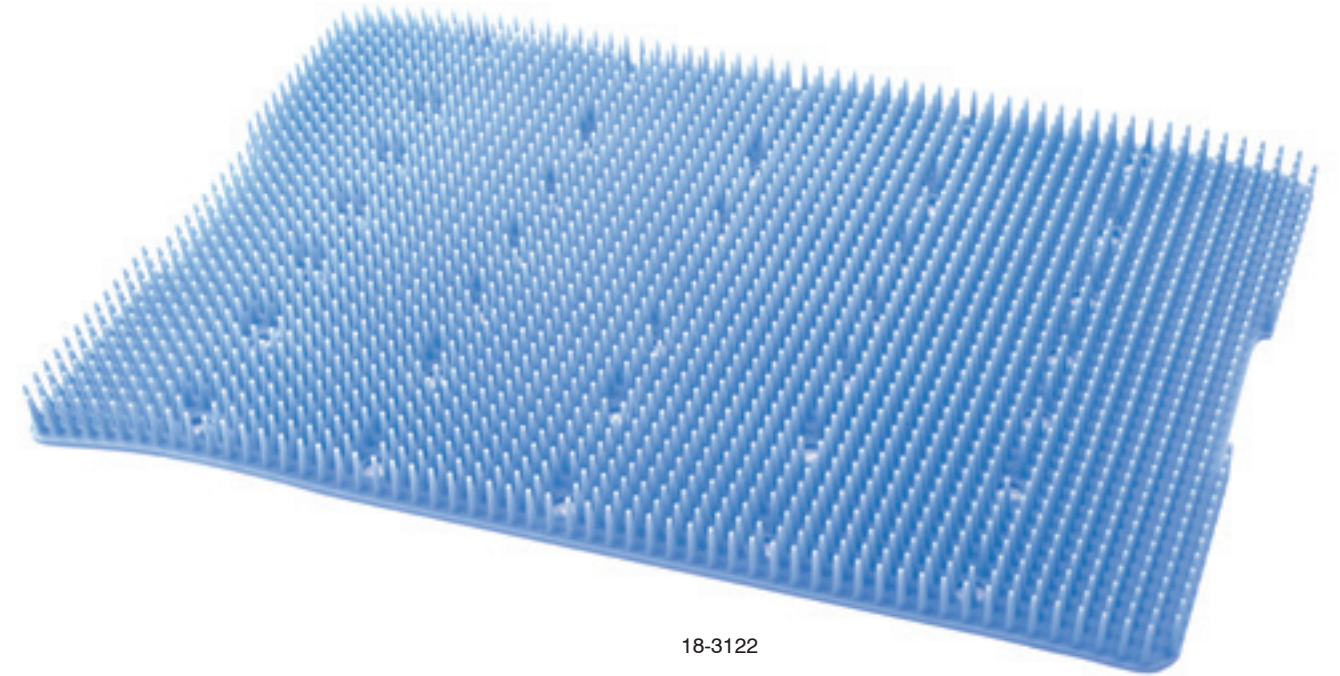

18-3122

Universal Kerrison Klick Rongeur Tray for Set

18-3564 tray for the set

To configure you own personalized set, refer to "Kerrison Section" > "Kerrison Universal Rotating 360° Rongeur" for all possible options

*different size shafts available up request



Alligator Sterilizing Rack

3.5" x 3" x 7.5"
325-130

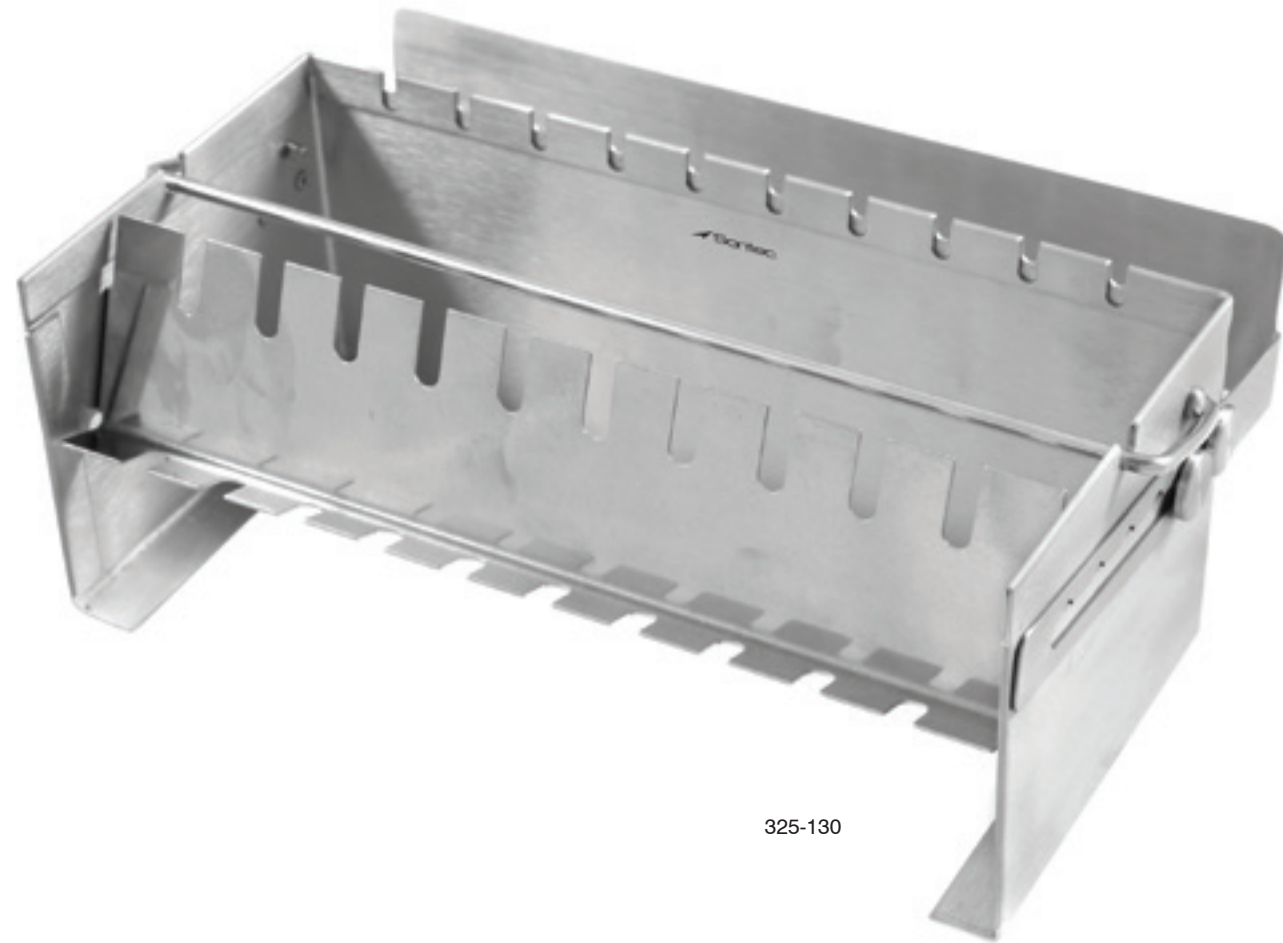

325-130

Thermoplastic Instrument Tray

With silicone mat / autoclavable

| | | | |
|----------|--------|-----------------|--------------------|
| 1103-719 | single | 10" x 6" x 2.5" | deep with flat lid |
| 1103-720 | single | 10" x 6" x 3" | deep with dome lid |

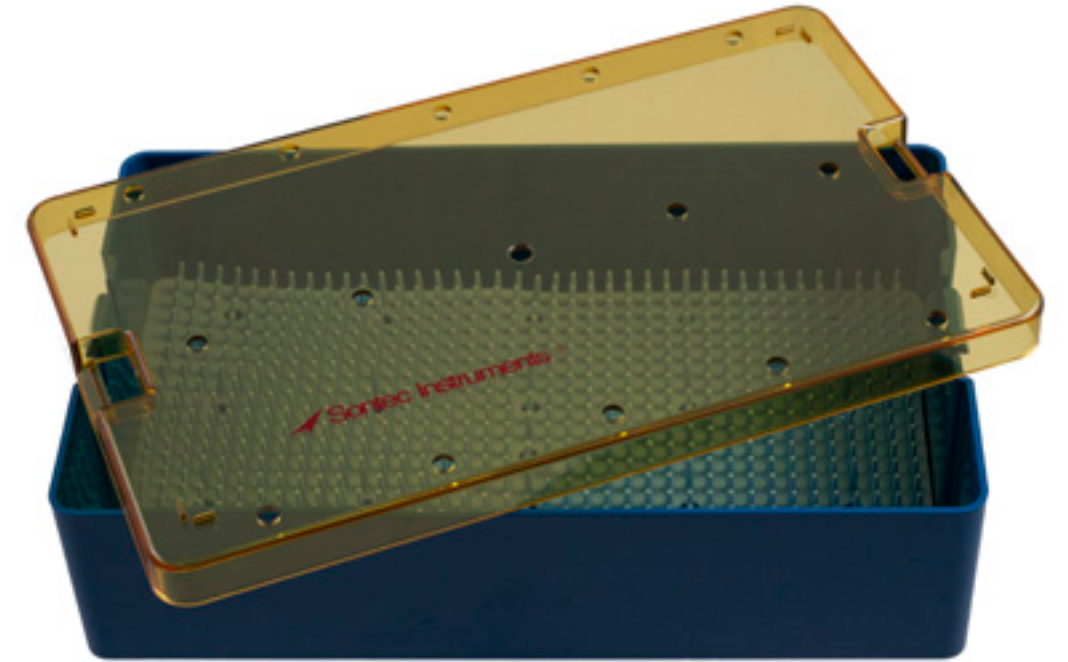

1103-719

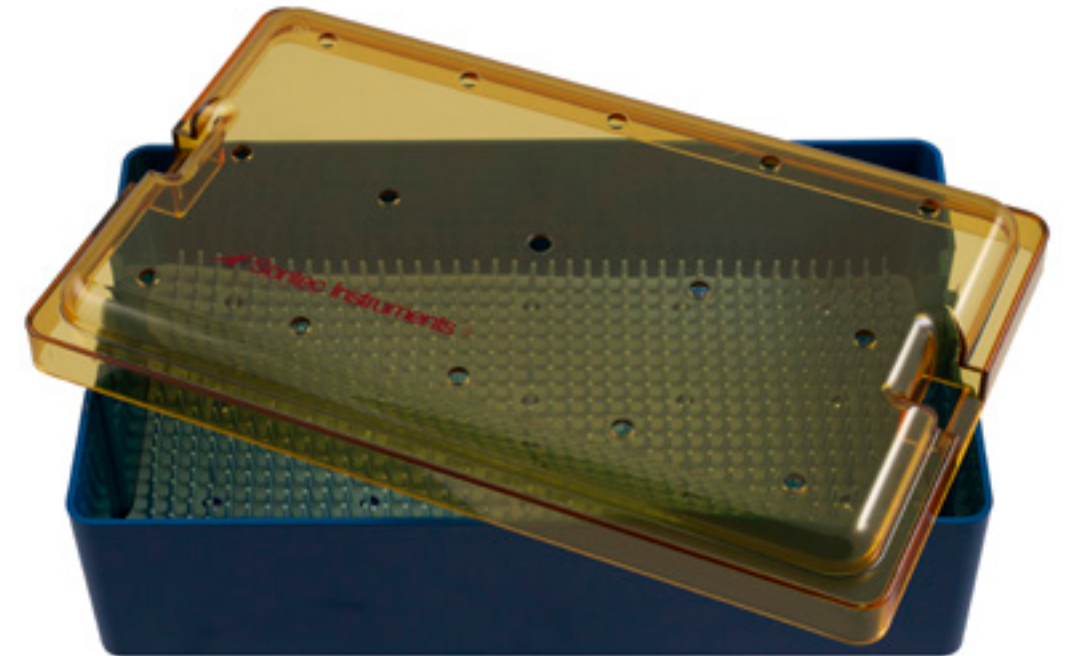

1103-720

Thermoplastic Instrument Tray

With silicone mat / autoclavable

| | | |
|-----------|---------------|------------------------------|
| 1103-702 | single | 6" x 2 1/2" x 3/4" |
| 1103-703 | single | 1.5" x 2.7" x .75" mini tray |
| 1103-705 | single | 6" x 4" x 3/4" |
| 1103-723 | single | 7 1/2" x 4" x 3/4" |
| 1103-710 | single | 10" x 6" x 3/4" |
| 1103-702D | single | 6" x 2 1/2" x 1 1/4" deep |
| 1103-724 | single | 7 1/2" x 4" x 1 1/2" deep |
| 1103-716 | single | 10" x 6" x 1 1/2" deep |
| 1103-715 | double decker | 10" x 6" x 1 1/2" |



1103-703

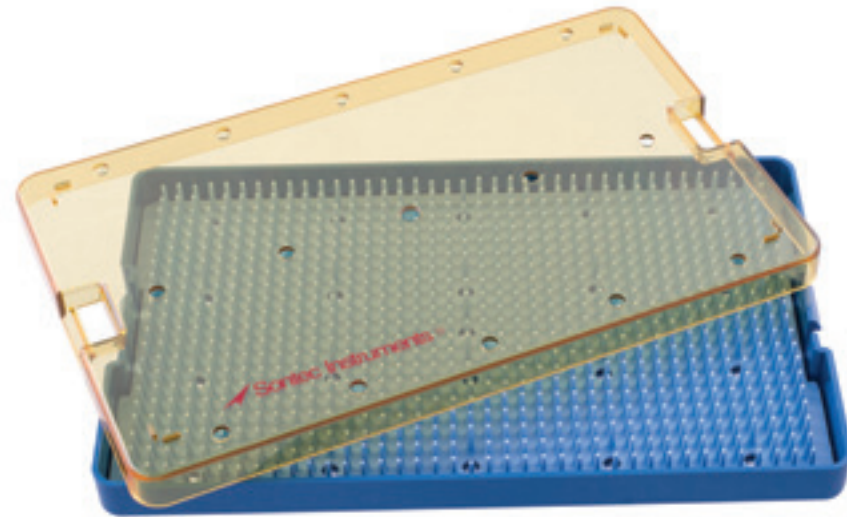

1103-710

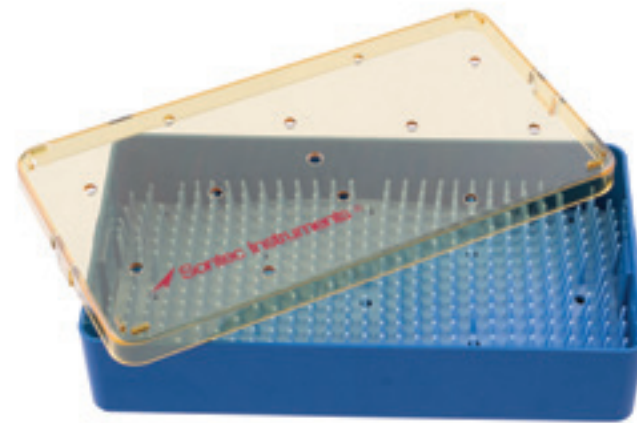

1103-724

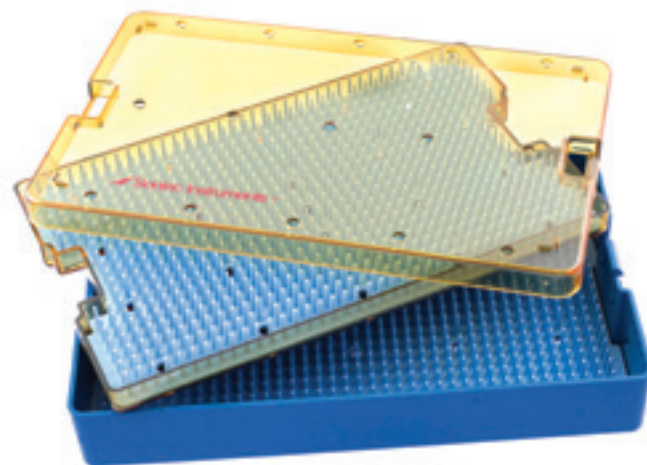

1103-715

Thermoplastic Instrument Tray

With silicone mat / autoclavable

| | | |
|---------|---------------|-------------------------|
| 18-3214 | single | 10" x 15" x 3/4" |
| 18-3215 | single | 10" x 15" x 1 1/2" deep |
| 18-3213 | double decker | 10" x 15" x 1 1/2" |

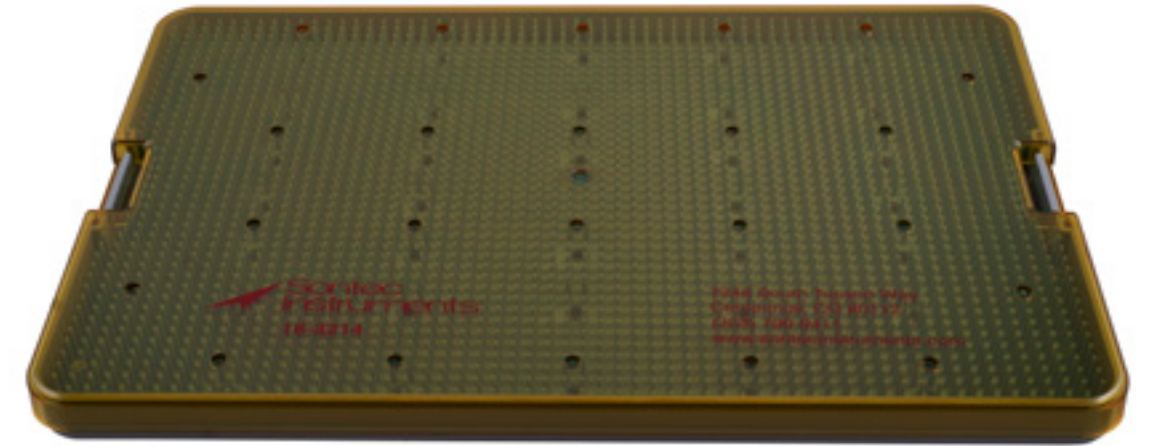

18-3214

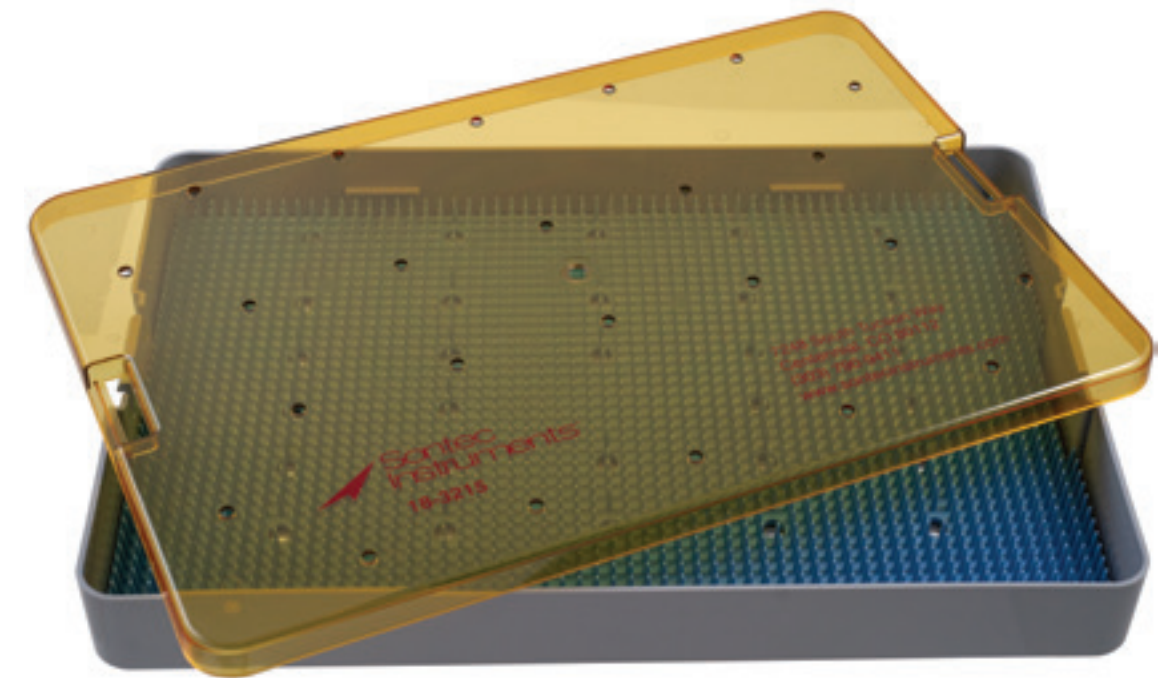

18-3215

Thermoplastic Instrument Trays

With silicone mat and metal clasps / autoclavable

- 1103-717 double decker 11" x 7" x 1 1/2"
- 1103-717D single deep 11" x 7" x 1 1/2"
- 1103-712 single shallow 11" x 7" x 3/4"

* Other sizes available upon request, requires special order. Check your measurements.

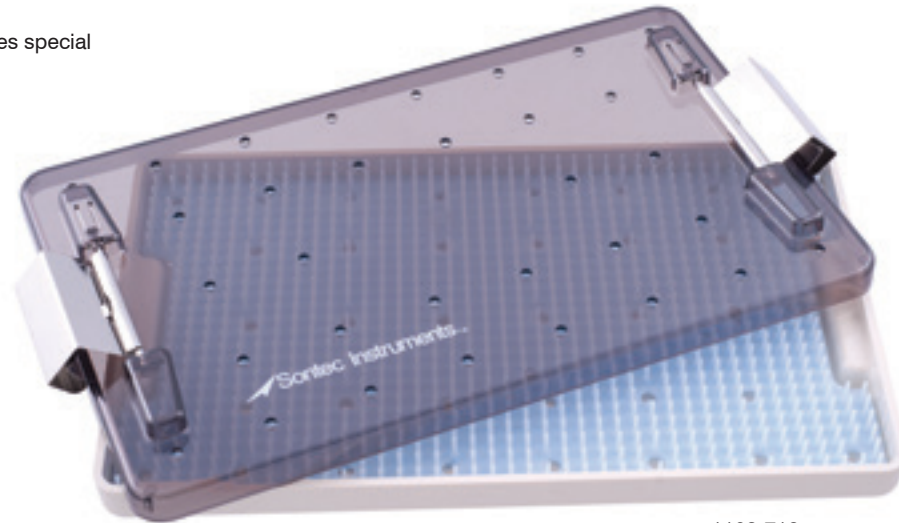

1103-712

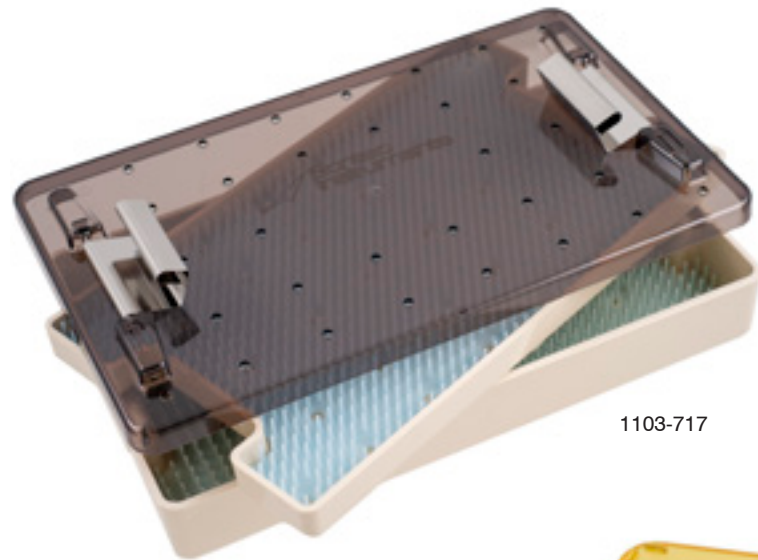

1103-717

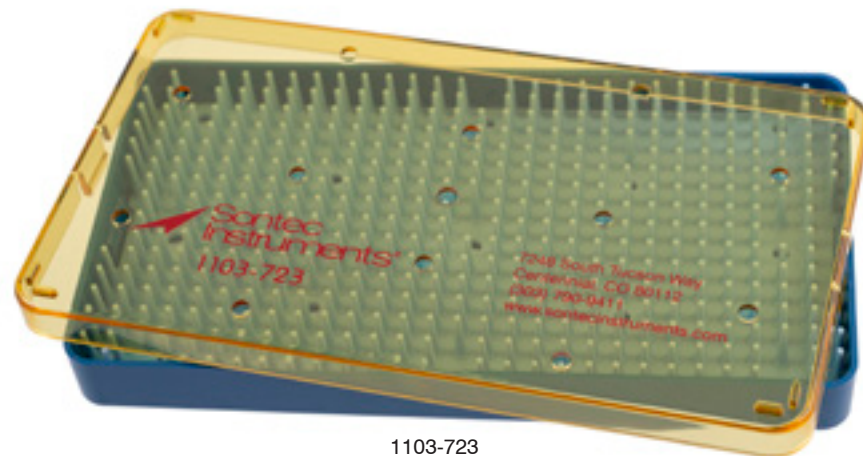

1103-723

Sontec Slim Thermoplastic Instrument Tray

- 18-3209 tray 10.3" x 18.3" x 2.33"
- 18-3270 tray 18.3" x 8.35" x 2"

* "Check Your Measurements", These items are FINAL SALE



18-3209



18-3270

Catheter Trays & Dome Lid Covers

Heavy duty / seamless / for catheter trays / strap handles / easy to handle

ST83 8 3/4" x 3 1/4" x 1 1/2" Tray
ST83-2 Lid Cover: fits tray ST83

ST17-0-0 17 1/4" x 4 1/2" x 2" Tray
ST17-0-2 Lid Cover: fits tray ST170

ST95-2 8 7/8" x 5" x 2" Tray
ST95-3 8 7/8" x 5" x 3" Tray
ST95-2D-2 Lid Cover: fits trays ST952 & ST953

* "Check Your Measurements"
These items are FINAL SALE



ST95-2

Stainless Steel Instrument Trays, Lid Covers & Perforated Nesting Sterilization Instrument Trays

Used for hot or cold sterilization / for Sterilization Trays / recessed strap handles / easy to handle / easy to store / safe to transport

STE2-0124 solid 20 3/4" x 12 3/4" x 4" Tray
STP2-0122 perforated 20 3/4" x 12 3/4" x 2 1/2" Tray
STE2-0126 solid 20 3/4" x 12 3/4" x 6" Tray
STP2-0124 perforated 20 3/4" x 12 3/4" x 4" Tray
ST20-00-2 Lid Cover: fits trays STE20124, STP20122, STE20126, STP20124

STE1-2104 solid 12 3/4" x 10 3/8" x 4" Tray
STP1-2102 perforated 12 3/4" x 10 3/8" x 2 1/2" Tray
STP1-2104 perforated 12 3/4" x 10 3/8" x 4" Tray
ST13-11-2 Lid Cover: fits trays STE1-2104, STP1-2102, STP1-2104



STP1-2104

Stainless Steel Instrument Trays & Lid Covers

Heavy duty / seamless / covered corners / easy to sterilize / for instrument trays / recessed strap handles / easy to handle / easy to store

ST43 5 3/8" x 4" x 2 5/8" Tray
ST43-2 Lid Cover: fits tray ST43

ST63 6 1/8" x 6 1/8" x 2 7/8" Tray
ST63-2 Lid Cover: fits tray ST63

ST95-3 8 7/8" x 5" x 3" Tray
ST95-2 8 7/8" x 5" x 2" Tray
ST95-2-2 Lid Cover: fits trays ST952 & ST953

ST10-02 10" x 6 1/2" x 2" Tray
ST10-02-2 Lid Cover: fits tray ST1002

ST12-02 12 1/4" x 7 3/4" x 2 1/4" Tray
ST12-02-2 Lid Cover: fits tray ST1202

STE1-082 10" x 8 1/4" x 2 1/2" Tray
ST10-82-2 Lid Cover: fits trays STE1082

STE1-654 16 1/2" x 10" x 4" Tray
STE1-650 16 1/2" x 10" x 2 1/2" Tray
ST16-50-2 Lid Cover: fits trays STE1650 & STE1654

STE9-02 6 7/8" x 4 1/4" x 2" Tray

STE2-304 13 7/8" x 12 7/8" x 4" Tray
STE2-302 13 7/8" x 12 7/8" x 2 1/2" Tray

STE0-6066 6 7/8" x 6 3/8" x 6" Tray
STE0-6064 6 7/8" x 6 3/8" x 4" Tray
STE0-6062 6 7/8" x 6 3/8" x 2 1/2" Tray
ST60-2-2 Lid Cover: fits trays STE06062, STE06064 & STE06066

STE1-0066 10 3/8" x 6 3/8" x 6" Tray
STE1-0064 10 3/8" x 6 3/8" x 4" Tray
STE1-0062 10 3/8" x 6 3/8" x 2 1/2" Tray
ST40-2-2 Lid Cover: fits trays STE10062, STE10064 & STE10066

* "Check Your Measurements", These items are FINAL SALE

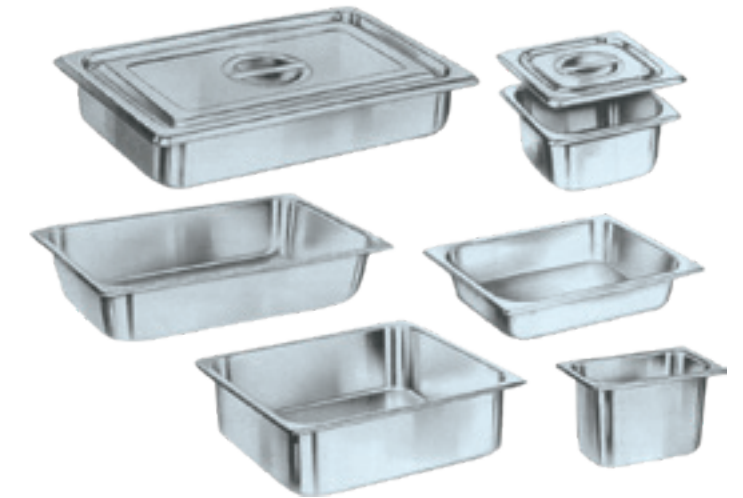

ST95-2



ST16-50-2



STE1-654

Stainless Steel Instrument Trays & Lid Covers **Continued**

For instrument trays / standard weight / 22 gauge

- STE1-2066 12 3/4" x 6 7/8" x 6" Tray
- STE1-2064 12 3/4" x 6 7/8" x 4" Tray
- STE1-2062 12 3/4" x 6 7/8" x 2 1/2" Tray

Heavy weight / 20 gauge

- STS1-2066 12 3/4" x 6 7/8" x 6" Tray
- STS1-2064 12 3/4" x 6 7/8" x 4" Tray
- STS1-2062 12 3/4" x 6 7/8" x 2 1/2" Tray
- ST30-2-2 Lid Cover: fits trays STE1-2062, STE1-2064, STE1-2066, STS1-2062, STS1-2064, STS1-2066

Standard weight / 22 gauge

- STE1-2106 12 3/4" x 10 3/8" x 6" Tray
- STE1-2104 12 3/4" x 10 3/8" x 4" Tray
- STE1-2102 12 3/4" x 10 3/8" x 2 1/2" Tray

Heavy weight / 20 gauge

- STS1-2106 12 3/4" x 10 3/8" x 6" Tray
- STS1-2104 12 3/4" x 10 3/8" x 4" Tray
- STS1-2102 12 3/4" x 10 3/8" x 2 1/2" Tray
- ST13-11-2 Lid Cover: fits trays STE1-2102, STE1-2104, STE1-2106, STS1-2102, STS1-2104, STS1-2106

Standard weight / 22 gauge

- STE2-0126 20 3/4" x 12 3/4" x 6" Tray
- STE2-0124 20 3/4" x 12 3/4" x 4" Tray
- STE2-0122 20 3/4" x 12 3/4" x 2 1/2" Tray

Heavy weight / 20 gauge

- STS2-0126 20 3/4" x 12 3/4" x 6" Tray
- STS2-0124 20 3/4" x 12 3/4" x 4" Tray
- STS2-0122 20 3/4" x 12 3/4" x 2 1/2" Tray
- ST20-00-2 Lid Cover: fits trays STE2-0122, STE2-0124, STE2-0126, STE2-0122, STE2-0124, STE2-0126

* "Check Your Measurements", These items are FINAL SALE

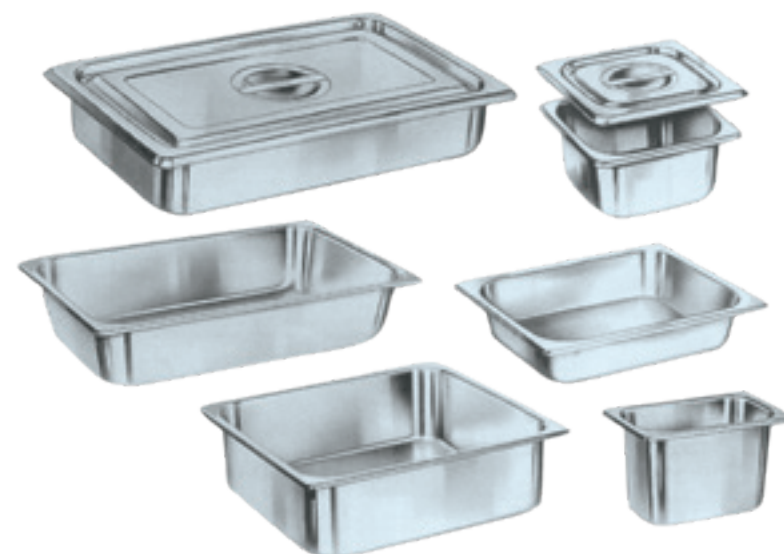

STS1-2104

Emesis Basin

- ST6 10 oz.
- ST8 12 oz.
- ST10 26 oz.
- ST12 50 oz.



Instrument Tray

Rolled edge

- ST10-F 10" x 6 1/2" x 3/4"
- ST13-F 13 1/2" x 9 3/4" x 3/4"
- ST15-20 21 1/4" x 16 1/4" x 7/8"
- ST15-F 15 1/8" x 10 5/8" x 3/4"
- ST17-F 17" x 11 5/8" x 3/4"
- ST19-F 19 1/8" x 12 5/8" x 3/4"



Perforated Mayo Tray

- ST10-F-PMT 10" x 6 1/2" x 3/4"
- ST15-20-PMT 21 1/4" x 16 1/4" x 7/8"
- ST15-F-PMT 15 1/8" x 10 5/8" x 3/4"
- ST17-F-PMT 17" x 11 5/8" x 3/4"
- ST19-F-PMT 19 1/8" x 12 5/8" x 3/4"



Non-Perforated Mayo Tray

| | |
|---------|--------------------------|
| ST3-926 | 10" x 6 1/2" x 3/4" |
| ST3-927 | 14" x 10" x 5/8" |
| ST3-929 | 17" x 11 5/8" x 3/4" |
| ST3-930 | 19 1/8" x 12 5/8" x 3/4" |



ST3-926



ST3-927



ST3-930

Iodine Cup

| | |
|--------|------------------------|
| ST6G | 6 oz. 3 7/16" x 2" |
| ST14-G | 14 oz. 4 3/8" x 2 5/8" |

* "Check Your Measurements",
These items are FINAL SALE



ST14-G



ST6G

Sponge Bowl

Flat bottom / straight sides / extra stable

| | | |
|--------|--------|-------------------|
| ST10-7 | 64 oz. | 7 9/16" x 3" |
| ST14-8 | 48 oz. | 7 1/8" x 2 3/4" |
| ST10-6 | 36 oz. | 6 1/4" x 2 3/4" |
| ST10-0 | 30 oz. | 5 9/16" x 2 9/16" |
| ST75 | 20 oz. | 5" x 2 3/8" |
| ST52 | 14 oz. | 4 1/4" x 2" |

* "Check Your Measurements", These items are FINAL SALE



ST10-6



ST52



ST75

Dressing Jar

With cover / cover included with jar

| | |
|------|-------------|
| ST2J | 2 quart |
| ST3J | 3 quart |
| ST4J | 4 3/4 quart |



Forceps Jar

| | |
|--------|----------------|
| ST14-K | 1 x 4" |
| ST32-K | 2 1/4 x 4 1/2" |
| ST72-K | 2 1/4 x 7" |



ST14-K

Medicine Cup

ST2 2 oz.



Sontec Scrub Pants

- 103-109 small
- 103-110 medium
- 103-111 large



Sontec Instrument Fabric Barrier Wrap 2Ply

- 103-115 18 x 18"
- 103-117 24 x 24"
- 103-119 30 x 30"



Sontec Forceps Holder

Side lock / pin

- 125-634 2 1/2" x 6" (15.2 cm)
- 125-635 2 1/2" x 8" (20.3 cm)
- 125-636 2 1/2" x 10" (25.4 cm)
- 125-637 2 1/2" x 12" (30.5 cm)
- 125-638 2 1/2" x 16" (40.6 cm)
- 125-639 2 1/2" x 18" (45.7 cm)

Open U

- 125-661 2 1/2" x 6" (15.2 cm)
- 125-662 2 1/2" x 8" (20.3 cm)
- 125-663 2 1/2" x 10" (25.4 cm)
- 125-664 2 1/2" x 12" (30.5 cm)

Center lock / hook

- 125-666 2 1/2" x 6" (15.2 cm)
- 125-667 2 1/2" x 8" (20.3 cm)
- 125-668 2 1/2" x 10" (25.4 cm)
- 125-669 2 1/2" x 12" (30.5 cm)
- 125-670 2 1/2" x 16" (40.6 cm)
- 125-671 2 1/2" x 18" (45.7 cm)

Side lock / wide / hook

- 125-640 2 1/2" x 8" (20.5 cm)
- 125-642 2 1/2" x 10" (25.5 cm)
- 125-644 2 1/2" x 12" (30.5 cm)
- 125-646 2 1/2" x 16" (41 cm)

Side lock

- 125-655 5" x 8" (20.3 cm)
- 125-656 5" x 10" (25.4 cm)
- 125-657 5" x 12" (30.5 cm)
- 125-658 5" x 16" (40.6 cm)
- 125-659 5" x 18" (45.7 cm)

Closed U

- 125-673 2 1/2" x 6" (15.2 cm)
- 125-674 2 1/2" x 8" (20.3 cm)
- 125-675 2 1/2" x 10" (25.4 cm)
- 125-676 2 1/2" x 12" (30.5 cm)

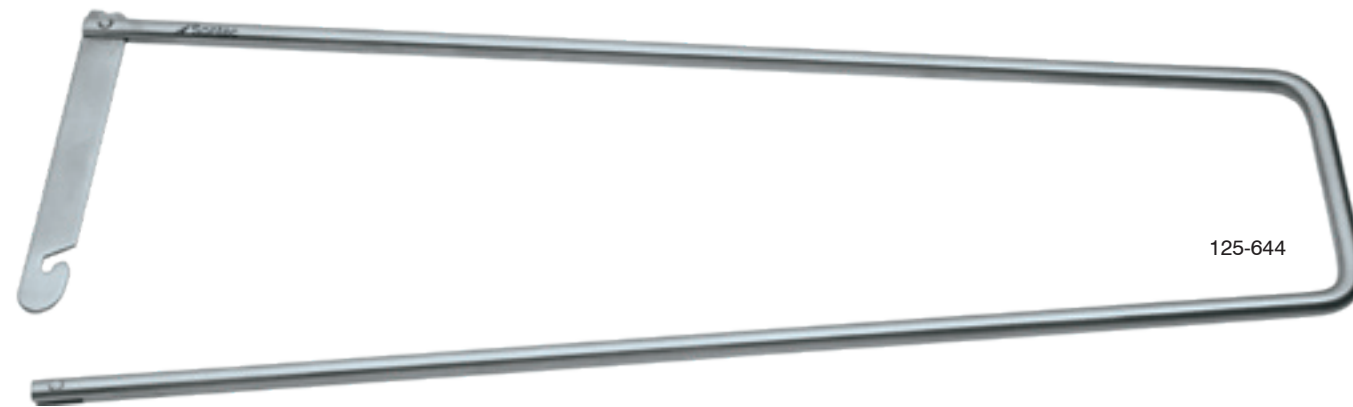

Stringer Forceps Holder

With loop end

- 127-227 6"
- 127-228 8"
- 127-226 10"
- 127-229 12"



Bunt Forceps Holder Ring

With loop end

- 1100-788

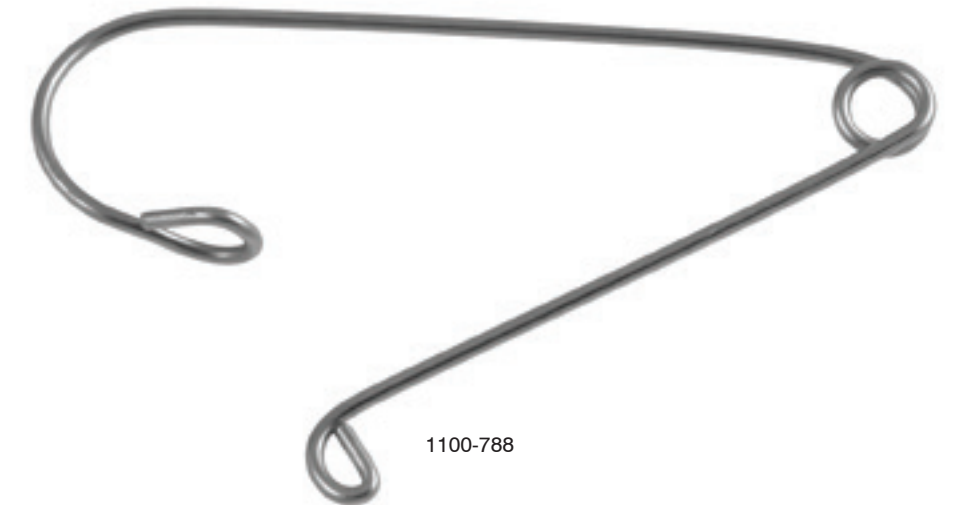

Needle Boat / Spiral Rack

For holding needles

- 1103-730

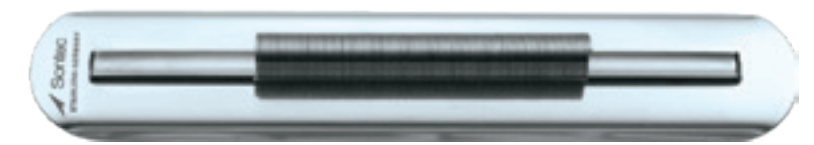

Tip Cover

For surgical instrument tip protection / economical & long-lasting / prevents damaging tips and edges / steam-permeable / autoclavable / conveniently color coded / soft vinyl construction, no latex / for a wide variety of instruments, including: scissors, forceps, curettes, drills, and retractors

* See colors online
 * Larger sizes available. Please call for details.
 * Individual styles, packaged 100 per bag

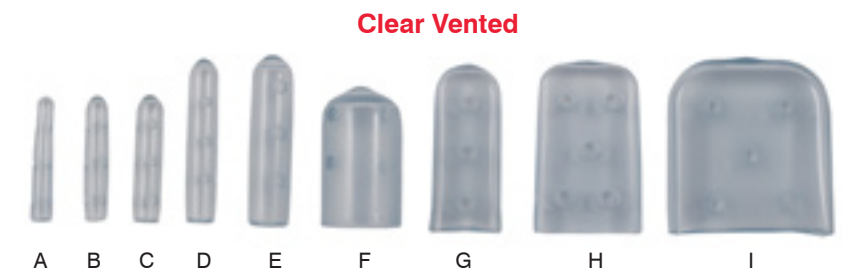
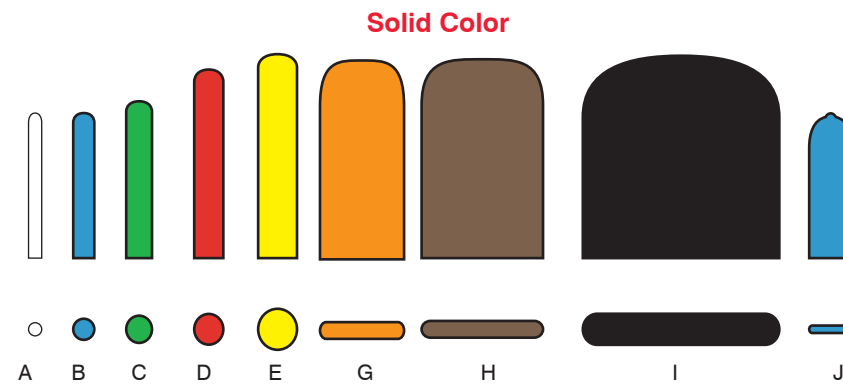

Individual styles, packaged 100 per bag

| | Color | Solid # | Tinted # |
|---|--------|---------|----------|
| A | White | 105-730 | 105-782 |
| B | Blue | 105-732 | 105-783 |
| C | Green | 105-734 | 105-784 |
| D | Red | 105-736 | 105-785 |
| E | Yellow | 105-738 | 105-786 |
| G | Orange | 105-742 | 105-787 |
| H | Brown | 105-744 | 105-789 |
| I | Black | 105-746 | 105-790 |
| J | Blue | 105-764 | N/A |

Individual styles, packaged 100 per bag

| | Size | Item # |
|---|----------------------|----------|
| A | 1.6 mm x 19 mm | 105-791 |
| B | 2 mm x 19 mm | 105-792 |
| C | 2.8 mm x 19 mm | 105-793 |
| D | 3 mm x 25 mm x 25 mm | 105-794 |
| E | 3.2 mm x 25.4 mm | 105-7951 |
| F | 5 mm x 25 mm | 105-796 |
| G | 10 mm x 19 mm | 105-797 |
| H | 2 mm x 9 mm x 25 mm | 105-798 |
| I | 2 mm x 16 mm x 25 mm | 105-799 |
| | Assorted Sizes | 105-791A |

Available Assortments

| | Solid # | Tinted # | Clear Vented | Description |
|----------------|---------|----------|--------------|-------------------------------------|
| Large Assorted | 105-748 | 105-780 | | Bag of 100, Equal parts A - J |
| Small Assorted | 105-750 | 105-781 | | Bag of 100, Equal parts A - E, G, J |
| Large Assorted | | | 105-791A | Bag of 100 All sizes A - I |

Sontec® Sheet Tape

For surgical instrument identification / color-codes instruments with pre-cut strips / each 8 1/2" x 11" sheet contains: 44 strips, 2" long x 1/4" wide / 220 strips, 1" long x 1/4" wide (total: 264 strips, 374" of tape)

* See colors online
 * PLEASE NOTE: Sontec® Sheet Tape is not recommended for use with cold sterilization fluids.
 * Size and color of tapes may vary slightly from actual products



| | | | | | |
|--|---------------------|--|-----------------------|---|-----------------------------------|
| | 105-610 White | | 105-581 Plum | | 105-640 Fuchsia |
| | 105-612 Kelly Green | | 105-540 Blue/Green | | 105-642 Medical Blue |
| | 105-614 Red | | 105-541 Blue/Red | | 105-644 Emerald Green |
| | 105-616 Yellow | | 105-542 Yellow/Blue | | 105-646 Violet |
| | 105-618 Orange | | 105-543 Yellow/Green | | 105-660 Fuchsia |
| | 105-620 Gray | | 105-544 Yellow/Red | | 105-662 Medical Blue |
| | 105-622 Lavender | | 105-686 Purple/Black | | 105-664 Emerald Green |
| | 105-624 Beige | | 105-688 Orange/Black | | 105-666 Violet |
| | 105-626 Light Blue | | 105-690 Blue/Black | | 105-590 Smiley Face, Yellow/Black |
| | 105-628 Lime Green | | 105-692 Rubine/Black | | 105-600 Red Hearts on White |
| | 105-630 Pink | | 105-694 Yellow/Black | | 105-602 White Hearts on Red |
| | 105-632 Plum | | 105-696 Green/Black | | 105-670 Fuchsia* |
| | 105-570 Royal Blue | | 105-720 Lime Green | | 105-672 Medical Blue* |
| | 105-571 Kelly Green | | 105-722 Gray | | 105-674 Emerald Green* |
| | 105-572 Red | | 105-723 Beige | | 105-676 Violet* |
| | 105-573 Yellow | | 105-724 Light Blue | * Each color sheet contains numbers 0 - 8 | |
| | 105-574 Orange | | 105-725 Pink | | 105-550 Red/White/Blue |
| | 105-575 Brown | | 105-726 Plum | | 105-551 Red/White/Black |
| | 105-576 Black | | 105-727 Lavender | | 105-552 Red/Yellow/Black |
| | 105-577 Lavender | | 105-650 Fuchsia | | 105-553 Red/Black/Green |
| | 105-578 Light Blue | | 105-652 Medical Blue | Above Styles: 3/8" wide, 245" total tape | |
| | 105-579 Lime Green | | 105-654 Emerald Green | | |
| | 105-580 Pink | | 105-656 Violet | | |







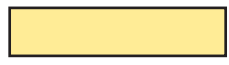

Medi-Mark™ Tape

Surgical instrument color coding system / fast and efficient identification system / available in 9 solid colors / one spool codes an average of 230 instruments / clinically proven safe in conventional, flash and gas sterilization / bonds to itself / lasts many months

* PLEASE NOTE: Medi-Mark™ Tape is not recommended for use with cold sterilization fluids.
* See colors online

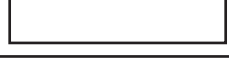
Application of Medi-Mark™ Tape

1. Instrument and hands must be clean and dry.
2. Cut Medi-Mark™ Tape with scissors. DO NOT STRETCH!
3. Overlap Medi-Mark™ Tape once.
4. Replace Medi-Mark™ Tape when color changes, before it becomes brittle.
5. Avoid placing Medi-Mark™ Tape on the shank of scissors.

| | |
|---|-------------------|
|  | 105-700 Green |
|  | 105-702 Yellow |
|  | 105-704 Blue |
|  | 105-706 Red |
|  | 105-708 Brown |
|  | 105-710 White |
|  | 105-712 Orange |
|  | 105-714 Black |
|  | 105-716 Purple |

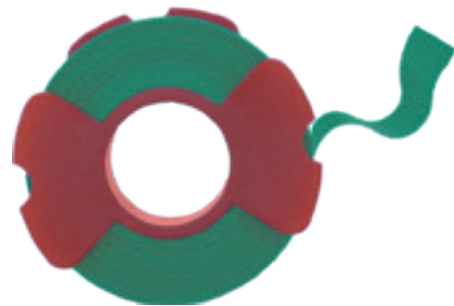

Whisk 'R Brush™

For general purpose cleaning / two bristle lengths & a sure-grip handle / available sterile & non-sterile / convenient & economical / simple to use on various shapes and surfaces / for a wide variety of instruments, including: burs, drill points, rasps, and rongeurs / easily removes bone fragments and soft tissue

- 9B-010 12 sterile brushes
- 9B-025 25 non-sterile brushes
- 9B-020 100 non-sterile brushes



Endozime AW Triple Plus®

- Multi-tiered enzymatic cleaner
- specifically designed for all washers, washer sterilizers, ultrasonics and manual cleaning
- proprietary synergistic mixture of enzymes and non-ionic detergents
- Protease, Amylase, Lipase, Carbohydrase and other proprietary enzymes
- dissolves all blood, fat, protein, carbohydrates and starches
- built in detergent eliminating the need for all other cleaners and detergents
- compatible with all washers, washer sterilizers and ultrasonics
- strong enough for the most difficult instruments but safe on the most delicate

345A-P16 16 oz
345A-PAG1 1 gal



Surgistain®

- Rust and stain remover
- removes rust, pitting, stains and corrosion from stainless steel instruments
- restores instrument's original finish
- restores articulation to box-locks and joints
- prevents destructive pitting on ridges of micro instruments
- non-corrosive; will not harm quality stainless steel

345B-16 16 oz
345B-G1 1 gal



Premixslip®

- instrument lubricant and rust inhibitor
- the only bacteriostatic pre-mixed instrument lubricant and rust inhibitor
- clinically tested to be thoroughly steam penetrable, steam sterilizable and ETO sterilizable
- prevents rust, spots, stains and corrosion
- non-oily, non-sticky, non-toxic and silicone free
- bacteriostatic high-grade mineral oil lubricant

345P-MX16 16 oz
345P-MXG1 1 gal



Prepzyme®

- multi-tiered enzymatic foam spray
- prevents bio-film from adhering to surface prior to decontamination
- foaming spray covers soiled instruments, scopes and biopsy forceps
- breaks down blood, fat, carbohydrates and starches immediately
- perfect for use in departments where instruments & scope cleaning is not readily available
- safe for all instruments and scopes (flexible or rigid), extends usable lifetime
- neutral PH, non-abrasive, free-rinsing and 100% biodegradable
- will not harm any metals, plastic, rubber, glass or corrugated tubing

345P-RP08 8 oz (with sprayer)
345P-RP22 22 oz (with sprayer)



F*A*C*T*S®

- foaming autoclave cleaning treatment system
- removes all rust, pitting, stains and corrosion from walls of autoclaves and from stainless steel carts and trays
- removes scale, alkaline and mineral deposits
- foaming spray remains on walls longer for better penetration
- eliminates all noxious odors
- restores original finish to all autoclaves, carts and trays
- non-corrosive; will not harm quality stainless steel

345F-CT22 22oz (with sprayer)





 Sontec Instruments®

KNIFE & BLADE Handles

Knife Handle #3

Fits surgical blades 10-15 / with calibrated scale

* surgical blade not included

1100-740 5" (12.5 cm)



Round handle

1100-741 6" (15 cm)



1100-740

Round knurl handle / double / 1 mm / 6 1/4"

1100-7411



1100-741

1100-7411

Wide Barrel Grip Knife Handle #3

Round knurled / straight / 5" (12.7 cm)

117-577

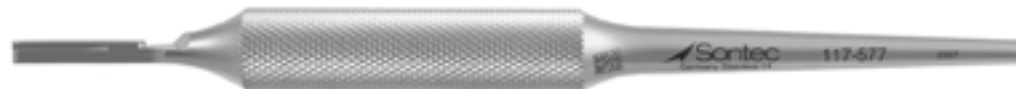

117-577

Universal Adjustable Angle Knife Handle #3

Adjustable tip & lock / straight / 10 mm locking increments of 7 positions / 6 1/2" (16.5 cm)

117-578 vertical adjusting

117-5781 horizontal adjusting



117-578



117-5781

Knife Handle #3L

Fits surgical blades 10-15

1100-866 8 1/2" (21.5 cm)

1100-868 12" (30 cm)

117-582 8 3/8" (20 cm) angled



1100-866



117-582

Staley Round Knurled Knife Handle

Aluminum / 6" (15.2 cm)

117-571



117-571

Sontec Knife Handle #3XXL

16" (40.6 cm)

1100-8681



1100-8681

Knife Handle #3KL

Round handle / 6" (15.2 mm)

117-564



117-564

Chuck Knife Handle #3HL

Hexagonal handle / 6" (15.2 mm)

117-566



117-566

Beaver® Blade Chuck Handle #3K

Fits Beaver® style blades

117-560 4" (10 cm)

T117-560 4" (10 cm) titanium

117-561 3" (7.5 cm)



117-560



T117-560

Beaver® Blade Chuck Handle #3KD

Fits Beaver® style blades / 5.25" (13.5 cm)

117-559



117-559

Blake Blade Holder

Fits size blades #10, 11, 12, 12D, 15, 15C

1100-7413



1100-7413

Knife Handle #4

fits surgical blades 20-25
/ with calibrated scale

1100-742 5" (12.5 cm)



1100-742

Knife Handle #4L

Fits surgical blades 20-25

1100-870 8 1/2" (21.5 cm)
1100-872 12" (30 cm)
117-583 8 3/8" (20 cm) angled



1100-870



117-583

Knife Handle #7

Fits surgical blades 10-15

117-576 6 1/2" (16.5)
117-576A 6 1/2" (16.5) angled



117-576



117-576A

Collett Chuck for Knife Handle

For 3K, 3KL & 3KM handles
19-1801

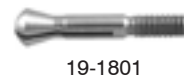

19-1801

Knife Handle #9

Fits surgical blades 10-15
117-585



117-585

Siegel Knife Handle

Fits surgical blades 10-15 /
round handle
117-588



117-588

Gubish Surgical Pen Holder Set

5 1/4" (13 cm)
117-593



chuck

117-593

Gubisch Surgical Pen Replacement Tip

10 to a package
117-594



117-594

Bayonet Spinal Knife Handle

Also available in titanium / 13 3/4" (18.5 cm)
400-428 # 3 use blades 10-15
400-428A # 4 use blades 20-25

* Additional sizes available please call Sontec for more information.



400-428

Self-Locking 3K Chuck Blade Handle

Stainless steel / 5 3/8"
117-555



117-588

Surgical Blade Remover

117-602



117-602



 Sontec Instruments®

CALIPERS & RULERS

Castroviejo Caliper

Scale to 20 mm / 3 1/2" (9 cm)

| | | |
|----------|------------|----------------------------|
| 12-9200 | straight | original with wider shanks |
| 12-9300 | straight | |
| T12-9300 | straight | titanium |
| 12-9300D | straight | deluxe |
| 12-9305 | angled 45° | |
| 12-9310 | curved | |
| 12-9310D | curved | deluxe |
| 12-9315 | angled | |
| 12-9316 | straight | 40 mm scale |
| 12-9318 | angled | 40 mm scale |

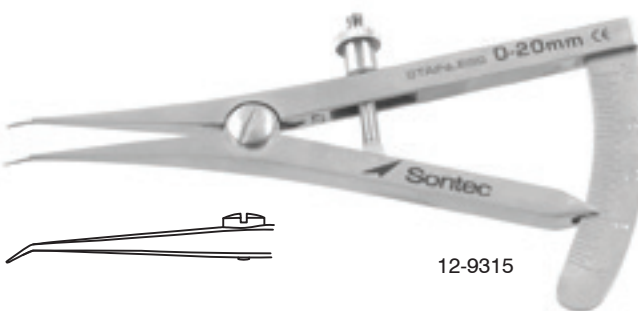
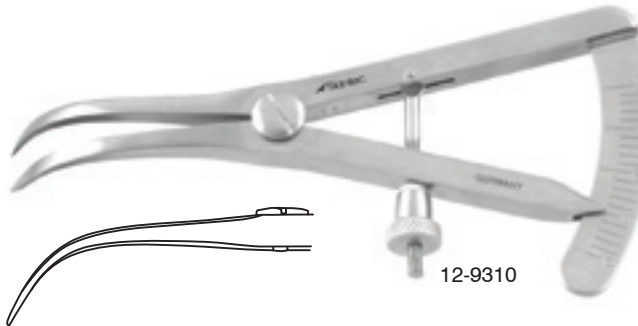
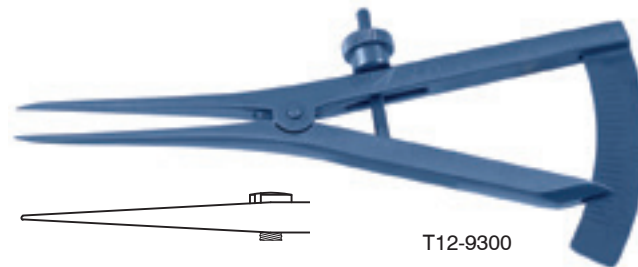
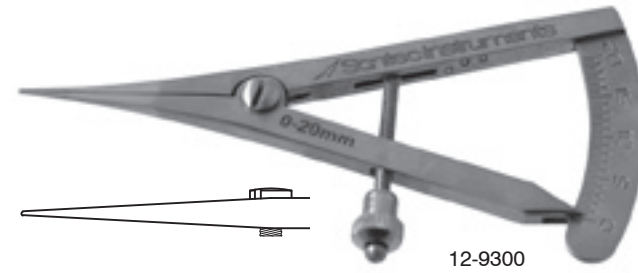

Finger Goniometer

5 3/4" (14.5 cm)
350-915



Castroviejo Body Caliper

0-200 mm gauge / 0-100 mm gauge

| | |
|---------|--------|
| 12-9330 | 100 mm |
| 12-9335 | 200 mm |



Castroviejo Caliper

40 mm / 7" (17.8 cm)

| | |
|---------|----------|
| 12-9320 | straight |
| 12-9325 | angled |



Jameson Caliper

Scale to 3" (8 cm)
12-9450

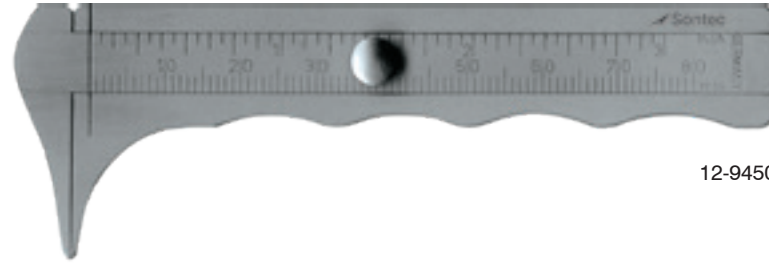

12-9450

Thorpe Caliper

Scale to 3" (8 cm) /
angled / markings in
0.5 mm increments
12-9400



12-9400

Orthopedic Vernier Caliper

Stainless steel / 6" (15.5 cm)
1103-170

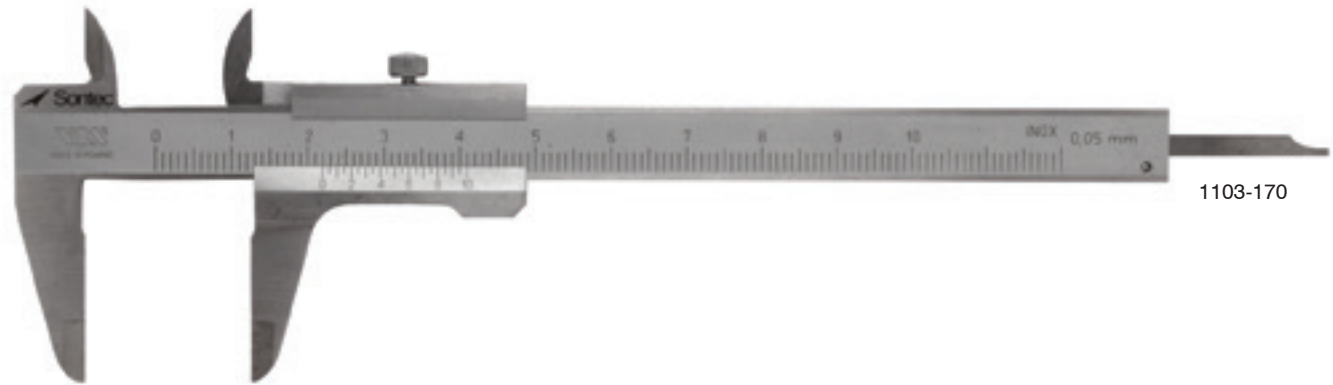

1103-170

Mini Caliper

Scale to 90 mm / 5" (12.5 cm)
12-9425



Braun Fixed Caliper

8 cm / special sizes made to order
12-9340



12-9340

Stahl A/C Lens Gauge

For verifying diameter of A/C
lenses in 1.5 mm increments /
Teflon coated stainless steel
12-9630

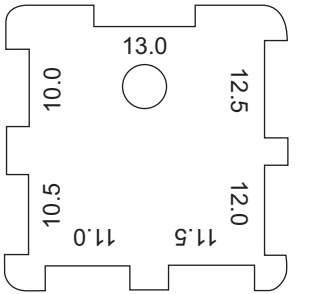

12-9600

Stahl Caliper

A/C caliper for
measuring corneal
diameter prior to A/C
IOL / size markings
on both sides
12-9600



12-9600

House Ear Caliper

With rod mark / 6 1/4" (16 cm)
1463-140 3.5mm
1463-141 4mm
1463-142 4.5mm
1463-143 5mm



1463-142

Schiotz Tonometer

Autoclavable / original model
18-8301 incline scale

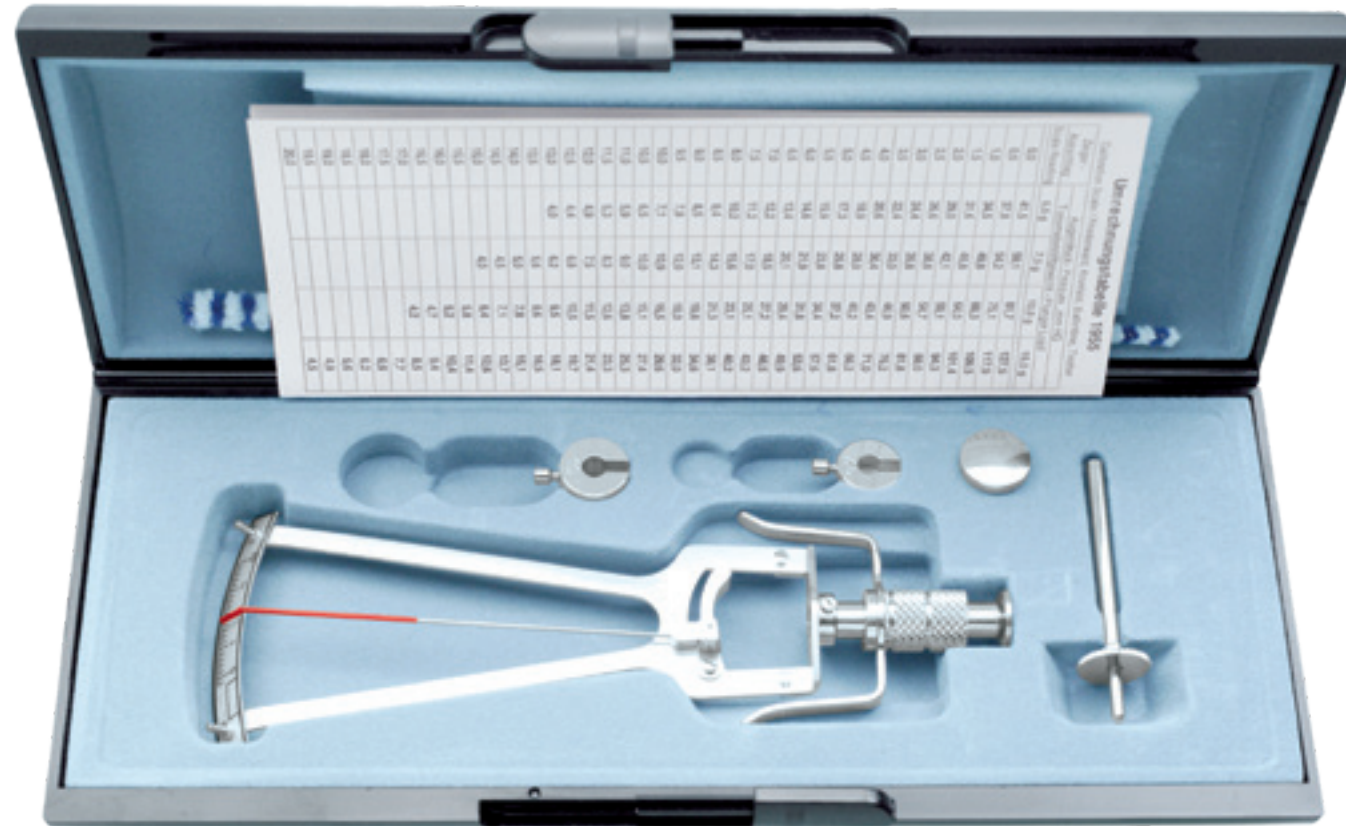

Punched Hole Gauge Ruler

7" (18 cm) in length
1106-190

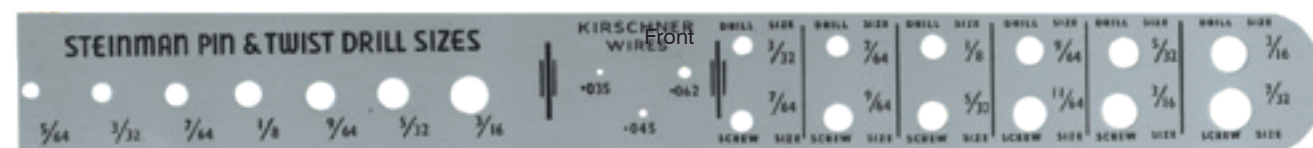
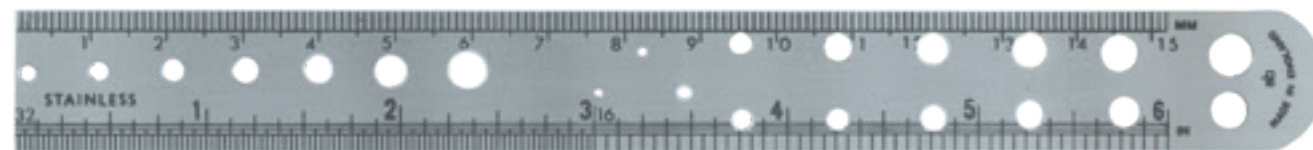

Back

1106-190

Flexible Stainless Ruler

6" (15 cm) / graduated in 1/32"
fractions and millimeters
12-9500

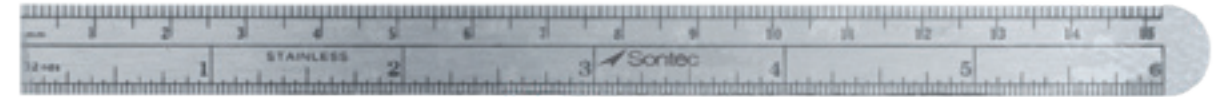

12-9500

TPLO Double-Ended Gauge

- 330-450 5 & 6 mm
- 330-452 7 & 8 mm
- 330-454 9 & 10 mm
- 330-456 11 & 12 mm



330-450



330-452



330-454



330-456



 Sontec Instruments®

ALLIGATOR BIOPSY FORCEPS

Sontec Alligator Forceps

With lock / delicate jaw / delicate shaft

- 1100-328L 3 1/2" (9 cm) long jaw
- 1100-330S 5 1/2" (14 cm) shaft
- 1100-333 6 1/2" (16.5 cm) shaft
- 1100-334 9" (23 cm) shaft



1100-328L



1100-328L



1100-330S



1100-333

Sontec Micro Alligator Forceps

Delicate / lacrimal ducts / 4 mm x 0.9 mm jaw / 3 1/4" (8 cm) shaft

- 469-036 straight without lock
- 469-040 straight with lock
- 469-048 angled left with lock
- 469-050 angled right with lock



469-036



469-040

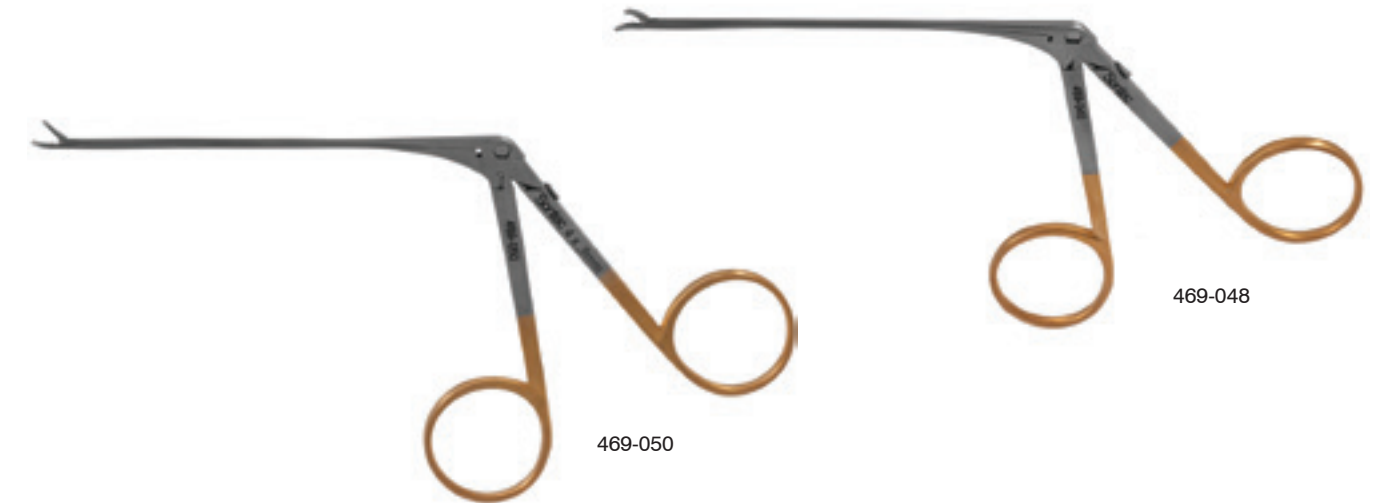

469-048



469-050

Hartman Alligator Forceps

1 x 2 teeth / 6 1/2" (16.5 cm)

- 1100-331



Alligator Forceps Tubular Shaft

Delicate, flexible, tubular shaft / jaw width is uniform / 10 mm length x 1 mm width

- 1271-010 3 1/2" (9 cm) shaft
- 1271-011 5 1/2" (14 cm) shaft
- 1271-012 6 1/2" (16.5 cm) shaft
- 1271-013 9" (23 cm) shaft



1271-010

Sontec Alligator Forceps

Standard jaw / jaw length 10 mm / standard shaft / jaw width 2.2 tapering at tip to 1mm

- 1100-328 3 1/2" (9 cm) shaft
- 1100-330 5 1/2" (14 cm) shaft
- 1100-332 6 1/2" (16.5 cm) shaft



1100-328

Alligator Forceps

With lock / delicate jaw / 3 1/2" (9 cm) delicate shaft

- 1100-328S short jaw



1100-328S

Side Biting Alligator Forceps

10 mm jaw

- 469-009 TC 2 1/4"
- 469-010 TCD 3 1/2"
- 469-012 TC 2 1/2"



1100-012

Micro House Alligator Forceps

Extremely delicate / 3 1/2" (8.9 cm) shaft

469-041Q 3 mm x 0.6 mm jaw

0.6 mm x 7 mm jaw / 3 1/4" (8 cm) shaft

469-042Q angled up

469-046Q angled down



469-041Q



469-046Q

Duckbill Ear Alligator Forceps

Round, flat, serrated jaw

469-015 3" (7.5 cm) shaft



469-015

Greven Alligator Forceps

Serrated jaws / 3 1/4" (8.3 cm)

469-051



469-051

Goodhill Alligator Forceps

5 mm specially tapered jaw
467-352 3" (7.5 cm) shaft



467-352

Alligator Forceps with Malleable Shaft

Delicate, malleable, tubular shaft / serrated
1271-0141 3 1/2" (9 cm) shaft
1271-0142 5 1/2" (14 cm) shaft
1271-0143 6 1/2" (16.5 cm) shaft
1271-0144 9" (23 cm) shaft



1271-0143

Micro Sontec® Alligator Forceps

Extremely delicate / 3" (9 cm) shaft
469-039 straight 4 mm x 0.9 mm jaw
469-041 straight 4 mm x 0.6 mm jaw
469-044 angled up 4 mm x 0.6 mm jaw

Extremely delicate / smooth TC Dust / straight / 4 mm x 0.9 mm jaw / 3" (9 cm) shaft
469-038



469-041



469-038

Micro Ear Alligator Forceps

Black anodized coating / serrated jaw / without lock

| | | | |
|----------|-------------------|---------------------|-----------|
| 469-020 | 4 mm x 0.6 mm jaw | 3 1/4" (8 cm) shaft | |
| 469-020S | 3 mm x 0.6 mm jaw | 3 1/4" (8 cm) shaft | short jaw |
| 469-021 | 5 mm x 0.8 mm jaw | 3 1/4" (8 cm) shaft | |

Oval cup

| | | |
|---------|------------|---------------------|
| 469-026 | 0.8 mm cup | 3 1/4" (8 cm) shaft |
|---------|------------|---------------------|



Micro Ear Alligator Forceps

Black anodized coating / serrated jaw / with lock / 3 1/2"

| | |
|----------|---------------|
| 469-036B | 4 mm x 0.9 mm |
| 469-041B | 3 mm x 0.6 mm |



Micro Ear Alligator Forceps

Black anodized coating / delicate serrated jaw / 4 mm x 0.9 mm / with lock / 3 1/2"

469-048B left curved
469-050B right curved



Micro Alligator Grasping Forceps

Black anodized coating / delicate shaft & jaw / with lock / 3"

1100-328LB



Goodhill Ear Forceps

Black anodized coating / delicate shaft & jaw / with lock / 3"

467-352B



Micro Sontec Alligator Forceps

Black anodized coating / extremely delicate / 4 mm x 0.9 mm / 3 1/2"

469-039B



Hartman Alligator Forceps

Black anodized coating / standard shaft / 10 mm serrated jaw / jaw width 2.2 tapering at tip to 1 mm / 3 1/2"

1100-328B



Micro House Biopsy Alligator Forceps

3 1/2" (9 cm) shaft

- 469-070 straight 1.2 mm x 0.9 mm oval cup
- 469-071 straight 1.0 mm x 0.6 mm oval cup
- 469-072 angled up 1.0 mm x 0.6 mm oval cup
- 469-074 angled down 1.0 mm x 0.6 mm oval cup
- 469-078 angled right 1.0 mm x 0.6 mm oval cup
- 469-076 angled left 1.0 mm x 0.6 mm oval cup

3" (7.5 cm) shaft

- 469-070B straight 1.2 mm x 0.9 mm oval cup

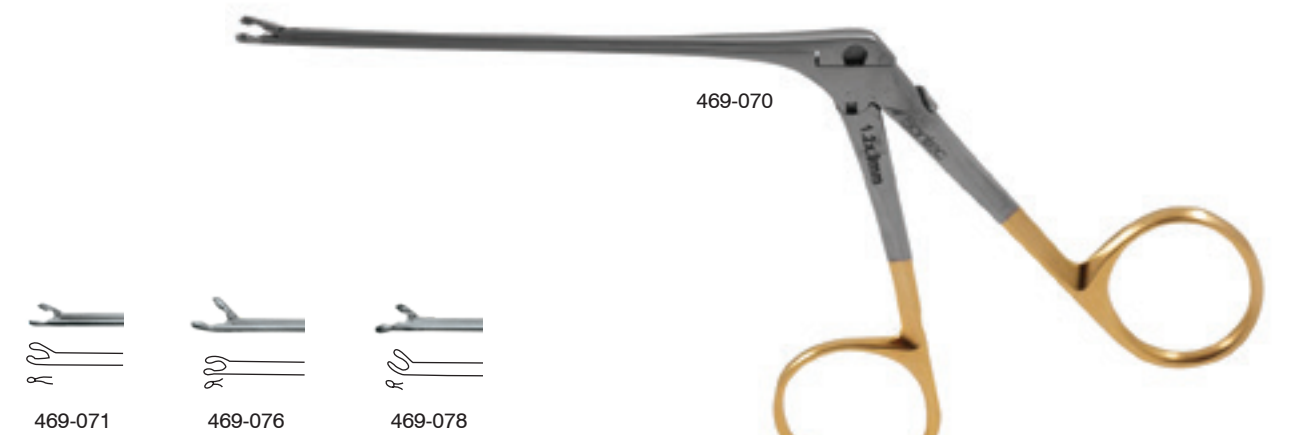

Micro Biopsy Forceps with Flexible Tubular Shaft

Tapered tubular shaft / 1mm round cup jaw

- 1271-0151 3 1/2" (9 cm)
- 1271-0152 5 1/2" (14 cm)
- 1271-0153 6 1/2" (16.5 cm)
- 1271-0154 9" (23 cm)



Hartmann-Noyes Alligator Forceps

Strong jaw / 5 mm x 1.0 mm cup / 3 1/2" (9 cm) shaft

- 467-339U angled up
- 467-339 straight micro serrated



Arthroscopic Grasping & Biopsy Combo Rongeur Forceps

Tubular shaft / serrated bite

- 1271-020 2.0 mm cup 4" (10 cm) shaft
- 1271-020R 2.0 mm cup 4" (10 cm) shaft
- 1271-016 2.7 mm cup 4" (10 cm) shaft
- 1271-018 3.4 mm cup 4" (10 cm) shaft
- 1271-021 2.0 mm cup 6" (15.5 cm) shaft
- 1271-021A 2.0 mm cup 6" (15.5 cm) shaft rear actuator handle



* Available in 4.5 mm, please ask for details



Mini Arthroscopic Small Joints Rongeur Set

Tubular 4" (10.2 cm) shaft / 2.0 mm jaws

- 1271-005 grasping forceps
- 1271-005A grasping forceps rear actuator handle 6"
- 1271-006 fine scissors
- 1271-007 basket punch
- 1271-008 round cup biopsy rear actuator handle
- 1271-009 round cup biopsy

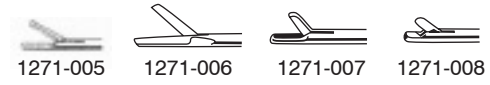

* All tubular shaft instruments available upon request with rear actuator handles



1271-005A



1271-008

Frontal Sinus Giraffe Punch

Double Action Cup / 50 degree / 5 3/4" (14.6 cm) shaft

- 468-340 vertical 2 mm
- 468-342 horizontal 2 mm

Double Action Cup / 90 degree / 5 3/4" (14.6 cm) shaft

- 468-343 horizontal 2 mm
- 468-344 vertical 2 mm



468-340



468-342



468-343



468-344

Frontal Sinus Giraffe Forceps

Double Action Cup / 45 degrees / 5 1/4" (13.5 cm) shaft

- 468-330 vertical 2 mm
- 468-331 horizontal 2 mm

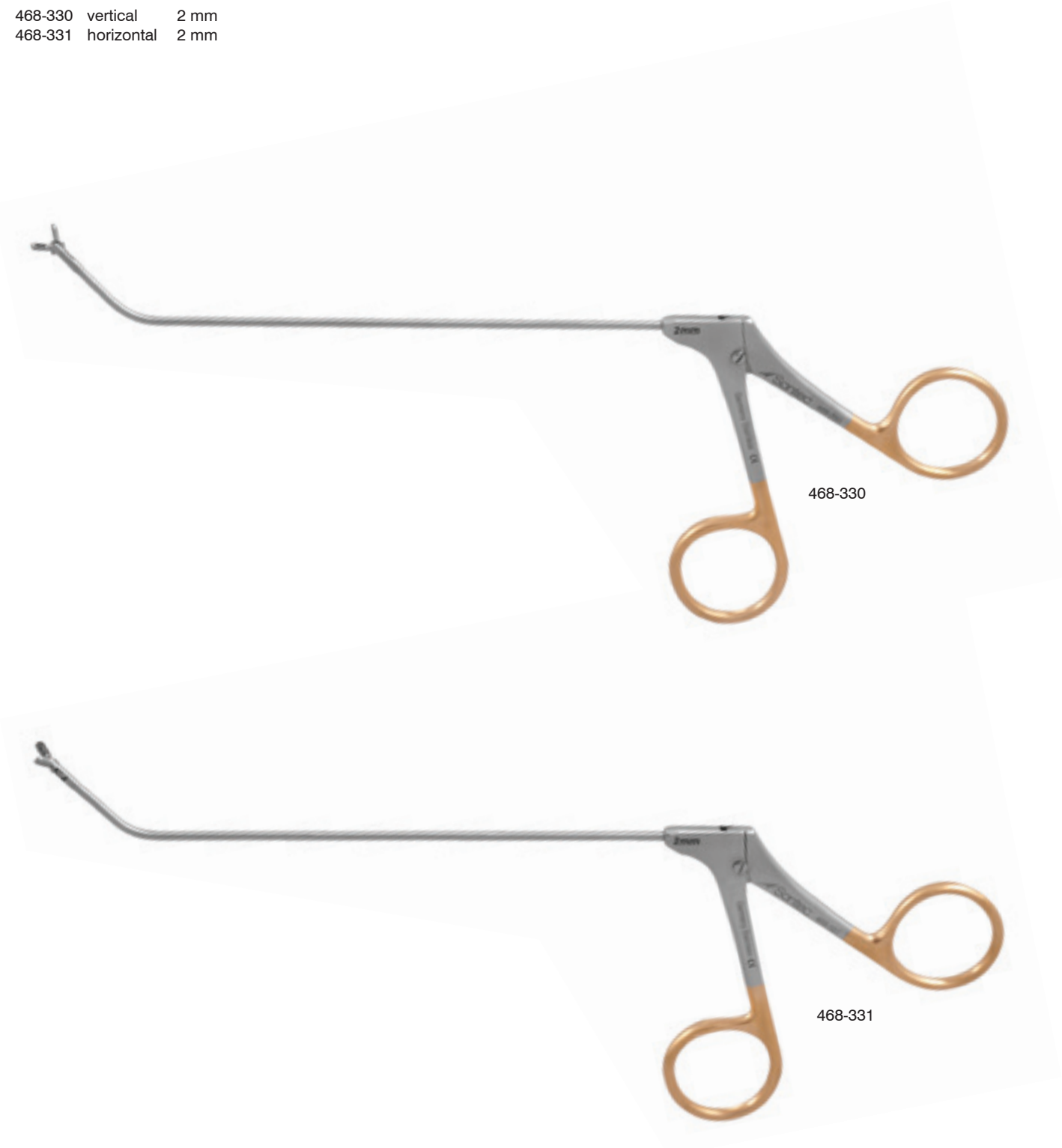

Frontal Sinus Giraffe Forceps

Double Action Cup / 45 degrees / 5 1/4" (13.5 cm) shaft

- 468-332 vertical 3 mm
- 468-333 horizontal 3 mm

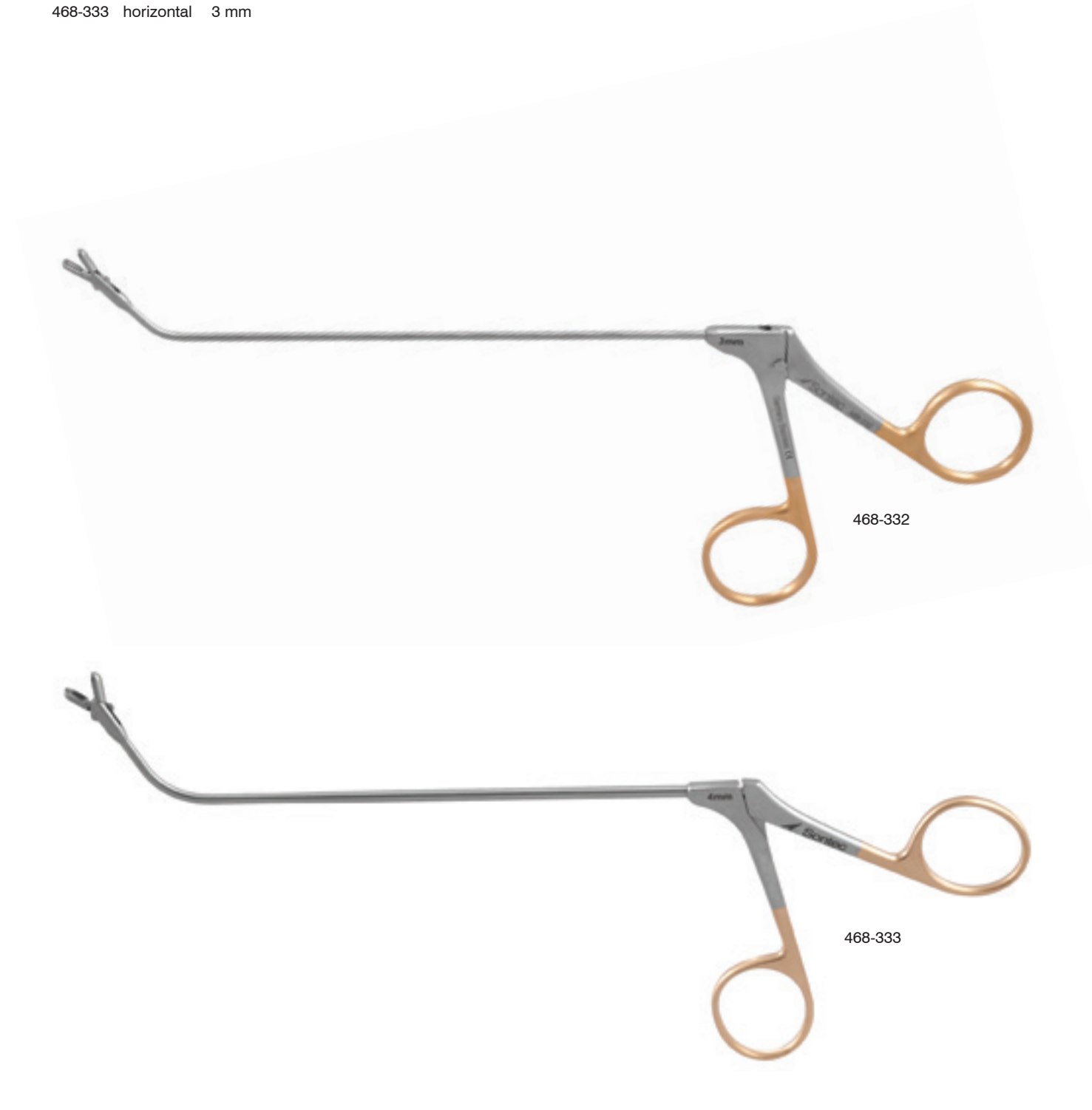

Frontal Sinus Giraffe Forceps

Double Action Cup / 90 degrees / 5 1/4" (13.5 cm) shaft

- 468-334 horizontal 2 mm
- 468-335 vertical 2 mm

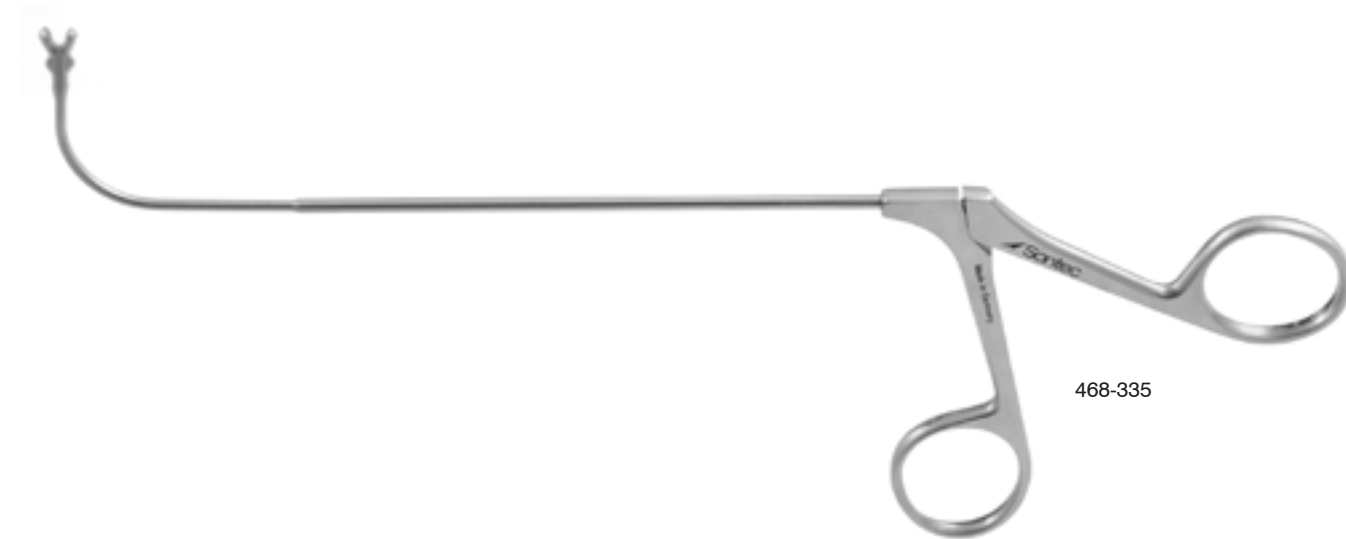

Frontal Sinus Giraffe Forceps

Double Action Cup / 90 degrees / 5 1/4" (13.5 cm) shaft

- 468-336 horizontal 3 mm
- 468-337 vertical 3 mm

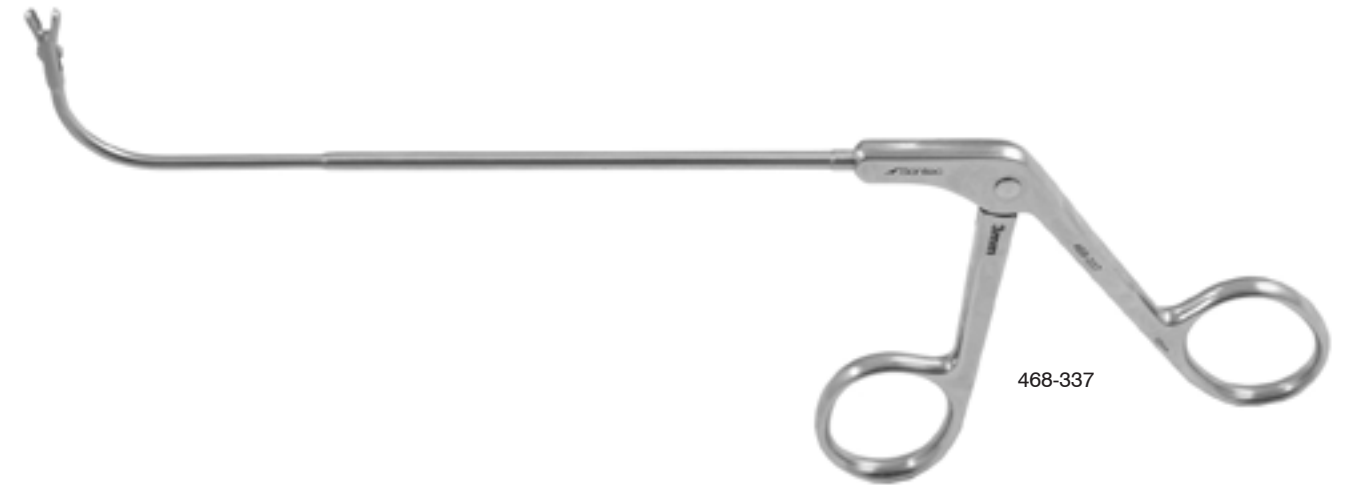

Frontal Sinus Giraffe Forceps

Double Action Cup / 90 degrees / 5 1/4" (13.5 cm) shaft

- 468-338 vertical 4 mm
- 468-339 horizontal 4 mm



468-338



468-339

Frontal Sinus Giraffe Forceps

Double Action Cup / 70 degrees / 3 mm / 4 3/4" (12 cm) shaft

- 468-321 horizontal
- 468-322 vertical

Double Action Cup / 110 degrees / 3 mm / 4 3/4" (12 cm) shaft

- 468-325 horizontal
- 468-326 vertical



468-321



468-322



468-325



468-326

Frontal Sinus Giraffe Forceps

Double Action Cup / 70 degrees/ 4 mm / 4 3/4" (12 cm) shaft

- 468-323 horizontal
- 468-324 vertical

Double Action Cup / 110 degrees/ 4 mm / 4 3/4" (12 cm) shaft

- 468-327 horizontal
- 468-328 vertical



468-323



468-324



468-327

468-328

Micro Biopsy Forceps with Flexible Shaft

Flexible shaft / 2.2 round cup jaw / 6" (15.2 cm) flexible shaft

1271-0156



1271-0156

Foreign Body Removal / Grasping Forceps

Ring handle / flexible cable shaft designed to glide through desired scope

| | | |
|---------|---------------------|-------|
| 516-002 | serrated jaw 1.2 mm | 21 cm |
| 516-003 | serrated cup 1.2 mm | 21 cm |
| 516-005 | serrated jaw 1.0 mm | 40 cm |
| 516-006 | serrated cup 1.2 mm | 40 cm |
| 516-007 | serrated jaw 1.2 mm | 21 cm |
| 516-008 | serrated cup 1.2 mm | 21 cm |

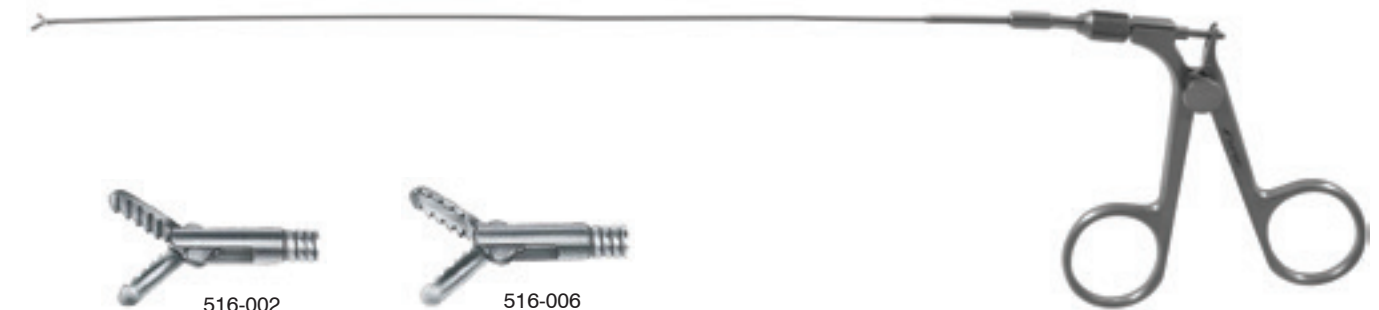

516-002



516-006



516-003



516-007



516-005



516-008

Jurasz Laryngeal Forceps

Single articulating jaws / 9" (23 cm)

- 502-271 lateral opening jaws
- 502-272 vertical opening jaws left
- 502-273 lateral opening jaws right
- 502-274 vertical opening jaws

Double articulating jaws / 9" (23 cm)

- 502-275 lateral opening
- 502-276 vertical opening



502-272



502-273



502-274

Fraenkel Laryngeal Forceps

Foreign body grasping forceps / double articulating jaws / vertical opening / 9" (23 cm)

502-277



502-277

Sontec Micro Biopsy Forceps

Round cup

- 469-062 1.0 mm cup 3 1/4" (8 cm) shaft
- 469-063 2.0 mm cup 3 1/4" (8 cm) shaft
- 469-063A 2.0 mm cup 3 1/4" (8 cm) shaft angled up
- 469-063M 2.5 mm cup 3 1/4" (8 cm) shaft
- 469-063L 3.0 mm cup 3 1/4" (8 cm) shaft
- 469-063X 4.0 mm cup 3 1/4" (8 cm) shaft
- 469-081 1.0 mm cup 6" (15 cm) shaft
- 469-082 2.0 mm cup 6" (15 cm) shaft
- 469-080 2.5 mm cup 6" (15 cm) shaft
- 469-083 3.0 mm cup 6" (15 cm) shaft
- 469-084 4.0 mm cup 6" (15 cm) shaft
- 469-085 5.0 mm cup 6" (15 cm) shaft

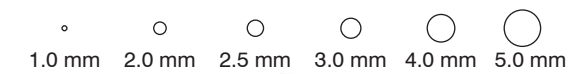

469-063M

Jackson / Biopsy Forceps

Round cup / straight / 11" (28 cm) shaft

- 1100-771A 2 mm cup
- 1100-769 4 mm cup
- 1100-770 6 mm cup

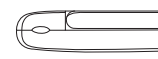
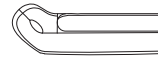

Round cup / straight / 11 3/4" (29.75 cm) shaft

- 1100-718A 2 mm cup
- 1100-718B 4 mm cup
- 1100-718C 6 mm cup



1100-710A

1100-718A

Round cup / straight / 15 3/4" (40 cm) shaft

- 1100-720A 2 mm cup
- 1100-720B 4 mm cup
- 1100-720C 6 mm cup

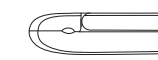
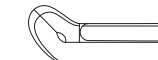

Round cup / straight / 19 3/4" (51 cm) shaft

- 1100-722A 2 mm cup
- 1100-722B 4 mm cup
- 1100-722C 6 mm cup

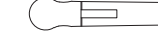

1100-710B

1100-718B

Round cup / straight / 23 3/4" (61 cm) shaft

- 1100-724A 2 mm cup
- 1100-724B 4 mm cup
- 1100-724C 6 mm cup



Round cup / up-angled / 11" (28 cm) shaft

- 1100-771B 2 mm cup

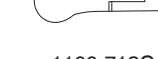

1100-710C

1100-718C

Round cup / up-angled / 11 3/4" (29.75 cm) shaft

- 1100-710A 2 mm cup
- 1100-710B 4 mm cup
- 1100-710C 6 mm cup



1100-710C

Round cup / up-angled / 15 3/4" (40 cm) shaft

- 1100-712A 2 mm cup
- 1100-712B 4 mm cup
- 1100-712C 6 mm cup

Round cup / up-angled / 19 3/4" (51 cm) shaft

- 1100-714A 2 mm cup
- 1100-714B 4 mm cup
- 1100-714C 6 mm cup

Round cup / up-angled / 23 3/4" (61 cm) shaft

- 1100-716A 2 mm cup
- 1100-716B 4 mm cup
- 1100-716C 6 mm cup

Heyman Septum Alligator Forceps

Oval cup

- 467-331S small
- 467-331M medium
- 467-331L large



467-331S

Hartmann Nasal Alligator Forceps

Delicate / 7" (19 cm)

- 467-333



467-333

Hartmann Ear Alligator Forceps

Delicate / 2 x 4 mm tip / 5" (12.5 cm)

467-335

Delicate / serrated jaw / 2.5 mm x 6 mm jaw / 5 1/4" (13.3 cm)

467-335E



467-335



467-335E

Silver Ear Dressing Alligator Forceps

2.5 mm x 8 mm / grooved jaw / 5 1/4" (13.3 cm)

467-336



467-336

Tobey Ear Dressing Forceps

Extra-delicate / 2 mm x 4 mm / 5 1/4" (13.3 cm)
467-334

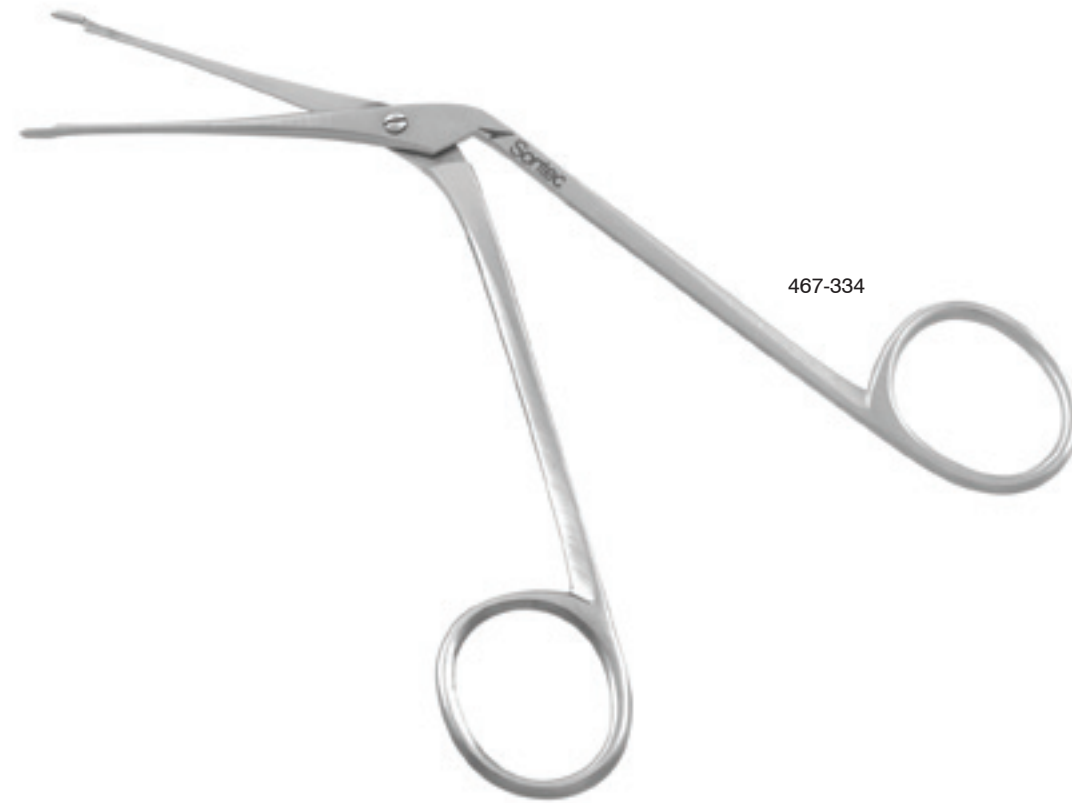

Hartman Ear Forceps

6 1/2" (16.5 cm)
467-350



Sontec Septal Platform Forceps

7 1/4" (18.4 cm)
467-332



467-332

Sontec Septal Platform Forceps Titanium

Serrated jaws / 11 mm x 21 mm / 7" (17.8 cm)
469-033T



469-033T

Carroll Tendon Pulling Forceps

4.5" shaft (11.4 cm) / serrated jaws
350-805 curved down
350-807 curved up



350-805

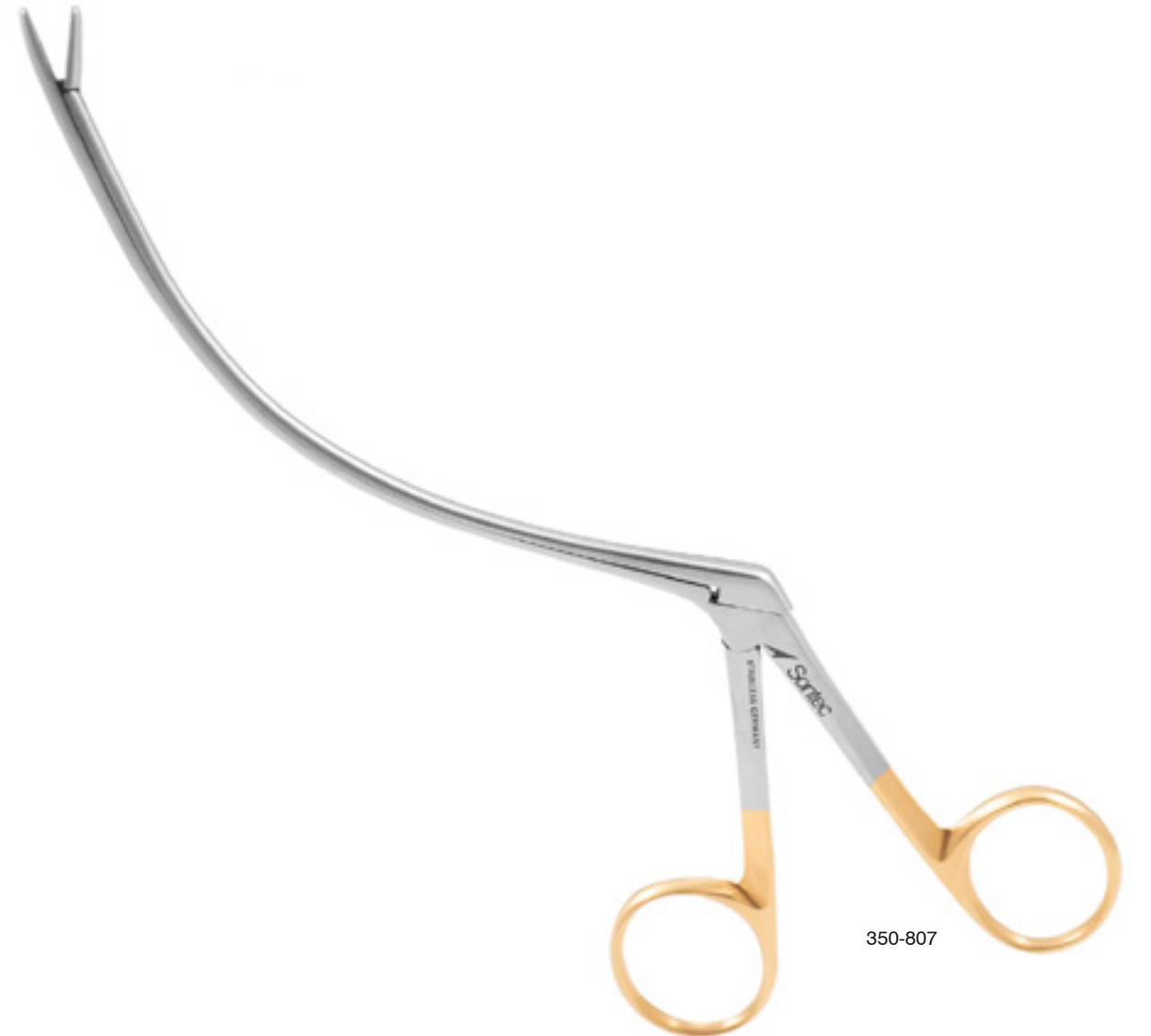

350-807

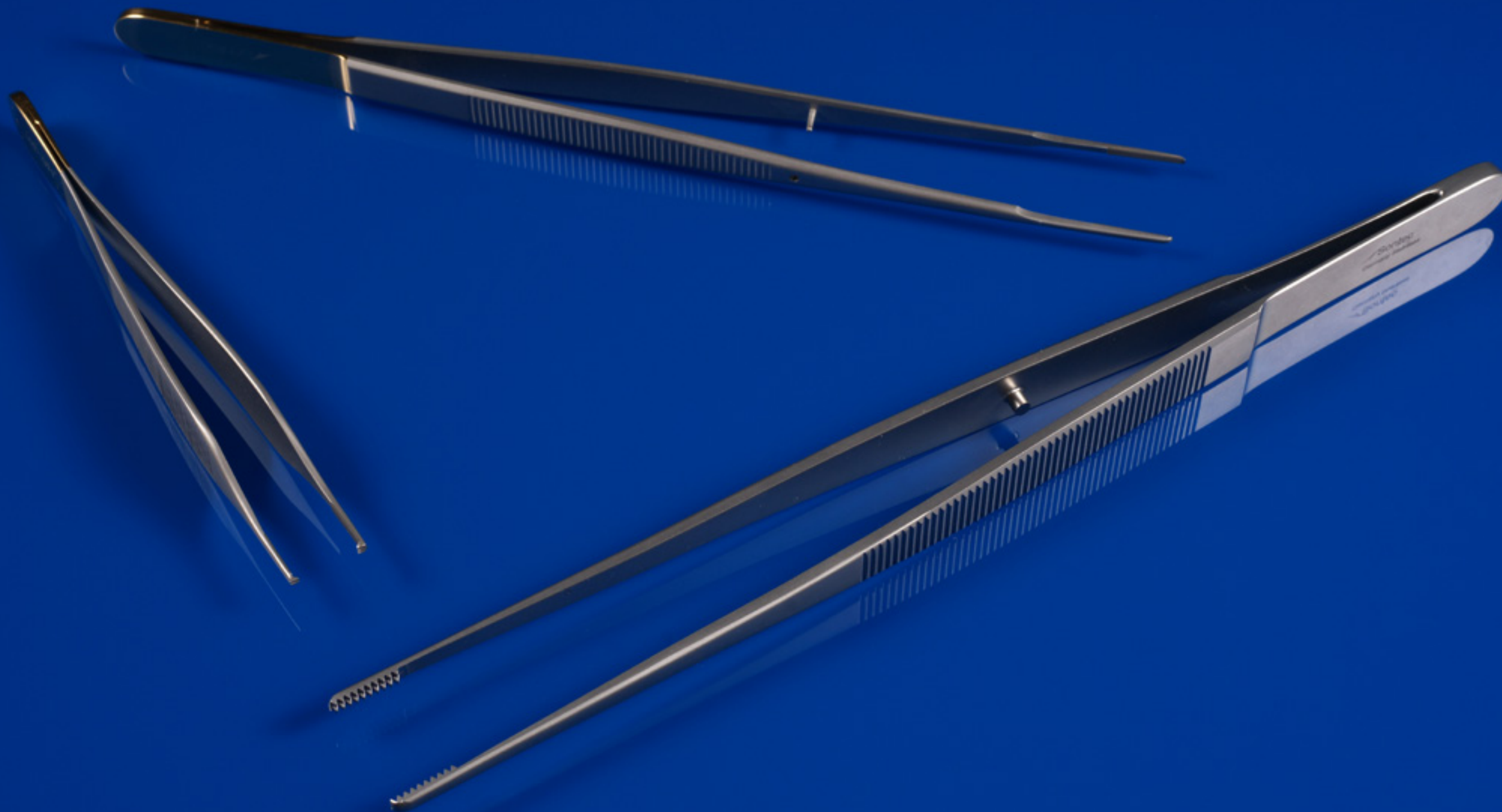

 Sontec Instruments®

FORCEPS Flat Handle

DeBakey Needle Pulling Tissue Forceps Titanium

1 mm / atraumatic tip / straight / 9" (23 cm)

2600-5863 flat serrated handle

2 mm / atraumatic tip / straight / 8" (20.5 cm)

2600-5860 flat fenestrated handle

2600-5862 flat serrated handle



2600-5863



2600-5860



2600-5862

DeBakey Vascular Forceps Titanium

1 mm / straight / fenestrated handle

2600-3611 6" (15 cm) 5 hole handle

2600-3641 8" (20 cm) 6 hole handle

2600-3651 9 1/2" (24 cm) 6 hole handle



2600-3611



2600-3641

DeBakey Forceps Titanium

1.2 mm Tip / Tapered Shaft / Short Flat Handle / Straight / Lightweight / 7 3/4" (20cm)

2600-350



2600-350

Micro Tying Forceps Titanium

Flat handle / TC dust / straight / 0.4 mm / 6" (15 cm)

2600-499



2600-499

Micro Tying Forceps

Flat handle / TC dust / with platform / straight / 0.5 mm / 7 1/4" (18.4 cm)

2200-245



2200-245

Micro Tying Forceps

Flat serrated handle / straight / 0.75mm / 6" (15.2 cm)

2600-498



2600-498

DeBakey Premier Knurled Handle Forceps Titanium

Flat Handle / DeBakey tip

2600-340 1.8 mm tip 2 x 3 teeth 9 1/2"

2600-341 1.4 mm tip 2 x 3 teeth 9 1/2" delicate

2600-345 1.2 mm tip 1 x 2 teeth 7 3/4"



2600-340



2600-341



2600-345

DeBakey Tissue Forceps Titanium

Atraumatic Jaw / straight

| | | |
|-----------|--------|------------------|
| 2600-361 | 1 mm | 6" (15 cm) |
| 2600-355 | 1.5 mm | 6" (15 cm) |
| 2600-367 | 2 mm | 6" (15 cm) |
| 2600-362 | 1 mm | 7" (17.8 cm) |
| 2600-374 | 1.5 mm | 7 1/4" (18.4 cm) |
| 2600-373 | 3 mm | 7 1/4" (18.4 cm) |
| 2600-364 | 1 mm | 7 3/4" (19.5 cm) |
| 2600-363 | 1.5 mm | 7 3/4" (19.5 cm) |
| 2600-357 | 2.5 mm | 7 3/4" (19.5 cm) |
| 2600-369 | 2 mm | 7 3/4" (19.5 cm) |
| 2600-370 | 3 mm | 7 3/4" (19.5 cm) |
| 2600-366 | 1.2 mm | 8" (20 cm) |
| 2600-365 | 1 mm | 9 1/2" (24 cm) |
| 2600-359 | 2.7 mm | 9 1/2" (24 cm) |
| 2600-371 | 2 mm | 9 1/2" (24 cm) |
| 2600-3714 | 2 mm | 12" (30.5 mm) |

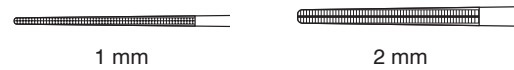

Angled / 2 mm

| | |
|----------|------------------|
| 2600-375 | 6" (15 cm) |
| 2600-376 | 7 1/4" (18.4 cm) |
| 2600-377 | 7 3/4" (19.5 cm) |
| 2600-379 | 9 1/2" (24 cm) |



2600-366



2600-377



2600-357



2600-370

Original DeBakey Forceps

Flat Handle / 3.5 mm tip / 9 1/2" (24 cm)

2200-114

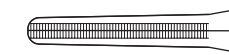

2200-114

DeBakey Vascular Forceps

6" (15 cm)

1100-183 1.5 mm tip fenestrated handle



1.5 mm DeBakey tip



1100-183

Dietrich-DeBakey Tissue Forceps

Flat handle / 1.5 mm tip

| | |
|---------|----------------------------|
| 442-236 | 6" (15 cm) |
| 442-238 | 7 3/4" (19.5 cm) |
| 442-239 | 7 3/4" (19.5 cm) 45° angle |
| 442-240 | 9 1/2" (24 cm) |



1.5 mm

Flat handle / 1.2 mm tip / with pin / 7 3/4"

442-238P



442-236



442-238



442-239



442-238P

DeBakey Tissue Forceps

Flat handle / 6" (15 cm)

- 2200-101 1.0 mm tip
- 2200-101A 1.5 mm tip
- 2200-105 2.0 mm tip
- 2200-105A 2.5 mm tip
- 2200-105B 2.8 mm tip

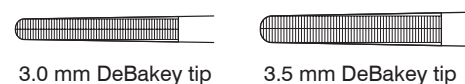
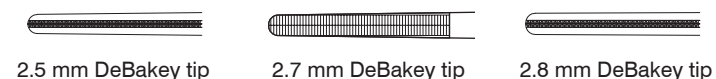

Flat handle / 7 3/4" (19.5 cm)

- 2200-102 1.0 mm tip
- 2200-102A 1.5 mm tip
- 2200-107 2.0 mm tip
- 2200-110 2.7 mm tip
- 2200-112 3.5 mm tip

Flat handle / 9 1/2" (24 cm)

- 2200-103 1.5 mm tip
- 2200-108 2.0 mm tip
- 2200-111 2.7 mm tip
- 2200-1133 3.0 mm tip
- 2200-113 3.5 mm tip

Flat handle / 12" (30 cm)

- 2200-104 1.5 mm tip
- 2200-109 2.0 mm tip
- 2200-1112 2.7 mm tip
- 2200-1132 3.5 mm tip

With pin / flat handle / 7 3/4" (19.5 cm)

- 2200-107P 2.0 mm tip
- 2200-110P 2.7 mm tip

With pin / flat handle / 9 1/2" (24 cm)

- 2200-108P 2.0 mm tip
- 2200-111P 2.7 mm tip

With pin / flat handle / 12" (30 cm)

- 2200-1112P 2.7 mm tip

* other sizes available with pin upon request.



2200-105



2200-110P



2200-111P

DeBakey Needle-Pulling Tissue Forceps

Flat handle / TC platform / 6" (15 cm)

- 2200-074 1.0 mm
- 2200-077 1.2 mm
- 2200-078 1.5 mm
- 2200-080 2.0 mm
- 2200-079 2.7 mm
- 2200-081 3.5 mm

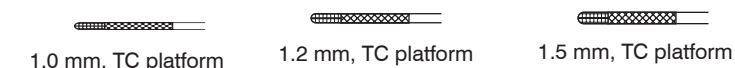

Flat handle / TC platform / 8" (20 cm)

- 2200-075 1.0 mm
- 2200-096 1.2 mm
- 2200-097 1.5 mm
- 2200-100 2.0 mm
- 2200-099 2.7 mm
- 2200-099P 2.7 mm with guide pin
- 2200-098 3.2 mm
- 2200-098P 3.2 mm with guide pin



2200-097

Flat handle / TC platform / 9 1/2" (24 cm)

- 2200-076 1.0 mm
- 2200-085 1.5 mm
- 2200-092 2.0 mm
- 2200-091 2.7 mm
- 2200-090 3.5 mm

Flat handle / TC platform / 12" (30 cm)

- 2200-0922 2 mm
- 2200-0912 2.7 mm
- 2200-0902 3.5 mm

DeBakey Angled Tissue Forceps

Flat Handle / 40° angle

- 2200-106 2.0 mm 6"
- 2200-107C 2.0 mm 7 3/4"
- 2200-107A 2.7 mm 7 3/4"
- 2200-103A 1.5 mm 9 1/2"



2200-107C



2200-103A

DeBakey Thoracic Forceps

Flat handle / 2.5 mm tip

- 442-210 6" (15 cm)
- 442-212 7 3/4" (20 cm)
- 442-214 9 1/2" (24 cm)
- 442-216 12" (30.5 cm)

Flat handle / 2.8 mm tip / 12" (30.5 cm)

442-219

Flat handle / 3.5 mm tip / 14" (35.5 cm)

442-215



DeBakey Thoracic Forceps

Flat handle / 3.0 mm tip

- 442-2123 7 3/4" (20 cm)
- 442-218 10" (25.4 cm)



DeBakey Ergonomic-Handle Forceps

Extra lightweight / 1.0 mm tip / fenestrated handle

- 2200-101F 6" (15 cm)
- 2200-102F 7 7/8" (20 cm)
- 2200-103F 9 1/2" (24 cm)
- 2200-104F 12" (30 cm)



DeBakey Ergonomic-Handle Forceps Titanium

Extra lightweight / 1.0 mm tip / fenestrated handle / 9 1/2" (24 cm)

- 2600-593 9 1/2" (24 cm)



Electro Blue Coated DeBakey Forceps

Monopolar use / insulated / 2.0 mm tip / flat handle

- 2200-105C 6" (15 cm)
- 2200-107B 7 3/4" (19.5 cm)
- 2200-108B 9 1/2" (24 cm)
- 2200-109B 12" (30 cm)



Monopolar use / insulated / flat handle / 12" (30 cm)

- 2200-1112B 2.7 mm tip
- 2200-1132B 3.0 mm tip



Cooley Vascular Tissue Forceps

2.0 mm tip

- 442-242 6 1/4" (16 cm)
- 442-244 7 3/4" (19.5 cm)
- 442-246 9 1/2" (24 cm)



442-244

Gerald Tissue Forceps

DeBakey tip / 1 mm tip / 7" (18 cm)

2200-150



DeBakey tip

DeBakey tip / 8" (20.5 cm)

- 2200-152 1 mm tip
- 2200-152N 1.5mm tip narrow handle



2200-150



2200-152N

Gerald Brown Tissue Forceps

Flat handle / 8x8 teeth / 7" (18 cm)

140-389



140-389

Gerald Lightweight Micro Tissue Forceps Titanium

1 mm tip / TC Dust

- 2600-384 7" (18 cm)
- 2600-388 8" (20 cm)

Serrated tip / dressing

- 2600-385 7" (18 cm)
- 2600-385S 8" (20 cm)

Tissue / 1 x 2 Teeth

- 2600-387 7" (18 cm)
- 2600-389 8" (20 cm)

1 mm platform Tip / TC Dust

- 2600-490 7" (18 cm)
- 2600-491 8" (20 cm)

1 mm ring Tip / TC Dust

- 2600-492 7" (18 cm)
- 2600-493 8" (20 cm)

1 mm DeBakey Tip

- 2600-495 7" (18 cm)
- 2600-496 8 1/4" (21 cm)
- 2600-497 7 7/8" (20 cm) wide handle
- 2600-494D 9 1/2" (24 cm)

1 mm serrated tip

- 2600-494 9 1/2" (24.1 cm)
- 2600-494A 9 1/2" (24.1 cm) 45° angled on the flat

1 mm platform ring tip / TC Dust

- 2600-492P 7" (17.8 cm)
- 2600-493P 8" (20.3 cm)
- 2600-493P1 9" (22.9 cm)

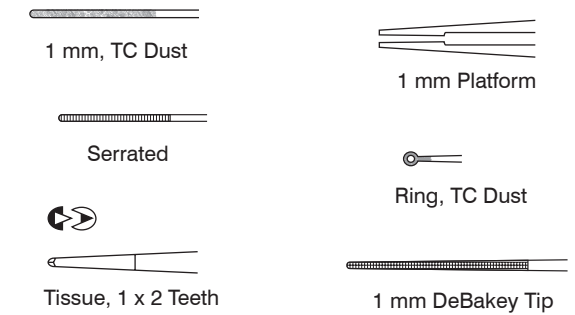

2600-490

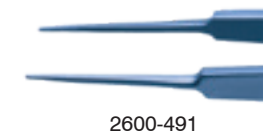

2600-491



2600-496



2600-497



2600-495



2600-494



2600-494A

Gerald Tissue Forceps

Serrated / 7" (18 cm)

- 2200-130 straight
- 2200-131 curved

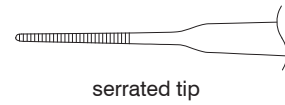

2200-130

Cross-serrated

- 2200-132 7 3/4" (18 cm)
- 2200-133 8" (20.5 cm)
- 2200-135 9" (23 cm)
- 2200-134 10" (25.5 cm)

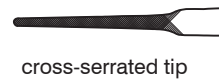

TC platform

- 2200-142 7" (18 cm)
- 2200-144 8" (20.5 cm)
- 2200-145 9" (23 cm)
- 2200-141A 9" (23 cm) 45° angle
- 2200-146 10" (25.5 cm)

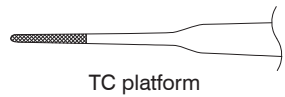

2200-142

TC dust

- 2200-138 7" (18 cm)
- 2200-140 8" (20.5 cm)
- 2200-141 9" (23 cm)

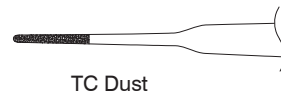

TC dust / ring tip / 7" (18 cm)

- 2200-154 straight
- 2200-155 curved



Delicate / straight / 1 x 2 teeth / 0.5 mm micro tip / 7" (18 cm)

- 2200-1365



2200-1365

1 x 2 teeth / 0.8 mm tip / micro / 7" (18 cm)

- 2200-136 straight
- 2200-137 curved

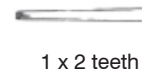

1 x 2 teeth / 1 mm tip / 7" (18 cm)

- 140-372 straight TC serrated
- 140-374 curved TC serrated
- 2200-129 straight



140-372

Micro Gerald Tissue Forceps

Round handle / TC serrated platform / 0.9 mm tip

- 2200-1431 7 1/4"
- 2200-1441 8 1/4"



2200-1431

Brown Tissue Forceps

9 x 9 teeth

- 136-690 6" (15.5 cm)
- 136-692 8" (20.5 cm)
- 136-694 10" (25.5 cm)



136-690

9 x 9 teeth / TC

- 136-691 6" (15.5 cm)
- 136-695 10" (25.4 cm)

McGravey Tissue Forceps

5 x 6 delicate teeth

- 136-766 7" (18 cm)
- 136-767 9" (22.9 cm)



136-766

Russian Tissue Forceps

- 136-771 6" (15.5 cm)
- 136-773 8" (20.5 cm)
- 136-775 10" (25.5 cm)
- 136-776 12" (30.5 cm)



136-773

Sontec D'Errico Tissue Forceps

- 136-769 7 1/4" (18.45 cm)



136-769

Selman Tissue Forceps

Round cup teeth

- 142-112 6" (15.5 cm)
- 142-113 8" (20.3 cm)
- 142-114 10" (25.4 cm)



142-113

Singly Tuttle Forceps

Serrated

- 142-103 6" (15 cm)
- 142-108 7" (18 cm)
- 142-110 9" (23 cm)
- 2200-0175 9" (23 cm) large ring
- 142-107 10" (25 cm)
- 142-111 12" (30 cm)
- 142-104 14" (35.5 cm)
- 142-106 16" (40.5 cm)



142-108



Wangensteen Tissue Forceps

TC Serrated

- 2200-015 6" (15 cm)
- 2200-016 8" (20 cm)
- 2200-017 9" (23 cm)
- 2200-018 10" (25.5 cm)



2200-017

Evans Tissue Forceps

TC serrated / 10" (25 cm)

- 2200-382



2200-382

Resano Brown Vascular Forceps

- 2200-376 7 1/8" (18.25 cm) 9 x 9
- 2200-377 9 1/8" (23.5 cm) 9 x 9
- 2200-377W 9 1/8" (23.5 cm) wide handle 11 x 11
- 2200-378 12 1/2" (31 cm) 9 x 9

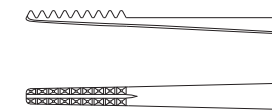

2200-376



2200-377



2200-377W



2200-378

Resano Brown Vascular Forceps

- 2200-361 7 1/8" (18.5 cm) 9 x 9 TC platform
- 2200-362 9 1/8" (23.5 cm) 9 x 9 TC platform
- 2200-362W 9 1/8" (23.5 cm) 11x11 TC platform wide handle



2200-361



2200-362



2200-362W

Resano Brown Vascular Forceps Titanium

9 x 9 teeth

- 2600-380 7 1/8" (18cm)
- 2600-381 9 1/8" (23.5 cm) wide handle
- 2600-382 12" (30 cm)

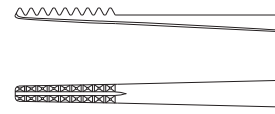

2600-380



2600-381

Resano Double Action Vascular Forceps Titanium

Double action / straight

- 2601-300 11" (28 cm)



Potts Smith Tissue Forceps

1 mm tip

- 2200-030 6 1/4" (16 cm) TC dust
- 2200-032 7 1/8" (19 cm) TC dust
- 2200-034 8" (20 cm) TC dust
- 2200-036 9 3/4" (24 cm) TC dust
- 2200-029 9" (23 cm) TC serrated



2200-032

2 mm Tip / TC Dust

- 2200-040 6 1/4" (16 cm)
- 2200-042 7 1/8" (19 cm)
- 2200-044 8" (20 cm)
- 2200-046 9 3/4" (24 cm)



2200-046

2 mm Tip / TC Serrated

- 2200-041 6 1/2" (16.5 cm)
- 2200-043 7" (18 cm)
- 2200-045 8" (20 cm)
- 2200-0459 9" (23 cm)
- 2200-047 10" (25 cm)



2200-047

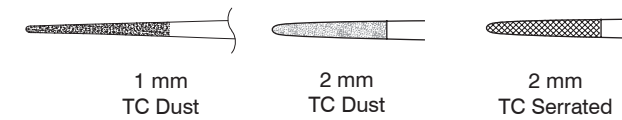

Potts Cooley Tissue Forceps

Serrated / 1 mm

- 2205-650 7 3/4" (19.7 cm)
- 2205-655 9 1/2" (23.5 cm)



2205-655

Electro Blue Coated Potts-Smith Tissue Forceps

Monopolar use / TC serrated platform / insulated / flat handle / 9 1/4" (23.5 cm)

- 2200-073B straight 2.5 mm tip 9 1/4" (23.5 cm)
- 2200-074B angled 2.5 mm tip 9 1/4" (23.5 cm)
- 2200-073C straight 1.5 mm tip 9" (22.9 cm) 1x2 teeth
- 2200-073D straight 2.5 mm tip 9 3/4" (24.8 cm)



2200-073B



2200-074B



2200-073C



2200-073D

Potts Nevins Forceps

TC serrated / 1.8 mm tip / 7 1/4" (18.4 cm)

- 140-273



140-273

Potts-Smith Dressing

Serrated

- 136-730 7" (18 cm)
- 136-735 8 1/4" (21 cm)
- 136-740 9 1/2" (24 cm)
- 136-746 12" (30 cm)



136-740

Potts-Smith Tissue Forceps

Serrated / 1 x 2 teeth

- 136-732 7" (18 cm)
- 136-737 8 1/4" (21 cm)
- 136-742 9 1/2" (24 cm)
- 136-748 12" (30 cm)



136-737

Reul Coronary Artery Forceps

TC serrated / 1 mm / 8" (20 cm)

- 2200-126



2200-126

Cushing Tying Forceps

Standard / straight tip / 7" (18 cm)

- 2200-789 serrated
- 2200-790 1x2 teeth



2200-789

TC insert platform / straight tip

- 2200-383 7" (18 cm)



2200-383

TC insert platform / 7" (18 cm)

- 2200-387 angled tip
- 2200-389 straight tip 1x2 teeth

TC insert platform / straight tip / serrated

- 2200-394 8 1/4" (21 cm)
- 2200-396 10" (25 cm)



Straight

Angled

Cushing Forceps Titanium

1 mm Tip / serrated / lightweight

- 2600-335 7" (18cm)
- 2600-339 8 1/4" (21cm)



2600-335



1 mm



2600-339

Thumb Forceps Titanium

Serrated Handle / TC Dust tip

- 136-612T 6 1/4" (16 cm)
- 136-616T 7 7/8" (20 cm)



136-612T



136-616T

Tissue Forceps with TC Inserts

TC platform / 6" (15.2 cm)

- 1100-732 1 x 2 teeth
- 1100-733 2 x 3 teeth
- 1100-7334 3 x 4 teeth
- 1100-7335 4 x 5 teeth



1100-733

Skinner Tissue Forceps

1 x 2 teeth / TC platform / 8" (20.5 cm)

- 140-517M micro
- 140-517 delicate
- 140-517G standard



standard tip

delicate tip

micro tip

1 x 2 teeth / TC platform / 9" (23 cm)

- 140-379 micro
- 140-378 delicate
- 140-376 standard

1 x 2 teeth / TC platform / 10" (25.5 cm)

- 140-519M micro
- 140-519 delicate
- 140-519G standard



140-376

Electro Blue Coated Skinner Tissue Forceps

Monopolar use / TC serrated platform / 1 x 2 teeth / insulated / 9" (22.9 cm)

140-376B



140-376B

Semken Forceps

Dressing / serrated

136-702 4 3/4" (12 cm)
136-704 6" (15.5 cm)

Tissue / 1 x 2 teeth / delicate / 0.7mm tip / 4 3/4" (12 cm)

136-701

Tissue / 1 x 2 teeth

136-706 5" (13 cm)
136-708 6" (15.5 cm)

Tissue / TC platform / 1 x 2 teeth

140-350 5 3/4" (15 cm)
140-358 6 1/4" (16 cm)
140-364 7" (18 cm)

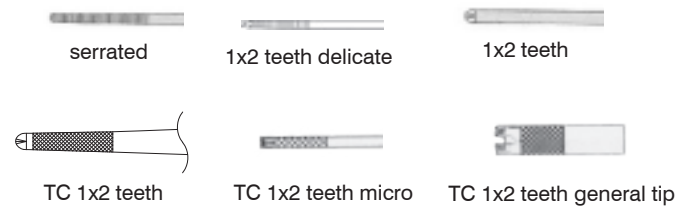

140-350



140-364

Tissue / TC platform / 1 x 2 teeth / micro

140-352 5 3/4" (15 cm)
140-360 6 1/4" (16 cm)
140-366 7" (18 cm)

Tissue / TC platform 1 x 2 teeth / general

140-354 5 3/4" (15 cm)
140-362 6 1/4" (16 cm)
140-368 7" (18 cm)
140-369 8" (20.5 cm)

Ferris-Smith Tissue Forceps

6 3/4" (17 cm)

136-711 1x2 teeth
136-712 2x3 teeth
140-382 2x3 teeth TC platform
140-3821 1x2 teeth TC platform



136-712



140-382



140-3821

Oehler Forceps

TC serrated / 1 x 2 teeth

140-512 6 1/2" (16.5 cm)
140-514 7" (17.8 cm)



140-512



140-514

Tissue Forceps with Teeth

1 x 2 teeth

| | | |
|----------|------------------|---------------------|
| 136-621 | 4 1/2" (11.5 cm) | |
| 136-624 | 5" (12.7 cm) | |
| 136-626 | 5 1/2" (14 cm) | |
| 136-626F | 5 1/2" (14 cm) | fine tip |
| 136-629 | 6" (15.5 cm) | |
| 136-632 | 7" (18 cm) | |
| 136-632B | 7" (18 cm) | electro blue coated |
| 136-634 | 8" (20.5 cm) | |
| 136-634D | 8" (20.5 cm) | delicate |
| 136-636 | 10" (25.5 cm) | |
| 136-636D | 10" (25.5 cm) | delicate |



136-632B



136-626F



136-634B

2 x 3 teeth

| | | |
|----------|----------------|-------------|
| 136-639 | 5" (12.7 cm) | |
| 136-633 | 5" (12.7 cm) | TC serrated |
| 136-640 | 5 1/2" (14 cm) | |
| 136-637 | 5 1/2" (14 cm) | TC serrated |
| 136-642 | 6" (15.5 cm) | |
| 1100-179 | 6 1/4" (16 cm) | |
| 136-641 | 6 1/4" (16 cm) | TC serrated |
| 1100-165 | 7" (18 cm) | |
| 136-643 | 7" (18 cm) | TC serrated |
| 1100-167 | 8" (20 cm) | |
| 136-645 | 8" (20 cm) | TC serrated |
| 1100-187 | 9 3/4" (25 cm) | |
| 136-649 | 9 3/4" (25 cm) | TC serrated |
| 1100-169 | 10" (25 cm) | |
| 136-651 | 10" (25 cm) | TC serrated |



136-640

3 x 4 teeth

| | | |
|---------|----------------|-------------|
| 136-644 | 5 1/2" (14 cm) | |
| 136-652 | 5 1/2" (14 cm) | TC serrated |
| 136-646 | 6" (15 cm) | |

4 x 5 teeth

| | | |
|----------|----------------|-------------|
| 136-648 | 5 1/2" (14 cm) | |
| 136-653 | 5 1/2" (14 cm) | TC serrated |
| 136-650 | 6" (15.5 cm) | |
| 136-6508 | 8" (20.3 cm) | |

McIndoe Forceps Titanium

Fine tip / serrated handle / serrated / 6" (15.2 cm)

| | |
|----------|-------------|
| 2600-391 | 1 x 2 teeth |
| 2600-392 | serrated |



2600-391



2600-392

McIndoe Dressing and Tissue Forceps

Fine serrations / 6" (15 cm)

2200-750



2200-750

Cross serrations with 1x2 teeth / 6" (15 cm)

2200-752



2200-752

Thumb Dressing Forceps

Serrated

| | |
|---------|------------------|
| 136-600 | 4" (10 cm) |
| 136-602 | 4 1/2" (11.5 cm) |
| 136-605 | 5" (13 cm) |
| 136-607 | 5 1/2" (14 cm) |
| 136-610 | 6" (15.5 cm) |
| 136-613 | 7" (18 cm) |
| 136-615 | 8" (20.5 cm) |
| 136-617 | 10" (25.5 cm) |
| 136-619 | 12" (30.5 cm) |



TC serrated

| | |
|-----------|--------------|
| 1100-739B | 6" (15.5 cm) |
| 1100-739A | 7" (18 cm) |



136-607

Ferlit Micro Forceps

1 x 2 teeth / cross serrated tying platform

| | | |
|----------|-----------|--------|
| 140-504A | 7" (18cm) | 1.5 mm |
| 140-504B | 4" (10cm) | 0.9 mm |

1 x 2 teeth / TC Dust / 0.5 mm teeth / 4 1/4" (10.8 cm)

140-505T



platform



140-505T



140-504B



Bonney Tissue Forceps

Serrated / 6 3/4" (17 cm)

| | | |
|---------|-------------|-------------|
| 140-502 | 1 x 2 teeth | TC serrated |
| 136-578 | 2 x 3 teeth | serrated |

1 x 2 / 7" (18 cm)

| | |
|---------|-------------|
| 136-580 | serrated |
| 140-500 | TC serrated |



1 x 2 teeth



2 x 3 teeth



140-502



136-578



136-580

Duehrssen Tissue Forceps

1 x 2 teeth / 8" (20.3 cm)

136-590



136-590

Gillies Forceps

Fine serrations / 1 x 2 teeth / 6" (15 cm)

2200-700



2200-700

Long Tissue Forceps

12" (30 cm)

1100-859 1 x 2 teeth
1100-858 2 x 3 teeth



1 x 2 teeth



2 x 3 teeth

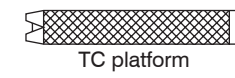

TC platform



1100-859

TC platform / 12" (30 cm)

1100-863 1 x 2 teeth
1100-862 2 x 3 teeth

14" (35.5 cm)

1100-874 1 x 2 teeth
1100-878 2 x 3 teeth

TC platform / 14" (35.5 cm)

1100-875 1 x 2 teeth
1100-879 2 x 3 teeth

16" (40.5 cm)

1100-876 1 x 2 teeth
1100-880 2 x 3 teeth



1100-880

TC platform / 16" (40.5 cm)

1100-877 1 x 2 teeth
1100-881 2 x 3 teeth



1100-861

18" (45.5 cm)

1100-861 1 x 2 teeth
1100-860 2 x 3 teeth



1100-861

TC platform / 18" (45.5 cm)

1100-865 1 x 2 teeth
1100-864 2 x 3 teeth

Hudson-Ewald Forceps

Heavy / serrated adson handle / 4 3/4" (12 cm)

- 136-684 1 x 2 teeth
- 136-680 serrated tip

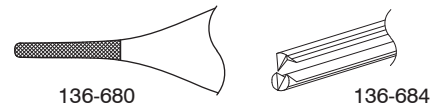

Troutman Micro Hook Forceps

With tying platform / TC dust / round handle

- 199-365S 5" (12.5 cm)
- 199-365 6 1/4" (16 cm)
- 199-365T 6 1/4" (16 cm) titanium

Adson handle

- 199-368 4 3/4" (12 cm)



Adson Tissue Forceps Titanium

TC dust / 1.0 mm tips / 4 3/4" (12 cm)

- 140-298T



Adson Tissue Forceps Titanium

1 x 2 / TC dust / tying platform / 4 3/4" (12 cm)

- 140-304T



Adson Tissue Forceps Titanium

TC dust / with tying platform / 0.6 mm / 4 3/4" (12 cm)

- 140-296T



Adson Tissue Forceps Titanium

TC dust / 0.3 mm / 1 x 2 tip / 4 3/4" (12 cm)

- 140-297T



Adson Tissue Forceps Titanium

With tying platform / TC dust / 1x2 teeth / 6" (15.2 cm)

- 2600-307



Adson Tissue Forceps Titanium

Serrated handle / TC dust / 0.5 mm / 1 x 2 tip / 4 3/4" (12 cm)

- 140-302T



Adson-Harris Ring Tip Forceps Titanium

Fenestrated / 1 mm ring-tip / TC dust / 4 3/4" (12 cm)

- 1103-812T



Adson Tissue Forceps Titanium

1 x 2 Teeth

- 2600-302 4 3/4"
- 2600-311 5 7/8"



Gorney-Adson Forceps

1 x 2 teeth with platform / stop pin / 4 3/4" (12 cm)

- 136-6741



DeBakey-Adson Tissue Forceps

1.5 mm / atraumatic DeBakey jaws / 4 3/4" (12 cm)

- 1100-185



Adson Tissue Forceps

1 x 2 teeth / serrated handle / 4 3/4"

- 136-668 0.8 mm
- 136-666 1.3 mm
- 136-672 1.3 mm 45° angled tips



136-666

1 x 2 teeth / serrated handle / 6"

- 136-683 0.8 mm
- 136-682 1.3 mm

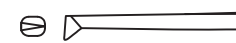

1 x 2 teeth / serrated handle / TC dust platform / 6"

- 136-682P 1.3 mm



136-672

1 x 2 teeth / fenestrated handle / 4 3/4"

- 136-669 1.0 mm
- 136-667 1.3 mm

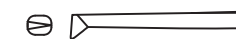

2 x 3 teeth / serrated handle / 4 3/4"

- 136-676 1.0 mm



136-682P



136-669



136-676



2 x 3 teeth

Beasley-Babcock Tissue Forceps

Serrated adson handle / 5 x 6 teeth / 5" (13 cm)

- 136-699



136-699



Adson Tissue Smooth Platform Forceps

1 x 2 teeth / smooth platform / serrated handle / 4 3/4"

- 136-668A 0.8 mm
- 136-674D 1.0 mm
- 136-674 1.3 mm

1 x 2 teeth / smooth platform / fenestrated handle / 4 3/4"

- 136-679 1.3 mm



136-674

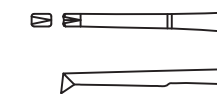

136-679

Adson Tissue TC Dust Platform Forceps

1 x 2 teeth / TC Dust platform / serrated handle / 4 3/4"

- 140-302D 0.8 mm
- 140-302 1.0 mm

1 x 2 teeth / TC Dust platform / fenestrated handle / 4 3/4"

- 140-302F 0.8 mm
- 140-303F 1.0 mm



140-303F

Adson Tissue TC Serrated Platform Forceps

1 x 2 teeth / TC serrated platform / serrated handle / 4 3/4"

- 140-305 1.0 mm
- 140-304 1.3 mm
- 140-303 1.8 mm

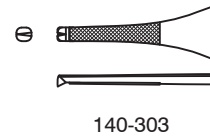

140-304

1 x 2 teeth / TC serrated platform / serrated handle / 6"

- 140-207 0.8 mm
- 140-309 1.0 mm
- 140-202 1.3 mm
- 140-203 1.8 mm



140-309

1 x 2 teeth / TC serrated platform / fenestrated handle / 4 3/4"

- 140-305F 1.0 mm
- 140-3042 1.3 mm
- 140-3032 1.8 mm



140-305F

2 x 3 teeth / TC serrated platform / serrated handle / 4 3/4"

- 140-306 0.8 mm
- 140-307 2.0 mm



140-307

2 x 3 teeth / TC serrated platform / fenestrated handle / 4 3/4"

- 140-304F 1.0 mm



140-304F

Adson Tissue Cross Serrated Forceps

1 x 2 teeth / cross-serrated platform / serrated handle / 4 3/4"

- 136-678 1.3 mm

1 x 2 teeth / cross-serrated platform / serrated handle / 6"

- 136-678L 1.8 mm

1 x 2 teeth / cross-serrated platform / fenestrated handle / 4 3/4"

- 136-679S 1.3 mm



136-678L



136-679S

Adson Dressing Serrated Forceps

Serrated tip / serrated handle / 4 3/4"

- 136-6621T 0.4 mm
- 136-662 0.8 mm
- 136-662T 0.8 mm
- 136-660 1.3 mm
- 136-660A 1.3 mm angled

Serrated tip / fenestrated handle / 4 3/4"

- 136-663 0.8 mm
- 136-661 1.3 mm

Serrated tip / serrated handle / 6"

- 140-198 1.3 mm

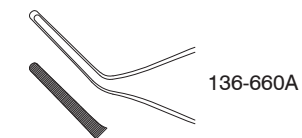

136-660A



136-660



136-6621T



136-662T

Adson Dressing TC Serrated Platform Forceps

TC Serrated platform / serrated handle / 4 3/4"

- 140-299 0.8 mm
- 140-301 1.3 mm



TC Serrated platform / serrated handle / 6"

- 140-201 1.3 mm

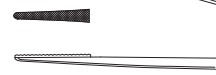

140-301

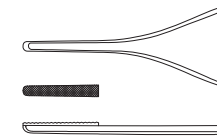

Adson Dressing TC Dust Forceps

TC Dust / serrated handle / 4 3/4"

- 140-298 1.3 mm
- 140-297 1.3 mm platform



TC Dust / serrated handle / 6"

- 140-205 1.3 mm
- 140-204 1.3 mm platform



140-297

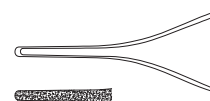

Adson Dressing Cross-Serrated Forceps

Cross-serrated tip / serrated handle / 4 3/4"

- 136-664D 0.8 mm
- 136-664 1.3 mm



136-664

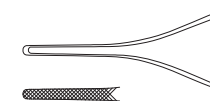

Cross-serrated tip / fenestrated handle / 4 3/4"

- 136-665 1.3 mm



136-664D



Adson-Derlacki Forceps

Serrated handle / 9x9 teeth / screw lock / 4 3/4" (12 mm)

- 136-6861



136-6861

Adson Helms Forceps

Serrated handle / 6" (15 mm)

- 2200-066



2200-066

Adson Forceps with Skin Hook

Attached thumb ring / 1x2 teeth / 2 sharp prong

475-492 4" (10 cm)
475-490 6 1/4" (16 cm)



475-492

Broli-Adson Forceps

1.2 mm Tip / TC Dust / straight / 6" (15 mm)

2200-062



2200-062

1.2 mm Tip / 1 x 2 Teeth / straight / 6" (15 mm)

2200-064

1.2 mm Tip / Serrated 6" (15 mm)

2200-058 straight
2200-060 curved

Brown Adson Tissue Forceps Titanium

1.8 mm tips / 7x7 teeth

T136-688 4 3/4" (12 cm) fenestrated handle
136-688T 6" (15.2 cm)



T136-688

1.8 mm tips / 9x9 teeth / 4 3/4" (12 cm)

T136-686 4 3/4" (12 cm)



136-688T



T136-686

Brown-Adson Tissue Forceps

Serrated handle / 7 x 7 teeth / 4 3/4" (12 cm)

136-688 fenestrated handle
136-688S



136-688

3 x 4 teeth / TC platform / 4 3/4" (12 cm)

136-689 serrated handle
1100-735F fenestrated handle

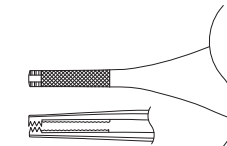

TC platform
3 x 4 teeth



136-6891

3 x 4 teeth / TC platform / electro black coated / 4 3/4" (12 cm)

136-6891 serrated handle

Russian fenestrated handle / 8 x 8 teeth / 4 3/4" (12 cm)

136-700



136-700

Serrated handle / 9 x 9 teeth / 4 3/4" (12 cm)

136-686
136-686D 1.6 mm delicate tip
136-698 angled



136-686

Serrated handle / 9 x 9 teeth / 6" (15.5 cm)

136-687
136-697 TC platform

9 X 9 teeth



136-697

Brown-Adson Cooley Forceps

1.5 mm tip / 4 3/4" (12 cm)

136-686C

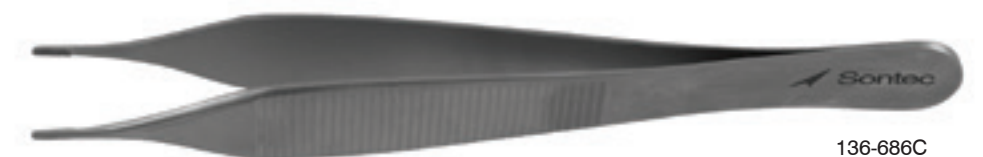

136-686C

Stille-Adson Tissue Forceps

1 x 2 teeth / 4 3/4" (12 cm)

- 136-675 platform
- 136-677 serrated
- 136-678P cross-serrated platform

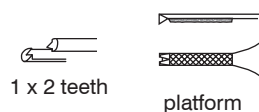

136-675

Stille-Adson Dressing Forceps

Serrated / 4 3/4" (12 cm)

- 136-659
- 136-659D delicate

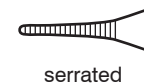

serrated



136-659

Adson Harris Ring Tip Forceps

Ring tip / TC dust / 1 mm tip / 4 3/4" (12 cm)

- 1103-808 fenestrated handle curved
- 1103-810
- 1103-812 fenestrated handle



ring tip
1mm



1103-808

Ring tip / 2 mm tip / 4 3/4" (12 cm)

1103-809



1103-810



1103-812

Brown Forceps

9x9 teeth / castroviejo handle / 4 1/4" (10.8 cm)

- 14-6560
- 14-6562 with TC dust platform
- 14-6564 with TC insert



14-6560

Harris Ring Tip Forceps

Fenestrated handle / ring tip / 1 mm tip / 6" (15.5 cm)

- 1103-811
- 1103-811T titanium

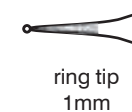

ring tip
1mm

Fenestrated handle / TC dust ring tip / 2 mm tip / 6" (15.5 cm)

1103-813



1103-811



1103-811T

Russian Adson Micro Forceps

Fenestrated handle / with platform / 5 1/4" (13.3 cm)

- 136-671A straight
- 136-671B curved



136-671A



136-671B

Fenestrated handle / 1 x 2 teeth / 5 1/4" (13.3 cm)

- 136-671C straight



136-671C

Fenestrated handle / straight / 1 x 2 teeth / 5 3/4" (14.5 cm)

136-671D

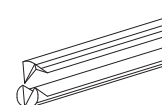

136-671D

Jewelers Bipolar Forceps

Straight / 0.5 mm tip / #5 tip / 4 3/4" (12.1 cm)

2700-918



2700-918

Adson Bipolar Forceps

1 mm tip / 4 3/4" (12 cm)

2700-905

2700-900

2700-902 4mm angled tip blue electro coat



2700-900



2700-902

1 mm tip / fenestrated handle / 4 3/4" (12 cm)

2700-902F 4 mm angled tip blue electro coat

2700-906 pointed tips



2700-902F



2700-906

1 mm tip / fenestrated handle / non-stick / black coated / 4 3/4" (12 cm)

2700-908NS straight

2700-903NS angled



2700-908NS

Jewelers Bipolar Forceps

0.4 mm tip / 4" (10 cm)

2700-920 straight

2700-922 curved

2700-915 straight blue coat



2700-920



2700-915

Insulated / non-stick / straight / 4 1/4" (10.8 cm)

2700-924NS 0.5 mm



2700-924NS

McPherson Bipolar Forceps

Smooth tying platform / 0.4 mm tip / 3 1/2" (9 cm)

16-2700 straight

16-2710 angled



16-2700



16-2710

Jewelers-McPherson Bipolar Forceps

Blue electro coat / straight

16-2760



16-2760

Tenzel Bipolar Forceps

Stop gap 0.5mm / 0.4 mm tip / 4" (10 cm)

2700-925



2700-925

Nadler Coaptation Bipolar Forceps

0.4 mm tip / 4" (10 cm)

2700-931



2700-931

Cushing Bayonet Bipolar Forceps

Stainless steel / 7 1/2" (19 cm)

2700-978 0.7 mm tip

2700-940 2.0 mm tip insulated



2700-978



2700-940

Gerald Bayonet Bipolar Forceps

Insulated / 1 mm tip / 7 1/2" (19 cm)

2700-990

2700-990NS non-stick



2700-990



2700-990NS

Bayonet Bipolar Forceps

Non-stick / black insulated / with stop pin / 1.0mm tip / 9 1/2" (24 cm)

2700-830NS



2700-830NS

Hardy Bayonet Bipolar Forceps

Insulated / 0.5 mm tip / 8 1/2" (22 cm)

2700-980



2700-980

Yasargil Bayonet Bipolar Forceps

1.5 mm tip / irrigated / insulated / 8 1/4" (21 cm)
2700-974



1 mm tip / irrigated / stainless steel / 7 1/8" (18.25 cm)
2700-975

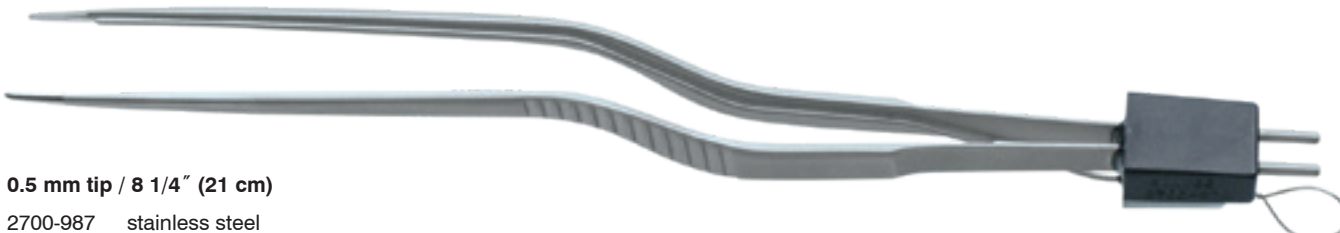

0.5 mm tip / 8 1/4" (21 cm)
2700-987 stainless steel
2700-984 insulated



2700-975



2700-987

0.7 mm tip / titanium / 4 hole serrated handle / 9" (22.9 cm)
2700-983



2700-984

0.8 mm tip / stainless steel / 10 1/4" (26 cm)
2700-988



2700-988

Reusable Bipolar Cord

12 feet in length
CORD-2000

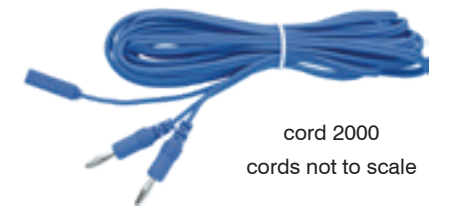

cord 2000
cords not to scale

Disposable Bipolar Cord

Sterile-12 ft long / nickle plated banana plugs / forceps plug compatible with all manufacture bipolar forceps and sweeps / packaged 50 per case/ box of 10
CORD-1000

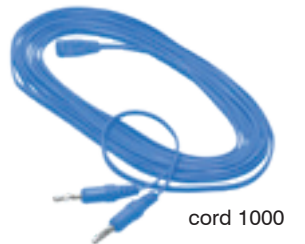

cord 1000

Titanium Bayonet Bipolar Forceps

Blue coating / 1.5 mm tip / irrigated / insulated / 8 3/4" (22 cm)
2700-955



2700-955

Hardy Bayonet Coagulation Forceps

Blue coating / 1.5 mm tip, irrigated / insulated stops / 8 1/2" (21.5 cm)
2700-960



2700-960

Scoville Bayonet Bipolar Forceps

Blue electro coating / 7 1/2" (19 cm)
2700-967 1 mm tip
2700-968 1.5 mm tip



Blue coating / 2 mm tip / 7 3/4" (19.5 cm)
2700-965

2700-965

Scoville Bipolar Forceps

Non-stick / Black electro coating / 1.5 mm tip / 7 1/2" (19 cm)

2700-968NS



2700-968NS

Jensen Bipolar Bayonet Irrigation Forceps

Blue insulated / 1.0 mm / 7 1/2" (19 cm)

2700-887



2700-887

Jansen Bipolar Forceps

Black electro coating / 5" (12.7 cm)

2700-879NS 1.0 mm

Black electro coating / 6" (15 cm)

2700-880NS 0.5 mm
2700-881NS 1.0 mm
2700-8815NS 1.5 mm



2700-880NS

Black electro coating / 7" (18 cm)

2700-890NS 0.5 mm
2700-891NS 1 mm
2700-8915NS 1.5 mm



2700-890NS



2700-891NS

Cushing Bipolar Forceps

1.5 mm tip / blue electro coating / 7" (18 cm)

2700-995



2700-995

Cushing Bipolar Forceps

Black insulated / non-stick / 1.5 mm tip / 7" (18 cm)

2700-995NS



Tissue Bipolar Forceps

Black insulated / non-stick / 2.0 mm tip / 6" (15 cm)

2700-862NS

2700-864NS with stop pin



2700-862NS



2700-864NS

Hardy Bayonet Bipolar Forceps

1 mm tip / insulated / straight / 8 1/2" (21.5 cm)

2700-959



2700-959

Coaptation Bipolar Forceps

0.4 x 3 mm tip / 4 1/4" (10.5 cm)

2700-930



2700-930

Bipolar Bayonet Wide Grip Forceps

Non-stick / black insulated / with stop pin / wide handle / 8 mm x 2 mm

| | | |
|------------|----------------|--------|
| 2700-840NS | downward angle | 6" |
| 2700-842NS | downward angle | 6 3/4" |
| 2700-844NS | downward angle | 8" |
| 2700-850NS | straight | 6" |
| 2700-852NS | straight | 6 3/4" |
| 2700-854NS | straight | 8" |
| 2700-856NS | straight | 9" |



2700-844NS



2700-852NS

Non-stick / black insulated / with stop pin / wide handle / 1.2 mm x 8 mm

| | | |
|-------------|----------------|-----|
| 2700-8581NS | downward angle | 8" |
| 2700-8591NS | downward angle | 9" |
| 2700-8601NS | downward angle | 10" |
| 2700-858NS | straight | 8" |
| 2700-859NS | straight | 9" |
| 2700-860NS | straight | 10" |



2700-8591NS



2700-859NS

Bipolar Bayonet Wide Grip Forceps

Unique micro / non-stick / black insulated / with stop pin / wide handle / thin shanks / straight / 4 mm x 1.2 mm

| | |
|------------|--------|
| 2700-837NS | 6 3/4" |
| 2700-839NS | 8" |



Black Monopolar Suction Tube

Non-stick / insulated

| | | | | |
|------------|----------|--------|-----|----------|
| 2700-550NS | straight | 4.3 mm | 5" | flexible |
| 2700-552NS | angled | 3.3 mm | 5" | flexible |
| 2700-554NS | angled | 4.0 mm | 5" | flexible |
| 2700-556NS | angled | 3.3 mm | 10" | flexible |
| 2700-558NS | angled | 4.0 mm | 10" | flexible |
| 2700-560NS | angled | 4.0 mm | 12" | flexible |

Bipolar Bayonet Suction Wide Grip Forceps

Black insulated / with suction / stop pin / 1.4 mm

| | |
|----------|--------------|
| 2700-817 | 8" (20.3 cm) |
| 2700-819 | 9" (22.9 cm) |



2700-817

Black Bipolar Bayonet Irrigation Forceps

Insulated / with stop pin / straight / 1.2 mm

| | |
|----------|--------|
| 2700-810 | 6 3/4" |
| 2700-812 | 8" |
| 2700-814 | 8 3/4" |
| 2700-815 | 9" |



2700-810

Yasargil Forceps Titanium

Flat bayonet / TC dust / 8 3/4" (22.2 cm)

2601-295 straight 0.5 mm serrated handle
 2601-295C straight 0.5 mm cross-serrated handle

Flat bayonet / serrated handle / TC dust / 9" (23 cm)

2601-296 angle up 0.5 mm
 2601-290 straight 1 mm
 2601-291 curved 1 mm
 2601-292 angled up 1 mm

Flat bayonet / serrated handle / TC dust / 10" (25.4 cm)

2601-293 straight 1 mm



Yasargil Forceps Titanium

Flat bayonet / 3 hole handle / TC dust / 9" (23 cm)

2601-299 straight 1 mm

Round bayonet handle / TC dust / 9" (23 cm)

2601-270 straight 0.5 mm
 2601-274 straight 1 mm

Round bayonet handle / TC dust / 1 x 2 teeth / 9" (23 cm)

2601-260 straight 1 mm

Flat bayonet / 3 hole handle / straight / 1.3mm / 1 x 2 teeth / 8" (20.5 cm)

2601-298



Yasargil Micro Forceps Titanium

Flat bayonet / 3 hole handle / TCD / 1 mm ring tip / 9" (23cm)

2601-280

Flat bayonet / serrated handle / TCD / 9" (23cm)

2601-282 straight 1 mm ring tip

2601-283 straight 1.3 mm ring tip

Round bayonet handle / TCD / 8" (20.3 cm)

2601-285 straight 1 mm ring tip



2601-280

2601-282

2601-283

2601-285

Yasargil Tumor Grasping Forceps Titanium

Flat bayonet 3 hole handle / flat serrated tip / 3 mm / 9" (23cm)

2601-275 straight

Round bayonet handle / flat serrated tip 4 mm / 9" (23cm)

2601-278 straight

Flat serrated handle / flat serrated tip / straight / 9" (23cm)

2601-276 3 mm

2601-279 5 mm

Flat serrated handle / curette serrated tip / straight / 9" (23cm)

2601-266 3 mm

2601-269 5 mm



2601-275

2601-278

2601-276

2601-279

2601-269

2601-266

Yasargil Bayonet Forceps Titanium

3 hole flat handle / straight / 9" (23cm)

- 2601-288 0.9 mm micro tip
- 2601-289 1.2 mm atraumatic tip



2601-288

Yasargil Tumor Grasping Bayonet Forceps Titanium

3 hole flat handle / spoon shaped / straight / 9" (23cm)

- 2601-262 5 mm
- 2601-264 7 mm



2601-262

Yasargil Tumor Grasping Bayonet Forceps Titanium

3 hole flat handle / 3 mm spoon shaped / 70° angle up / 9" (23cm)

- 2601-255



2601-255

Yasargil Micro Forceps Titanium

Flat bayonet / 4 hole handle / straight / TCD / 1mm / 9" (23cm)

- 2601-294



2601-294

DeBakey Bayonet Forceps

1.5 mm tip

- 2200-115 7 3/4" (19.5 cm)
- 2200-117A 8 1/2" (12.5 cm)

1.5 mm tip / TC / 7 3/4" (19.7 cm)

- 2200-1151



2200-115

2200-117A

2200-1151

Gerald Bayonet Forceps

1 mm serrated tip / 7 5/8" (19 cm)

- 412-334



412-334

Micro Bayonet Forceps

3 hole handle / TC dust / sharp

- 400-091 straight 8" (20 cm)
- 400-095 angled 8" (20 cm)
- 400-101 straight 9" (23 cm)
- 400-105 angled 9" (23 cm)
- 400-109 straight 9 1/2" (24 cm)
- 400-113 angled 9 1/2" (24 cm)

3 hole handle / TC dust / blunt

- 400-093 straight 8" (20 cm)
- 400-097 angled 8" (20 cm)
- 400-103 straight 9" (23 cm)
- 400-107 angled 9" (23 cm)
- 400-111 straight 9 1/2" (24 cm)
- 400-115 angled 9 1/2" (24 cm)



400-111

Yasargil Micro Bayonet Forceps

TC dust / straight / 9" (23 cm)

- 400-298 sharp
- 400-296 blunt

TC dust / angled / 9" (23 cm)

- 400-293 sharp
- 400-294 blunt

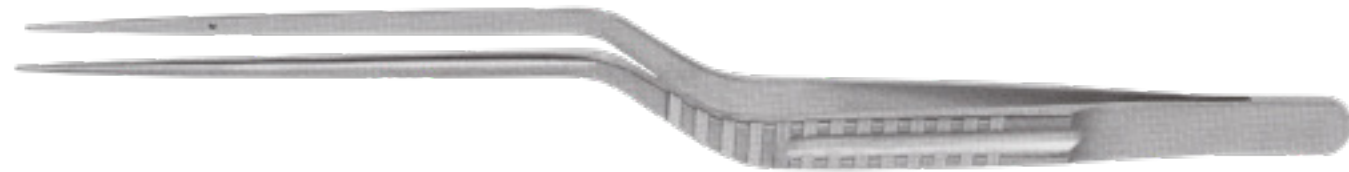

400-296

Yasargil Tumor Bayonet Forceps

Serrated handle / spoon shaped / 9" (23 cm)

- 400-070 3 mm
- 400-071 5 mm

Serrated handle / flat serrated / 9" (23 cm)

- 400-074 3 mm
- 400-075 5 mm

Serrated handle / curette toothed / 9" (23 cm)

- 400-076 3 mm
- 400-077 5 mm



400-077

Yasargil Atrauma Forceps

DeBakey / straight / 1.2 mm 8" (20.3 cm)

400-080



400-080

Bayonet Forceps

Blue coat / serrated / 7 3/4" (20 cm)

467-317B

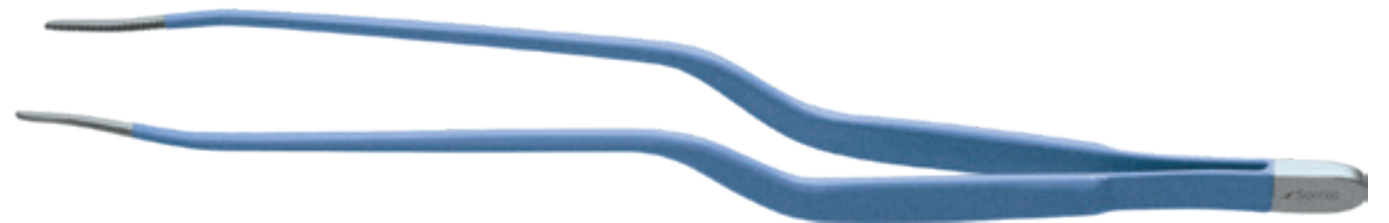

467-317B

Lucae Ear Forceps

Bayonet handle / serrated

- 467-310 4 1/2" (11.5 cm)
- 467-311 5 1/2" (14 cm)



467-310

Wilde Ear Forceps

Serrated / 5 1/2" (14 cm)

467-320



467-320

Jacobson Micro Bayonet Forceps

Straight / 7" (18 cm)

- 400-360 sharp
- 400-358 blunt

Angled / 7" (18 cm)

- 400-364 sharp
- 400-362 blunt



400-362

TC dust / straight / 7" (18 cm)

- 400-361 sharp
- 400-359 blunt

TC dust / angled / 7" (18 cm)

- 400-365 sharp
- 400-363 blunt

Hypophyseal Bayonet Forceps

With smooth cupped jaws 7 mm Ø / 8 3/4" (22 cm)

- 400-050
- 400-050T titanium



400-050

Yasargil Tumor Grasping Bayonet Forceps

3mm / 3 hole handle / 9 1/4"

- 400-060 spoon shaped
- 400-063 flat serrated
- 400-066 curette toothed

5mm / 3 hole handle / 9 1/4"

- 400-061 spoon shaped
- 400-064 flat serrated
- 400-067 curette toothed



400-066

Cushing Bayonet Forceps

TC / serrated / 7 1/2" (19 cm)

- 140-220



140-220

Cushing Dressing Bayonet Forceps

1 x 2 teeth / 7 1/4" (18.4 cm)

- 136-787



136-787

Cottle Lower Antrum Forceps

Boyonet / screw lock / 6" (15.2 cm)

- 468-300



468-300

Electro Blue Coated Cushing Bayonet Tissue Forceps

Monopolar use / TC serrated/insulated

140-220B 7 1/2"
140-222B 9"



140-220B

Brown-Cushing Bayonet Forceps

9 x 9 teeth / 7 1/4" (18.25 cm)

136-798

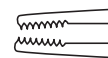

136-798

Jansen Bayonet Ear Forceps Titanium

1.0 mm / serrated tips / 5 1/2" (14 cm)

467-314T



467-314T

Gruenwald (Jansen) Ear Forceps

Bayonet handle / serrated

467-315 6 1/2" (16.5 cm)
467-317 7 3/4" (19.5 cm)
467-318 8 1/2" (21.5 cm)



467-315



467-317



467-318

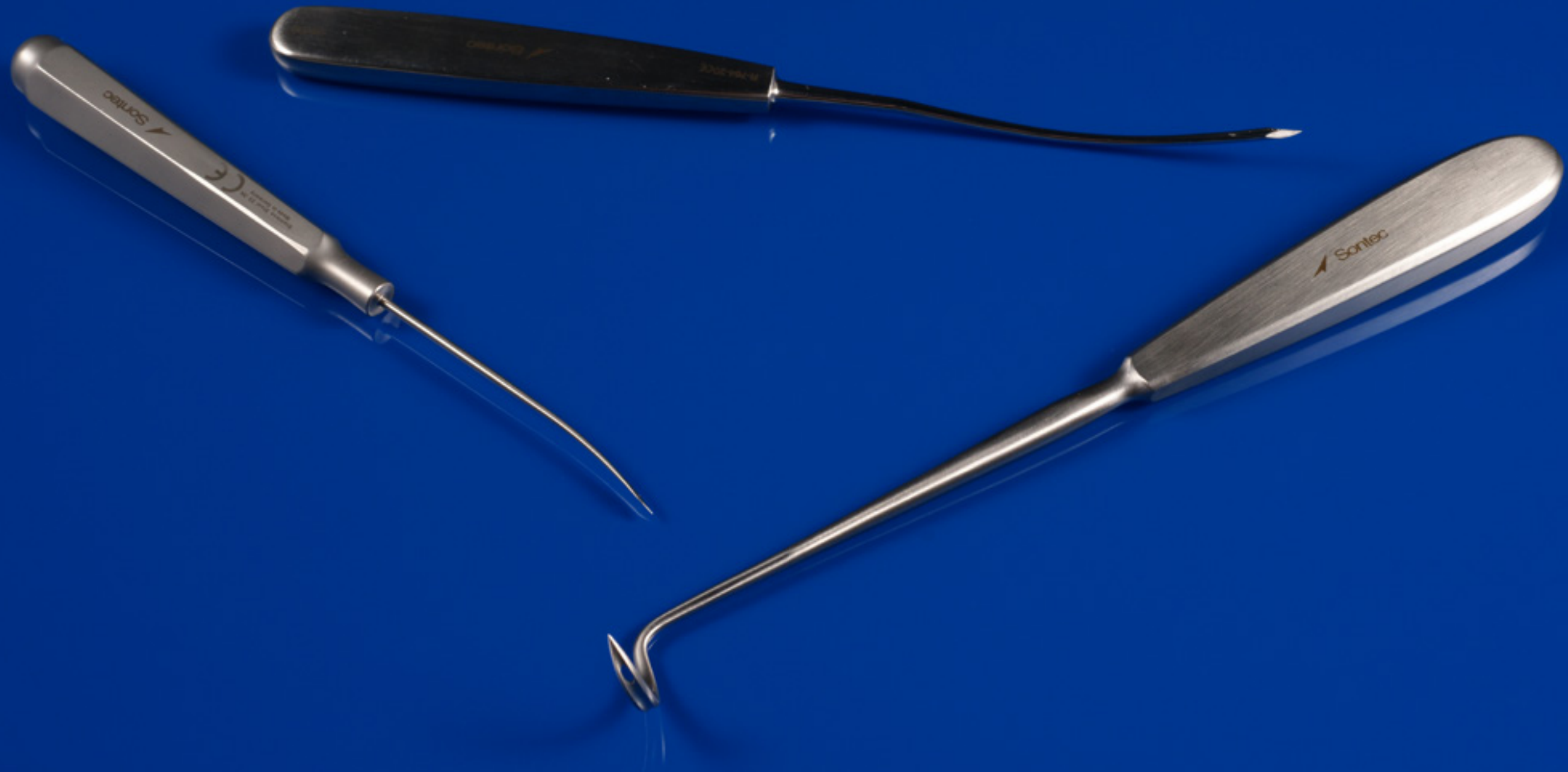

 Sontec Instruments®

Ligature Carriers

Cassio Ligature Carrier

Sharp / straight / 8" (20.5 cm)
134-240

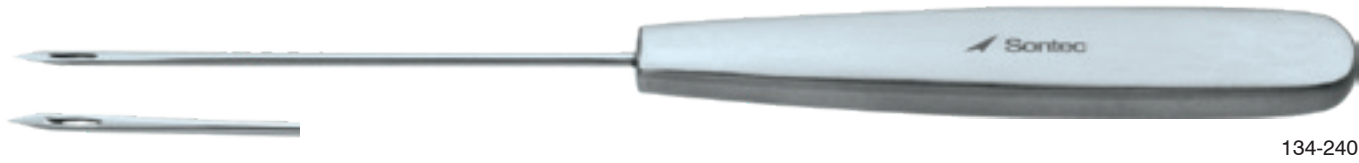

134-240

Sontec Reverdin Blunt Needle/Ligature Carrier

Blunt / curved / 8" (20.5 cm)
134-242



134-242

Reverdin Needle/Ligature Carrier

Sharp / curved / 8" (20.5 cm)
134-276



134-276

Durrani Dorsal Vein Complex Ligation Needle

90° sharp / 9" (22.9 cm)
515-505



515-505

Tendon Passer Ligature Carrier

10.5" (26 mm) / 11" phenolic handle
305-910



305-910

Graft Passer Ligature Carrier

Curved
1106-400 2 cm extra small
1106-401 3 cm small
1106-402 4.5 cm large
1106-403 6 cm extra large
1106-404 8cm XX large



1106-400

1106-401

1106-402

1106-403



1106-400

Deschamps Ligature Carrier

Small / 25 mm / 8" (20 cm)

- 134-277 sharp left
- 134-278 sharp right
- 134-280 blunt left
- 134-281 blunt right



134-278

Medium / 30 mm / 8" (20 cm)

- 134-277M sharp left
- 134-278M sharp right
- 134-280M blunt left
- 134-281M blunt right

Large / 35 mm / 9 1/2" (24 cm)

- 134-282A sharp left
- 134-282B sharp right



134-277

Schmieden-Dick Ligature Carrier

Malleable / 12 3/4" (32.5 cm)

134-267



134-267

Entner Ligature Carrier

Curved

- 134-243 8.1/4" (21 cm)
- 134-245 6.1/2" (16.5 cm)



134-243

Sanders Brown Ligature Carrier

10" (25 cm)

134-248



134-248

Eyebrow Lifting Ligature Carrier

11" (28 cm)

134-268



134-268

Facia Ligature Carrier

6" (15 cm)

134-247



134-247



 Sontec Instruments®

Micro HAND SURGERY

Micro Scissors Long 14 mm Blades Round Handle Titanium

| | | | |
|-----------|----------|----------------|-----------------|
| 2602-100 | straight | 5 1/2" (14 cm) | |
| 2602-101 | curved | 5 1/2" (14 cm) | |
| 2602-102 | straight | 7" (17.8 cm) | |
| 2602-1201 | straight | 7" (17.8 cm) | serrated blades |
| 2602-103 | curved | 7" (17.8 cm) | |
| 2602-1031 | curved | 7" (17.8 cm) | serrated blades |



2602-100



2602-101

Micro Scissors Small 8 mm Blades Round Handle Titanium

| | | |
|-----------|----------|------------------|
| 2602-104 | straight | 5 1/2" (14 cm) |
| 2602-105 | curved | 5 1/2" (14 cm) |
| 2602-1051 | curved | 5 3/4" (14.6 cm) |
| 2602-106 | straight | 7" (17.8 cm) |
| 2602-107 | curved | 7" (17.8 cm) |



2602-104



2602-105



2602-1051



2602-106



2602-107

Micro TCD Round Handle 5 1/2" Needle Holder Titanium

| | | |
|----------|----------|------------------|
| 2602-300 | curved | |
| 2602-301 | curved | with lock |
| 2602-302 | curved | with lock 1.0 mm |
| 2602-303 | straight | |
| 2602-304 | straight | with lock 0.3 mm |



2602-300



2602-301



2602-302



2602-303



2602-304

Micro TCD Round Handle 7" Needle Holder Titanium

| | | |
|----------|----------|------------------|
| 2602-305 | curved | |
| 2602-306 | curved | with lock 0.5 mm |
| 2602-307 | straight | |
| 2602-308 | straight | with lock 0.5 mm |



2602-305



2602-306



2602-307



2602-308

Micro Round Handle 6" Forceps Titanium

| | | | | |
|----------|----------|---------------|--------|---------|
| 2602-200 | straight | with platform | | 0.20 mm |
| 2602-201 | straight | with platform | | 0.10 mm |
| 2602-202 | straight | with platform | strong | 0.3 mm |
| 2602-203 | curved | with platform | strong | 0.3 mm |



2602-200



2602-201



2602-202



2602-203

Micro Round Handle Forceps Titanium

| | | | |
|----------|----------|--------|--------------|
| 2602-204 | curved | 0.3 mm | 7" (17.8 cm) |
| 2602-205 | straight | 0.3 mm | 7" (17.8 cm) |
| 2602-206 | curved | 0.4 mm | 8" (20.3 cm) |
| 2602-207 | straight | 0.4 mm | 8" (20.3 cm) |
| 2602-208 | straight | 0.6 mm | 6" (15.2 cm) |
| 2602-209 | curved | 0.6 mm | 6" (15.2 cm) |



2602-204



2602-205



2602-206



2602-207



2602-208



2602-209

Micro Straight Round Handle Forceps Titanium

| | | | |
|----------|----------|---------------|--------------|
| 2602-210 | delicate | 1x2 teeth | 6" (15.2 cm) |
| 2602-211 | delicate | 1 mm ring tip | 6" (15.2 cm) |
| 2602-212 | delicate | 1 mm ring tip | 7" (17.8 cm) |



2602-211



2602-210



2602-212



 Sontec Instruments®

Neuro HOOKS

Doolen Neuro Hook

1 mm ball tip / 90° / 8" (20.5 cm)

- 2700-501 2 mm from angle
- 2700-502 3 mm from angle



Krayenbuehl Nerve Hook

90° / 7 1/4" (18.5 cm)

- 400-445 2 mm tip length
- 400-447 2 mm tip length 1 mm ball tip
- 400-446 3 mm tip length
- 400-448 3 mm tip length 1 mm ball tip

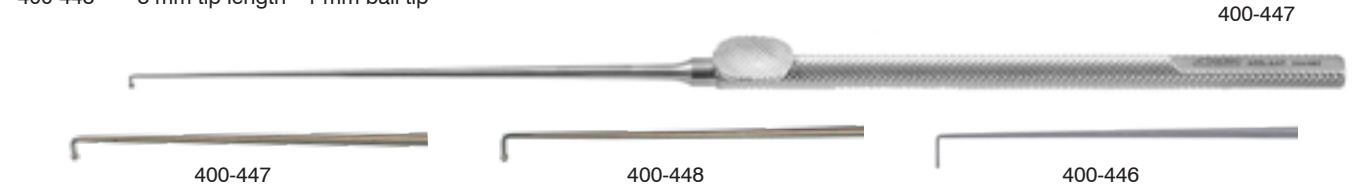

Krayenbuehl Nerve Hook Extra Long Version

Round Handle / special long model / 11" (27.9 cm)

- 400-445L 2 mm tip length
- 400-447L 2 mm tip length 1 mm ball tip
- 400-446L 3 mm tip length
- 400-448L 3 mm tip length 1 mm ball tip



Tufts Pigtail Neuro Hook Probe

With ball tip / twist right / large / 6 1/2" (16.5 cm)

- 412-443



Frazier Dorsey Dura Separator

Angled / 5 x 15 mm blades / 6" (15.2 cm)

- 412-488



Tufts Pigtail Neuro Hook Probe

With ball tip / 6 3/4" (17 cm)

- 412-442L spirals left
- 412-442R spirals right

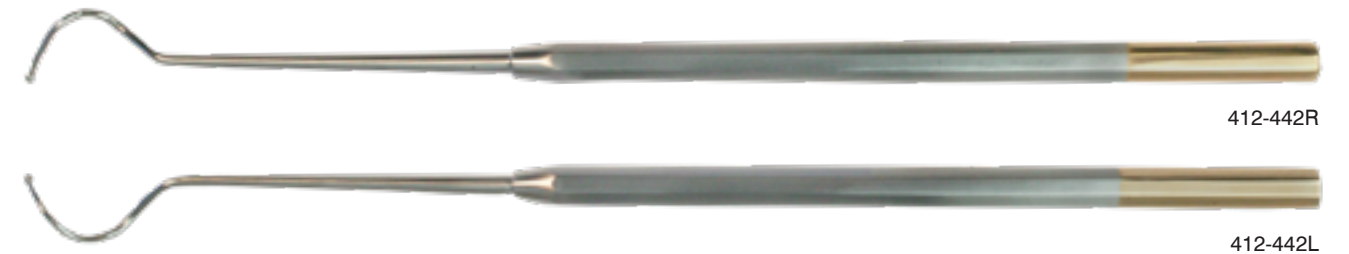

Pig Tail Neuro Hook Probe

With ball tip / 6 7/8" (17.5 cm)

- 412-444 spirals right
- 412-444L spirals left
- 412-444KR spirals right 90° angle up
- 412-444KL spirals left 90° angle up

Titanium / with ball tip / 6 7/8" (17.5 cm)

- 412-444T spirals right
- 412-444LT spirals left



Culler Neuro Round Handle Hook

Unique sharp 3 mm tip length / 5 1/2"

412-445D

5 mm tip length

412-445B 0.7 mm Ø x 5 mm tip length 4 3/4"

412-445A 1 mm Ø x 5 mm tip length 4 3/4"

412-445CL 1 mm tip Ø 6 1/4"

0.5 mm Ø tip

412-445C 3 mm tip length 4 5/8"

412-445AL 3 mm tip length 6 1/4"

412-445BL 2 mm tip length 6 1/4"

1.0 mm Ø 45° 4 mm tip / 6 1/4"

412-445EL

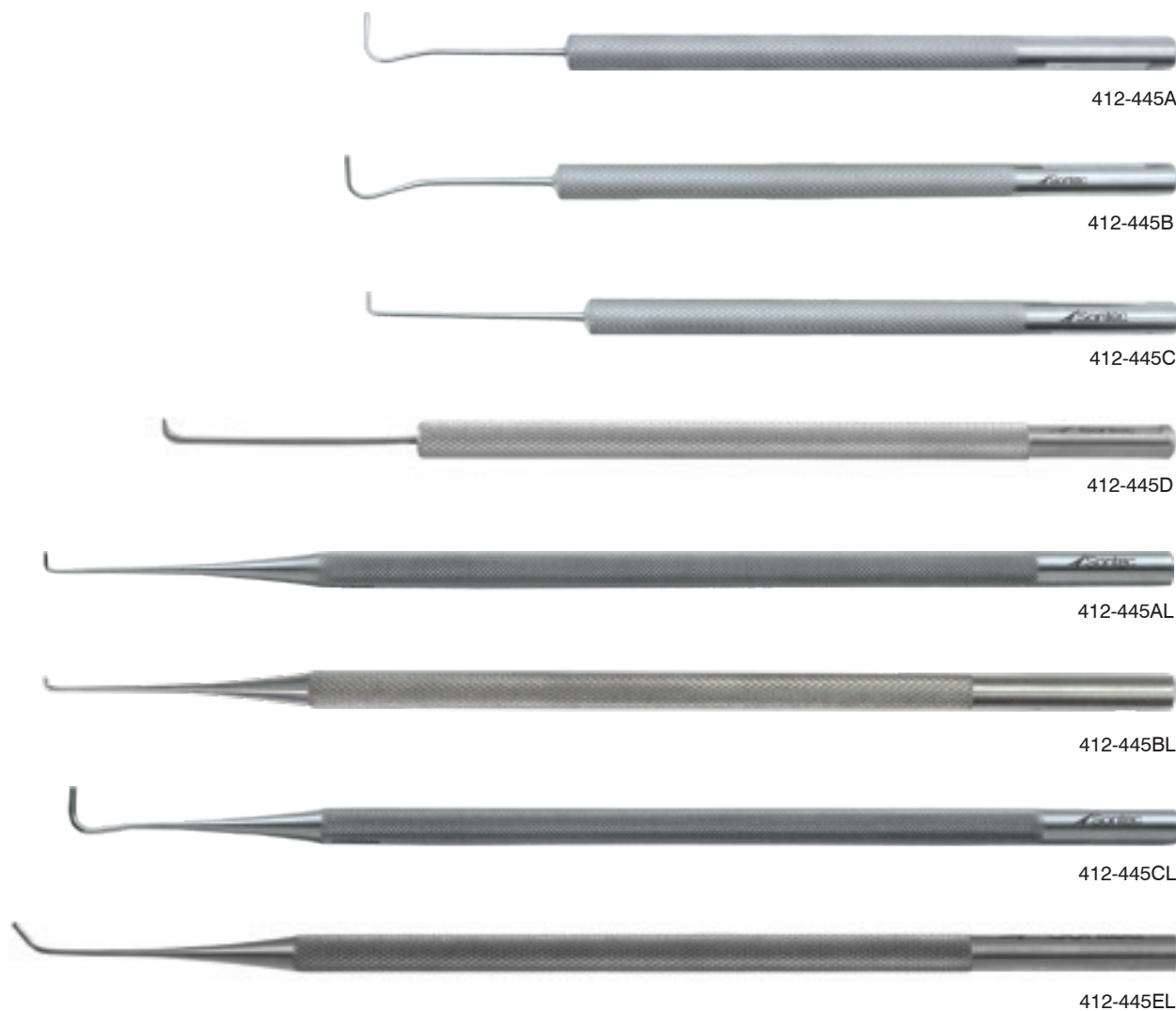

Culler Neuro Round Handle Hook Titanium

Unique sharp 3 mm tip length / 5 1/2"

412-445DT

5 mm tip length

412-445BT 0.7 mm tip Ø 4 3/4"

412-445AT 1 mm tip Ø 4 3/4"

412-445CLT 1 mm tip Ø 6 1/4"

0.5 mm Ø tip

412-445CT 2.5 mm tip length 4 5/8"

412-445ALT 2 mm tip length 6 1/4"

412-445BLT 2.0 mm tip length 6 1/4"

1.0 mm Ø 45° 4 mm tip / 6 1/4"

412-445ELT

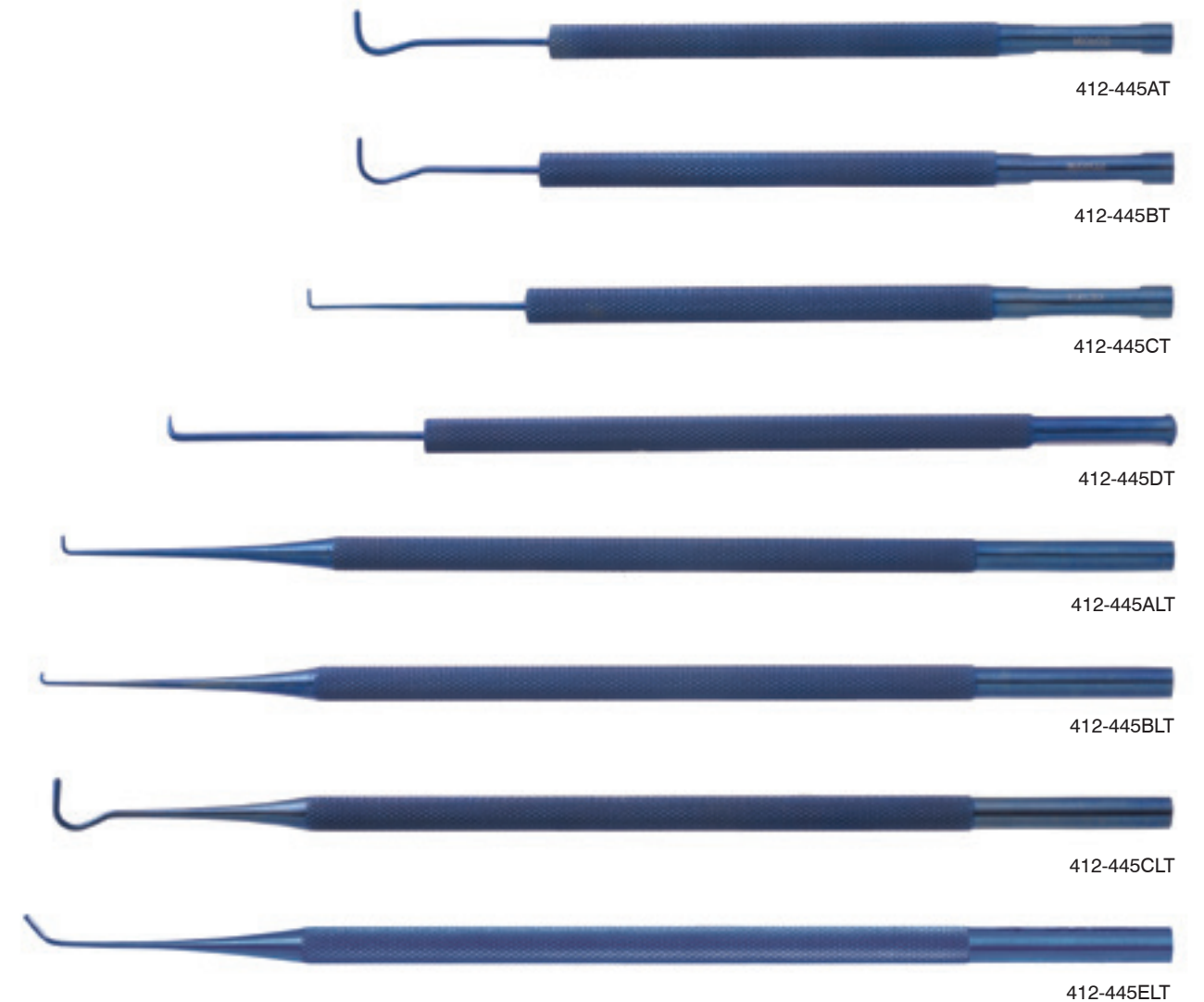

Sontec Nerve Hook Titanium

3 mm tip length / 1 mm ball Tip

2700-470A 7 1/8" (18 cm) 5 mm hook with 1 mm ball tip
 2700-470 8" (20 cm) 3 mm hook with 1 mm ball tip



2700-470A

Nerve & Vessel Hook Titanium

10" (25.5 cm)

2700-450 3.5 mm tip with graduation marks
 2700-451 1.5 mm ball tip



2700-450



2700-451

Krayenbuehl Nerve Hook Titanium

90° / 7 1/4" (18.5 cm)

| | | | |
|----------|--------------|------------------|-------|
| 400-461T | 3 mm probe | 1 mm ball tip | small |
| 400-462T | 3.8 mm probe | 1 mm ball tip | large |
| 400-463T | 2.5 mm probe | without ball tip | small |
| 400-464T | 4.0 mm probe | without ball tip | large |



400-461T



400-462T



400-463T



400-464T

Heartline Nerve & Vessel Hook

3.2 mm tip with graduation marks / 12" (30.5 cm)

2800-450

1.5 mm ball tip / 10" (25 cm)

2800-451



2800-450



2800-451

Carpentier Vascular Hook Titanium

9 1/2" (24 cm)

2700-431 45° angle
 2700-432 90° angle
 2700-433 125° angle



2700-432

Bayonet Nerve Hook

6" (150 mm) working length / 10 3/4" (27 cm) overall length

412-615



actual size

412-615

Dandy Nerve Hook

9" (23 cm)

- 412-438 straight shaft
- 412-440 angled left shaft
- 412-442 angled right shaft



412-438



412-440



412-442

Bayonet Nerve Hook Titanium

Backward facing 0.9mm Ø tip / 20 mm working length / 12 1/4" (31 cm)

412-616T



412-616T

Lucae Ear Hook

Fine / indent ball end / 6" (15 cm)

- 468-169 2.0 mm
- 468-170 2.5 mm
- 468-171 3.0 mm
- 468-172 4.0 mm



468-171

Bryant Mitral Hook Retractor

10 3/4" (26.5 cm)

- 2500-313 3 semi-sharp prongs
- 2500-313T 3 semi-sharp prongs
- 2500-315 2 semi-sharp prongs
- 2500-315T 2 semi-sharp prongs
- 2500-320 1 semi-sharp prong
- 2500-320T 1 semi-sharp prong



2500-313



2500-313T



2500-315



2500-315T



2500-320



2500-320T

Wagner Hook

5 1/2" (14 cm)

- 468-181 size 1
- 468-182 size 2
- 468-183 size 3
- 468-184 size 4
- 468-185 size 5



468-183



Nerve Hook Titanium

Bayonet / ball Tip (0.5mm) / 9 1/4" (23.5 cm)

412-618T



412-618T

Cushing Dura Hook

6 1/2" (16 cm)

412-414



412-414

Cloward Dura Hook

6 1/2" (16 cm)

412-415



412-415

Graham Dura Hook

6 1/2" (16 cm)

412-422



412-422

Micro Hook Titanium

90° graduation (1 mm) / 7 1/2" (19 cm)

2700-504



2700-504

enlarged to show tip detail

Yasargil Galea Spring Neuro Hook

Double sharp prong hook / bulldog clamp / spring body / 310 mm

2700-405





 Sontec Instruments®

Neuro RASPATORY

Yasargil® Raspatory Titanium

7 1/4" (18.5 cm)

- 400-420T angle with wide blade
- 400-421T light curve with narrow blade
- 400-422T curved with narrow blade
- 400-423T angle with narrow blade



400-420T



400-421T



400-422T



400-423T

Yasargil® Raspatory Titanium

Angled with wide blade / 5" (13 cm)

400-419T



400-419T



Yasargil Raspatory Probe Set

Single-ended / 7 1/4" (18.5 cm)

- 2700-412 slight curve
- 2700-414 full curve
- 2700-416 angled
- 2700-424 double angle
- 2700-426 dissector

Single-ended / 9" (22.9 cm)

- 2700-410 slight curve



2700-410



2700-412



2700-414

Jacobson Raspatory/Probe Set

Single-ended / Round Handle / 7 1/4" (18.5 cm)

- 2700-418 buttoned probe
- 2700-420 twin probe
- 2700-422 suture pusher
- 2700-428 vessel knife



2700-428

2700-422

2700-420

2700-418



 Sontec Instruments®

Neuro Spinal DISSECTORS

Yasargil Bayonet Raspatory Titanium



Yasargil Dissector Raspatory Titanium



Ochsner Dissector



Ochsner-Sontec Straight Dissector



Ochsner Dissector

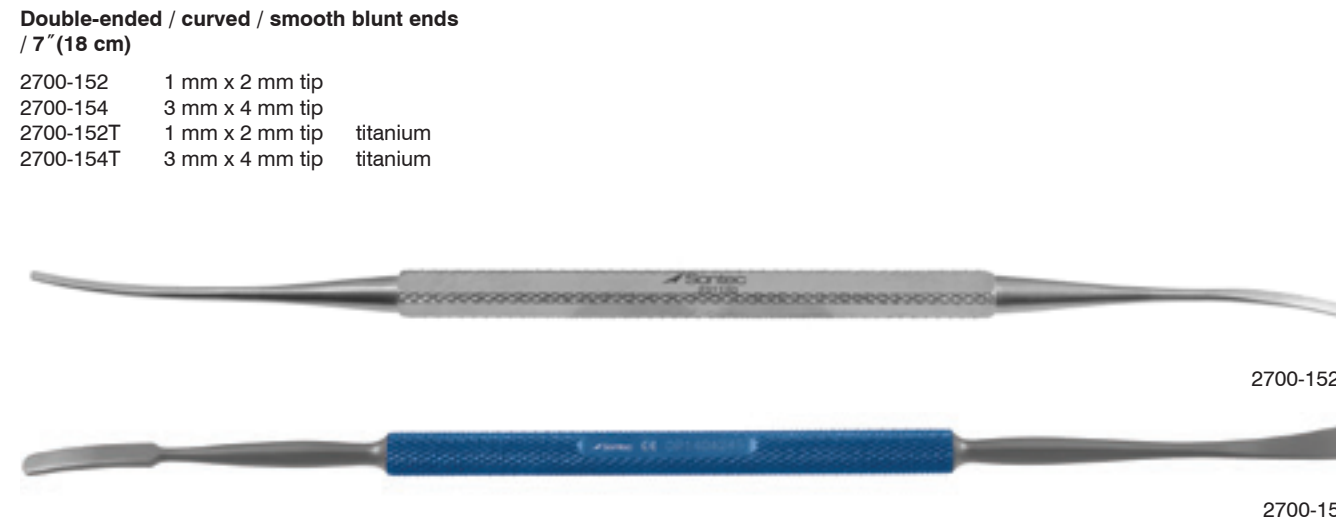

Olivecrona Dissector

Double-ended / curved / with Ligature Guide

| | | |
|----------|-----------------|------------------|
| 2700-164 | 1 mm x 2 mm tip | 7" (18 cm) |
| 2700-165 | 2 mm x 3 mm tip | 7" (18 cm) |
| 2700-166 | 3 mm x 4 mm tip | 7" (18 cm) |
| 2700-168 | 1 mm x 2 mm tip | 7 3/4" (19.5 cm) |
| 2700-170 | 3 mm x 4 mm tip | 7 3/4" (19.5 cm) |
| 2700-160 | 2 mm x 3 mm tip | 9 1/2" (24 cm) |
| 2700-162 | 3 mm x 4 mm tip | 9 1/2" (24 cm) |



Titanium Sontec® Dissector

Single-ended / round knurled handle /
curved / 7 3/4" (19.5 cm)

| | |
|---------|---------------|
| 412-545 | 3 mm delicate |
| 412-546 | 4 mm regular |



Lemmon Dissector

Semi sharp / 4 mm tip / 6 3/4" (17 cm)

| | |
|---------|--------------|
| 440-420 | slight curve |
| 440-421 | medium curve |
| 440-423 | full curve |



Penfield Dissector Set

Sets

412-552 #1 - #5 stainless steel
 412-552T #1 - #5 titanium

**Double-ended / dissector / curette /
 curved / 6 mm / #1 / 7" (18 cm)**

412-547
 412-547T titanium

**Double-ended / dissector / wax packer /
 7 3/4" (19.5 cm)**

412-548 curved #2
 412-548T curved #2 titanium
 412-549 full curve #3
 412-549T full curve #3 titanium

**Single-ended dissector / curved / 3mm /
 #4 / 8 1/4" (21 cm)**

412-550
 412-550T titanium

**Double-ended dissector / curved / 6mm /
 #5 / 11 1/2" (29 cm)**

412-551
 412-551T titanium



412-547



412-548T



412-549T



412-550



412-551



 Sontec Instruments®

Neuro Spinal ELEVATORS

Nelms Suction Elevator

- 2700-310 suction freer style sharp 7" (18 cm)
- 2700-312 suction freer style blunt 7" (18 cm)
- 2700-314 suction cottle style blunt 7 1/2" (19 cm)

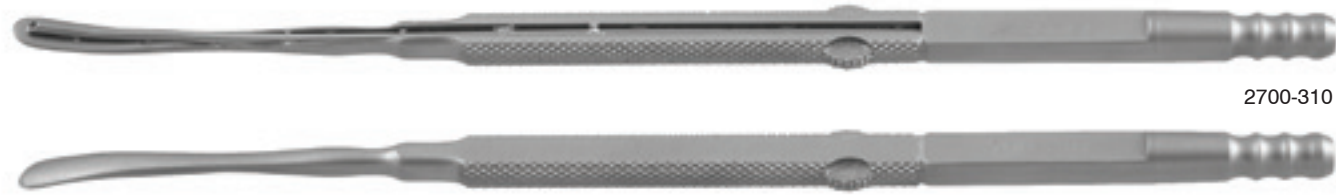

2700-310

Yasargil Bayonet Elevator Titanium

Straight oval tip (2.75mm wide) / 8 7/8" (22 cm)

400-429T

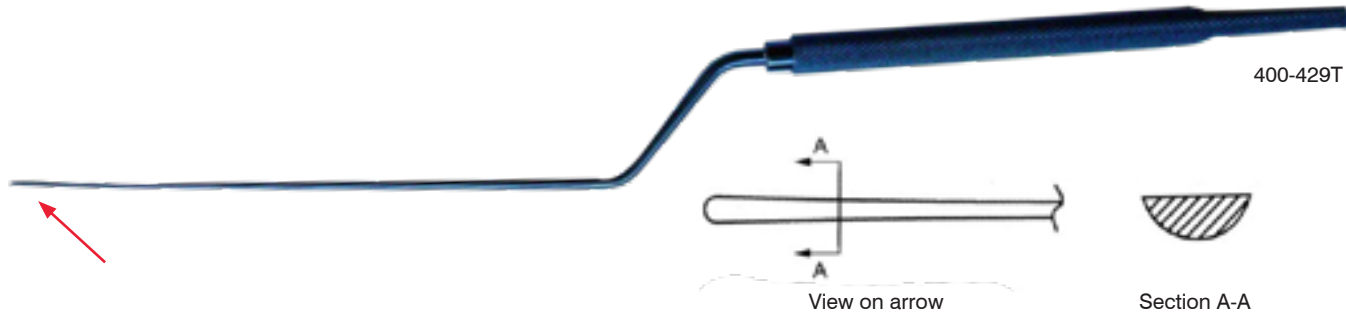

400-429T

Cobb Spinal Elevator

Sharp / stainless / 11" (28 cm)

- 330-654 3/8" tip
- 330-655 1/2" tip
- 330-656 3/4" tip
- 330-657 1" tip
- 330-658 1 1/4" tip

Sharp / stainless / aluminum handle / 11" (28 cm)

- 330-654A 3/8" tip
- 330-655A 1/2" tip
- 330-656A 3/4" tip
- 330-657A 1" tip
- 330-658A 1 1/4" tip

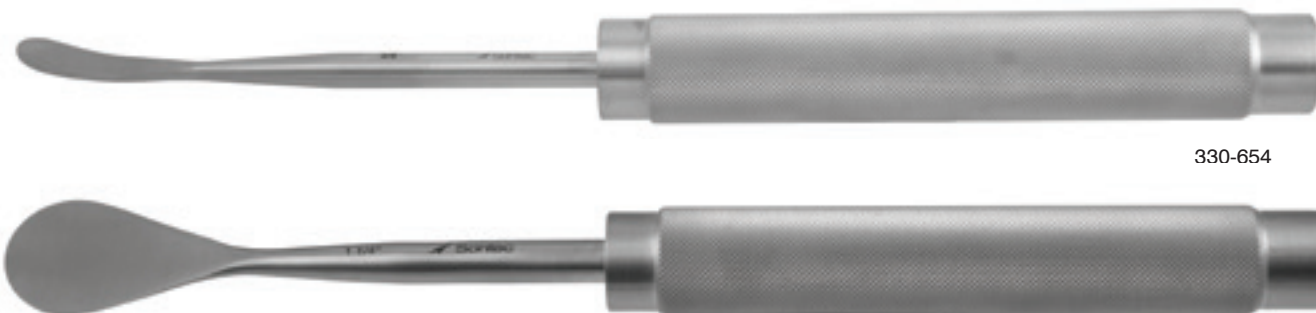

330-654

330-658

Cobb Spinal Elevator

Hex handle / 9 1/2" (24 cm)

- 335-320 3/8"
- 335-322 1/2"
- 335-324 3/4"
- 335-325 1"
- 335-326 1 1/4"

Long phenolic handle / 13" (33 cm)

- 335-326A size 1/2
- 335-326B size 5/8
- 335-326C size 3/4
- 335-326D size 1
- 335-326E size 1 1/8"

Long phenolic handle / 15" (38 cm)

- 335-327A size 1/2
- 335-327B size 5/8
- 335-327C size 3/4
- 335-327D size 1
- 335-327E size 1 1/8"

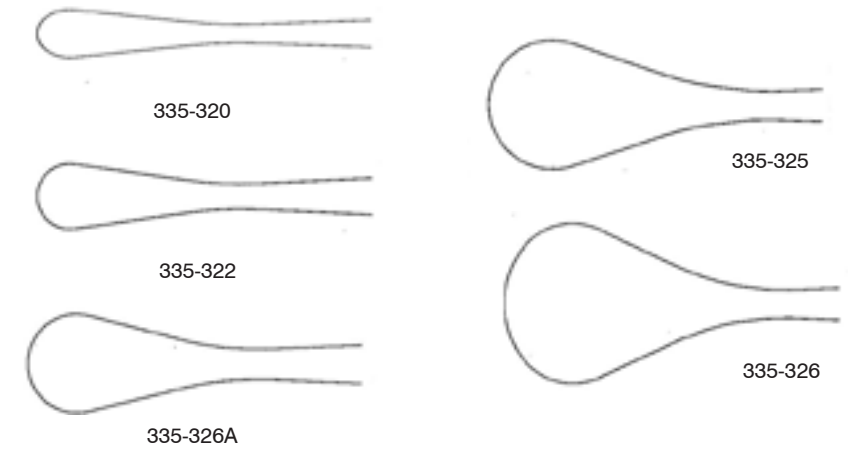

335-320



335-324



335-326

Cobb Spinal Elevator with Unique Handle

Sharp / black handle / 16 1/2" (41.9 cm)

- 320-627B small cobb
- 320-628B large cobb

Sharp / green handle / 16 1/2" (41.9 cm)

- 320-627G small cobb
- 320-628G large cobb

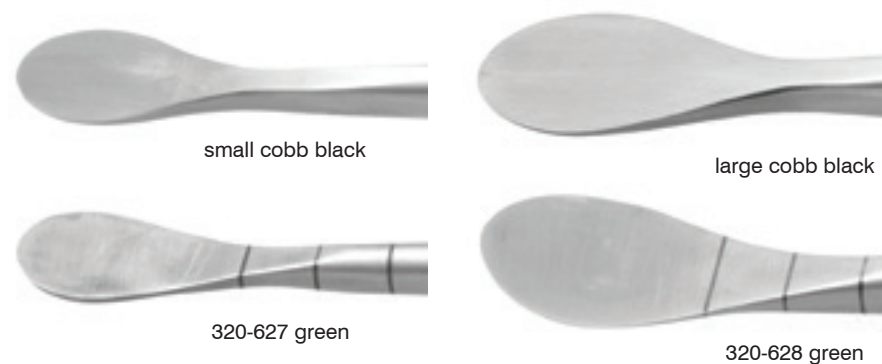

320-627B



320-627G

Wagner Spinal Elevator

Phenolic handle

- 335-350 8 mm tip 13" (33 cm)
- 335-360 20 mm tip 11" (28 cm)
- 335-355 17 mm tip 13" (33 cm)



335-350



335-360



335-355

Freer/Pennington Extra Long Spinal Elevator

Blunt / blunt / 10 mm ends / 12" (30.5 mm) / extra extra large

1100-791



1100-791



 Sontec Instruments®

Neuro Spinal PROBES

Murphy Ball End Probe

8 1/2" (22 cm)

- 413-030 curved
- 413-031 straight

10 1/2" (25 cm)

- 413-032 curved
- 413-033 straight



413-030



413-031

Murphy Ball End Probe

9" (23 cm)

- | | | | |
|---------|----------|------|----|
| 413-020 | straight | | #1 |
| 413-021 | 65° | 8mm | #2 |
| 413-022 | 80° | 10mm | #3 |
| 413-023 | 75° | 12mm | #4 |
| 413-024 | 80° | 13mm | #5 |



413-020



413-024

**For more probes go to
"Rhoton Jacobson Curette
& Dissector Hook Set"
section**



 Sontec Instruments®

Caspar RETRACTORS & DISTRACTORS

Caspar Cervical Vertebral Retractor Frame

Accommodates all blade types / single articulation / 85 mm maximum spread / 6 1/2" (16.5 cm)

- 416-280 stainless steel
- 416-680 titanium



Caspar Cervical Vertebral Retractor Frame

Accommodates all blade types / double articulation / 125 mm maximum spread / 8" (20 cm)

- 416-260 stainless steel
- 416-660 titanium

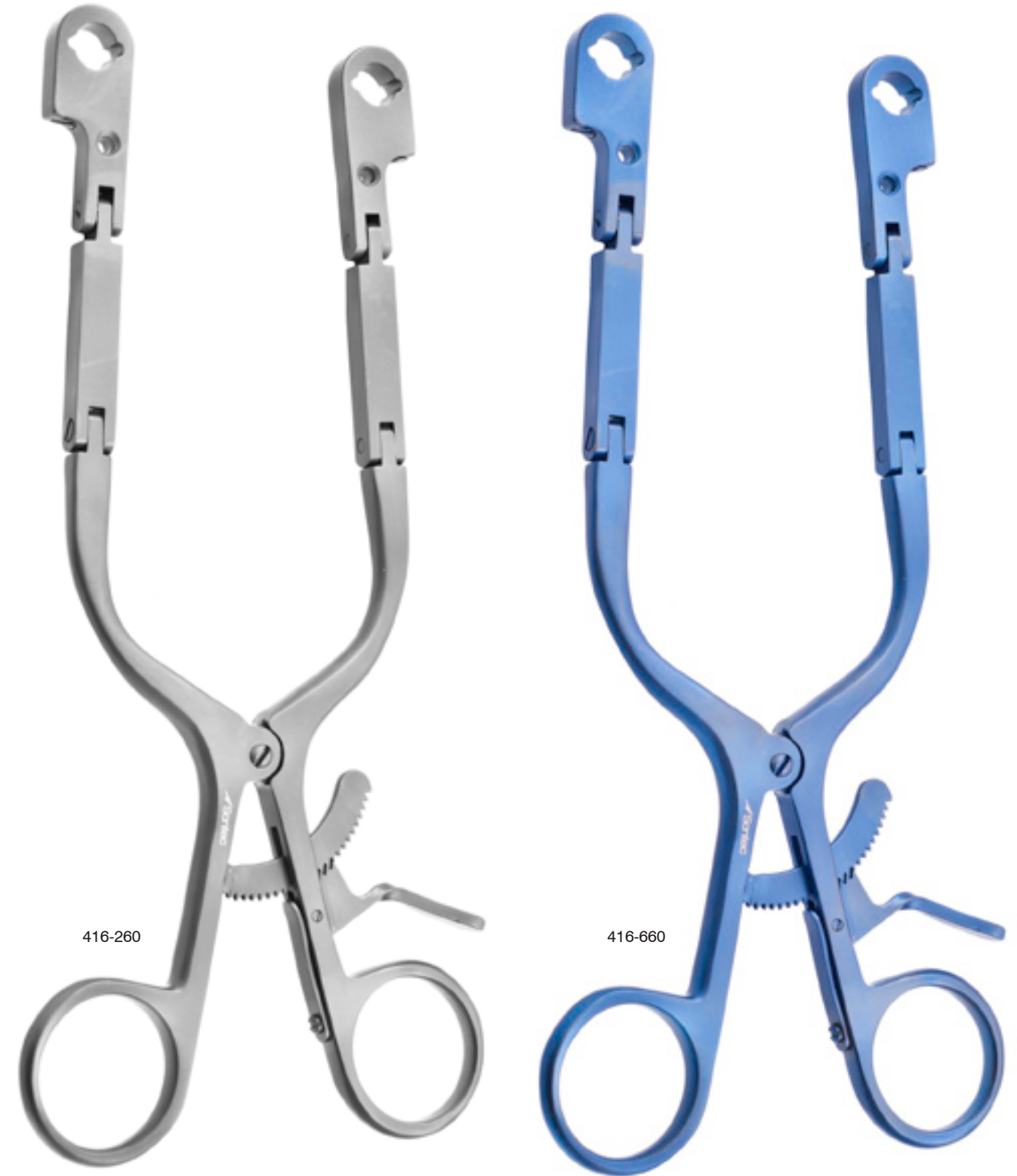

Caspar Cervical Vertebral Retractor Frame

Accommodates all blade types / single articulation / V-handle / 85 mm maximum spread

416-230 4 1/2 (11.5 cm)

Caspar Cervical Vertebral Retractor Frame

For use with the titanium & plastic quick release blades only / double articulation / 100 mm maximum spread

416-250 6 1/4" (16 cm)



Caspar MIS Cervical Vertebral Column Retractor Frame

Accommodates all blade types / double articulation / 90 mm maximum spread

416-200 stainless steel
416-700 titanium

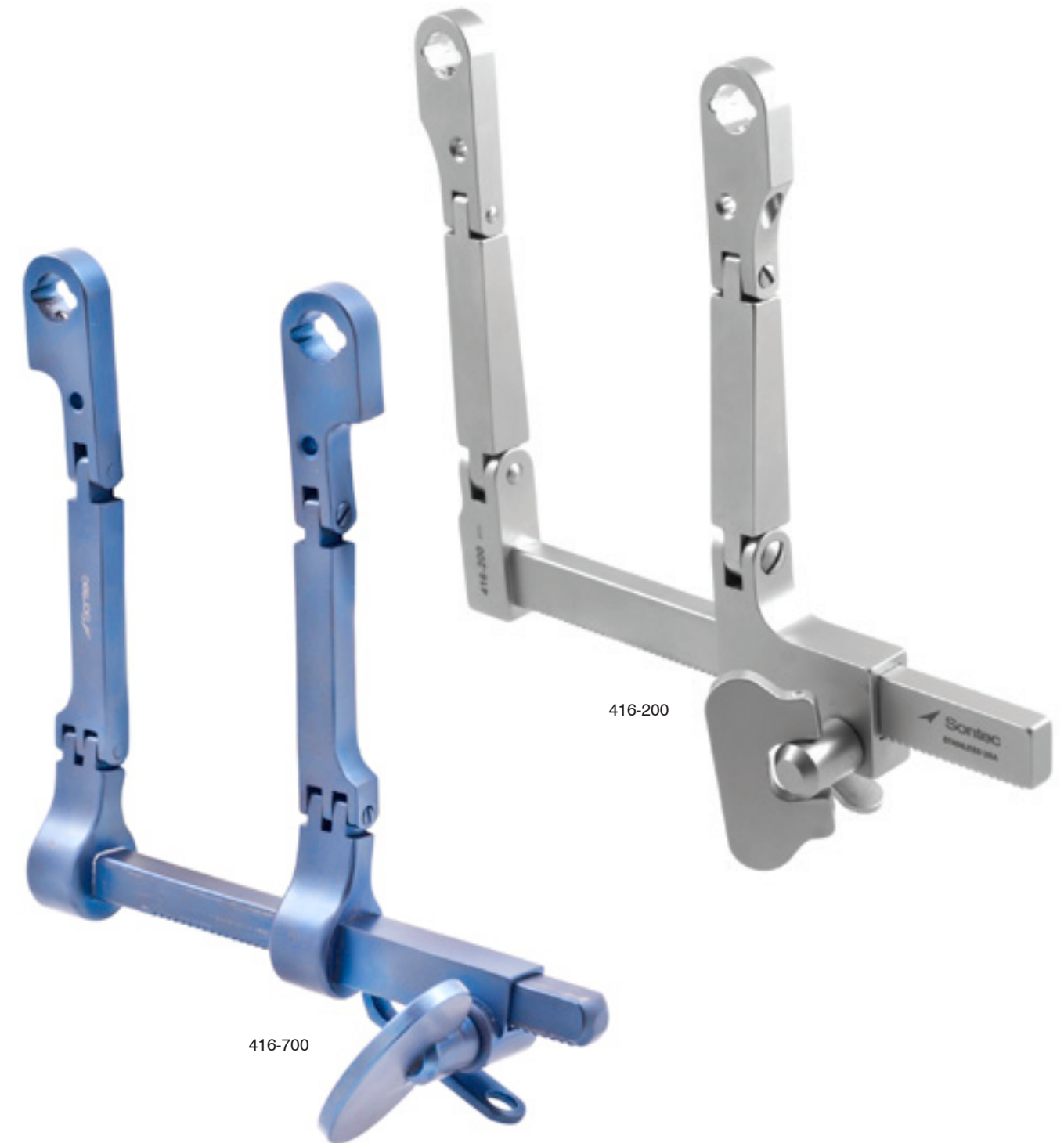

Caspar Cervical Vertebral Column Retractor Frame

Rotatable arms / accommodates all blade types / double articulation / 90 mm maximum spread

416-202 stainless steel



HL MIS Retractor Frame Medium

Accommodates all blade types / double articulation / 200 mm maximum spread

416-201



Caspar V-Blunt Blade

Stainless steel

- 416-450 45 x 20 mm
- 416-452 50 x 20 mm
- 416-454 55 x 20 mm
- 416-456 60 x 20 mm
- 416-458 65 x 20 mm

Plastic / quick release / ultra-transparent to X-ray

- 416-460 45 x 20 mm
- 416-462 50 x 20 mm
- 416-464 55 x 20 mm
- 416-466 60 x 20 mm
- 416-468 65 x 20 mm



Stainless steel



Plastic / quick release

Caspar Serrated Lateral Blade

Stainless steel

- 416-519 40 x 15 mm extra thin
- 416-520 45 x 20 mm
- 416-522 50 x 20 mm
- 416-524 55 x 20 mm
- 416-526 60 x 20 mm
- 416-528 65 x 20 mm

Anodized aluminum

- 416-510 45 x 20 mm
- 416-512 50 x 20 mm
- 416-514 55 x 20 mm
- 416-516 60 x 20 mm
- 416-518 65 x 20 mm

Plastic / quick release

- 416-530 45 x 20 mm
- 416-532 50 x 20 mm
- 416-534 55 x 20 mm
- 416-536 60 x 20 mm
- 416-538 65 x 20 mm

Titanium / quick release / semi-transparent to X-ray

- 416-500 45 x 22 mm
- 416-502 50 x 22 mm
- 416-504 55 x 22 mm
- 416-506 60 x 22 mm
- 416-508 65 x 22 mm



Titanium / quick release



Plastic / quick release



stainless steel

Caspar Blunt Smooth Blade

Anodized aluminum

- 416-560 45 x 20 mm
- 416-562 50 x 20 mm
- 416-564 55 x 20 mm
- 416-566 60 x 20 mm
- 416-568 65 x 20 mm

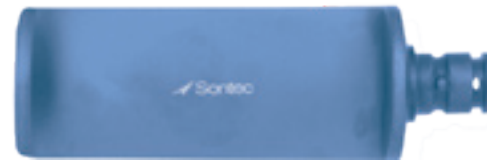

Anodized titanium

Titanium / quick release / semi-transparent to X-ray

- 416-550 45 x 23 mm
- 416-552 50 x 23 mm
- 416-554 55 x 23 mm
- 416-556 60 x 23 mm
- 416-558 65 x 23 mm
- 416-559 75 x 23 mm

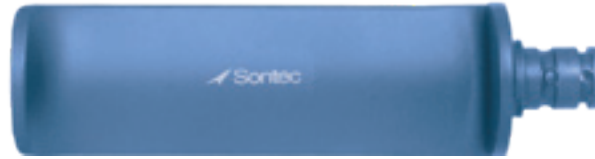

Titanium / quick release

Medial Blade

Stainless steel

- 416-400 45 x 20 mm
- 416-402 50 x 20 mm
- 416-404 55 x 20 mm
- 416-406 60 x 20 mm
- 416-408 65 x 20 mm



Aluminum

Anodized aluminum / special order only

- 416-410 45 x 20 mm
- 416-412 50 x 20 mm
- 416-414 55 x 20 mm
- 416-416 60 x 20 mm
- 416-418 65 x 20 mm



416-542

Plastic / quick release / ultra-transparent to X-ray

- 416-420 45 x 20 mm
- 416-422 50 x 20 mm
- 416-424 55 x 20 mm
- 416-426 60 x 20 mm
- 416-428 65 x 20 mm

Titanium / quick release

- 416-541 45 x 20 mm
- 416-542 50 x 20 mm
- 416-543 55 x 20 mm
- 416-544 60 x 20 mm
- 416-545 65 x 20 mm

Caspar Blade Removal Forceps

For changing blades

- 416-298 straight
- 416-299 angled



416-298



416-299

Caspar Hand Universal Retractor

For use with the quick release blades only / with depth gauge / screw on blade lock (more secure hold)

- 416-220 8" (20 cm)



416-220

For use with the quick release blades only / black handle

- 416-220L snap lock 8" (20 cm)
- 416-220B screw on blade lock 7 1/4" (18.4 cm)



416-220B



416-220L

Caspar Cervical Vertebral Column Quick Release Retractor Frame

Accommodates SL-Connect blades / double articulation / 90 mm maximum spread / quick release

- 416-650
- 416-655 trans-verse/stepdown

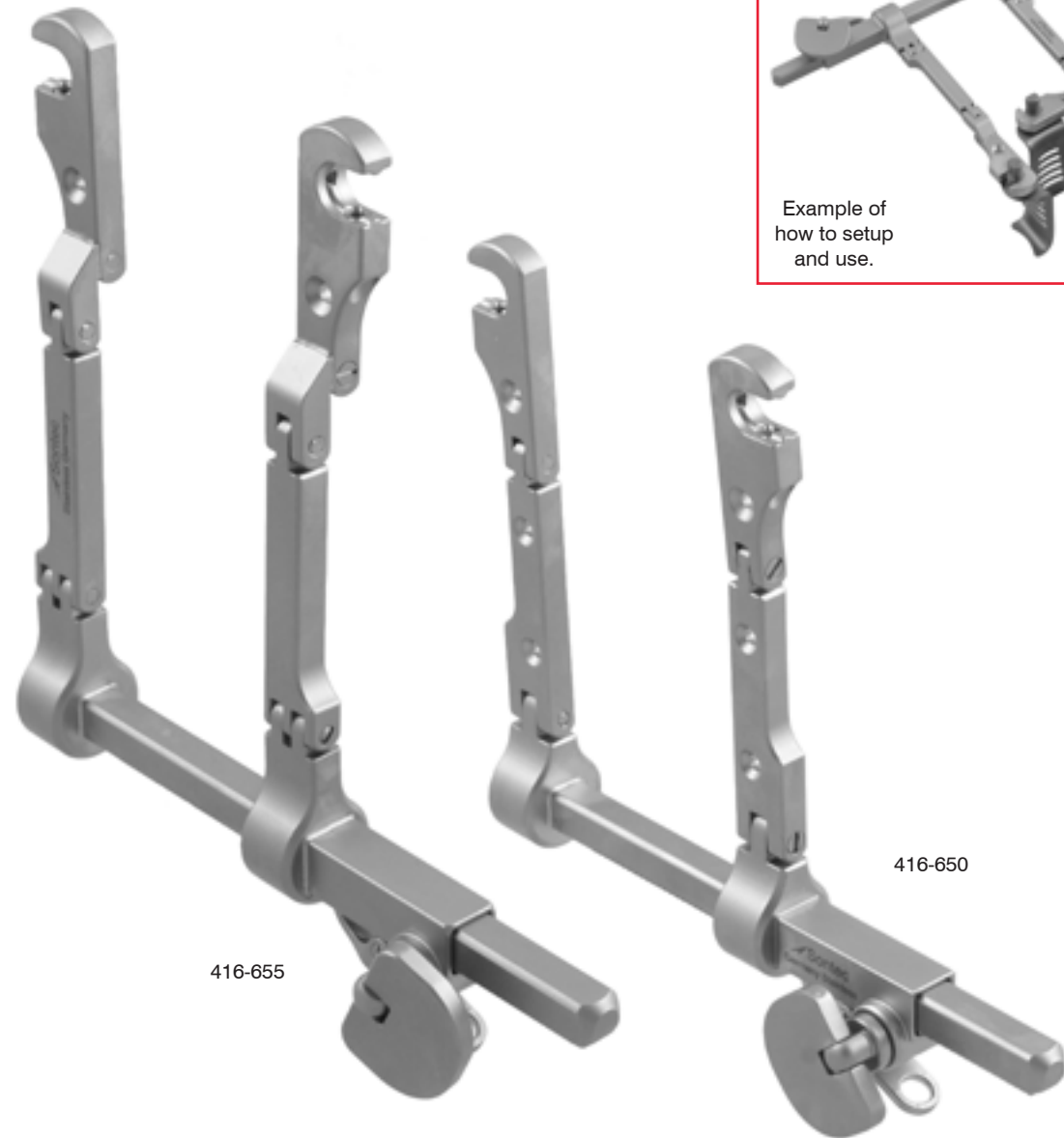
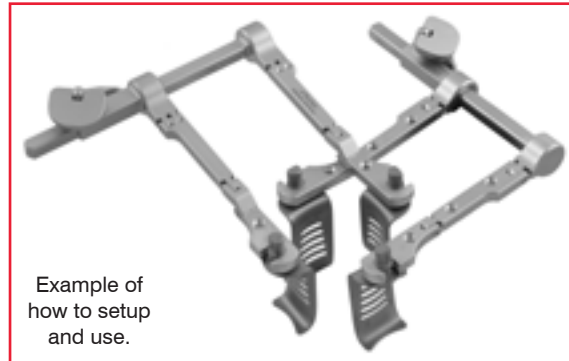

SL - Connect Blade Insert Instrument

7 1/4" (18m mm)

416-225



SL - Connect Lateral Blade Titanium

Quick release

- 416-580 24 x 45
- 416-582 24 x 50
- 416-584 24 x 55



SL - Connect Blunt Blade Titanium

Quick release

- 416-586 24 x 45
- 416-588 24 x 50
- 416-590 24 x 55



Caspar Distractor Vertebral Retractor

416-300 right
416-305 left

| A | B |
|-------|-------|
| 70 mm | 93 mm |

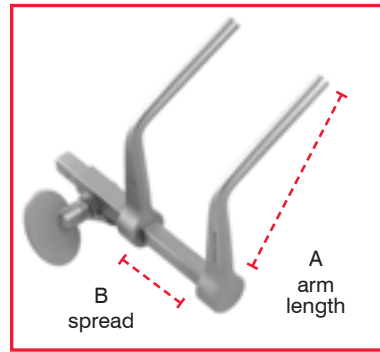

416-305



416-300

Caspar Drill Guide

Works inconjunction with distractors pictured on previous page. Screw mechanism slides over distractor bar for drill guide.

416-340 right
416-342 left



416-340

right



left

416-342



right

left

Caspar Twist Drill

416-335 1.7 mm Ø



Caspar Screw Post

For Distractor

416-312 12 mm
416-314 14 mm
416-316 16 mm



416-314



416-316

Caspar Screwdriver

For Distractor / also available in phenolic plastic handle / 7 3/4"

416-330



Caspar Lumbar Speculum

Non-reflective / anodized surface / 18 mm wide

416-820 40 mm in length
416-821 45 mm in length
416-822 50 mm in length
416-823 55 mm in length
416-824 60 mm in length
416-825 65 mm in length
416-826 75 mm in length
416-827 85 mm in length

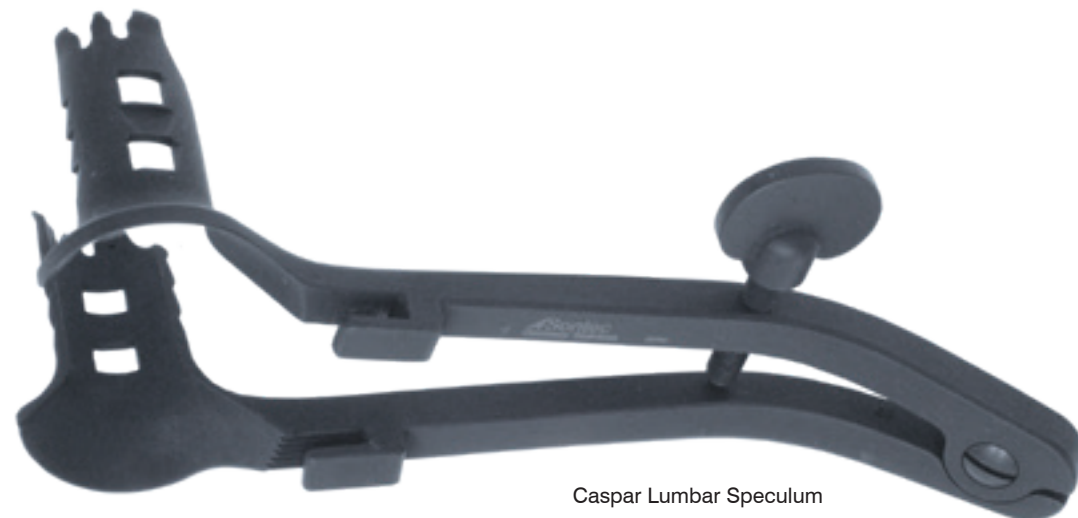

Caspar Lumbar Speculum

Caspar Counter Retractor

For Caspar Speculum / 60 mm maximum spread

416-800 complete with 5 blades
416-801 retractor only

Caspar Serrated Lateral Blade

For Counter Retractor

416-802 35 mm
416-803 40 mm
416-804 45 mm
416-805 50 mm
416-806 55 mm
416-807 60 mm
416-808 65 mm
416-809 75 mm
416-810 85 mm

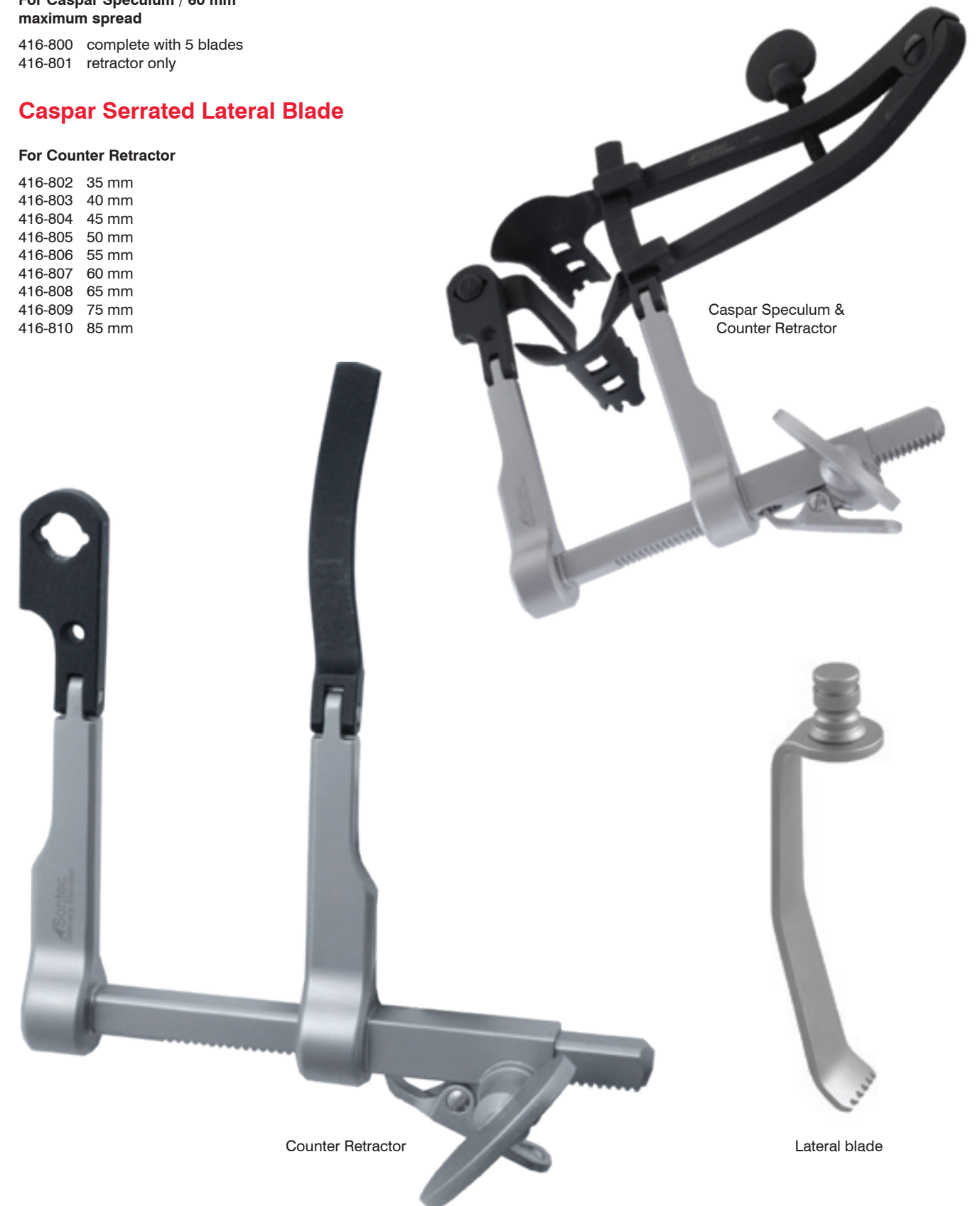

Caspar Speculum & Counter Retractor

Counter Retractor

Lateral blade

Scoville Retractor Frame

lumbar retractor system / accommodates
all blade types / double articulation / 8
1/4" long with 6 1/2" arms

417-098

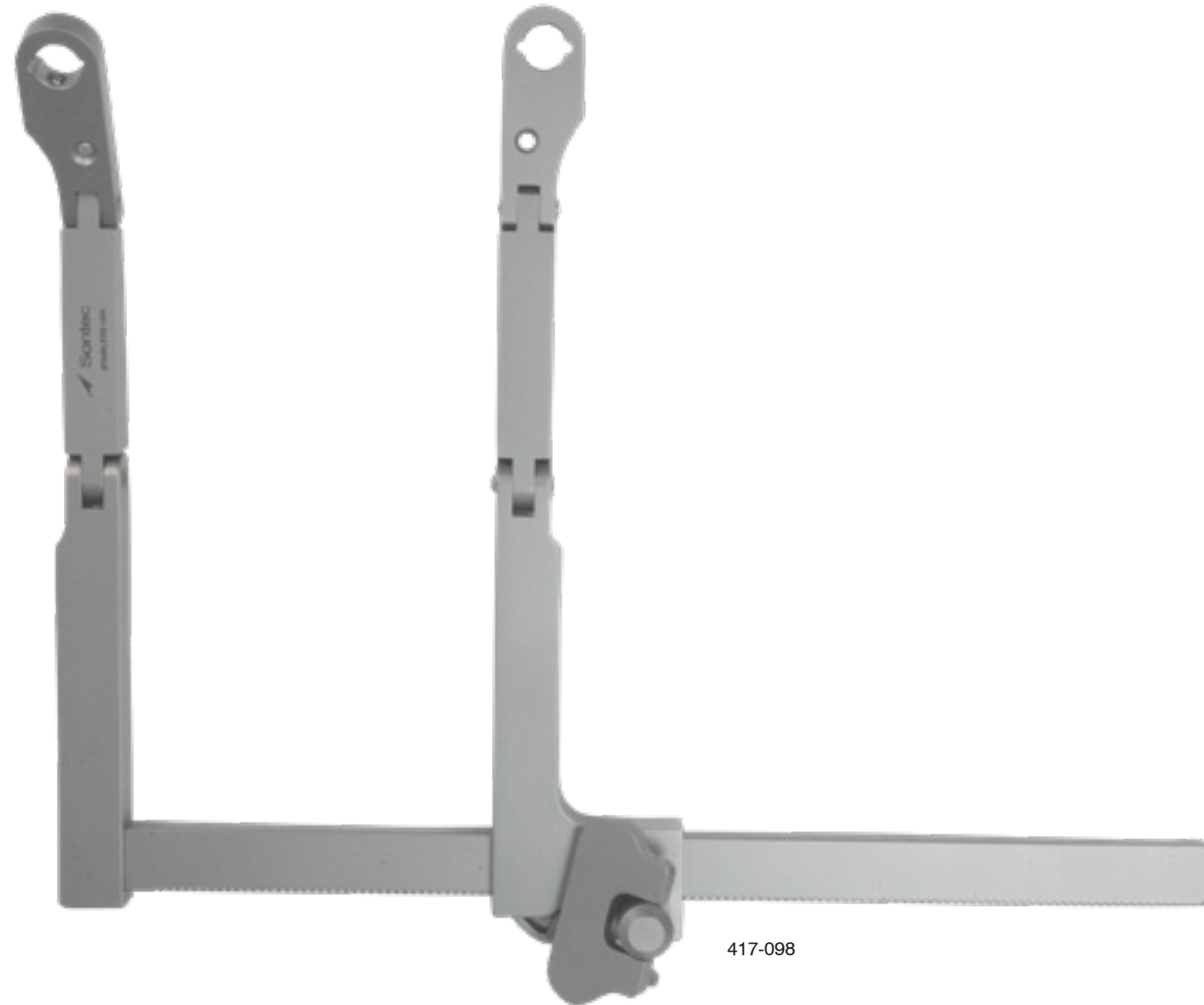

Scoville Lumbar Blade

23 mm wide

| | |
|----------|-------------|
| 417-0030 | 23 x 35 mm |
| 417-0031 | 23 x 45 mm |
| 417-0032 | 23 x 55 mm |
| 417-0033 | 23 x 65 mm |
| 417-0034 | 23 x 75 mm |
| 417-0035 | 23 x 85 mm |
| 417-0036 | 23 x 100 mm |
| 417-0037 | 23 x 120 mm |

45 mm wide

| | |
|----------|------------|
| 417-0050 | 45 x 50 mm |
| 417-0051 | 45 x 60 mm |
| 417-0052 | 45 x 70 mm |
| 417-0053 | 45 x 80 mm |

60 mm wide

| | |
|----------|-------------|
| 417-0060 | 60 x 50 mm |
| 417-0061 | 60 x 60 mm |
| 417-0062 | 60 x 70 mm |
| 417-0063 | 60 x 80 mm |
| 417-0064 | 60 x 100 mm |
| 417-0065 | 60 x 120 mm |



Scoville Middle Lumbar Blade

15 degrees

| | |
|----------|-------|
| 417-0135 | 35 mm |
| 417-0136 | 40 mm |
| 417-0137 | 45 mm |
| 417-0138 | 50 mm |
| 417-0139 | 55 mm |
| 417-0140 | 60 mm |
| 417-0141 | 65 mm |
| 417-0142 | 70 mm |
| 417-0143 | 75 mm |
| 417-0144 | 80 mm |



Micro Lamina Spreader

With speed lock / many tip widths available / 5 3/4" (14.5 cm)

417-058

With speed lock / deep angle / 6 3/4" (17.1 cm)

417-058D

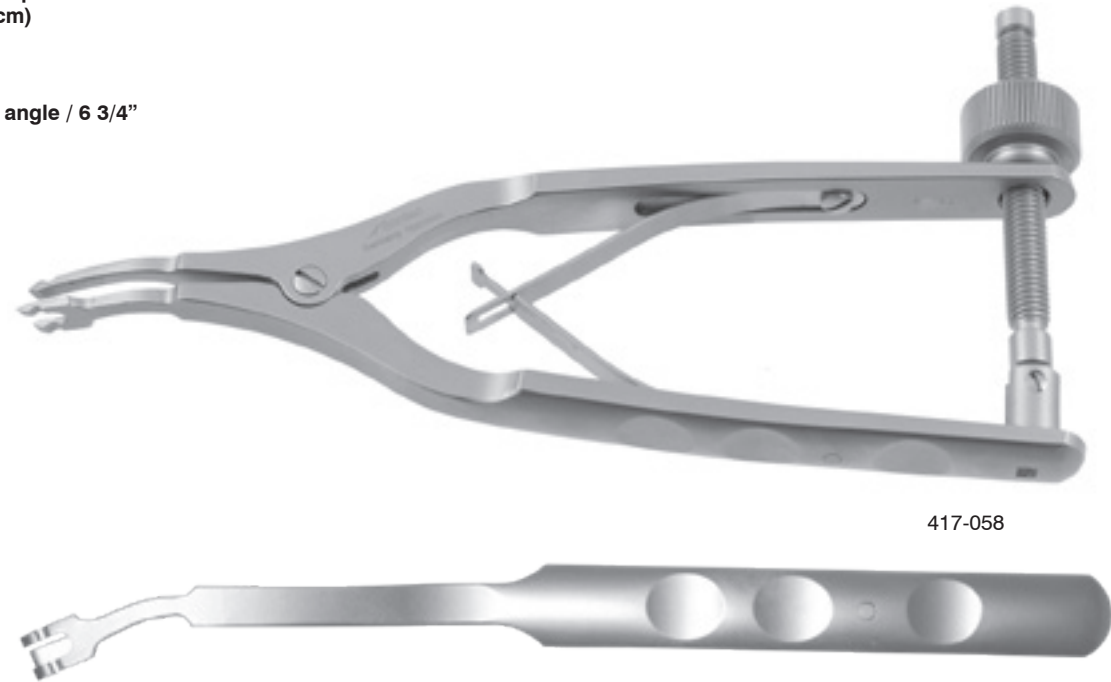

417-058



417-058D

Caspar Nerve-Root Retractor

For micro lumbar dissection

416-844 4 mm

416-846 6 mm

416-848 8 mm

416-850 10 mm

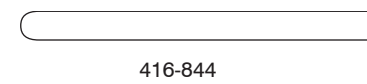

416-844



416-848

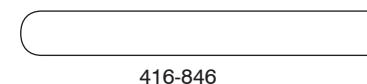

416-846

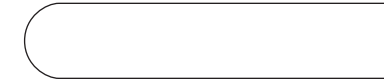

416-850

Cloward Cervical Retractor

64 mm maximum spread

- 416-130 complete, with 5 toothed blades
- 416-131 frame only

Blunt Blade

For Cloward Cervical Retractor

- 416-132 40 mm x 15/23 mm
- 416-133 45 mm x 15/23 mm
- 416-134 50 mm x 15/23 mm
- 416-135 55 mm x 15/23 mm
- 416-136 60 mm x 15/23 mm

Round Blade

For Cloward Cervical Retractor

- 416-138 55 mm x 20 mm
- 416-139 60 mm x 20 mm
- 416-140 65 mm x 25 mm
- 416-141 70 mm x 25 mm

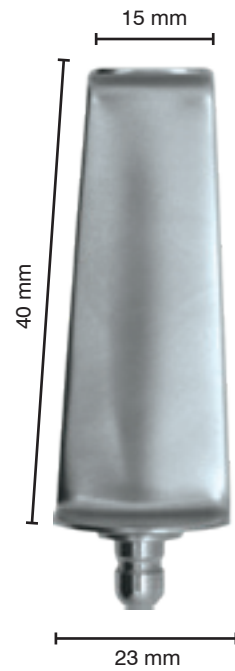

Cloward Cervical Retractor

114 mm maximum spread

- 416-100 complete, with 5 toothed blades
- 416-101 frame only

Toothed Blade

For Cloward Cervical Retractor

- 416-102 40 mm x 15/23 mm
- 416-103 45 mm x 15/23 mm
- 416-104 50 mm x 15/23 mm
- 416-105 55 mm x 15/23 mm
- 416-106 60 mm x 15/23 mm

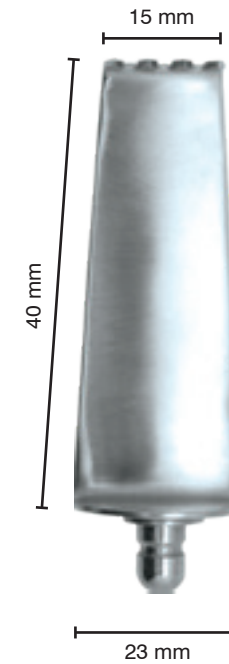

McCullough Retractor Set

64 mm maximum spread

416-150 extended rack 8"

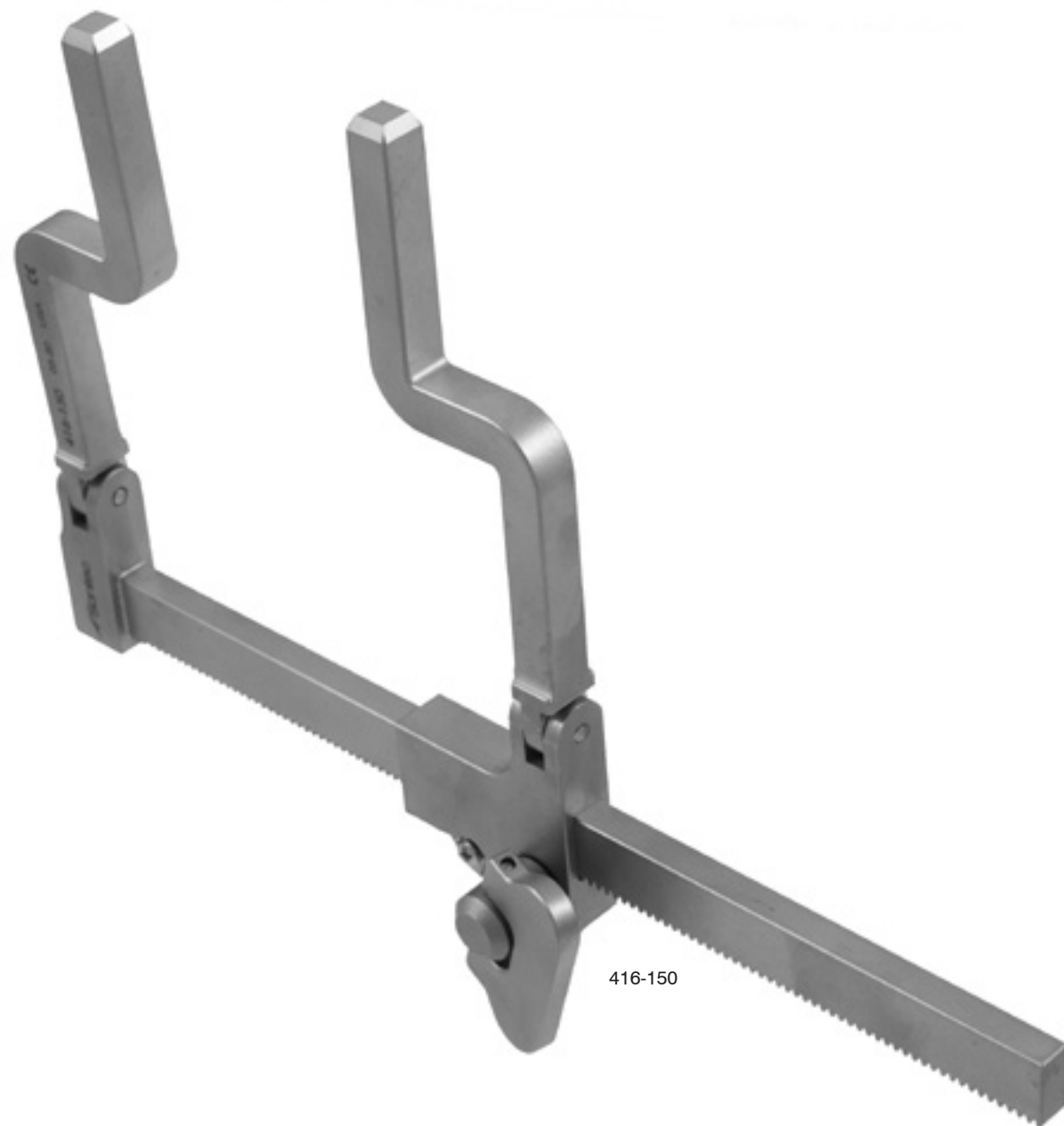

416-150

McCullough Retractor Set

64 mm maximum spread

- 416-150 extended rack 8"
- 416-152 black narrow muscle blade 2 cm x 9 cm
- 416-153 black narrow muscle blade 2 cm x 10 cm
- 416-154 black narrow muscle blade 2 cm x 11 cm
- 416-157 black wide muscle blade 2.7 cm x 9 cm
- 416-158 black wide muscle blade 2.7 cm x 10 cm
- 416-159 black wide muscle blade 2.7 cm x 11 cm
- 416-161 black hook blade 7 cm
- 416-162 black hook blade 8 cm
- 416-163 black hook blade 9 cm



416-152

416-153

416-154

416-157

416-159

416-161

416-163

Neuro Caliper

8 3/4" (22 cm)
355-250



Caspar System Complete Set

1103-729 tray
416-199 set Call for individual & set pricing

Set includes:

- 416-200 caspar cervical vertebral column retractor frame
- 416-220 caspar hand retractor with depth gauge 8"
- OR**
- 416-220B caspar hand retractor with screw on blade 7 1/4"
- 416-230 caspar cervical vertebral retractor "v-shape 4 1/2"
- 416-260 caspar cervical vertebral retractor 8" double articulating
- 416-280 caspar cervical vertebral retractor 6 1/2" single
- 416-299 caspar forceps for changing blades
- 416-300 caspar distractor right
- 416-305 caspar distractor left
- 416-314 screw post for distractor 14 mm
- 416-330 caspar screwdriver universal
- 416-335 caspar twist drill 1.7mm
- 416-340 drill guide 65 degree angle right phenolic handle
- 416-342 drill guide 65 degree angle left phenolic handle
- 417-058D micro lamina spreader deep angle with speed lock 6 3/4"
- assorted blades (10 sets) different sizes
- tray

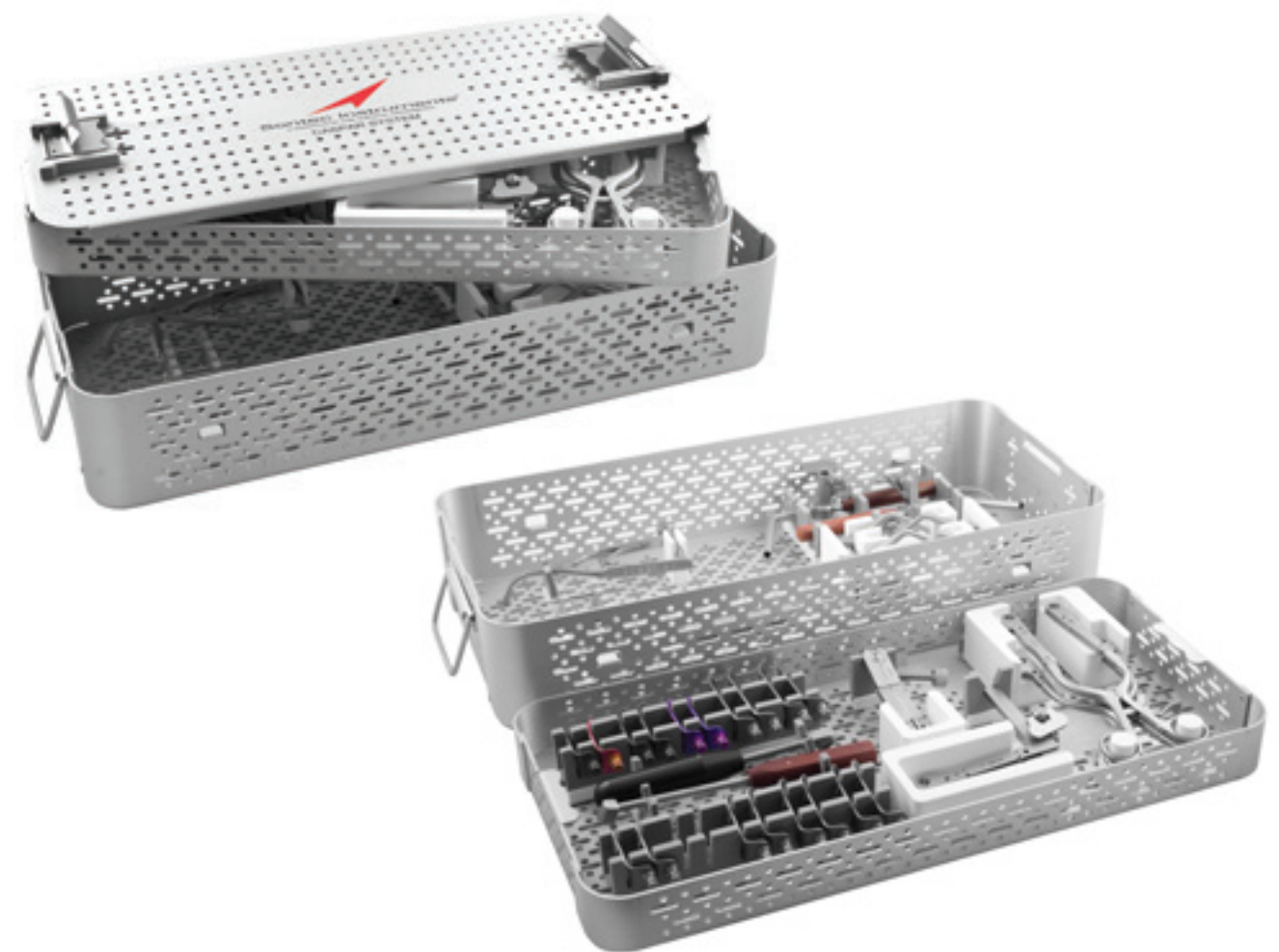



 Sontec Instruments®

Brain SPATULAS

Abdominal Spatula

Malleable

| | | |
|---------|----------------------------------|----------|
| 20-0847 | 6 3/4" long x 5/8" wide | |
| 20-0848 | 7 1/2" long x 1" wide | |
| 20-0871 | 11" long x 1 1/2" to 2 1/2" wide | Reverdin |
| 20-0874 | 8" long x 3/4" to 1" wide | Tuffier |
| 20-0873 | 12" x 40 mm/50 mm | Haberer |

20-0847



20-0873



Haberer



Tuffier

20-0874

CSU Kloop Neuro Spatula

6 1/2" (16.5 cm)

412-472



412-472

Cushing Brain Depressor Spatula

Double-ended

412-787 6 3/4" (17.1 cm)

412-789 7 3/4" (19.7 cm)



412-787



412-789

Sontec Brain Spatula

Tapered / malleable / 7" (18 cm)

- 412-779 2 mm
- 412-781 4 mm
- 412-783 6 mm



412-779



412-781



412-783

Davis Brain Spatula

Malleable / 7" (18 cm)

- 412-770 1/4"
- 412-771 3/8"
- 412-772 1/2"
- 412-773 5/8"
- 412-774 3/4"
- 412-775 1"
- 412-776 1 1/4"
- 412-777 1 1/2"



412-770



412-771



412-772



412-773



412-774



412-775

Davis Brain Black Silicone Spatula

Silicone coated / malleable / 7" (18 cm)

- 412-766 small 6 mm & 10 mm
- 412-767 medium 9 mm & 15 mm
- 412-768 large 11 mm & 20 mm
- 412-769 x-large 14 mm & 25 mm



412-766



412-767



412-768



412-769

Davis Brain Spatula

Blue coated / malleable / round end

- 412-794 2 mm 6" (15 cm)
- 412-796 4 mm 6" (15 cm)
- 412-798 6 mm 6" (15 cm)
- 412-795 2 mm 7" (18 cm)
- 412-797 4 mm 7" (18 cm)
- 412-799 6 mm 7" (18 cm)



412-794



412-797



412-799

Blue coated / malleable / 6" (15 cm)

- 412-790 3 prongs 3 mm
- 412-792 4 prongs 6 mm



412-790

Blue coated / malleable / 7" (18 cm)

- 412-791 3 prongs 3 mm
- 412-793 4 prongs 6 mm



 Sontec Instruments®

Nerve RETRACTORS

Love Nerve Root Retractor

Ergonomic ring handle / 90 degree / double loop curved blade 5x40 mm

412-605 7" (17.8 cm)

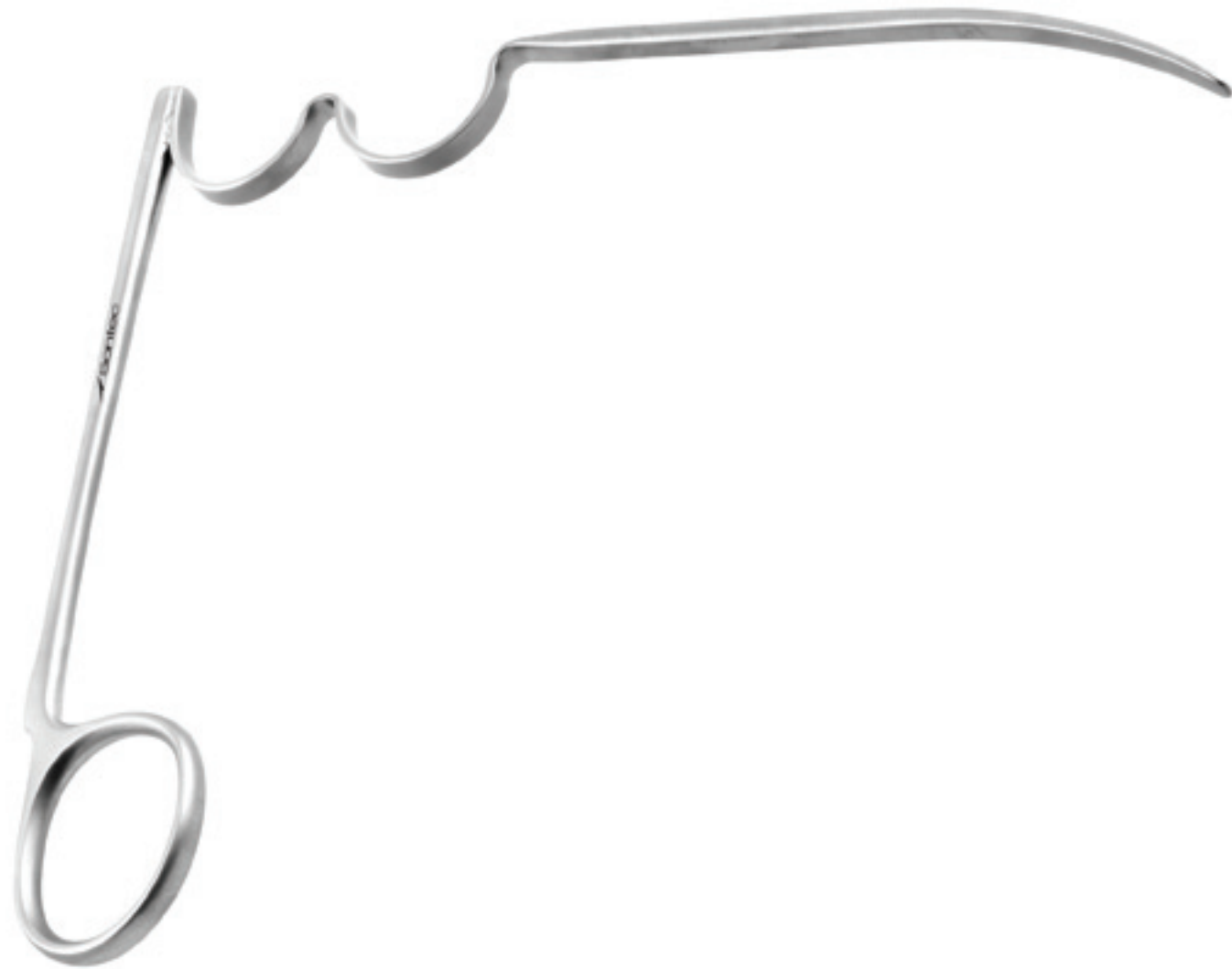

Sontec-Love Nerve Root Retractor

Knurled round handle

412-607 str 9.25" (23.5 cm)

412-608 45°

412-609 90°



Love Nerve Root Retractor

Classic model / flat handle

- 412-610 str
- 412-612 45°
- 412-614 90°



412-610

412-612

412-614

Suction Nerve Retractor

5" working length

- 412-721 4/2 mm 10 3/4" (27 cm)
- 412-722 7/3 mm 10 3/4" (27 cm)



412-721

412-722

Suction Nerve Retractor

7 french / 8" (20.3 cm)

- 412-7256 6 mm
- 412-7257 7 mm
- 412-7258 8 mm



412-7257

Lighted Smith Nerve Retractor

7/16 mm / 5" working length / 10 3/4" (27.3 cm)
412-723



412-723

Wide Scoville Nerve Root Retractor

Phenolic handle / 9" (23cm)
412-645A 10 mm
412-645B 12 mm
412-645C 14 mm

12 mm & 14mm have limited availability

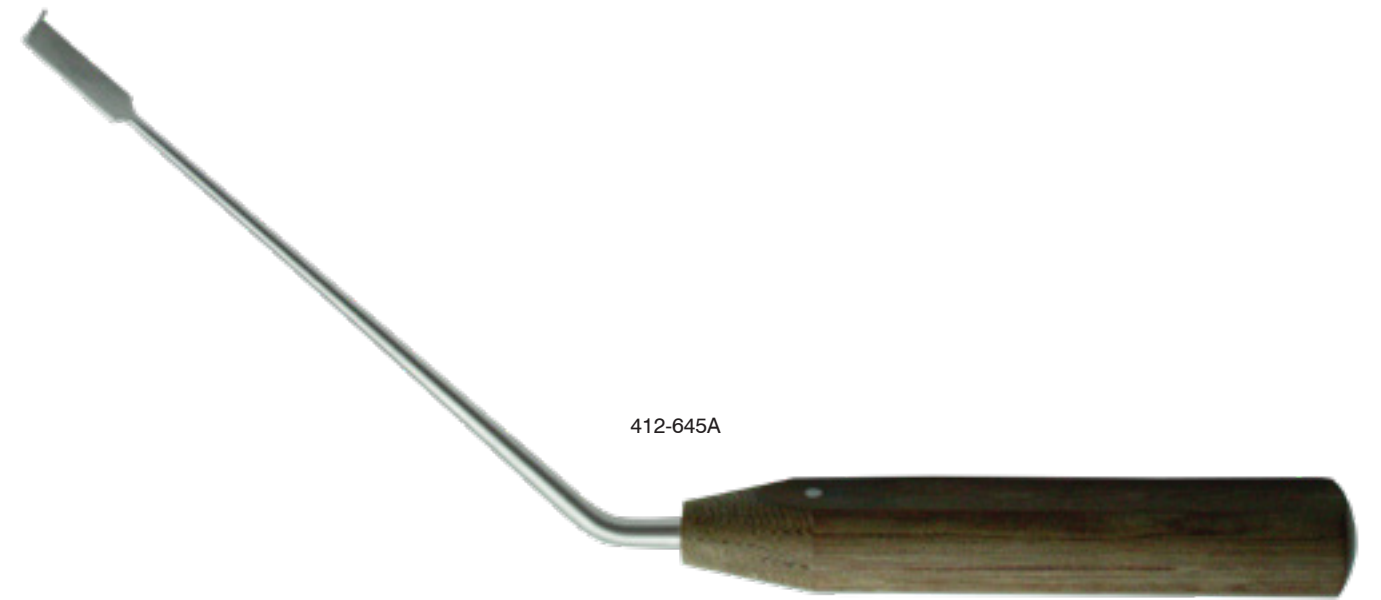

412-645A

Hess Nerve Retractor

- 412-620 45° 3mm
- 412-621 90° 3mm
- 412-622 45° 5mm
- 412-623 90° 5mm

Long shaft

- 412-624A 45° 3mm
- 412-624B 90° 3mm
- 412-625A 45° 5mm
- 412-625B 90° 5mm

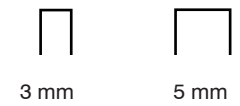

Scoville Nerve Root Retractor

5" from bend / 10.5" (27 cm) / 8 mm

- 412-643A straight
- 412-643B 45°
- 412-643C 90°
- 412-643D bayonet

* 3 & 5 available on request

7" from bend / 8 mm longer / 9" (23 cm)

- 412-644A 45°
- 412-644B 90°
- 412-644C full curved

* 3 & 5 available on request





 Sontec Instruments®

Rhoton Jacobson Curette & Dissector Hook Set

Rhoton Circular Dissector 45°

Stainless steel / 7 1/2" (19 cm)

| | | |
|----------|------|-----------------|
| 413-001S | 1 mm | stainless steel |
| 413-001 | 1 mm | titanium |
| 413-002S | 2 mm | stainless steel |
| 413-002 | 2 mm | titanium |
| 413-003S | 3 mm | stainless steel |
| 413-003 | 3 mm | titanium |

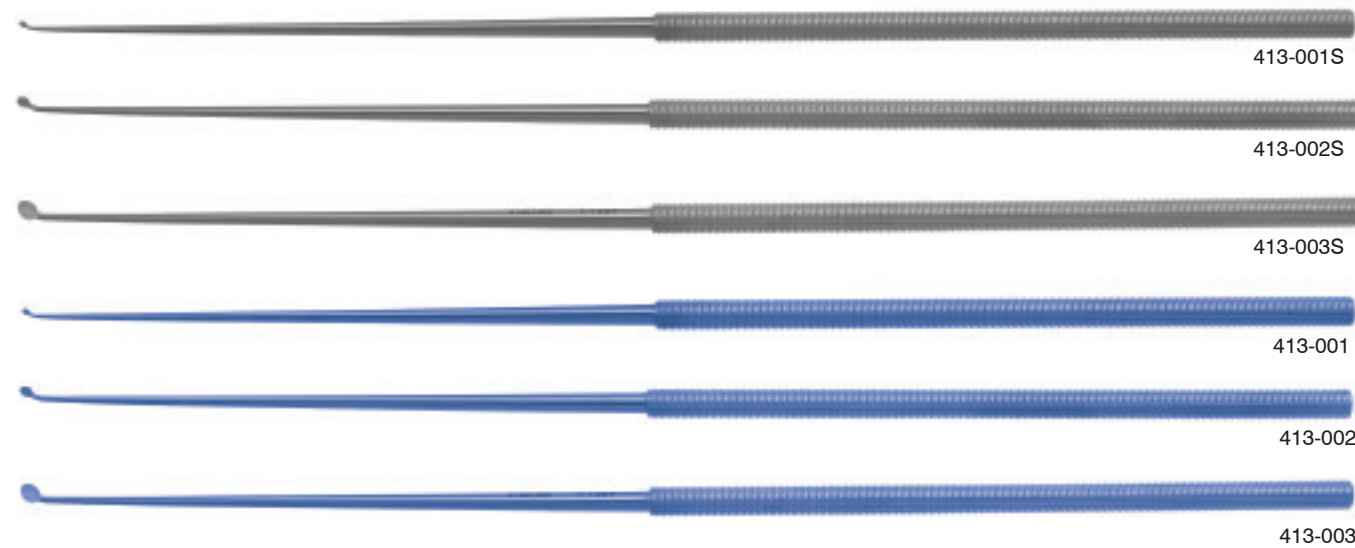

Rhoton Dissector / Raspatory

7 1/2" (19 cm)

| | | | |
|----------|--------|--------|-----------------|
| 413-004S | 2.8 mm | curved | stainless steel |
| 413-004 | 2.8 mm | curved | titanium |
| 413-005S | 1 mm | angled | stainless steel |
| 413-005 | 1 mm | angled | titanium |



Jacobson Hook

Sharp / 2 mm / 90° / 7 1/2" (19 cm)

| | |
|----------|-----------------|
| 413-006S | stainless steel |
| 413-006 | titanium |



Rhoton Dissector / Raspatory

Semi-sharp / 25° / 7 1/2" (19 cm)

| | | |
|----------|--------|-----------------|
| 413-007S | 1.5 mm | stainless steel |
| 413-007 | 1.5 mm | titanium |
| 413-008S | 2 mm | stainless steel |
| 413-008 | 2 mm | titanium |
| 413-009S | 1 mm | stainless steel |
| 413-009 | 1 mm | titanium |

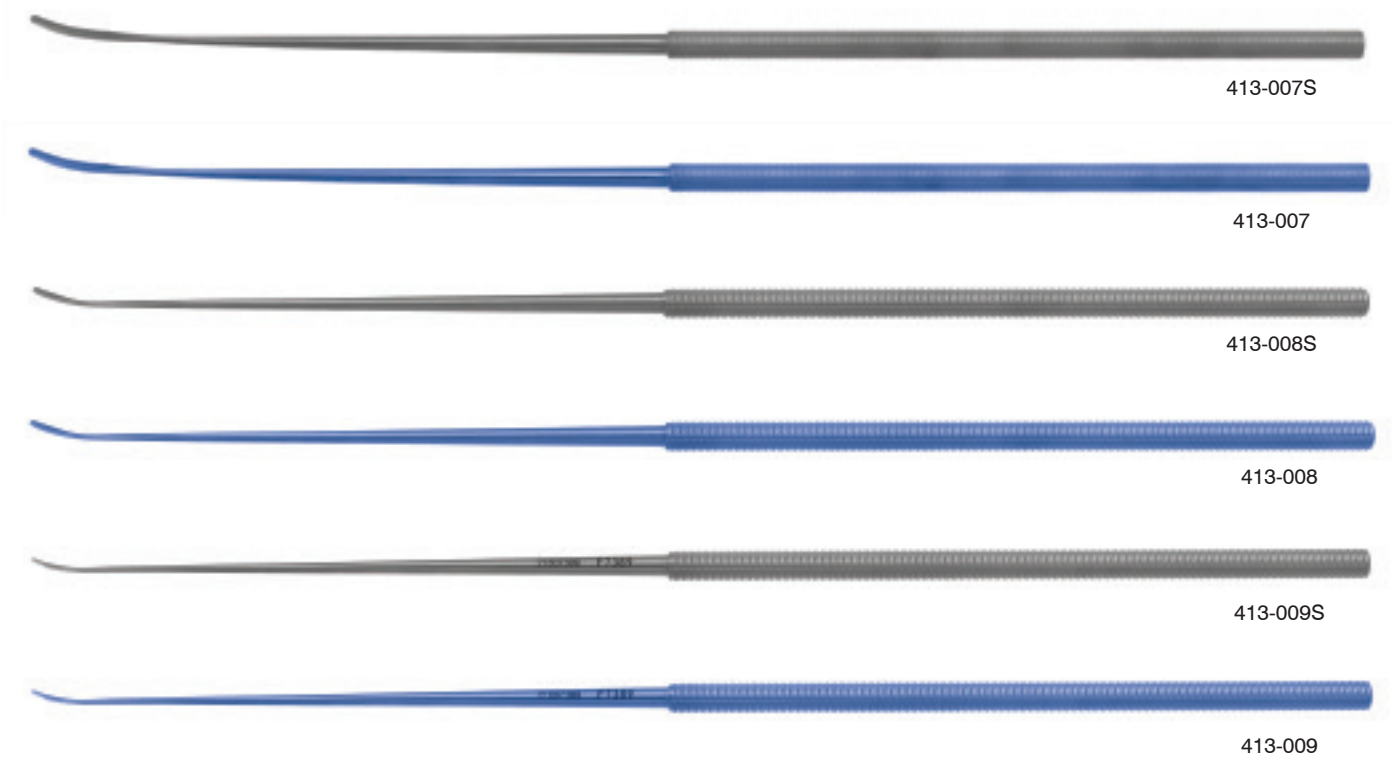

Rhoton Hook

7 1/2" (19 cm)

| | | | | |
|----------|-----|------|------------|-----------------|
| 413-010S | 90° | 2 mm | blunt | stainless steel |
| 413-010 | 90° | 2 mm | blunt | titanium |
| 413-011S | 45° | 3 mm | semi sharp | stainless steel |
| 413-011 | 45° | 3 mm | semi sharp | titanium |



Rhoton Pick

Semi Sharp / straight / 7 1/2" (19 cm)

| | |
|----------|-----------------|
| 413-012S | stainless steel |
| 413-012 | titanium |



Rhoton Curette

1 x 2 mm / 7 1/2" (19 cm)

| | | |
|----------|------------|-----------------|
| 413-013S | straight | stainless steel |
| 413-013 | straight | titanium |
| 413-014S | 45° angled | stainless steel |
| 413-014 | 45° angled | titanium |



Jacobson Button End Probe

Straight / blunt / 1 mm / 7 1/2" (19 cm)

| | |
|----------|-----------------|
| 413-015S | stainless steel |
| 413-015 | titanium |



Jacobson Hook Probe

Angled 45° / 1x8 mm long / 7 1/2" (19 cm)

| | |
|----------|-----------------|
| 413-019S | stainless steel |
| 413-019 | titanium |



Jacobson Button End Hook Probe

Angled 90° / 1 x 3.5 mm / 7 1/2" (19 cm)

| | |
|----------|-----------------|
| 413-016S | stainless steel |
| 413-016 | titanium |



Jacobson Hook Probe

Blunt / Angled 90° / 1x5 mm long / 7 1/2" (19 cm)

| | |
|----------|-----------------|
| 413-017S | stainless steel |
| 413-017 | titanium |

Blunt / Angled 45° / 1x5 mm long / 7 1/2" (19 cm)

| | |
|----------|-----------------|
| 413-018S | stainless steel |
| 413-018 | titanium |





 Sontec Instruments®

Spinal RASPS

Long Handle File

Black plastic handle /
square file / 18" (45.7 cm)

320-591 straight
320-592 15° angle

Black plastic handle / round
file / straight / 18" (45.7 cm)

320-593



320-591



320-593



320-592

JPS Bone File

8 3/4" (22.2 cm)

345-217



back



front

345-217



 Sontec Instruments®

Spinal RETRACTORS

Gelpi Original Spinal Retractor

Deep angle / parallel tips / multilevel distraction
230-405

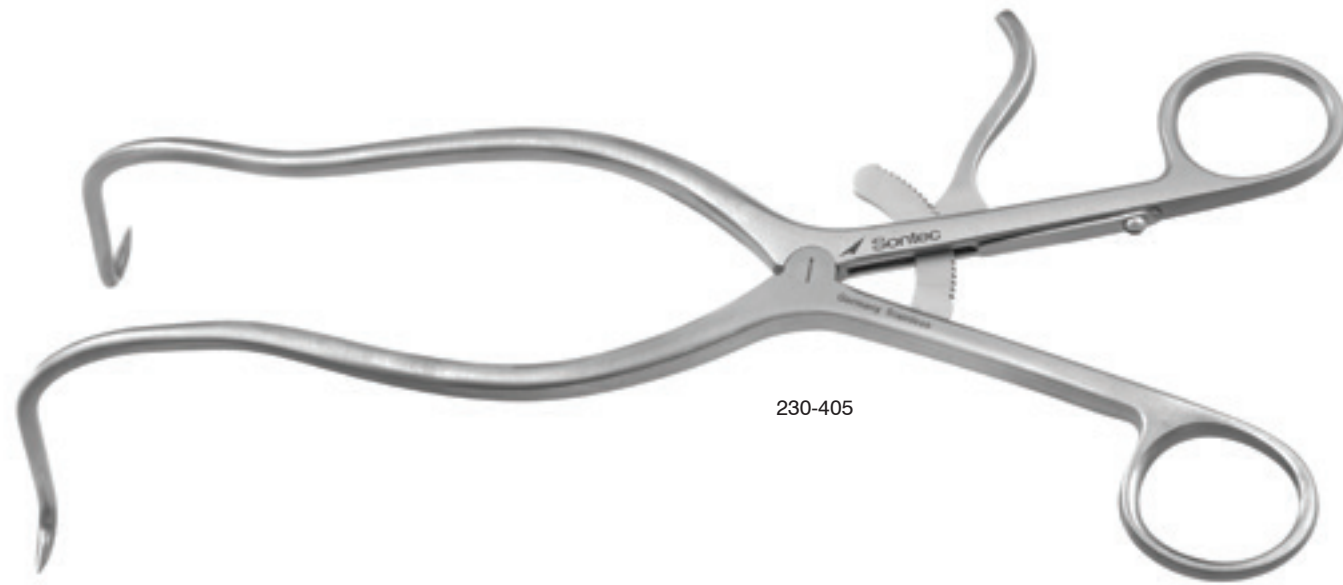

230-405

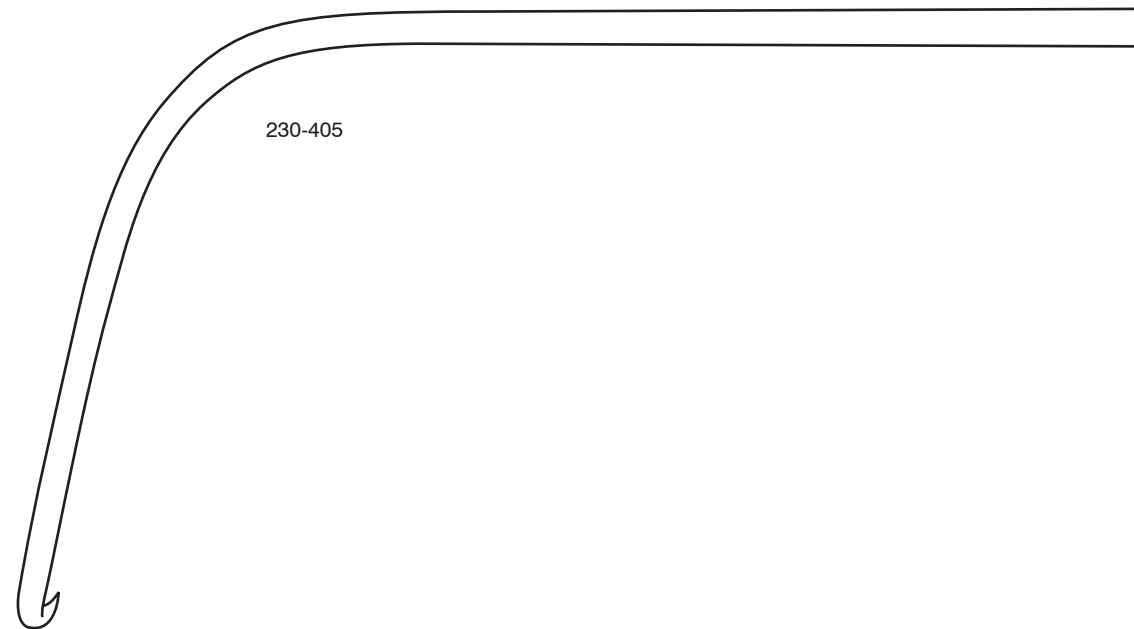

230-405

Gelpi Retractor Titanium

Parallel tips / multilevel distraction /
9.5" (24 cm)
230-406T deep angle
230-406N neroma

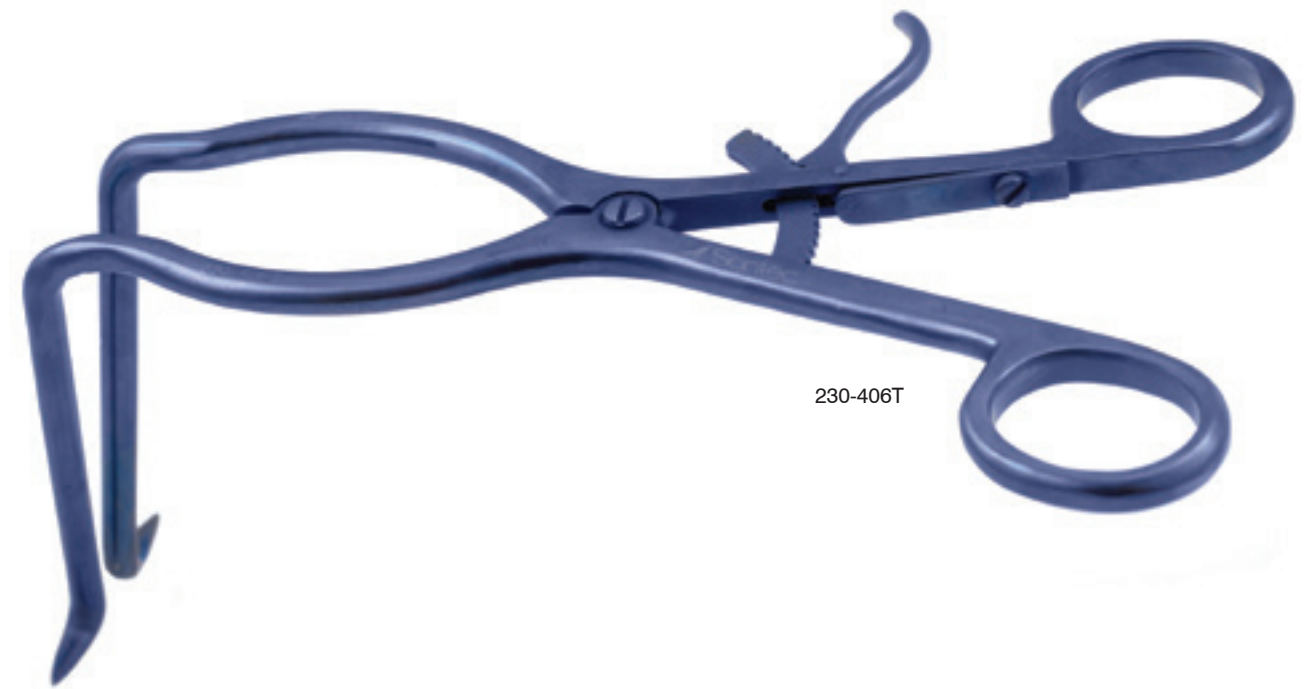

230-406T

Gelpi Spinal Retractor

Deep angle / double prongs / with
ratchet / 13" (33 cm)
417-088

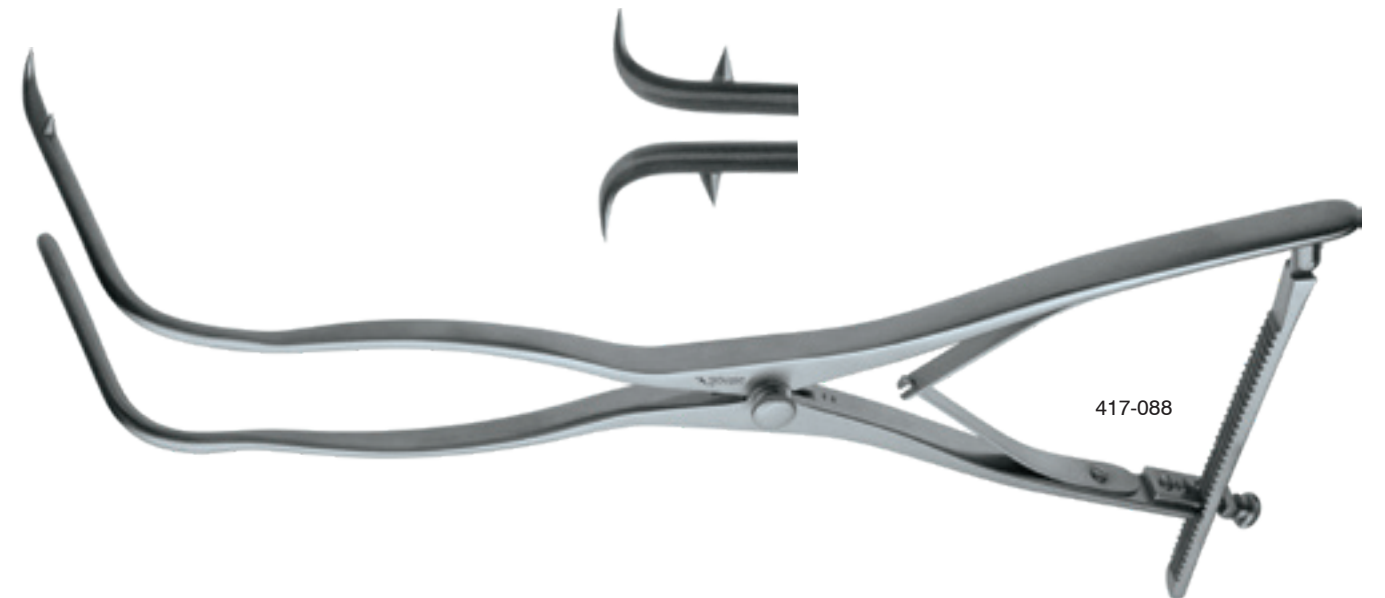

417-088

Gelpi Spinal Retractor

90° angle / with speed lock

- 230-371 1.5" / 11.5"
- 230-372 2" / 12"
- 230-373 3" / 13"

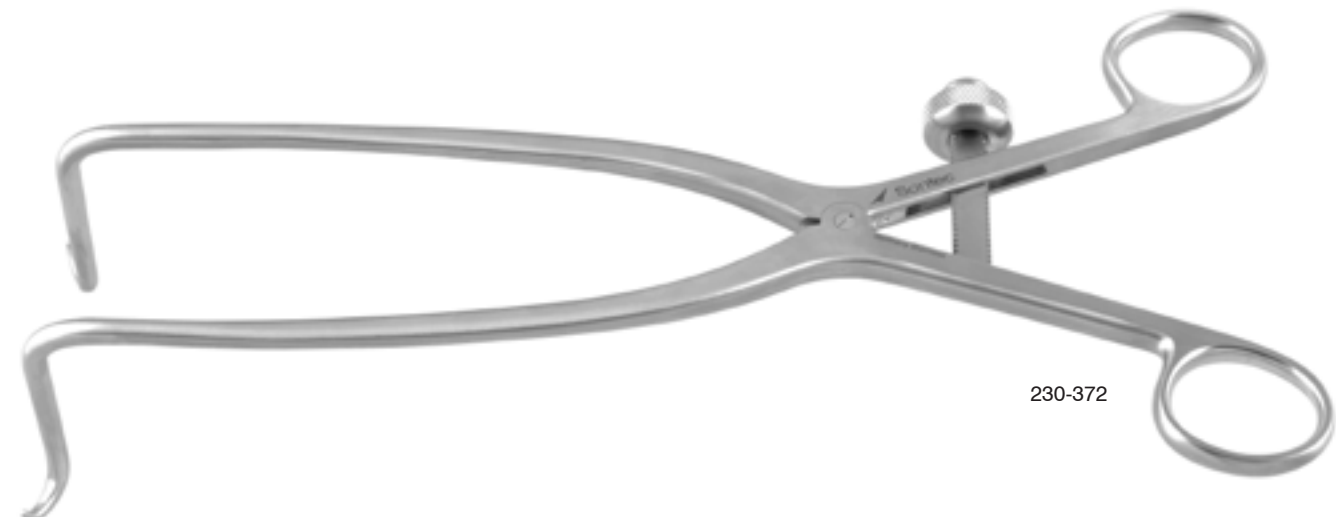

Gelpi Spinal Retractor

90° angle / with speed lock

- 230-374 4" / 14"
- 230-375 5" / 15"



Neroma Gelpi Spinal Retractor

90° angle / blunt / with speed lock

230-376 14" overall length with 4" deep arms

230-378 15" overall length with 5" deep arms

* special order, minimum order 5 each

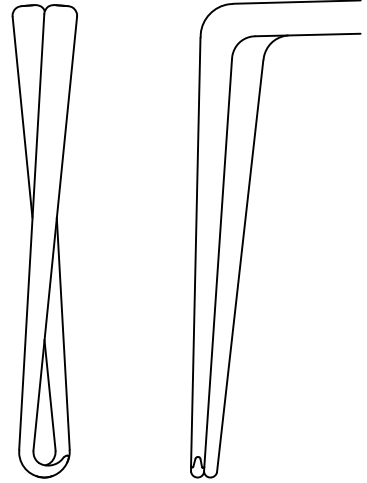
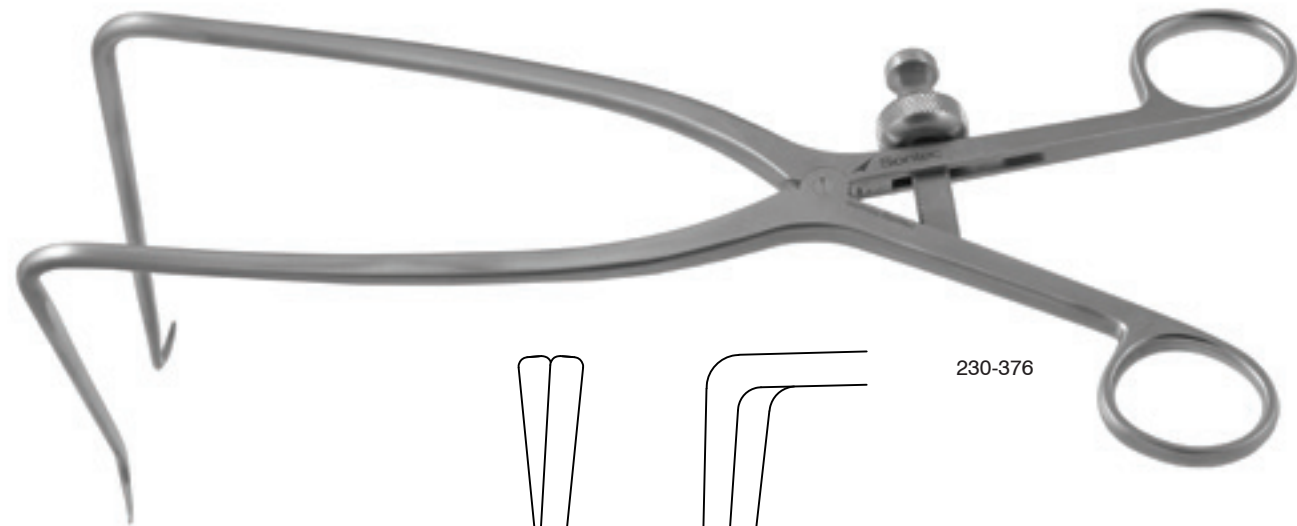

230-376

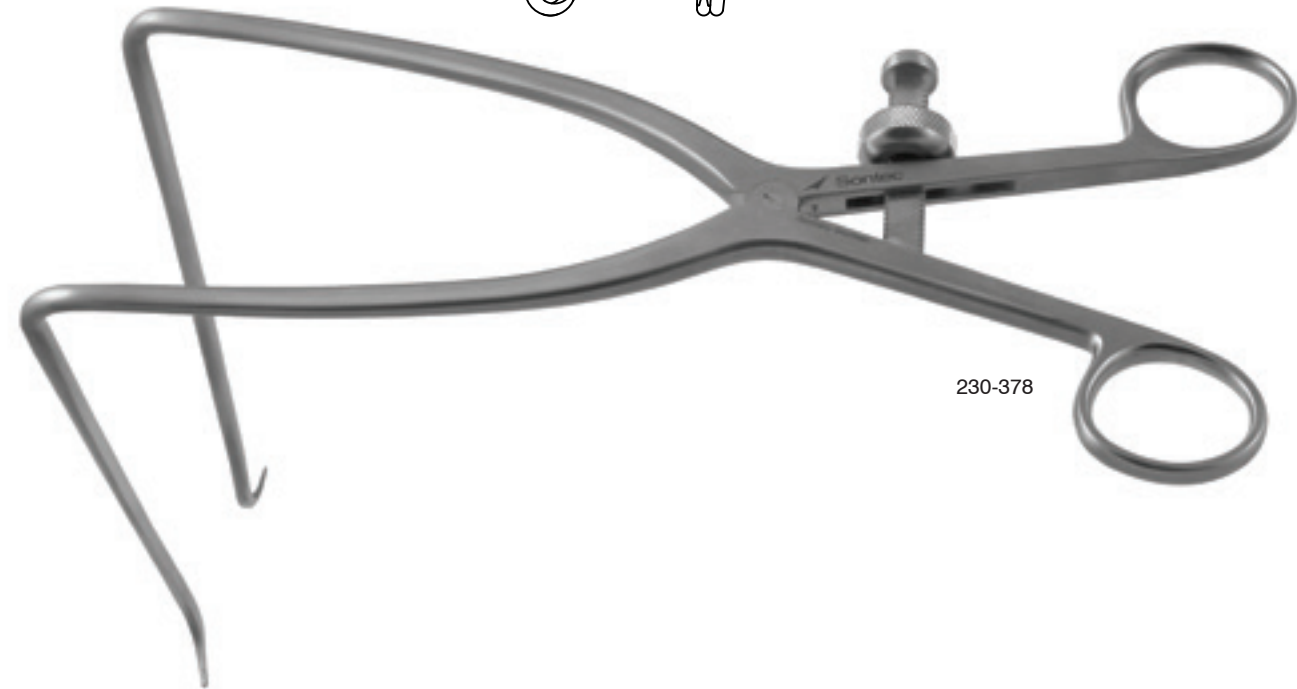

230-378

Weitlaner Retractor

Hinged arms / 3 x 4 prongs

1100-636 sharp 5 1/2" (14 cm)

1100-638 blunt 5 1/2" (14 cm)

1100-640 sharp 6 1/4" (16 cm)

1100-642 blunt 6 1/4" (16 cm)

1100-644 sharp 8" (20.5 cm)

1100-644B blunt 8" (20.5 cm)

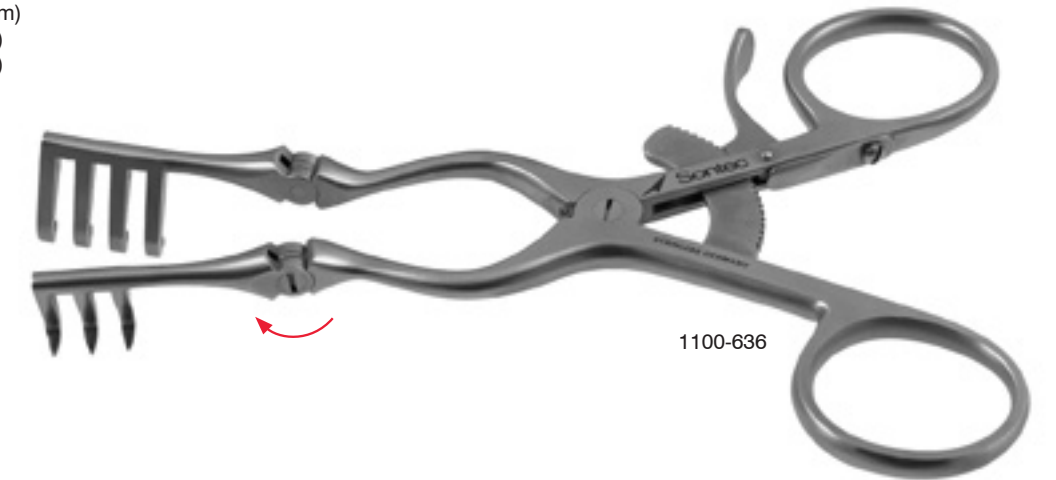

1100-636

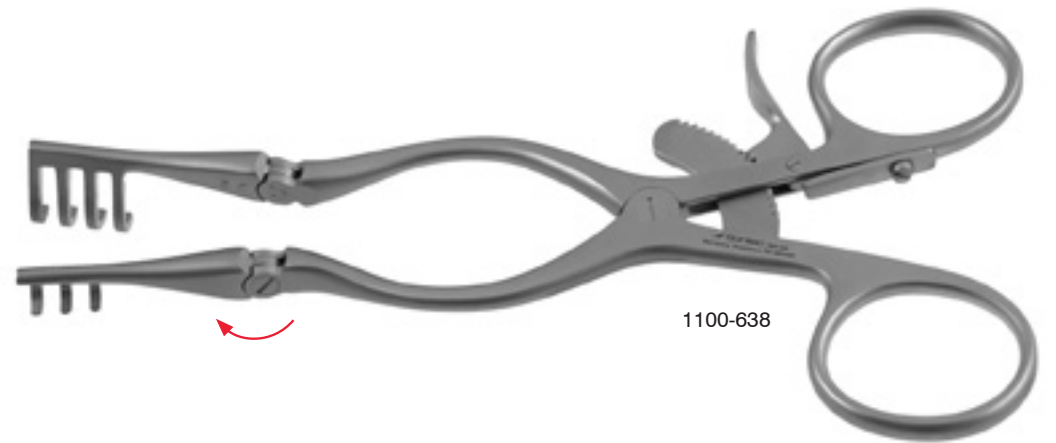

1100-638

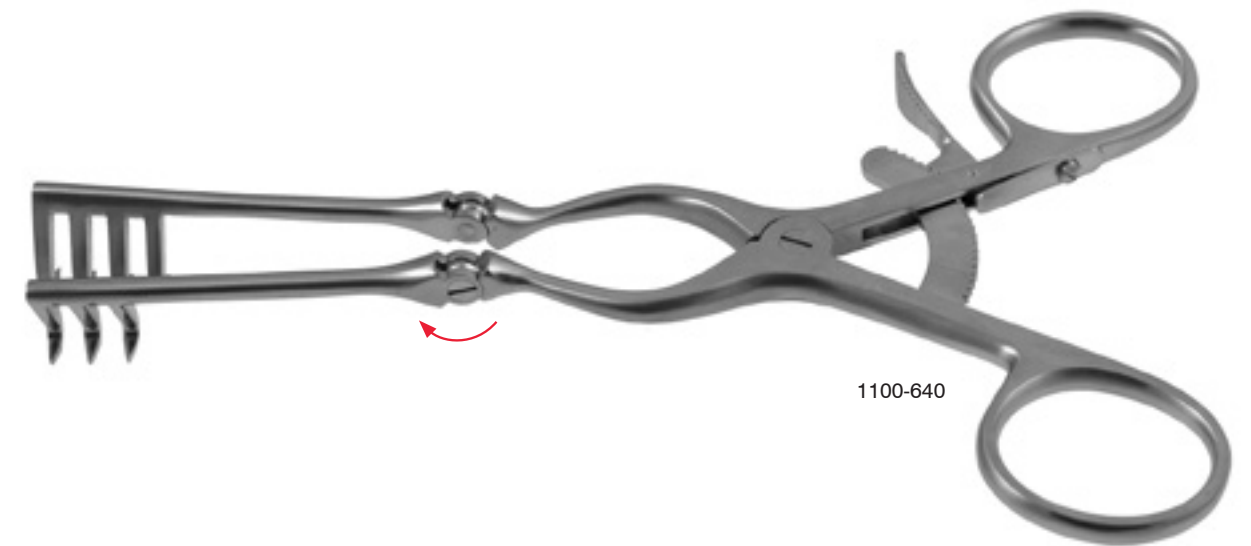

1100-640

Adson Cerebella Retractor

4 x 4 sharp prongs / 7 1/2" (19 cm)

230-480 straight arms

230-486 angled arms



Weitlaner Retractor Titanium

3x4 prongs / sharp / 5 1/2" (14 cm)

2600-618



Weitlaner Retractor

2 x 3 prongs

- 1100-616 sharp 4" (10 cm)
- 1100-617 blunt 4" (10 cm)

3 x 4 prongs

- 1100-618 sharp 5 1/2" (14 cm)
- 1100-619 blunt 5 1/2" (14 cm)
- 1100-620 sharp 6 1/4" (16 cm)
- 1100-621 blunt 6 1/4" (16 cm)
- 1100-622 sharp 8" (20.5 cm)
- 1100-623 blunt 8" (20.5 cm)
- 1100-624 sharp 9 1/2" (24 cm)
- 1100-625 blunt 9 1/2" (24 cm)



sharp



blunt



1100-617



1100-618



1100-619

Weitlaner Extended Blades Retractor

With 4 prongs / prong depth 3.5 cm / straight arms / blunt tips / 4 1/2" (11.4 cm)

230-445

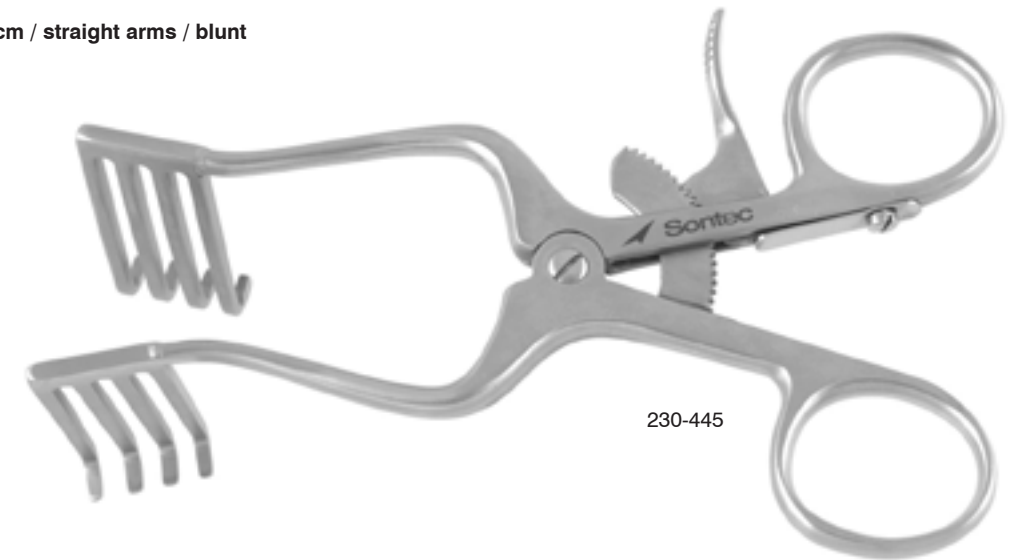

230-445

Beckman-Adson Retractor

4 x 4 prongs / 12 1/4" (31 cm) / hinged

- 1100-645B blunt
- 1100-645S sharp



1100-645B

Beckman Retractor

3 x 4 prongs / hinged / sharp / 10" (25.4 cm)

230-4901

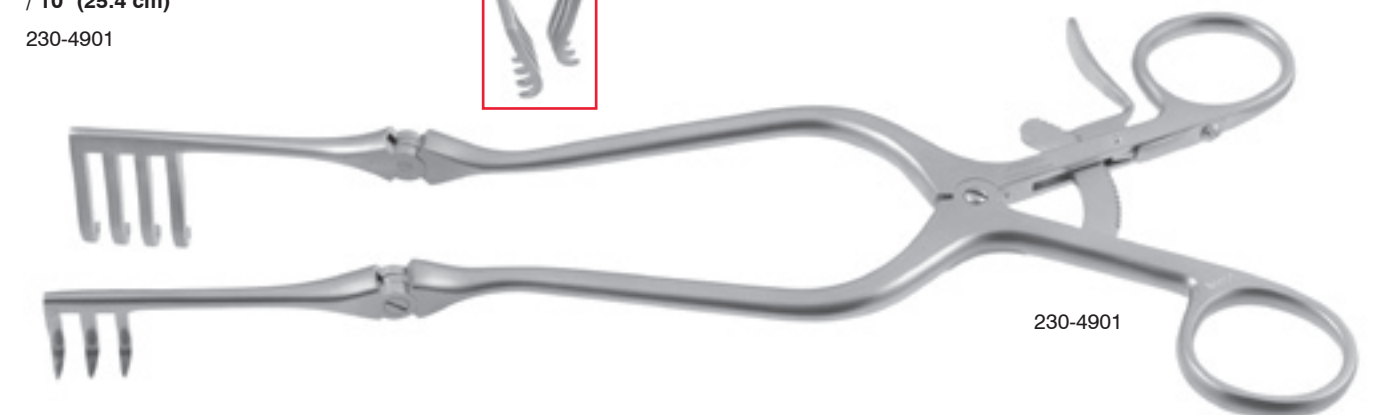

230-4901

Mollison Retractor

2 x 2 sharp 12 mm blades / 5" (13 cm)

1100-6251

4 x 4 sharp 15 mm blades / 6 3/4" (17 cm)

1100-6252

4 x 4 sharp 13 mm blades / 6" (15 cm)

1100-6253

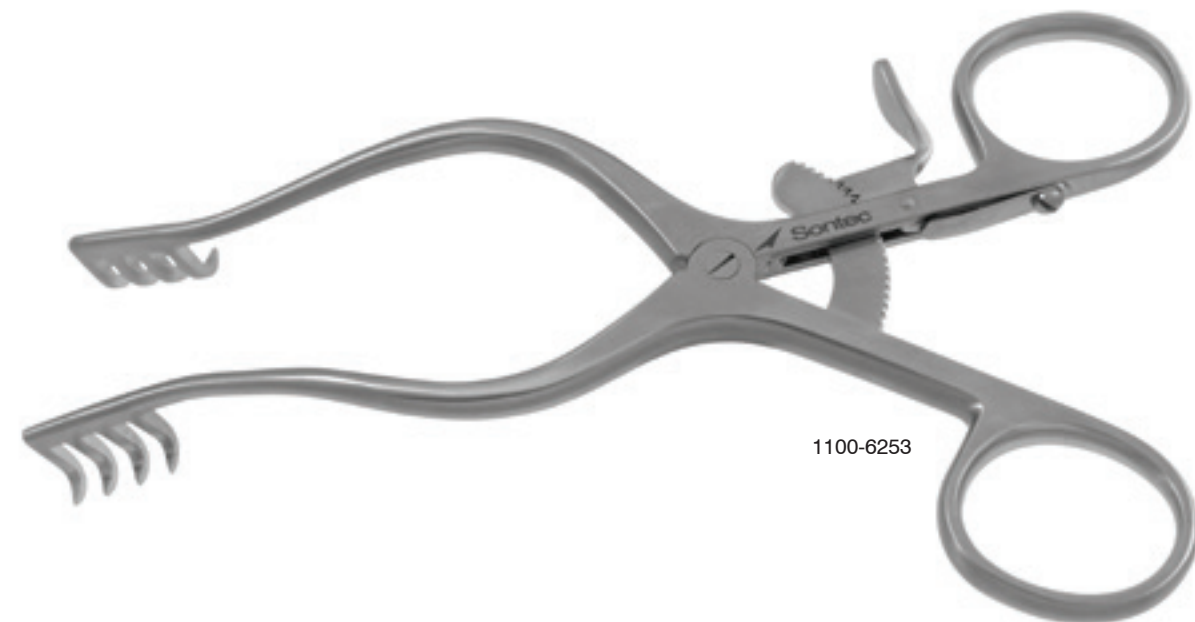
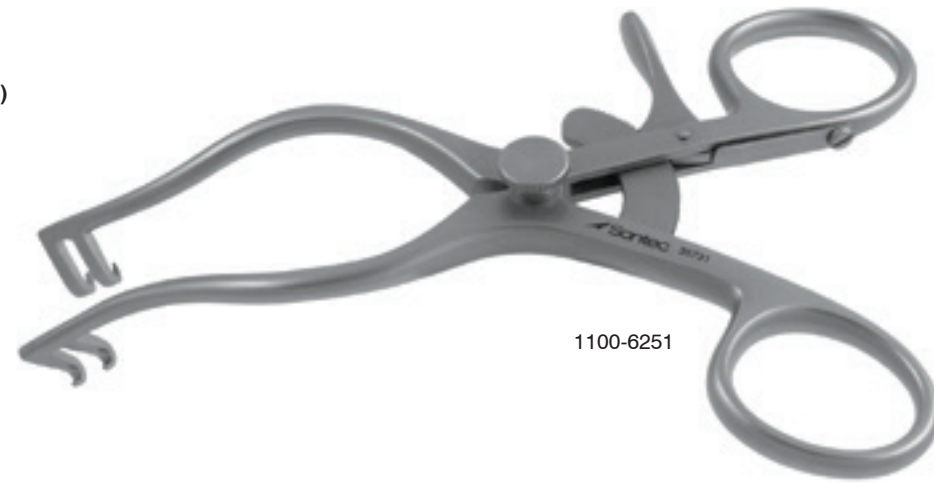

Gelpi Spinal Retractor

90° angle / with speed lock / with cerebellar tip / 13 1/2" (34.3 cm)

230-365

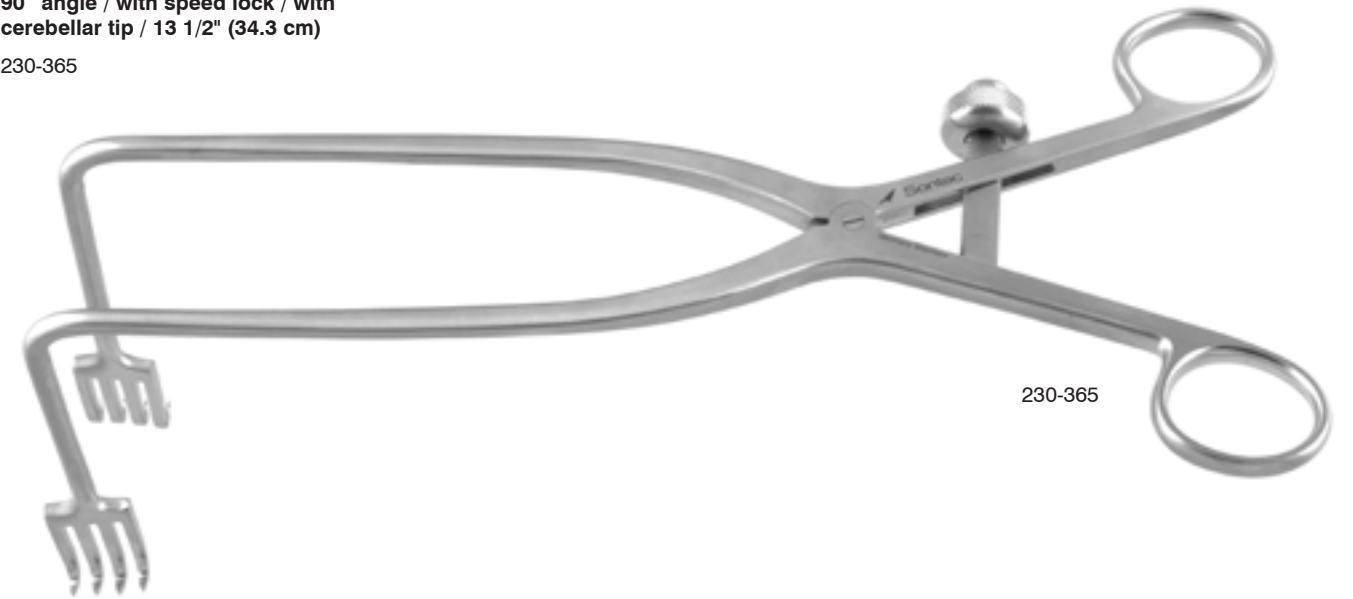

Frazier Lamina Retractor

1 1/4" deep / 3 x 4 prongs / 4" (10 cm) spread

1100-608



Sontec Multi-Level Gelpi Retractor

Sharp / 3 x 3 parallel prongs / 25 mm between prongs / 12" (30.5 cm)

- 230-352 50 mm prong tip
- 230-354 35 mm prong tip
- 230-357 60 mm prong tip
- 230-360 95 mm prong tip

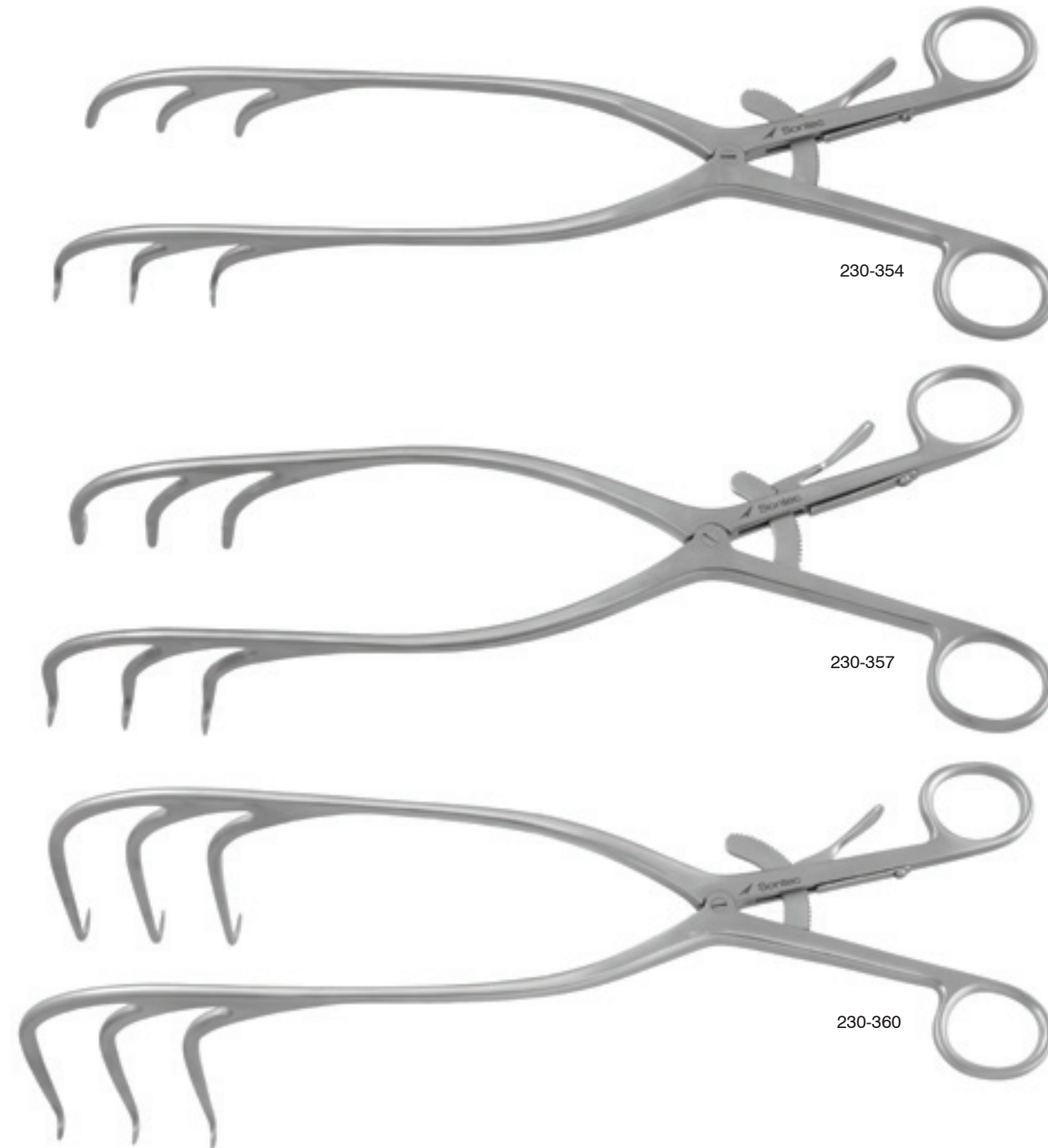
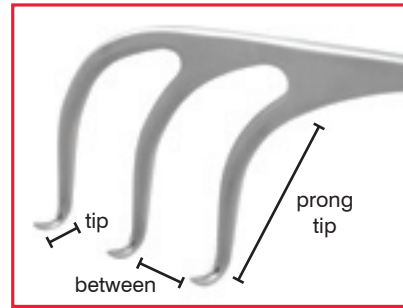

Sontec Multi-Level Off Set Arms Gelpi Retractor

Sharp / 3 x 3 prongs / 10.5" (27 cm) / "Shorter design in arms adds more stability with less flex."

- 230-337 right 64 mm & 44 mm prongs 7 mm tip
- 230-338 left 44 mm & 64 mm prongs 7 mm tip

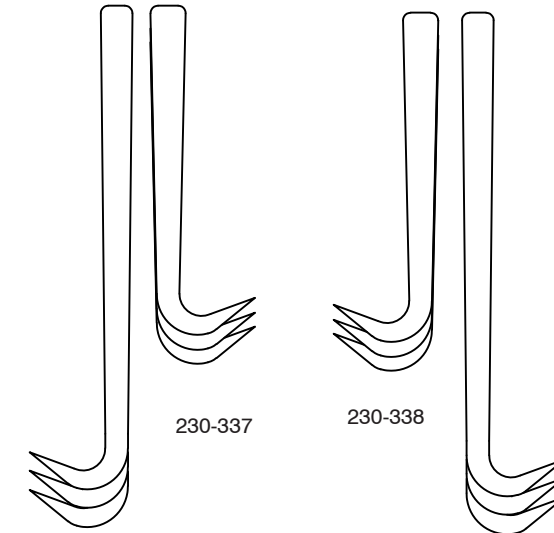
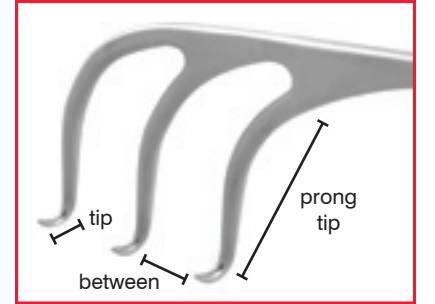

Beckman-Eaton Retractor

Hinged blades / 7 x 7 prongs / sharp / 12 1/2" (32 cm)

1100-646



Sontec Multi-Level Gelpi Retractor

Sharp / 3 x 3 prongs / with off-set arms / 10.5" (27 cm)
 230-347 60 mm prongs 7 mm tip

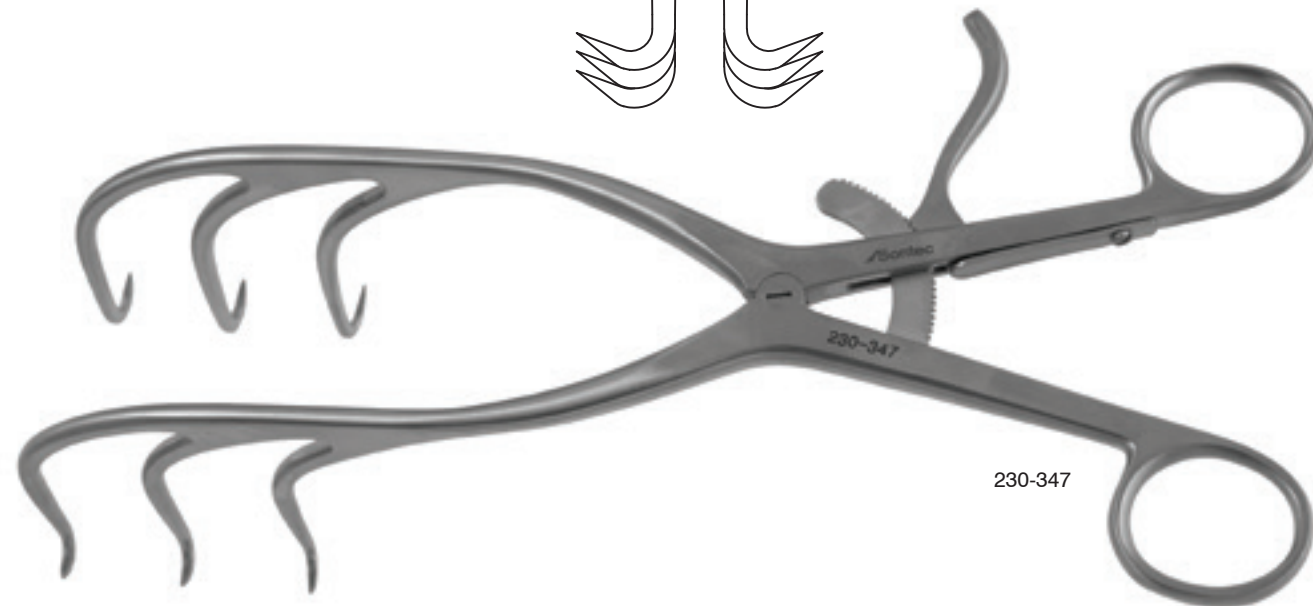
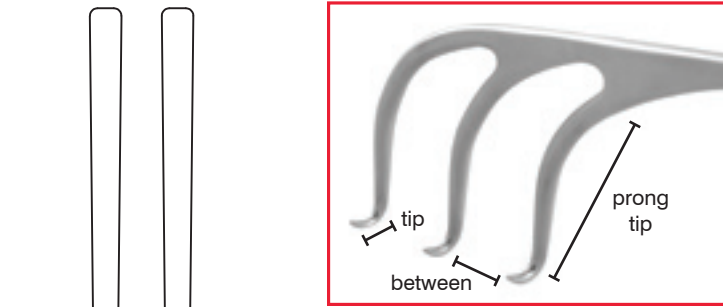

Miskimon Cerebellum Retractor

7 x 7 prongs
 417-045 sharp 7 3/4" (20 cm)



Spinal Distractor/Compressor

11 1/4" (28.6 cm)
 416-604 distractor
 416-601 compressor



Spinal Distractor

1/4" rods / 45° angle / small style
 416-603 9 1/2" (24 cm)

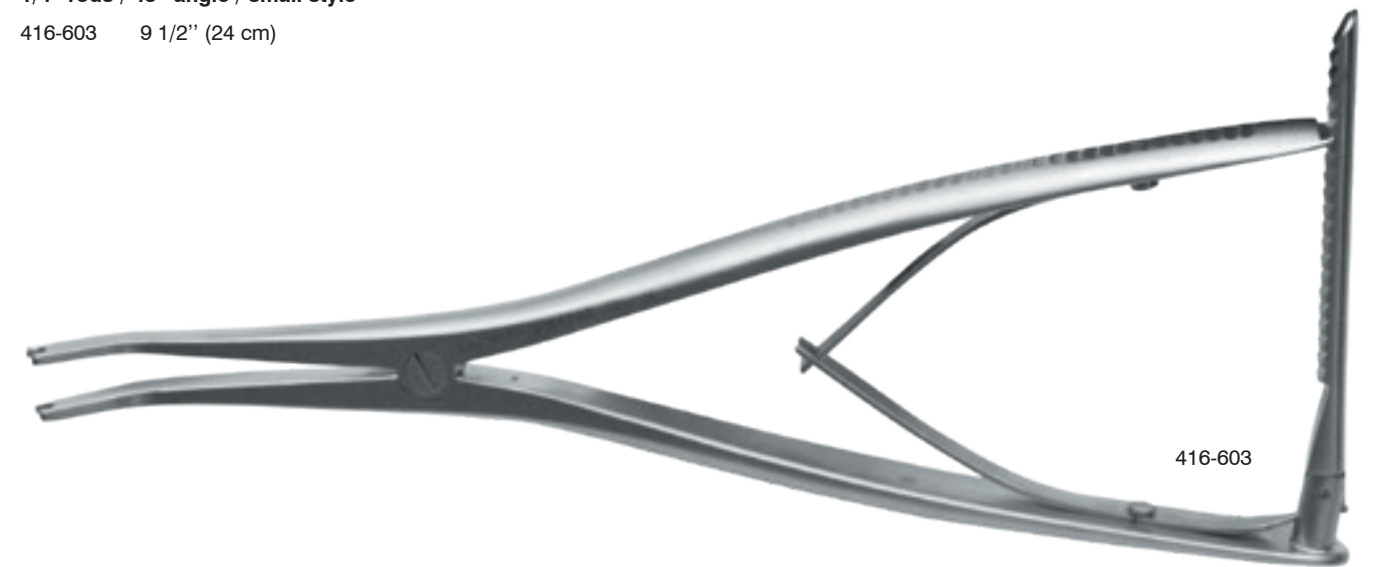

Spinal Compressor

Small style

416-602 10" (25.5 cm)



416-602

Spinal Distractor

1/4" rods / 45° angle / large style

416-605 12 1/2" (32 cm)



416-605

Spinal Compressor

Large style

416-600 12" (30.5 cm)



416-600

Double-Action Distractor

1/4" rods / 30° angle / 15" (38.1 cm)

416-610



416-610

Double-Action Compressor

1/4" rods / 30° angle / 15" (38.1 cm)

416-615



416-615



 Sontec Instruments®

SUCTION Selection

General Suction Information

French measurement scale for determining suction tube diameter

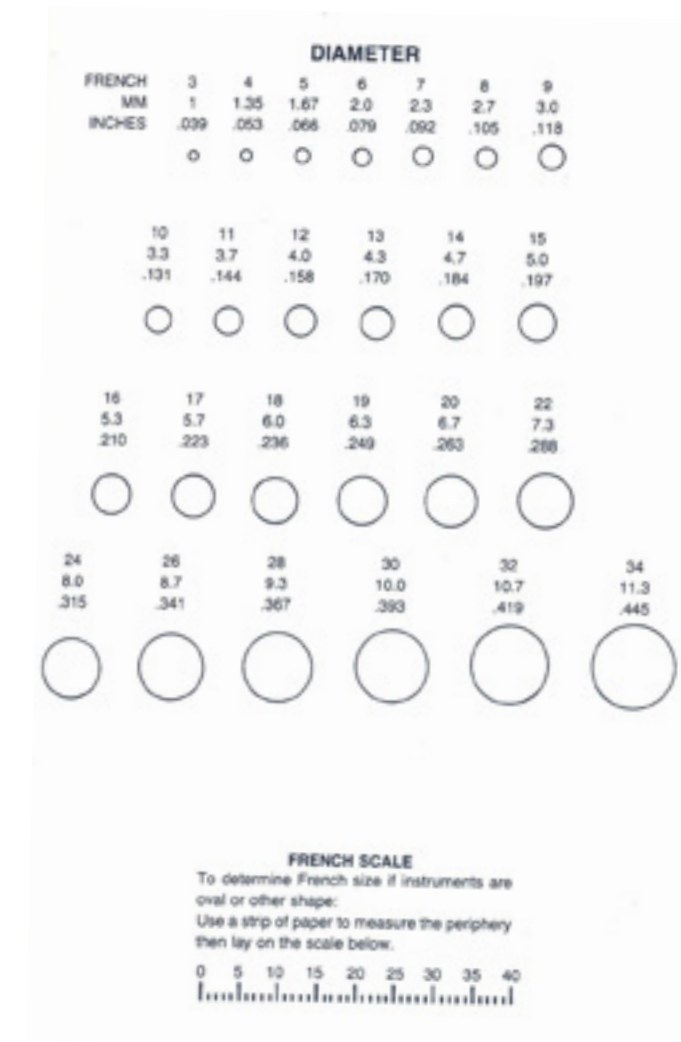

Frazier Angled Suction

Finger cut-off hole to control suction /
angled / 7" (18 cm)

- 412-677 3 french
- 412-678 4 french
- 412-680 6 french
- 412-681 7 french
- 412-682 8 french
- 412-683 9 french
- 412-684 10 french
- 412-685 11 french
- 412-686 12 french
- 412-688 15 french

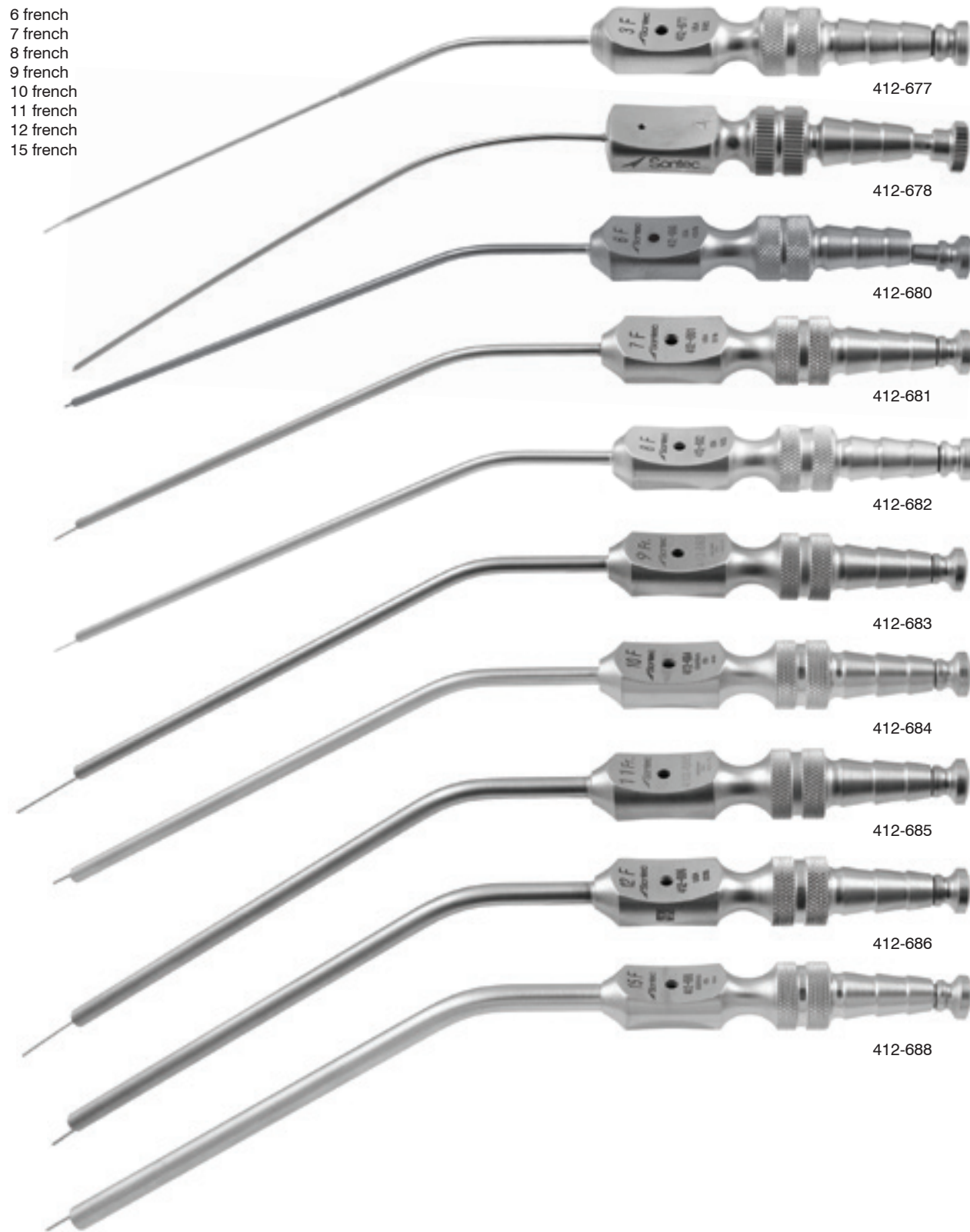

Frazier Angled Suction

9" (23 cm)
412-705 10 french



Frazier Angled Suction

Finger cut-off hole to control suction / angled / malleable / 7" (18 cm)

- 412-677M 3 french
- 412-678M 4 french
- 412-680M 6 french
- 412-681M 7 french
- 412-682M 8 french
- 412-683M 9 french
- 412-684M 10 french
- 412-685M 11 french
- 412-686M 12 french
- 412-688M 15 french

* special order

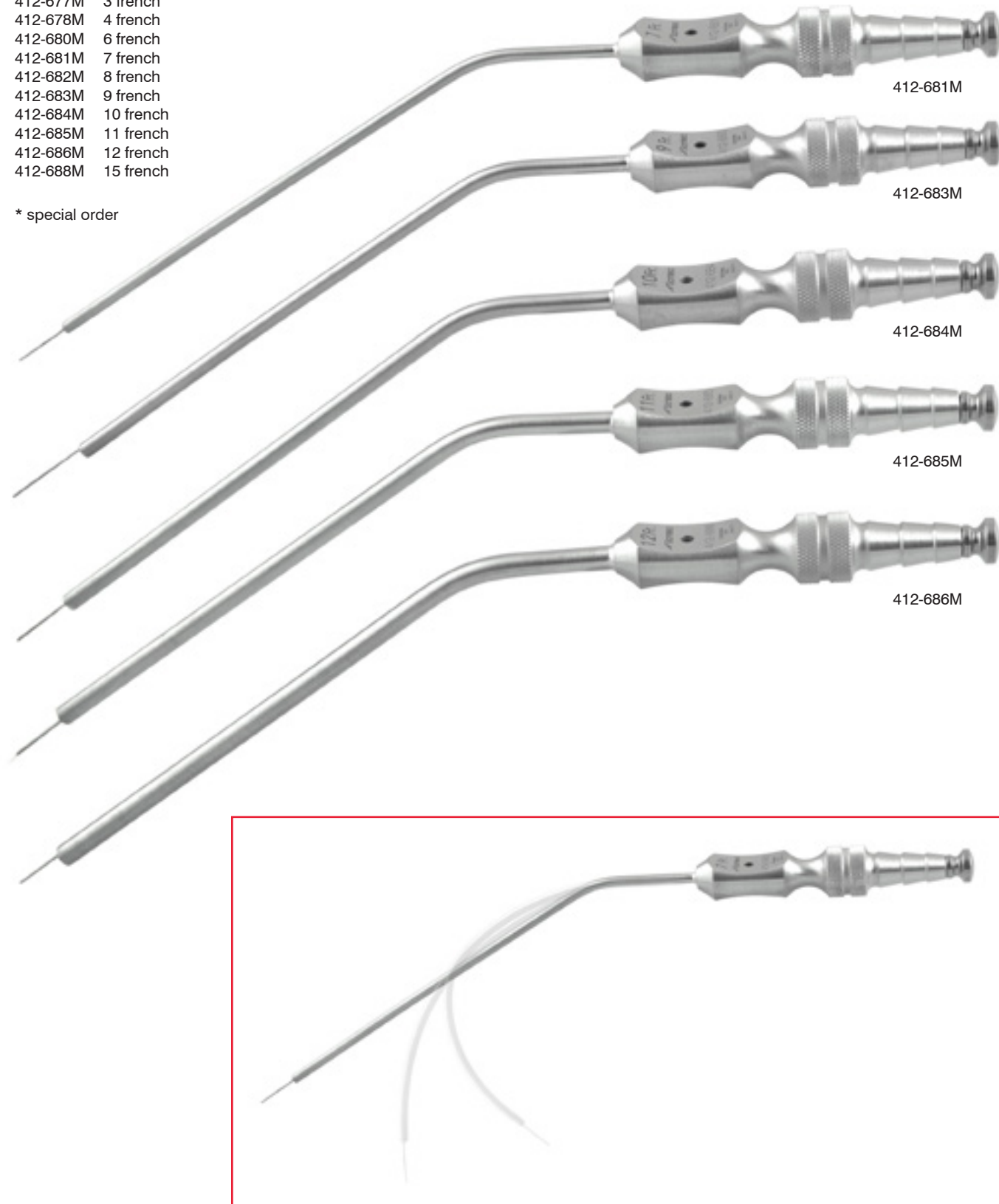

412-681M

412-683M

412-684M

412-685M

412-686M

Frazier Angled Suction

Finger cut-off slot to control suction / angled / 7" (18 cm)

- 412-677L 3 french
- 412-678L 4 french
- 412-679L 5 french
- 412-680L 6 french
- 412-681L 7 french
- 412-682L 8 french
- 412-683L 9 french
- 412-684L 10 french
- 412-685L 11 french
- 412-686L 12 french

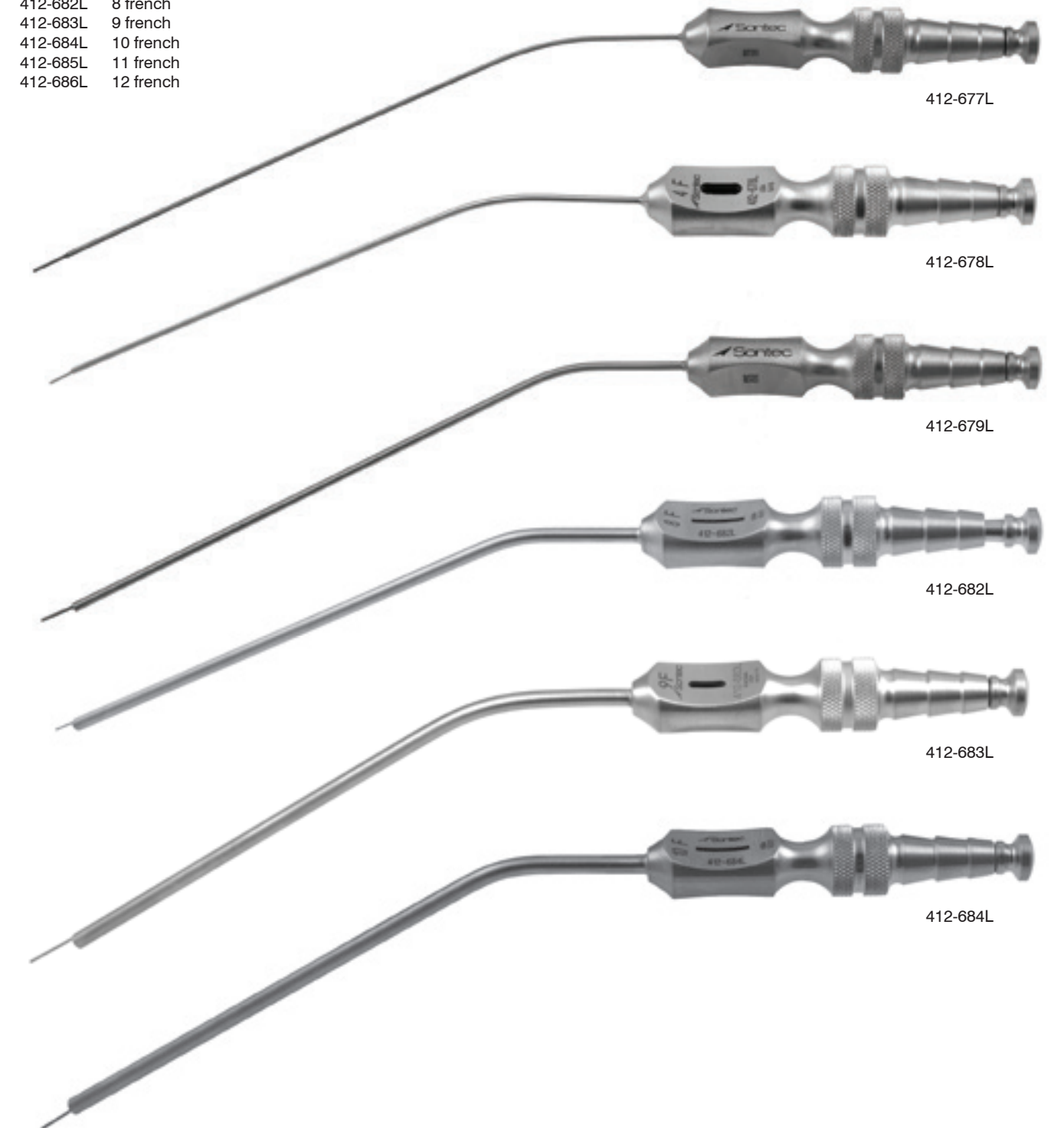

412-677L

412-678L

412-679L

412-682L

412-683L

412-684L

Frazier Straight Suction

Finger cut-off hole to control suction / straight / 7" (18 cm)

- 412-689 5 french
- 412-690 6 french
- 412-691 7 french
- 412-692 8 french
- 412-694 10 french
- 412-696 12 french

9" (23 cm)

- 412-700 6 french
- 412-701 7 french
- 412-702 8 french
- 412-704 10 french
- 412-706 12 french



Frazier Insulated Suction

Finger cut-off hole to control suction / angled / Insulated electro coated tube / 7" (18 cm)

- 412-677I 3 french
- 412-678I 4 french
- 412-679I 5 french
- 412-680I 6 french
- 412-681I 7 french
- 412-682I 8 french
- 412-683I 9 french
- 412-684I 10 french
- 412-685I 11 french
- 412-686I 12 french

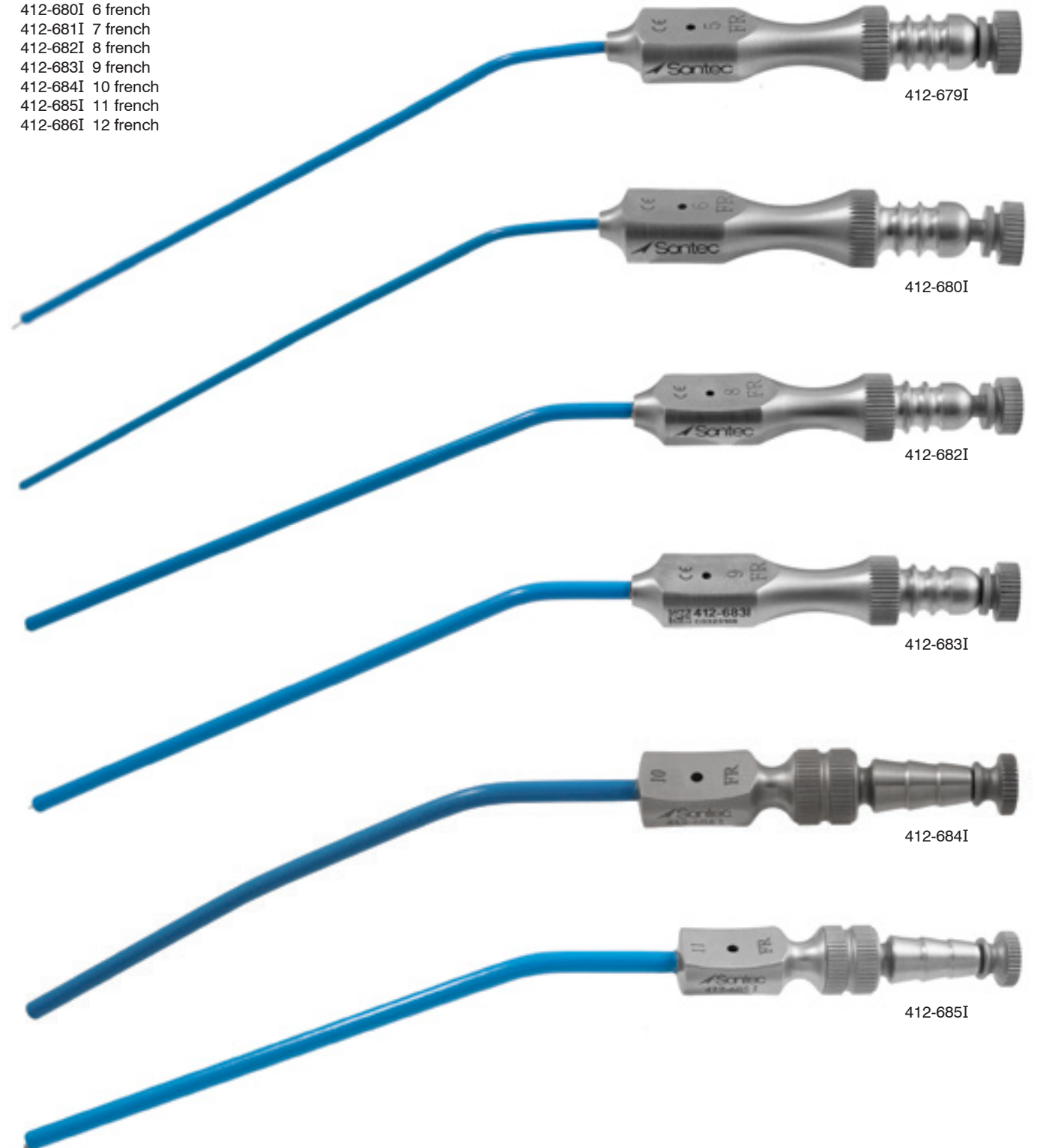

Frazier-Rhoton Angled Suction

Finger cut-off hole to control suction / angled / with olive tip / 7" (18 cm)

- 412-681R 7 french
- 412-682R 8 french
- 412-686R 12 french

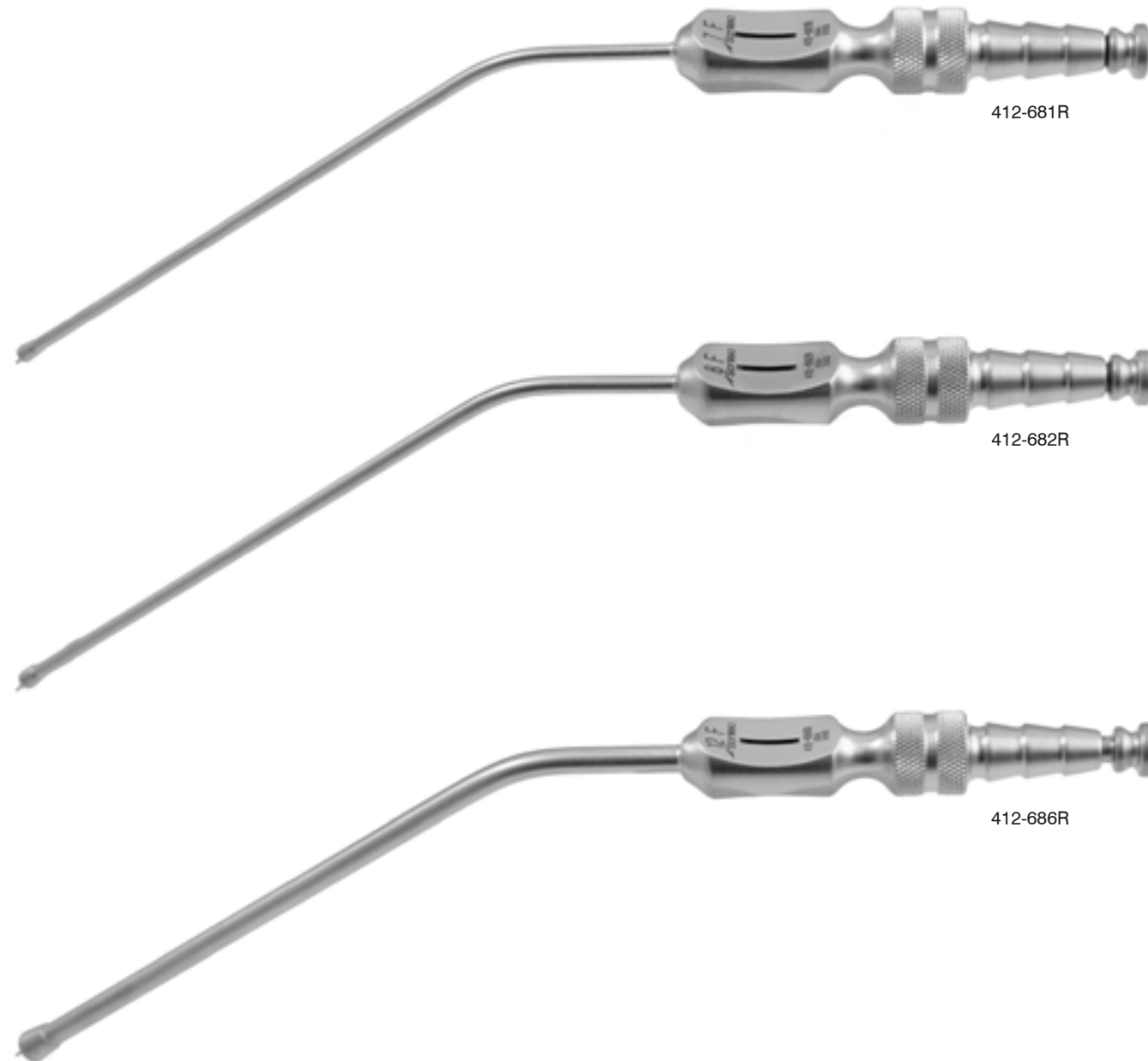

Rhoton Micro Neuro Suction

Specially blunted atraumatic tips / 80 mm working length

- 412-839 3 french
- 412-840 5 french
- 412-844 7 french
- 412-841 10 french

100 mm working length

- 412-845 3 french
- 412-848 5 french
- 412-846 7 french
- 412-847 10 french

130 mm working length

- 412-849 5 french
- 412-850 7 french
- 412-851 10 french
- 412-852 12 french

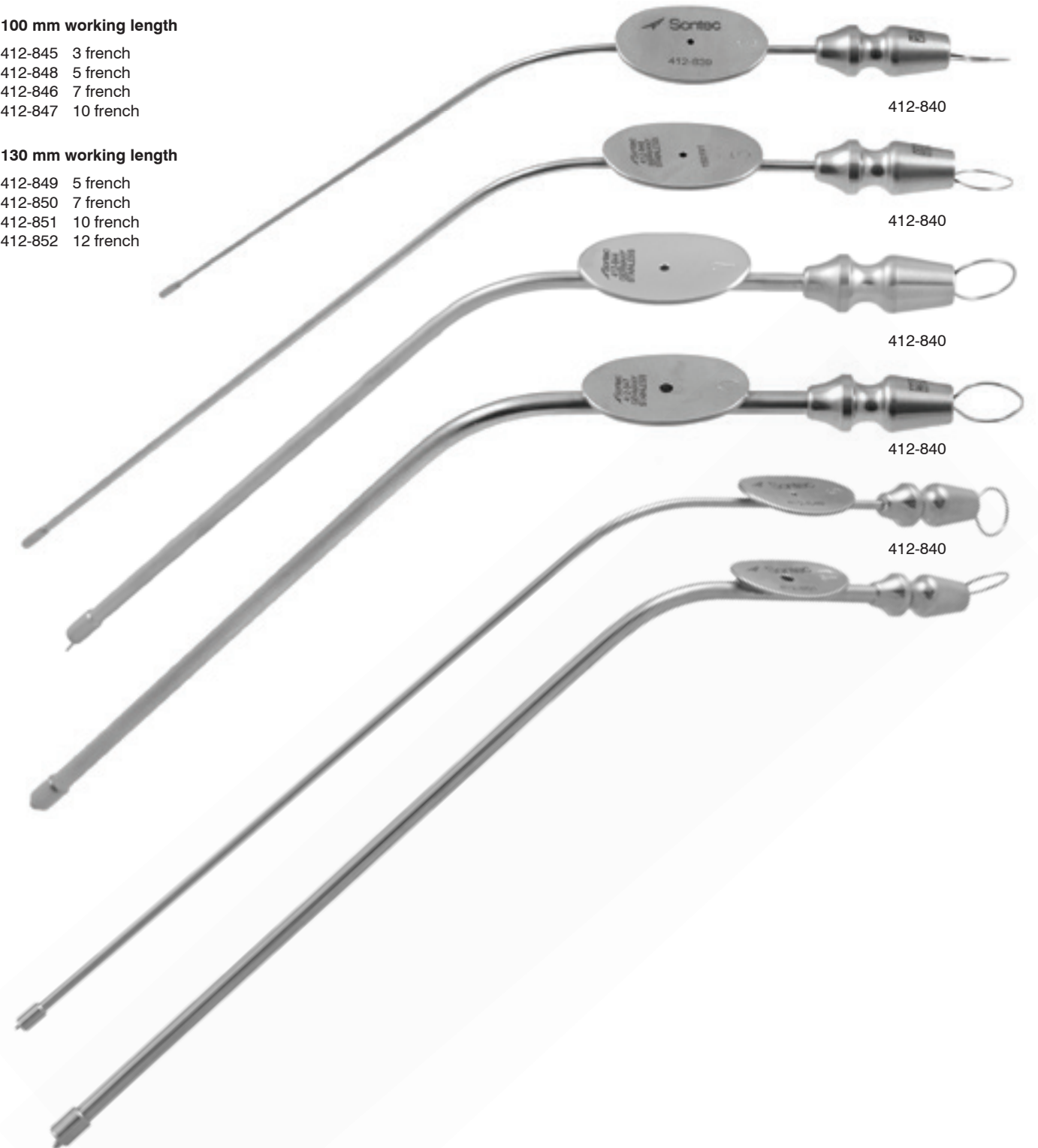

Fukushima Suction

Tapered tube shaft / teardrop finger control / 5" (12.7 cm) working length

- 180-404S 4 fr
- 180-405S 5 fr
- 180-406S 6 fr
- 180-407S 7 fr
- 180-408S 8 fr
- 180-409S 9 fr
- 180-410S 10 fr
- 180-411S 11 fr
- 180-412S 12 fr

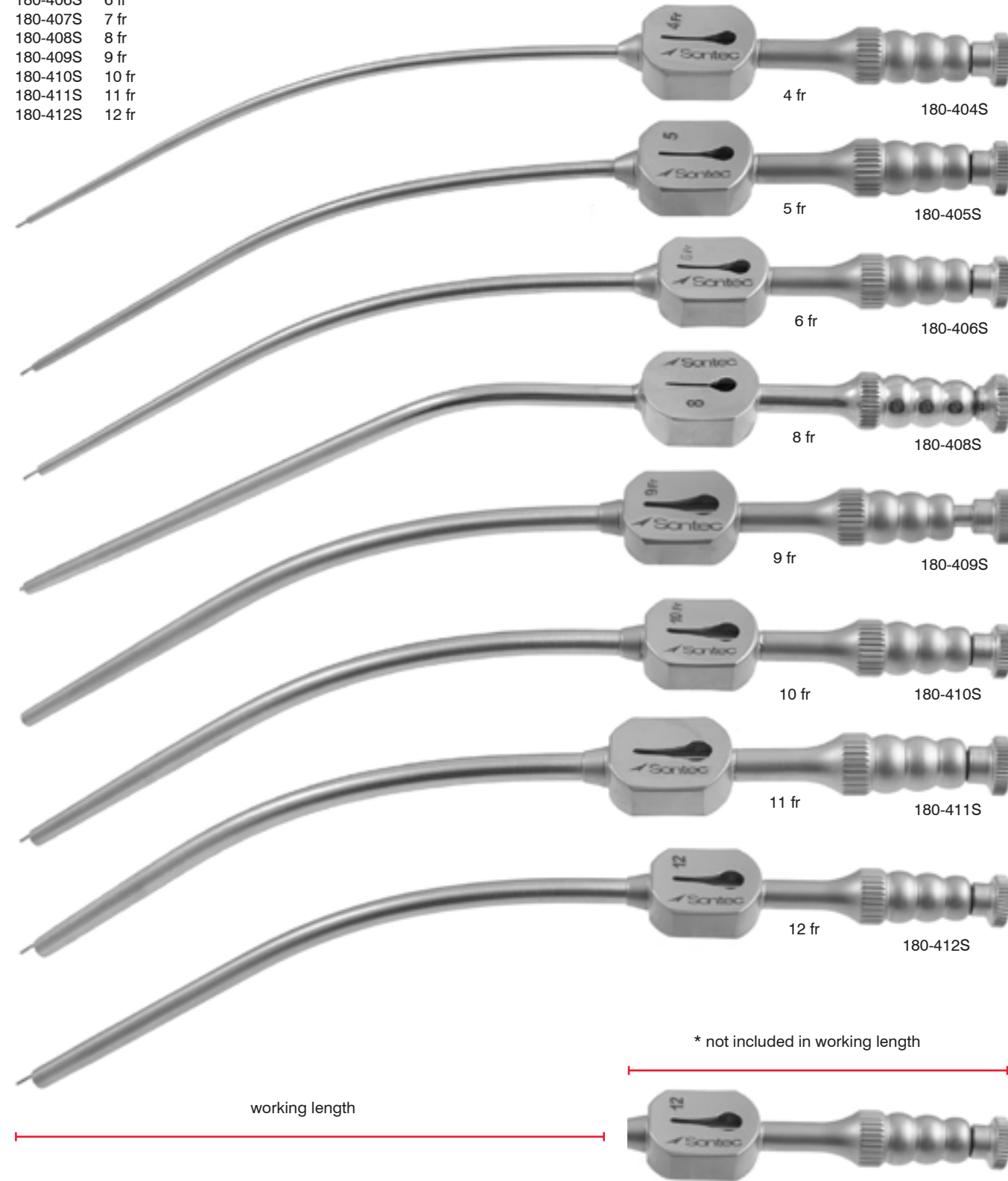

Fukushima Suction

Tapered tube shaft / teardrop finger control / 7" (18 cm) working length

- 180-403 3 fr
- 180-404 4 fr
- 180-405 5 fr
- 180-406 6 fr
- 180-407 7 fr
- 180-408 8 fr
- 180-409 9 fr
- 180-410 10 fr
- 180-411 11 fr
- 180-412 12 fr

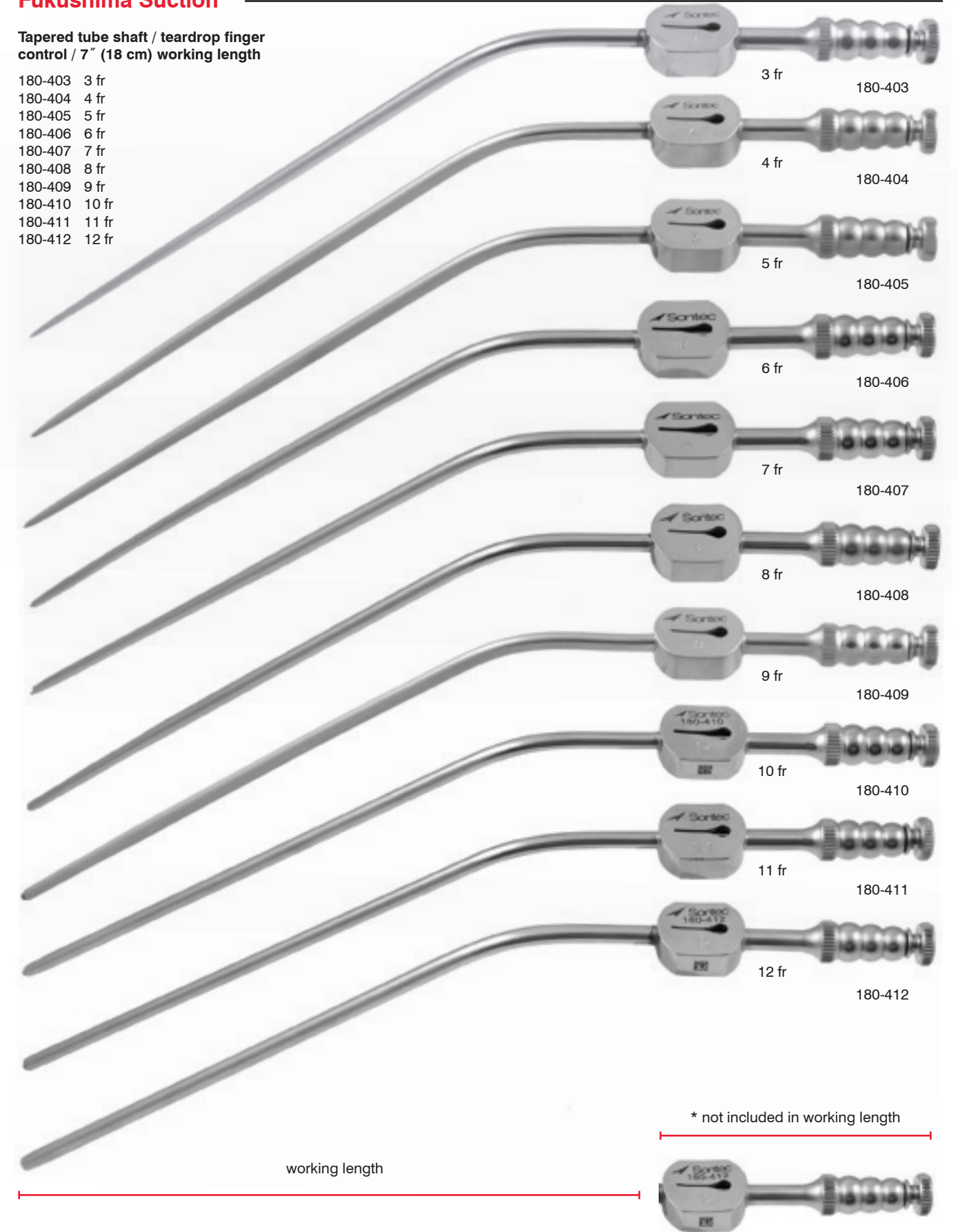

Sontec Neuro Suction

tapered tubing for increased flow / short shaft / 3 hole finger control / 2 3/4" (7 cm)

- 412-853 1.2mm tip
- 412-854 2mm tip
- 412-855 2.5mm tip

Medium shaft / 3 hole finger control / 4" (10 cm)

- 412-856 1.2mm tip
- 412-857 2mm tip
- 412-858 2.5mm tip

Long shaft / 3 hole finger control / 5 1/2" (14 cm)

- 412-859 1.2mm tip
- 412-860 2mm tip
- 412-861 2.5mm tip



Barnes Mini Suction Tube

- 412-7081 1.5 mm tip
- 412-7082 1.7 mm tip
- 412-7083 2 mm tip
- 412-7084 3 mm tip

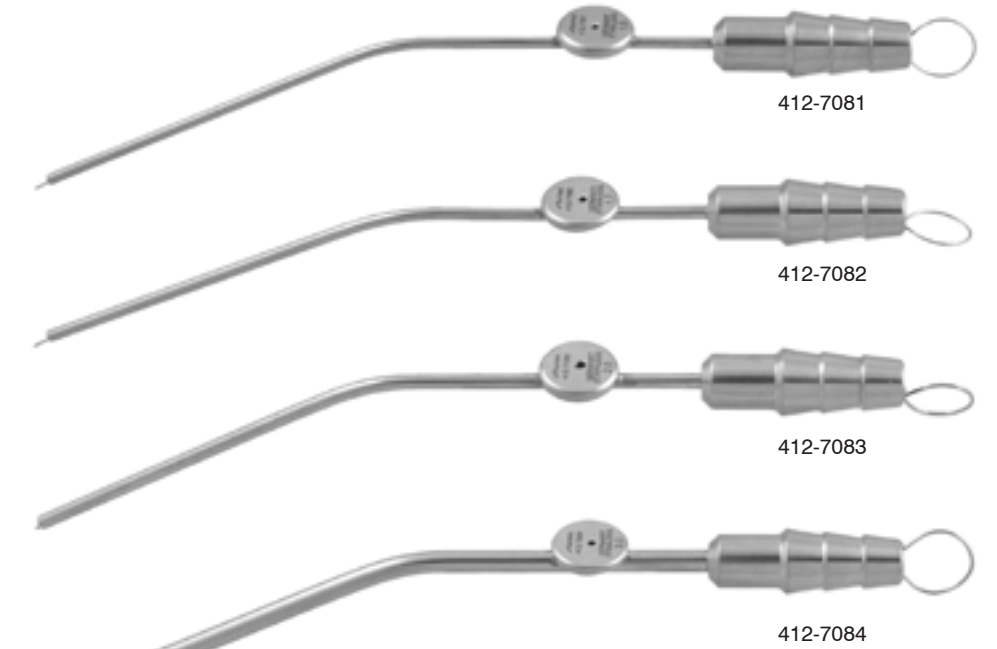

Baron Suction

Finger cut-off hole to control suction / angled / 4" (10 cm)

- 412-710 3 french
- 412-712 4 french
- 412-713 5 french
- 412-714 7 french

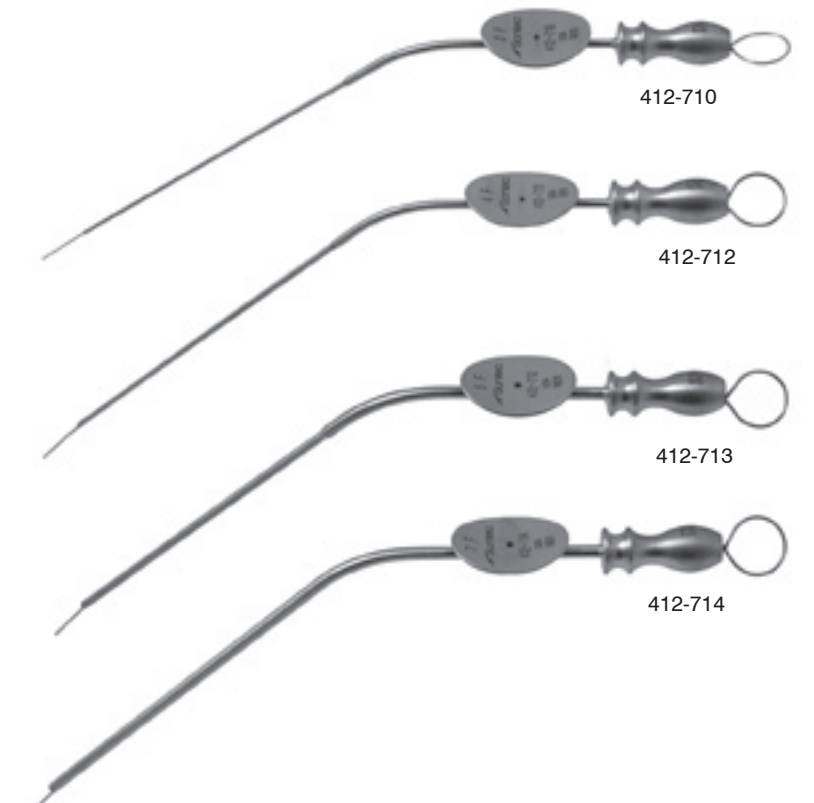

Pashley-Frazier Suction

Curved tip / 7" (18 cm)

- 1463-501 7 french curved right
- 1463-500 7 french curved left
- 1463-503 8 french curved right
- 1463-504 8 french curved left
- 1463-506 9 french curved right
- 1463-507 9 french curved left

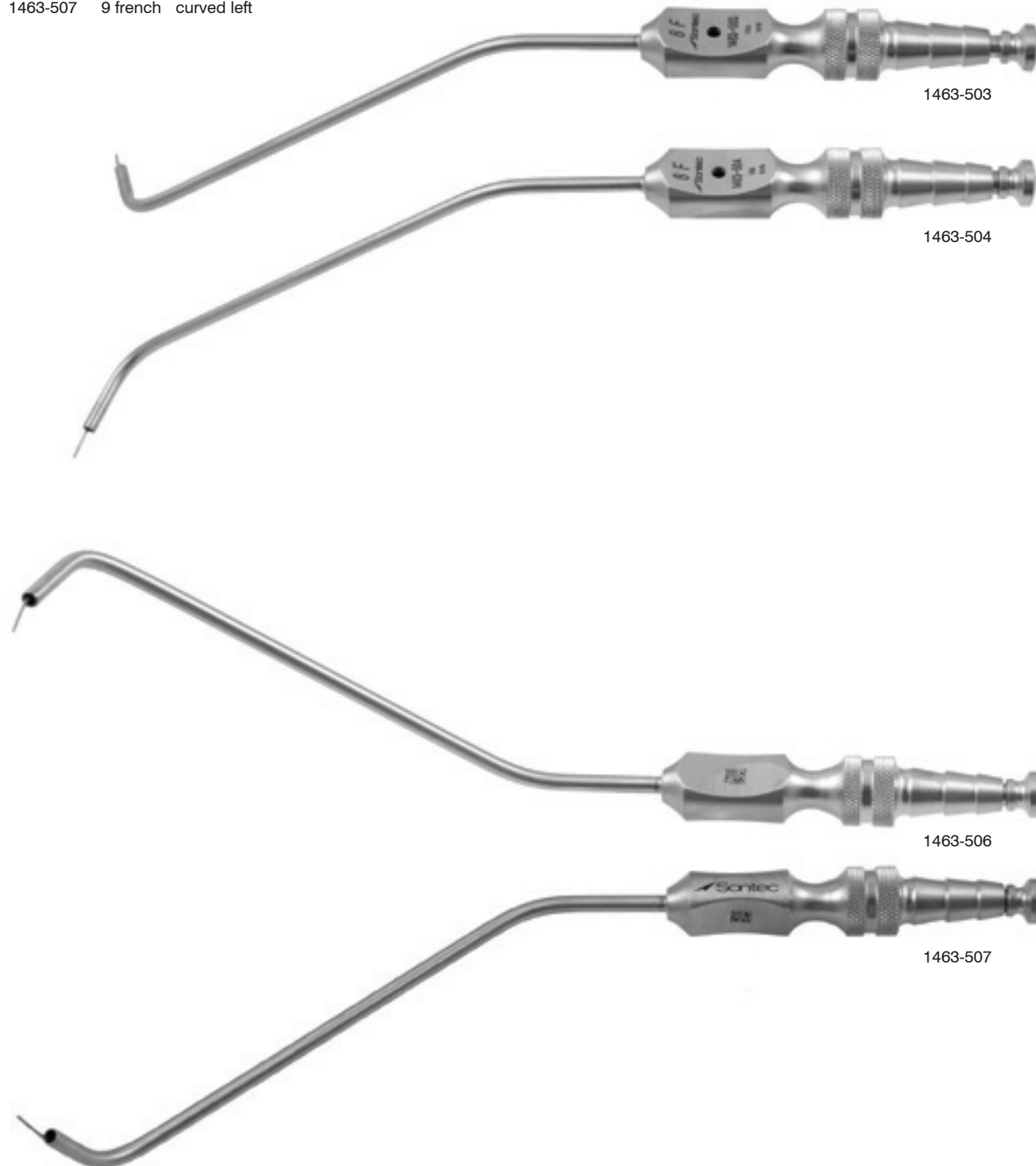

Modified Ferguson-Frazier Suction

Fenestrated oval tip

- 412-685F 11 french angled
- 412-686H 12 french angled with hook lip



Bayonet Suction Tube

Top finger control / 3 3/8" working length

- 412-900 5 french
- 412-902 7 french
- 412-904 9 french

Right finger control / 3 3/8" working length

- 412-906 5 french
- 412-908 7 french
- 412-910 9 french

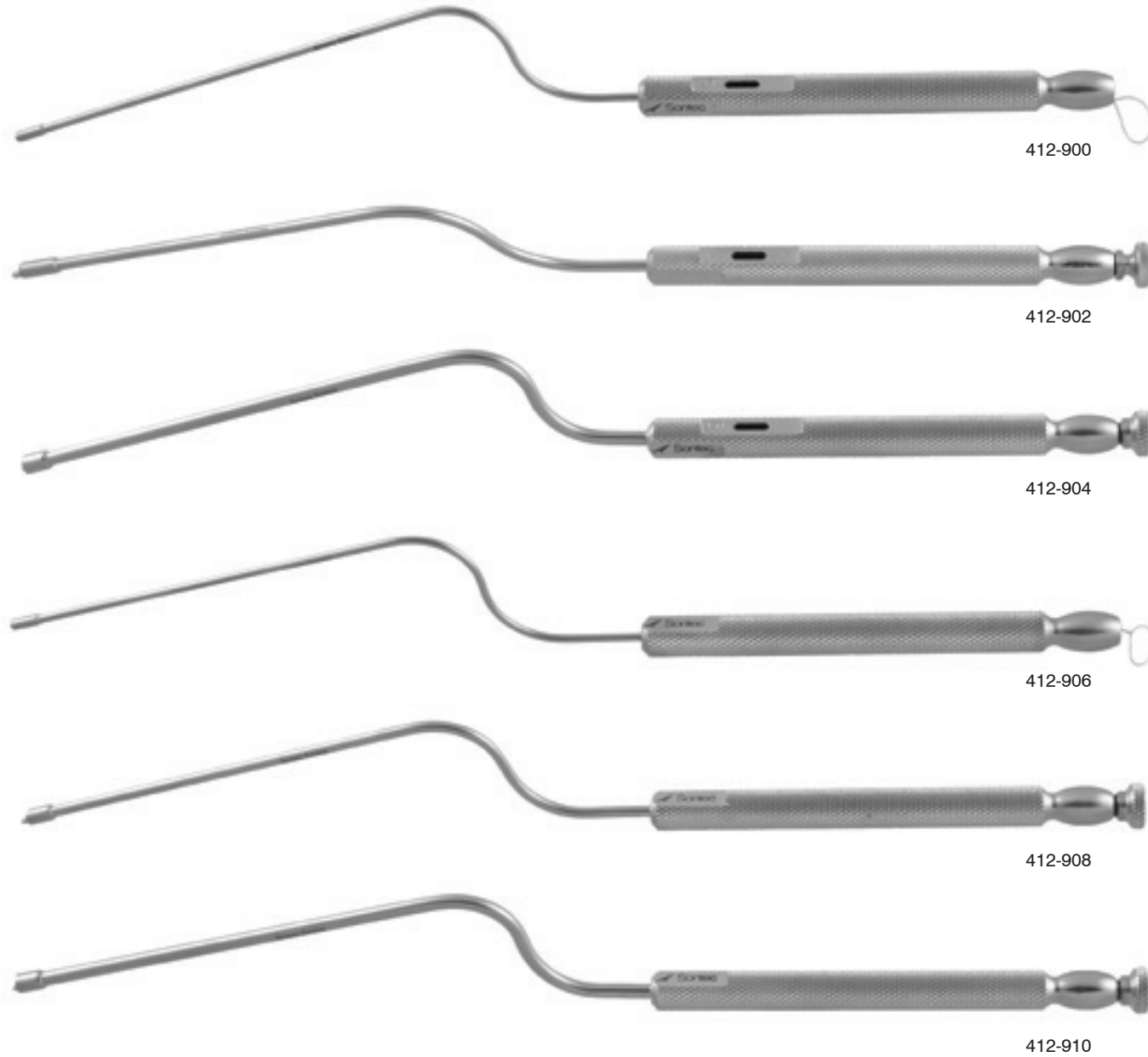

Suction Nerve Retractor

7 french / 8" (20.3 cm)

- 412-7256 6 mm
- 412-7257 7 mm
- 412-7258 8 mm

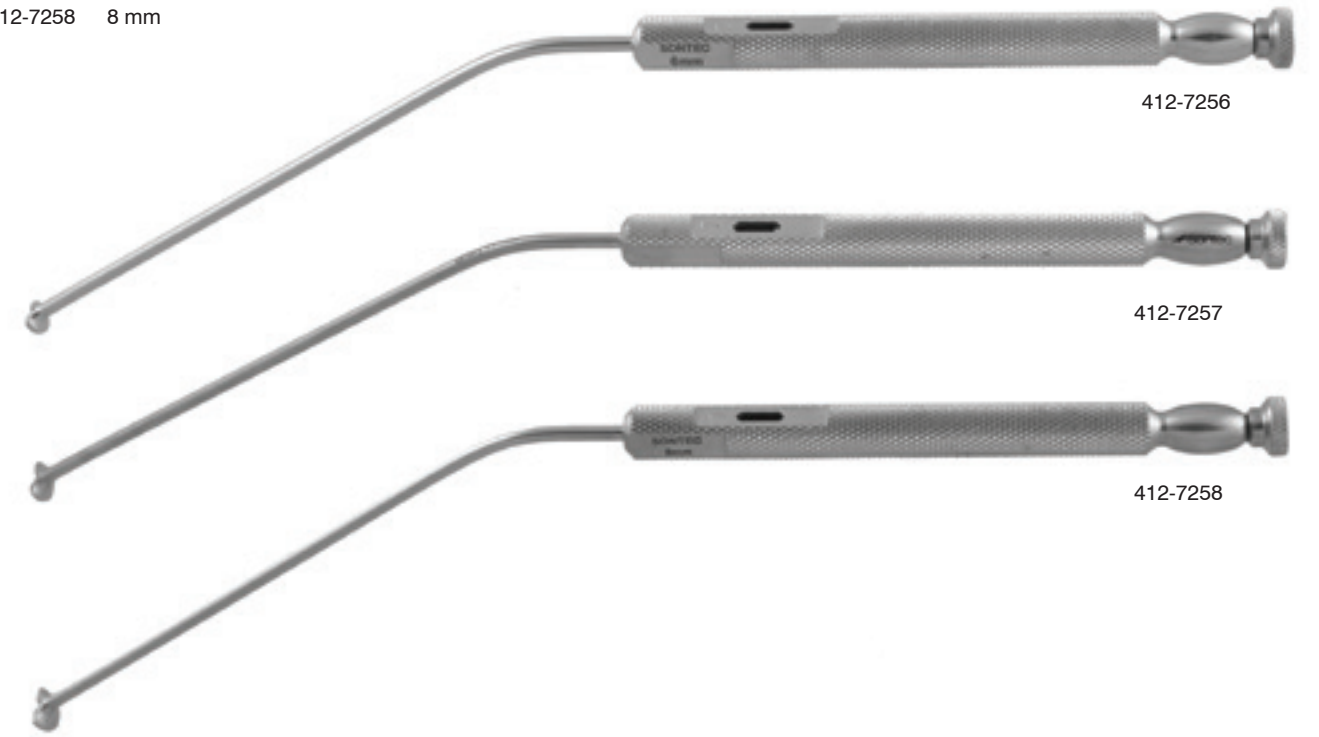

Papavero Cannula Suction

Angled / 7" (18 cm)

- 412-671 8 french



Rosen Suction Tips

Luer LK Angle / overall length 100mm / 65 mm working length

- 412-737-11 11 gauge
- 412-737-13 13 gauge
- 412-737-14 14 gauge
- 412-737-15 15 gauge
- 412-737-16 16 gauge
- 412-737-17 17 gauge
- 412-737-18 18 gauge
- 412-737-19 19 gauge
- 412-737-20 20 gauge
- 412-737-21 21 gauge
- 412-737-22 22 gauge
- 412-737-24 24 gauge
- 412-737-25 25 gauge
- 412-737-26 26 gauge

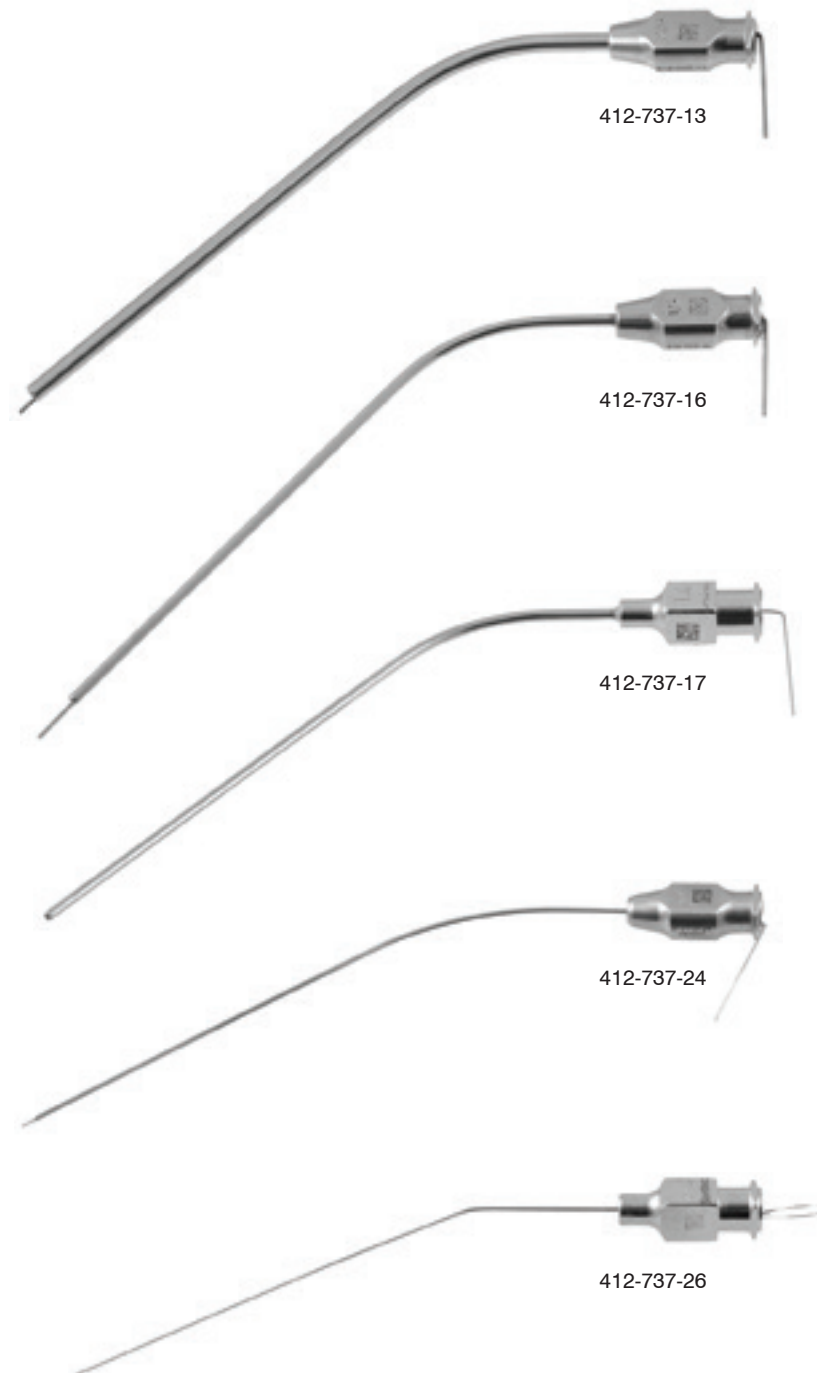

Wullstein Ear Suction Tube

7" working length / 9 1/4" overall length

- 412-738-11 11 FR O.D. x 8 FR I.D.
- 412-738-12 12 FR O.D. x 9 FR I.D.
- 412-738-13 13 FR O.D. x 10 FR I.D.

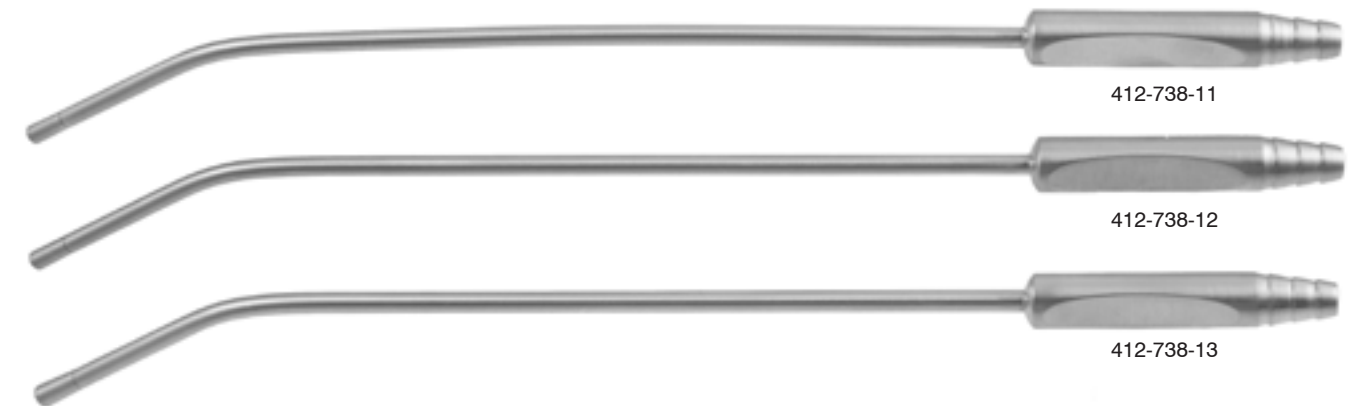

House Cutoff Suction Adapter

2" (5 cm)

412-738-50

Universal handles are necessary for Rosen and Schmidt Suction tubes



412-738-50

Kurtz Cutt-Off Suction Adapter

2.2" (5.5 cm)

- 412-738-55 chrome plated
- 412-738-55S stainless steel

Universal handles are necessary for Rosen and Schmidt Suction tubes



412-738-55



412-738-55S

Wullstein Suction Handle

4 1/4" (11 cm)

412-738 male luer coupling 3mm

Universal handles are necessary for Rosen and Schmidt Suction tubes



412-738

Schmid Suction Tips

6" (15 cm)

- 412-736-1
- 412-736-2
- 412-736-3
- 412-736-4

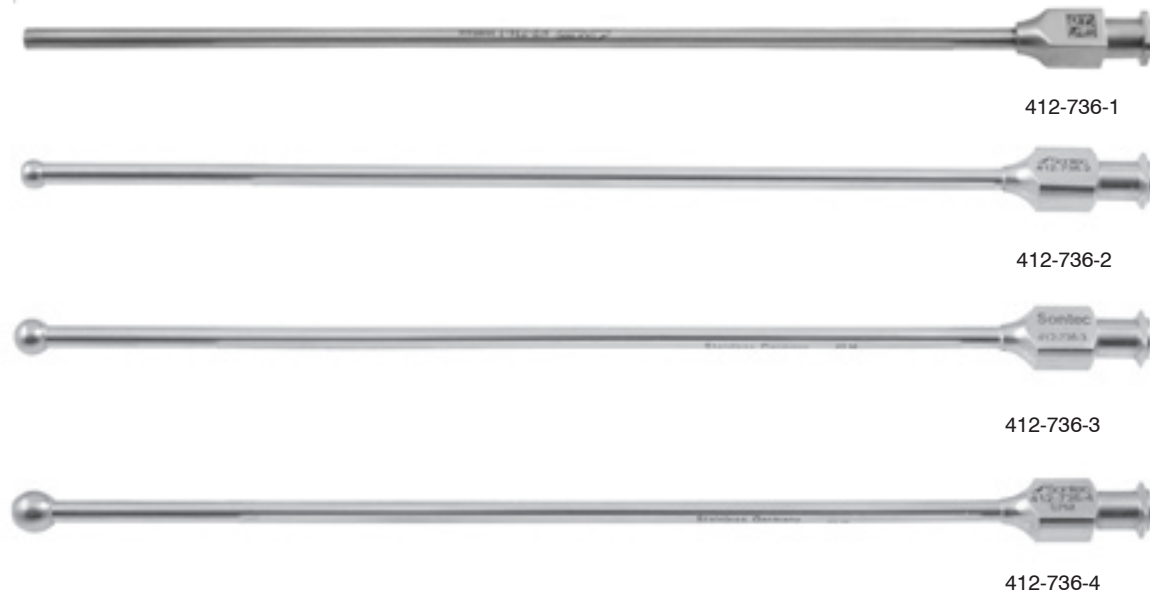

Suction Irrigation Tube

5 mm / with stylet / 8" (20 cm)

- 412-830 4 french x 8 french



House-Baron Suction

With multi port / 5" (12.5 cm)

- 412-728 5 french
- 412-728B 7 french

7" (18 cm)

- 412-729 5 french
- 412-729B 7 french

11" (28 cm)

- 412-727A 5 french
- 412-727B 7 french



House Irrigator/Suction

With thumb plate and cutoff (bypass hole) / 70mm working length / 4 1/2" (11.5 cm)

- 412-715A 2.5 french x 4 french
- 412-715C 4 french x 5 french

85mm working length / 5" (13 cm)

- 412-715 2 french x 2.5 french

95mm working length / 5 1/2" (14cm)

- 412-715B 2.5 french x 4 french
- 412-7151B 3 french x 4 french
- 412-715D 4 french x 5 french
- 412-716 5 french x 7 french
- 412-716A 6 french x 8 french
- 412-717 7 french x 10 french
- 412-718 8 french x 12 french
- 412-719 12 french x 14 french

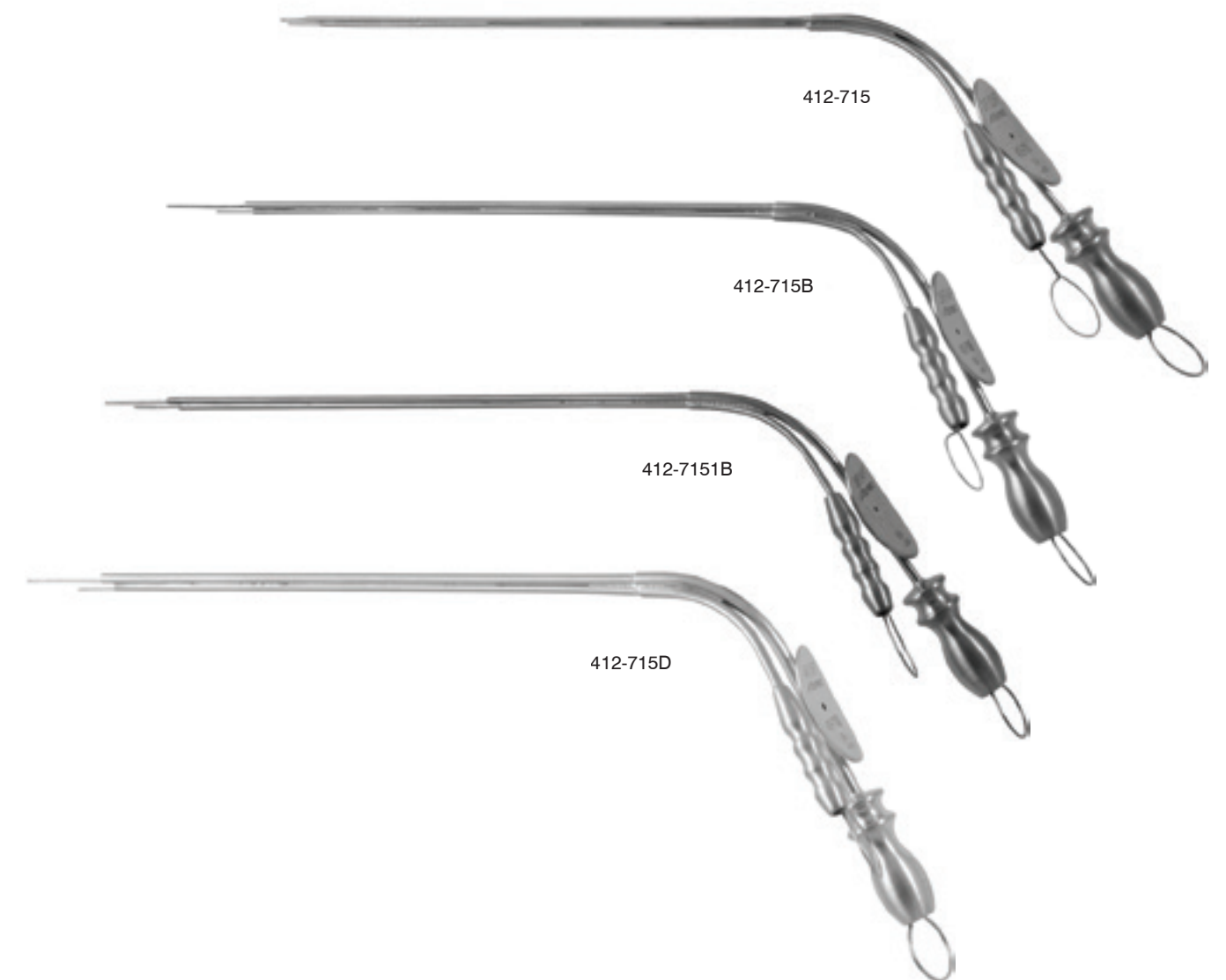

Sontec Micro Pediatric Suction

For pediatric Use

| | | | | |
|----------|-----|---------|-----------------|--------|
| 2700-300 | 40° | 3.25 mm | long fluted tip | 4 1/4" |
| 2700-301 | 45° | 3.25 mm | fluted tip | 4 3/4" |
| 2700-302 | 40° | 5 mm | fluted tip | 4 3/4" |
| 2700-304 | 55° | 7 mm | fluted tip | 4 3/4" |
| 2700-306 | 50° | 3.25 mm | fluted tip | 4 1/4" |

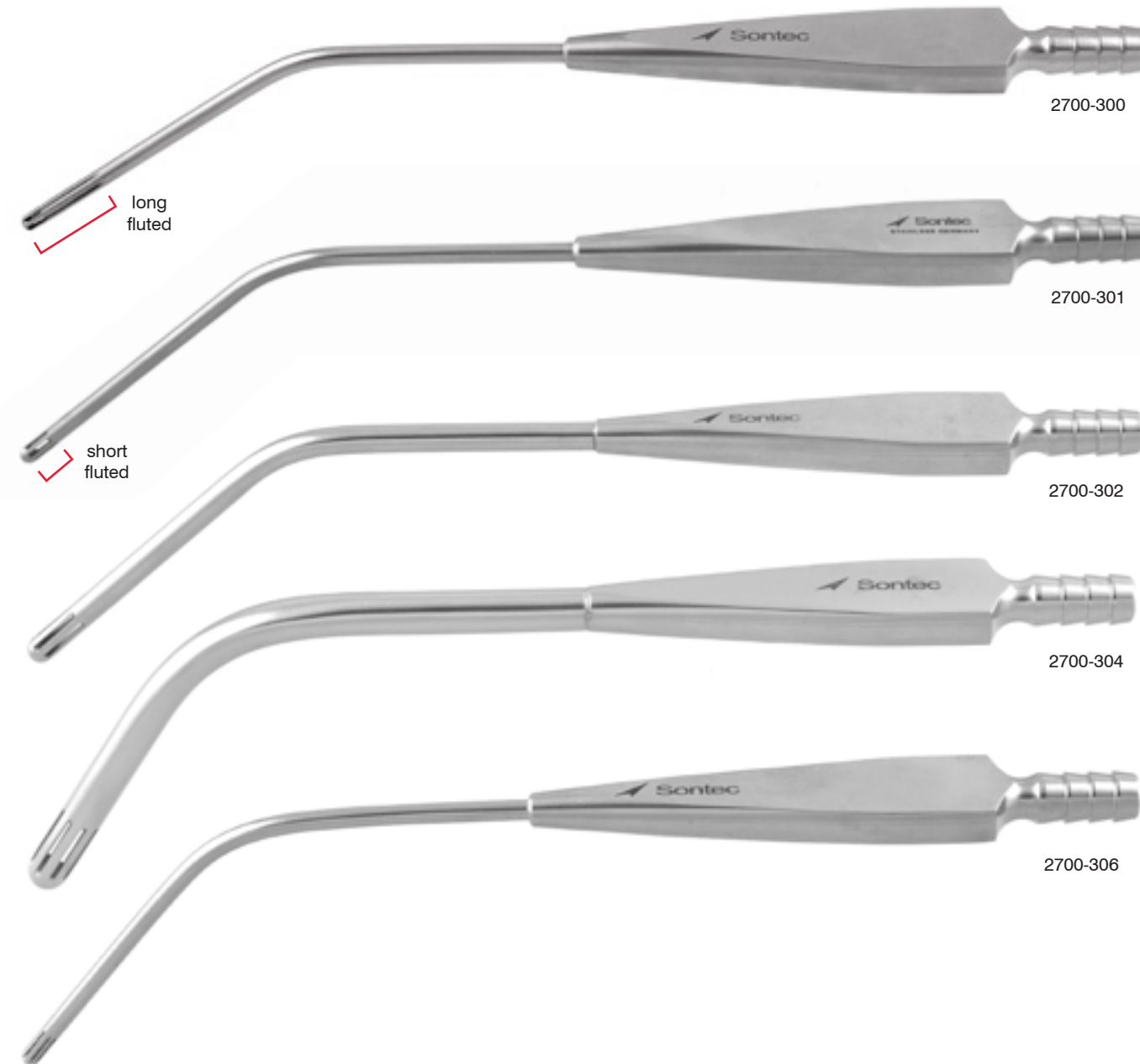

Sontec Micro Pediatric Suction

For pediatric use / removable fluted tip

| | | | |
|-----------|-----|-------------|--------|
| 2700-301R | 45° | 3.25 mm tip | 4 3/4" |
| 2700-303R | 45° | 3.25 mm tip | 3 1/4" |



Sontec Micro Pediatric Suction

For pediatric use / removable fenestrated tip

- 2700-307R 45° 5 mm tip 3 3/4"
- 2700-308 55° 3.5 mm tip 3 3/4"
- 2700-308R 45° 3.5 mm tip 3 1/2"



2700-307R



2700-308R



2700-308

Andrews Pynchon Suction

Stainless / 9 1/2" (24 cm)

- 180-432 3.0 mm
- 180-433 4.2 mm
- 180-436 5.0 mm standard

Chrome handle / standard 5 mm / 9 1/2" (24 cm)

180-439



180-432

Anthony Suction

4 mm tip / 10" (25.5 cm)

180-440



180-440

Braun-Ralph Suction

5mm suction tube / 70° angle with 7 mm Ø 40 mm long fluted tip / 10" (25.5 cm)

2700-309



2700-309

Yankauer Suction

Chrome / 11 3/4" (30 cm)

180-447

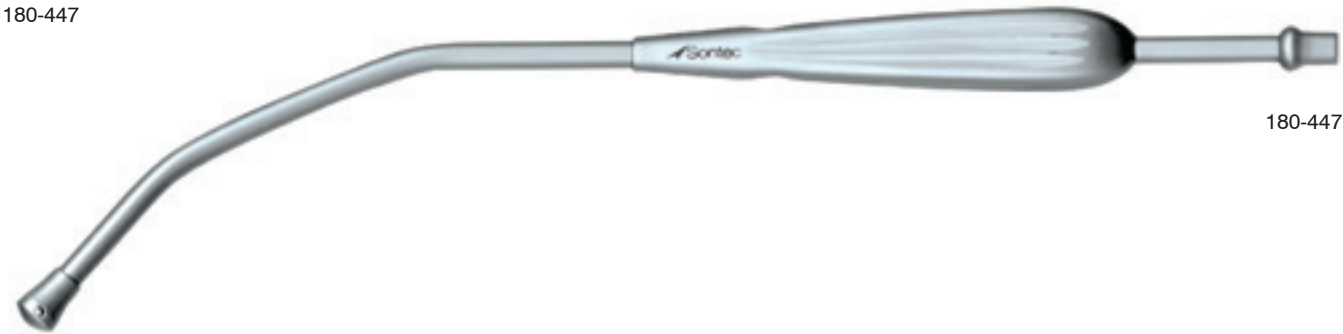

Stainless Steel / 11 3/4" (30 cm)

180-448



With universal fiber optic light guide / stainless steel / 11 1/4" (28.5 cm)

180-449 2mm



Stainless steel / 16" (41 cm)

180-451 2mm



Heartline Ross Sump Sucker

Swivel head

2700-390 adult 4.8mm x 7.5mm O.D. x 43mm length
 2700-392 child 4.8mm x 6.5mm O.D. x 32.5mm length
 2700-394 infant 3.2mm x 5mm O.D. x 22.5mm length



Heartline Ross Ventricular Vent

Swivel head

2700-395 adult 4.8mm x 7.5mm O.D. x 51mm length
 2700-396 child 4.8mm x 6mm O.D. x 37.5mm length
 2700-397 infant 3.2mm x 5mm O.D. x 24mm length



Poole Suction

8 3/4" (22 cm)

180-424 cvd 23 french
 180-422 str 30 french



Baby Poole Suction

Curved / 17 french / 8" (20.3 cm)
180-420



180-420

Poole Suction Deluxe

With cut off valve / 30 french / 10 1/4" (26.04 cm)
180-427



180-427

Buie Suction Tube

With finger valve / 16" (40.5 cm)
508-523 15 french



508-523

Adson Suction

Curved tip
412-720 12 french 5" (12.5 cm)
412-724 12 french 8" (20 cm)



412-720

Killian (Von Eicken) Suction

Curved / 6" (15 cm)
412-815 4 mm end short curve
412-810 4 mm end full long curve
412-805 3 mm end short curve
412-800 3 mm end long curve



412-805



412-800



412-815



412-810

Sontec Perfusion Cannula Suction

For pediatric Use

- 412-740 style #1
- 412-741 style #2

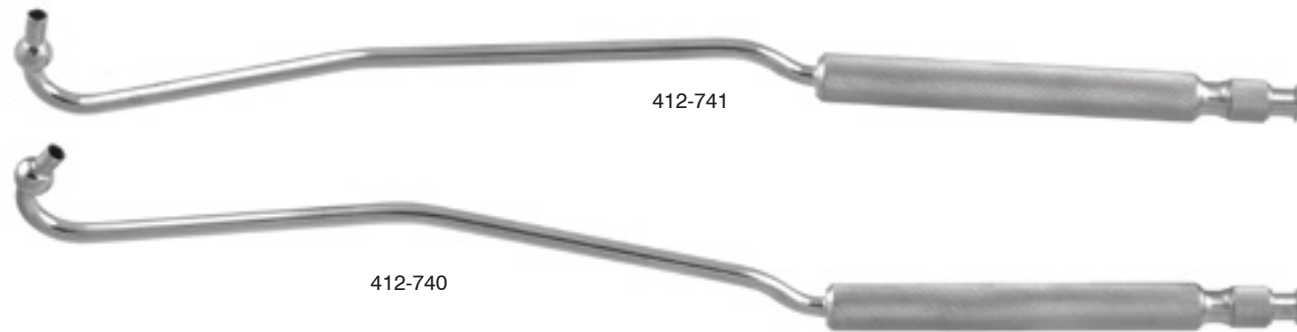

Coupland Suction Set

6 1/2" (16.5 cm)

412-672-SET
set includes:

- 412-673 tip #1 1.5 mm wide
- 412-674 tip #2 2.0 mm wide
- 412-675 tip #3 2.5 mm wide
- 412-676 tip #4 3.5 mm wide
- 412-672H handle

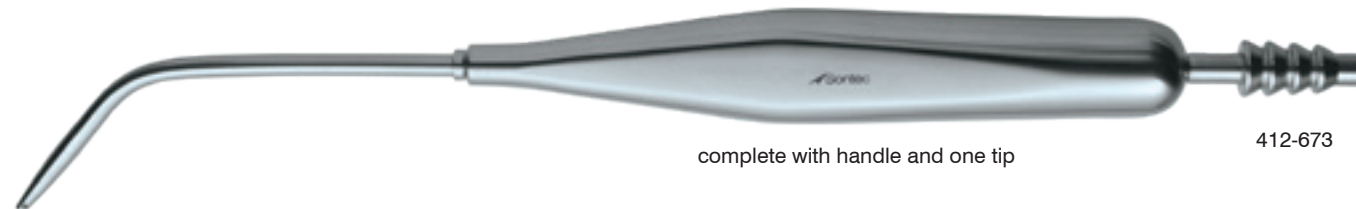

Pashley Pipe Suction Tube Holding Device

1463-461





 Sontec Instruments®

Orthopedic BONE HOLDING CLAMPS

Verbrugge Bone Clamp

Curved to side / with speedlock

- 1103-070 6" (15.5 cm)
- 1103-074 7 1/2" (19 cm)
- 1103-075 8 1/4" (21 cm)
- 1103-075D 8 1/4" (21 cm) delicate
- 1103-080 10" (25.5 cm)

Swivel jaw / curved to side/with speedlock

- 1103-071 5 3/4" (15 cm)
- 1103-073 8" (20.5 cm)
- 1103-077 9" (23 cm)
- 1103-078 10 1/4" (26 cm)
- 1103-079 11 1/4" (29 cm)



Verbrugge Bone Clamp

Ring handle / with ratchet

- 1103-068 7" (18 cm)



Verbrugge Bone Clamp

Reverse jaw / curved to side / with speedlock

| | |
|-----------|-----------------|
| 1103-071J | 5 3/4" (15 cm) |
| 1103-073J | 8" (20.5 cm) |
| 1103-077J | 9" (23 cm) |
| 1103-078J | 10 1/4" (26 cm) |
| 1103-079J | 11 1/4" (29 cm) |

Reverse speed lock and jaw / curved to side

| | |
|-----------|-----------------|
| 1103-071L | 5 3/4" (15 cm) |
| 1103-073L | 8" (20.5 cm) |
| 1103-077L | 9" (23 cm) |
| 1103-078L | 10 1/4" (26 cm) |
| 1103-079L | 11 1/4" (29 cm) |



1103-071J



1103-071L

Ulrich Bone Clamp

With speedlock / straight

| | |
|-----------|-------------------|
| 305-367S* | 7 1/8" (18.25 cm) |
| 305-368 | 9" (23 cm) |
| 305-369 | 10 1/2" (27 cm) |

Curved to side

| | |
|-----------|-------------------|
| 305-365 | 5 1/4" (13.5 cm) |
| 305-365M* | 5 1/2" (14 cm) |
| 305-366 | 6 1/2" (16.5 cm) |
| 305-367* | 7 1/8" (18.25 cm) |
| 305-368A | 9" (23 cm) |
| 305-369A | 10 1/2" (27 cm) |

* micro jaws



305-365M



305-367



305-367S

Verbrugge-Rogalski Bone Clamp

With speedlock / 1.5 mm jaw / 4" (10 cm)
1103-069



1103-069

Kern Hybrid Bone Clamp

With speedlock / fenestrated head / 4 3/4" (12 cm)
305-344A



305-344A

Kern Bone Clamp

Fenestrated jaw / with ratchet
305-332 4 3/4" (12 cm)
305-334 5 1/2" (14 cm)
305-328 6 1/4" (15.9 cm)
305-338 7" (18 cm)
305-336 8 1/2" (21.5 cm)



Fenestrated jaw
Side view

With ratchet
305-347 13" (33 cm)



305-332



305-347

Stefan Mini Bone Holding Forceps

Curved / 4 mm opening / mini

- 1103-003 4" (10 cm) with speedlock
- 1103-004 4" (10 cm) with ratchet
- 1103-005 5 1/2" (14 cm) with ratchet

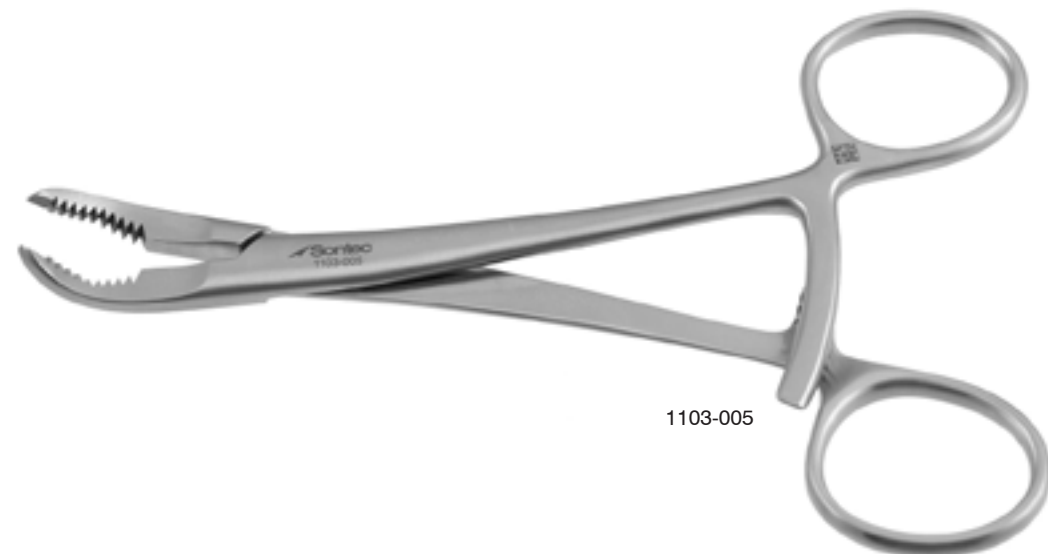

Stefan Bone Holding Forceps

Curved / with speed lock

- 1103-006 5 1/2" (14 cm)
- 1103-008 6" (15.5 cm)
- 1103-010 7" (18 cm)
- 1103-011 9 1/2" (24 cm)



Sequestrum Sontec Bone Forceps

Serrated jaws / 8" (20.3 cm)

- 1103-013 straight
- 1103-014 curved



Angus Bone Holding Forceps

6" (15.5 cm)

- 1103-015 with ratchet
- 1103-017 with speedlock



Taylor-Dingmann Bone Clamp

angled / 7 1/2" (19 cm)

- 1100-451 with speedlock
- 1100-452 with ratchet



Babcock Bone Holding Clamp

Angled / with ratchet / 7 3/4" (19.7 cm)
1103-065



1103-065

Mini Doolen Bone Holding Clamp

1.5 mm wide jaw / angled / 5" (12.7 cm)
1103-843 with speedlock
1103-844 with ratchet

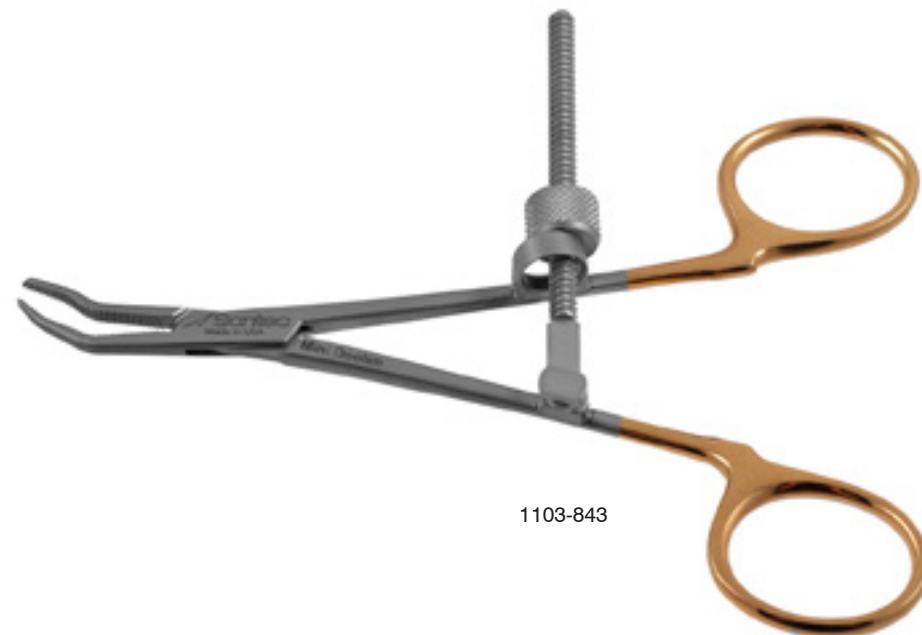

1103-843

Sesamoidectomy Bone Clamp

Strong curve / 6 1/2" (16.5 cm) / with ratchet
1103-050

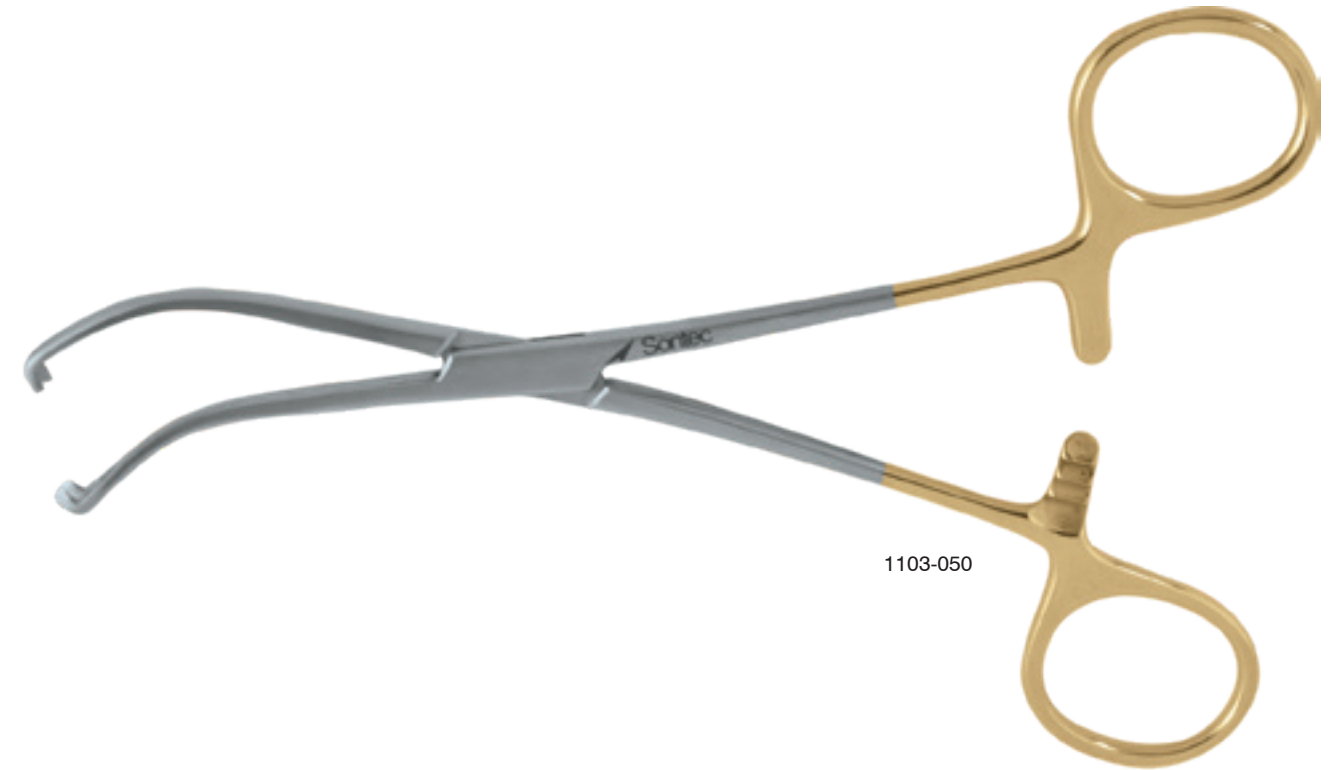

1103-050

Doolen Bone Holding Clamp

2mm wide jaw / 5.5" (14cm)

- 1103-845 str w/ speedlock
- 1103-846 ang w/ speedlock
- 1103-846R ang w/ ratchet

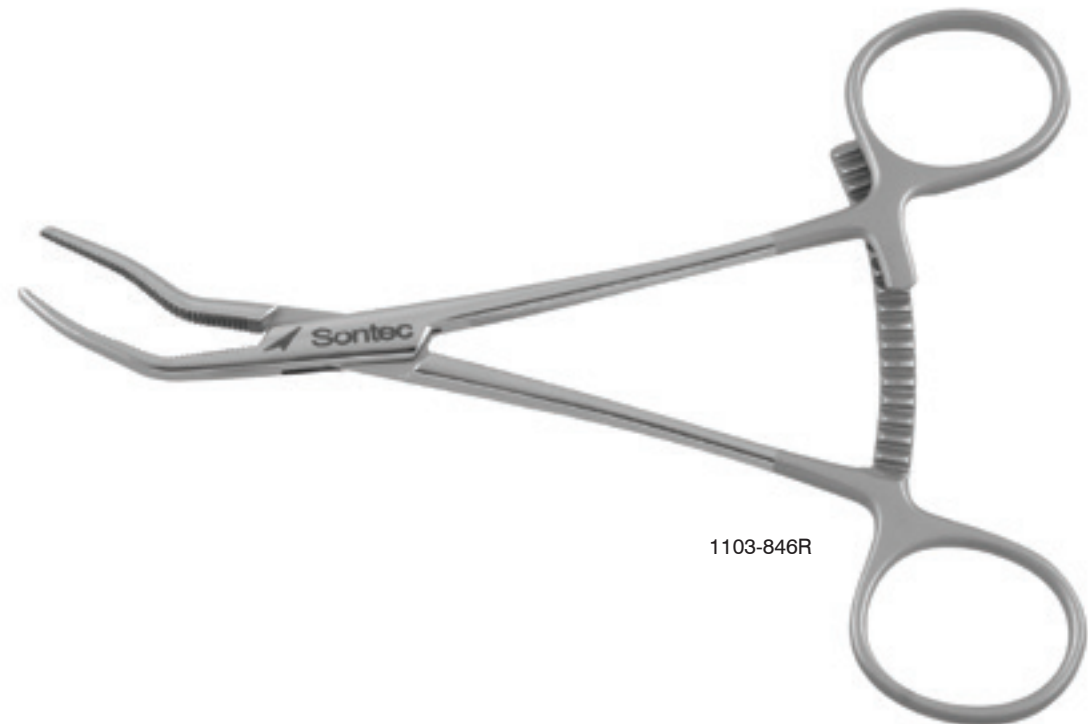
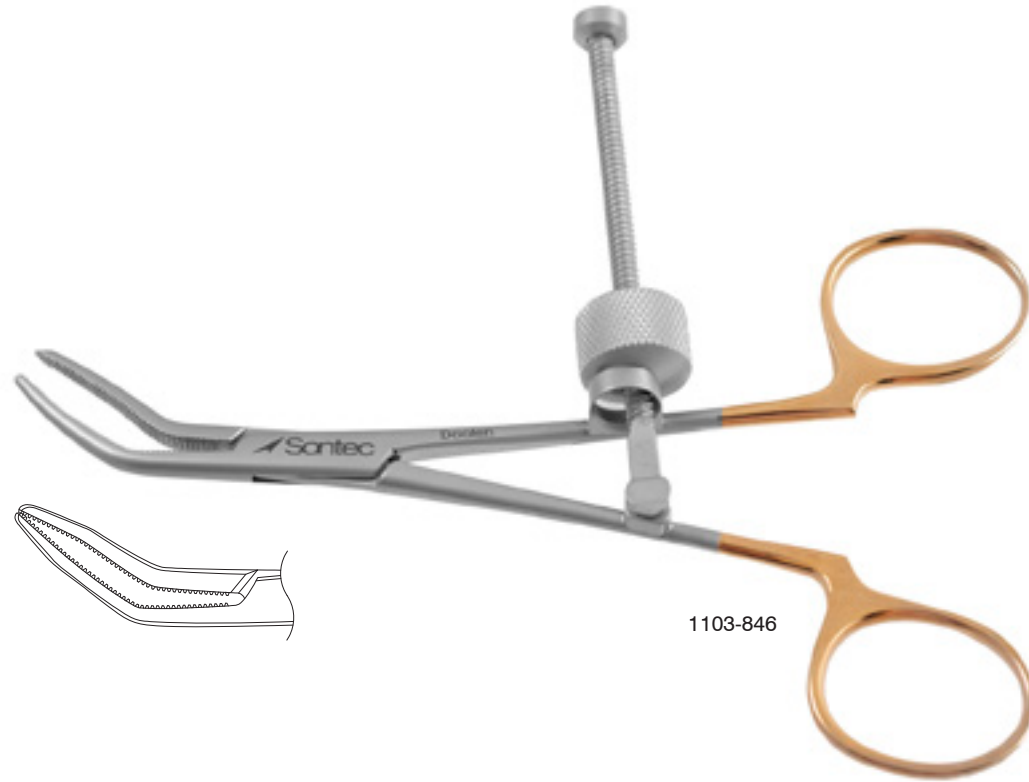

Doolen Bone Holding Clamp

3mm wide jaw / angle jaw / 7" (18 cm)

- 1103-856 with speedlock
- 1103-856R with ratchet

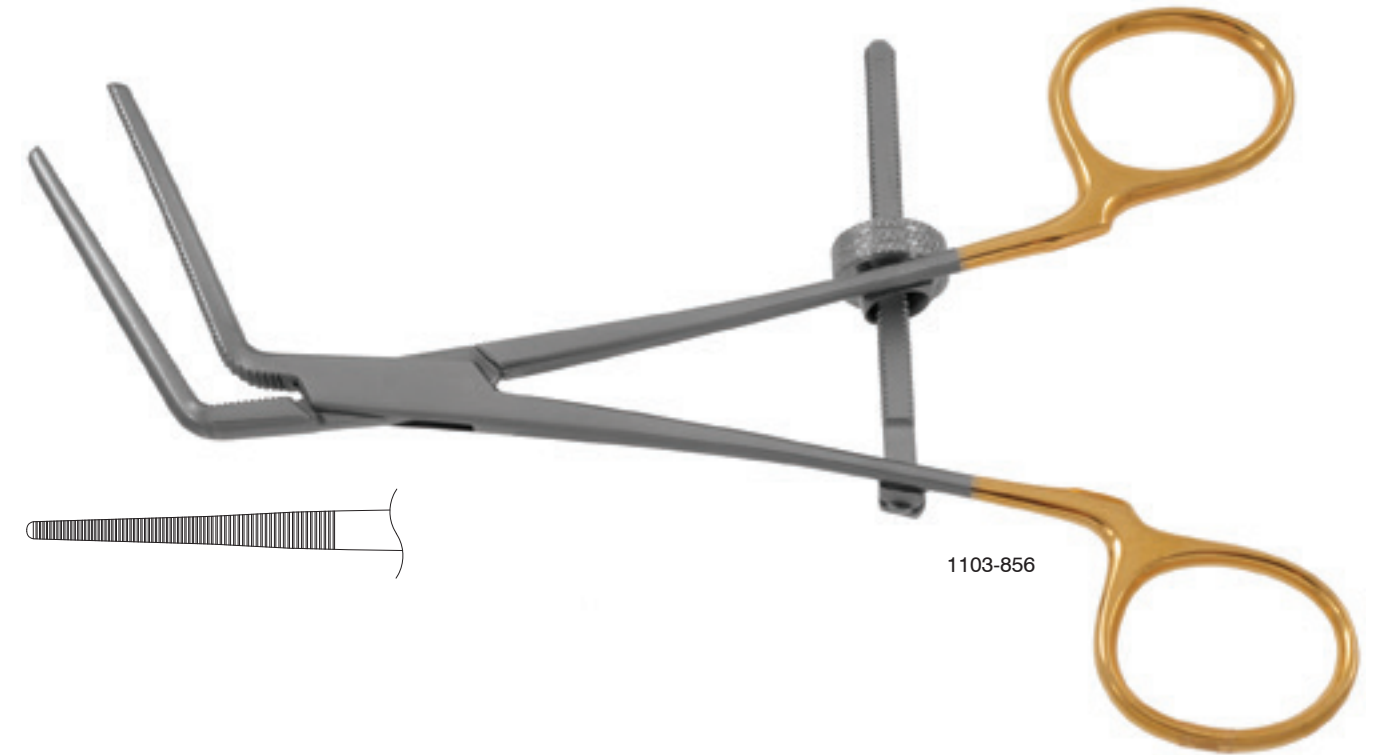

KUV Richards Bone Clamp

With ratchet / 9" (23 cm)

- 1103-067



Bishop Bone Clamp

With ratchet / 12 1/2" (31.8 cm)

305-380



Patella 2 x 2 Prong Bone Clamp

With speed lock / 7 1/4" (18.5 cm)

1103-215



Lowman Bone Holding Clamp

1 x 1 prongs

- 305-475 4 3/4" (12 cm)
- 305-480 7 1/4" (18.5 cm)
- 305-485 8" (20.5 cm)

1 x 2 prongs

- 305-460 4 3/4" (12 cm)
- 305-465 7 1/4" (18.5 cm)
- 305-470 8" (20.5 cm)

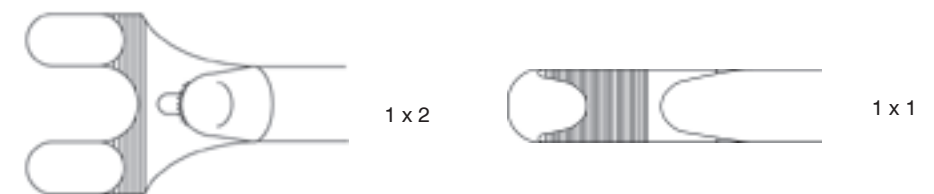

Lowman Bone Clamp

2 x 2 prongs on bone clamp

- 305-490 7 1/4" (18.5 cm)
- 305-495 8" (20 cm)



Lambert-Lowman Bone Holding Clamp

2 x 2 prongs / swivel jaw

305-496 7 1/4" (18.5 cm)

305-497 8" (20.5 cm)



Gersten Traction Bar

For Lowman Bone Clamps

305-505



Ulrich Swivel Jaw Bone Clamp

With speed lock / 10 1/2" (27 cm)

305-370 straight

305-370A angled

305-370B curved to side 1 x 2 prong





 Sontec Instruments®

Orthopedic BONE REDUCTION CLAMPS

Bone Reduction Clamp Extra Large

Oversized / extra-long ratchet / 12" (30 cm)

- 1103-049 extra-long prongs
- 1103-049L extra-long shanks



1103-049



1103-049L

AO-Type Bone Reduction Clamp

With speedlock / short tips

- 1103-051 8" (21 cm)

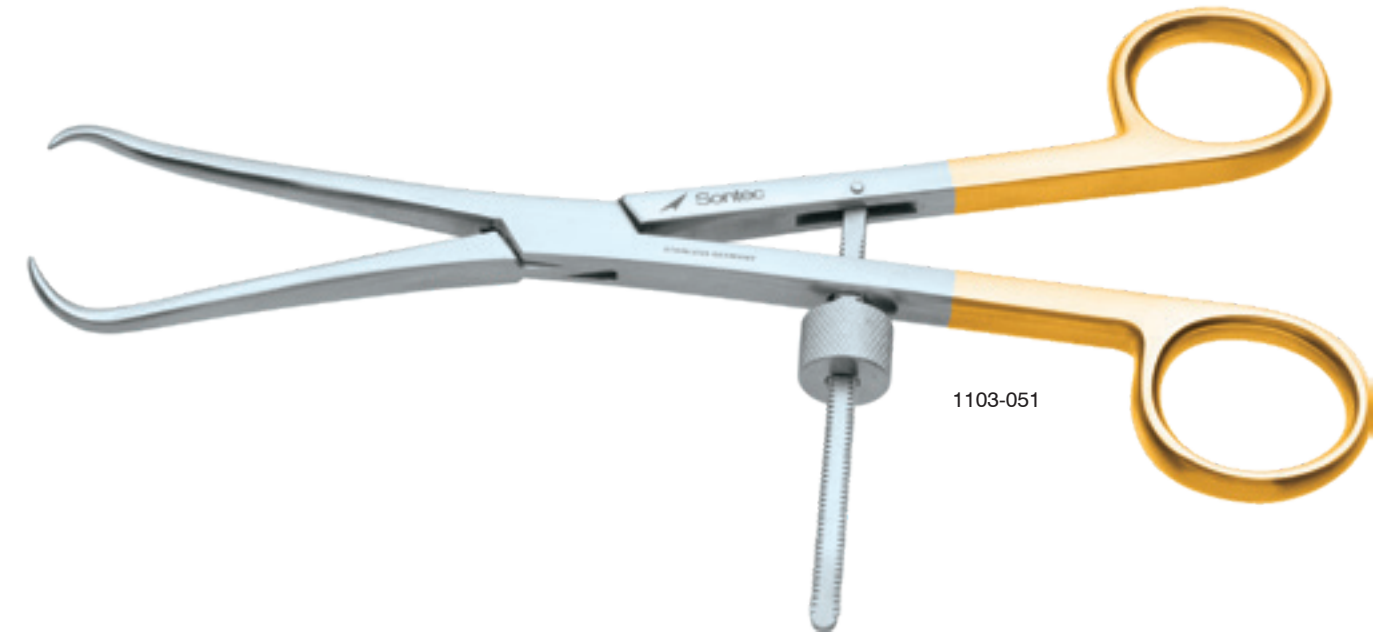

1103-051

Kistler Manus Bone Reduction Clamp

6 1/8" (15 cm)

- 1103-033



1103-033

Reil Bone Holding Forceps

Angled / 6 3/4" (17.1 cm)
1103-020

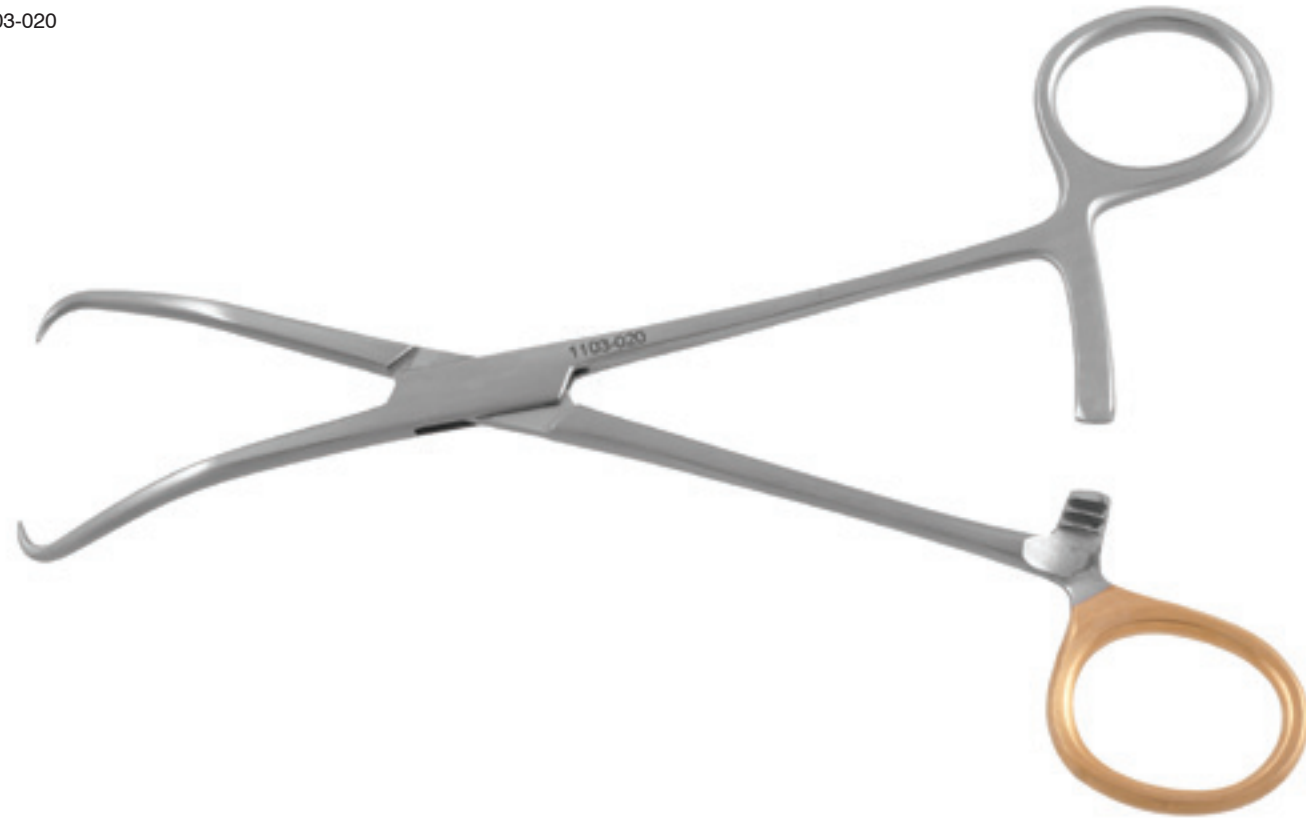

Bone Reduction Clamp

With speedlock
1103-039S 7" (17.8 cm)
1103-048 8" (20 cm)

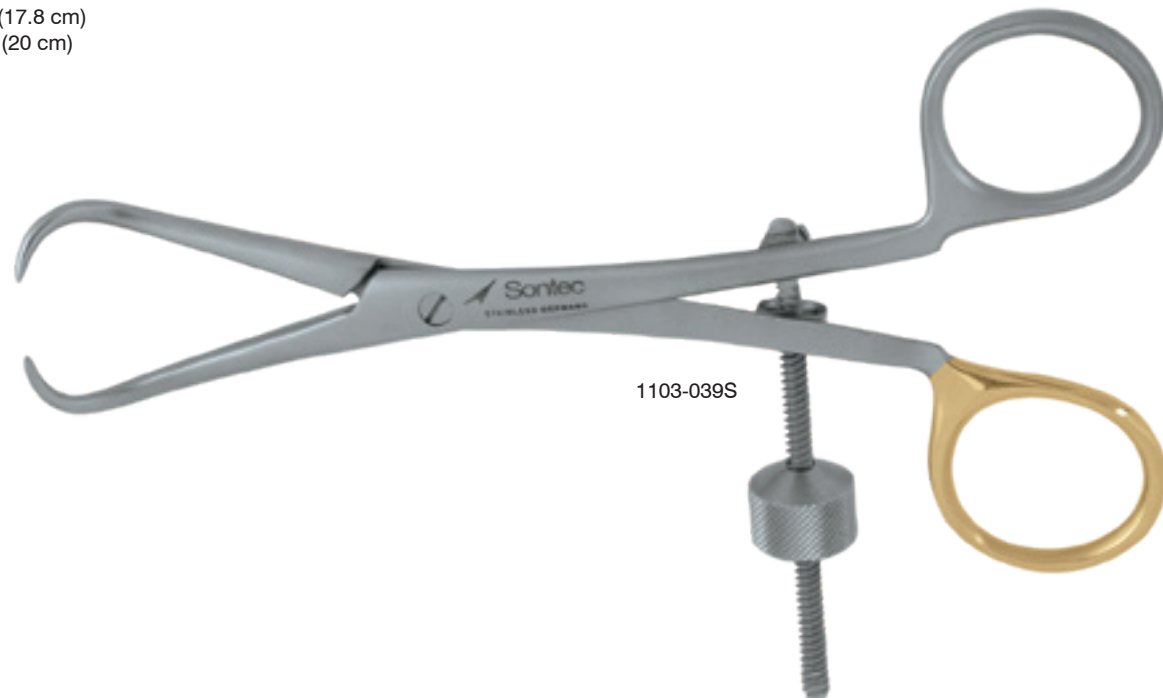

Bone Reduction Clamp

With ratchet
1103-039L* 6" (15 cm) long double ratchet
1103-039N* 7" (17.8 cm) long double ratchet
1103-045 8" (20 cm) extra long ratchet

* Other sizes available

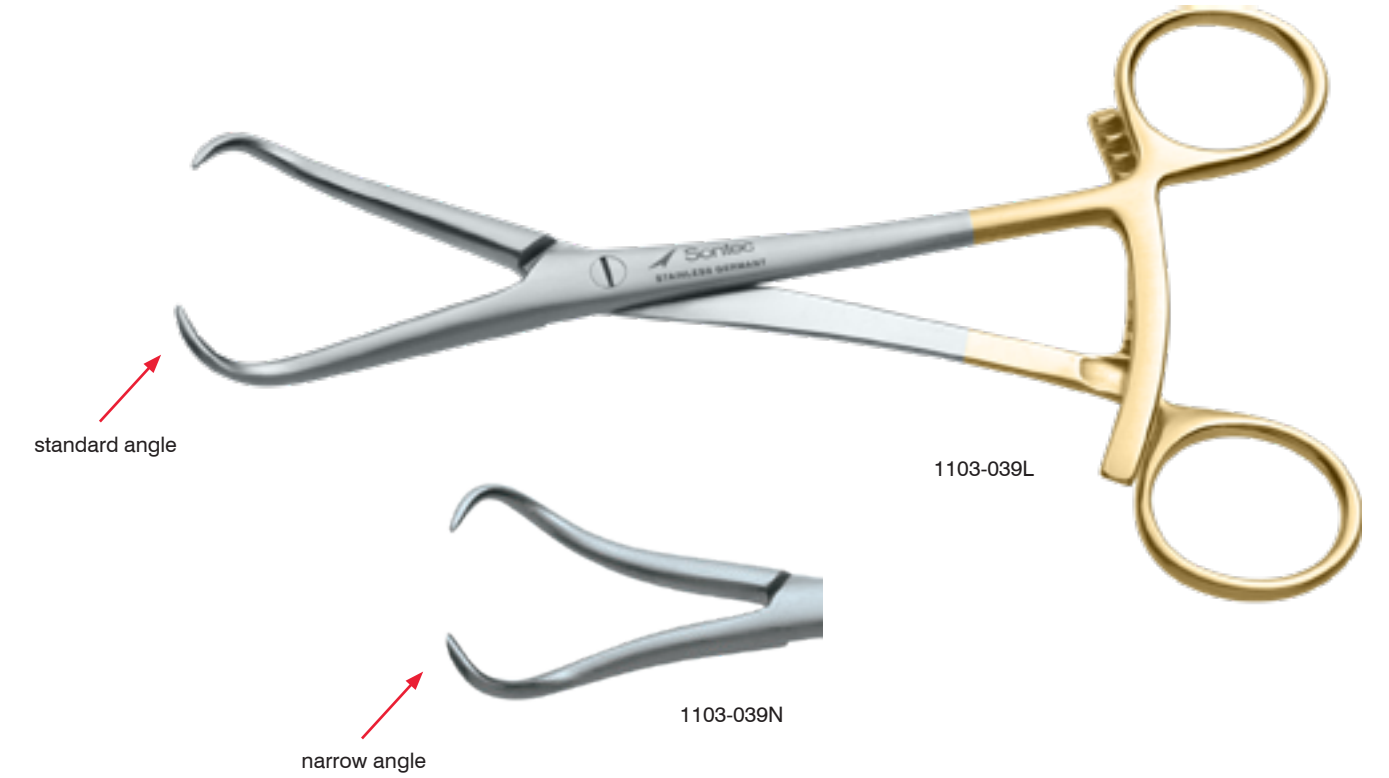

standard angle

1103-039L

narrow angle

1103-039N



1103-045

Kristler Manus Bone Reduction Clamp

With speed lock / serrated jaw / 6 1/8"

1103-0331



1103-0331

Bone Reduction K-Wire Guide Clamp

With double long ratchet / with 1.8 mm ID guide cylinder with serrated foot

- 1103-0391 with 10 mm k-wire guide 6" (15 cm)
- 1103-0453 with 12 mm k-wire guide 8" (20 cm)
- 1103-0454 with 15 mm k-wire guide 8" (20 cm)



1103-0453

Raleigh Bone Reduction Clamp

7 mm / 5 1/2" (14 cm)

- 1103-024 with ratchet
- 1103-023 with speed lock



1103-024

Locke Bone Reduction Clamp

With long ratchet / 4 mm / 6" (15.2 cm)

1103-027



1103-027

Locke CSU Bone Reduction Clamp

1x2 teeth tips with contoured serrated jaws / 6" (15 cm)

- 1103-021 straight with ratchet
- 1103-021A curved with ratchet
- 1103-023A curved with speedlock
- 1103-023B straight with speedlock

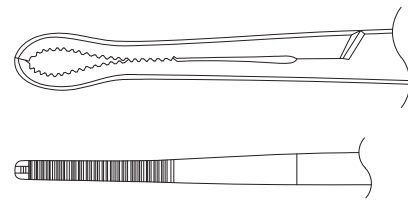
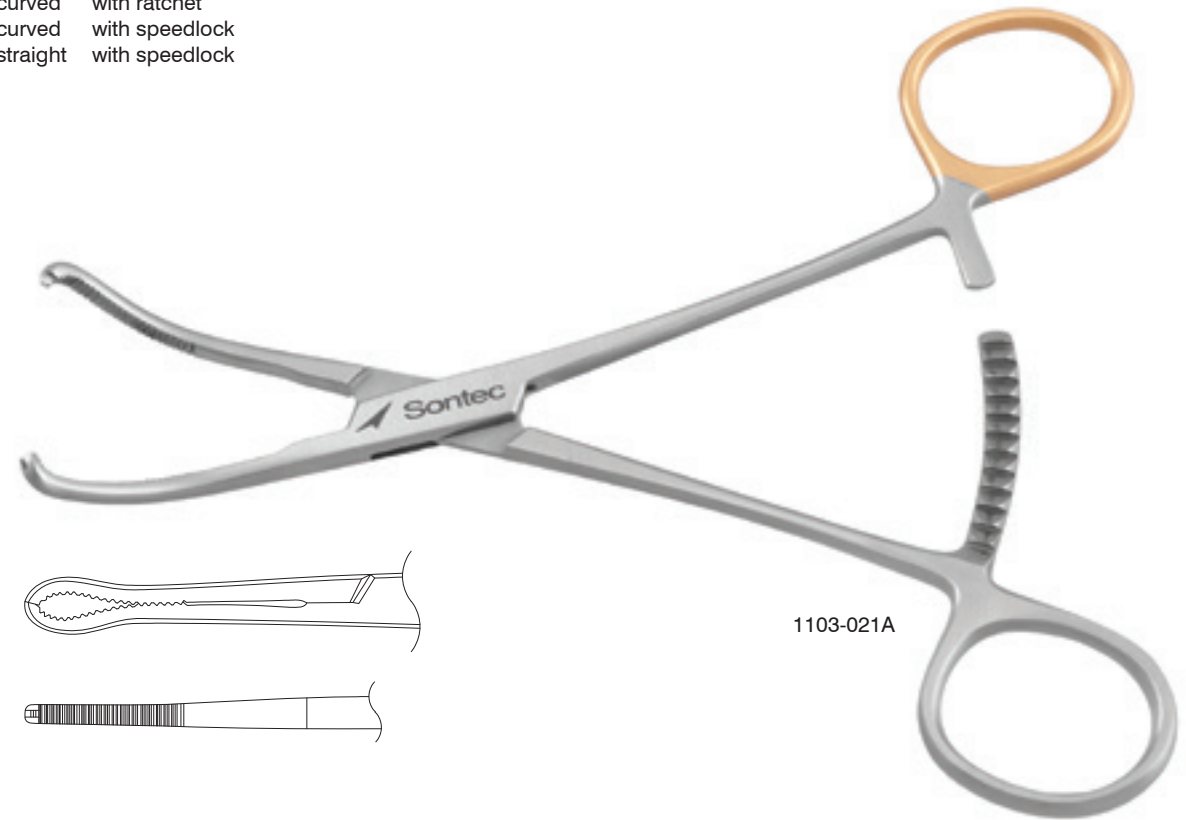

Raleigh Bone Holding Forceps

- 1103-040A 3 mm 5 1/2" with ratchet
- 1103-040B 5 mm 5 1/2" with ratchet
- 1103-040C 12 mm 7" with speedlock
- 1103-040AS 3 mm 5 1/2" with speedlock
- 1103-040BS 5 mm 5 1/2" with speedlock



Lewin Bone Reduction Clamp

Serrated

1100-426 7" (18 cm)
1100-426M 7 1/2" (19 cm) modified serrations

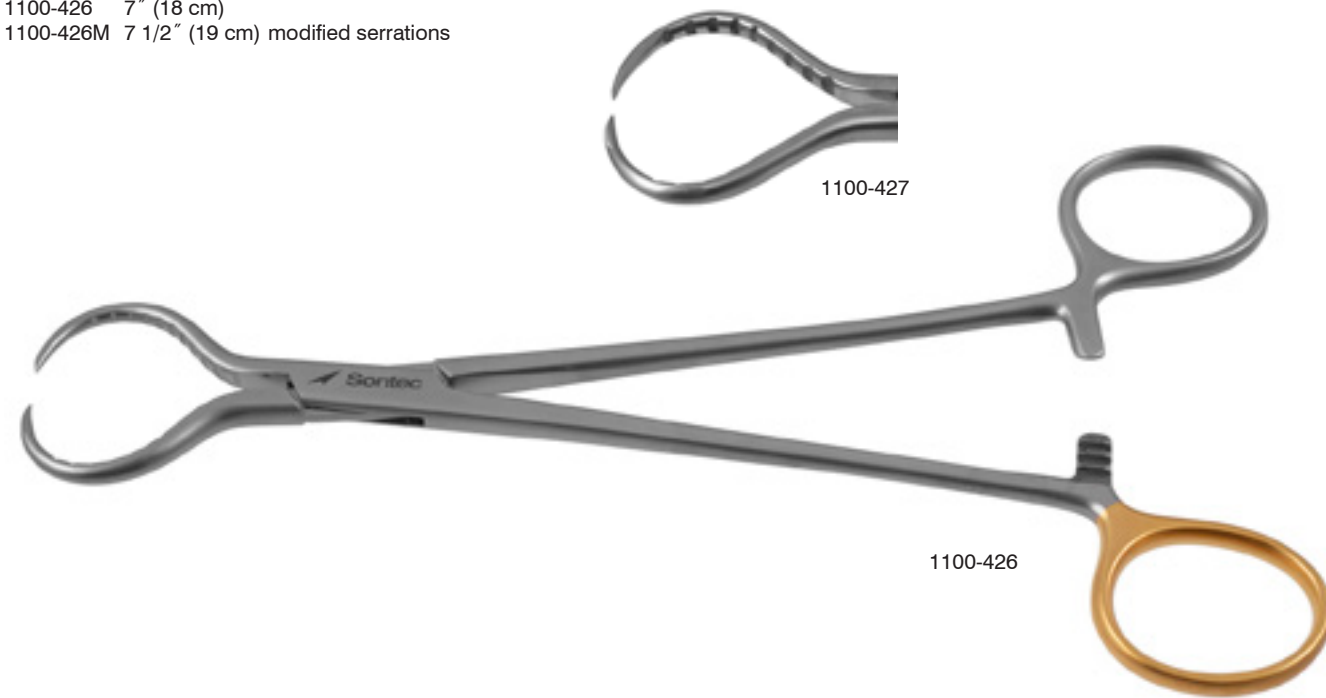

Bone Reduction Clamp

With K-wire guide / 5 1/4" (13.5 cm)

1103-044 with ratchet
1103-044S with speed lock

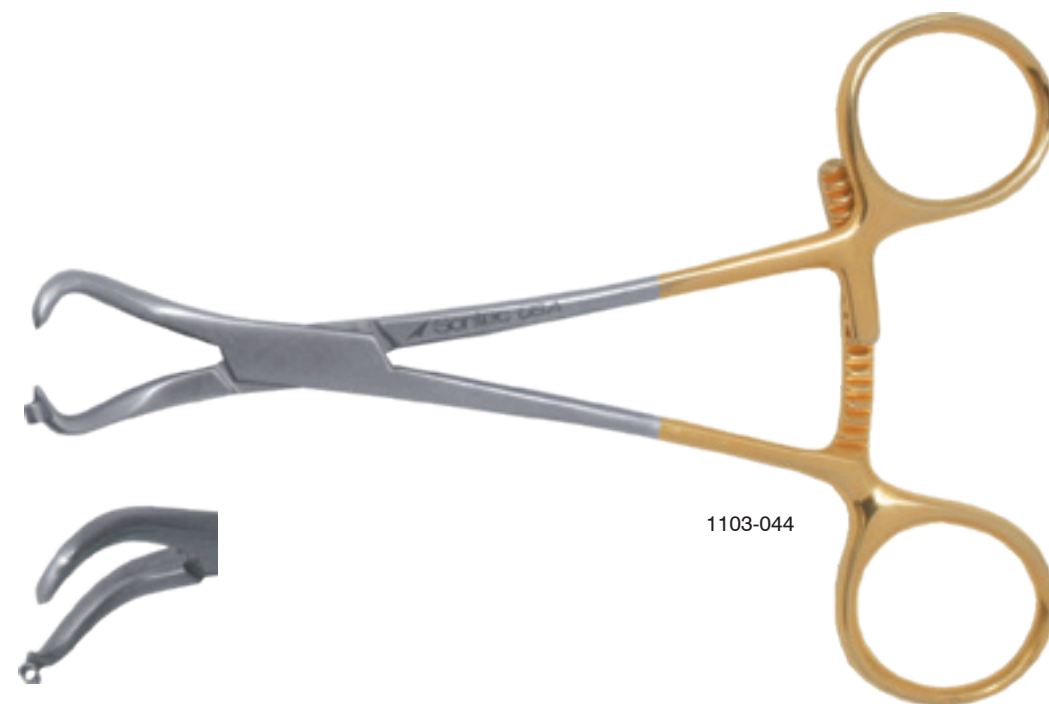

Bone Holding Forceps

With 0.9 mm K-wire guide / curved / 6 3/4" (17.1 cm)

1103-088 with ratchet

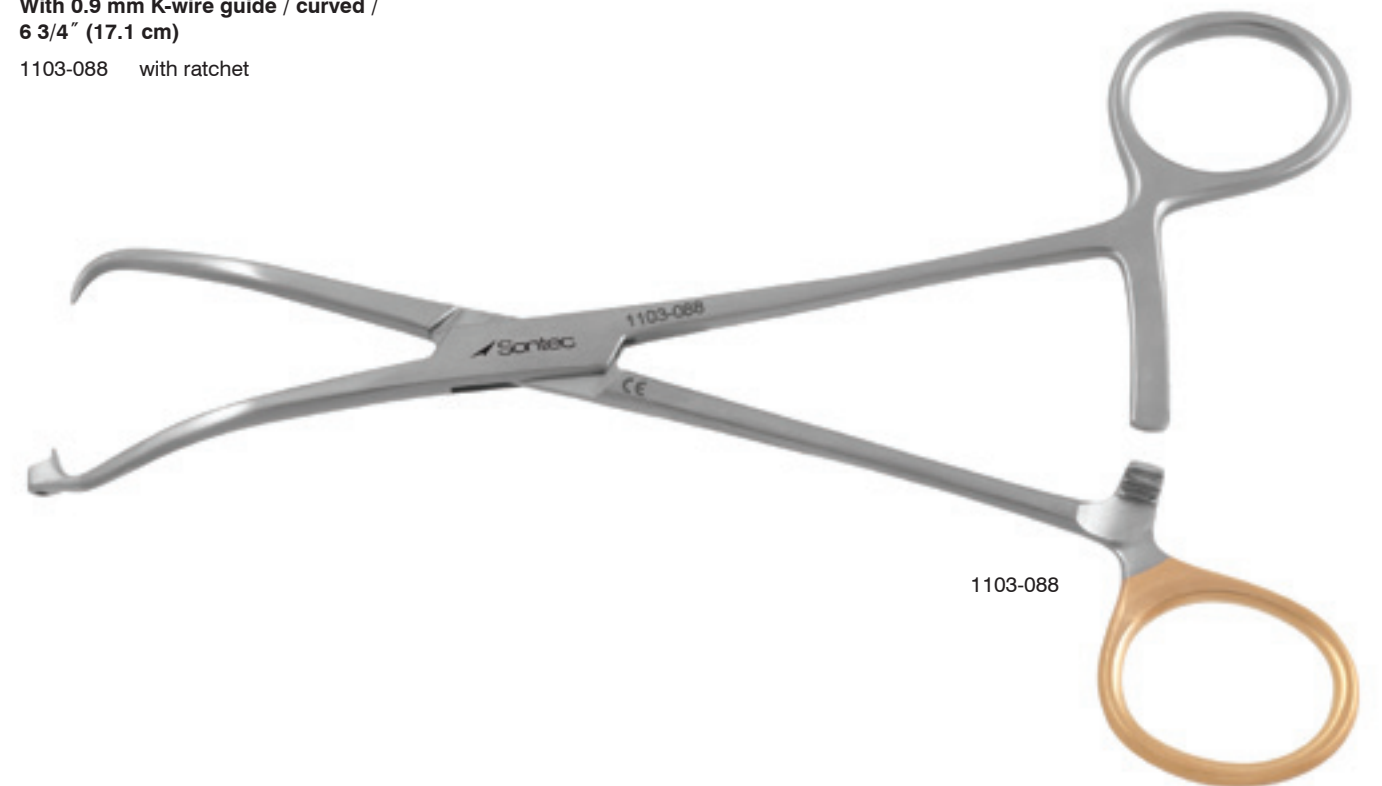

Deluxe Bone Reduction Clamp

Serrated jaws / with ratchet / 5 1/4" (13.3 cm)

1103-046

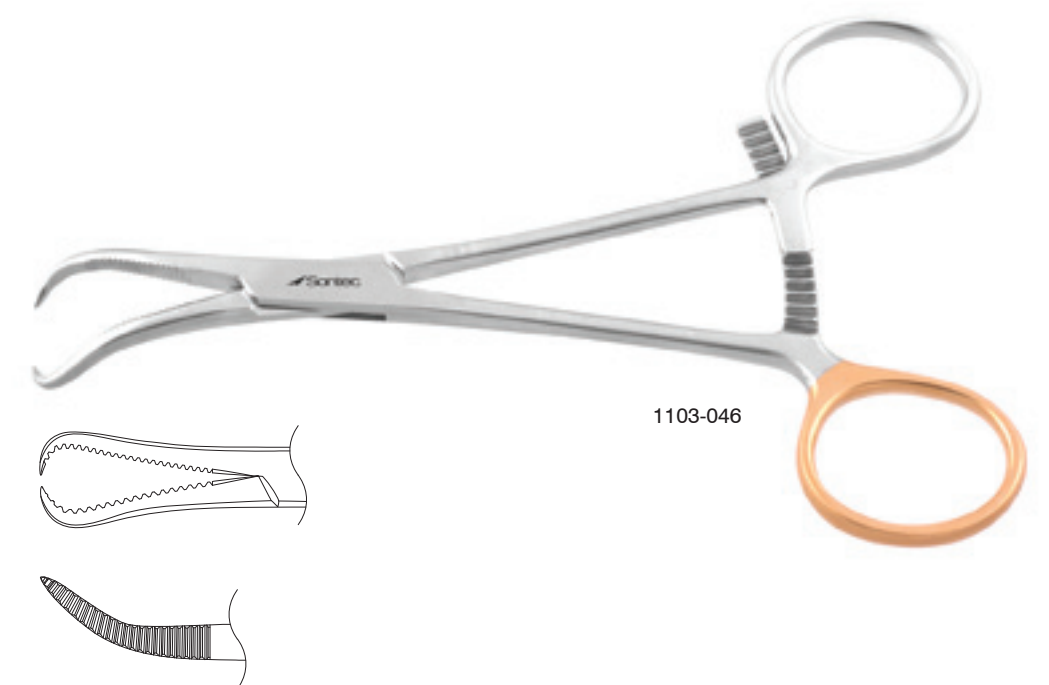

Bone Reduction Clamp

With extra long ratchet

- 1103-040 5 1/8" (13.25 cm)
- 1103-040R 5 1/8" (15.2 cm) longer ratchet
- 1103-042 7" (18 cm)

With speedlock

- 1103-041 5 1/8" (13.25 cm)
- 1103-0425 6 1/8"
- 1103-043 6 1/2" (16.5 cm)



1103-040



1103-0425

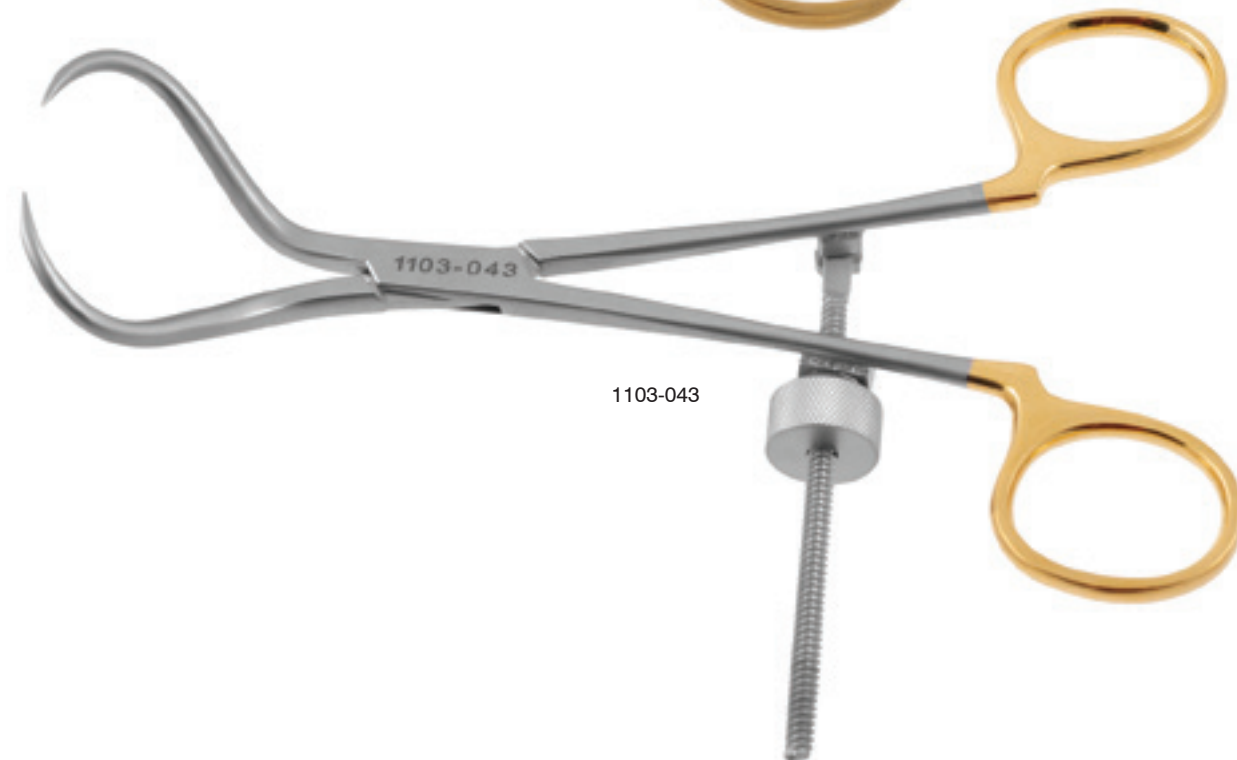

1103-043

Bone Reduction Clamp

AO types

- 1103-041A 8" (20.5 cm)
- 1103-041B 6" (15 cm)
- 1103-041C 10" (25.5 cm)

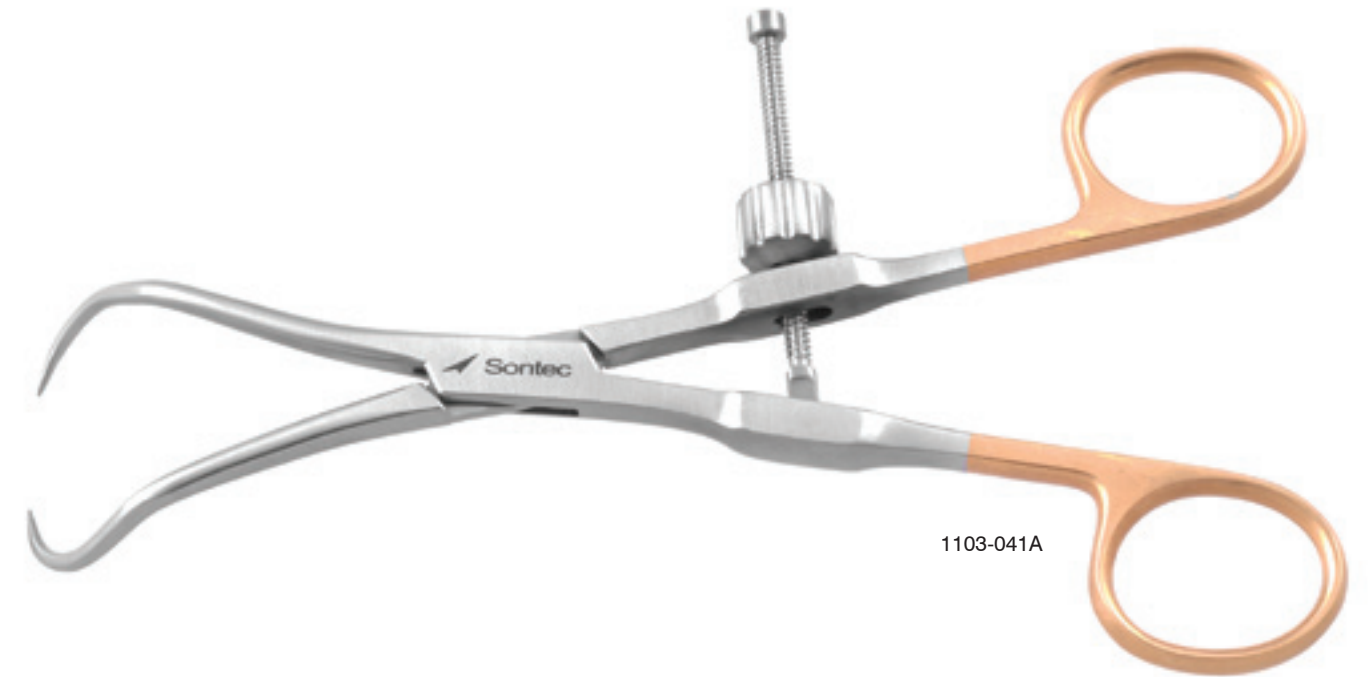

1103-041A



1103-041C

Ikuta Bone Clamp

5" (13 cm)

| | | |
|-----------|--------|----------|
| 1103-054A | 2.0 mm | straight |
| 1103-054B | 2.0 mm | curved |
| 1103-054C | 3.0 mm | straight |
| 1103-054D | 3.0 mm | curved |



1103-054C



1103-054D

Schroeder Vulsellum Bone Reduction Clamp

9 3/4" (24 cm)

| | | |
|----------|--------------|----------------|
| 1103-055 | str | with speedlock |
| 1103-056 | cvd | with speedlock |
| 1103-060 | str | with ratchet |
| 1103-061 | cvd up | with ratchet |
| 525-364 | cvd sideways | with ratchet |



1103-060



1103-055



525-364

Sontec®-Condial Reduction Clamp

8" (20.5 cm)

- 1103-036 speedlock
- 1103-036R ratchet



Micro Bone Reduction Clamp

- 1103-037 3 3/4" (9.5 cm) with plate holding tip
- 1103-037A 4 3/4" (12 cm)



Bone Reduction Clamp

- With speedlock / 3 3/4" (9.5 cm)
- 1103-037S



Redler Reposition Reduction Clamp

With K-wire guide / 1.6 mm / 5 1/4" (13.5 cm)
1103-031



1103-031

Plate & Bone Reduction Forceps

With long ratchet / 4 3/4" (12 cm)
1103-038



1103-038

Hip Reduction Clamp

With speed lock

- 1106-019 7 3/4"
- 1106-020 10"
- 1106-022 10" 3 balls spikes
- 1106-023 10" asymmetric 3 balls spikes
- 1106-024 10" asymmetric



1106-019



1106-022



1106-023



1106-024



Martin Cartilage Clamp

- 350-866 5 3/4" (14.6 cm)
- 350-867 6 1/2" (16.5 cm)
- 350-869 7" (18 cm)
- 350-871 8" (20 cm)



350-867

Bircher-Ganske Cartilage Clamp

- 8" (20.5 cm)
- 350-884 straight
- 350-885 curved



350-884

CSU Meniscus Clamp

- 5 3/4" (14.5 cm)
- 1103-204 str
- 1103-204A angled



1103-204



1103-204A

Sontec Meniscus Clamp

Serrated grooved jaws middle weight
/ 5 3/8" (13.5 cm)

- 1103-202 str
- 1103-203 angled

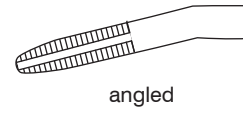

1103-202

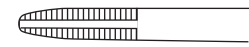

Sontec Delicate Meniscus Clamp

Heavy serrated jaws with gap / 5 3/8" (13.5 cm)

- 1103-202D straight
- 1103-203D angled



1103-202D

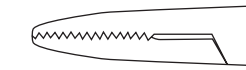

1103-203D

DeBakey Meniscus Clamp

Autraumatic jaw / 3 cm jaw / 5 1/2" (14 cm)

142-199 str



3.0 mm DeBakey tip

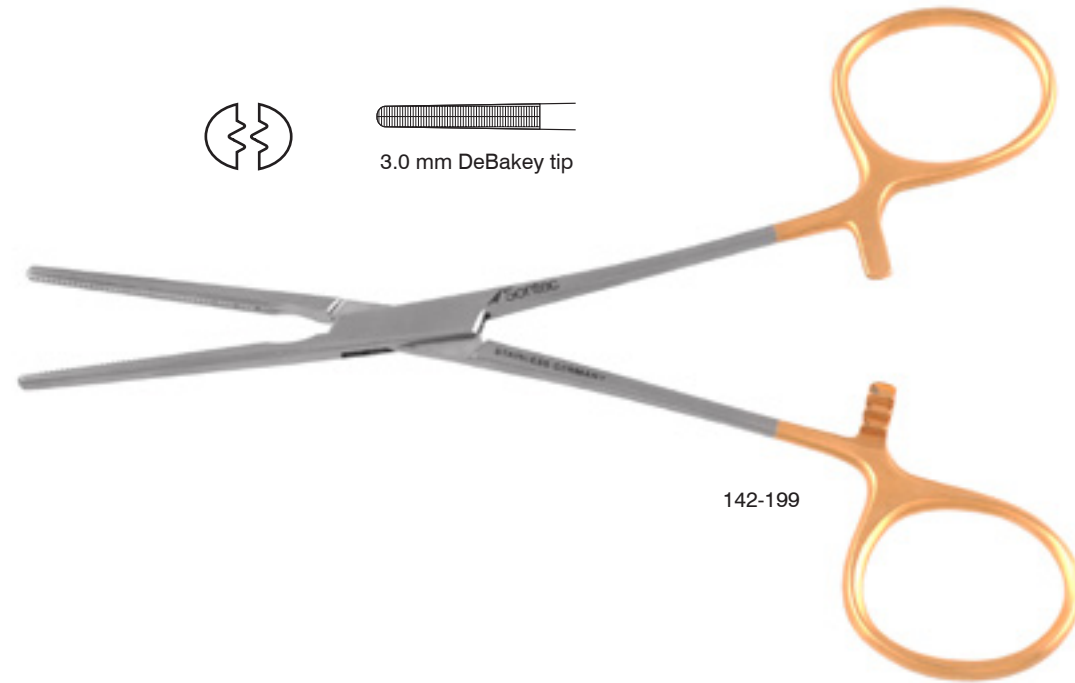

142-199

Sontec Mesh Meniscus Clamp

Fenestrated jaws / 7 1/4" (18.5 cm)

350-880 15 teeth with 1 x 2



350-880

DeBakey Mosquito Forceps

6" (15 cm)

2200-403 straight

2200-405 curved

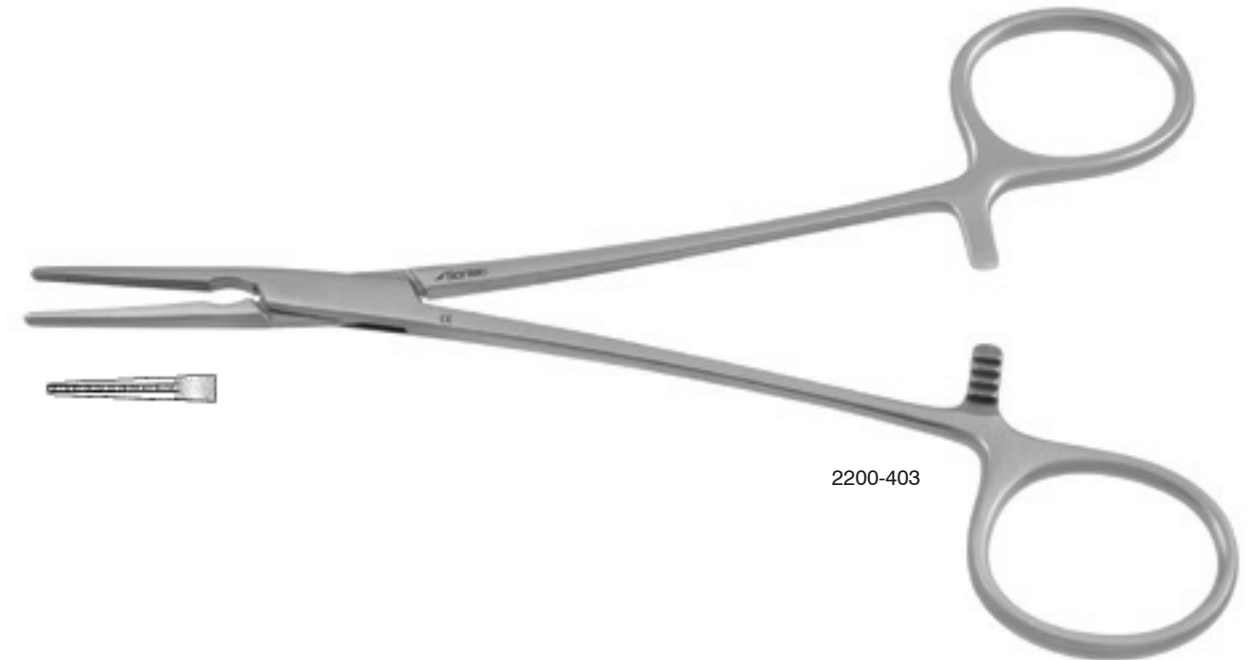

2200-403

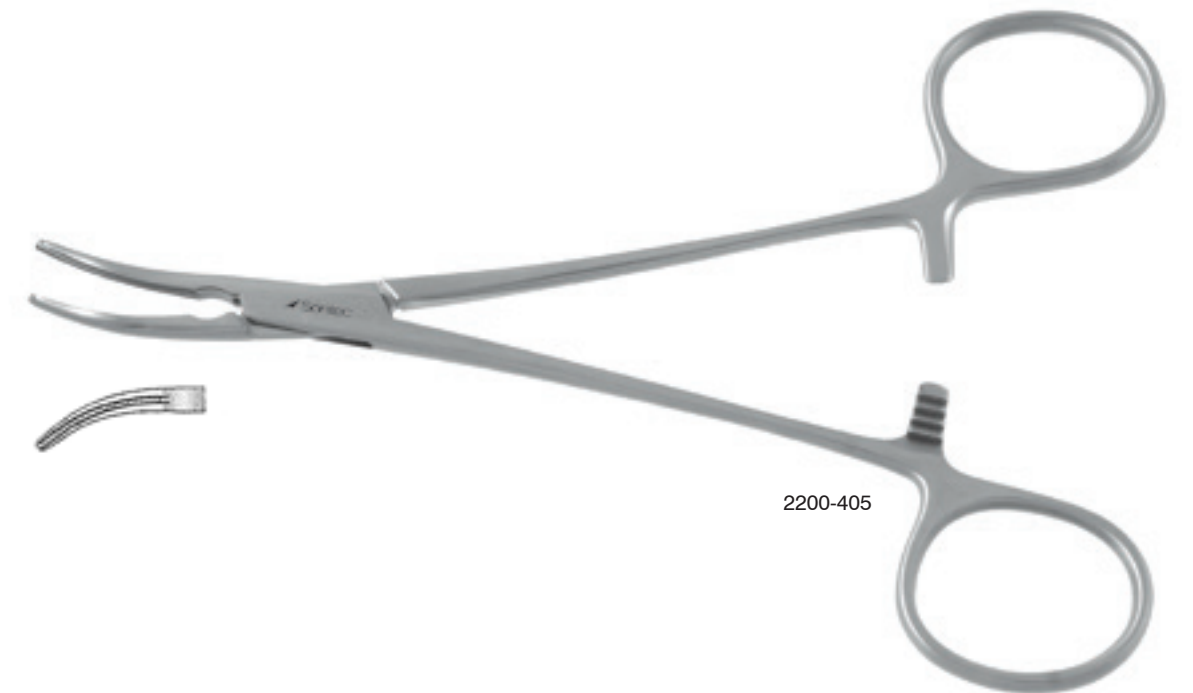

2200-405



 Sontec Instruments®

Orthopedic CURETTES

Stille Curette

Flat handle / round cup

| | | |
|----------|-------|--------|
| 1103-263 | 2 mm | 6 1/2" |
| 1103-264 | 3 mm | 6 1/2" |
| 1103-265 | 4 mm | 6 1/2" |
| 1103-266 | 5 mm | 7 3/4" |
| 1103-267 | 6 mm | 7 3/4" |
| 1103-268 | 7 mm | 7 3/4" |
| 1103-269 | 8 mm | 7 3/4" |
| 1103-270 | 10 mm | 8" |
| 1103-271 | 12 mm | 8" |
| 1103-272 | 14 mm | 8" |

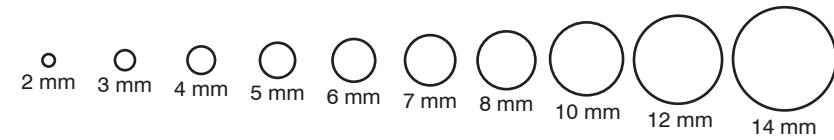

Bruns Round Cup Curette

Round cup / straight / 6 3/4" (17 cm)

| | |
|---------|------------|
| 320-708 | size 00000 |
| 320-709 | size 0000 |
| 320-710 | size 000 |
| 320-711 | size 00 |
| 320-712 | size 0 |
| 320-713 | size 1 |
| 320-714 | size 2 |
| 320-715 | size 3 |
| 320-716 | size 4 |
| 320-717 | size 5 |
| 320-718 | size 6 |

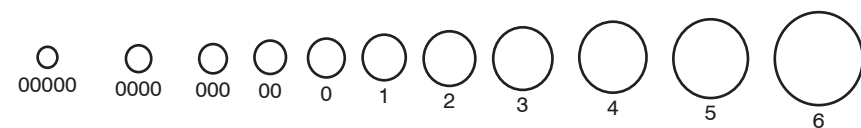

Bruns Oval Cup Curette

Oval cup / straight / 6 3/4" (17 cm)

| | |
|---------|------------|
| 320-808 | size 00000 |
| 320-809 | size 0000 |
| 320-810 | size 000 |
| 320-811 | size 00 |
| 320-812 | size 0 |
| 320-813 | size 1 |
| 320-814 | size 2 |
| 320-815 | size 3 |
| 320-816 | size 4 |
| 320-817 | size 5 |
| 320-818 | size 6 |

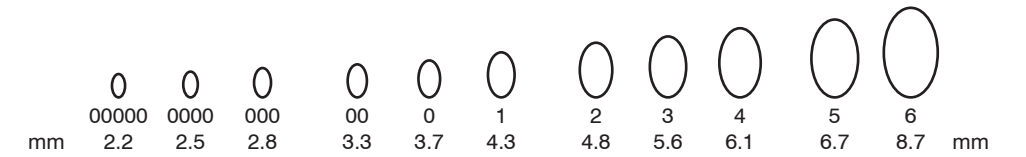

Oval cup / straight / 9" (23 cm)

| | |
|---------|------------|
| 320-827 | size 00000 |
| 320-829 | size 0000 |
| 320-830 | size 000 |
| 320-831 | size 00 |
| 320-832 | size 0 |
| 320-833 | size 1 |
| 320-834 | size 2 |
| 320-835 | size 3 |
| 320-836 | size 4 |
| 320-837 | size 5 |
| 320-838 | size 6 |



Oval cup / angled / 9" (23 cm)

| | |
|---------|------------|
| 320-848 | size 00000 |
| 320-849 | size 0000 |
| 320-850 | size 000 |
| 320-851 | size 00 |
| 320-852 | size 0 |
| 320-853 | size 1 |
| 320-854 | size 2 |
| 320-855 | size 3 |
| 320-856 | size 4 |
| 320-857 | size 5 |
| 320-858 | size 6 |



Bruns Oval Cup Curette

Oval cup / straight / phenolic handle /
6 3/4" (17 cm)

- 320-810P size 000
- 320-811P size 00



320-810P



320-811P

Bruns Solid Hexagonal Curette

Angled / solid hexagonal handle / oval / 9" (22.9 cm)

- 320-870A size 000
- 320-871A size 00
- 320-872A size 0
- 320-873A size 1
- 320-874A size 2
- 320-875A size 3
- 320-876A size 4
- 320-877A size 5
- 320-878A size 6

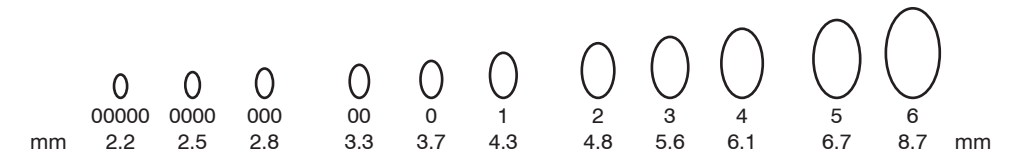

320-870A



320-876A

Bruns Hexagonal Handle Curette

Solid hexagonal handle / 9" (23 cm)

- 320-870 size 000
- 320-871 size 00
- 320-872 size 0
- 320-873 size 1
- 320-874 size 2
- 320-875 size 3
- 320-876 size 4
- 320-877 size 5
- 320-878 size 6



320-876

Cone Ring Curette

Aluminum handle / inside ring diameter / 9" (23 cm)

- 320-952 3mm straight
- 320-955 3mm angle
- 320-951 6mm straight
- 320-954 6mm angle
- 320-950 8mm straight
- 320-953 8mm angle

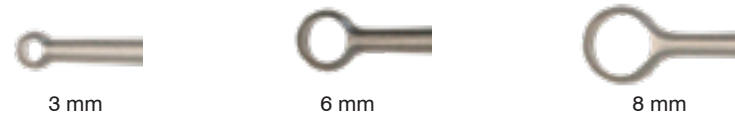

320-953

Hatt Spoon Curette

Solid hexagonal handle / 9" (23 cm)

- 320-778 10 mm
- 320-779 15 mm
- 320-780 20 mm



320-780

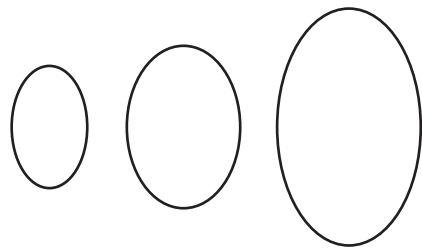

10 mm 15 mm 20 mm

Bruns Ring Curette

9" (23 cm)

- 1271-145 5 mm inside ring diameter
- 1271-147 8 mm inside ring diameter
- 1271-146 10 mm inside ring diameter



1271-145

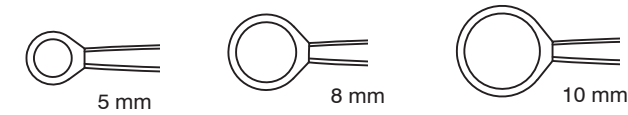

Volkman Curette

Double-ended / oval cup - oval cup

- 320-941 5 1/2" (14 cm)
- 320-942 6 1/2" (16.5 cm)
- 320-948 8" (20.5 cm)

Double-ended / round cup - oval cup

- 320-940 5" (13 cm)
- 320-944 6 1/2" (16.5 cm)
- 320-946 8" (20.5 cm)



320-941



320-940

Jansen Curette

Sharp / double-ended / 6" (15 cm)

- 320-761 straight round cups
- 320-760 20° double-angled oval cups



320-761



320-760



 Sontec Instruments®

Orthopedic ELEVATORS

Freer Periosteal Elevator

Double-ended / square handle / straight
/4.5 mm tip / sharp/blunt / 7 3/4"

1100-798S

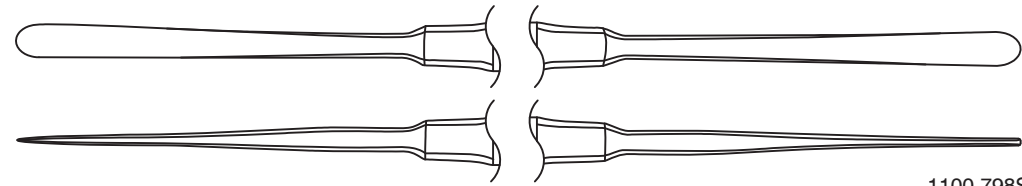

1100-798S

Double-ended / square handle / curved /
4.5 mm tip / sharp/blunt

1100-798 7 3/4"

1100-798F 8 3/4"



1100-798

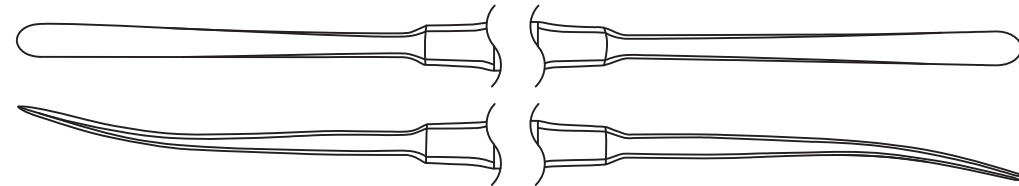

Double-ended / square handle / curved /
6.5 mm tip / sharp/blunt

1100-798A 7 3/4"

1100-798E 8 3/4"



1100-798A

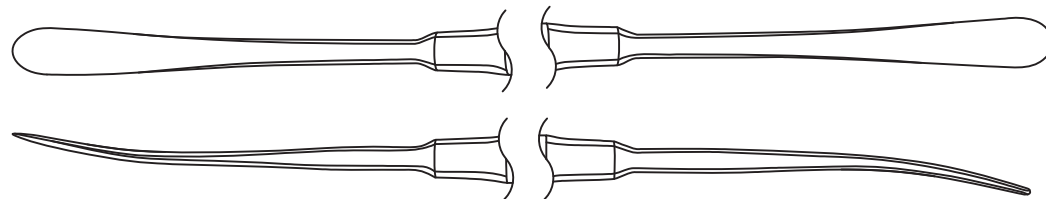

Freer Periosteal Elevator

Double-ended / round handle / curved /
sharp/blunt / 7 1/2"

1100-798B 5 mm tip

1100-798C 6.7 mm tip



1100-798B

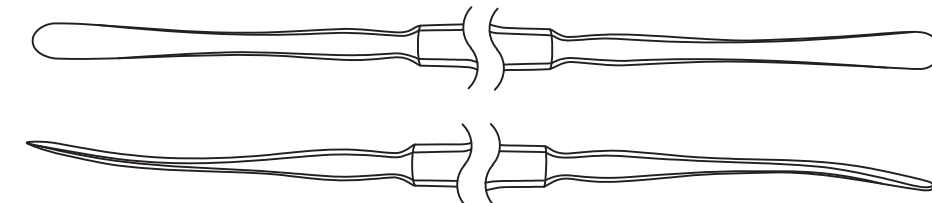

1100-798C

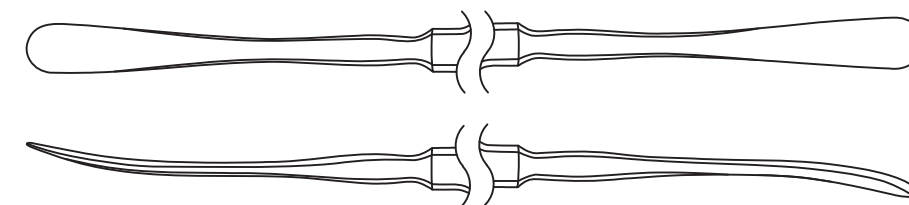

Double-ended / knurled round handle /
curved / 4.5 mm tip / sharp/blunt / 6 3/4"

1100-798D



1100-798D

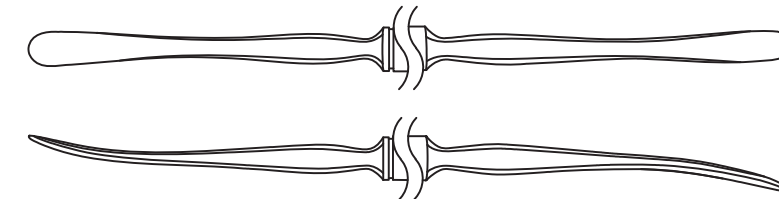

Freer Periosteal Elevator

Double-ended / round handle / curved / 3.5 mm tip
/ sharp / 7 1/4"
1100-798H

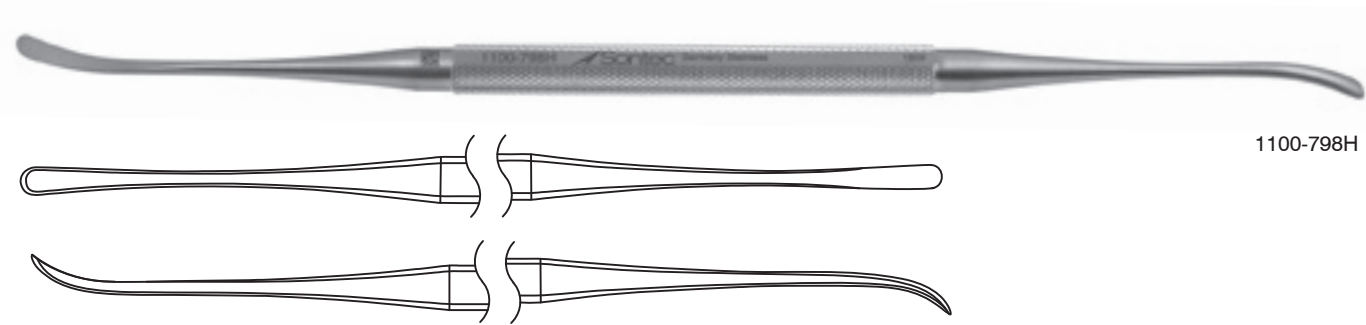

1100-798H

Adson Periosteal Elevator

Single-ended / 6 1/2" (16.5 cm)
412-520 str chisel edge
412-522 cvd blunt
412-524 cvd semi-sharp
412-526 str semi-sharp



412-520

412-522

412-524

412-526

Love Adson Periosteal Elevator

Single-ended / 6 3/4" (16.5 cm)
412-528 cvd semi-sharp



412-528

Langenbeck Periosteal Elevator

Single-ended / 8" (20 cm)
335-205 narrow blunt tip 6 mm
335-207 wide sharp tip 17 mm

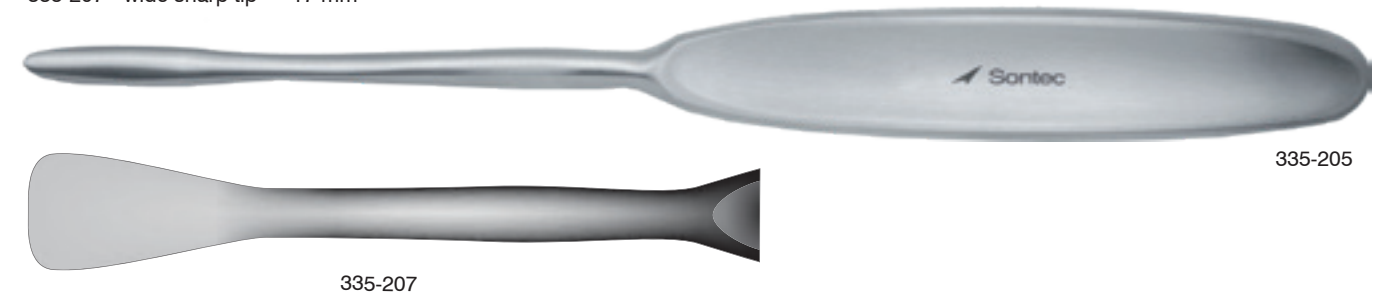

335-205

335-207

Hoen Periosteal Elevator

7 mm tip / 6 1/4" (16 cm)
412-530



412-530

Lane Periosteal Elevator

Single-ended / 7 1/2" (19 cm)
335-210 narrow semi-sharp tip 6 mm
335-212 wide semi-sharp tip 10 mm



335-210

335-212

McIlwraith Periosteal Elevator

Single-ended / 7 1/2" (19 cm)

- 1404-870 sharp
- 1404-871 sharp phenolic handle



1404-870



1404-871

Key Periosteal Elevator

6 3/4" (17 cm)

- 335-135 1/8" tip
- 335-136 1/4" tip
- 335-137 3/8" tip

7 1/2" (19 cm)

- 335-138 1/2" tip
- 335-139 5/8" tip

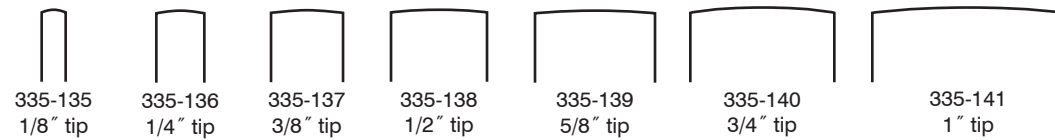

8" (20.5 cm)

- 335-140 3/4" tip

8 3/8" (21.5 cm)

- 335-141 1" tip



335-135



335-136



335-137



335-139

Joker Periosteal Elevator

Blunt / curved / 6" (15.5 cm)

412-518



412-518

Williger Periosteal Elevator

Sharp / 6 1/4"

- 412-5374 4 mm
- 412-5375 5 mm
- 412-53765 6.5 mm
- 412-5377 7 mm



412-53765

Sayre Elevator

Double-ended / 6 1/2" (16.5 cm)

- 1100-512 sharp/blunt
- 1100-512B blunt/blunt



1100-512

Piermattei Shoulder Elevator

Single-ended / 9" (23 cm)

1103-210



1103-210

Sedillot Elevator

18 mm tip / 7 1/2" (19 cm)

335-226



335-226

Sontec A O Type Elevator / Raspatory

Phenolic handles / 7 1/2" (19 cm)

| | | | |
|---------|----------|--------------|------------|
| 335-250 | 6 mm tip | str | flat edge |
| 335-254 | 3 mm tip | slight curve | round edge |
| 335-255 | 3 mm tip | slight curve | flat edge |
| 335-260 | 6 mm tip | slight curve | flat edge |
| 335-265 | 6 mm tip | slight curve | round edge |

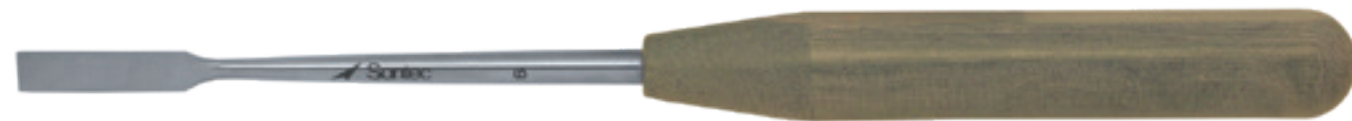

335-250



335-255



335-260



335-265

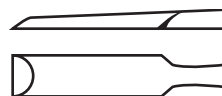

335-250



335-255



335-260



335-265

Sontec A O Type Elevator / Raspatory

Phenolic handles / 8" (20 cm)

| | | | |
|---------|-----------|--------|------------|
| 335-270 | 13 mm tip | angled | flat edge |
| 335-275 | 14 mm tip | str | round edge |
| 335-280 | 14 mm tip | cvd | round edge |
| 335-285 | 20 mm tip | str | round edge |



335-270



335-275



335-280



335-285

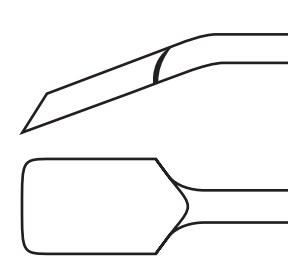

335-270

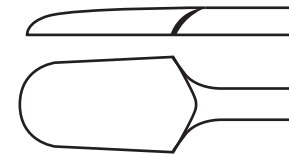

335-275

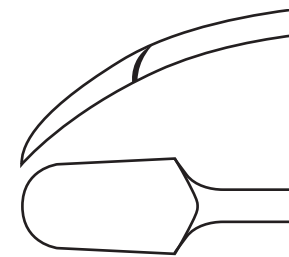

335-280

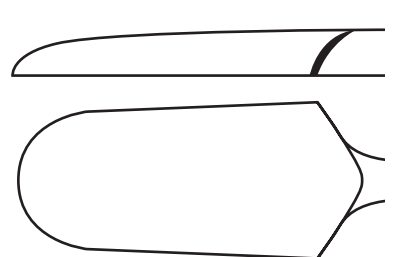

335-285



 Sontec Instruments®

Orthopedic GOUGES

Smith-Petersen Gouge

Straight / 8" (20.5 cm)

- 330-630 6 mm (1/4") tip
- 330-631 9 mm (3/8") tip
- 330-632 13 mm (1/2") tip
- 330-633 16 mm (5/8") tip
- 330-634 19 mm (3/4") tip
- 330-635 25 mm (1") tip
- 330-636 32mm (1 1/4") tip



330-634

Curved / 8" (20.5 cm)

- 330-640 6 mm (1/4") tip
- 330-641 9 mm (3/8") tip
- 330-642 13 mm (1/2") tip
- 330-643 16 mm (5/8") tip
- 330-644 19 mm (3/4") tip
- 330-645 25 mm (1") tip
- 330-646 32mm (1 1/2")tip

Cobb Type Spinal Gouge

11" (20.5 cm)

- 330-650 straight
- 330-651 medium curve
- 330-652 strong curve
- 330-653 reverse curve



330-652

Sontec Micro Gouge

5 1/2" (14 cm)

- 475-803 3mm
- 475-804 4mm
- 475-805 5mm
- 475-806 6mm



475-804



475-805



475-806

Mini Lexer Gouge

7" (18 cm)

- 330-020 4 mm tip
- 330-021 6 mm tip
- 330-022 8 mm tip
- 330-023 10 mm tip
- 330-024 12 mm tip

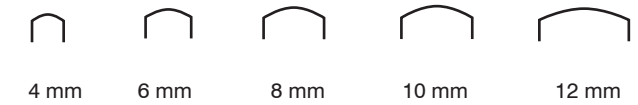

330-020



330-021



330-022

Lexer Gouge

8 3/4" (22.5 cm)

- 330-030 7 mm tip
- 330-031 10 mm tip
- 330-032 15 mm tip
- 330-033 20 mm tip
- 330-034 25 mm tip
- 330-035 30 mm tip

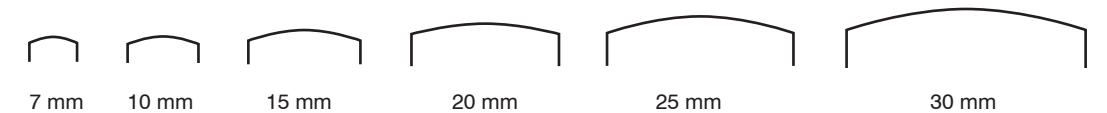

330-030



330-032



330-034

Hibbs Gouge

Straight / 9 1/2" (24.1 cm)

| | |
|---------|--------|
| 330-590 | 1/4" |
| 330-591 | 3/8" |
| 330-592 | 1/2" |
| 330-593 | 5/8" |
| 330-594 | 3/4" |
| 330-595 | 7/8" |
| 330-596 | 1" |
| 330-597 | 1 1/8" |
| 330-598 | 1 1/4" |
| 330-599 | 1 1/2" |



330-591

Curved / 9 1/2" (24.1 cm)

| | |
|---------|--------|
| 330-600 | 1/4" |
| 330-601 | 3/8" |
| 330-602 | 1/2" |
| 330-603 | 5/8" |
| 330-604 | 3/4" |
| 330-605 | 7/8" |
| 330-606 | 1" |
| 330-607 | 1 1/8" |
| 330-608 | 1 1/4" |
| 330-609 | 1 1/2" |

Hibbs Chisel

Straight / 9 1/2" (24.1 cm)

| | |
|---------|--------|
| 330-500 | 1/4" |
| 330-511 | 3/8" |
| 330-512 | 1/2" |
| 330-513 | 5/8" |
| 330-514 | 3/4" |
| 330-515 | 7/8" |
| 330-516 | 1" |
| 330-517 | 1 1/8" |
| 330-518 | 1 1/4" |
| 330-519 | 1 1/2" |



330-517

Curved / 9 1/2" (24.1 cm)

| | |
|---------|--------|
| 330-530 | 1/4" |
| 330-531 | 3/8" |
| 330-532 | 1/2" |
| 330-533 | 5/8" |
| 330-534 | 3/4" |
| 330-535 | 7/8" |
| 330-536 | 1" |
| 330-537 | 1 1/8" |
| 330-538 | 1 1/4" |
| 330-539 | 1 1/2" |

Sontec Chisel

Curved / 7 1/4" (18.4 cm)

| | |
|---------|------|
| 330-460 | 7 mm |
|---------|------|



330-460

Straight / 7 1/4" (18.4 cm)

| | |
|---------|-------|
| 330-462 | 6 mm |
| 330-464 | 8 mm |
| 330-466 | 10 mm |
| 330-468 | 12 mm |
| 330-470 | 16 mm |
| 330-472 | 22 mm |



330-464



330-466



330-468



330-470



330-472



 Sontec Instruments®

Orthopedic OSTEOTOMES

Smith Peterson Osteotome

Straight / 8" (20.5 cm)

| | |
|---------|--------|
| 330-610 | 1/4" |
| 330-611 | 3/8" |
| 330-612 | 1/2" |
| 330-613 | 5/8" |
| 330-614 | 3/4" |
| 330-615 | 1" |
| 330-616 | 1 1/4" |



330-611



330-612

Smith Peterson Osteotome

Curved / 8" (20.5 cm)

| | |
|---------|--------|
| 330-620 | 1/4" |
| 330-621 | 3/8" |
| 330-622 | 1/2" |
| 330-623 | 5/8" |
| 330-624 | 3/4" |
| 330-625 | 1" |
| 330-626 | 1 1/4" |



330-621



330-623



330-624



330-625



330-626

Hibbs Osteotome

Straight / 9 1/2" (24 cm)

- 330-550 1/4"
- 330-551 3/8"
- 330-552 1/2"
- 330-553 5/8"
- 330-554 3/4"
- 330-555 7/8"
- 330-556 1"
- 330-557 1 1/8"
- 330-558 1 1/4"
- 330-559 1 1/2"

Curved / 9 1/2" (24 cm)

- 330-570 1/4"
- 330-571 3/8"
- 330-572 1/2"
- 330-573 5/8"
- 330-574 3/4"
- 330-575 7/8"
- 330-576 1"
- 330-577 1 1/8"
- 330-578 1 1/4"
- 330-579 1 1/2"

330-550



330-551



330-552



330-553



330-571



330-572



330-573



Lambotte Osteotome

Straight / 9" (23 cm)

- 330-660 1/4" (6 mm)
- 330-661 1/2" (13 mm)
- 330-662 3/4" (19 mm)
- 330-663 1" (25 mm)
- 330-664 1 1/4" (32 mm)
- 330-665 1 1/2" (38 mm)

Curved / 9" (23 cm)

- 330-670 1/4" (6 mm)
- 330-671 1/2" (13 mm)
- 330-672 3/4" (19 mm)
- 330-673 1" (25 mm)
- 330-674 1 1/4" (32 mm)
- 330-675 1 1/2" (38 mm)

330-660

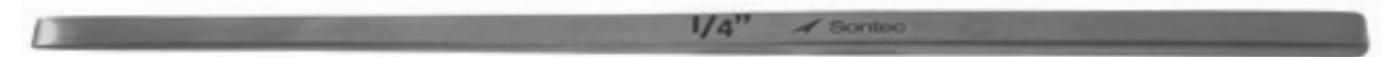

330-661

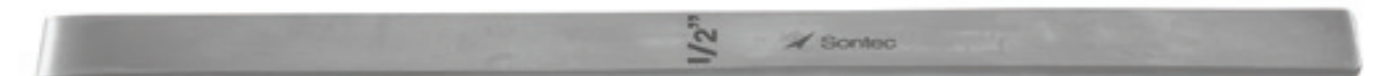

330-662



330-665



330-670



330-671



West Osteotome

Square handle

| | | |
|----------|------|------------------|
| 330-708 | 4 mm | 6 1/2" (16.5 cm) |
| 330-708A | 6 mm | 7 1/2" (19 cm) |



Hand Surgery Osteotome

Straight / 5" (13 cm)

| | |
|----------|----------------|
| 1103-281 | 3/32" (2 mm) |
| 1103-280 | 1/8" (3 mm) |
| 1103-282 | 5/32" (4 mm) |
| 1103-283 | 1/4" (6 mm) |
| 1103-284 | 5/16" (8 mm) |
| 1103-285 | 13/32" (10 mm) |
| 1103-286 | 15/32" (12 mm) |
| 1103-287 | 9/16" (14 mm) |
| 1103-288 | 19/32" (15 mm) |
| 1103-289 | 3/4" (19 mm) |
| 1103-291 | 5/8" (16 mm) |
| 1103-292 | 11/16" (18 mm) |
| 1103-293 | 13/16" (20 mm) |



Curved / 5" (13 cm)

| | |
|-----------|----------------|
| 1103-281C | 3/32" (2 mm) |
| 1103-280C | 1/8" (3 mm) |
| 1103-282C | 5/32" (4 mm) |
| 1103-283C | 1/4" (6 mm) |
| 1103-284C | 5/16" (8 mm) |
| 1103-285C | 13/32" (10 mm) |
| 1103-286C | 15/32" (12 mm) |
| 1103-287C | 9/16" (14 mm) |
| 1103-288C | 19/32" (15 mm) |
| 1103-289C | 3/4" (19 mm) |
| 1103-291C | 5/8" (16 mm) |
| 1103-292C | 11/16" (18 mm) |
| 1103-293C | 13/16" (20 mm) |

Sheehan Osteotome

6 1/4" (16 cm)

| | |
|---------|-------|
| 330-882 | 2 mm |
| 330-883 | 3 mm |
| 330-884 | 4 mm |
| 330-885 | 5 mm |
| 330-886 | 6 mm |
| 330-887 | 7 mm |
| 330-888 | 8 mm |
| 330-889 | 9 mm |
| 330-890 | 10 mm |
| 330-891 | 11 mm |
| 330-892 | 12 mm |
| 330-895 | 15 mm |



Hoke Osteotome

Hex handle / straight / 5" (12.5 cm)

| | |
|---------|--------------|
| 330-690 | 1/8" (3 mm) |
| 330-691 | 3/16" (4 mm) |
| 330-692 | 1/4" (6 mm) |
| 330-693 | 5/16" (8 mm) |
| 330-694 | 3/8" (10 mm) |
| 330-695 | 1/2" (13 mm) |
| 330-696 | 5/8" (16 mm) |



Curved / 5" (12.5 cm)

| | |
|---------|--------------|
| 330-700 | 1/8" (3 mm) |
| 330-701 | 3/16" (4 mm) |
| 330-702 | 1/4" (6 mm) |
| 330-703 | 5/16" (8 mm) |
| 330-704 | 3/8" (10 mm) |
| 330-705 | 1/2" (13 mm) |
| 330-706 | 5/8" (16 mm) |



Cottle Plastic Osteotome

Specially designed edge / heavy type
/ with end stop platform / with no
corners on blade / 7" (18 cm)

- 330-849A 3/32" (2 mm)
- 330-849B 5/32" (4 mm)
- 330-849C 9/32" (7 mm)
- 330-849D 11/32" (9 mm)
- 330-849E 15/32" (12 mm)



330-849A



330-849B



330-849C



330-849D



330-849E

Stille Osteotome

Hexagonal handle / 8" (20.5 cm)

- 330-730 13/32" (10 mm)
- 330-731 9/16" (14 mm)
- 330-732 23/32" (18 mm)
- 330-733 7/8" (22 mm)



330-730



330-731



330-733

Hardt Micro Cartilage Osteotome Set (with tray)

5 1/8" (13.25 cm)

330-799-SET includes:

- 330-801M 3/32" (2 mm)
- 330-802M 5/32" (4 mm)
- 330-803M 1/4" (6 mm)
- 330-804M 5/16" (8 mm)
- 330-805M 13/32" (10 mm)
- 330-806M 15/32" (12 mm)
- 330-807M 19/32" (15 mm)

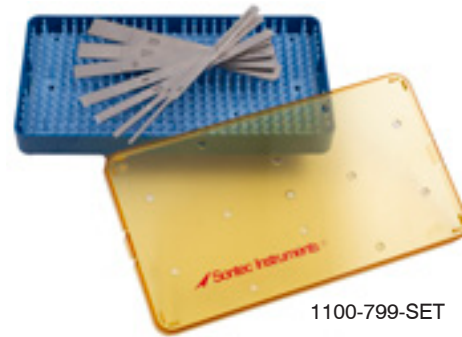

1100-799-SET



1100-800M-SET

6 3/4" (17 cm)

330-800M-SET includes:

- 330-790M 3/32" (2 mm)
- 330-791M 5/32" (4 mm)
- 330-792M 1/4" (6 mm)
- 330-793M 5/16" (8 mm)
- 330-794M 13/32" (10 mm)
- 330-795M 15/32" (12 mm)
- 330-796M 19/32" (15 mm)

1103-723 7 1/2" x 4" x 3/4" tray with silicone mat, autoclavable

Hardt Osteotomes also available individually



330-801M

330-802M

330-803M

330-804M

330-805M

330-806M

330-807M

Sontec-Cottle Osteotome Set

Graduated markings / 7" (18 cm)

1100-479-SET set includes:

7 osteotomes and tray
2 mm, 3 mm, 4 mm, 6 mm,
8 mm, 10 mm, 12 mm

- 1100-479K 2 mm
- 1100-479M 3mm
- 1100-479L 4 mm
- 1100-479A 6 mm
- 1100-479B 8 mm
- 1100-479C 10 mm
- 1100-479D 12 mm
- 1100-479E 14 mm
- 1100-479F 16 mm
- 1100-479G 18 mm
- 1100-479N 19mm
- 1100-479J 20 mm
- 1100-479H 22 mm

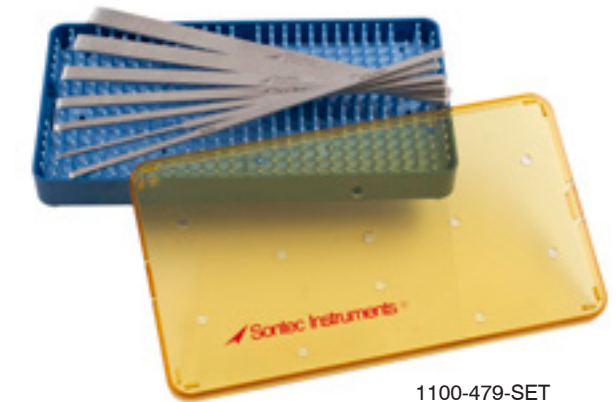

1100-479-SET

1103-723 7 1/2" x 4" x 3/4" tray with silicone mat, autoclavable



1100-479K

1100-479E

1100-479G

1100-479N

1100-479J

1100-479H

Hardt Micro Ceramitec Osteotome

6 3/4" (17 cm)

- 330-790MB 2 mm
- 330-791MB 4 mm
- 330-792MB 6 mm
- 330-793MB 8 mm
- 330-794MB 10 mm
- 330-795MB 12 mm
- 330-796MB 15 mm



330-791MB



330-792MB

Mini Lexer Osteotome

Small handle / 7" (18 cm)

- 330-001 4 mm tip
- 330-002 6 mm tip
- 330-003 8 mm tip
- 330-004 10 mm tip
- 330-005 12 mm tip



330-005

Lexer Osteotome

Large handle / 8 3/4" (22.5 cm)

- 330-010 7 mm tip
- 330-011 10 mm tip
- 330-012 15 mm tip
- 330-013 20 mm tip
- 330-014 25 mm tip
- 330-015 30 mm tip



330-015



Lexer Osteotome

Large handle / 12" (30.5 cm)

- 330-016 10 mm tip
- 330-017 12 mm tip
- 330-018 15 mm tip

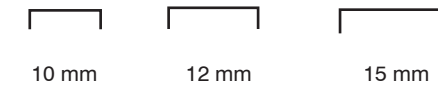

330-016

Obwegeser Split Osteotome

8 3/4" (22.5 cm)

- 330-120 8 mm tip
- 330-125 12 mm tip
- 330-130 16 mm tip
- 330-135 20 mm tip

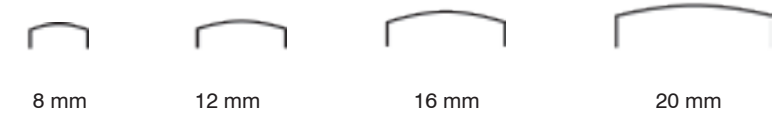

330-130

Obwegeser Wedge Osteotome

8 3/4" (22.5 cm)

- 330-100 8 mm tip
- 330-105 12 mm tip
- 330-110 16 mm tip



330-100



 Sontec Instruments®

Orthopedic MALLETS

Sontec Combo Nylon Mallet

1" head diameter / removable heads / 7 3/8" (18.75 cm)

1100-462S deluxe mallet with one nylon head

Sold separately

1100-462SH stainless steel head for deluxe mallet

1100-463S nylon head for deluxe mallet



1100-462S



1100-462SH



1100-463S

Sontec Double Nylon Mallet

Light-weight / 7 3/8" (18.7 cm) / 7 oz.

330-808



Sontec Micro Mallet

3/4" head diameter / 6 1/2" (16.5 cm)

330-817 stainless steel convex/flat combo 4 oz.

330-819 lead filled head no recoil 5.6 oz.



330-819

Mead Mallet

3/4" head diameter / 7 1/2" (19 cm) / 8 oz. head
/ w/replacement nylon caps

330-814

Replacement caps

330-814R

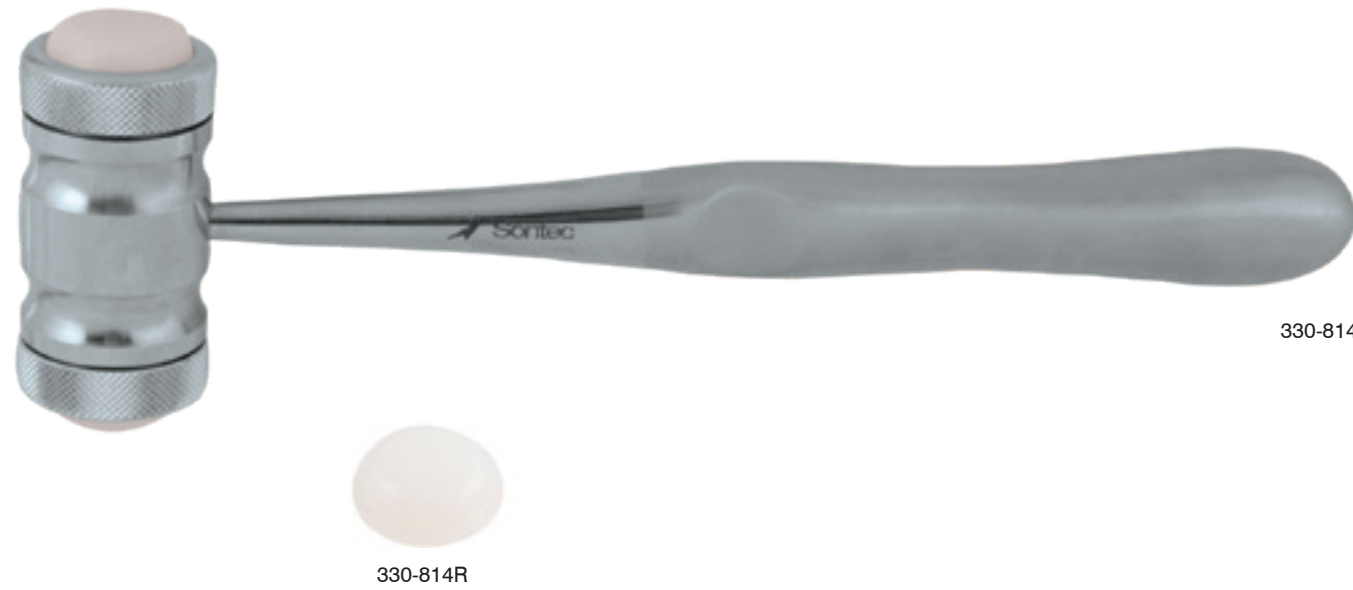

Brass Head Mallet

7 3/4" (20 cm)

330-811



Large Sontec Combo Mallet

1 1/2" head / replaceable heads / 8" (20.5 cm)

330-824

330-824S stainless & nylon head

Replaceable heads / 1 1/2" (3.8 cm)

330-824NH nylon

330-824SH stainless steel



330-824NH

330-824SH



330-824

Cottle Mallet

Convex flat combo / 7 1/2" (19.1 cm)

1100-461S stainless steel head



1100-461S

Collin Lucae Mallet

Solid head / 210 grams /
30mm Ø / 8 1/4" (21 cm)

330-818



330-818

USA Model Mallet

1" diameter / 1 lb USA model / 7 1/4" (18.4 cm)

330-833



Sontec Large Mallet

10 3/4" (26.5 cm)

330-835 1 pound (450 g)
330-834 2 pounds (900 g)



330-835



330-834

Heavyweight Mallet

1 1/2" head diameter / 7 1/4" (18.5 cm)
330-832 1.72 lbs



330-832

AO Type Mallet

Fenestrated handle / AO type / 9" (23 cm)
330-839



330-839

Sontec Large Handle Mallet

Ribbed phenolic handle
330-840 10 1/4" (26 cm) 1 3/4" head dia. 3 lbs
330-842 10 1/4" (26 cm) 1 1/4" head dia.



330-840

Sontec Large Handle Mallet

Ergonomic phenolic handle / 1 1/4" head diameter
330-841 8 3/4" (22 cm)



330-841

No Recoil Mallet

One sided nylon head / no recoil

330-823 9 3/4" (25 cm) 500 g 35mm diameter head
 330-827 9" (23cm) 300 g 27mm diameter head



330-823



330-827

Phenolic Spinal Mallet

10 1/4" (26.5 cm)

330-844 35 mm 150 g
 330-845 45 mm 240 g
 330-846 50 mm 330 g

9 1/2" (24 cm) / Steinbach style

330-847 60 mm 400 g



330-844



330-847



 Sontec Instruments®

Orthopedic MENISCOTOMES & KNIVES

Femoral Head Disarticulator Knife

Curved

1103-211 Small 5 1/2" (14 cm)
1103-213 Large 7 1/2" (19 cm)



1103-211



1103-213

V Blade Meniscotome

Flat handle / 6 3/4" (17 cm)

1103-206

Curved / 8" (20.5 cm)

1103-209



1103-206

Mini V-Blade Meniscotome

Flat handle / 6 3/4" (17 cm)

1103-2063 3mm



1103-2063

Foerner Sesamoid Knife Elevator

Single end / curved / 5 mm tip

1404-875 6 1/4" (16 cm)

1404-875L 7 1/4" (18.4 cm) heavy



1404-875



1404-875L

Rosin Root Meniscotome

Curved "V" blade / 6 1/4" (16 cm)
350-836



350-836

Piermattei Smillie Meniscotome

6 3/4" (17 cm)
1103-205



1103-205

Smillie Meniscotome

Straight blade / 6 3/4" (17 cm)
1103-208



1103-208

Smillie Meniscus Knife

Curved / "V" tip / 8" (20.3 cm)
350-838



350-838

Braake Tendon Knife

Angled down / carbon coated
shaft / 7" (18 cm)
1271-183



1271-183

Nixon XXL Banana Knife

Double sided / wide blade / serrated / 9" (23 cm)
1271-139C curved
1271-139D straight



1271-139C



1271-139D



 Sontec Instruments®

Orthopedic PIN-PULLERS, DRIVERS & BENDERS

Vickers Easy Driver / Bender / Puller

To drive, bend & pull K-wire / 5 1/2" (14 cm)
1103-179

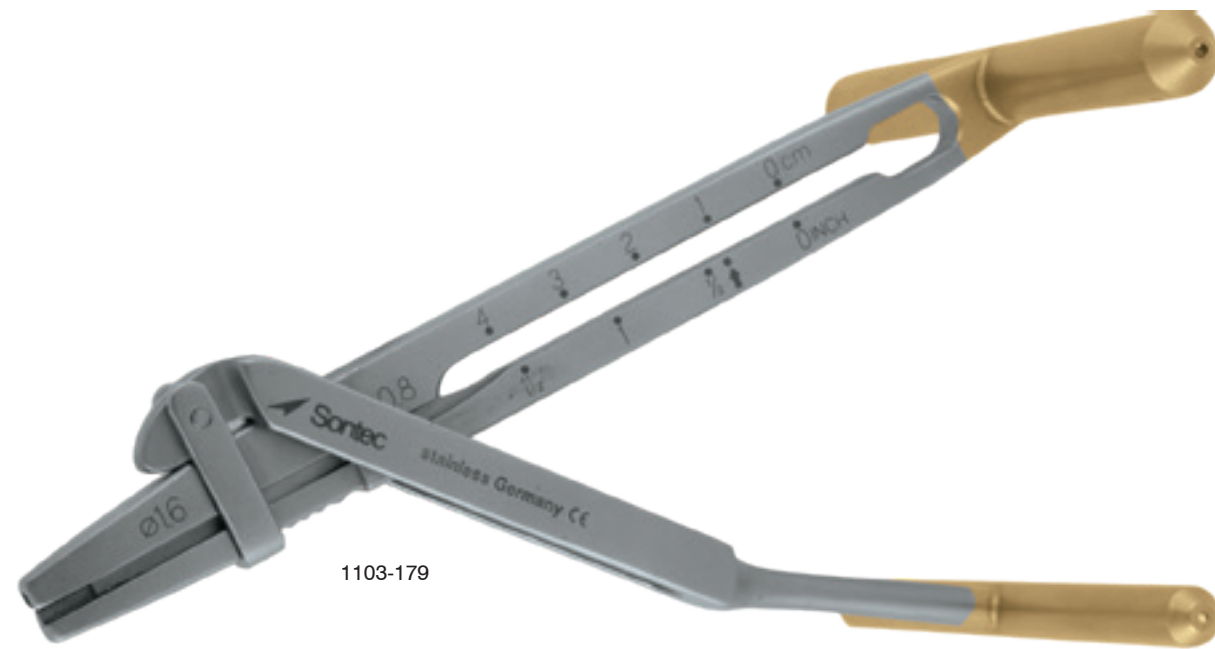

1103-179

Black Vickers K-Wire Pin Bender

3 1/2" (9 cm)

- 1103-178A 1 mm Ø (0.035") x 1.2 mm Ø (0.045")
- 1103-178C 1.4 mm Ø (0.054") x 1.6 mm Ø (0.062")



1103-178A



1103-178C

Pin Driver & Bone Tamp

Single-ended flat tip with 1 mm raised circular lip / 3 1/2" (9 cm) in length

- 1103-2011 1.5 mm tip
- 1103-201A 2 mm tip
- 1103-201B 3 mm tip
- 1103-201C 4 mm tip
- 1103-201D 5 mm tip
- 1103-201E 6 mm tip
- 1103-201F 8 mm tip
- 1103-201G 10 mm tip

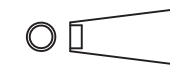

1103-201A

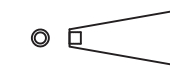

1103-2011



1103-201D



1103-201B



1103-201C

Sontec Pin Driver / Bender

Bends K-wire and pins

- 1103-201 2 mm / 2.3 mm 5" (13 cm)
- 1106-199 2 mm / 3.2 mm 6" (15.5 cm)

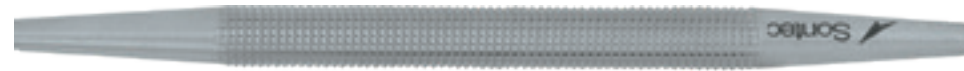

1103-201



1106-199

Peterson Fully Cannulated Pin Bender

Double-ended with concave tips / specially cannulated through entire length for better leverage

- 1103-201J 2 mm tip / 2.3 mm tip 5" (13 cm)
- 1103-201H 2 mm tip / 3.2 mm tip 5 3/4" (14 cm)



1103-201J



1103-201H

Pin Bender Double-Ended

Bends K-wire / 4 1/2" (11.5 cm)

- 1106-196 1.6 mm tip / 2.0 mm tip
- 1106-198 0.8 mm tip / 1.25 mm tip



1106-196



1106-198

Pin Bender Double-Ended

Bends K-wire / 0.9 mm (0.035") / 1.6 mm (0.062") / 1.1 mm (0.045") / 1.4 mm (0.054") / 4 1/2" (11.5 cm)

- 1106-206



1106-206

Piermattei Pin Bender / Driver

3 1/2" (9 cm)
1103-200

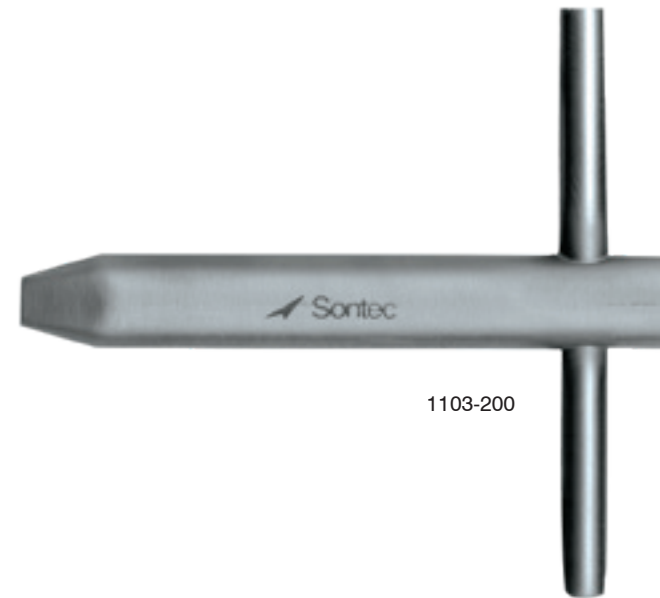

1103-200

Steinman Pin Puller

Pulls pins from 1/8" (3.2 mm)
/ 5 1/2" (14 cm)
1106-124

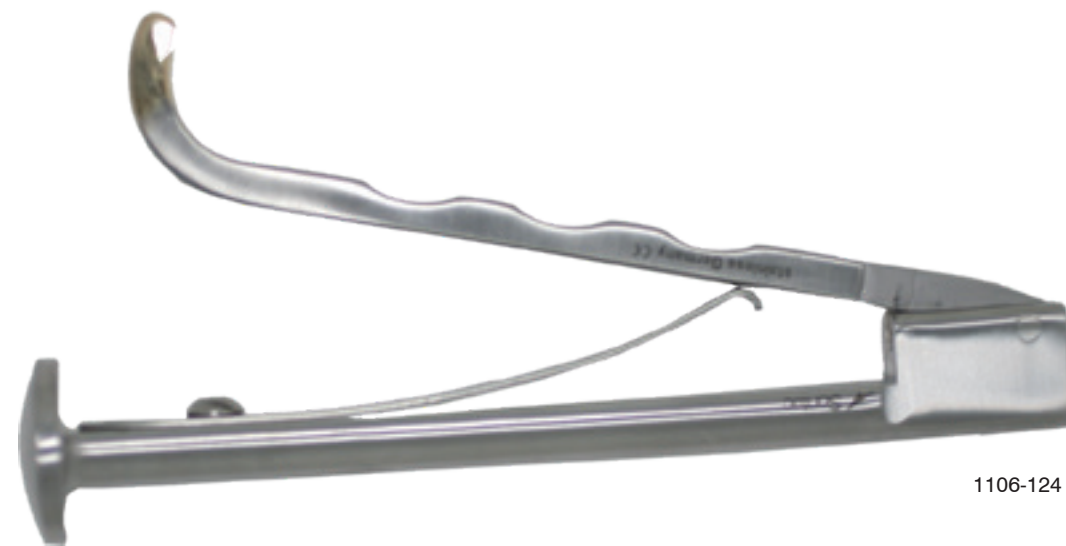

1106-124

Parallel Wire Extraction Pliers

Cuts wire up to 1.6 mm MAX

- 1103-125 4 1/2" (11.5 cm) with TC cutter
- 1103-126 6 1/2" (16.5 cm) with TC cutter
- 1103-126R 6 1/2" (16.5 cm) with TC cutter rainbow
- 1103-127 7 1/4" (18.5 cm) with TC cutter
- 1103-127A 7 1/2" (19 cm) without TC cutter



1103-125



1103-127



1103-127A

Pin Pulling Double Action Pliers

TC serrated / double-action / 7" (18 cm)

- 1100-533 2 mm
- 1100-533A 3 mm
- 1100-532 4 mm
- 1100-536 6 mm



HERCULES® GRIP Pin Puller

Over 40% less power required / 7" (18 cm)

- 355-182 3 mm
- 355-183 6 mm

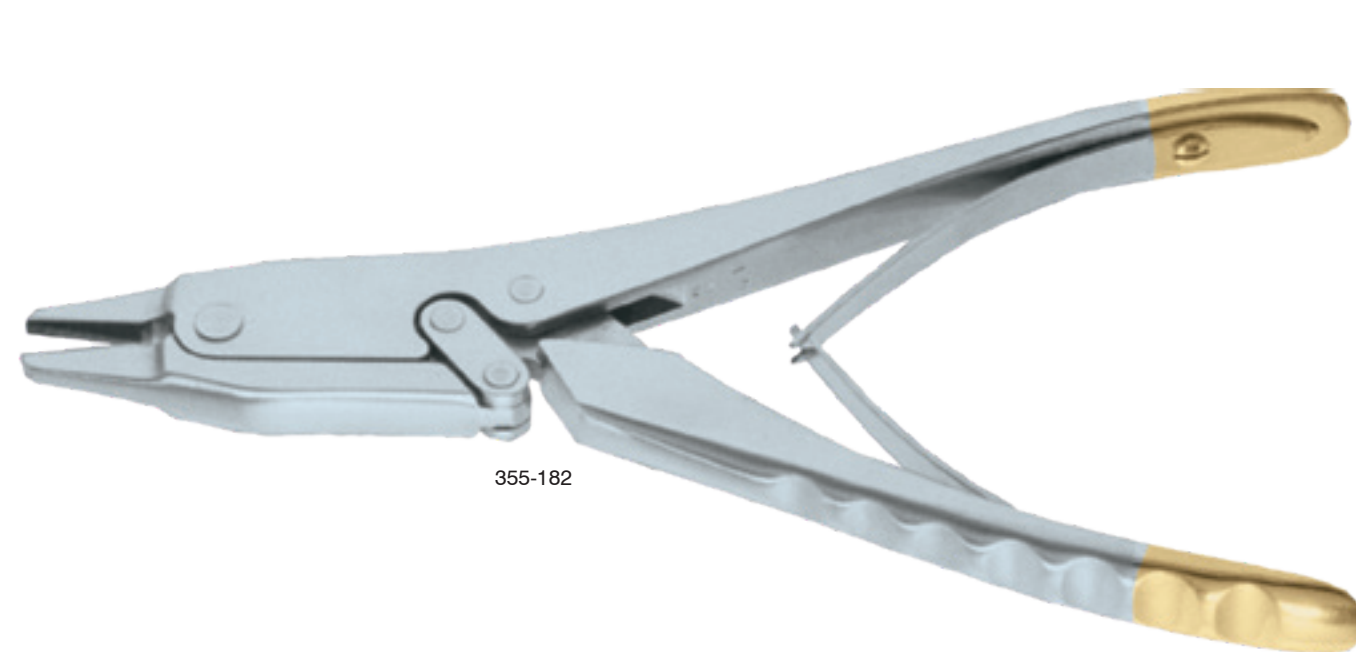

Pin Puller

Grooved serrated jaws / with adjustable screw

- 1103-122 5 1/2"
- 1103-123 7"





 Sontec Instruments®

Orthopedic PLATE BENDERS & BENDING IRONS

Mini Plate Bending Iron

Small plates / bends plates 1.5 and smaller / 4 3/4" (12 cm)

1106-197



1106-197

Small Plate Bending Iron

Used in pairs / 5 1/2" (14 cm)

1106-200 bends plates 2.7 mm
1106-205 bends plates 3.5 mm



1106-200



1106-205

Standard Plate Bending Iron

Bends standard plates / with four rod holes / 9 1/2" (24 cm)

1106-210



1106-210

Plate Bending Iron

Bends plates laterally / 2.7 mm contours plates / use in pairs / 6 1/4" (16 cm)

1106-207



1106-207

Plate Bending Iron Lateral & Contour

Bends plates 3.5 mm & 4.5 mm / 7 1/2" (19 cm)

1106-212



1106-212

Plate Bending Pliers

Rotatable anvil

355-244 10" (25 cm)



355-244

Plate Bending Table Top Press

Bends plates up to 6 mm / rotatable anvil / 17" (43 cm) in length

1106-185



1106-185

Lateral Plate Bending Pliers

Bends 2.7 mm x 3.5 mm / contours plates /
10 1/4 (26 cm)

355-245



355-245

Whale Nose Plate Bending Pliers

Bends small plates up to 2.7 mm / 7 3/4" (19.5 cm)
355-230

Bends large plates up to 3.5 mm / 9 1/2" (24 cm)
355-235



AO Type Bending Pliers Set

For straight plates / with 2 anvils / 10" (25.4 cm)
/ comes with 355-236N & 355-236B
355-236-SET

Plates for Bending Pliers

- 355-236A for small plates
- 355-236B for broad plates
- 355-236N for narrow plates



355-236A



355-236B

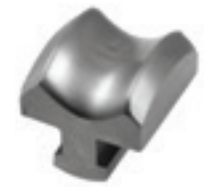

355-236N



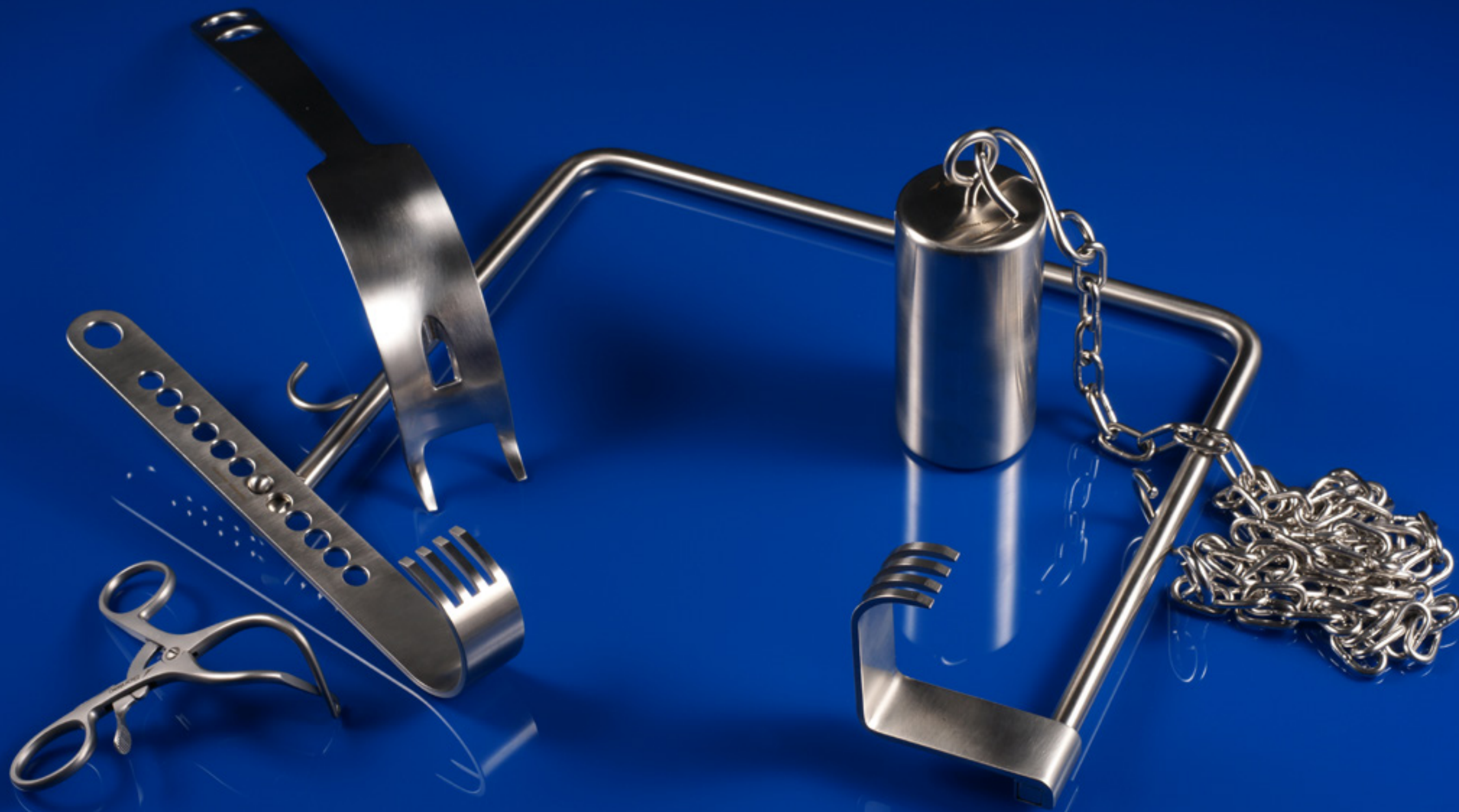

 Sontec Instruments®

Orthopedic RETRACTORS

Gelpi Deep Angle Retractor

- 1100-629A 3 1/2"(9 cm)
- 1100-628A 4 1/2"(11.5 cm)
- 1100-628C 5 1/2"(14 cm)
- 1100-631 6 3/4"(17.5 cm)
- 1100-631S 6 3/4"(17.5 cm)
- 4.5 mm prong 3 cm deep
- 1100-631A 7 1/2"(19 cm)
- 1100-631B 8" (20 cm)

* Custom blunt or shortened tips available upon request



1100-628C

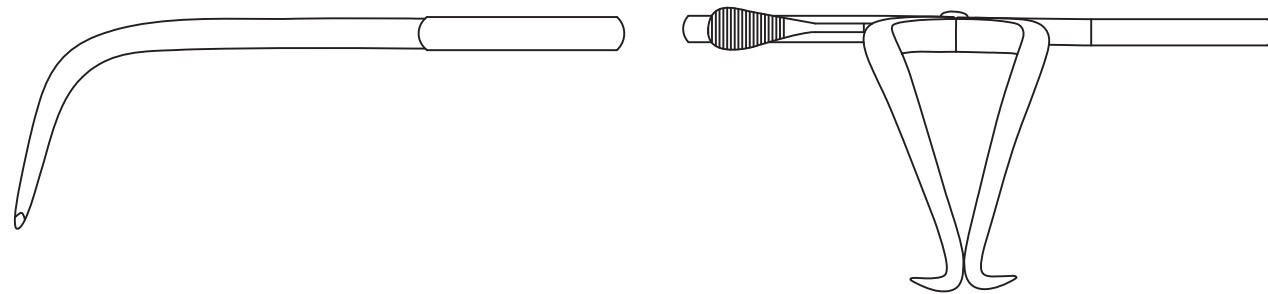

Gelpi Retractor

Deep half angle / 7 1/2" (19 cm)

- 1100-6315 sharp
- 1100-6317 blunt

* Custom blunt or shortened tips available upon request

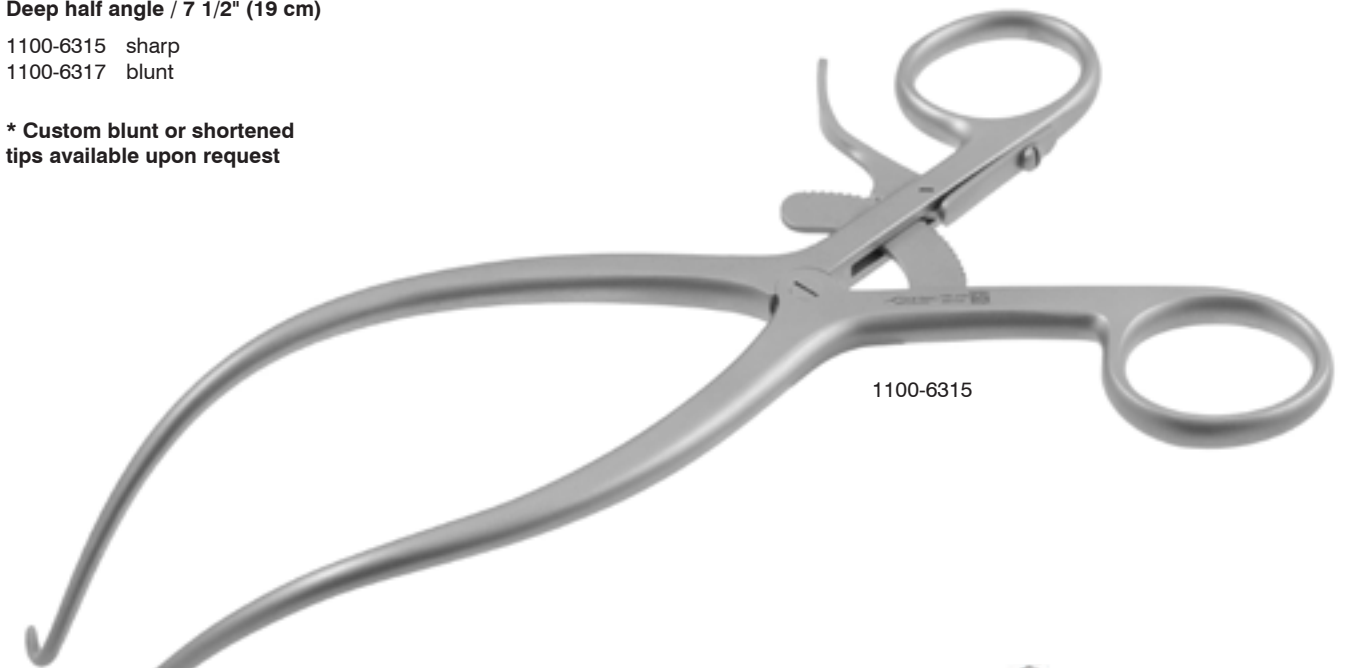

1100-6315

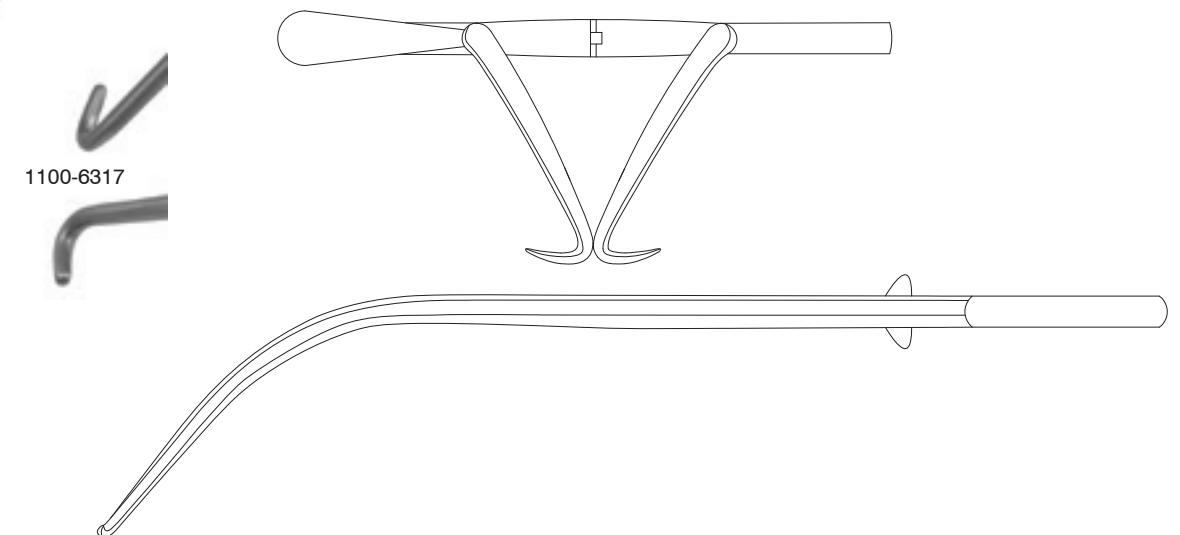

1100-6317

Gelpi Neroma (Crossover) Retractor

| | | |
|-----------|------------------|-------|
| 1100-633A | 4 1/2" (11.5 cm) | |
| 1100-633B | 3 1/2" (9 cm) | |
| 1100-633 | 5 1/2" (14 cm) | |
| 1100-633C | 6 1/2" (16.5 cm) | |
| 1100-633D | 7 1/2" (19 cm) | |
| 1100-633E | 3 1/2" (9 cm) | heavy |

Enclosed ratchet version

| | |
|------------|---------------|
| 1100-633BR | 3 1/2" (9 cm) |
|------------|---------------|

* Custom blunt or shortened tips available upon request



enclosed ratched



1100-633A

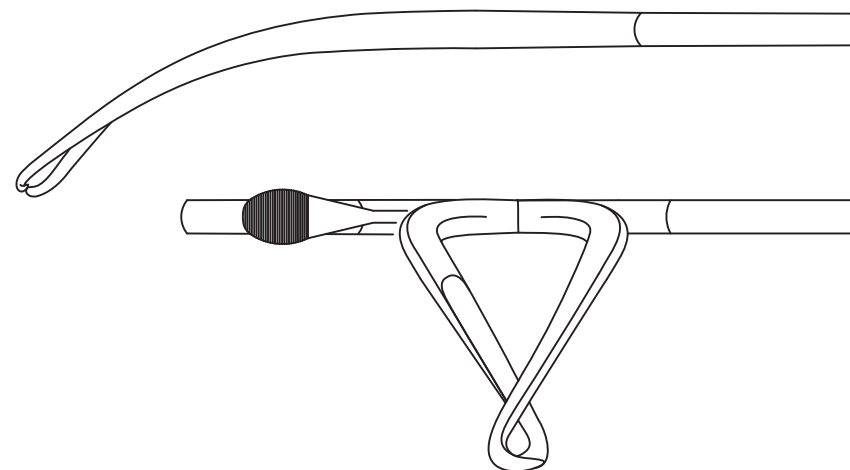

Gelpi Deep Angle Neroma (Crossover) Retractor

Deep angle

| | |
|-----------|------------------|
| 1100-633H | 3 1/2" (9 cm) |
| 1100-633G | 4 1/2" (11.5 cm) |
| 1100-633F | 5 1/2" (14 cm) |
| 1100-633I | 6 1/2" (16.5 cm) |
| 1100-632R | 6 3/4" (17.5 cm) |
| 1100-630N | 7 1/2" (19 cm) |
| 1100-631N | 8" (20 cm) |

Enclosed ratchet / deep angle

| | |
|------------|------------------|
| 1100-633HR | 3 1/2" (9 cm) |
| 1100-633GR | 4 1/2" (11.5 cm) |
| 1100-633FR | 5 1/2" (14 cm) |

* Custom blunt or shortened tips available upon request



enclosed ratched



1100-633G

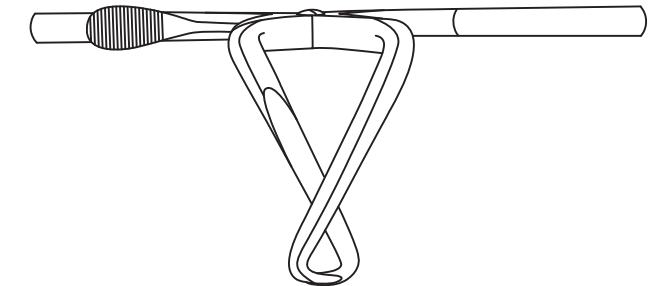
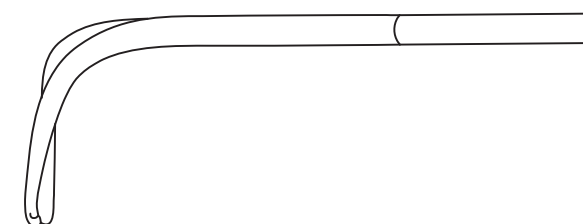

Gelpi Classic Retractor

2 cm across / angle medium blunt tips / 6" (15.2 cm)

1100-632AB

* Custom blunt or shortened tips available upon request

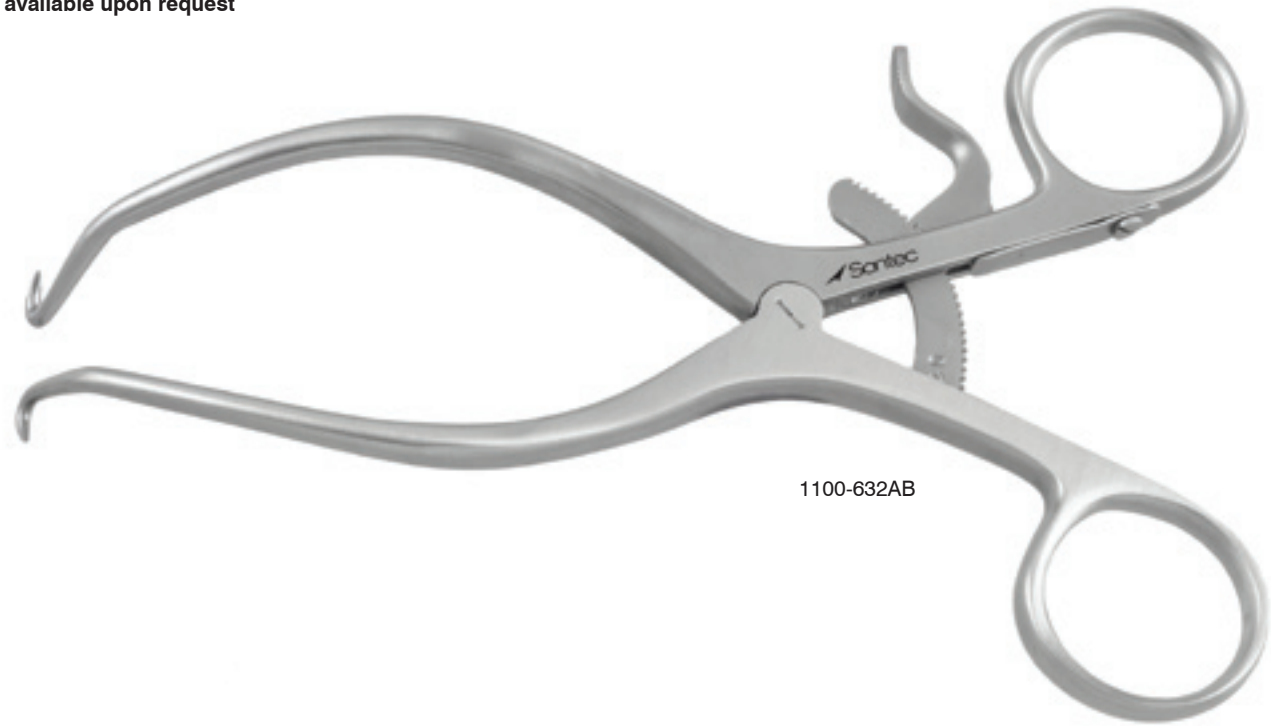

1100-632AB

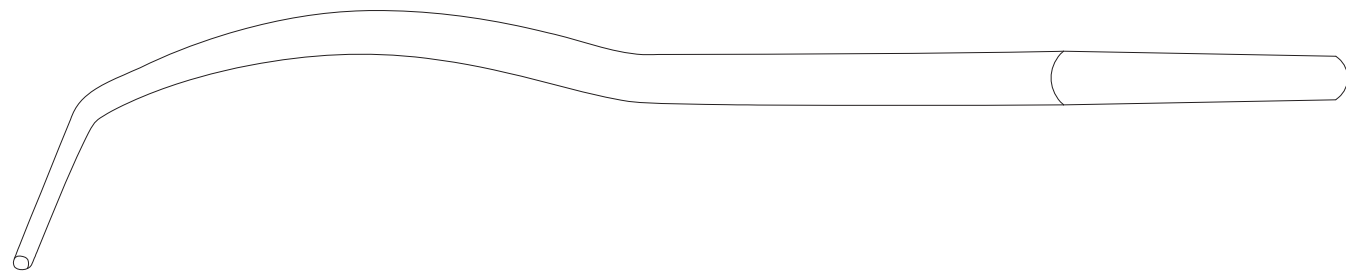
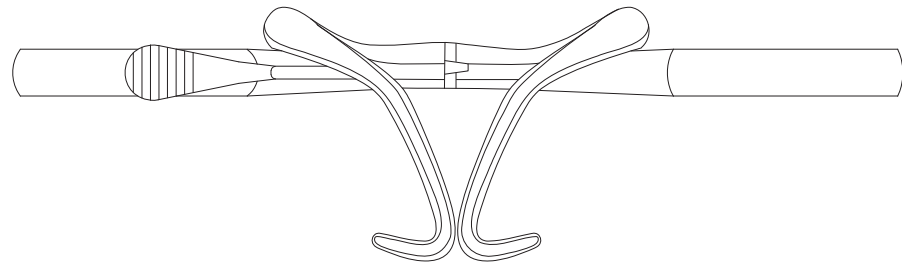

Gelpi Classic Retractor

Standard

| | | |
|-----------|------------------|-------|
| 1100-629 | 3 1/2" (9 cm) | micro |
| 1100-628 | 3 3/4" (9.5 cm) | heavy |
| 1100-629B | 4 1/2" (11.5 cm) | |
| 1100-6280 | 4 1/2" (11.5 cm) | heavy |
| 1100-628B | 5 1/2" (14 cm) | |
| 1100-632 | 6 1/2" (16.5 cm) | |
| 1100-630 | 7 1/2" (19 cm) | |
| 1100-630A | 8" (20 cm) | |

* Custom blunt or shortened tips available upon request



1100-629B

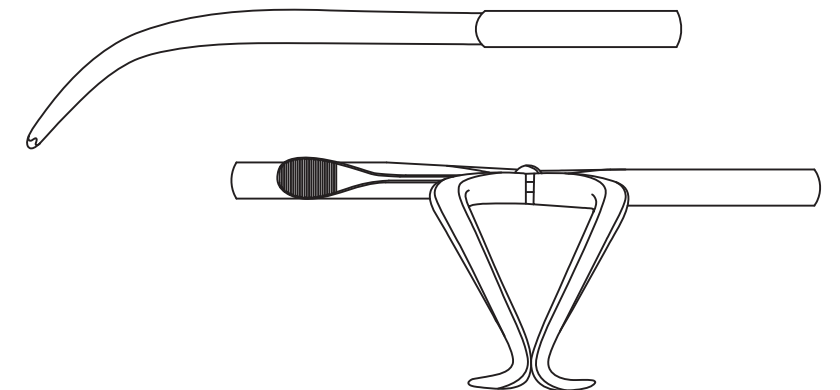

Gelpi Retractor

Enclosed ratchet / 7 1/2" (19.1 cm)

1100-630ER

* Custom blunt or shortened tips available upon request



1100-630ER



Gelpi Retractor

Angle medium blunt tips / with enclosed ratchet

1100-632ABR-7 2 cm deep angle 7"

1100-632ABR-8 3 cm deep angle 8"

* Custom blunt or shortened tips available upon request

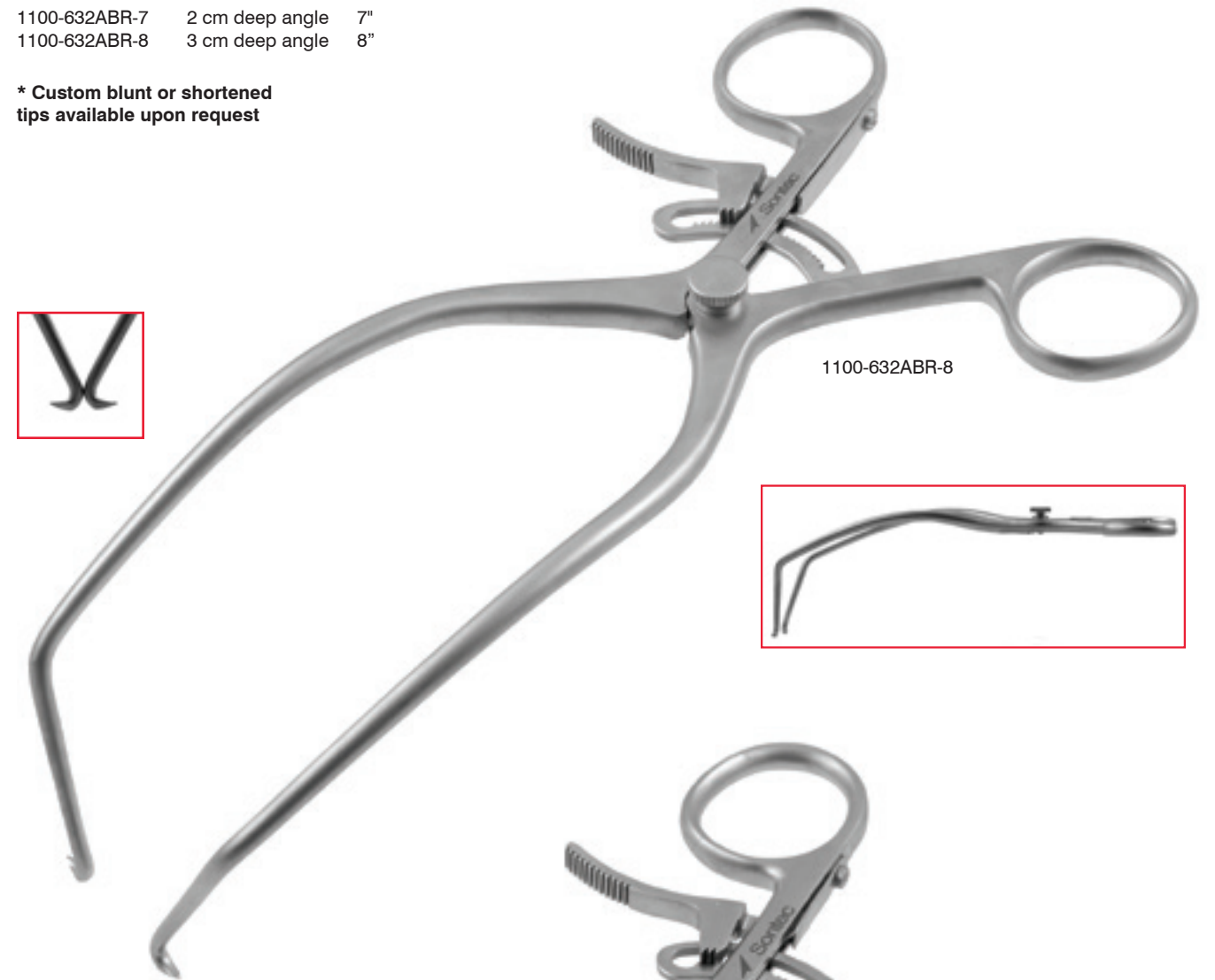

1100-632ABR-8

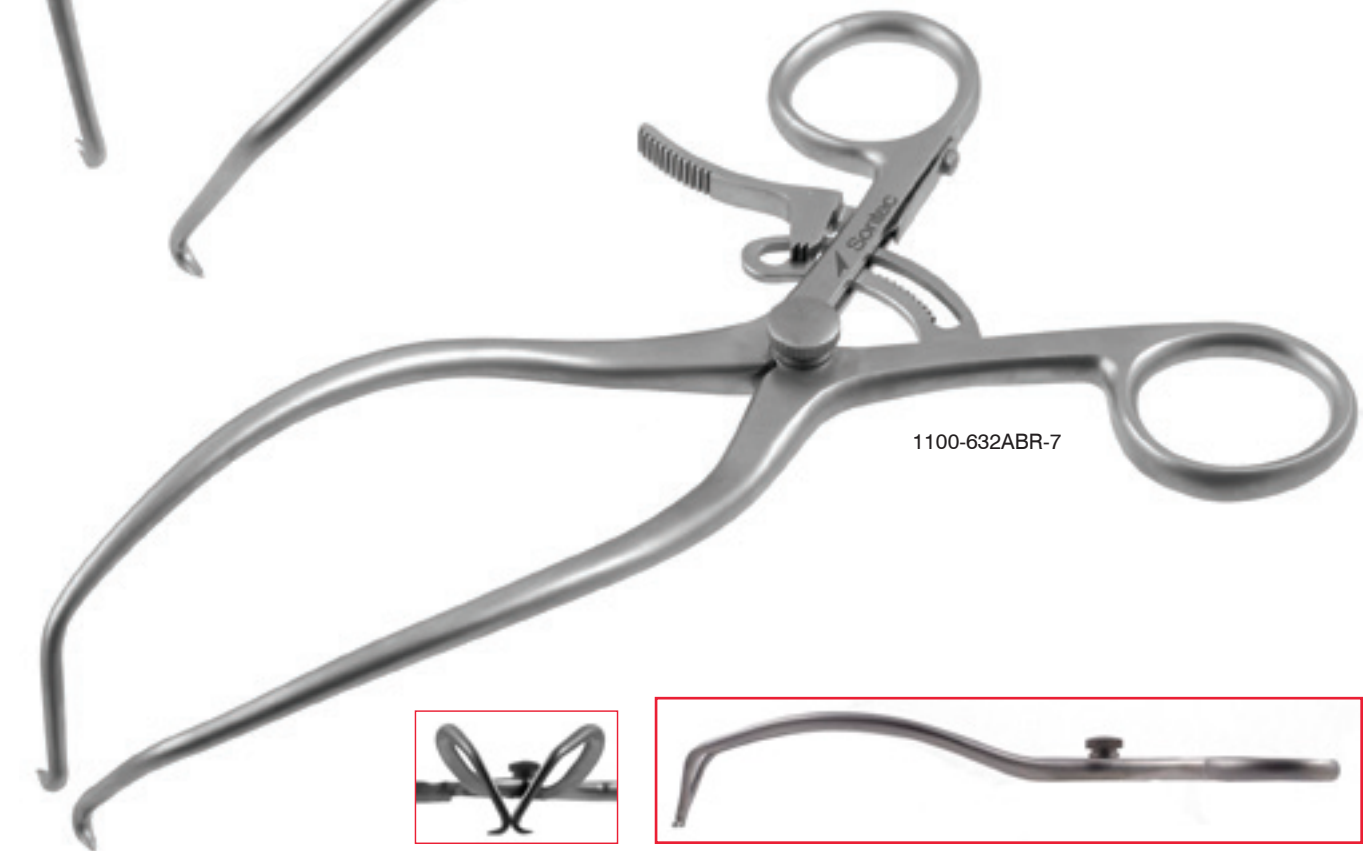

1100-632ABR-7



Gelpi 1st Generation Deep Angle Retractor

Original deep angle

| | |
|-----------|------------------|
| 1100-629G | 3 1/2" (9 cm) |
| 1100-628G | 4 1/2" (11.5 cm) |
| 1100-632G | 5 1/2" (14 cm) |
| 1100-631G | 6 1/2" (16.5 cm) |
| 1100-630G | 7 1/2" (19 cm) |

Original deep angle with enclosed ratchet

| | |
|------------|------------------|
| 1100-629GR | 3 1/2" (9 cm) |
| 1100-628GR | 4 1/2" (11.5 cm) |
| 1100-632GR | 5 1/2" (14 cm) |
| 1100-631GR | 6 1/2" (16.5 cm) |
| 1100-630GR | 7 1/2" (19 cm) |

* Custom blunt or shortened tips available upon request

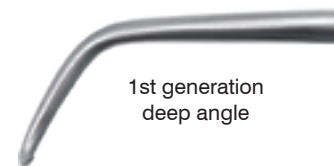

1st generation deep angle



1100-628G



1100-629GR

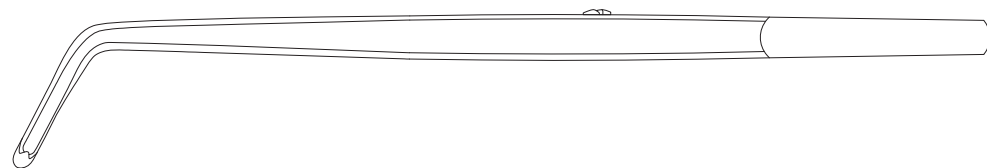
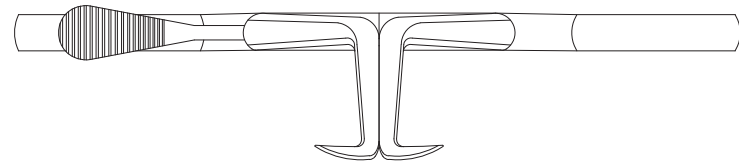

Gelpi Offset Arm Left & Right

3 1/2"

| | |
|-----------|-------------------------------|
| 1100-6332 | left 5/8" (17mm) x 1" (25mm) |
| 1100-6333 | right 1" (25mm) x 5/8" (17mm) |

4 1/2"

| | |
|-----------|-----------------------------------|
| 1100-6282 | left 7/8" (22mm) x 1 1/4" (32mm) |
| 1100-6283 | right 1 1/4" (32mm) x 7/8" (22mm) |

5 1/2"

| | |
|-----------|---------------------------------|
| 1100-6292 | left 1" (25mm) x 1 1/2" (38mm) |
| 1100-6293 | right 1 1/2" (38mm) x 1" (25mm) |

6 1/2"

| | |
|-----------|-------------------------------------|
| 1100-6312 | left 1 5/8" (42mm) x 2 1/8" (53mm) |
| 1100-6313 | right 2 1/8" (53mm) x 1 5/8" (42mm) |

7 1/2"

| | |
|-----------|-------------------------------------|
| 1100-6322 | left 1 1/4" (32mm) x 2 1/4" (57mm) |
| 1100-6323 | right 2 1/4" (57mm) x 1 1/4" (32mm) |

8"

| | |
|-----------|---------------------------------|
| 1100-6334 | left 2" (51mm) x 2 1/2" (67mm) |
| 1100-6335 | right 2 1/2" (67mm) x 2" (51mm) |

* Custom blunt or shortened tips available upon request



1100-6322

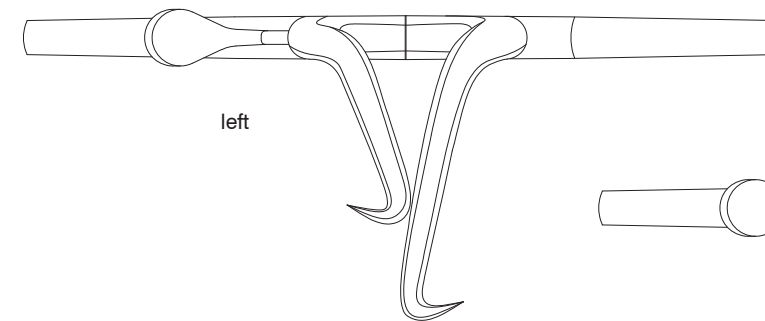

left

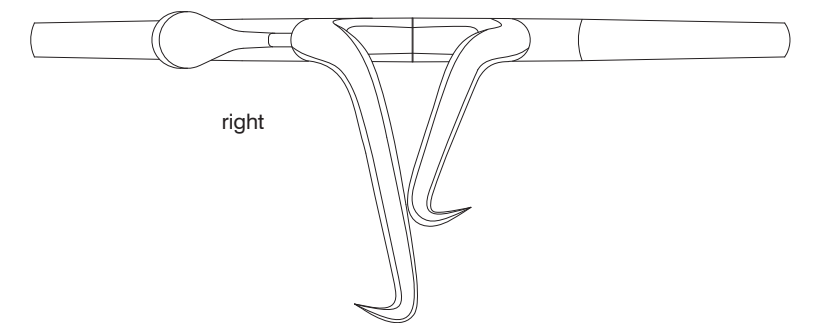

right

Gelpi Retractor

Parallel prongs with blunt tips / 6 1/2" (16.5 cm)
1100-631M

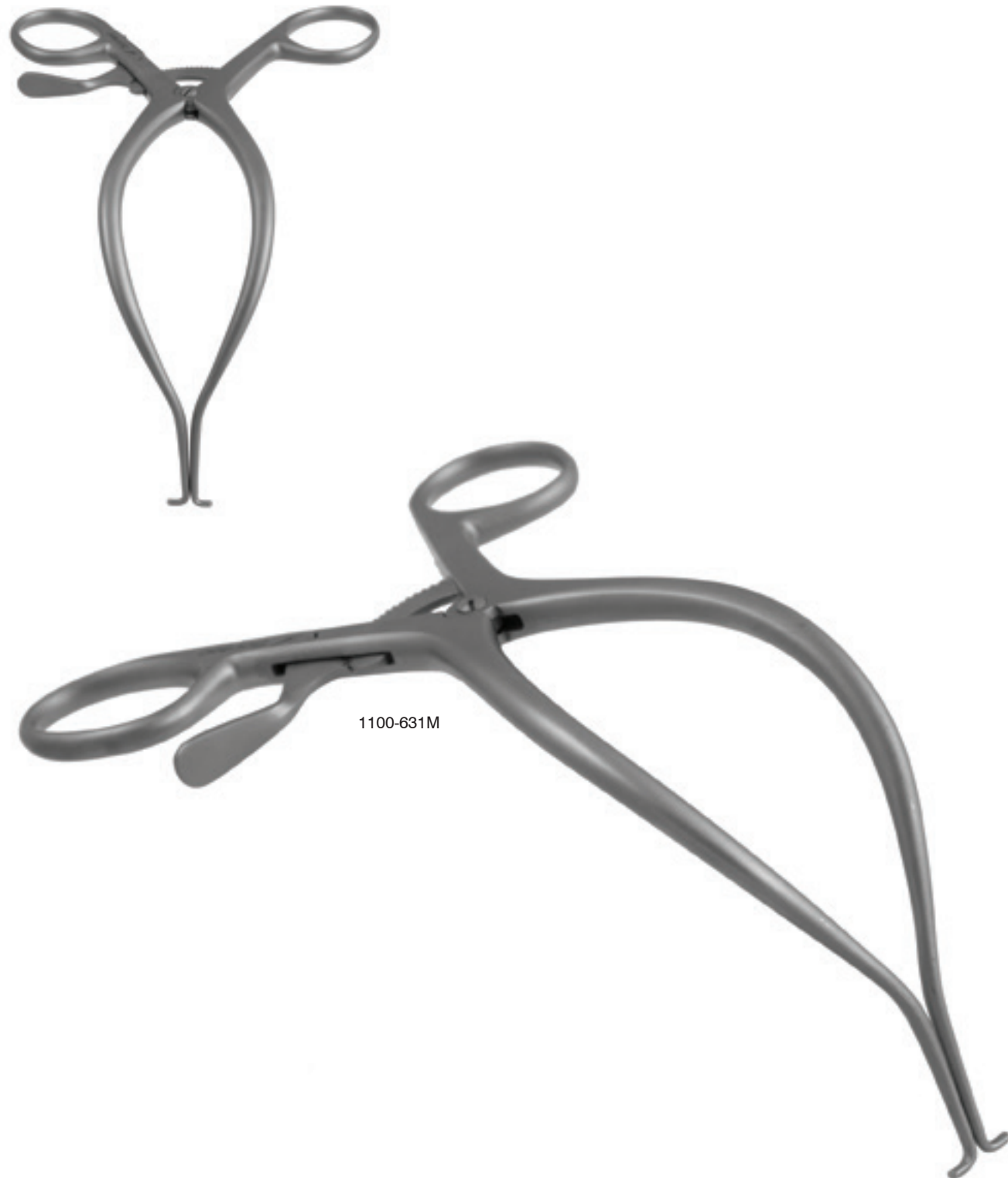

Foremann Kwire Distractor

417-062 small closed arms 6"
417-062A small outspread arms 6"
417-062B large closed arms 8 1/4"
417-062C large outspread arms 8 1/4"

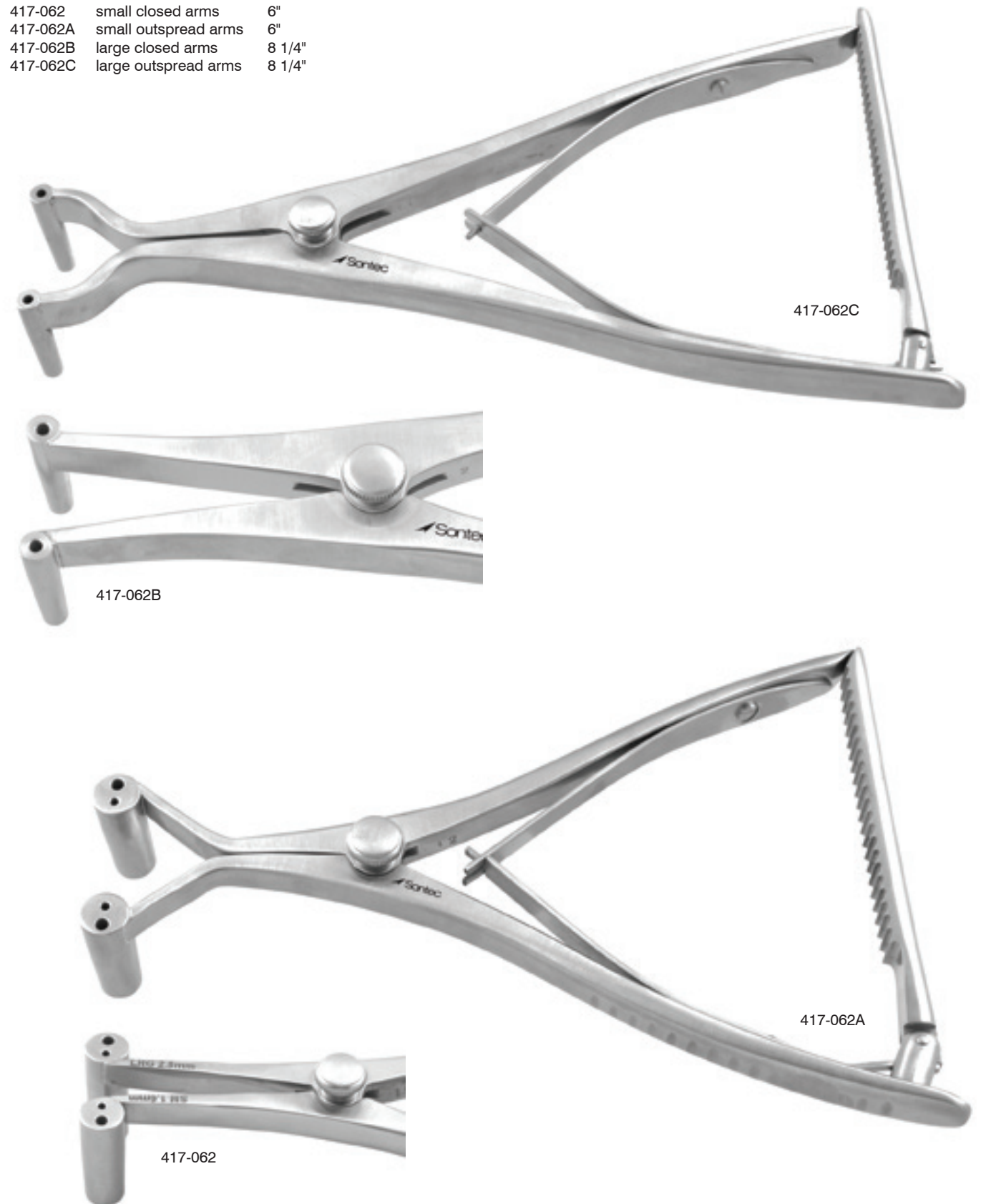

Foremann Kwire Distractor

Tapered arms / 7 1/2" (19.1 cm)

417-062D



417-062D

Mini Foremann Distractor

Tapered arms / 5" (12.7 cm)

417-061



417-0621

Davis Stifle Retractor

With speed lock / 6 3/4" (17 cm)
1103-290

* Custom blunt or shortened tips available upon request



1103-290

Allen Inge Stifle Retractor

With speed lock / 11" (27.9 cm)
1103-297

* Custom blunt or shortened tips available upon request



1103-297

Inge Neroma Retractor

With crossover tip / 6 1/2" (16.5 cm)
417-048 with speedlock
417-048R with ratchet

* Custom blunt or shortened tips available upon request



417-048



417-048R

Mini Inge Neroma Retractor

With crossover tip / speed lock / 5" (12.7 cm)

417-0482

* Custom blunt or shortened tips available upon request



417-0482

Mini Inge Neroma Ceramitec Retractor

With crossover tip / speed lock / 5" (12.7 cm)

417-0482B

* Custom blunt or shortened tips available upon request



417-0482B

Wellace Stifle Retractor

Improved retraction / turn-key action

1100-635 standard

1100-635C crossover style



1100-635



1100-635C

Sisson Spring Retractor

Sharp / 1 x 1 prongs / with ratchet / 4" (10 cm)

220-114

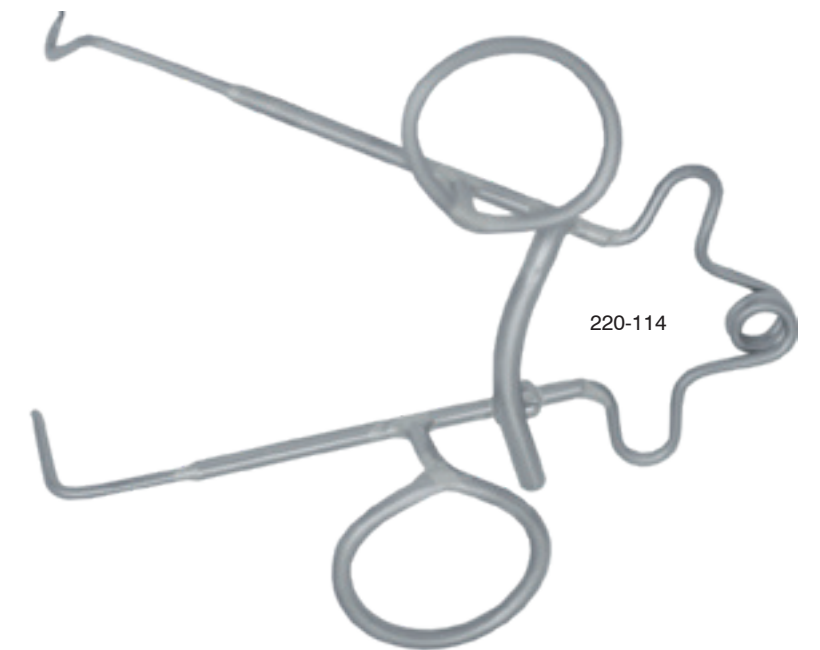

220-114

Vickers Self-Retaining Retractor

| | | |
|---------|----------------|--------------|
| 220-220 | solid blades | 3 1/8 (8 cm) |
| 220-222 | 2 blunt blades | 2 7/8 (7 cm) |
| 220-224 | 3 blunt blades | 3 1/2 (9 cm) |

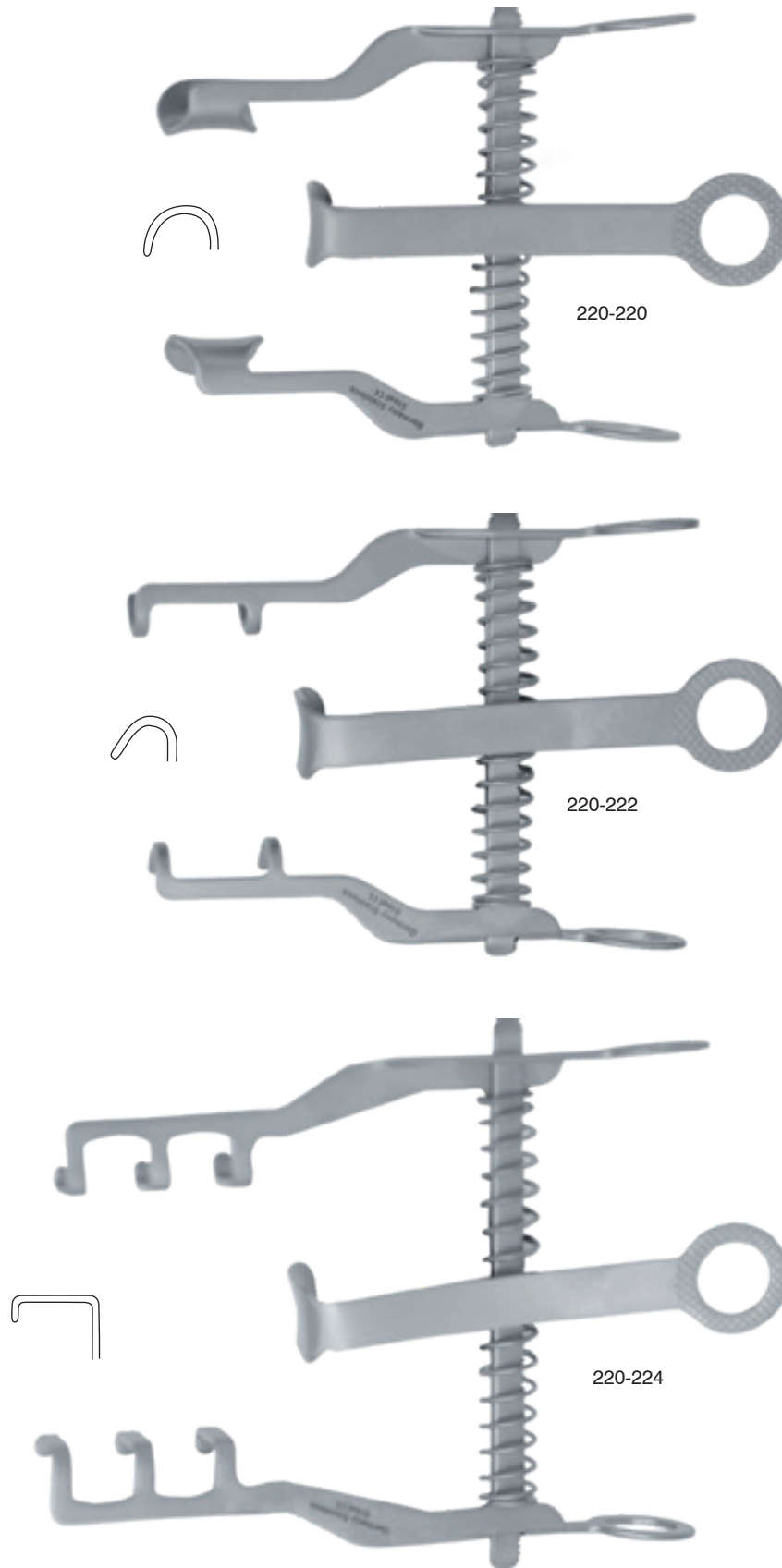

Finsen Self-Retaining Retractor

2 x 3 prongs

| | | |
|---------|-------|-----------------|
| 220-128 | sharp | 2" (5 cm) |
| 220-126 | blunt | 2" (5 cm) |
| 220-136 | blunt | 3 1/8" (7.5 cm) |

3 x 4 prongs

| | | | |
|---------|-------|---------------|-----------------------|
| 220-132 | sharp | 2 3/4" (7 cm) | |
| 220-130 | blunt | 2 3/4" (7 cm) | |
| 220-140 | sharp | 2 3/4" (7 cm) | with adjustment screw |
| 220-138 | blunt | 2 3/4" (7 cm) | with adjustment screw |

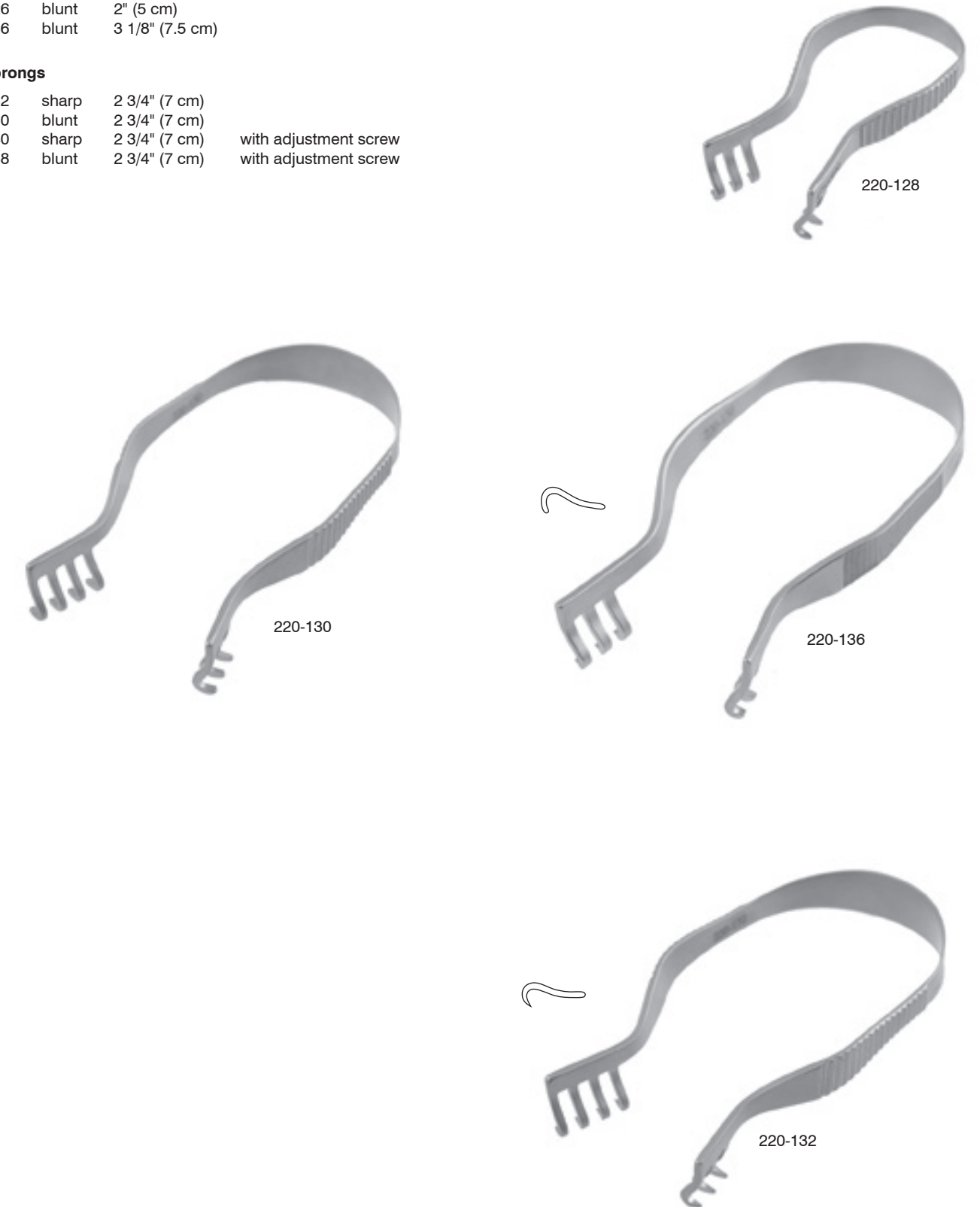

Charnley Initial Incision Retractor

Round frame set

9-15-450-02-SET

Complete set includes the following:

- 9-15-452-20 round frame
- 9-15-452-02 small blade 25mm x 65mm
- 9-15-452-08 large blade 25mm x 50mm
- 9-15-452-12 weight with chain

Square frame set

9-15-460-02-SET

Complete set includes the following:

- 9-15-462-20 square frame
- 9-15-462-02 small blade 25mm x 38mm
- 9-15-462-08 large blade 25mm x 44mm
- 9-15-462-12 weight with chain

Additional blades are also available

Small blades

- 9-15-462-18 25mm x 25mm
- 9-15-462-21 25mm x 50mm
- 9-15-462-23 25mm x 57mm
- 9-15-462-22 25mm x 63mm
- 9-15-462-07 25mm x 75mm
- 9-15-462-14 25mm x 101mm
- 9-15-462-16 25mm x 127mm
- 9-15-462-27 25mm x 114mm

Large blades

- 9-15-462-19 25mm x 25mm
- 9-15-462-26 25mm x 50mm
- 9-15-462-24 25mm x 57mm
- 9-15-462-09 25mm x 63mm
- 9-15-462-13 25mm x 75mm
- 9-15-462-15 25mm x 101mm
- 9-15-462-17 25mm x 127mm
- 9-15-462-28 25mm x 114mm

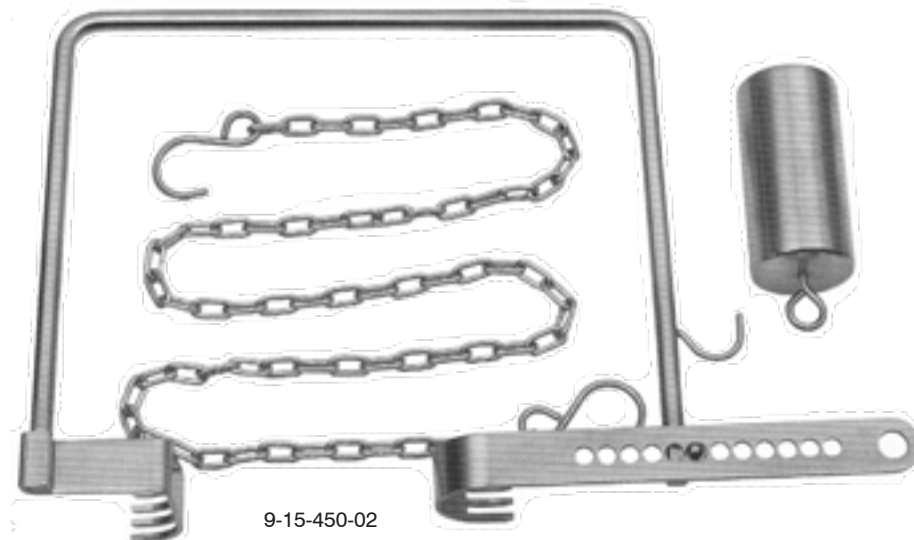

9-15-450-02

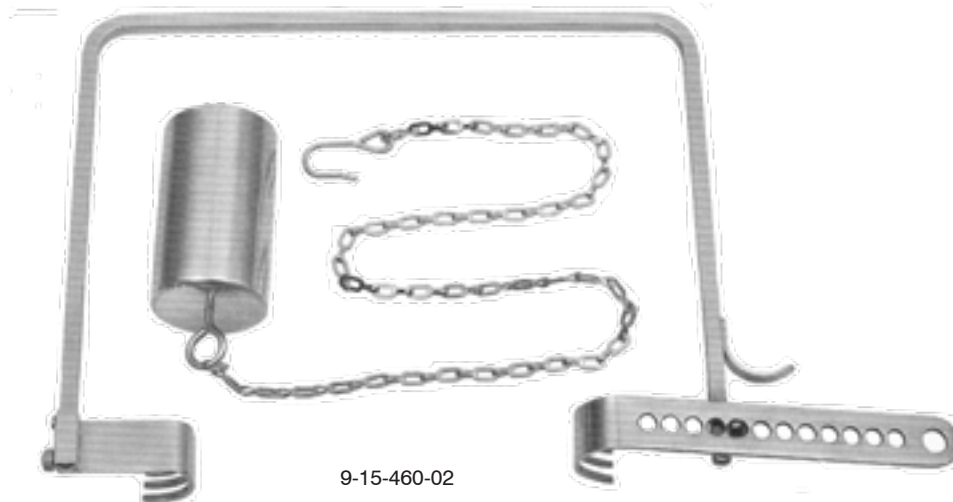

9-15-460-02

Slocum Type Army Navy Retractor

Double ended

6 1/2" (16.5 cm)

207-259



207-259

Taylor Spinal Retractor

7 1/4" (18.5 cm)

417-070 1 1/4" x 3" blade

8" (20.5 cm)

417-072 1 1/4" x 4" blade



417-072

Kujat Shoulder Retractor

207-520 30 mm blade

207-525 35 mm blade



207-520

Murphy-Lane Bone Skid

Double ended / 1 1/4" cup & 3/4" cup / 12" (30.5 cm)

310-160



310-160

Aufranc Cobra Retractor

10 1/2" (26 cm)

- 1100-682 sharp serrated tip
- 1100-684 blunt serrated tip
- 1100-686 blunt smooth tip
- 1100-687 pointed smooth tip

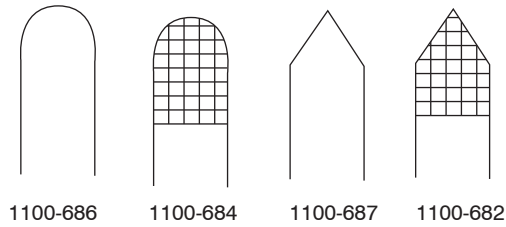

1100-686

Sontec Stifle Thrust Lever

- 1100-6691 8 3/8"
- 1100-6692 11"



1100-6691

1100-6692

Lahey Retractor

7 3/4" (20 cm)

207-300



207-300

Mathieu Retractor

Set of 2 / double ended / 1 end with 2 prongs / 8" (20.3 cm)

207-254



207-254

Hibbs Retractor

Sharp teeth / 9 1/4" (23.5 cm)

- 207-389 25 mm w x 50 mm d
- 207-390 26 mm w x 75 mm d
- 207-391 25 mm w x 100 mm d



207-389



207-390



207-391

Meyering Retractor

- 207-415 large blade 3 1/2" x 2" x 9 1/2"
- 207-413 medium blade 3" x 1" x 9 1/2"
- 207-411 small blade 2" x 5/8" x 9 1/2"



207-413



207-415

Malleable Ribbon Retractor

Hollow Grip Handle

- 207-482 3/4" wide blade
- 207-484 1" wide blade
- 207-486 1 1/4" wide blade
- 207-488 1 1/2" wide blade
- 207-490 2" wide blade



207-486



207-488



207-490

Malleable Ribbon Retractor

Malleable

- 207-454 1/4" x 7"
- 207-455 3/8" x 7"
- 207-456 1/2" x 7"
- 207-460 5/8" x 7"
- 207-461 3/4" x 7"
- 207-462 1" x 7"
- 207-463 3/4" x 13"
- 207-464 1" x 13"
- 207-465 1 1/4" x 13"
- 207-466 1 1/2" x 13"
- 207-467 2" x 13"
- 207-468 2 1/2" x 13"
- 207-469 3" x 13"
- 207-470 3 1/2" x 13"
- 207-471 4" x 13"
- 207-472 5" x 13"
- 207-474 1 3/4" x 13"
- 207-473 2 3/4" x 13"



207-454



207-462



207-465



207-468

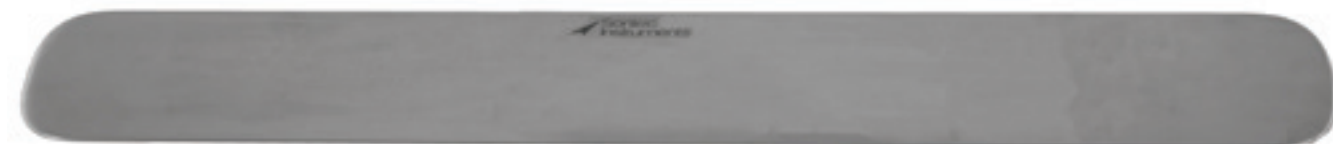

207-474



207-473

Volkman Retractor

Sharp / 4 1/2" (11.5 cm)

- 1100-648 2 prong
- 1100-650 3 prong
- 1100-652 4 prong
- 1100-654 6 prong



1100-648

Sharp / 8" (20 cm)

- 1100-656 2 prong
- 1100-658 3 prong
- 1100-662 6 prong



1100-650

Sharp / 8 1/2" (22 cm)

- 1100-660 4 prong



1100-652

Blunt / 4 1/2" (11.5 cm)

- 1100-648B 2 prong
- 1100-650B 3 prong
- 1100-652B 4 prong
- 1100-654B 6 prong

Blunt / 8 1/2" (22 cm)

- 1100-656B 2 prong
- 1100-658B 3 prong
- 1100-660B 4 prong
- 1100-662B 6 prong

Sharp / 8 3/4" (23 cm)

- 214-052 4 prong



1100-660



1100-662



214-052

Senn Retractor

Double-ended / 6 1/4" (16 cm)

- 1100-668 sharp
- 1100-668B blunt
- 1100-668T sharp titanium



Senn Retractor

Blue electro coated / Double-ended / 6 1/4" (16 cm)

- 1100-669 sharp
- 1100-669B blunt



Ragnell Retractor

Double-ended / 6" (15 cm)

- 205-849



Ragnell Retractor

Blue coated / double-ended / 6" (15 cm)

- 205-849B



Richardson Retractor

9 1/2" overall length / loop grip handle

- 207-338 1" x 3/4"
- 207-340 1" x 1 1/4"
- 207-342 1 1/2" x 1 1/2"
- 207-345 2" x 3/4"



9 1/4" overall length / hollow grip handle

- 207-333 2" x 3/4"

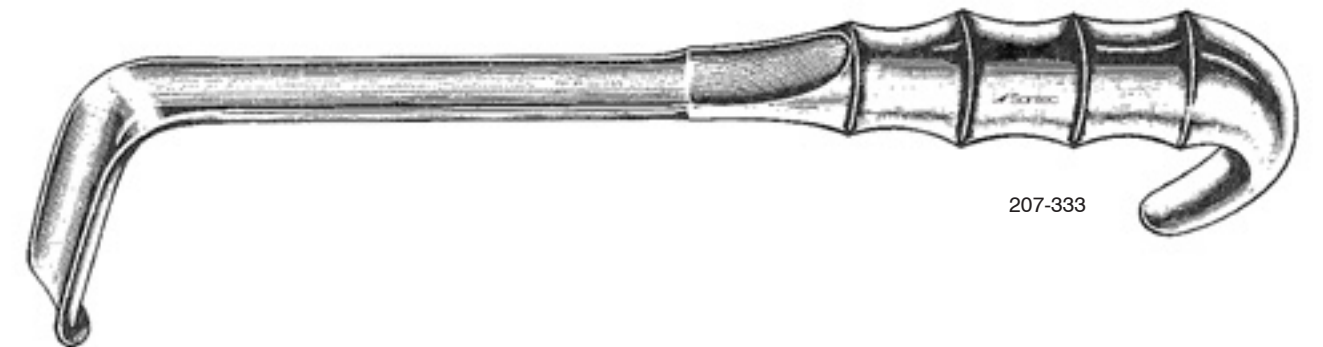

11" overall length / lamb grip handle

- 207-326 1" x 3/4"
- 207-328 1 1/4" x 1"
- 207-330 1 1/2" x 1 1/2"



Senn Retractor

Double-ended / 6 1/4" (16 cm)

- 1100-668 sharp
- 1100-668B blunt
- 1100-668T sharp titanium



1100-668B



1100-668T

Senn Retractor

Blue electro coated / Double-ended / 6 1/4" (16 cm)

- 1100-669 sharp
- 1100-669B blunt



1100-669



1100-669B

Ragnell Retractor

Double-ended / 6" (15 cm)

205-849



205-849

Ragnell Retractor

Blue coated / double-ended / 6" (15 cm)

205-849B



205-849B

Richardson Retractor

9 1/2" overall length / loop grip handle

- 207-338 1" x 3/4"
- 207-340 1" x 1 1/4"
- 207-342 1 1/2" x 1 1/2"
- 207-345 2" x 3/4"



207-340

9 1/4" overall length / hollow grip handle

- 207-333 2" x 3/4"

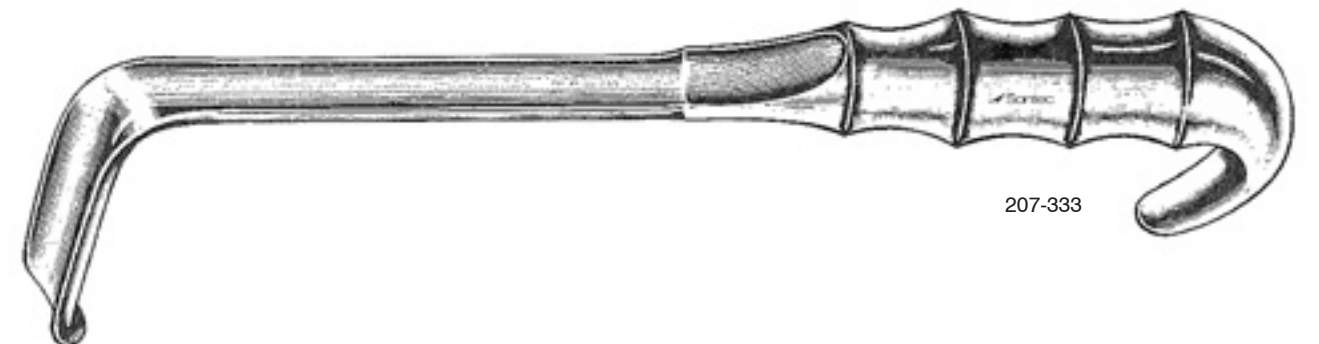

207-333

11" overall length / lamb grip handle

- 207-326 1" x 3/4"
- 207-328 1 1/4" x 1"
- 207-330 1 1/2" x 1 1/2"



207-326

Richardson-Eastman Retractor

207-319-SET set of two, one large and one small
 207-321 small 10" (25 cm)
 207-323 large 11" (28 cm)



207-319-SET

Kelly Retractor

Hollow grip handle / 9 1/2" (24 cm)

207-358 1 1/2" x 2"
 207-360 2" x 2 1/2"
 207-362 2 1/2" x 3"
 207-364 3" x 3 1/2"



207-364

Kelly Lamb Retractor

10" overall length

207-350 1 1/2" x 2"
 207-352 2" x 2 1/2"
 207-354 2 1/2" x 3"
 207-356 3" x 3 1/2"



207-350

U.S. Army-Navy Retractor

Set of 2 / 8 1/2" (21.5 cm)

1100-670



1100-670

U.S. Army-Navy Retractor

Set of 2 / blue electro coated / 8 1/2" (21.5 cm)

1100-670B



1100-670B

Sontec-Hohmann Elevator Retractor

Fenestrated head / 2 prong tip / curved

310-177 11 1/4" (30 cm) 22 mm tip

Radically curved head / sharp tip / curved

310-178 11 1/2" (30 cm) 22 mm tip

Fenestrated head / proximal tibia type / 2 prong tip / curved

310-179 12 1/4" (31 cm) 40 mm tip

Extra long 16" / radically curved head / sharp tip / curved

310-180 16" (40.5 cm)

Radically curved contoured head 120° / sharp

310-182 13" (33 cm) 40mm tip



310-177 310-178 310-179 310-182 310-180

Sontec-Hohmann Elevator Retractor

Extra long tip / C-shaped handle

310-171 10 1/4" 24 mm tip

Radically curved / fenestrated head / sharp tip

310-173 10 1/4" 22 mm tip

Radically curved / contoured head / sharp tip

310-174 12" 40 mm tip

Extra wide tip

310-176 10 3/4" 33 mm tip



310-171 310-173 310-174 310-176

Hohman Elevator Retractor

8 1/2" (21.5 cm)

1100-671 8 mm blade

9 1/4" (23.5 cm)

1100-672 10 mm blade
 1100-673 18 mm blade
 1100-674 25 mm blade
 1100-675 43 mm blade
 1100-676 70 mm blade

9 1/2" (24 cm) / with extra long tip

1100-671E 8 mm blade
 1100-672E 10 mm blade
 1100-673E 18 mm blade



1100-674



1100-675



1100-673E

Sontec-Hohman Retractor

Radical bend / 25 mm tip / 10 1/2" (27 cm)

1100-677



1100-677

Mini Hohman Elevator Retractor

6 1/4" (16 cm)

1100-6780 2.5 mm blade
 1100-679 4 mm blade
 1100-678 6 mm blade
 1100-680 8 mm blade



1100-6780



1100-679



1100-678



1100-680



Sontec Lane Lever Elevator

Ring handle style 30-100 lbs

1100-6696



Hip & Knee Retractor

With Handle / 10" (25.5 cm)
207-405

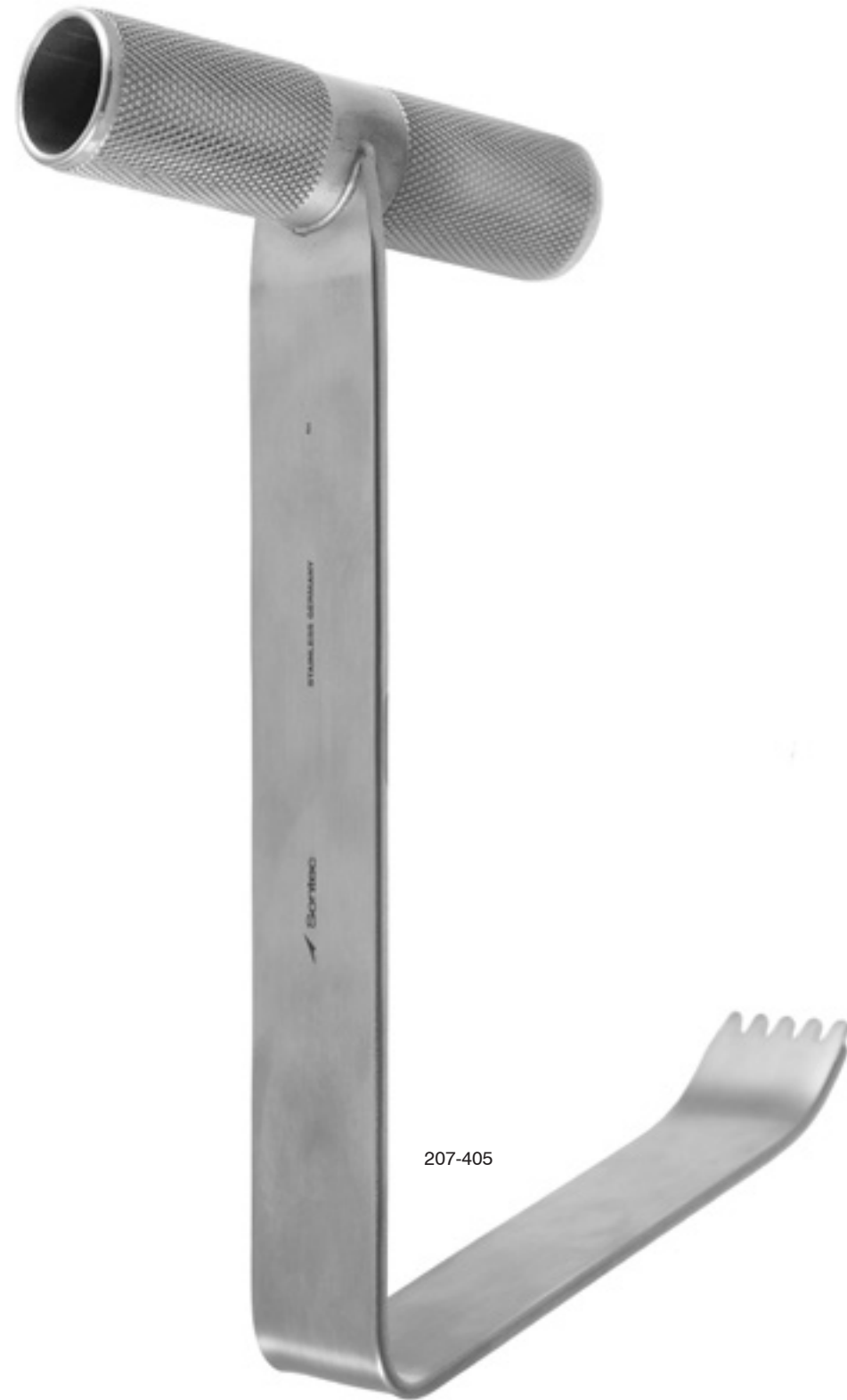

207-405

Lead Hand Stabilizing Restrainer

48-0339 pediatric 9 3/4" (25cm)
48-0340 adult 14 1/2" (37cm)



48-0340



 Sontec Instruments®

Orthopedic Spinal LAMINA SPREADERS

Platypus Micro Inge Lamina Spreader

Platypus tip / 7" (17.8 cm)
417-049



Inge Lamina Spreader

With unique selection of tips /
adult size / 9 1/2" (24 cm)
417-060 standard tip
417-060A tip A
417-060B tip B
417-060C tip C
417-060D tip D
417-060E tip E



Inge Lamina Spreader

With unique selection of tips / pediatric
/ 6 1/2" (16.5 cm)

417-064 standard tip
417-064A tip A
417-064B tip B
417-064C tip C
417-064D tip D micro tip 1mm wide
417-064E tip E smooth
417-064F flat delicate, cross
serrated tips with
calibrated ratchet

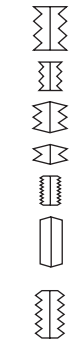

child standard tip

tip A

tip B

tip C

tip D

tip E

tip F

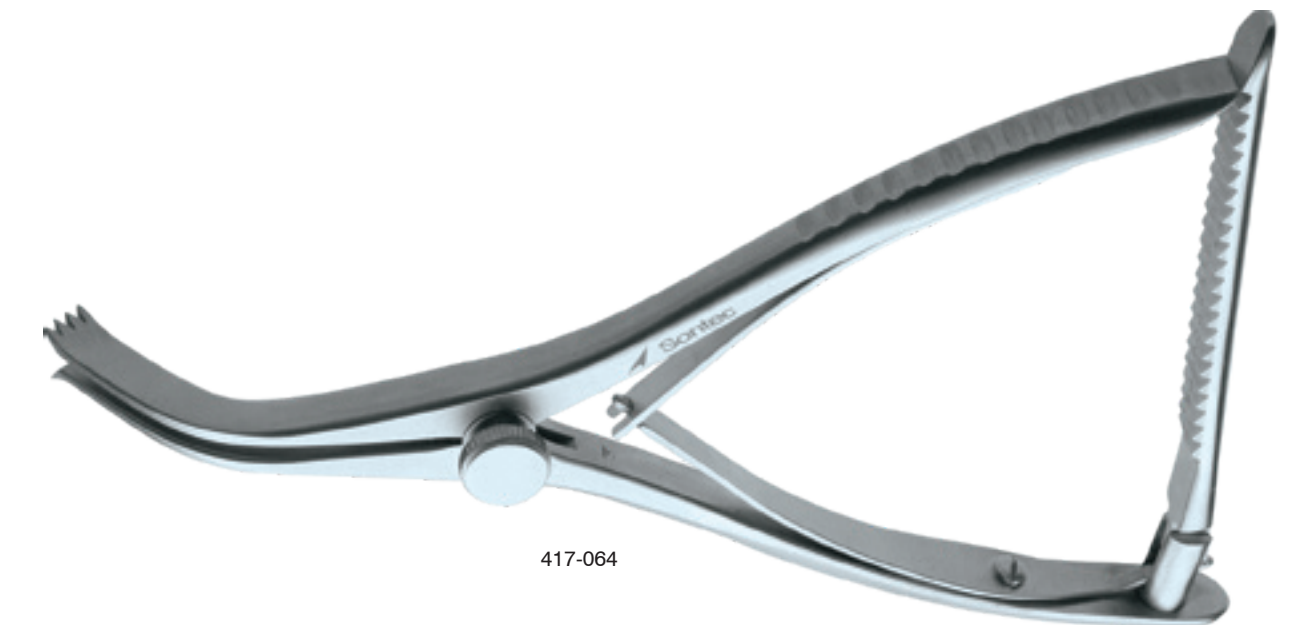
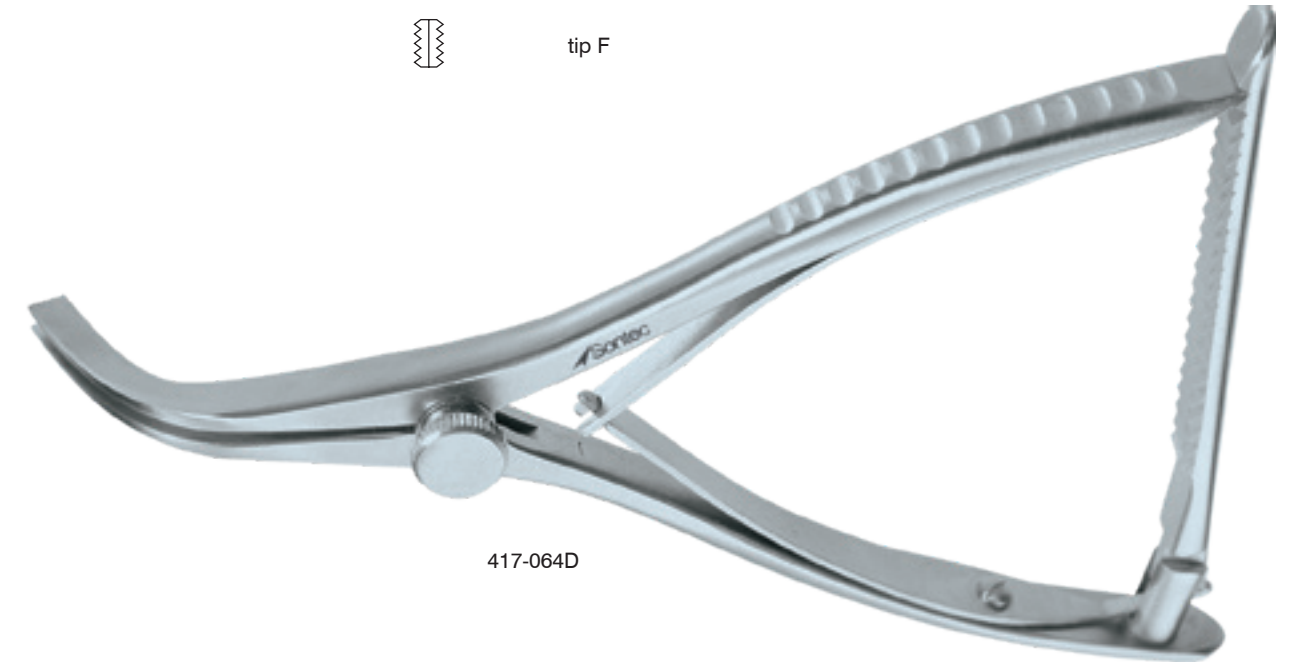

Micro Inge Lamina Spreader

“tip D” / with speed lock

417-063 micro 1 mm serrated tips

* also available with ratchet design



Inge Lamina Spreader Extra Large Retractor

Leverage shaped concave blades / 11" (28 cm)

417-057 large 16 mm tip concave jaws

417-056 small 11mm tip

417-056D micro tip 1 mm tip

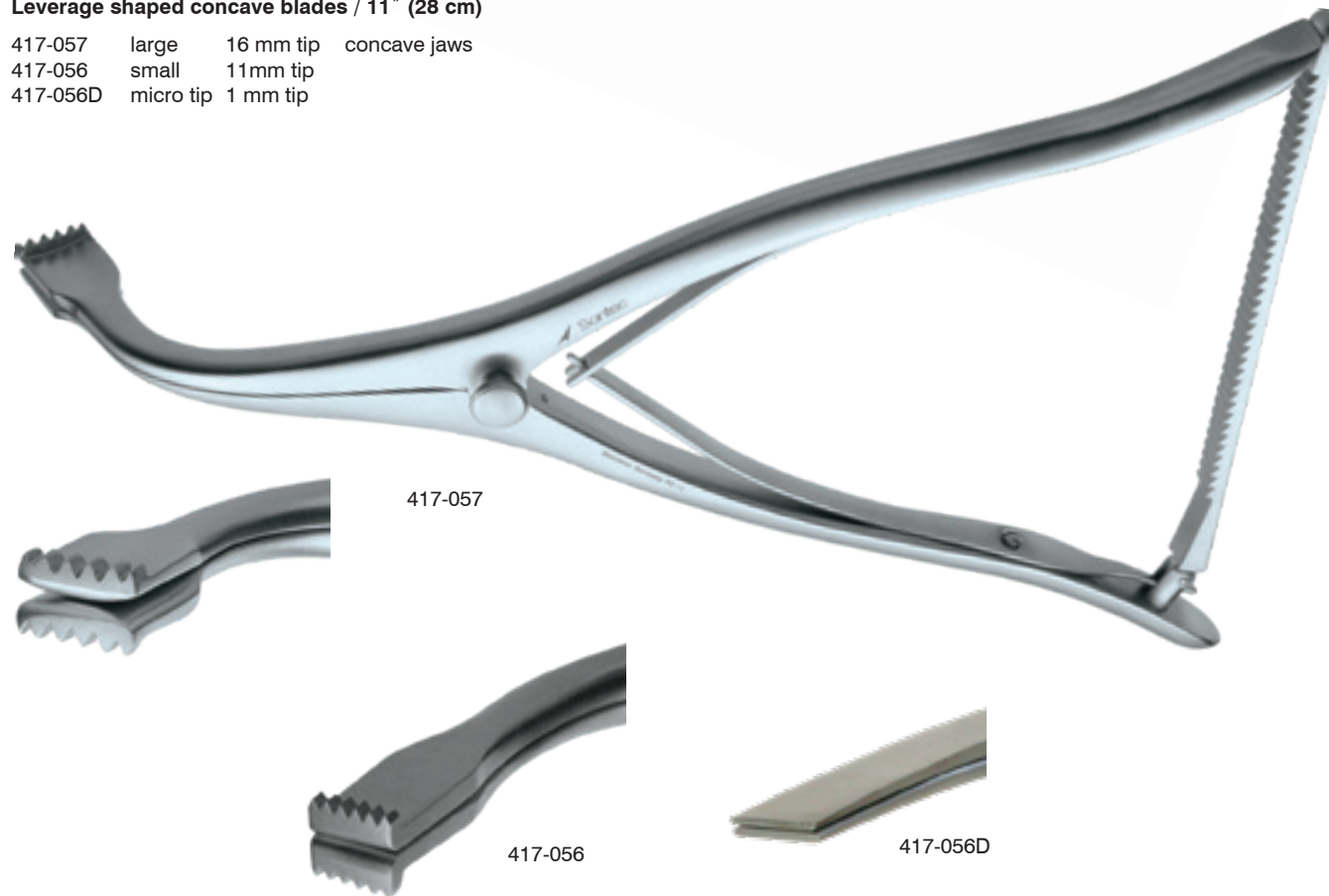

Inge Micro Ring Handle Lamina Spreader

With ratchet / 6 1/4" (16 cm)

417-046 4x4 mm tip

417-047 1.5x4 mm tip

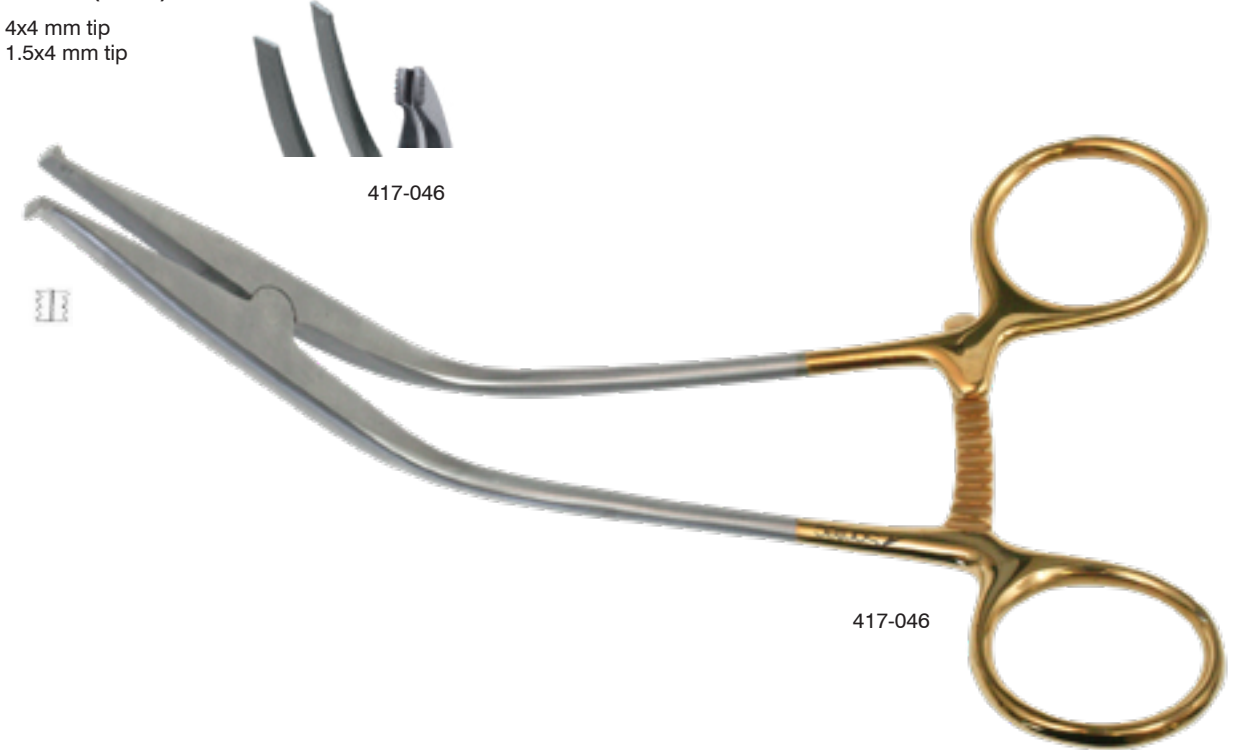

Cloward Vertebral Cervical Spreader Retractor

416-137



416-137

Cloward Lamina Spreader

52-1301 6 1/4" (15.9 cm)



52-1301

Inge Lamina Retractor

Classic jaws / with speedlock

| | | |
|----------|---------------------|------------------------|
| 417-055 | 3.5" working length | 10 3/4" overall length |
| 417-055L | 5" working length | 12" overall length |
| 417-055S | 1.5" working length | 8" overall length |

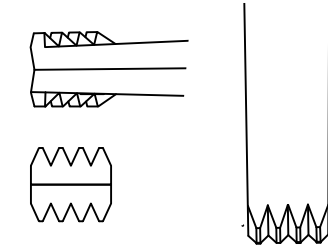

417-055L



417-055S



 Sontec Instruments®

Orthopedic ROD HOLDERS & BENDERS

Rod Holder Kern Type

With ratchet / 10" (25.5 cm) / round jaw,
with threaded hole / holds rods up to 6 mm

355-222

Prism jaw / holds rods 5 mm & 5.5 mm

355-223



Ferris Smith Rod Holder

For Ø 5.5 rods / 7" (17.8 cm)

355-226



Mini Rod Holder

7" (17.8 cm)

355-2213 5.5 mm

8 1/4" (21 cm)

355-221 2.5 mm

355-2215 5.5 mm

8 3/4" (22 cm)

355-2214 5.0 mm

355-2217 5.5 mm

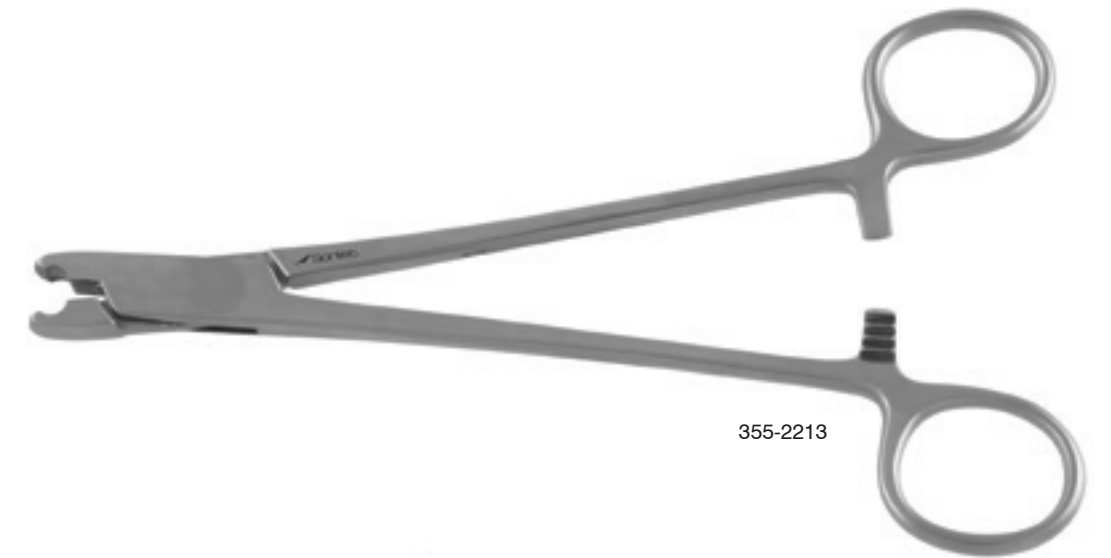

Rod Gripping Pliers

Adjustable to accommodate all
Rod sizes / 8 3/4" (22cm)

1103-134



1103-134

Wire Bender

Bends and stabilizes
K-wire / cuts wire up to
1.6 mm / 7 1/2" (19 cm)

1103-156



1103-156

Rod Bender Small

Double sided / 7" (18 cm)

355-238 fits 3mm and 4mm rods

355-239 universal 3mm and 4mm rods

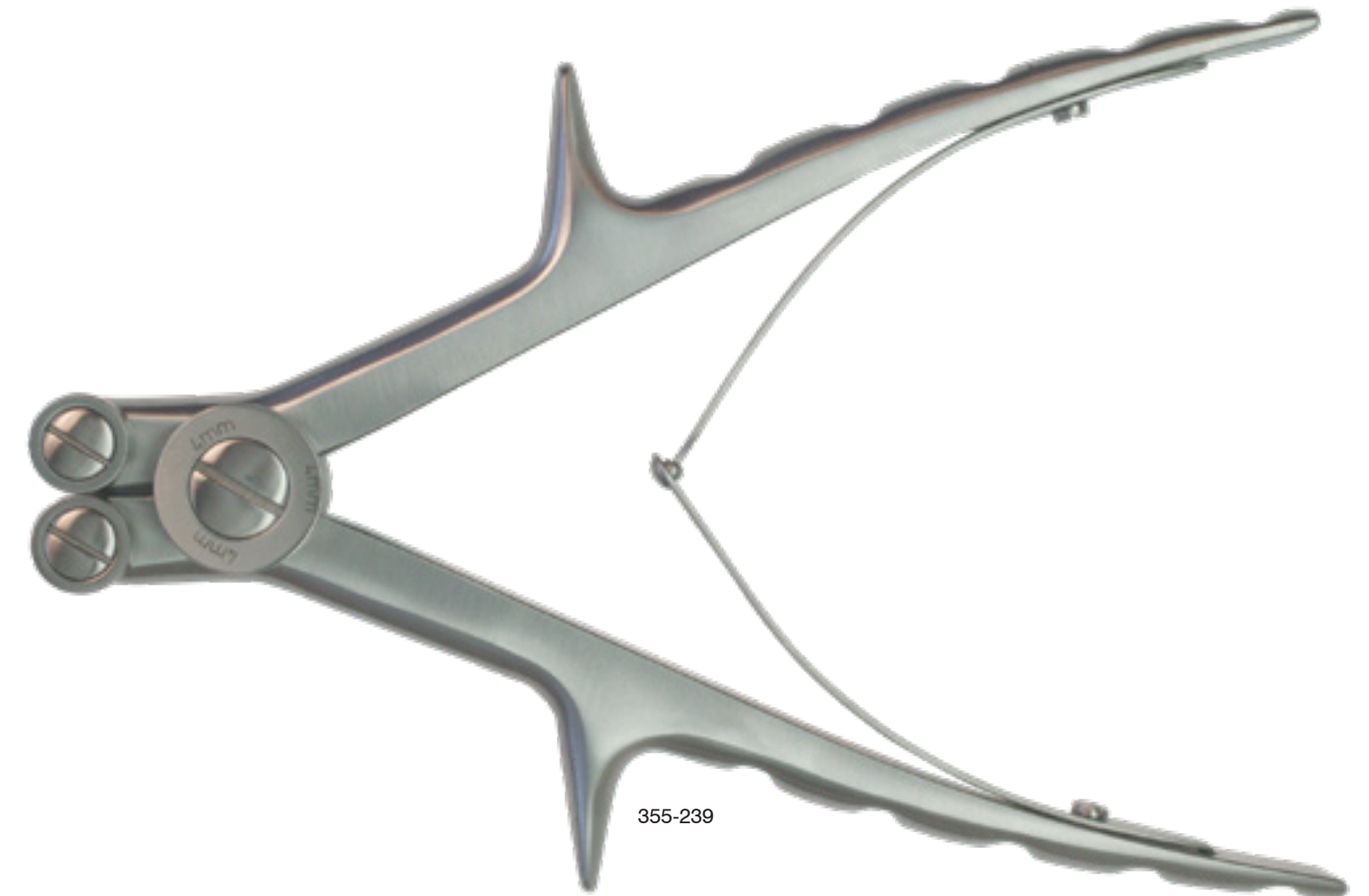

355-239



355-238

Rod Bender Large

11" (28 cm)

355-240 bends rods up to 7 mm
355-241 bends rods up to 5.5 mm



355-240

Aderer Wire Bending Pliers

5 3/4" (14.5 cm)

1103-120



1103-120

Waldsachs Universal Pin Bender Pliers

6" (15 cm)

1103-138
1103-1381 TC



1103-138



1103-1381



 Sontec Instruments®

Orthopedic SCREWDRIVERS

Hexagonal Screw Driver

Screw drivers / phenolic handle

| | | |
|----------|--------|----------------|
| 1106-261 | 2.5 mm | 7" (18cm) |
| 1106-263 | 3.5 mm | 7" (18 cm) |
| 1106-270 | 2.5 mm | 7 3/4" (20 cm) |
| 1106-260 | 2.5 mm | 9" (23 cm) |
| 1106-262 | 3.5 mm | 9" (23 cm) |
| 1106-271 | 2.5 mm | 9" (23 cm) |

Universal screw driver sleeve

1106-270S



1106-263



1106-270S



sleeve and screw drivers sold separately

Phenolic handle / 10 1/2" (27 cm)

| | | |
|----------|-------|------------------------|
| 1106-257 | 2.5mm | screw driver w/ sleeve |
| 1106-258 | 2.5mm | screw driver |
| 1106-259 | | sleeve |



1106-258



1106-259



1106-257

A.O. Type Universal Screw Driver

Screw drivers / 5" (13 cm)

| | |
|----------|---------------------------|
| 1106-280 | AO type tap handle |
| 1106-281 | AO type tap handle swivel |

Screw driver shaft

| | |
|----------|--------|
| 1106-283 | 1.5 mm |
| 1106-285 | 2.5 mm |
| 1106-284 | 3.5 mm |



1106-281



1106-285



1106-281 with 2.5mm shaft and universal sleeve

Lubra® Screw Driver

Phenolic Handle / 6 3/4" (17 cm)

| | |
|----------|-----------|
| 1106-965 | flat head |
| 1106-967 | hex head |

Phenolic handle / 10" (25 cm)

| | |
|----------|-------------|
| 1106-264 | single slot |
| 1106-266 | cruciform |
| 1106-268 | phillips |



1106-967

Omega Mini Screwdriver Set

1106-2871 Set includes:

- 1106-287 Omega mini screwdriver round handle 4" (10.2 cm)
- 1106-289A 1.5mm hex screw driver shaft 2" (5 cm)
- 1106-289B 1.5mm cruciform hex screw driver shaft 2" (5 cm)
- 1106-289C sleeve for cruciform hex mini screw driver shaft 1.5 mm



1106-287



sleeve and screw drivers sold seperatly



1106-289A



1106-289B



1106-289C

1106-289A

1106-289B

AO Type Universal Screwdriver Set

1106-2881 Set includes:

- 1106-288 AO type tap handle swivel 4 1/4" (11 cm)
- 1106-289A 1.5mm hex screwdriver shaft 2" (5 cm)
- 1106-289B 1.5mm cruciform hex screwdriver shaft 2" (5 cm)
- 1106-289C universal sleeve mini screwdriver shafts 1.5 mm



1106-288



sleeve and screw drivers sold seperatly



1106-289C



1106-289A



1106-289B



1106-289A

1106-289B

1106-289C

Screw Holding Forceps

For titanium and stainless steel screws / 5 3/4" (14.6 cm)

136-801T



136-801T



 Sontec Instruments®

Orthopedic DRILLS, DRILL GUIDES & CHUCKS

Sontec I.M. Pin Chuck

Stainless steel keyed drill chuck

- 1103-190 3/8"
- 1103-191 5/16"

Key for Sontec I.M. pin chuck

- 1103-185K for 3/8" chuck
- 1103-184K for 5/16" chuck

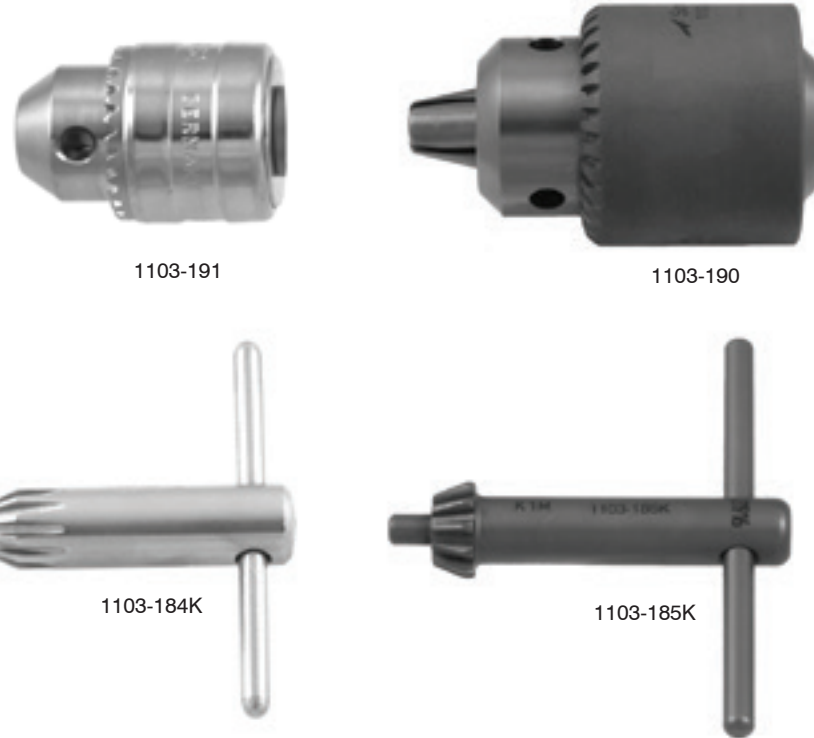

Sontec Hybrid I.M. Pin Chuck

Stainless steel universal use with or without key drill chuck

- 1103-193 3/8"

Key for 3/8" hybrid chuck

- 1103-193K

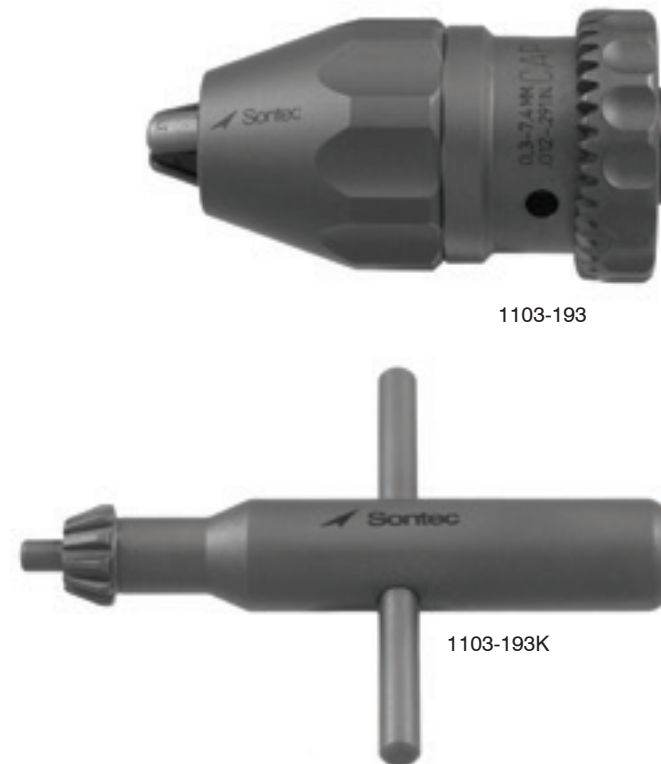

Sontec Keyless I.M. Pin Drill Chuck

Stainless steel chuck with lock system

- 1103-194 3/8"

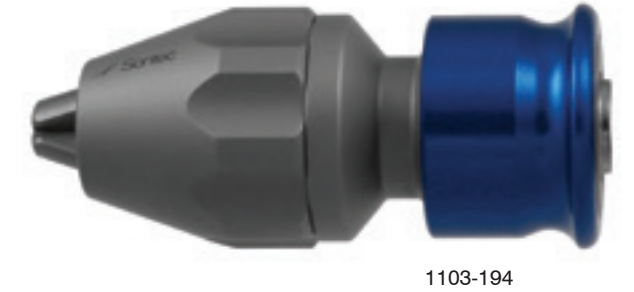

Sontec I.M. Pin Chuck Aluminum Handle

- 1103-190H for 3/8" chuck
- 1103-191H for 5/16" chuck



Sontec I.M. Pin Chuck T-Handle

1103-185T



1103-185T

Power Drill Adapter for Sontec I.M. Pin Chuck

For 5/16"

1103-176



1103-176

Sontec I.M. Pin Chuck Extensions

1103-187 extension handle to protect against sharp end of pin being exposed
 1103-186X key extension handle for IM Pin chuck key leverage device



1103-187



1103-186X

Sontec I.M. Pin Chuck Set

with aluminum handle

1103-184-SET

Set includes:

- 1103-191 stainless steel 5/16" chuck
- 1103-184K key
- 1103-191H aluminum handle
- 1103-187 extension handle

1103-185-SET

Set includes:

- 1103-190 stainless steel 3/8" chuck
- 1103-185K key
- 1103-190H aluminum handle
- 1103-187 extension handle



Sontec I.M. Pin Chuck Set

with t-handle

1103-184T-SET

Set includes:

- 1103-191 stainless steel 5/16" chuck
- 1103-184K key
- 1103-185T t-handle

1103-185T-SET

Set includes:

- 1103-190 stainless steel 3/8" chuck
- 1103-185K key
- 1103-185T t-handle



Sontec Hybrid I.M. Pin Chuck Set

with aluminum handle

1103-193-SET

Set includes:

- 1103-193 stainless steel 3/8" keyed or keyless drill chuck
- 1103-193K key
- 1103-190H aluminum handle
- 1103-187 extension handle

with t-handle

1103-193T-SET

Set includes:

- 1103-193 stainless steel 3/8" keyed or keyless drill chuck
- 1103-193K key
- 1103-185T t-handle



Sontec Keyless I.M. Pin Chuck Set

with aluminum handle

1103-194-SET

Set includes:

- 1103-194 stainless steel 3/8" keyless chuck
- 1103-190H aluminum handle
- 1103-187 extension handle

with t-handle

1103-194T-SET

Set includes:

- 1103-194 stainless steel 3/8" keyless chuck
- 1103-185T t-handle



K-Wire Pin Driver

Cannulated for K-wire / 6 3/8" (15.5 cm)

1103-180
1103-180T titanium



1103-180



1103-180T

Universal Drill Guide

With adjustable spiked head and 3 different sized interchangeable guide tubes

1103-168-SET
Set include:
1103-168 Universal Drill Guide body with spike
1103-16820 2.0 mm guide tube
1103-16827 2.7 mm guide tube
1103-16835 3.5 mm guide tube

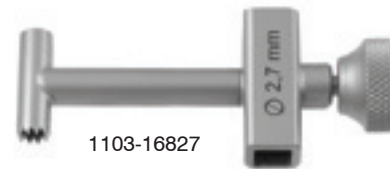

1103-16827



1103-16835

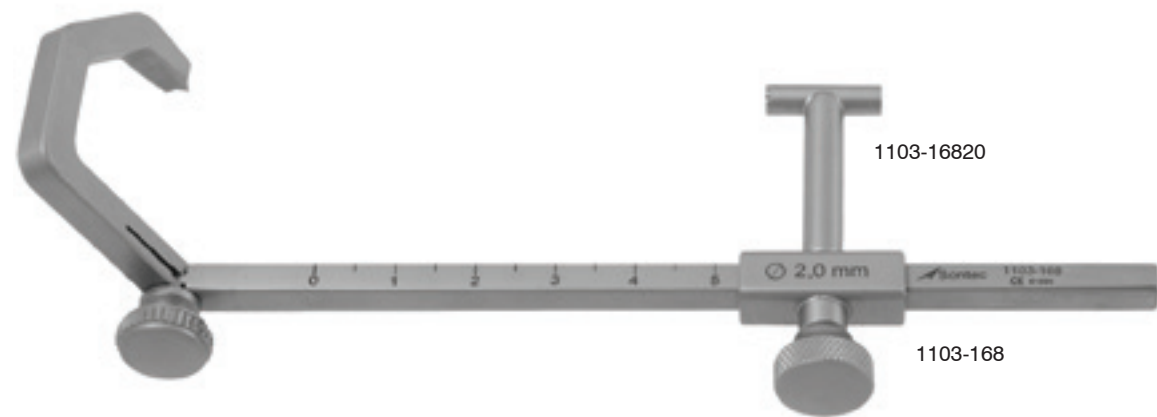

1103-16820

1103-168

Tap Sleeve & Insert Drill Sleeve Set

1103-162S-SET set includes:
1103-161 Taylor Universal drill guide handle
1103-162A tap sleeve 4.5 mm
1103-162B insert drill sleeve for 3.2 mm

* The toothed tip prevents slipping on the bone



1103-162S



1103-162B

1103-162A

1103-161

3 / 1 Drill Guide

For drill 2 mm / double ended

1103-162C tap sleeve 4.5 mm



1103-162C

Tap/ Drill Sleeve

Double ended

- 1103-162D 3.5 mm x 2.5 mm
- 1103-162E 2.7 mm x 2.0 mm



Micro Tap/ Drill Sleeve

2.5 mm / single ended

- 1103-162M



Taylor Drill Guide

- 1103-1625 small reducer 3.2 mm / 1.6 mm
- 1103-1626 large reducer 7 mm / 3.2 mm
- 1103-1627 handle / reducer 9.5 mm / 7 mm

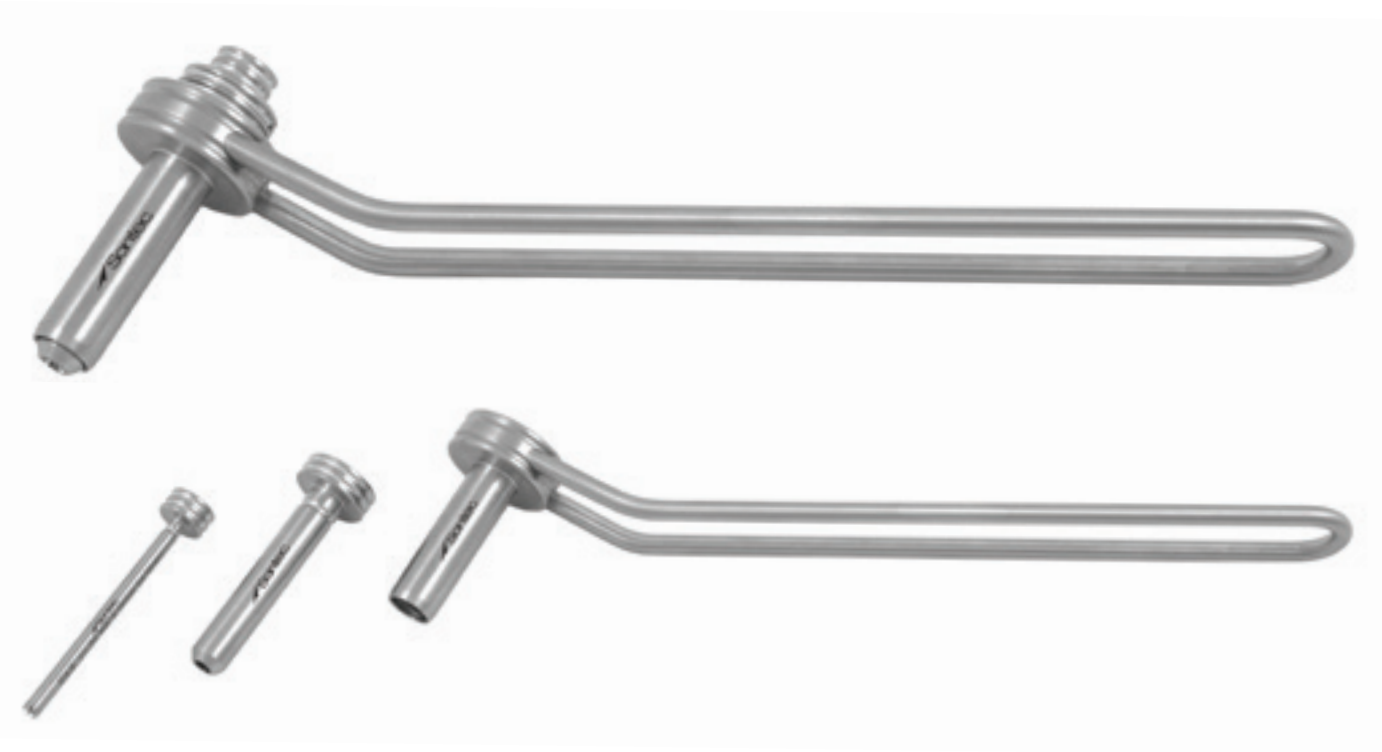

Countersink Bit Cannulated

- 1106-384 3.5 / 4.0 mm screws
- 1106-385 4.5 mm screws



Measuring Gauge

For cannulated screws / 3.5 mm & 4.5 mm

- 1106-375



AO Tap Cannulated

- 1106-387 for 4.5 mm screws 7"
- 1106-388 for 3.5 mm screws 4 1/4"



Drill Bit Quick Coupling

4.5 mm Ø 195 mm

- 1106-391



Double Drill Guide

4.5 / 3.2 mm
1103-1624



Double Drill Guide

2.7 / 1.25 mm
1103-1623



Parallel Drill Guide

For 1.6 mm wire / 4.5 mm cannulated screws
1103-1622 small reducer



Bone Tunnel Borer

7" (18 cm)
1106-848 2.7 mm

* Stainless Steel, small handle, attached drill bit. Used to create bone tunnel quickly and easily without having to set upon a complete orthopedic drill.



1106-848

Valkyrie Mach Holder / Drill Guide

1103-1601



1103-1601



 Sontec Instruments®

Orthopedic SPECIALTY

Depth Gauge

6 1/4" (16 cm) /
Screw size 2.4 - 4.0 /
10 mm - 60 mm

355-162



355-162

8 3/4" (22 cm) /
Screw size 3.5 - 6.5 /
10 mm - 90 mm

355-163



355-163

Screw size 3.5 - 6.5 /
10 mm - 120 mm

355-163L



355-163L

1.) Scale

a.) Scale gradations
please mark your desired scale design

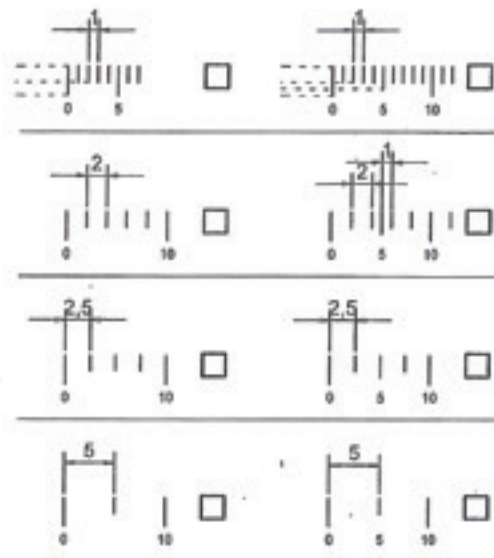

b.) length of scale mm
 mm

c.) customized scale (please add your drawing)

2.) Distance dimension of zero-point to the tip distance

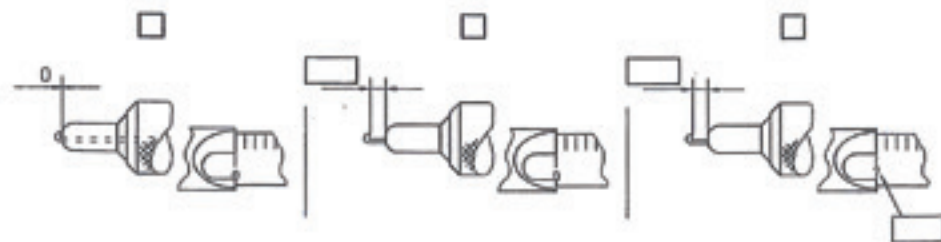

Depth Gauge EZ Clean

| | | |
|----------|-----------|-------------------|
| 355-170 | 1.2/1.5mm | screw size 0-30mm |
| 355-171 | 2.0/2.4mm | screw size 0-30mm |
| 355-171L | 2.0/2.4mm | screw size 0-50mm |
| 355-172 | 2.7mm | screw size 0-50mm |
| 355-173 | 3.5/4.0mm | screw size 0-50mm |
| 355-173L | 3.5/4.0mm | screw size 0-80mm |



355-170



355-171



355-171L



355-172



355-173



355-173L

Mini Depth Gauge

Screw size 1.5 / 10 mm - 30 mm
355-161



355-161

Cloward Depth Gauge

7" (17.8 cm) / up to 45 mm
355-161



355-164

Taylor Micro Arthroscopic Pick

Straight / 1.2 mm / 8" (20 cm)
1271-120



1271-120

T-Handle Bone Hook

T-shaped phenolic handle /
sharp tip / 7" (18 cm) shaft
320-936



320-936

Bone Scraper Set

Includes bone grater attachment 1.0
mm / 1.5 mm / 2.0 mm / 11" (28 cm)

355-272 two legs
355-273 four legs

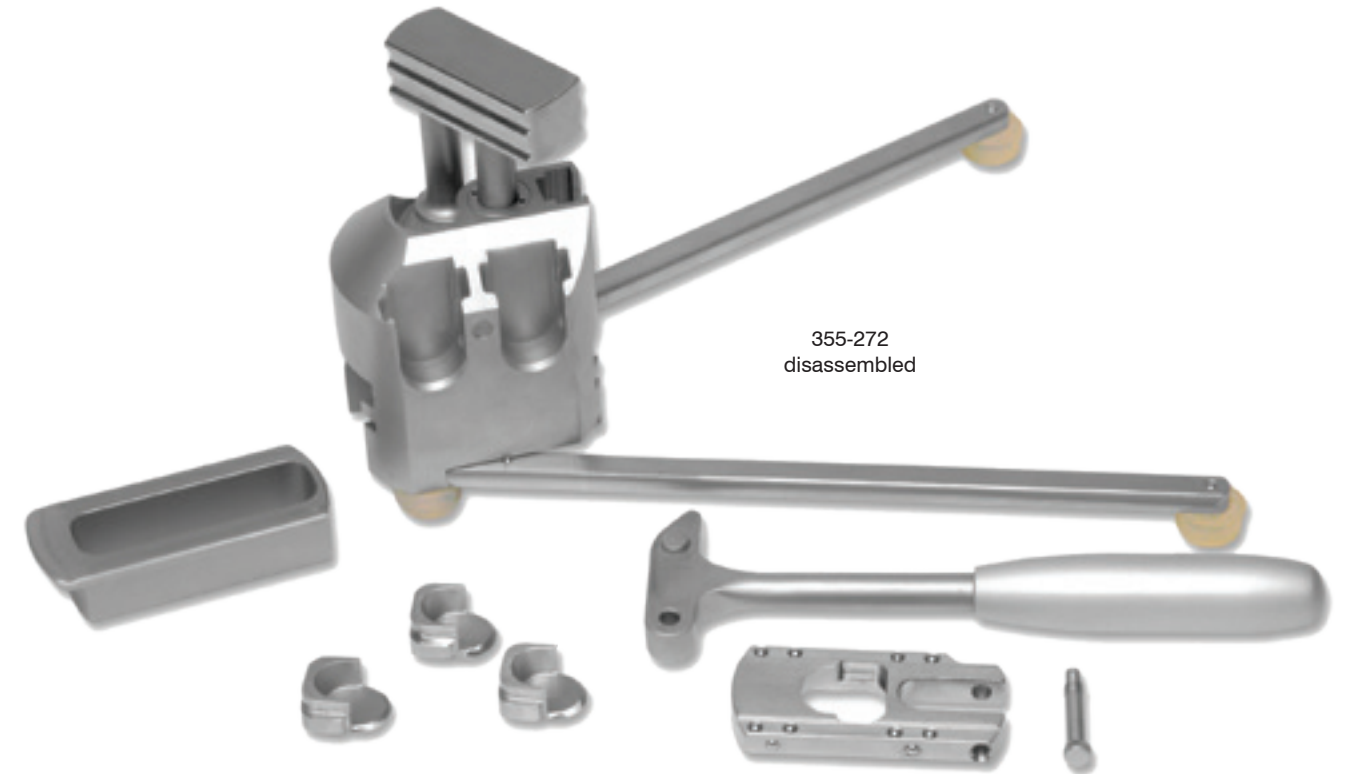

355-272
disassembled

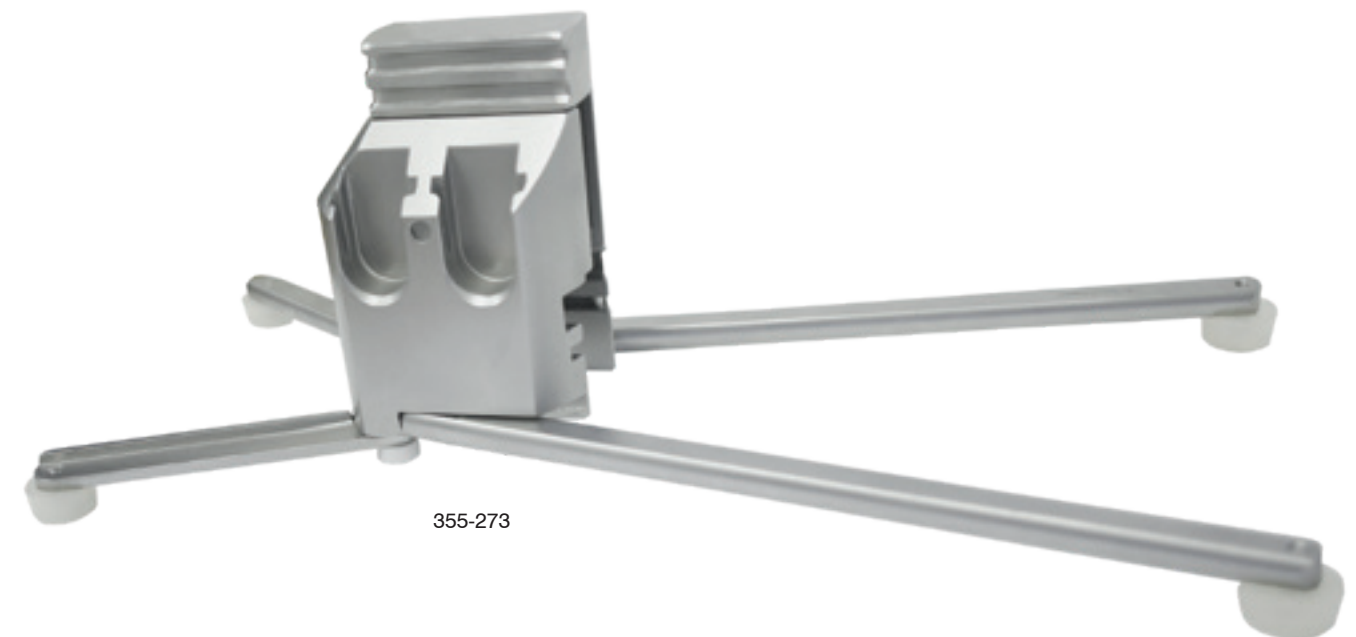

355-273

Liska Awl

T- handle / 3" shaft
1271-342



1271-342

Perthes Awl

6" (15 cm)
1271-340



1271-340

Daniel Nasal Awl

6 1/4" (10.8 cm)
467-414



467-414

Sontec 3 Prong Cast Spreader

9" (23 cm)
240-700



240-700

Henning Cast Spreader

10 3/4" (23 cm)
240-695



240-695

Lumbar & Cervical Impactor

| | | | |
|---------|------------------|-----------------------------------|------------------|
| 335-390 | 6.5 mm x 11.5 mm | | 8 1/2" (21.6 cm) |
| 335-391 | 6 mm x 12.55 mm | narrow | 8 3/4" (22.2 cm) |
| 335-392 | 4.3 mm x 10 mm | micro lateral offset without heel | 7" (17.8 cm) |
| 335-393 | 4.3 mm x 10 mm | micro lateral offset with heel | 7" (17.8 cm) |
| 335-396 | 10 mm x 13 mm | micro lateral offset | 8 3/4" (22.2 cm) |
| 335-397 | 7 mm x 12.5 mm | guarded micro lateral | 8 3/4" (22.2 cm) |
| 335-398 | 10 mm x 13 mm | lateral wide | 8 3/4" (22.2 cm) |
| 335-399 | 7 mm x 12.5 mm | lateral wide | 8 3/4" (22.2 cm) |



335-390



335-391



335-392



335-393



335-396



335-397



335-398



335-399

Hibbs Bone Chip Packer

Hex handle / 10" (25.5 cm)

| | |
|---------|--------------|
| 335-400 | 2 mm x 10 mm |
| 335-404 | 6 mm x 10 mm |
| 335-406 | 6 mm x 19 mm |

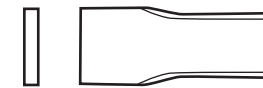

335-400



335-404

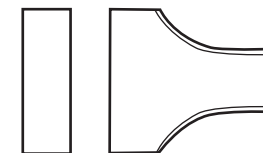

335-406

Lumbar Implant Holder/ Disk Marker

Phenolic handle / sharp with 6mm bead tip / 12" (30.5 cm)

335-380



335-380

Bone Tamp

8" (20 cm)

- 1103-197A 5 mm
- 1103-197B 8 mm
- 1103-197C 12 mm



1103-197A`



1103-197B



1103-197C

Bayonet / 5 mm / 9 1/2" (24.1 cm)

1103-195



1103-195

Bone Mill Set

- 355-270 bone mill (overall length 17")
- 355-275 table C-clamp for stationary positioning of bone mill
- 355-280 large (4.2 mm) cutting cylinder
- 355-285 small (3.2 mm) cutting cylinder

- 355-290 complete set



355-270

355-275

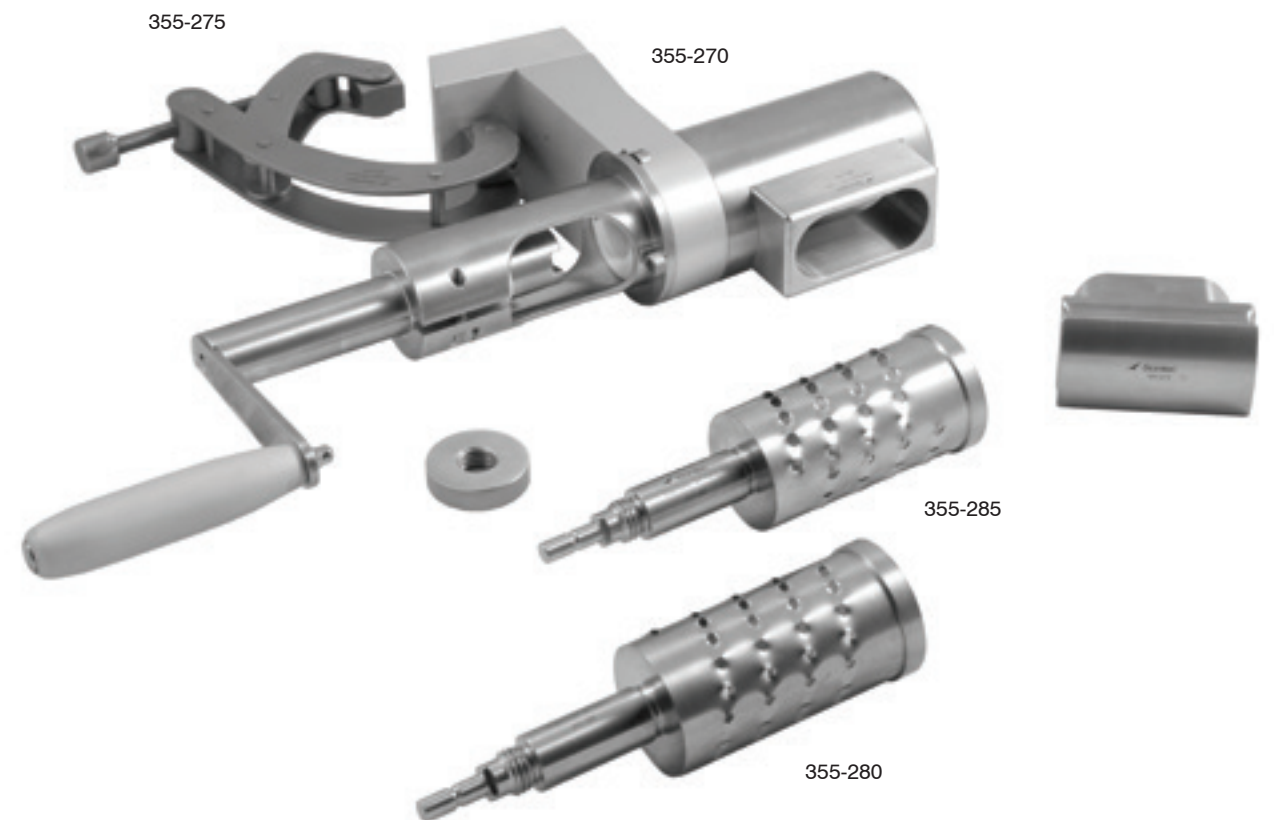

355-275

355-270

355-285

355-280



 Sontec Instruments®

Orthopedic Spinal Neuro CURETTES

Lampert Curette

Thin neck / oval cup / straight / 8" (20.5 cm)

- 320-826T size 000000
- 320-827T size 00000
- 320-829T size 0000
- 320-830T size 000
- 320-831T size 00
- 320-832T size 0
- 320-833T size 1
- 320-834T size 2



Thin neck / oval cup / angled / 8" (20.5 cm)

- 320-847T size 000000
- 320-848T size 00000
- 320-849T size 0000
- 320-850T size 000
- 320-851T size 00
- 320-852T size 0
- 320-853T size 1
- 320-854T size 2



320-827T



320-834T

Bayonet Curette Titanium

Bending Hypophysis Enucleator / 8 3/4" (22 cm)

413-040



413-040

Bayonet Ring Curette Titanium

8 3/4" (22.2 cm)

- 413-060 2.5 mm 45° up angle
- 413-061 3.0 mm 45° up angle
- 413-062 2.5 mm 40° down angle
- 413-063 3.0 mm 40° down angle
- 413-064 2.5 mm 90° up angle
- 413-065 3.0 mm 90° up angle



10 1/4" (25.26 cm)

- 413-050 3.0 mm 90° up angle
- 413-051 3.0 mm 90° down angle
- 413-052 2.25 mm 45° up angle

11" (28 cm)

- 413-055 3.0 mm 90° up angle
- 413-057 3.0 mm 40° down angle
- 413-058 2.25 mm 45° up angle

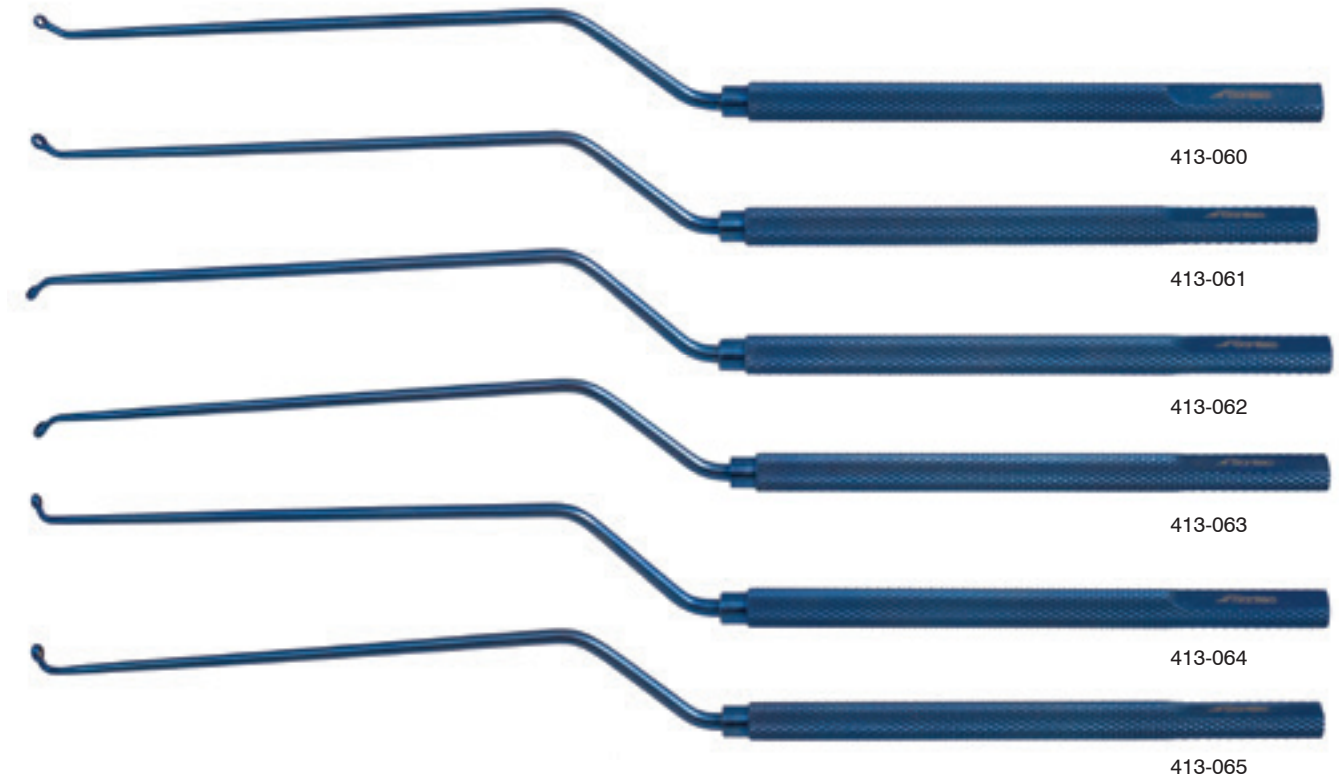

Neuro Ring Curette

Titanium / 8 1/4" (21 cm) / straight

- 413-044 2 mm
- 413-045 3 mm



413-044

Down Pushing Curette

Phenolic handle / 10 mm x 5 mm /
9" handle / 15" (38 cm) / 380 mm

320-879



320-879

O'Brien Curette

Phenolic handle / 9"
handle / 15" (38 cm)

320-924A 8mm
320-924B 11 mm



320-924A

Charnley Curette

Phenolic handle / 9" handle /
15" (38 cm) / 380 mm

320-869L large
320-869S small



320-869L

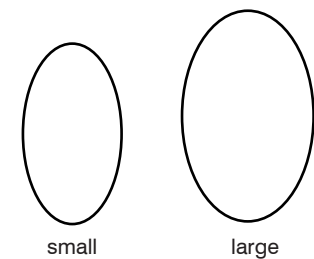

small

large

Tear Drop Spinal Curette

Phenolic handle / 52 mm x 12 mm /
11" (27.9 cm)

320-958 straight
320-959 angled 15°

Phenolic handle / 52 mm x 12 mm /
17" (43.2 cm)

320-960 straight
320-962 angled 15°



320-958



320-960



320-962

Spinal Curette

Phenolic handle / straight / 11" (28 cm)

- 320-866 size 000
- 320-859 size 00
- 320-860 size 0
- 320-861 size 1
- 320-862 size 2
- 320-863 size 3
- 320-864 size 4
- 320-865 size 5



320-862



320-865



320-866

Phenolic handle / angled / 11" (28 cm)

- 320-866A size 000
- 320-859A size 00
- 320-860A size 0
- 320-861A size 1
- 320-862A size 2
- 320-863A size 3
- 320-864A size 4
- 320-865A size 5

Extra Long Spinal Curette

Phenolic handle / extra long / angled / 13" (33 cm)

- 320-920 size 0



320-920



USA Curette

Phenolic handle / oval cup / 5" handle / 11" (28 cm)

- 320-687 size 5/0
- 320-686 size 4/0
- 320-678 size 3/0
- 320-679 size 2/0
- 320-680 size 0
- 320-681 size 1
- 320-682 size 2
- 320-683 size 3
- 320-684 size 4
- 320-685 size 5



320-684



320-679

Phenolic handle / straight / 5" handle / 10" (25.5 cm) / 250 mm

- 320-922A size 2
- 320-922B size 3
- 320-922C size 4



320-922C



320-922B

Phenolic handle / angled / 5" handle / 10" (25.5 cm) / 250 mm

- 320-923A size 2
- 320-932B size 3
- 320-923C size 4

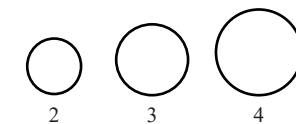

Cone Ring Two Handed Curette

Phenolic handle / straight / 15" (38 cm) / 380 mm

- 320-881A size 1
- 320-881B size 2
- 320-881C size 3
- 320-881D size 4



Phenolic handle / angled / 15" (38 cm) / 380 mm

- 320-882A size 1
- 320-882B size 2
- 320-882C size 3
- 320-882D size 4

320-881C

Phenolic handle / lateral angled / 15" (38 cm) / 380 mm

- 320-883A size 1
- 320-883B size 2
- 320-883C size 3
- 320-883D size 4

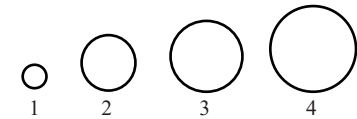

320-883C

Cone Ring Two Handed Curette

Phenolic handle / 9mm / 14 1/2" (37 cm) / 370 mm

- 320-615 straight
- 320-617 40° lateral



320-615



320-617

Black handle / 9mm / 14 1/2" (37 cm) / 370 mm

- 320-615B straight
- 320-617B 40° lateral



Two Handed Curette

Phenolic handle / serrated cup
/ 6mm x 9mm / 14 1/2" (37 cm)

- 320-621 straight
- 320-622 30d up
- 320-623 45d cvd left
- 320-624 45d cvd right
- 320-625 90d



320-625

Black handle / serrated cup / 6 mm x 9 mm / 14 1/2" (37 cm)

- 320-621B straight
- 320-622B 30d up
- 320-623B 45d cvd left
- 320-624B 45d cvd right
- 320-625B 90d



* Available in a green handle



320-621B



straight



30d up



45d curved left



45d curved right



90d

Two Handed Curette

Black handle / 90° / 18" (45.7 cm)

- 320-584 2 mm
- 320-585 3.8 mm
- 320-586 8 mm

Black handle / 30° / 18" (45.7 cm)

- 320-580 2 mm
- 320-581 2.8 mm
- 320-582 4 mm oval
- 320-583 7 mm

Black handle / straight / 18" (45.7 cm)

- 320-587 3 mm
- 320-588 7 mm

Tear Drop Curette

Black handle / 11 mm teardrop / 18" (45.7 cm)

- 320-589 straight
- 320-590 15 degree angled



320-588



320-587



320-580



320-581



320-582



320-583



320-584



320-585



320-586



320-589



320-590

Long Handle Curette

Sharp / black handle / 16 1/2" (41.9 cm)

- 320-626B teardrop
- 320-629B #3 angled
- 320-630B #6 angled

Sharp / green handle / 16 1/2" (41.9 cm)

- 320-626G teardrop
- 320-629G #3 angled
- 320-630G #6 angled



320-626G



320-626B



320-629G



320-630G



320-626G



320-626B

Two Handed Large Grip Curette

Phenolic handle / oval cup / straight / 7" handle / 13" (33 cm)

- 320-658 size 3/0
- 320-659 size 2/0
- 320-660 size 0
- 320-661 size 1
- 320-662 size 2
- 320-663 size 3
- 320-664 size 4
- 320-665 size 5
- 320-666 size 6
- 320-667 size 7

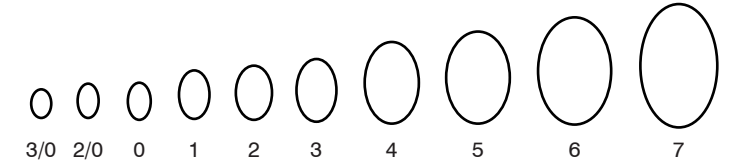

320-663

Phenolic handle / oval cup / straight / 9" handle / 15" (38 cm)

- 320-638 size 3/0
- 320-639 size 2/0
- 320-640 size 0
- 320-641 size 1
- 320-642 size 2
- 320-643 size 3
- 320-644 size 4
- 320-645 size 5
- 320-646 size 6
- 320-647 size 7



320-639

Phenolic handle / oval cup / straight / 7 1/2" handle / 16" (40.5 cm)

- 320-670 size 5



Phenolic handle / oval cup / with teeth / 9" handle / 15" (38 cm) / 380 mm

- 320-634T size 4
- 320-636T size 6



320-636T



Micro Spinal Curette

Phenolic handle / straight / 4.5" handle / 9.5" (24 cm) / 240 mm

- 320-889A size 6/0
- 320-889B size 5/0
- 320-889C size 4/0
- 320-889D size 3/0
- 320-889E size 2/0
- 320-889F size 0



Straight



Angled



Rev. Angled

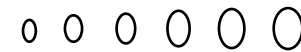

6/0 5/0 4/0 3/0 2/0 0

Phenolic handle / angled / 4.5" handle / 9.5" (24 cm) / 240 mm

- 320-888A size 6/0
- 320-888B size 5/0
- 320-888C size 4/0
- 320-888D size 3/0
- 320-888E size 2/0
- 320-888F size 0

Phenolic handle / rev. angled / 4.5" handle / 9.5" (24 cm) / 240 mm

- 320-887A size 6/0
- 320-887B size 5/0
- 320-887C size 4/0
- 320-887D size 3/0
- 320-887E size 2/0
- 320-887F size 0



320-889A



320-889B



320-889D

Micro Axial Bayonet Regular Length Curette

Phenolic handle / straight / 4.5" handle / 9.5" (24 cm) / 240 mm

- 320-886A size 6/0
- 320-886B size 5/0
- 320-886C size 4/0
- 320-886D size 3/0
- 320-886E size 2/0
- 320-886F size 0



320-886C



320-886E

Phenolic handle / angled / 4.5" handle / 9.5" (24 cm) / 240 mm

- 320-885A size 6/0
- 320-885B size 5/0
- 320-885C size 4/0
- 320-885D size 3/0
- 320-885E size 2/0
- 320-885F size 0

Phenolic handle / rev. angled / 4.5" handle / 9.5" (24 cm) / 240 mm

- 320-884A size 6/0
- 320-884B size 5/0
- 320-884C size 4/0
- 320-884D size 3/0
- 320-884E size 2/0
- 320-884F size 0



Straight



Angled



Rev. Angled



6/0 5/0 4/0 3/0 2/0 0

Micro Axial Bayonet Long Curette

Phenolic handle / long shaft / straight / bayonet / 5" handle / 12" (32 cm)

- 320-803A 1 mm
- 320-803B 2 mm
- 320-803C 3 mm
- 320-803D 4 mm
- 320-803E 5 mm
- 320-803F 6 mm

Phenolic handle / long shaft / angled / bayonet / 5" handle / 12" (32 cm)

- 320-804A 1 mm
- 320-804B 2 mm
- 320-804C 3 mm
- 320-804D 4 mm
- 320-804E 5 mm
- 320-804F 6 mm

Phenolic handle / long shaft / rev. angled / bayonet / 5" handle / 12" (32 cm)

- 320-805A 1 mm
- 320-805B 2 mm
- 320-805C 3 mm
- 320-805D 4 mm
- 320-805E 5 mm
- 320-805F 6 mm



320-804C



320-805B

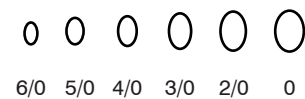
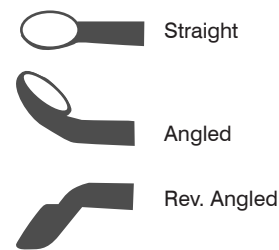

Micro Axial Bayonet Extra Long Curette

Phenolic handle / long shaft / straight / bayonet/ 5" handle / 14" (35.5 cm)

- 320-800A 1 mm
- 320-800B 2 mm
- 320-800C 3 mm
- 320-800D 4 mm
- 320-800E 5 mm
- 320-800F 6 mm

Phenolic handle / long shaft / angled / bayonet / 5" handle / 14" (35.5 cm)

- 320-801A 1 mm
- 320-801B 2 mm
- 320-801C 3 mm
- 320-801D 4 mm
- 320-801E 5 mm
- 320-801F 6 mm

Phenolic handle / long shaft / rev. angled / bayonet / 5" handle / 14" (35.5 cm)

- 320-802A 1 mm
- 320-802B 2 mm
- 320-802C 3 mm
- 320-802D 4 mm
- 320-802E 5 mm
- 320-802F 6 mm



320-801E



320-802D

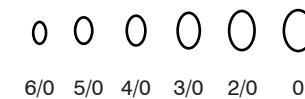
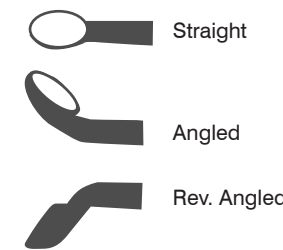

Spinal Fusion Curette

Oval cup / 9" (23 cm)

| | | |
|---------------|----------|----------|
| 320-866-9-000 | straight | size 000 |
| 320-866-9-00 | straight | size 00 |
| 320-860-9-0 | straight | size 0 |
| 320-861-9-1 | straight | size 1 |
| 320-862-9-2 | angled | size 2 |
| 320-863-9-3 | straight | size 3 |
| 320-864-9-4 | angled | size 4 |
| 320-865-9-5 | straight | size 5 |
| 320-867-9-6 | angled | size 6 |

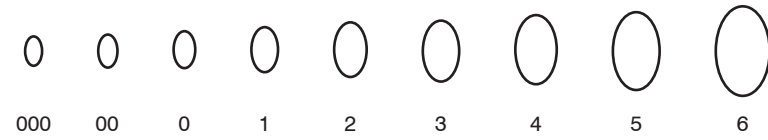

320-866-9-00

Anterior Spinal Curette

Hollow knurled handle / oval cup / straight / 15" (38 cm)

| | | |
|---------------|----------|---------|
| 320-868-15-00 | straight | size 00 |
| 320-868-15-1 | straight | size 1 |
| 320-868B-15-6 | bayonet | size 6 |



320-868-15-1



320-868-15-6

Cobb Spinal Curette

Hollow knurled handle / oval cup / straight / 11" (28 cm)

| | |
|---------|----------|
| 320-896 | size 000 |
| 320-897 | size 00 |
| 320-898 | size 0 |
| 320-899 | size 1 |
| 320-900 | size 2 |
| 320-901 | size 3 |
| 320-902 | size 4 |
| 320-903 | size 5 |
| 320-904 | size 6 |

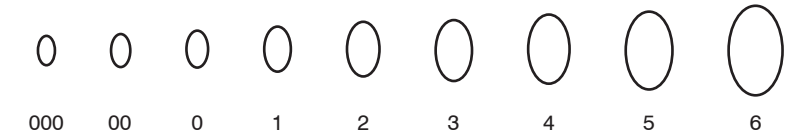

320-896



320-913



 Sontec Instruments®

Orthopedic TREPHINE

Nested Trocar Set

6 1/2" (16.5 cm)

190-246 set includes:
6 french
9 french
13 french
17 french
handle & cover

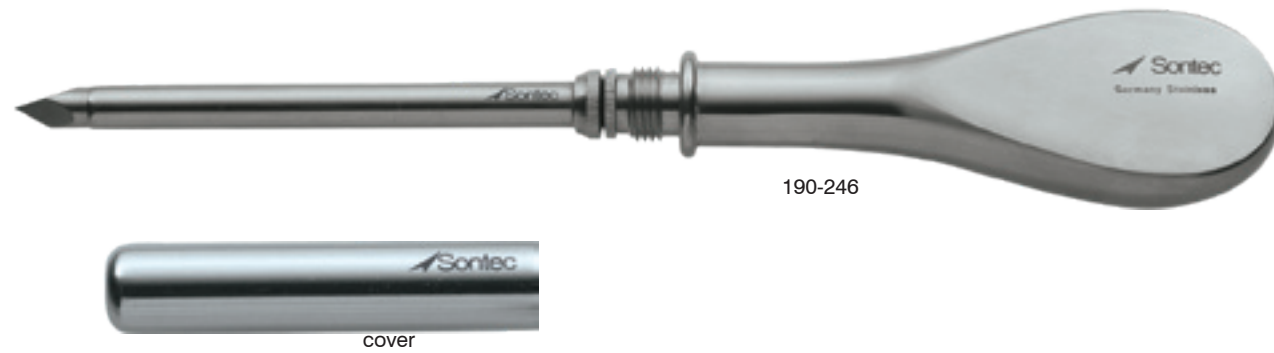
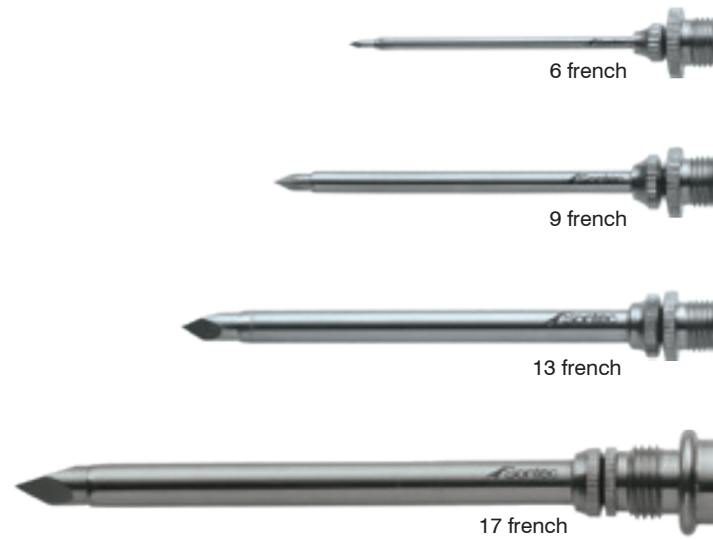

Michele Trephine

| | | |
|-----------|----------------|------------------|
| 1100-460T | 1/8" / 3 mm | special diameter |
| 1100-460S | 3/16" / 5 mm | |
| 1100-460M | 7/32" / 6 mm | |
| 1100-460L | 5/16" / 8 mm | |
| 1100-460E | 13/32" / 10 mm | |
| 1100-460X | 15/32" / 12 mm | |

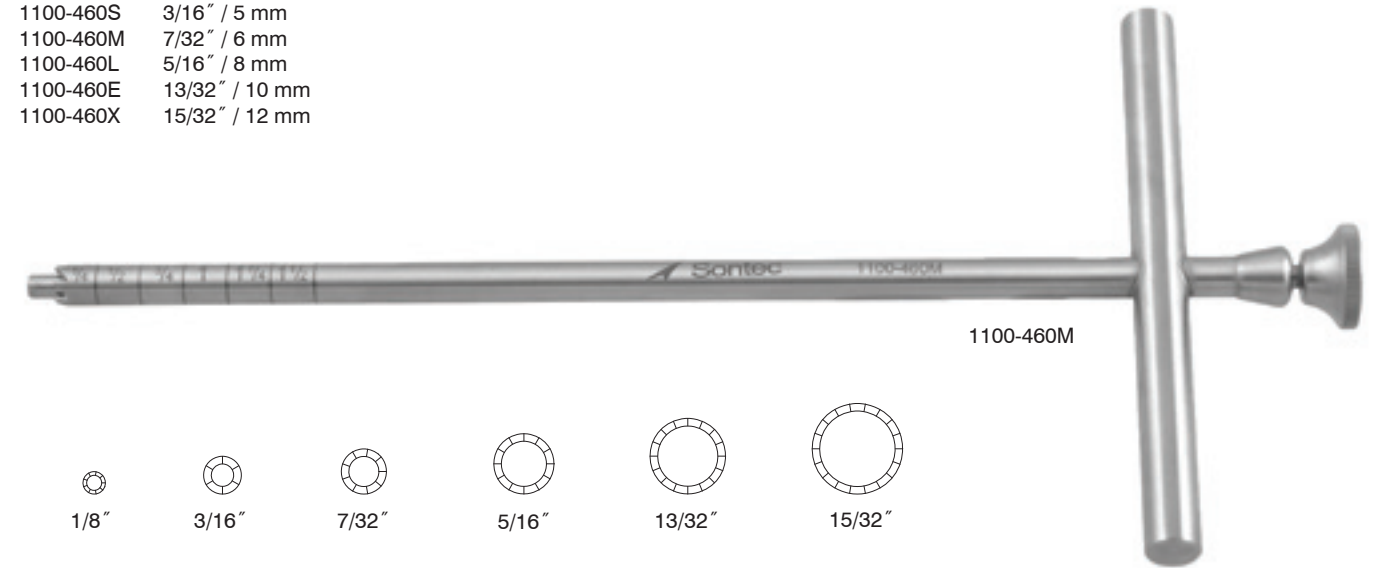

Galt Trephine

| | |
|---------|--------------|
| 419-378 | 1/2" / 13 mm |
| 419-380 | 5/8" / 16 mm |
| 419-382 | 3/4" / 19 mm |
| 419-384 | 7/8" / 22 mm |
| 419-386 | 1" / 25 mm |

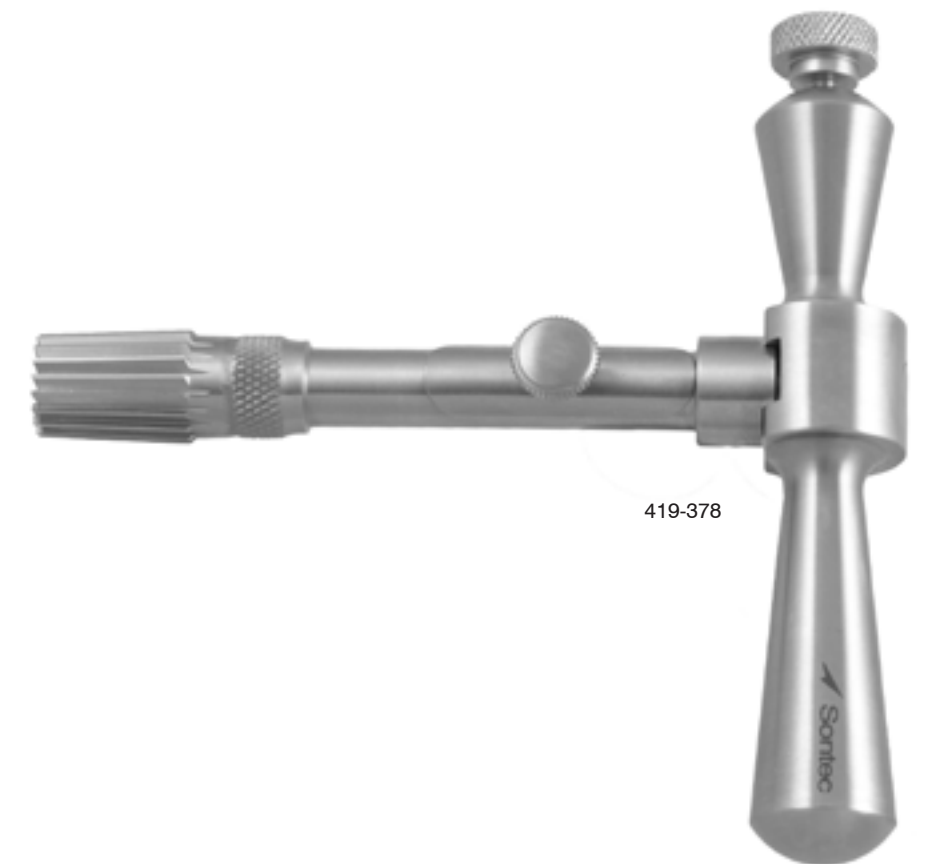

Shepard Ram Obturator

5 1/2" (14 cm)

- SC94-0412 5 mm
- SC94-0417 6 mm
- SC94-0422 8 mm



Shepard Trocar

5 1/2" (14 cm)

- SC94-0411 5 mm
- SC94-0416 6 mm
- SC94-0421 8 mm

Shepard Cylindrical Osteotome

5" (13 cm)

- SC94-0410 5 mm
- SC94-0415 6 mm
- SC94-0420 8 mm



Shepard Cross Pin

4 1/2" (11.5 cm)

- SC94-0405



Plug Cutter

With Obturator / 4 1/2" (11.4 cm)

- 419-392 3 mm/ 5 mm

With Obturator / 6 1/2" (16.5 cm)

- 419-393 5 mm/ 7 mm
- 419-394 7 mm/ 9 mm
- 419-395 10 mm/ 12 mm
- 419-396 12 mm/ 14 mm
- 419-397 20 mm/ 22 mm
- 419-398 22 mm/ 25 mm

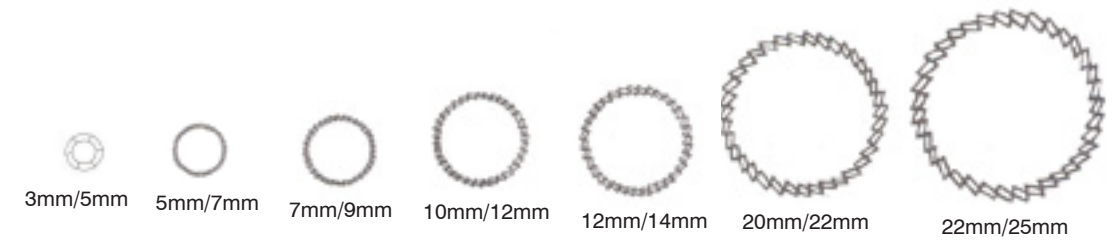

Bespoke Wroblewski Bone Trepine

O/D 8 mm I/D 6 mm

- 419-388





 Sontec Instruments®

Orthopedic VISE GRIP PLIERS

Wire Extraction Pliers

7" (18 cm)

| | | | |
|----------|----------------|------|-------------|
| 1106-130 | cross-serrated | 6 mm | grooved jaw |
| 1106-131 | cross-serrated | 3 mm | |
| 1106-132 | serrated | 3 mm | |



1106-131

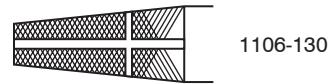

1106-130



1106-131

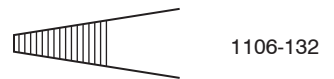

1106-132

Pin Pulling Pliers

TC / one grooved jaw / 3 mm tip / 5 1/2" (14 cm)

1106-140



1106-140

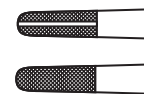

Needle Nose Pliers

Stainless

| | | |
|----------|----------------|----------|
| 1103-144 | 5 1/2" (14 cm) | |
| 1103-145 | 6" (15 cm) | delicate |
| 1106-133 | 7 3/4" (20 cm) | |



1103-144



1103-145



1106-133

Needle Nose Locking Pliers

- 1103-137S 8 5/8" (21.75 cm)
- 1103-137M 10" (25 cm)
- 1103-137L 11 3/4" (29.5 cm)



Slap Hammer/Hip Dislodger

Modified / locking pliers / with slide hammer
355-300



Vise Grip Pliers

Locking adjustable jaws

- 1103-133S 7" (18 cm)
- 1103-133M 8" (20 cm)
- 1103-133L 9 1/2" (24 cm)



Slip Joint Pliers

Stainless

- 1103-142 6" (15 cm)
- 1103-141 8" (20 cm)





 Sontec Instruments®

Orthopedic WIRE PASSERS

Sontec Single End Wire Passer

Phenolic handle / 45 mm / 9" (22 cm)

1103-166

70 mm / 10 1/2" (27 cm)

1103-166X

45 mm / 8 3/8" (21.5 cm)

1103-167

Phenolic handle / with thick tubing wall /

9" (23 cm)

1103-165

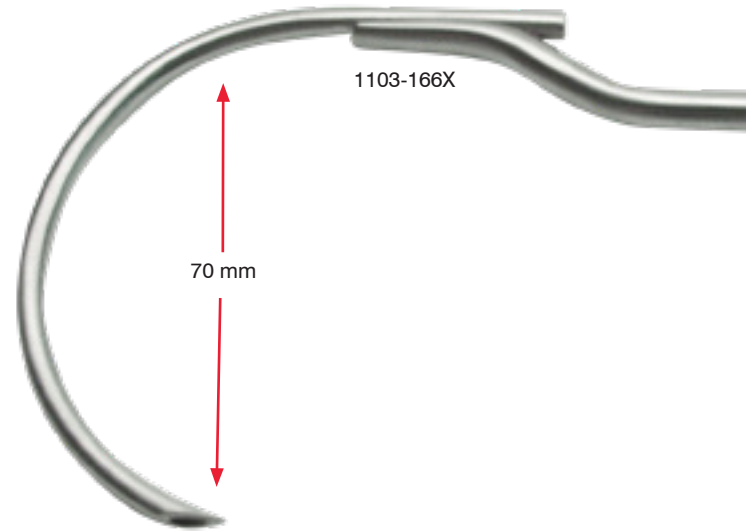

Hybrid Herbst Wire Passer

Phenolic handle / single end / 10 1/2" (26.7 cm)

1103-1661 45mm

1103-1662 70mm



Herbst-Doolen Wire Passer

Double-ended / small / medium / 5 1/2"
(14 cm) / for 20-26 gauge wire

1103-841



1103-841

Herbst Wire Passer

Double-ended / 5 1/2" (14 cm)
/ for 18-26 gauge wire

1103-160



1103-160

Avian Mini Wire Passer

For 22-26 gauge wire

1103-848 single ended 22 gauge 4 1/2"

1103-848S single ended 26 gauge 4 1/2"

1103-847 double ended 22-26 gauge 5"



1103-848



1103-847



 Sontec Instruments®

Orthopedic WIRE PIN CUTTERS

Wire Side Cutter

TC

| | | |
|-----------|-------------------|------------------------|
| 1103-115 | 5 3/4" (14.5 cm) | cuts wire up to 1.0 mm |
| 1100-528 | 7 1/2" (19 cm) | cuts wire up to 1.6 mm |
| 1100-528D | 8" (20 cm) Deluxe | cuts wire up to 1.6 mm |



1103-115

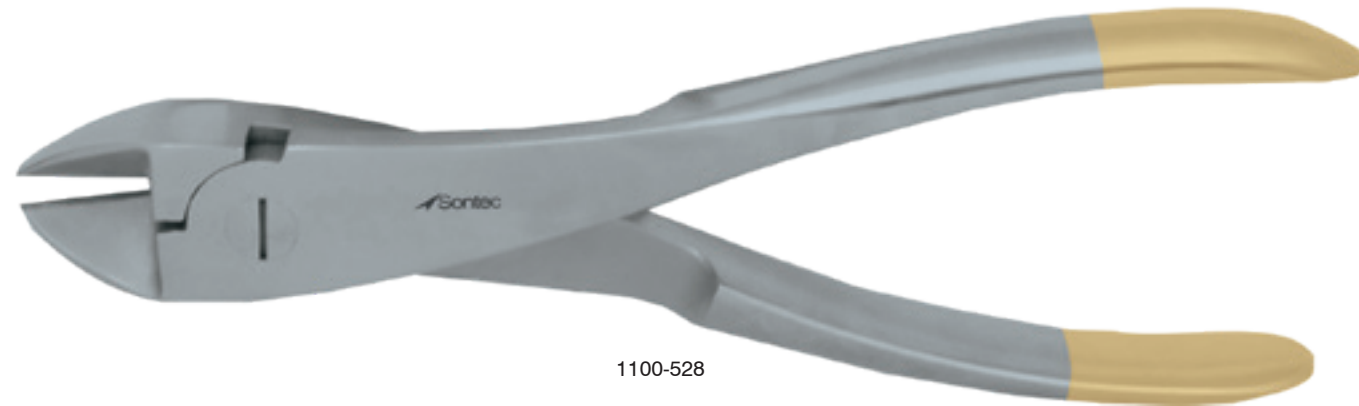

1100-528

Plate Cutter for Titanium Plates

Cuts up to 1.8 mm MAX / 6 1/2" (16.5 cm)

355-219



355-219

Wire End Cutter

TC / cuts wire up to 1.5 mm / 5 3/4" (14.5 cm)

1103-110

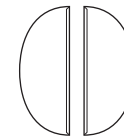

1103-110

TC Pin Cutter

Cuts pins up to 2 mm / 6 1/2" (16.5 cm)

355-196



355-196

End Pin Cutter

Cannulated / cuts pins up to 1.6 mm / single action / 7 1/2" (19 cm)

1103-109
1103-108 TC



1103-109

Large Plate & Pin Cutter

Cuts stainless steel wire & plates up to 3.5 mm / replacement jaws available / 9 1/2" (24 cm)

1103-104

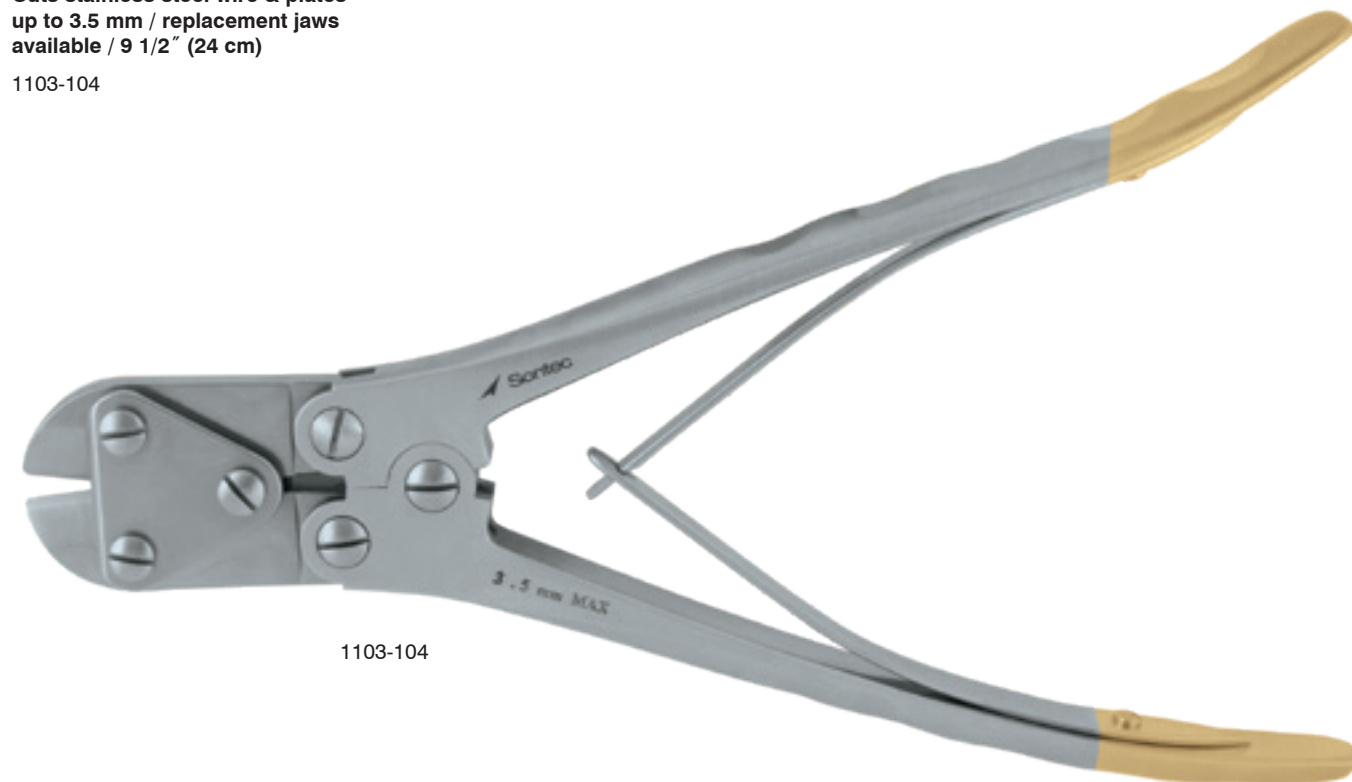

1103-104

GOLD-CUT HERCULES® Pin Cutter

Cuts pins up to 3 mm / exchangeable TC blades / over 40% less power required / exchangeable rubber jaws / fully sterilizable / 9" (23 cm)

355-189 wire cutter
355-190 TC Blades Replacement Set
355-193 Rubber Jaws Replacement Set

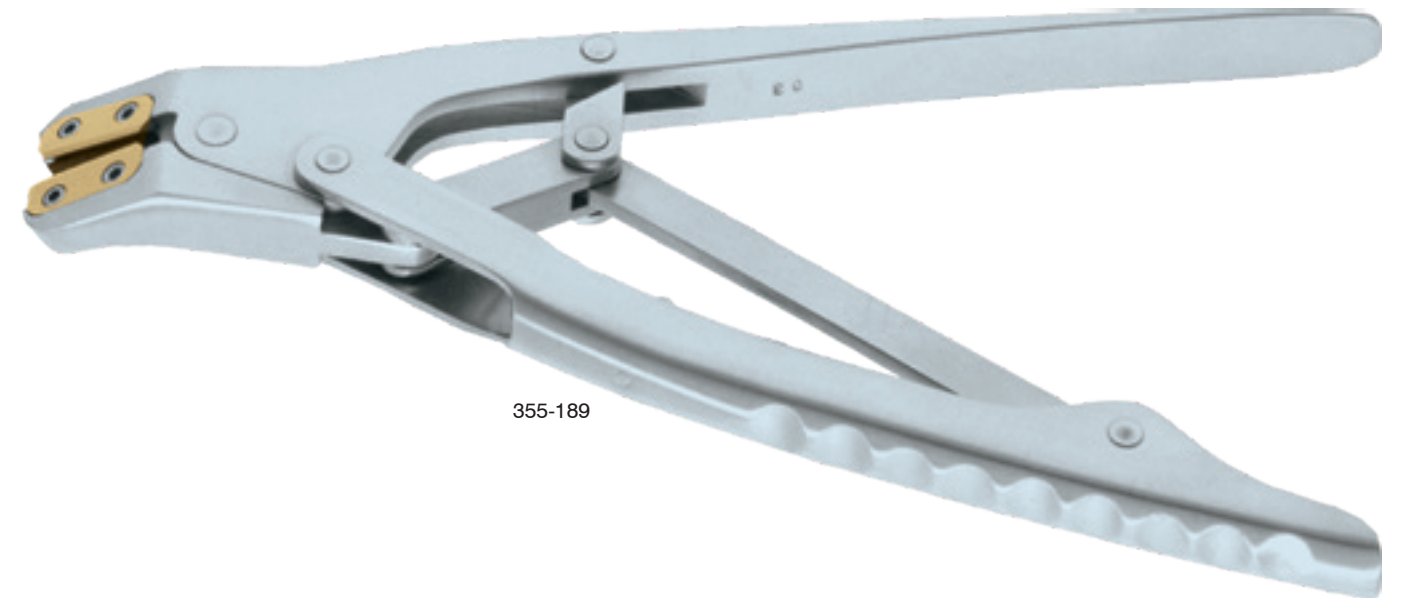

355-189

The Big GOLD-CUT HERCULES® Pin Cutter

Cuts pins 2.5 mm - 4.0 mm / exchangeable TC Blades / over 40% less power required / exchangeable rubber jaws / fully sterilizable / 11" (28 cm)

355-191 wire cutter
355-192 TC Blades Replacement Set
355-193 Rubber Jaws Replacement Set

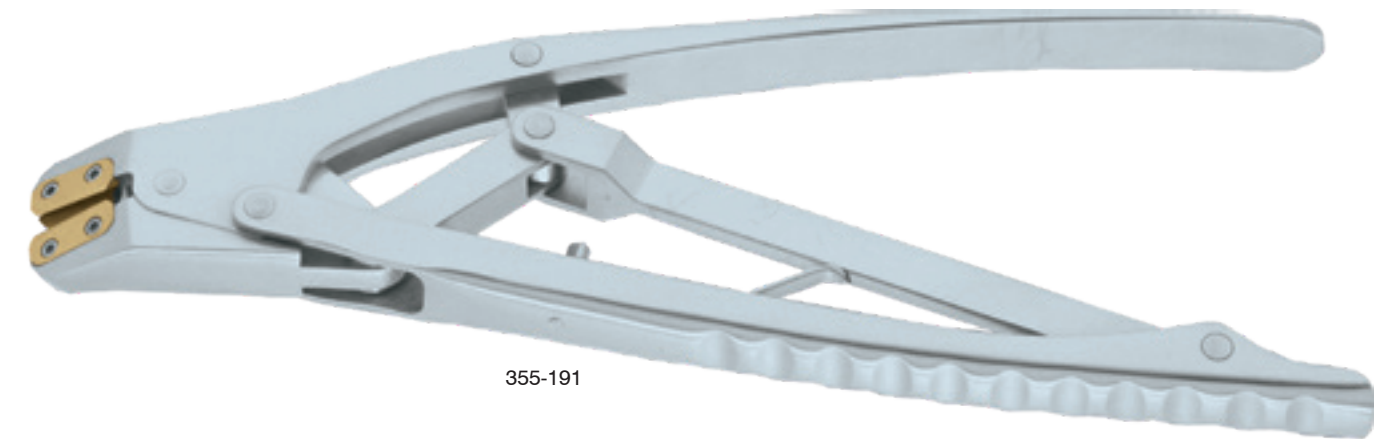

355-191

Baby GOLD-CUT HERCULES® Pin Cutter

Cuts pins up to 2.2 mm / exchangeable TC blades / over 40% less power required / exchangeable rubber jaws / fully sterilizable / 7" (18 cm)

- 355-187 left-handed
- 355-186 right-handed
- 355-188 TC Blades Replacement Set
- 355-193 Rubber Jaws Replacement Set

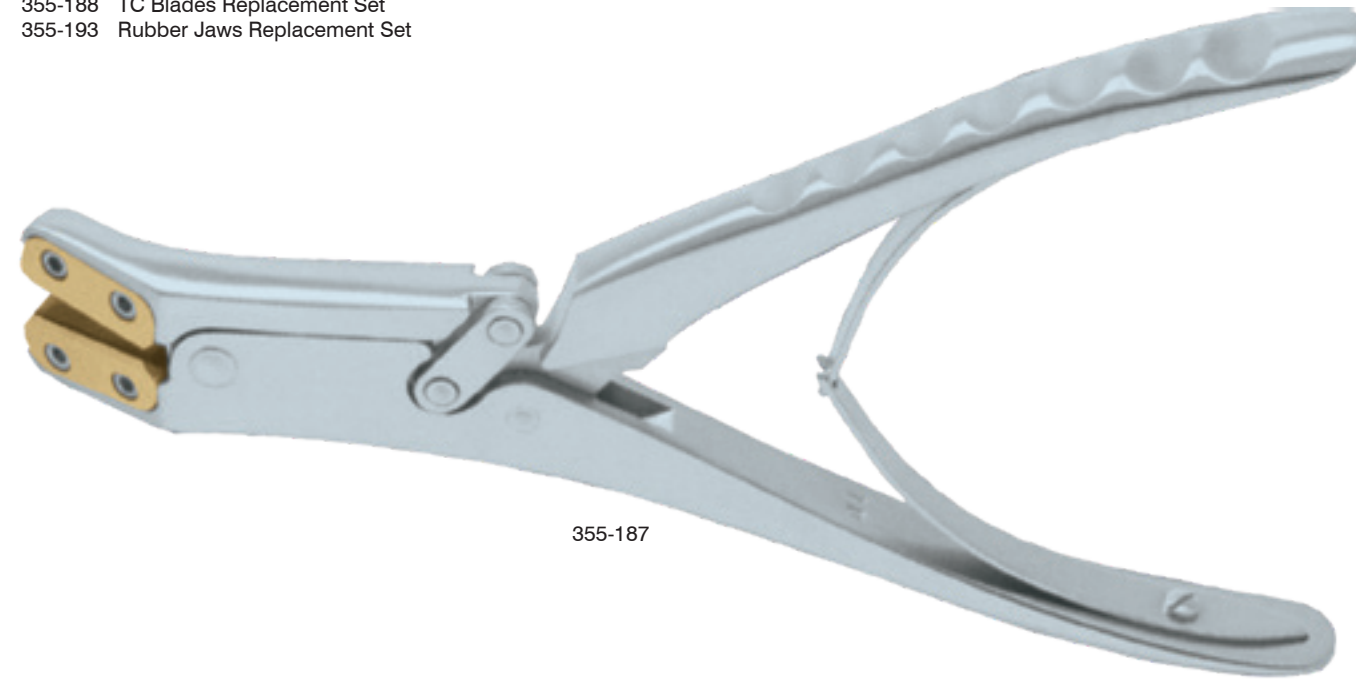

355-187

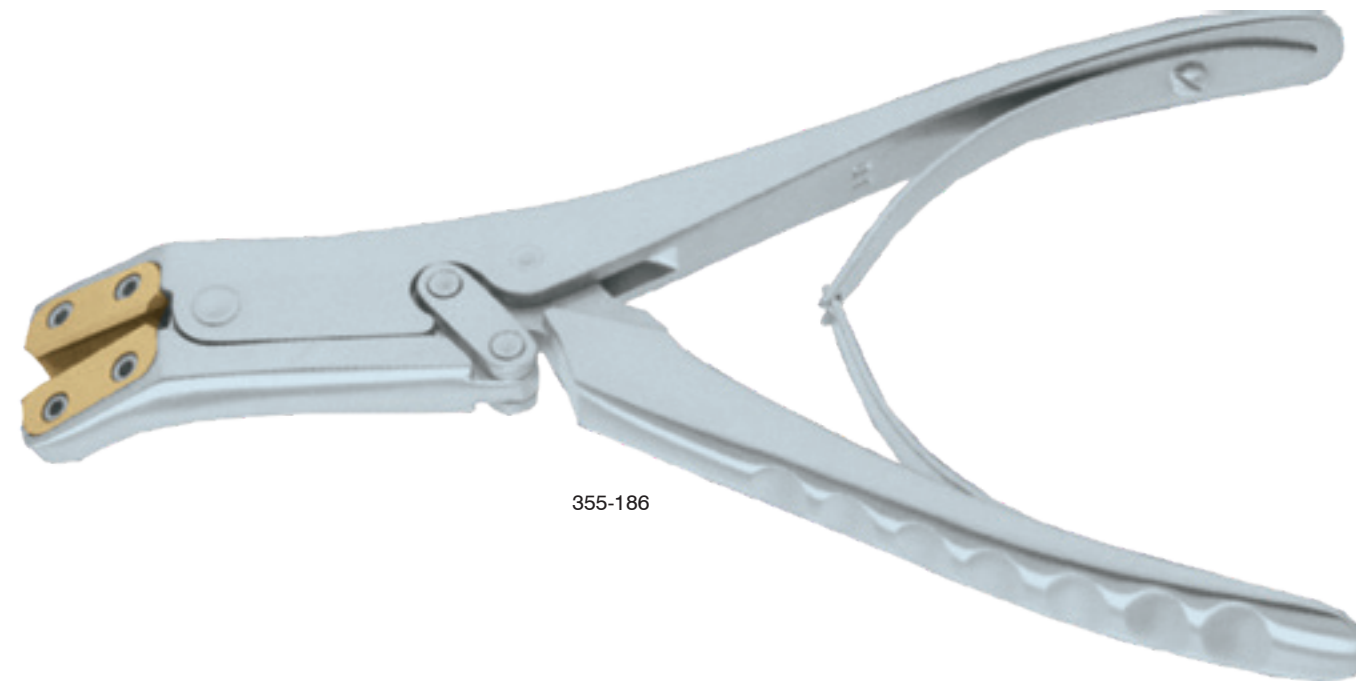

355-186

Double Action Wire Cutter

Cuts wire up to 1.6 mm / TC / 6 1/4" (16 cm)

1100-530A



1100-530A

Micro Double Action Wire Cutter

Cuts wire up to 1.6 mm / TC / 6 1/2" (16.5 cm)

1100-531



Large Pin / Bolt Cutter

Cuts pins up to 6.3 mm / replaceable jaws

| | | |
|---------|---------------------------|---------|
| 355-212 | non-removable handles | 22 1/2" |
| 355-213 | compact removable handles | 18 1/2" |
| 355-214 | removable handles | 22 1/2" |

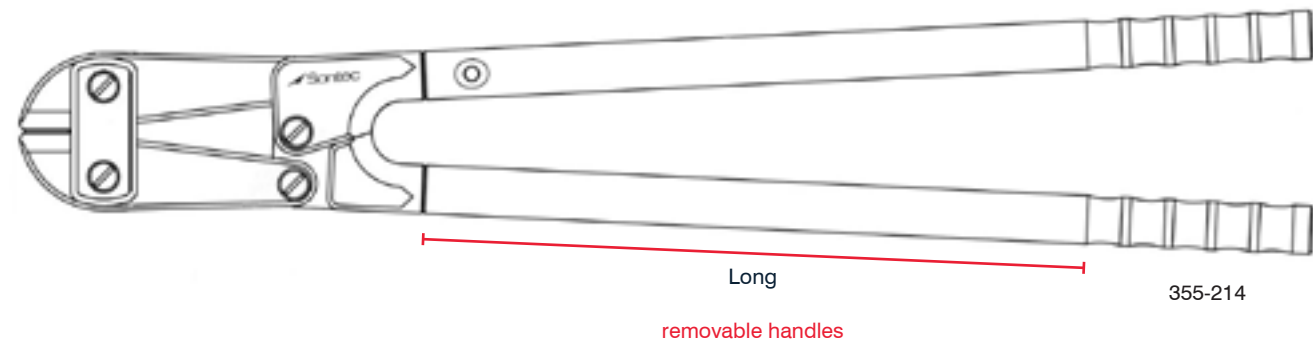
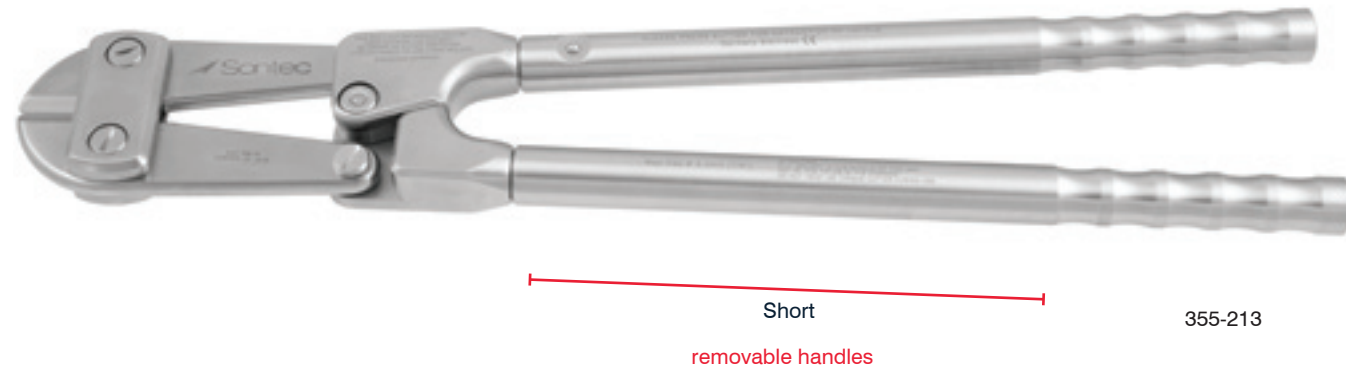
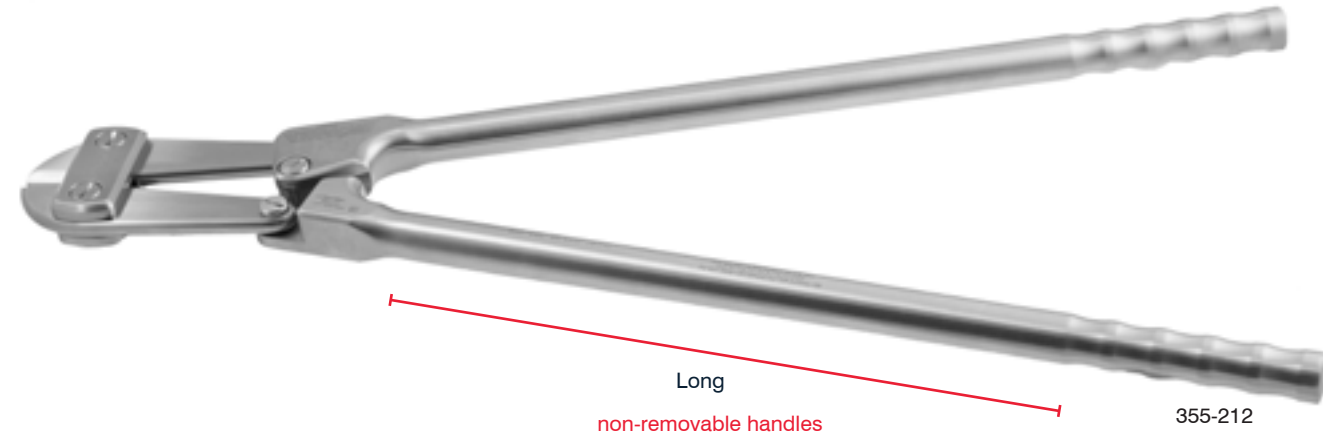

TC Pin Cutter

Cuts pins up to 6.0 mm / replaceable jaws

| | | |
|-----------|-------------|--|
| 1103-140 | 19" (48 cm) | special order |
| 1103-140A | 19" (48 cm) | handles are removable for smaller autoclaves |

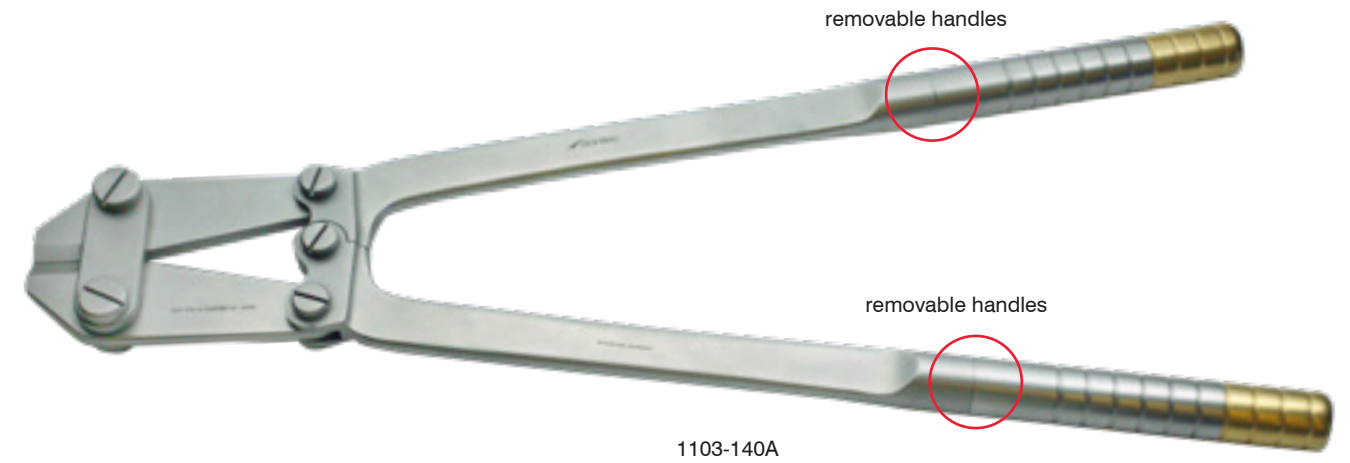

Pin Cutter Specialty Harden Jaws

Cuts pins up to 4 mm

| | |
|-----------|-------------|
| 1103-140J | 15" (38 cm) |
|-----------|-------------|

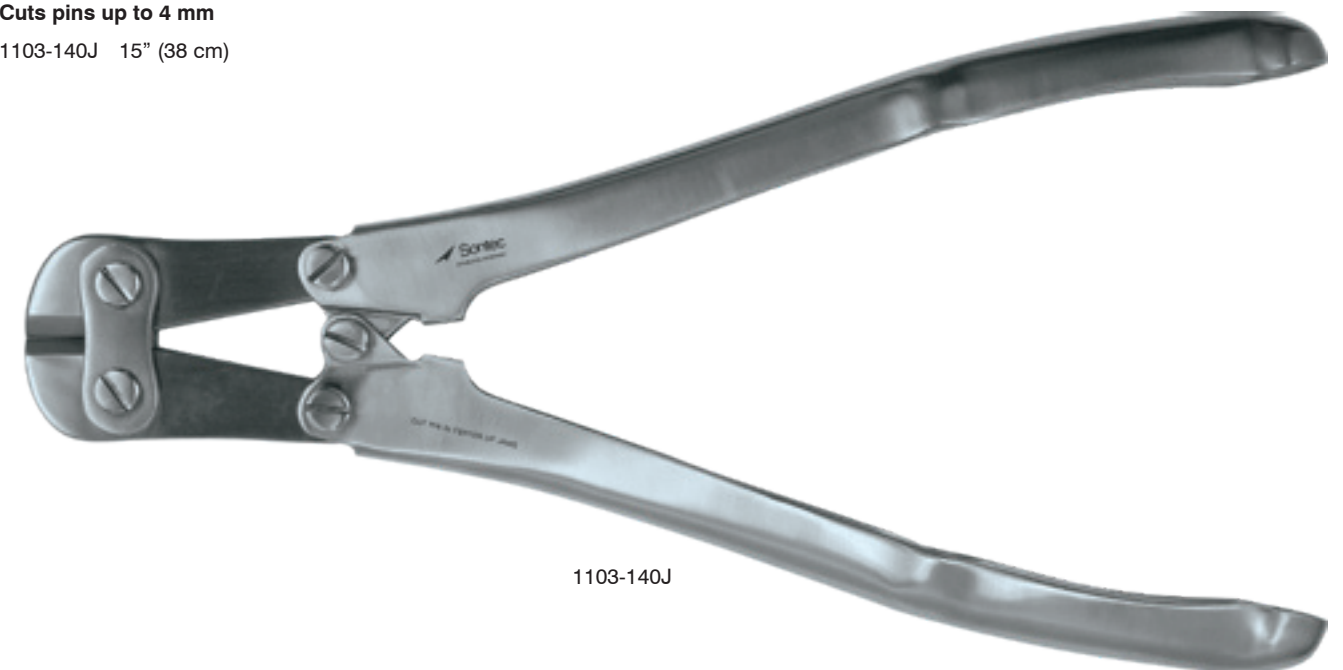

Double Action Wire Cutter

Angled to the side / TC

1100-529 7 1/4" (18 cm)

Cuts wire up to 1.6 mm / TC

1100-530 7" (18 cm)



1100-529

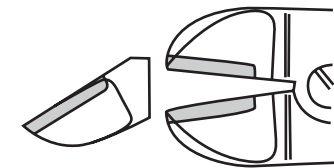

1100-530

TC / Cuts wire up to 2.2 mm / 8 3/4" (22 cm)

1103-102 15° angle

1103-103V 30° angle



1103-102

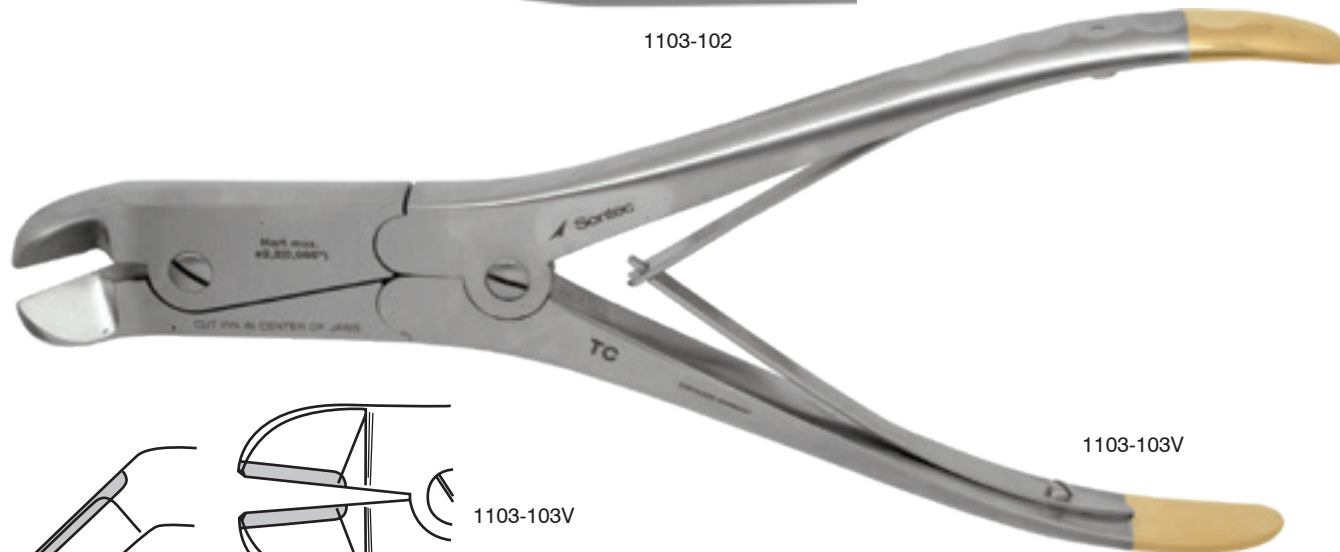

1103-103V

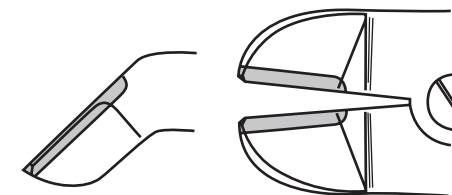

1103-103V

Sontec Pin Cutter

With TC inserts / max cap ø 4 mm / 15" (38 cm)

355-209



355-209

Pin End Cutter

Cuts pins up to 3 mm / 10" (25 cm)

355-202

Cuts pins up to 4.7 mm / 14" (35.5 cm)

355-210

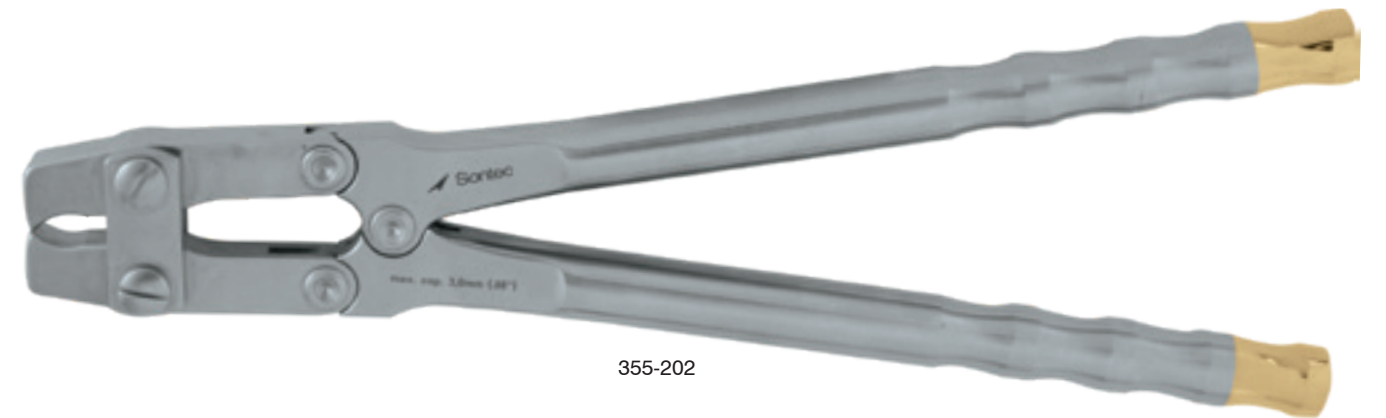

355-202

Rod Cutter

Cuts rods \varnothing 2.5 mm, \varnothing 3.0 mm,
 \varnothing 3.5 mm / 11 1/2" (29.2 cm)

355-207



355-207

Rod Flush Cutter

With removable handle / cuts rods \varnothing 4.5
mm, \varnothing 5.5 mm, \varnothing 6.35 mm / 22" (57 cm)

355-211



355-211



Wire End Cutter

TC / double-action / 7"
(18 cm)

1103-107

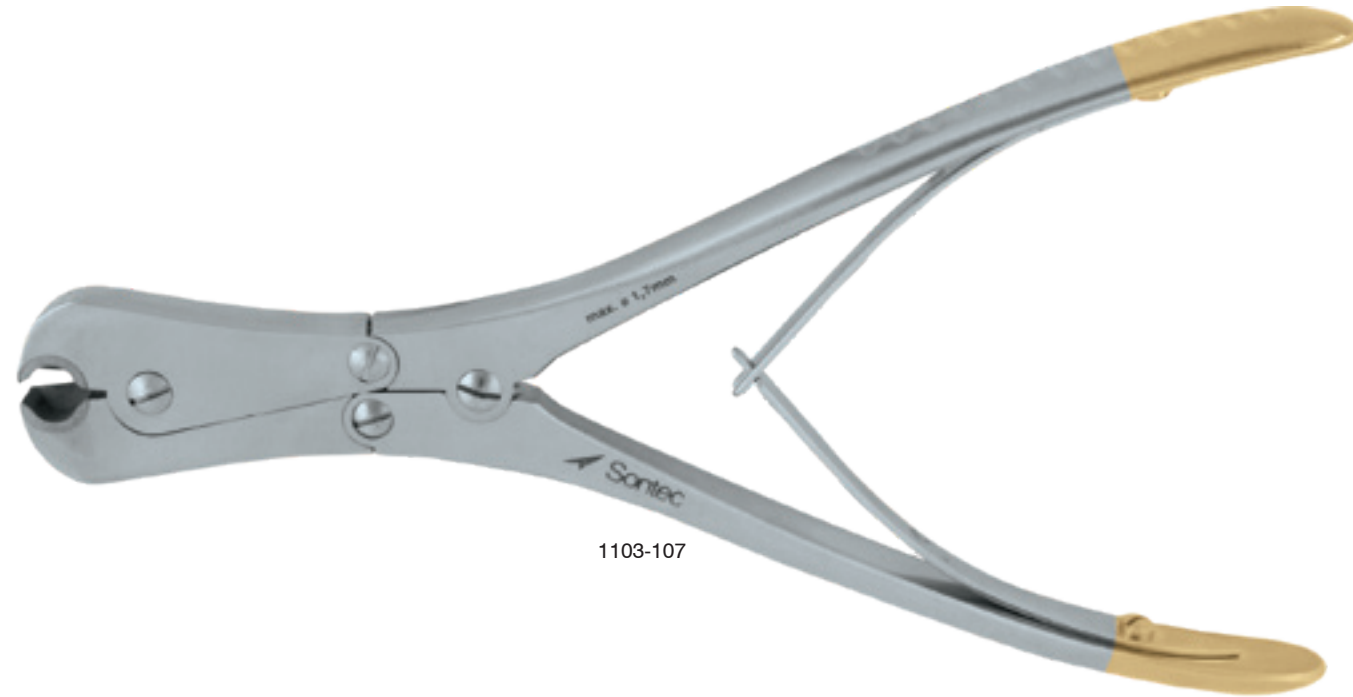

1103-107

Flush Cut Pin Cutter

With enclosed cutting design /
cuts pins up to 4 mm / 12" (30 cm)

1103-117

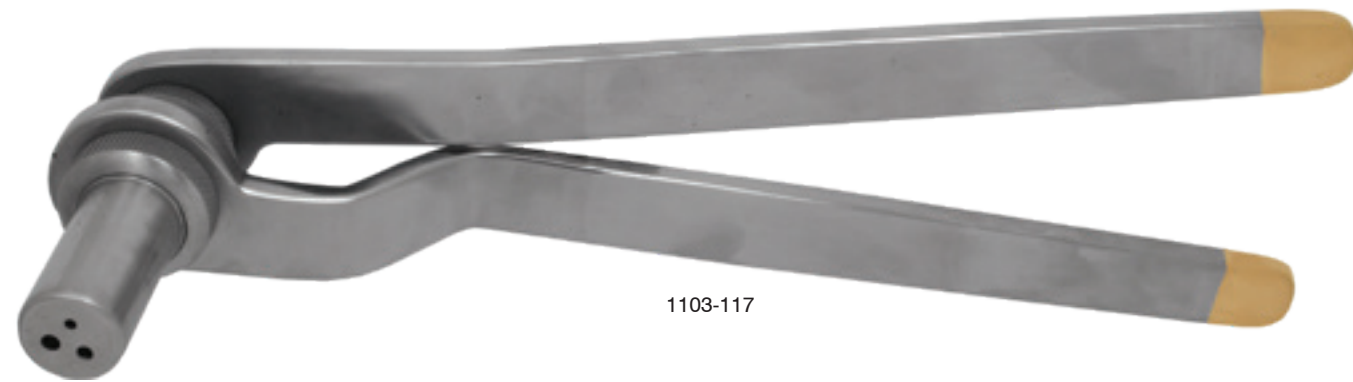

1103-117

Wire End Cutter

TC / double-action / cuts wire
up to 1.5 mm / 6 1/4" (16 cm)

1103-105 mini

TC / double-action / Cuts wire
up to 2.5 mm / 8 1/2" (21.5 cm)

1103-100 extra large



1103-105

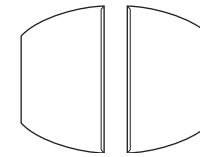

1103-100

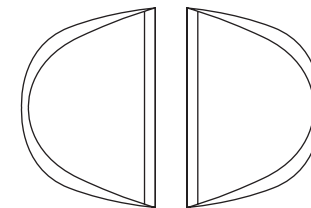

GOLD-CUT HERCULES® Front & Side Pin Cutter

Cuts pins up to 1.6 mm / over 40% less power required / exchangeable TC blades with integrated rubber jaws / fully sterilizable / 7" (18 cm)

355-198 front & side cutter
355-199 TC inserts with Rubber Jaws Replacement Set

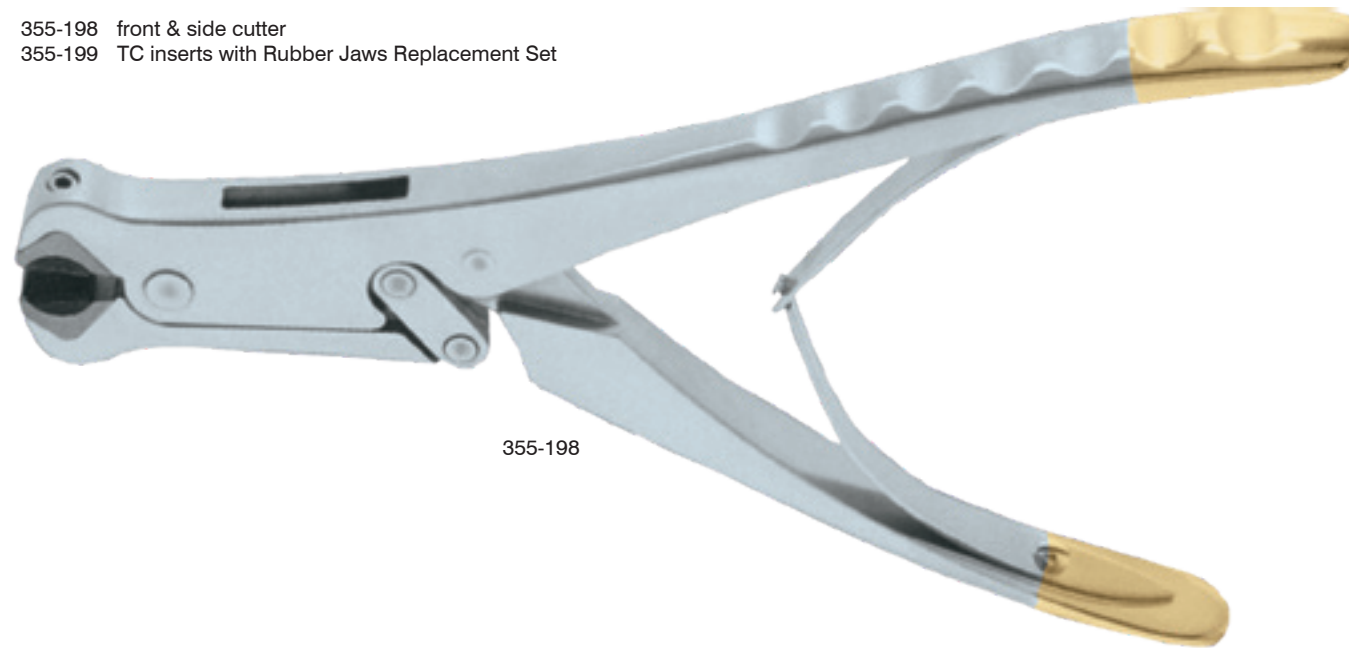

355-198

TC Blades Replacement Set For Hercules Wire Cutter

1 pair of TC blades / 1 pair of screws / 1 allen wrench

355-190 for 355-189
355-192 for 355-191



Rubber Jaws Replacement Set for Hercules Wire Cutter

1 pair of rubber jaws / 1 pair of screws

355-193 for 355-189 and 355-191



TC Inserts with Rubber Jaws Replacement Set for Hercules Front & Side Cutter

1 pair of TC inserts with rubber jaws / 1 pair of screws / 1 allen wrench

355-199 for 355-198



Table Top Rod Cutter

Max capacity 6.4 mm (1/4") / select pin size dial selector / cuts pins flush

355-206



355-206



 Sontec Instruments®

Orthopedic WIRE TWISTERS

Rubio Wire Twister Needle Holder

Heavy / TC / 5 1/4" (13 cm)
1103-147



1103-147

Obwegeser Wire Twister Needle Holder

Special order / 5 3/4" (15 cm)
2300-599

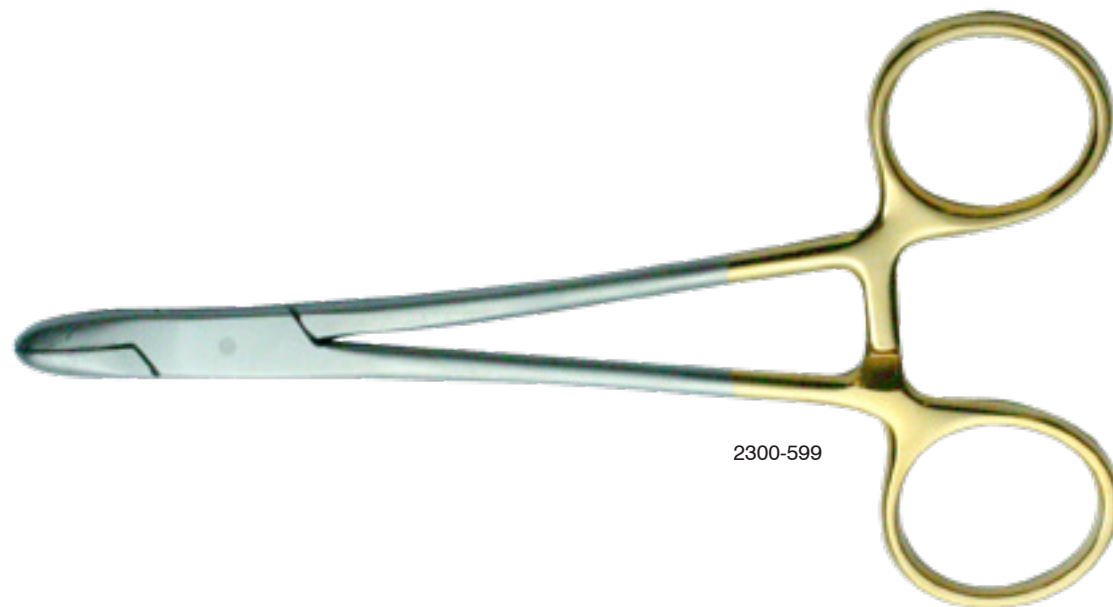

2300-599

Sternal Wire Twister Needle Holder

Broad jaw / TC serrated / can be used as a wire twister / suggested suture size sternal needles and smaller
1103-154S 5 1/8" (13 cm)
1103-152 7" (18 cm)
1103-153 7 3/4" (19.5 cm)



TC Serrated



1103-154S

New Orleans Wire Twister Needle Holder

TC serrated / suggested suture size 2-0 and smaller
2300-600 rounded 6" (15 cm)
2300-602 blunt 6" (15 cm)
2300-601 rounded 7" (18 cm)
2300-604 blunt 7" (18 cm)
2300-606 rounded 8" (20.5 cm)
2300-607 blunt 8" (20.5 cm)



rounded



blunt

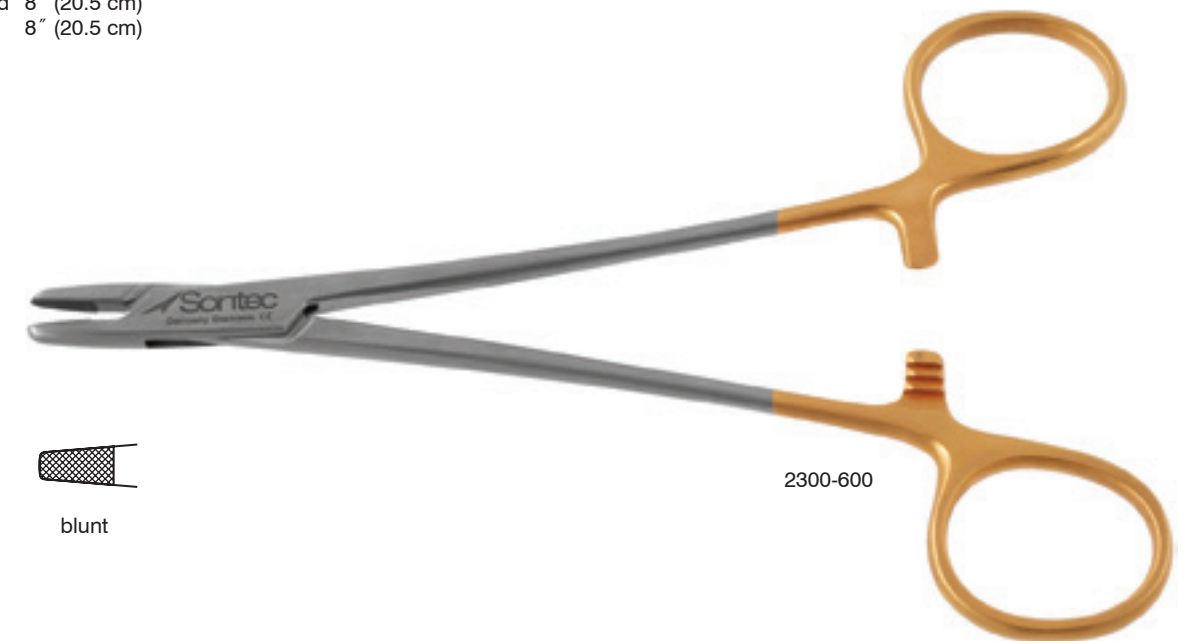

2300-600

Anti-Buckle Wire Twister

TC serrated / w/ guard
1103-159 7 1/4" (18.5 cm)

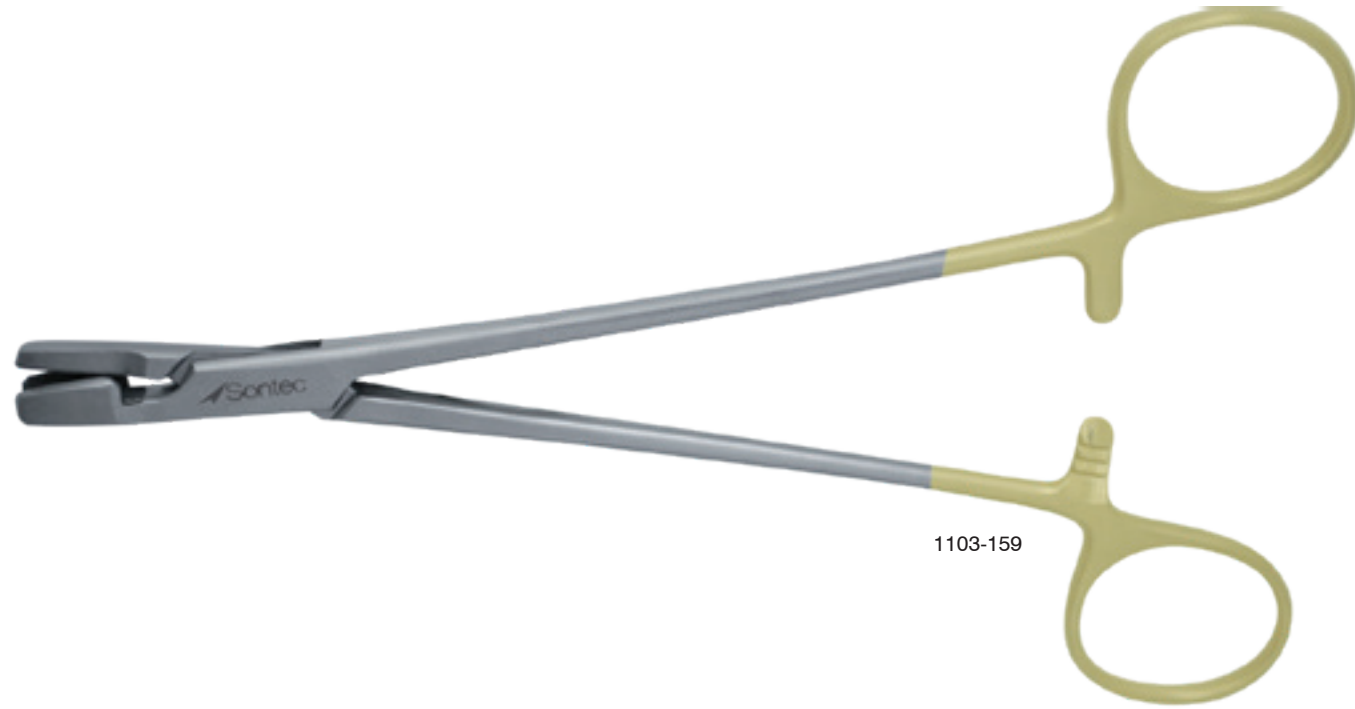

1103-159

Axel Wire Twister

Needle holder style / with
hole / 6 3/4" (17.1 cm)
1103-155

Rounded jaw / with hole /
heavy duty XXL
1103-1551 7 1/4" (18.4 cm)
1103-1552 8" (20.3 cm)

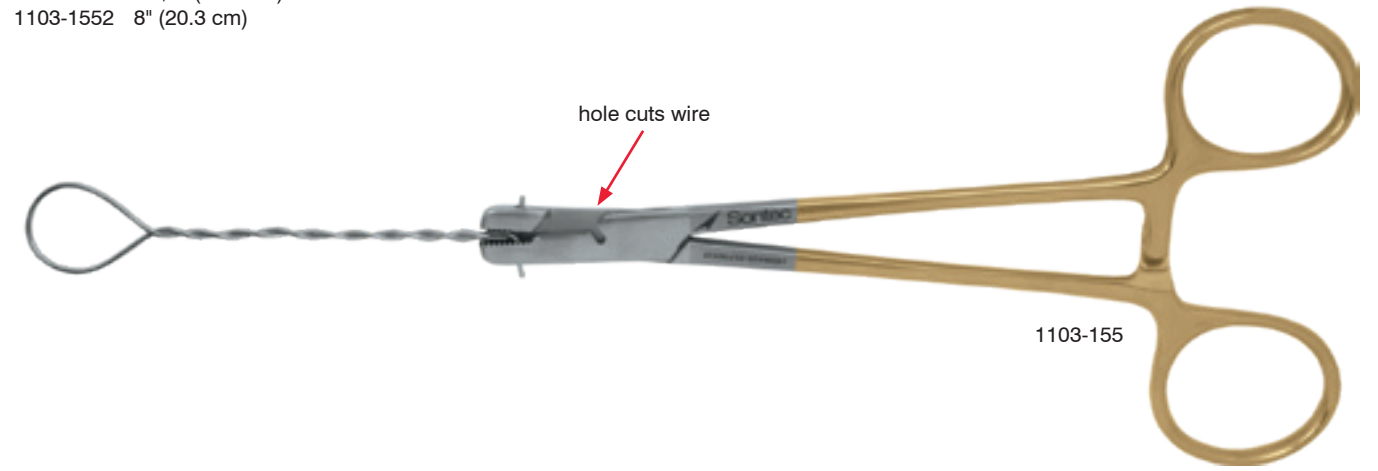

1103-155



1103-1551

Wire Twister

Needle holder style / with hole / 7" (18 cm)
1103-150



Mini Jet Wire Twister Needle Holder

Mayo needle holder style / TC serrated / 6 1/2" (16.5 cm)
1103-158M

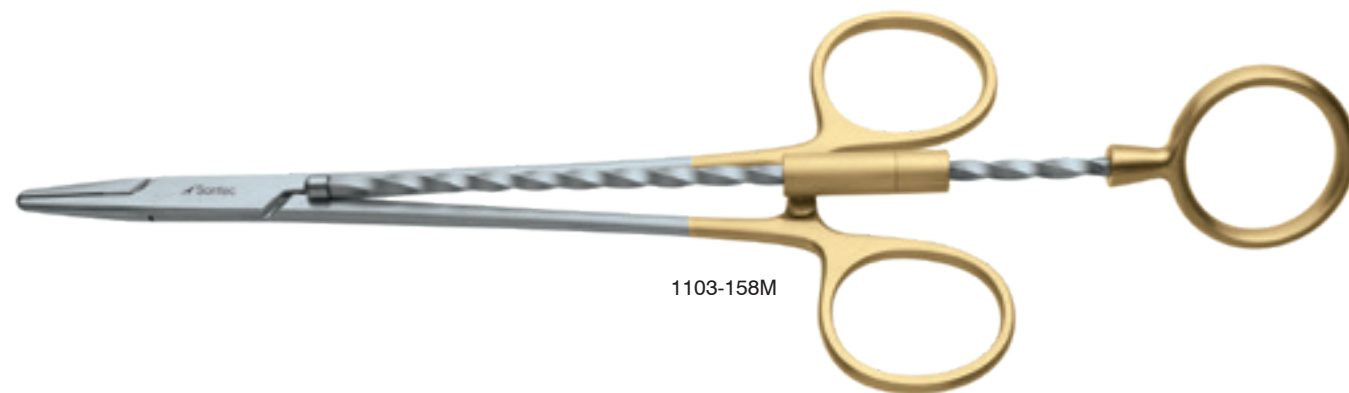

TC Jet Wire Twister Corkscrew Design Heavy Needle Holder

Broad jaw / 7" (17.8 cm)
1103-152A



Cerclage Torpedo Type Wire Twister

Stainless / 5" (12.5 cm)
1100-496



Bio-Met Wire Twister

Aluminum handle / 6" (15 cm)
1103-158B



1103-158B

Bio-Met Type Wire Twister

6" (15 cm)
1103-171



1103-171

Loute Wire Twister

Stainless / precise adjustment capabilities / 8 1/2" (22 cm)
1100-496L



1100-496L

Jet Wire Twister

Automatic / 8" (20 cm) / with cutter
1103-158



1103-158

Spring loaded with ratchet / 11" (28 cm)
/ without cutter
1103-158S



1103-158S

Cerclage Double Torpedo Type Wire Twister

Stainless / phenolic handle / 9 3/4" (25 cm)
1100-496D



1100-496D



 Sontec Instruments®

ARTHROSCOPIC

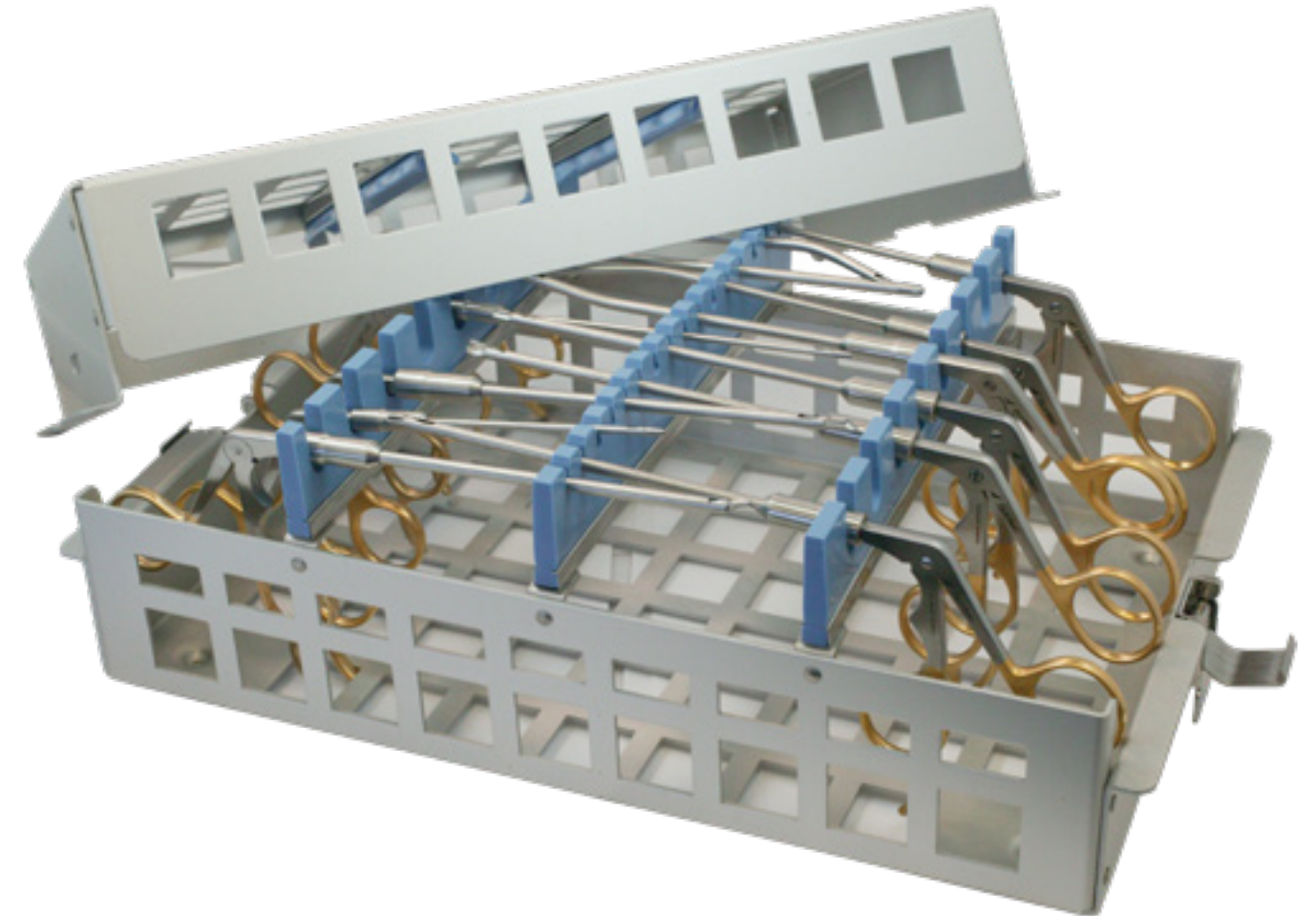

Complete Arthroscopic sets (including tray) are available upon request. Please contact Sontec for more information.

Items shown are examples only. Customer must choose which 16 items to include in the set.

Restrictions apply 18-3318 tray only

Arthroscopic Hook Punch

7" (18 cm)

2.7mm - custom size / please call Sontec for availability

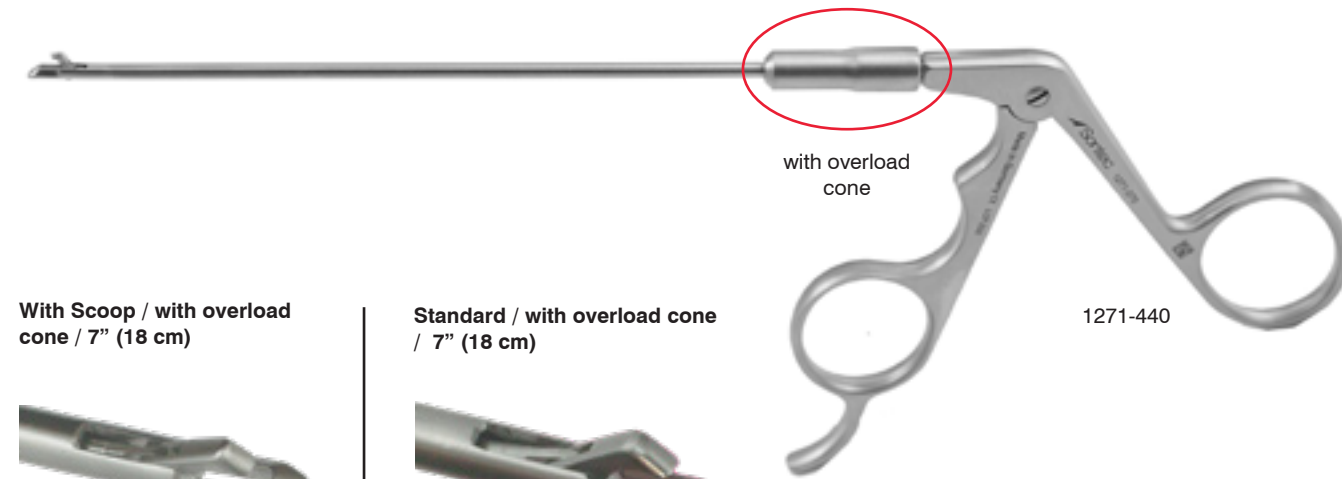

with overload cone

1271-440

With Scoop / with overload cone / 7" (18 cm)



Standard / with overload cone / 7" (18 cm)



2.7 mm

- 1271-370 straight
- 1271-371 30° left
- 1271-372 30° right
- 1271-373 45° left
- 1271-374 45° right
- 1271-375 15° curved up

2.7 mm

- 1271-420 straight
- 1271-421 30° left
- 1271-422 30° right
- 1271-423 45° left
- 1271-424 45° right
- 1271-425 15° curved up

3.4 mm

- 1271-380 straight
- 1271-381 30° left
- 1271-382 30° right
- 1271-383 45° left
- 1271-384 45° right
- 1271-385 15° curved up

3.4 mm

- 1271-430 straight
- 1271-431 30° left
- 1271-432 30° right
- 1271-433 45° left
- 1271-434 45° right
- 1271-435 15° curved up

4.5 mm

- 1271-390 straight
- 1271-391 30° left
- 1271-392 30° right
- 1271-393 45° left
- 1271-394 45° right
- 1271-395 15° curved up

4.5 mm

- 1271-440 straight
- 1271-441 30° left
- 1271-442 30° right
- 1271-443 45° left
- 1271-444 45° right
- 1271-445 15° curved up

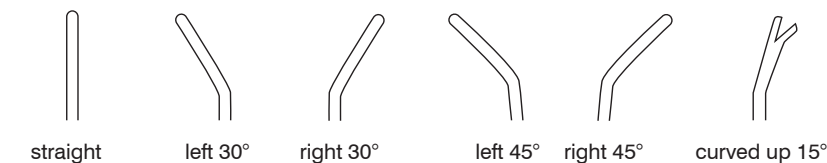

Arthroscopic Mini Low Profile Hook Punch

7" (18 cm)

2.7mm - custom size / please call Sontec for availability

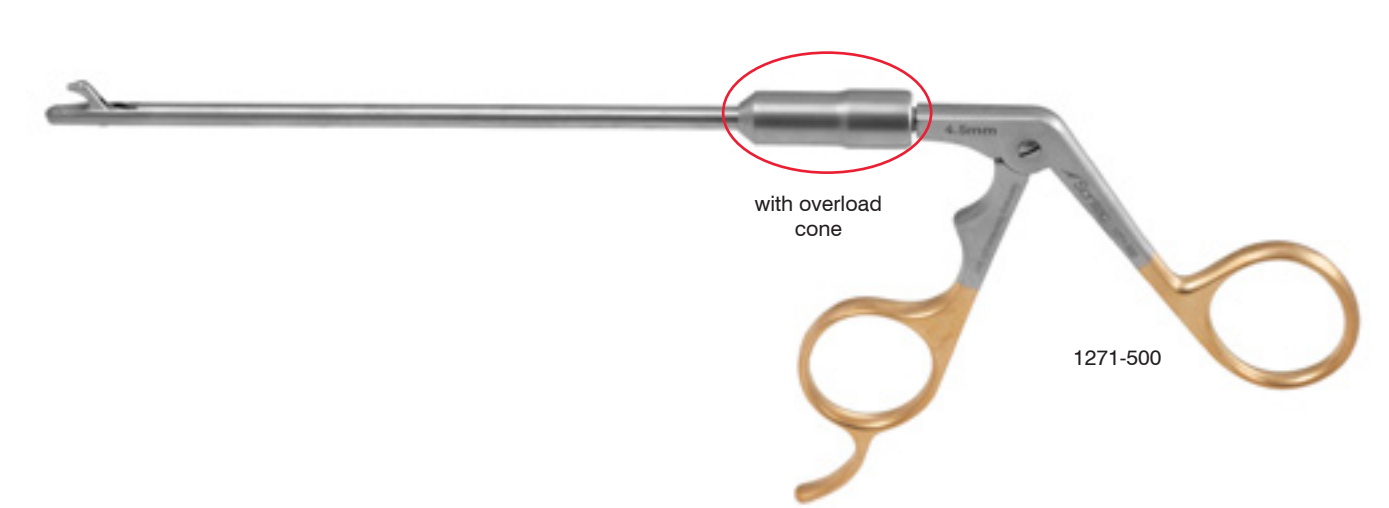

with overload cone

1271-500

Hook

With mini jaw / with overload cone



2.7 mm

- 1271-480 straight
- 1271-481 30° left
- 1271-482 30° right
- 1271-483 45° left
- 1271-484 45° right
- 1271-485 15° curved up

3.4 mm

- 1271-490 straight
- 1271-491 30° left
- 1271-492 30° right
- 1271-493 45° left
- 1271-494 45° right
- 1271-495 15° curved up

4.5 mm

- 1271-500 straight
- 1271-501 30° left
- 1271-502 30° right
- 1271-503 45° left
- 1271-504 45° right
- 1271-505 15° curved up

Square Standard

With overload cone



2.7 mm

- 1271-350 straight
- 1271-351 30° left
- 1271-352 30° right
- 1271-353 45° left
- 1271-354 45° right
- 1271-355 15° curved up

3.4 mm

- 1271-360 straight
- 1271-361 30° left
- 1271-362 30° right
- 1271-363 45° left
- 1271-364 45° right
- 1271-365 15° curved up

Basket Standard

With overload cone



3.4 mm

- 1271-400 straight
- 1271-401 30° left
- 1271-402 30° right
- 1271-403 45° left
- 1271-404 45° right

4.5 mm

- 1271-410 straight
- 1271-411 30° left
- 1271-412 30° right
- 1271-413 45° left
- 1271-414 45° right

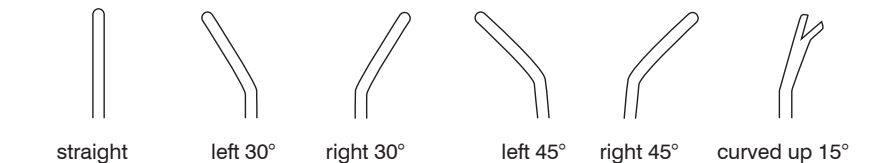

Arthroscopic Low Profile Toothed Punch

7" (18 cm)

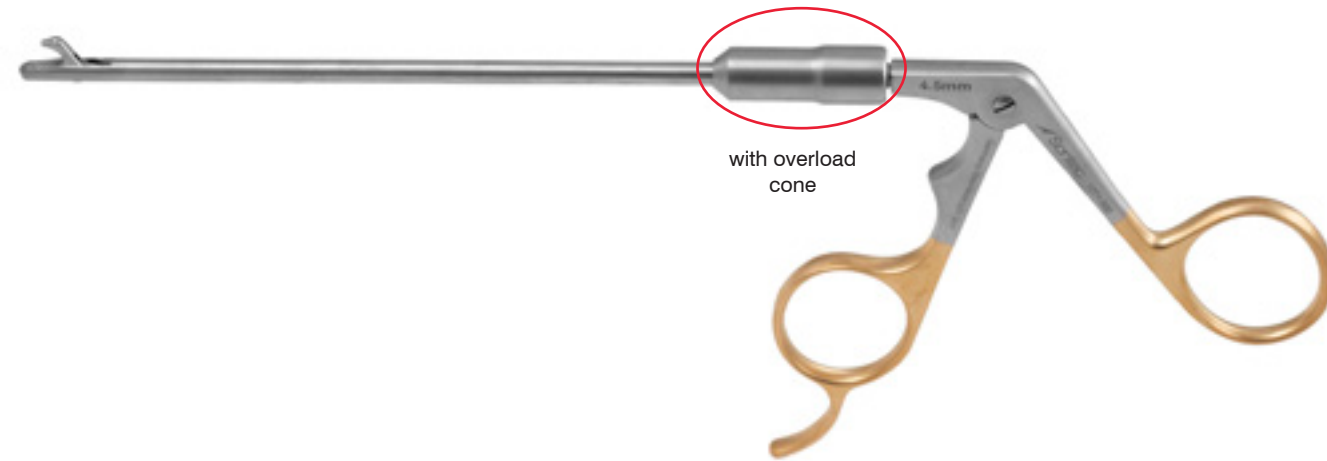

Punch

Square bite / curved up / with overload cone

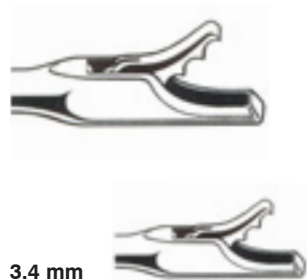

- 3.4 mm**
- 1271-510 straight
 - 1271-511 30° left
 - 1271-512 30° right
 - 1271-513 45° left
 - 1271-514 45° right
 - 1271-515 15° curved up

Punch

Square bite / curved up 15° / with overload cone



- 3.4 mm**
- 1271-520 straight
 - 1271-521 30° left
 - 1271-522 30° right
 - 1271-523 45° left
 - 1271-524 45° right
 - 1271-525 15° curved up

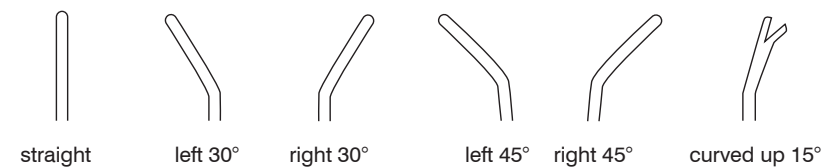

Arthroscopic Right Left Side Punch

With overload cone / 7" (18 cm)



Standard / 3.4 mm jaw



Left angled

- 1271-530 straight
- 1271-531 30° left
- 1271-532 30° right
- 1271-533 45° left
- 1271-534 45° right
- 1271-535 15° curved up

Standard / 3.4 mm jaw



Right angled

- 1271-540 straight
- 1271-541 30° left
- 1271-542 30° right
- 1271-543 45° left
- 1271-544 45° right
- 1271-545 15° curved up

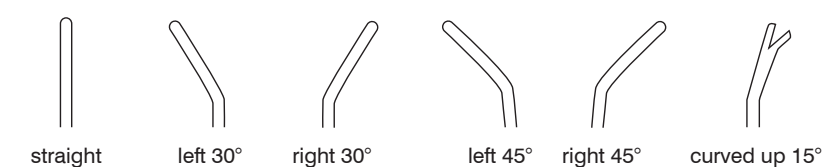

Arthroscopic Metzenbaum Hook Scissors

7" (18 cm)

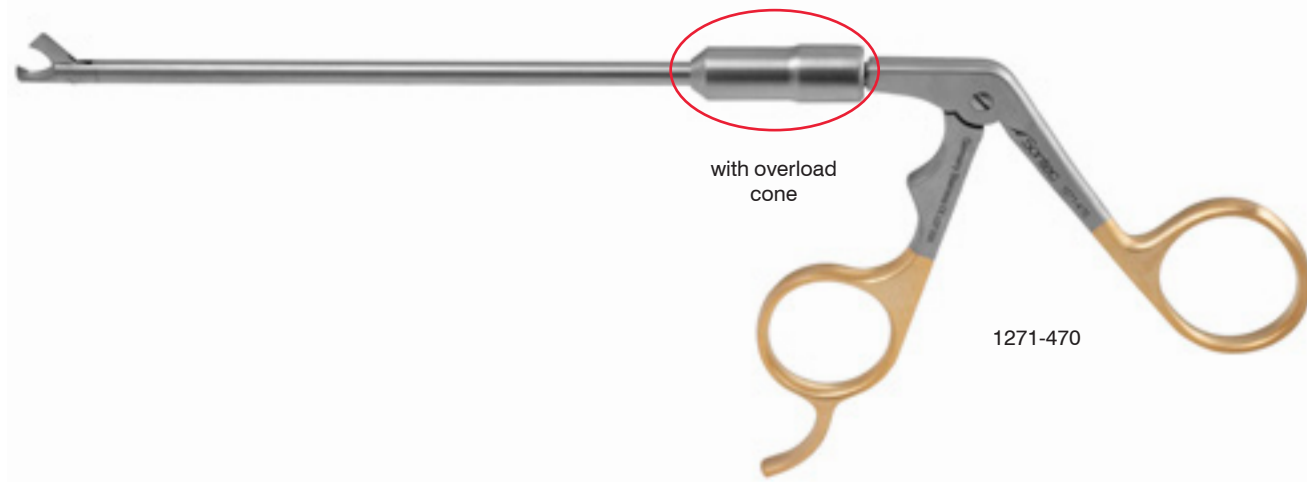

with overload cone

1271-470

Hook Scissors / with overload cone



2.7 mm

- 1271-450 straight
- 1271-451 30° left
- 1271-452 30° right
- 1271-453 45° left
- 1271-454 45° right

3.4 mm

- 1271-460 straight
- 1271-461 30° left
- 1271-462 30° right
- 1271-463 45° left
- 1271-464 45° right

4.5 mm

- 1271-470 straight
- 1271-471 30° left
- 1271-472 30° right
- 1271-473 45° left
- 1271-474 45° right

Straight / with overload cone / metzenbaum blades



3.4 mm

- 1271-550 straight
- 1271-551 30° left
- 1271-552 30° right
- 1271-553 45° left
- 1271-554 45° right
- 1271-555 15° curved up

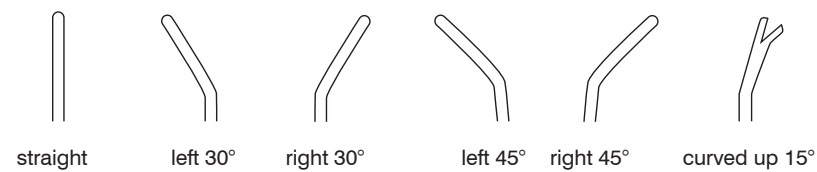

Arthroscopic, Forceps, Biopsy & Grasping Rongeur Forceps

Biopsy grasper forceps / tubular shaft / serrated bite

- 1271-020 2.0 mm cup 4" (10 cm) shaft
- 1271-016 2.7 mm cup 4" (10 cm) shaft
- 1271-018 3.4 mm cup 4" (10 cm) shaft
- 1271-021 2.0 mm cup 6" (15.5 cm) shaft
- 1271-021A 2.0 mm cup 6" (15.5 cm) shaft rear actuator hand

* Available in 4.5 mm, please ask for details

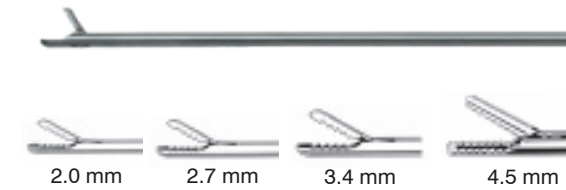

Tubular 4" (10 cm) shaft / 2.0 mm cup

- 1271-005 grasping forceps
- 1271-005A grasping forceps rear actuator handle 6"
- 1271-006 fine scissors
- 1271-007 basket punch
- 1271-008 round punch





















All tubular shaft instruments available upon request with rear actuator handles

1271-005A

Arthroscopic Punch & Scissors

Overload cone for added strength / 5 3/4" (14.5 cm)
shaft measurement is from jaw to overload cone

| | | Straight | Left 30° | Right 30° | Left 45° | Right 45° | wCurved Up 15° |
|-----------------------------|--|---|---|---|--|---|---|
| | |  |  |  |  |  |  |
| Square Punch | 2.7 mm  | 1271-350 | 1271-351 | 1271-352 | 1271-353 | 1271-354 | 1271-355 |
| | 3.4 mm  | 1271-360 | 1271-361 | 1271-362 | 1271-362 | 1271-364 | 1271-365 |
| Hook Punch with Scop | 2.7 mm  | 1271-370 | 1271-371 | 1271-372 | 1271-373 | 1271-374 | 1271-375 |
| | 3.4 mm  | 1271-380 | 1271-381 | 1271-382 | 1271-383 | 1271-384 | 1271-385 |
| | 4.5 mm  | 1271-390 | 1271-391 | 1271-392 | 1271-393 | 1271-394 | 1271-395 |
| Basket Punch | 3.4 mm  | 1271-400 | 1271-401 | 1271-402 | 1271-403 | 1271-404 | |
| | 4.5 mm  | 1271-410 | 1271-411 | 1271-412 | 1271-413 | 1271-414 | |
| | | | | | | | |
| Hook Punch | 2.7 mm  | 1271-420 | 1271-421 | 1271-422 | 1271-423 | 1271-424 | 1271-425 |
| | 3.4 mm  | 1271-430 | 1271-431 | 1271-432 | 1271-433 | 1271-434 | 1271-435 |
| | 4.5 mm  | 1271-440 | 1271-441 | 1271-442 | 1271-443 | 1271-444 | 1271-445 |
| Hook Scissors | 2.7 mm  | 1271-450 | 1271-451 | 1271-452 | 1271-453 | 1271-454 | |
| | 3.4 mm  | 1271-460 | 1271-461 | 1271-462 | 1271-463 | 1271-464 | |
| | 4.5 mm  | 1271-470 | 1271-471 | 1271-472 | 1271-473 | 1271-474 | |



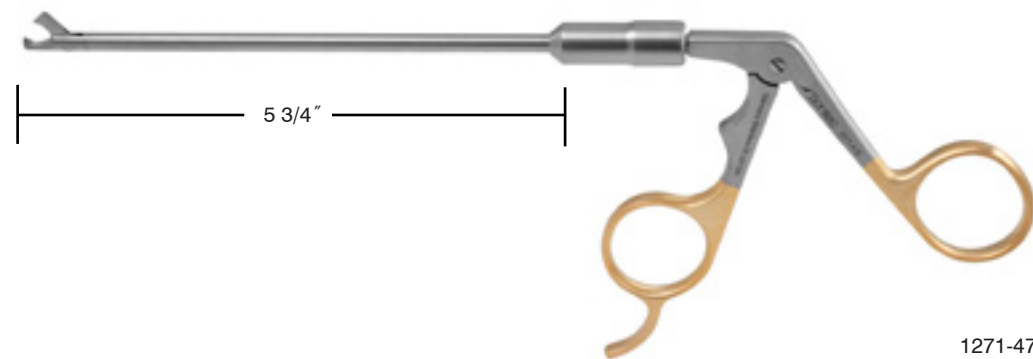







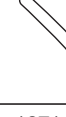

continues on next page



1271-470

Arthroscopic Punch Rongeur

Overload cone for added strength / 5 3/4" (14.5 cm)
shaft measurement is from jaw to overload cone

| | | Straight | Left 30° | Right 30° | Left 45° | Right 45° | wCurved Up 15° |
|-----------------------------------|--|---|---|---|---|---|---|
| | |  |  |  |  |  |  |
| Hook Punch with Mini Jaw | 2.7 mm  | 1271-480 | 1271-481 | 1271-482 | 1271-483 | 1271-484 | 1271-485 |
| | 3.4 mm  | 1271-490 | 1271-491 | 1271-492 | 1271-493 | 1271-494 | 1271-495 |
| | 4.5 mm  | 1271-500 | 1271-501 | 1271-502 | 1271-503 | 1271-504 | 1271-505 |
| Square Bite / curved up | 3.4 mm  | 1271-510 | 1271-511 | 1271-512 | 1271-513 | 1271-514 | 1271-515 |
| Square Bit / curved up 15° | 3.4 mm  | 1271-520 | 1271-521 | 1271-522 | 1271-523 | 1271-524 | 1271-525 |
| Side punch / left | 3.4 mm  | 1271-530 | 1271-531 | 1271-532 | 1271-533 | 1271-534 | 1271-535 |
| Side Punch / right | 3.4 mm  | 1271-540 | 1271-541 | 1271-542 | 1271-543 | 1271-544 | 1271-545 |
| Scissor, / straight | 3.4 mm  | 1271-550 | 1271-551 | 1271-552 | 1271-553 | 1271-554 | 1271-555 |

Arthroscopic Grasping Forceps

Overload cone / available with or without ratchet /
5 3/4" (14.5 cm) shaft

| Grasping Forcep | | | | | | | | |
|--------------------------------------|---------------------|--|-----------|-----------|-----------|-----------|-----------|-----------|
| | 2.7 mm | | 1271-060 | 1271-061 | 1271-062 | 1271-063 | 1271-064 | 1271-085 |
| | 3.4 mm | | 1271-065 | 1271-066 | 1271-067 | 1271-068 | 1271-069 | 1271-086 |
| | 4.5 mm | | 1271-070 | 1271-071 | 1271-072 | 1271-073 | 1271-074 | 1271-087 |
| | 3.4 mm / 1x2 tth | | 1271-610 | 1271-611 | 1271-612 | 1271-613 | 1271-614 | 1271-615 |
| | 4.5 mm / 1x2 tth | | 1271-620 | 1271-621 | 1271-622 | 1271-623 | 1271-624 | 1271-625 |
| Grasping Forcep with ratchet | | | | | | | | |
| | 2.7 mm | | 1271-060R | 1271-061R | 1271-062R | 1271-063R | 1271-064R | 1271-085R |
| | 3.4 mm | | 1271-065R | 1271-066R | 1271-067R | 1271-068R | 1271-069R | 1271-086R |
| | 4.5 mm | | 1271-070R | 1271-071R | 1271-072R | 1271-073R | 1271-074R | 1271-087R |
| | 3.4 mm / 1x2 tth | | 1271-640 | 1271-641 | 1271-642 | 1271-643 | 1271-644 | 1271-645 |
| | 4.5 mm / 1x2 tth | | 1271-650 | 1271-651 | 1271-652 | 1271-653 | 1271-654 | 1271-655 |
| Biopsy & Grasping Forceps | | | | | | | | |
| | 2.7 mm | | 1271-090 | 1271-091 | 1271-092 | 1271-093 | 1271-094 | 1271-095 |
| | 3.4 mm | | 1271-101 | 1271-102 | 1271-103 | 1271-104 | 1271-105 | 1271-106 |
| | 4.5 mm | | 1271-107 | 1271-108 | 1271-109 | 1271-110 | 1271-111 | 1271-112 |

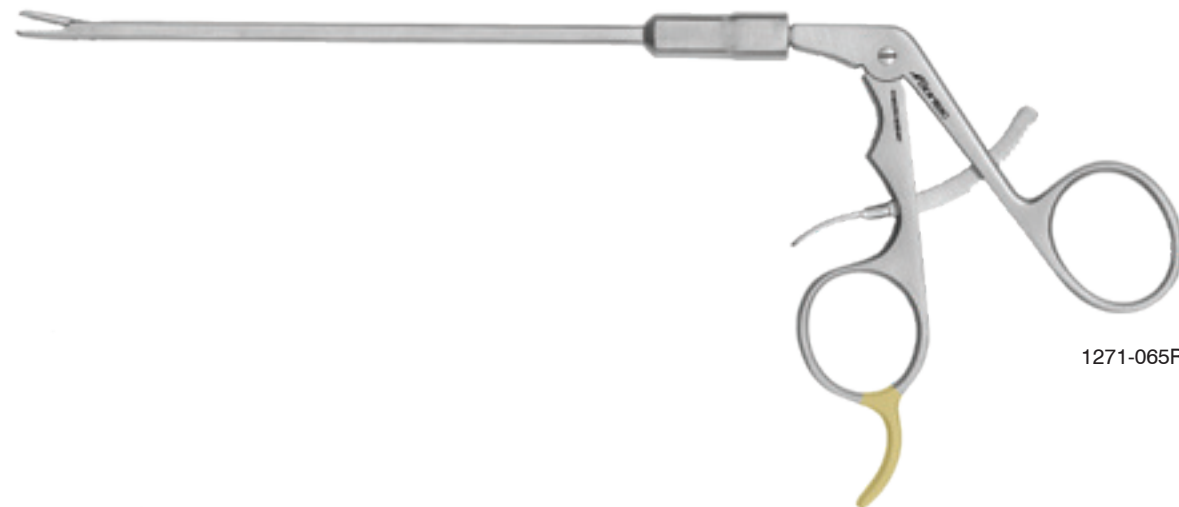

1271-065R

Arthroscopic Grasping Forceps

Overload cone / for small joints / available with or
without ratchet / 4" (10 cm) shaft

| Grasping Forcep | | | | | | | | |
|--------------------------------------|--------|--|-----------|-----------|-----------|-----------|-----------|-----------|
| | 2.7 mm | | 1270-060 | 1270-061 | 1270-062 | 1270-063 | 1270-064 | 1270-085 |
| | 3.4 mm | | 1270-065 | 1270-066 | 1270-067 | 1270-068 | 1270-069 | 1270-086 |
| | 4.5 mm | | 1270-070 | 1270-071 | 1270-072 | 1270-073 | 1270-074 | 1270-087 |
| Grasping Forcep with ratchet | | | | | | | | |
| | 2.7 mm | | 1270-060R | 1270-061R | 1270-062R | 1270-063R | 1270-064R | 1270-085R |
| | 3.4 mm | | 1270-065R | 1270-066R | 1270-067R | 1270-068R | 1270-069R | 1270-086R |
| | 4.5 mm | | 1270-070R | 1270-071R | 1270-072R | 1270-073R | 1270-074R | 1270-87R |
| Biopsy & Grasping Forceps | | | | | | | | |
| | 2.7 mm | | 1270-090 | 1270-091 | 1270-092 | 1270-093 | 1270-094 | 1270-095 |
| | 3.4 mm | | 1270-101 | 1270-102 | 1270-103 | 1270-104 | 1270-105 | 1270-106 |
| | 4.5 mm | | 1270-107 | 1270-108 | 1270-109 | 1270-110 | 1270-111 | 1270-112 |



1270-060

Arthroscopic Biopsy Grasping Forceps

Straight / 2.7 mm jaw / overload cone / with ratchet / 4" (10 cm) shaft
1270-090R

Straight / 2.7 mm jaw / overload cone / with ratchet / 7" (18 cm) shaft
1271-090R



Arthroscopic Biopsy Grasping Forceps

Overload cone / 3.4 mm jaw / available with or without ratchet / 4" (18 cm) shaft
1270-101R

Overload cone / 3.4 mm jaw / available with or without ratchet / 7" (18 cm) shaft
1271-101R



Arthroscopic Biopsy Grasping Forceps

Straight / 4.5 mm jaw / overload cone / with ratchet / 3 1/4" (8.25 cm) working shaft length
1270-107R

Straight / 4.5 mm jaw / overload cone / with ratchet / 7" (18 cm) working shaft length
1271-107R



Suction Arthroscopic Cut Through Punch Rongeur

5° up / 4" (20 cm) shaft / comes with stylus
1271-040 2.5 mm jaw

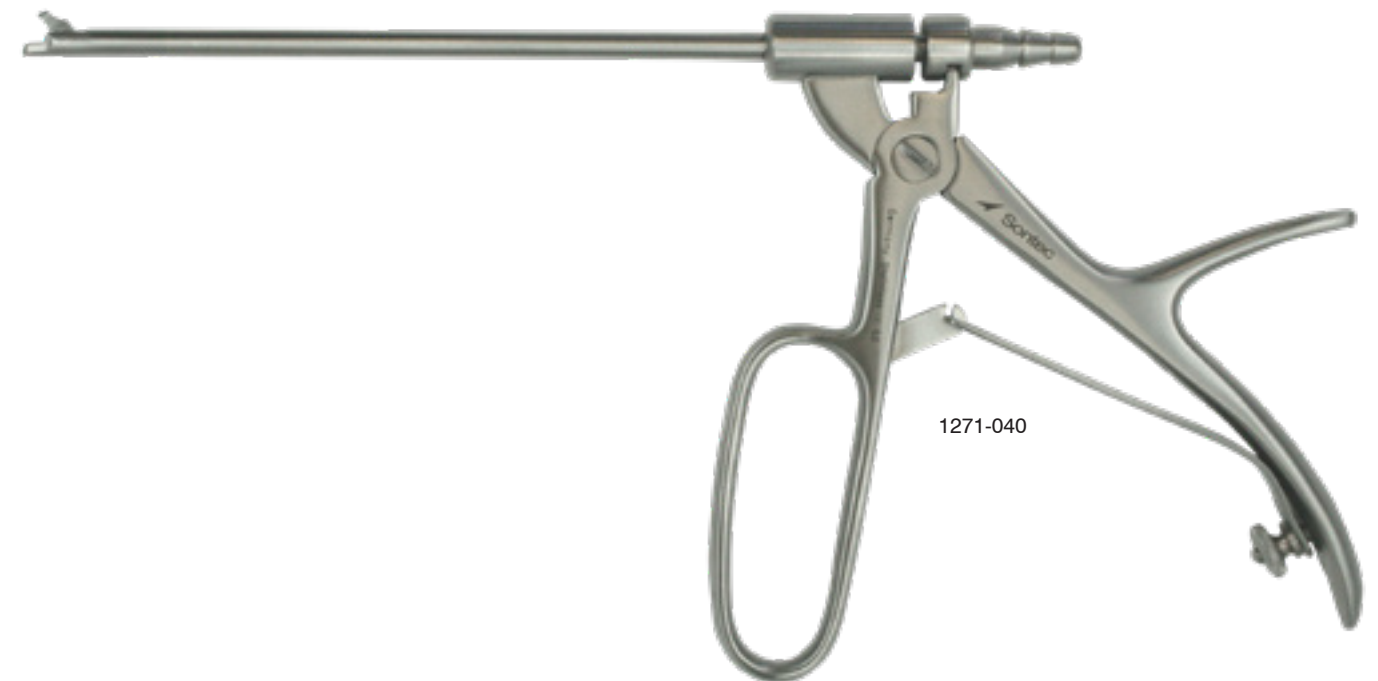

Suction Arthroscopic Cut Through Punch Rongeur

5° up / 5 mm Ø shaft / 140 mm working length

1271-042 3 mm jaw



McIlwraith Suction Arthroscopic Cut Through Punch Rongeur

5° up / 5" shaft / extra long bore 5 mm I.D.

1271-041 5 mm jaw



Arthroscopic Needle Holder

With clean flush port / TC serrated jaw / curved

1271-113



Hook Punch

2.7 mm / straight / with overload cone / 5" (12.7 cm)

1271-426



Arthroscopic Maxi Grasper

Large serrated teeth / crab claw jaws / open center jaw 18 mm elliptical gap when jaws are fully closed / 7" (18 cm)

404-765



404-765

Arthroscopic Mini Grasper

Serrated upper jaw with smooth lower jaw / crab claw jaw / 18 mm jaw / 6" (15.2 cm)

404-764



404-764

Meniscus Grasping Forceps

Axial, ring handled grip / serrated jaw / 1 x 2 teeth / 7" (18 cm)

- 1404-852 straight
- 1404-854 curved left
- 1404-853 curved right



1404-852

1404-854

1404-853

Rotary Arthroscopic Scissors

- 1273-100 hook left 20°
- 1273-101 hook right 20°
- 1273-103 hook right 60°
- 1273-105 hook left 60°



1273-100

1273-103

Triangle Handle Arthroscopic Meniscotome, Hook, Probe & Knife

9 1/4" (23.5 cm) / triangle handle

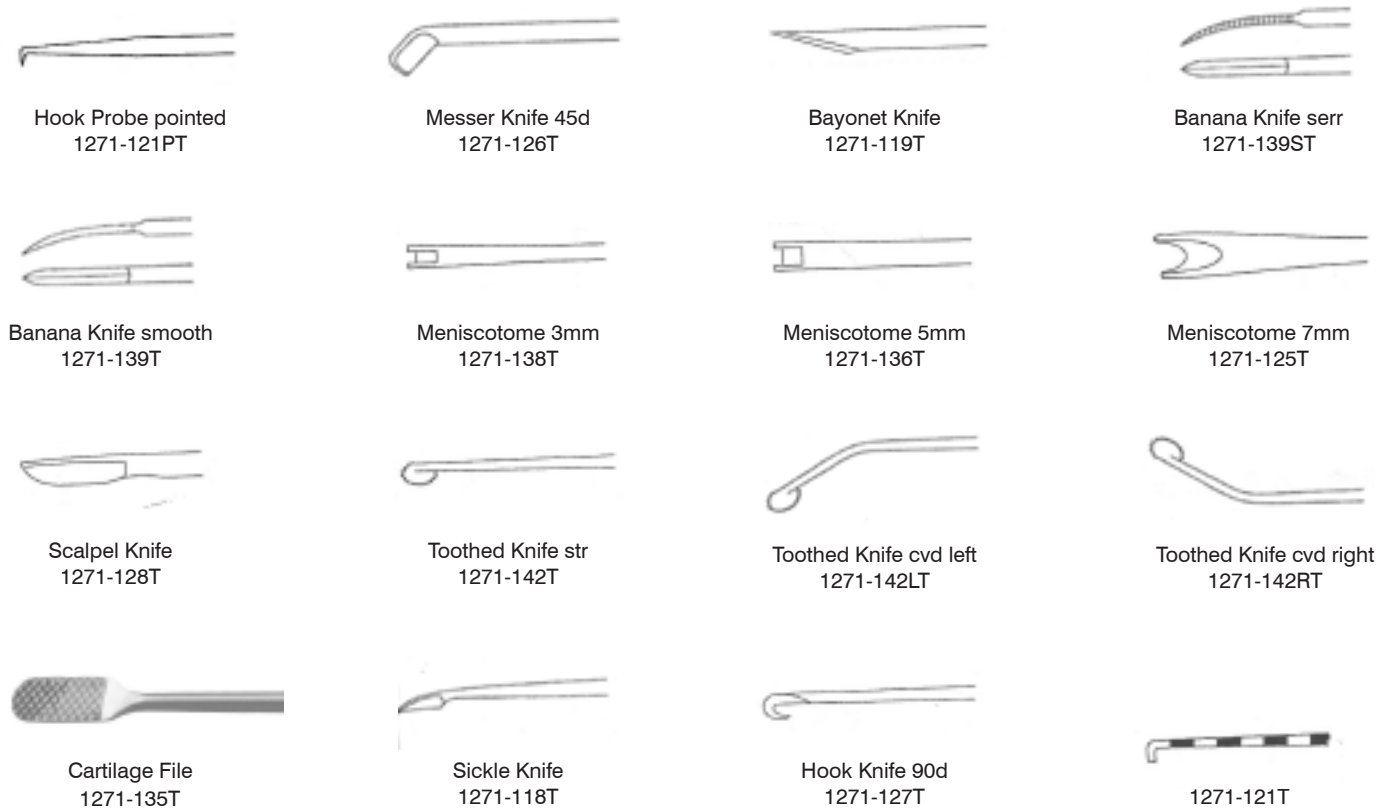

Arthroscopic Meniscotomes Hook, Probe & Knife

9" (23 cm) / knurled handle sold separately



Arthroscopic Meniscotomes Hook, Probe & Knife

9" (23 cm) / handle sold separately / fit universal handle / choose either knurled handle or universal handle-shaft combination

- 1271-143 universal handle sold separately 4 3/4"
- 1271-143L universal handle extra long 8" special order

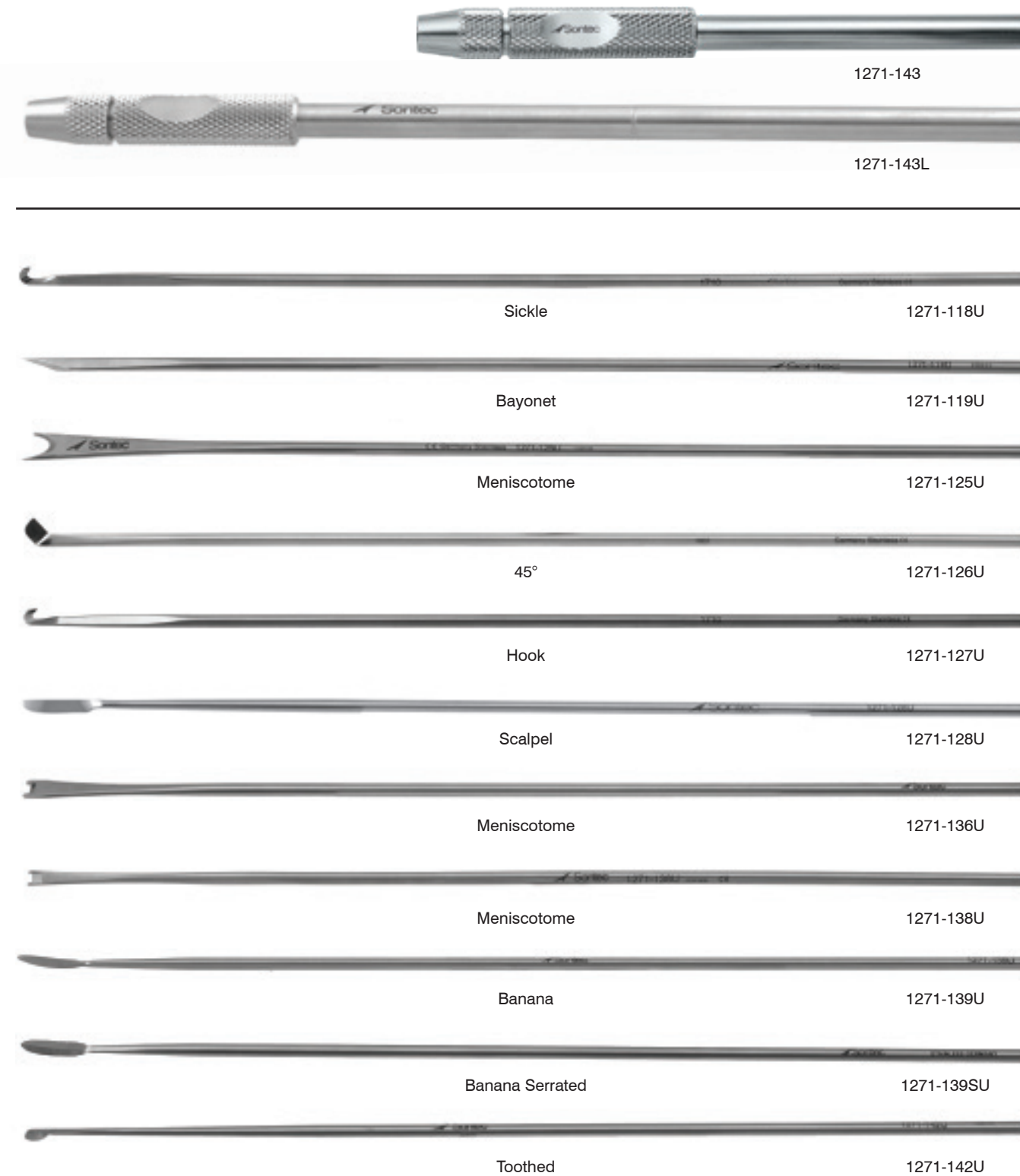

Arthroscopic Curette & Ring Curette

9 1/4" (23.5 cm) / triangle handle

- 1271-116T 30 degrees
- 1271-148S 3 mm ring tip
- 1271-148T 7 mm ring tip 30°

9 1/4" (23.5 cm) / triangle handle / 30°

- 1271-149 5 mm ring tip

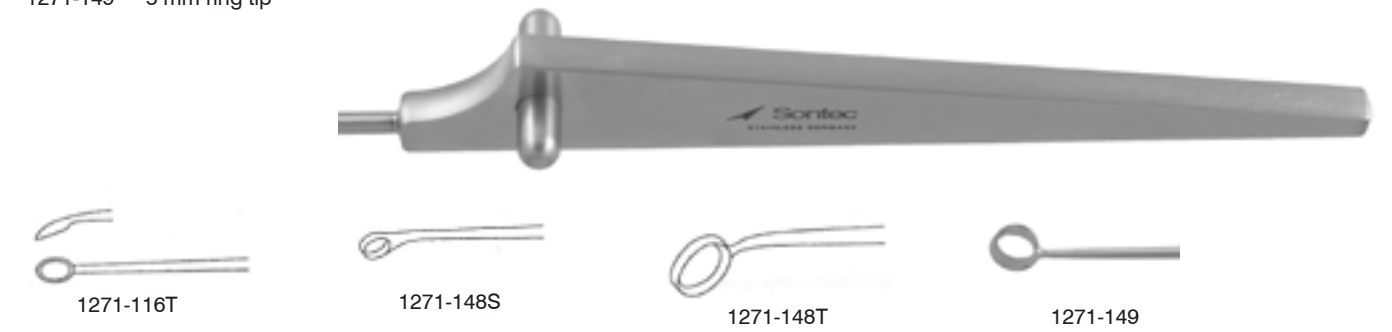

Knurled handle / 3 mm / 9" (23 cm)

- 1271-115 30° curved curette
- 1271-140 right angled sharp ring tip

"U" Fit universal handle / 3 mm / 9" (23 cm)

- 1271-116U 30° curved curette
- 1271-140U right angled sharp ring tip

Universal handle sold separately

- 1271-143 universal handle sold separately

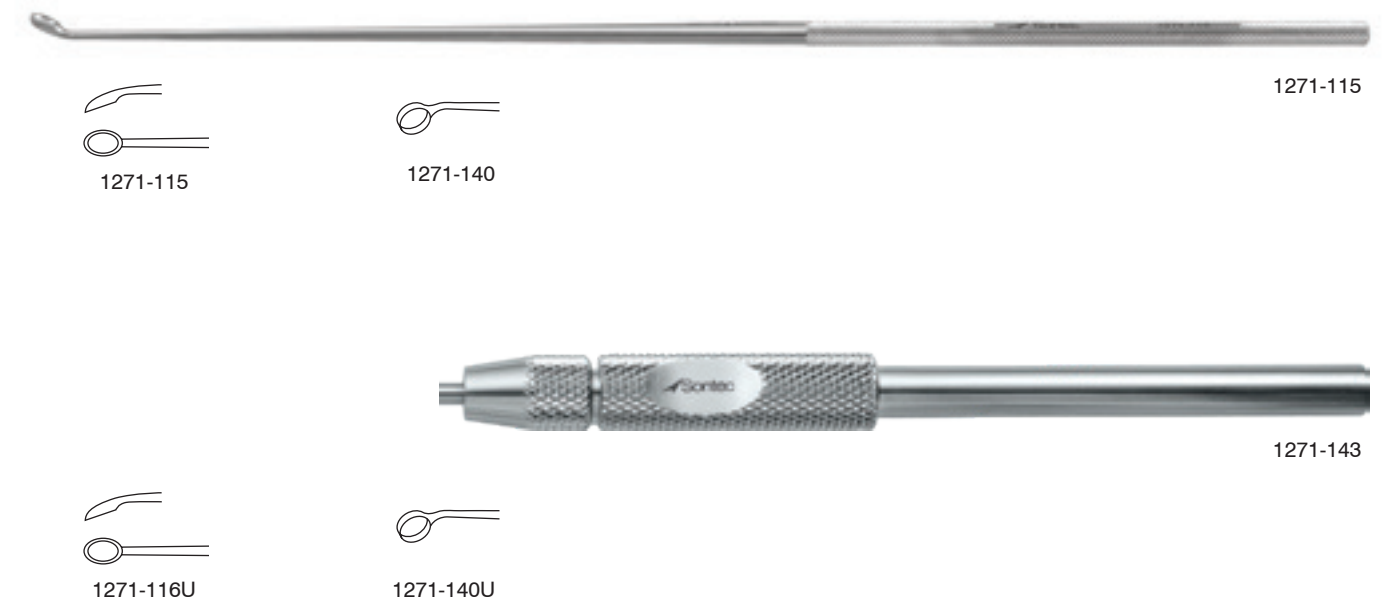

Arthroscopic Hook Probe

9" (23 cm)

| | | |
|------------|--------|----------------------|
| 1271-121 | 3.5 mm | knurled handle |
| 1271-122 | 2.5 mm | knurled handle |
| 1271-122U | 2.5 mm | for universal handle |
| 1271-121U | 3.5 mm | for universal handle |
| 1271-1204U | 4 mm | for universal handle |
| 1271-120U | 5 mm | for universal handle |



1271-121

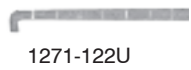

1271-122U

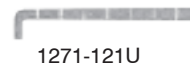

1271-121U

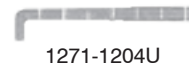

1271-1204U

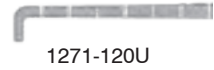

1271-120U



Universal Handle sold separately

Arthroscopic Rasp

Item numbers followed by "U" fit universal handle / 9" (23 cm)

| | |
|----------|----------------------------------|
| 1271-134 | |
| 1271-143 | universal handle sold separately |

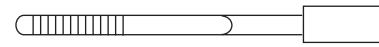

1271-134



1271-143

Arthroscopic Hook Probe with Conical Handle

3.5 mm tip

| | |
|-----------|--------|
| 1271-121A | 4 1/2" |
| 1271-121B | 6" |
| 1271-121C | 7 1/2" |

4 mm tip Ø

| | |
|-----------|--------|
| 1271-1218 | 8 1/4" |
|-----------|--------|



1271-121C



1271-1218

McIlwraith Arthroscopic Hook Probe

Graduated / light / 9 1/2" (24 cm)

1271-129



1271-129

Graduated / heavy / 10 1/2" (26 cm)

1271-130



1271-130

Phenolic handle / 10 1/4" (26 cm)

1271-130PH



1271-130PH

Taylor Micro Arthroscopic Hook Probe & Pick

1.2mm / 8" (20 cm)

| | |
|----------|----------|
| 1271-120 | straight |
| 1271-123 | curved |

3 mm hook / 1 mm ball tip / lightweight type handle / 8 1/2" (21.5 cm)

1271-123LW



1271-123



1271-120



1271-123LW

Arthroscopic Rasp

Item numbers followed by "U" fit universal handle / 4x6 mm / 9" (23 cm)

- 1271-133U straight
- 1271-133AU 15° angle
- 1271-143 universal handle sold separately



Chondro Pick

Silicone handle / 6 mm Ø shaft / 125 mm working length / 9" (23 cm) overall length

Specifically designed for the treatment of micro fracture cartilage defects on large and medium joints

- 1271-315 straight
- 1271-316 25° angled tip
- 1271-317 40° angled tip
- 1271-318 60° angled tip
- 1271-319 90° angled tip



Bone Pick Micro Fracture

Phenolic handle / 30° tip

- 1271-320 6 7/8" (17.5 cm) mini
- 1271-330 7 1/2" (19 cm) peterson
- 1271-325 10 3/4" (27.5cm) equine

Phenolic handle / 60° tip

- 1271-321 6 7/8" (17.1 cm)
- 1271-322 7 1/2" (19.1 cm)
- 1271-326 10 3/4" (27.3 cm)

Phenolic handle / 90° tip

- 1271-323 6 7/8" (17.1 cm)
- 1271-324 7 1/2" (19.1 cm)
- 1271-327 10 3/4" (27.3 cm)



Inflow Cannula Set

Set includes a sharp and blunt cannula

- SC95-0300-SET 4.5 mm includes infusion adapter complete set
- SC95-0305 4.5 mm infusion adapter only
- SC95-0302-SET 5.5 mm includes infusion adapter complete set
- SC95-0306 5.5 mm infusion adapter only

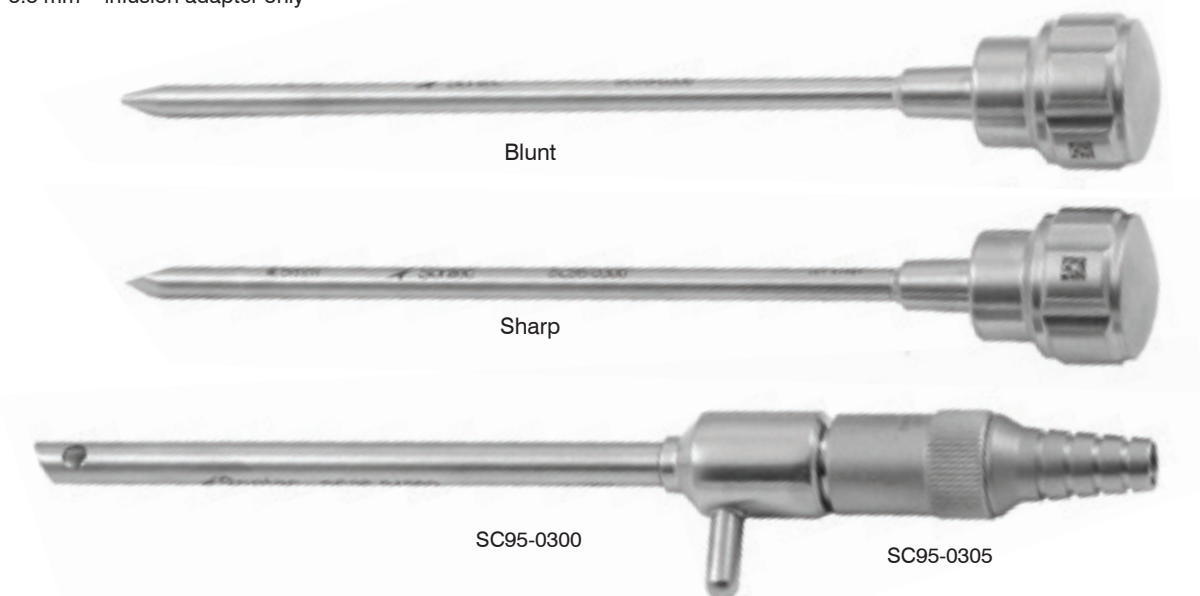

Egress Cannula Set

Cutting obturator / lateral irrigation holes / 2 3/4" (7 cm) working length / set includes a sharp and blunt cannula

| | | | |
|---------------|-----------------|-------------------|---------------|
| SC95-0310-SET | 3.2 mm diameter | without stop cock | special order |
| SC95-0315-SET | 3.2 mm diameter | with stop cock | |
| SC95-0415-SET | 4.5 mm diameter | with stop cock | |

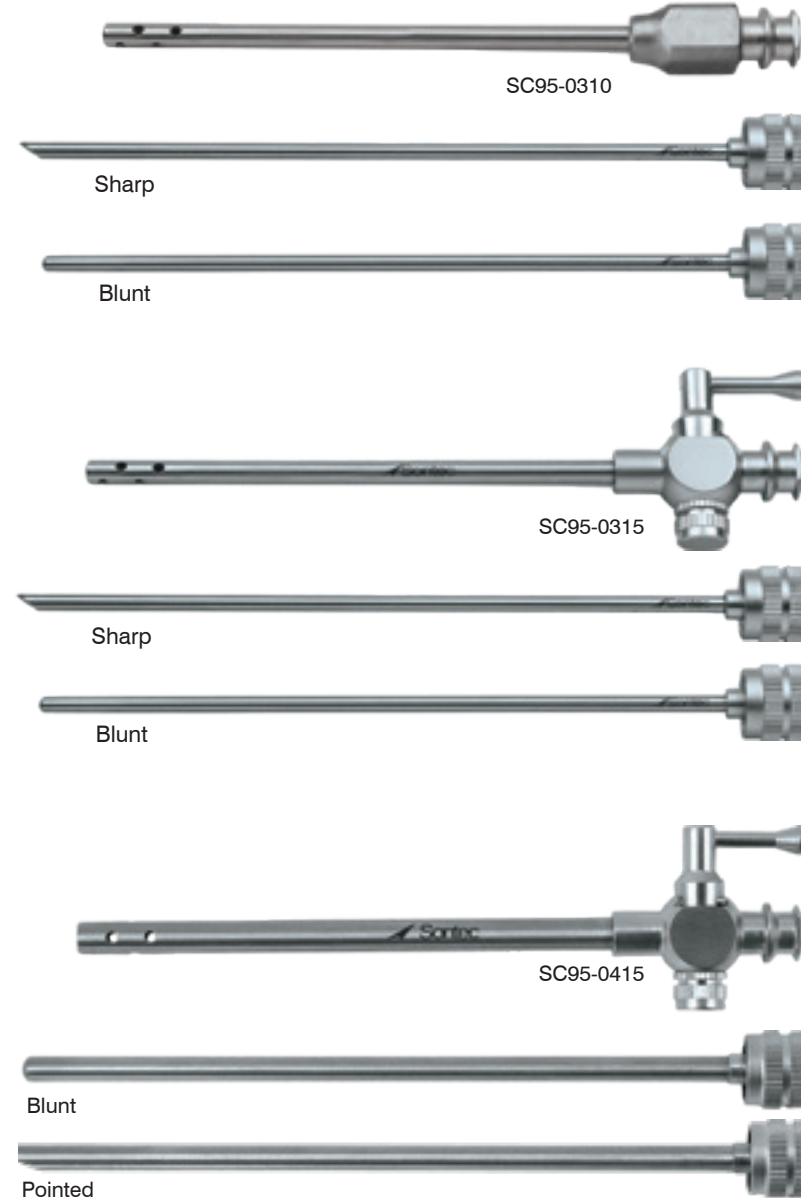

Egress Cannula Set

With conical obturator / 6" (15.2 cm) working length

| | |
|------------|-----------|
| SC94-0312 | 3.1 mm ID |
| SC94-0313 | 4.1 mm ID |
| SC94-0314 | 5.1 mm ID |
| SC94-0315 | 6.1 mm ID |
| SC94-03157 | 7.1 mm ID |
| SC94-03158 | 8.1 mm ID |
| SC94-03159 | 9.1 mm ID |

With Conical obturator / 12" (30.5 cm) working length

| | |
|-----------|-----------|
| SC94-0316 | 3.1 mm ID |
| SC94-0317 | 4.1 mm ID |
| SC94-0318 | 5.1 mm ID |
| SC94-0319 | 6.1 mm ID |
| SC94-0320 | 7.1 mm ID |
| SC94-0321 | 8.1 mm ID |
| SC94-0322 | 9.1 mm ID |

* CUSTOM - specify size (diameter & length) when ordering

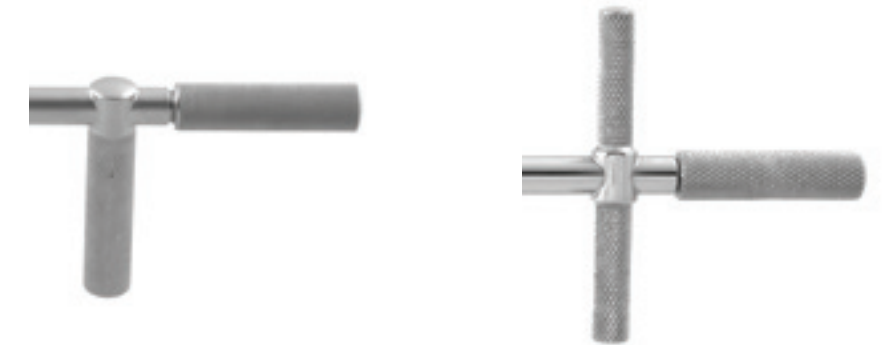

available with T-handle or L-handle shown above



Arthroscopic Switch Stick

8 3/4"

| | |
|------------|-------|
| 1271-117-1 | 1.1mm |
| 1271-117-5 | 2.4mm |
| 1271-117-2 | 2.9mm |
| 1271-117 | 3.2mm |
| 1271-117-3 | 3.7mm |

Set of 5 / 8 3/4"

1271-117-4 sizes in set:

| |
|-------|
| 1.1mm |
| 2.4mm |
| 2.9mm |
| 3.2mm |
| 3.7mm |



1271-117

Small Joint Arthroscopic Cannula Switch Stick Set

Complete with 4 cannulas, 4 switch sticks, cannulated obturator, and lightweight anodized case

SC95-0425

*Instruments are also available separately

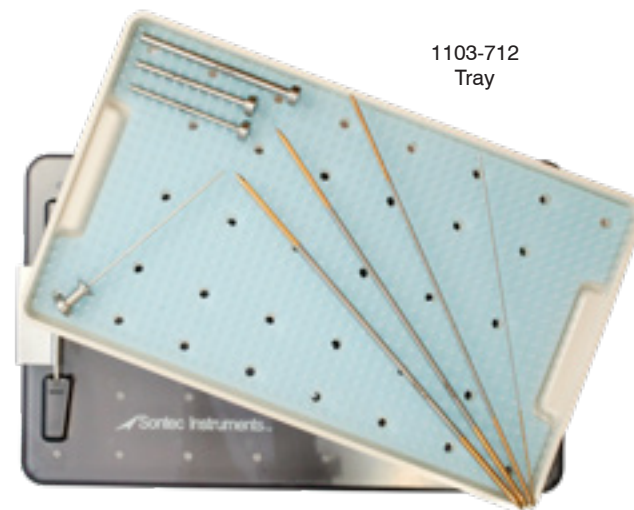

1103-712
Tray

Small Joint Arthroscopic Cannula

| | | |
|-----------|--------|----------------|
| SC95-0421 | 2.9 mm | 2 1/2" (6.5cm) |
| SC95-0422 | 3.7 mm | 2 1/2" (6.5cm) |
| SC95-0423 | 4.3 mm | 3 1/4" (8.3cm) |
| Sc95-0424 | 5.1 mm | 3 1/4" (8.3cm) |

Arthroscopic Cannulated Obturator

Small joint / 1.3 mm / 4 1/2" (11.5cm)

SC95-0420



SC95-0421

SC95-0422

SC95-0423

SC95-0424

Arthroscopic Switch Stick

| | | |
|------------|---------------------------|----------------|
| 1271-117 | 3.2mm | 8 3/4" (22 cm) |
| 1271-117-1 | 1.1mm | 7" (18cm) |
| 1271-117-2 | 2.9mm | 8 3/4 (22cm) |
| 1271-117-3 | 3.7mm | 8 3/4 (22cm) |
| 1271-117-4 | complete switch stick set | |



1271-117

1271-117-1

1271-117-2

1271-117-3

SC95-0420

Small Joint Complete Arthroscopic Set

Includes the following instruments

Sc95-0427 complete set

* instruments are also available separately

| Item Number | Description | | | | |
|-------------|------------------------------|--------|-----------|---------------|----------------|
| 1271-020 | grasping biopsy forcep | 2 mm | serrated | 4" (10 cm) | |
| 1271-090 | grasping biopsy forcep | 2.7 mm | straight | 7" (18 cm) | overload cone |
| 1271-060R | grasping forcep with ratchet | 2.7 mm | straight | 7" (18 cm) | overload cone |
| 1271-480 | hook punch with mini jaws | 2.7 mm | straight | 7" (18 cm) | overload cone |
| 1271-143 | universal anthro handle | 125 mm | | | |
| 1271-127U | universal hook probe | 3 mm | 90° | | |
| 1271-139U | universal banana knife | | | | |
| 1271-122U | universal hook probe | 2.5 mm | graduated | | |
| 1271-121U | universal hook probe | 3.5 mm | graduated | | |
| 1271-142U | universal toothed knife | | straight | | |
| 1271-140U | universal ring curette | 3 mm | angled | | |
| SC95-0315 | irrigation cannula | 3.2 mm | | | with stop cock |
| 1271-117-1 | arthroscopic switch stick | 1.1 mm | | 8" (20.3 cm) | |
| 1271-117-2 | arthroscopic switch stick | 2.9 mm | | 8" (20.3 cm) | |
| 1271-117-3 | arthroscopic switch stick | 3.7 mm | | 8" (20.3 cm) | |
| SC95-0420 | cannulated obturator | 1.3 mm | | 4" (10 cm) | small joint |
| SC95-0421 | arthroscopic cannula | 2.9 mm | | 2 1/4" (6 cm) | small joint |
| SC95-0422 | arthroscopic cannula | 3.7 mm | | 2 1/4" (6 cm) | small joint |
| SC95-0423 | arthroscopic cannula | 4.3 mm | | 3 1/4" (8 cm) | small joint |

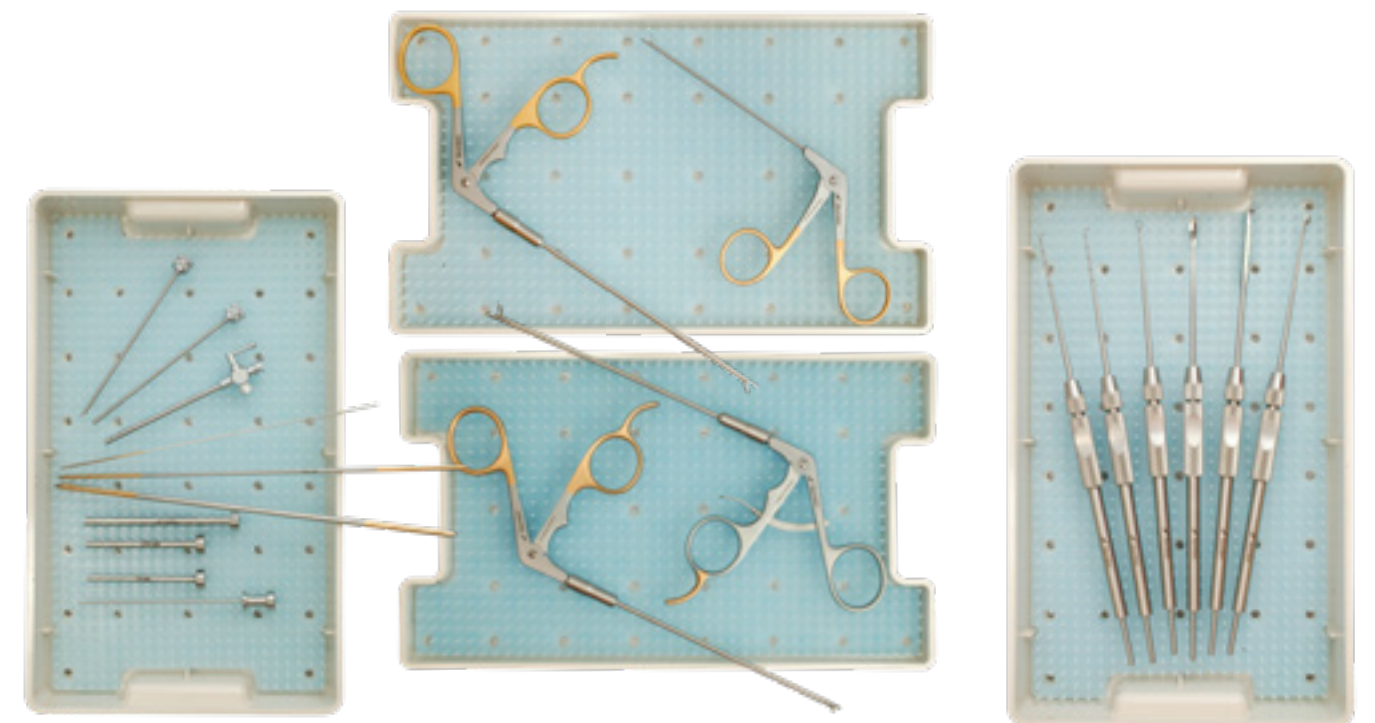

KNEE INSTRUMENTS

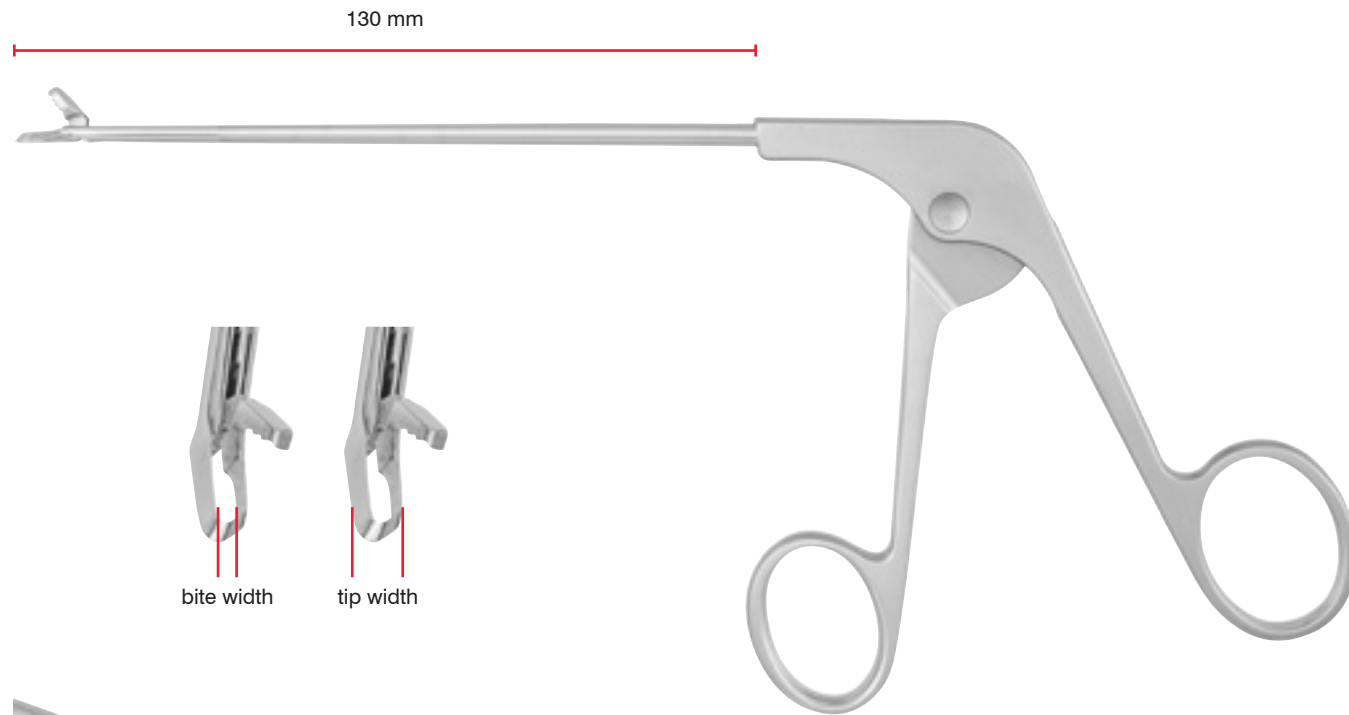

Straight: The primary style for direct approach

Upbiter: Angled at tip increased access to the posterior meniscus

Upswept: Angled shaft follows the contour of the condyle and keeps the cutting surface parallel to the tibial plateau

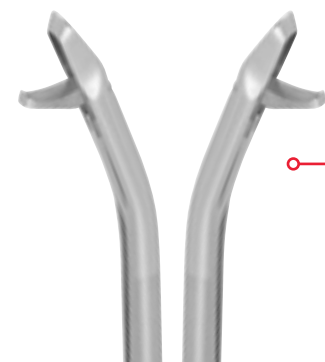

Curved left and curved right: Angled to reach the anterior and posterior meniscus

KNEE INSTRUMENTS

Classic Handle

Scissors, basket punches and graspers are equipped with our traditional classic handle



Slide Lock Handle

All graspers are equipped with this infinite position locking handle design



Ergonomic Handle

Selected punches, scissors and graspers are equipped with this ergonomic handle design



Rotatable Handle

Available on rotary basket punches and scissors



KNEE INSTRUMENTS

Punch

The Basket Punch provides a maximum tissue resection by its wave tooth and wide bite

Basket Punch / small / 5" straight shaft / 2.5 mm bite width / 4.15 mm tip width

- 1273-202 classic handle
- 1273-203 ergonomic handle



Basket Punch / small / upbiter / 5" straight shaft up / 2.5 mm bite width / 4.15 mm tip width

- 1273-204 classic handle
- 1273-205 ergonomical handle



Basket Punch / medium / 5" shaft / 3.2 mm bite width / 5.05 mm tip width / straight tip

- 1273-210 straight shaft classic handle
- 1273-211 straight shaft ergonomic handle
- 1273-214 curved left shaft classic handle
- 1273-215 curved left shaft ergonomic handle
- 1273-212 curved right shaft classic handle
- 1273-213 curved right shaft ergonomic handle
- 1273-216 upswept shaft classic handle
- 1273-217 upswept shaft ergonomic handle



Basket Punch / medium / upbiter / 5" shaft / 3.20 mm bite width / 5.05 mm tip width

- 1273-220 straight shaft classic handle
- 1273-221 straight shaft ergonomic handle
- 1273-224 curved left shaft classic handle
- 1273-225 curved left shaft ergonomic handle
- 1273-222 curved right shaft classic handle
- 1273-223 curved right shaft ergonomic handle
- 1273-226 upswept shaft classic handle
- 1273-227 upswept shaft ergonomic handle



Basket Punch / large / 5" straight shaft / 4.50 mm bite width / 6.15 mm tip width

- 1273-228 classic handle
- 1273-229 ergonomic handle



Basket Punch / large / upbiter / 5" straight shaft / 4.50 mm bite width / 6.15 mm tip width

- 1273-230 classic handle
- 1273-231 ergonomic handle



Basket Punch / upbiter / diagonal cut / 5" shaft / 3.20 mm bite width / 5.05 mm tip width

- 1273-232 curved left shaft classic handle
- 1273-233 curved left shaft ergonomic handle
- 1273-234 curved right shaft classic handle
- 1273-235 curved right shaft ergonomic handle



KNEE INSTRUMENTS

Punch

Combines wide bite with the thinnest possible tip to provide optimum maneuverability under the condyle

Gawsling Basket Punch / small / 5" shaft / 2.50 mm bite width / 4.15 mm tip width

- 1273-172 straight shaft classic handle
- 1273-173 straight shaft ergonomic handle
- 1273-174 curved right shaft classic handle
- 1273-175 curved right shaft ergonomic handle
- 1273-176 curved left shaft classic handle
- 1273-177 curved left shaft ergonomic handle
- 1273-178 upswept shaft classic handle
- 1273-179 upswept shaft ergonomic handle



Gawsling Basket Punch / small / upbiter / 5" straight shaft / 2.50 mm bite width / 4.15 mm tip width

- 1273-148 classic handle
- 1273-149 ergonomic handle



Gawsling Basket Punch / medium / 5" shaft / 3.20 mm bite width / 5.00 mm tip width

- 1273-140 straight shaft classic handle
- 1273-142 straight shaft ergonomic handle
- 1273-136 curved left shaft classic handle
- 1273-141 curved left shaft ergonomic handle
- 1273-134 curved right shaft classic handle
- 1273-139 curved right shaft ergonomic handle
- 1273-138 upswept shaft classic handle
- 1273-143 upswept shaft ergonomic handle



Gawsling Basket Punch / medium / upbiter / 5" shaft / 3.20 mm bite width / 5.00 mm tip width

- 1273-133 straight shaft classic handle
- 1273-181 straight shaft ergonomic handle
- 1273-145 curved left shaft classic handle
- 1273-183 curved left shaft ergonomic handle
- 1273-144 curved right shaft classic handle
- 1273-182 curved right shaft ergonomic handle
- 1273-147 upswept shaft classic handle
- 1273-184 upswept shaft ergonomic handle



Gawsling Basket Punch / large / 5" straight shaft / 4.50 mm bite width / 6.15 mm tip width

- 1273-185 classic handle
- 1273-186 ergonomic handle



Gawsling Basket Punch / large / upbiter / 5" straight shaft / 4.50 mm bite width / 6.15 mm tip width

- 1273-187 classic handle
- 1273-188 ergonomic handle



Gawsling Punch Elevator / 5" straight shaft / 3.20 mm bite width / 5.00 mm tip width

- 1273-189 classic handle
- 1273-190 ergonomic handle



KNEE INSTRUMENTS

Punch

The small aggressive tip provides excellent maneuverability and multiple plane cutting capability in the tightest joint

Basket Punch / slim style / 5" shaft / 1.67 mm bite width / 2.89 mm tip width

| | | |
|----------|----------------|------------------|
| 1273-320 | straight shaft | classic handle |
| 1273-321 | straight shaft | ergonomic handle |
| 1273-322 | upswept shaft | classic handle |
| 1273-323 | upswept shaft | ergonomic handle |



Basket Punch / slim style / 5" shaft / 1.67 mm bite width / 2.89 mm tip width

| | | | |
|----------|----------------|------------------|------------------|
| 1273-326 | straight shaft | 45° angled left | classic handle |
| 1273-327 | straight shaft | 45° angled left | ergonomic handle |
| 1273-324 | straight shaft | 45° angled right | classic handle |
| 1273-325 | straight shaft | 45° angled right | ergonomic handle |



Hook Punch / slim style / upbiter / 5" shaft / 1.67 mm bite width / 2.89 mm tip width

| | | |
|----------|--------------------|------------------|
| 1273-330 | straight shaft | classic handle |
| 1273-331 | straight shaft | ergonomic handle |
| 1273-334 | curved left shaft | classic handle |
| 1273-335 | curved left shaft | ergonomic handle |
| 1273-332 | curved right shaft | classic handle |
| 1273-333 | curved right shaft | ergonomic handle |



Punch

The lowest profile tip with the largest bite offers the most versatile instrument available

Basket Punch / oval / 5" shaft / 4.39 mm bite width / 6.57 mm tip width

| | | |
|----------|--------------------|------------------|
| 1273-238 | straight shaft | classic handle |
| 1273-239 | straight shaft | ergonomic handle |
| 1273-242 | curved left shaft | classic handle |
| 1273-243 | curved left shaft | ergonomic handle |
| 1273-240 | curved right shaft | classic handle |
| 1273-241 | curved right shaft | ergonomic handle |
| 1273-244 | upswept shaft | classic handle |
| 1273-245 | upswept shaft | ergonomic handle |



Basket Punch / oval / upbiter / 5" shaft / 4.39 mm bite width / 6.57 mm tip width

| | | |
|----------|--------------------|------------------|
| 1273-248 | straight shaft | classic handle |
| 1273-247 | straight shaft | ergonomic handle |
| 1273-252 | curved left shaft | classic handle |
| 1273-251 | curved left shaft | ergonomic handle |
| 1273-250 | curved right shaft | classic handle |
| 1273-249 | curved right shaft | ergonomic handle |
| 1273-254 | upswept shaft | classic handle |
| 1273-253 | upswept shaft | ergonomic handle |



KNEE INSTRUMENTS

Punch

These instruments have a flexible purpose due to their different sizes

Basket Punch Scoop / 5" shaft / 1.59 mm bite width / 3.25 mm tip width

| | | |
|----------|---------------------------|------------------|
| 1273-256 | 1.0 mm straight shaft | classic handle |
| 1273-257 | 1.0 mm straight shaft | ergonomic handle |
| 1273-262 | 1.0 mm upswept shaft | classic handle |
| 1273-263 | 1.0 mm upswept shaft | ergonomic handle |
| 1273-260 | 1.3 mm curved left shaft | classic handle |
| 1273-261 | 1.3 mm curved left shaft | ergonomic handle |
| 1273-258 | 1.3 mm curved right shaft | classic handle |
| 1273-259 | 1.3 mm curved right shaft | ergonomic handle |



Basket Punch Scoop / 1.3 mm / upbiter / 5" shaft / 1.59 mm bite width / 3.27 mm tip width

| | | |
|----------|--------------------|------------------|
| 1273-266 | straight shaft | classic handle |
| 1273-265 | straight shaft | ergonomic handle |
| 1273-270 | curved left shaft | classic handle |
| 1273-269 | curved left shaft | ergonomic handle |
| 1273-268 | curved right shaft | classic handle |
| 1273-267 | curved right shaft | ergonomic handle |



Basket Punch Scoop / 5" shaft / 1.59 mm bite width

| | | | |
|----------|-------------------|-----------------------|------------------|
| 1273-278 | 3.27 mm tip width | 1.3 mm upswept shaft | classic handle |
| 1273-280 | 3.27 mm tip width | 1.3 mm upswept shaft | ergonomic handle |
| 1273-277 | 3.88 mm tip width | 1.5 mm straight shaft | classic handle |
| 1273-279 | 3.88 mm tip width | 1.5 mm straight shaft | ergonomic handle |



Basket Punch Scoop / downbiter / 5" straight shaft / 1.59 mm bite width / 3.27 mm tip width

| | | |
|----------|--------------|------------------|
| 1273-281 | 1.3 mm shaft | classic handle |
| 1273-282 | 1.3 mm shaft | ergonomic handle |



Basket Punch Scoop / upbiter / 5" shaft

| | | | | |
|----------|--------------------|-------------------|-----------------------|------------------|
| 1273-276 | 1.59 mm bite width | 3.88 mm tip width | 1.5 mm upswept shaft | classic handle |
| 1273-275 | 1.59 mm bite width | 3.88 mm tip width | 1.5 mm upswept shaft | ergonomic handle |
| 1273-272 | 1.77 mm bite width | 3.58 mm tip width | 2.7 mm straight shaft | classic handle |
| 1273-271 | 1.77 mm bite width | 3.58 mm tip width | 2.7 mm straight shaft | ergonomic handle |
| 1273-274 | 2.03 mm bite width | 3.76 mm tip width | 3.4 mm straight shaft | classic handle |
| 1273-273 | 2.03 mm bite width | 3.76 mm tip width | 3.4 mm straight shaft | ergonomic handle |



Basket Punch Scoop / upbiter / 5" straight shaft / 1.59 mm bite width / 3.88 mm tip width

| | |
|----------|------------------|
| 1273-283 | classic handle |
| 1273-284 | ergonomic handle |



Basket Punch / short cut / 5" straight shaft / 1.67 mm bite width / 3.32 mm tip width

| | |
|----------|------------------|
| 1273-200 | classic handle |
| 1273-201 | ergonomic handle |



KNEE INSTRUMENTS

Punch

The meniscal elevator with the extended lip of the lower jaw assists to slide easily under a tight meniscus

Basket Punch / meniscal elevator / 5" straight shaft / 1.60 mm bite width / 3.20 mm tip width / 1.3 mm shaft

- 1273-290 classic handle
- 1273-291 ergonomic handle



Basket Punch / meniscal elevator / upbiter / 5" straight shaft / 1.60 mm bite width / 3.20 mm tip width / 1.3 mm shaft

- 1273-292 classic handle
- 1273-293 ergonomic handle



Punch

The blunt tip enables this instrument to get into the posterior horn for flush trimming of the meniscus

Hook Punch / blunt nose 1.0 mm / 5" shaft / 1.67 mm bite width / 3.32 mm tip width

- 1273-362 straight shaft classic handle
- 1273-363 straight shaft ergonomic handle
- 1273-368 upswept shaft classic handle
- 1273-369 upswept shaft ergonomic handle
- 1273-366 curved left shaft classic handle
- 1273-367 curved left shaft ergonomic handle
- 1273-364 curved right shaft classic handle
- 1273-365 curved right shaft ergonomic handle



Punch

The short jaw and the gradually tapered shaft permit the tip to open wide for cutting in tight posterior compartments

Posterior Basket Punch / 5" shaft / 2.18 mm bite width / 4.00 mm tip width / straight tip

- 1273-300 straight shaft classic handle
- 1273-301 straight shaft ergonomic handle
- 1273-304 curved left shaft classic handle
- 1273-305 curved left shaft ergonomic handle
- 1273-302 curved right shaft classic handle
- 1273-303 curved right shaft ergonomic handle
- 1273-306 upswept shaft classic handle
- 1273-307 upswept shaft ergonomic handle



Posterior Basket Punch / upbiter / 5" shaft / 2.18 mm bite width / 4.00 mm tip width

- 1273-310 straight shaft classic handle
- 1273-311 straight shaft ergonomic handle
- 1273-314 curved left shaft classic handle
- 1273-315 curved left shaft ergonomic handle
- 1273-312 curved right shaft classic handle
- 1273-313 curved right shaft ergonomic handle



Punch

The backbiting capability of this punch offers the most direct access to the anterior meniscus

Basket Punch Unicorn / 5" straight shaft / 2.38 mm bite width / 5.58 mm tip width

- 1273-296 left cut classic handle
- 1273-297 left cut ergonomic handle
- 1273-294 right cut classic handle
- 1273-295 right cut ergonomic handle



KNEE INSTRUMENTS

Punch

This punch offers an effective angle for the anterior meniscus. The tip allows successive bites, ideal for balancing the meniscal rim.

Rotary Basket Punch / 5" straight shaft / 90° jaw / rotatable handle /

- 1273-287 2.20 mm bite width 4.10 mm tip width 2.2mm shaft angled left
- 1273-286 2.20 mm bite width 4.10 mm tip width 2.2mm shaft angled right
- 1273-289 3.40 mm bite width 5.30 mm tip width 3.4mm shaft angled left
- 1273-288 3.40 mm bite width 5.30 mm tip width 3.4mm shaft angled right



Rongeur

Enables cutting and removal of tissue particularly useful in ACL surgery

Rongeur Raptor / 5" straight shaft

- 1273-376 classic handle
- 1273-377 ergonomic handle



Punch

The small bite size allows for increased visibility and consistently provides a clean shear cut

Scissors Punch / 5" shaft / 1.20 mm bite width / 2.80 mm tip width / straight tip

- 1273-340 straight shaft classic handle
- 1273-341 straight shaft ergonomic handle
- 1273-344 curved left shaft classic handle
- 1273-345 curved left shaft ergonomic handle
- 1273-342 curved right shaft classic handle
- 1273-343 curved right shaft ergonomic handle



Scissors Punch / upbiter / 5" shaft / 1.20 mm bite width / 2.80 mm tip width

- 1273-129 straight shaft classic handle
- 1273-347 straight shaft ergonomic handle
- 1273-132 curved left shaft classic handle
- 1273-351 curved left shaft ergonomic handle
- 1273-130 curved right shaft classic handle
- 1273-349 curved right shaft ergonomic handle



Scissors

Teeth on the top hook of the instrument prevent tissue from slipping off and allows a clean cut

Hook Scissors / 5" shaft

- 1273-354 straight shaf classic handle
- 1273-355 straight shaft ergonomic handle
- 1273-358 curved left shaft classic handle
- 1273-359 curved left shaft ergonomic handle
- 1273-356 curved right shaft classic handle
- 1273-357 curved right shaft ergonomic handle



KNEE INSTRUMENTS

Scissors

Ideal for manipulation of all aspects of the meniscus because of its unique sideways cutting action and ability to fit into tight areas

Rotary Hook Scissors / 5" straight shaft / 20° / rotatable handle

- 1273-361 angled left
- 1273-360 angled right



Rotary Scissors serrated / 5" straight shaft / 20° / rotatable handle

- 1273-353 angled left
- 1273-352 angled right



Rotary Hook Scissors / 5" straight shaft / 60° / rotatable handle

- 1273-131 angled left
- 1273-137 angled right



Forceps

Ideal for manipulation of all aspects of the meniscus because of its unique sideways cutting action and ability to fit into tight areas

Grasping Forceps / 1x2 teeth / 5" straight shaft / slide-lock handle

- 1273-115



Grasping Forceps / cupped / serrated / 5" straight shaft / slide-lock handle

- 1273-380 2.7 mm
- 1273-381 3.4 mm



Grasping Forceps Alligator / upbiter / 5" shaft / 2.7 mm / slide-lock handle

- 1273-382 straight shaft
- 1273-383 upswept shaft



Grasping Forceps Crocodile / 5" shaft / 2.7 mm / slide-lock handle

- 1273-112 straight shaft
- 1273-110 upswept shaft



Grasping Forceps Alligator / 5" shaft / 3.4 mm / slide-lock handle

- 1273-384 straight shaft
- 1273-385 upswept shaft



Tissue Grasping Forceps / 5" straight shaft / slide-lock handle

- 1273-386 without channel
- 1273-387 with 2 mm channel



KNEE INSTRUMENTS



SMALL JOINT INSTRUMENTS

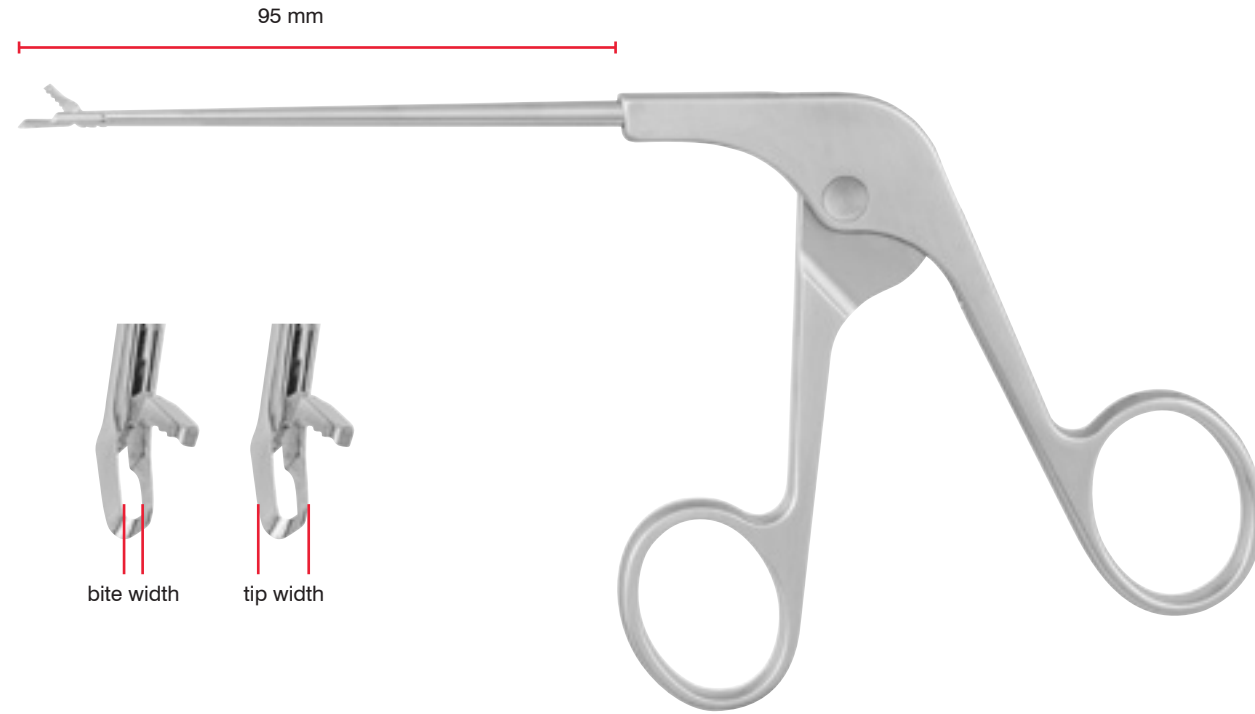

Straight: The primary style for direct approach

Upbiter: Angled up at the tip

Upswept: Angled up on the shaft

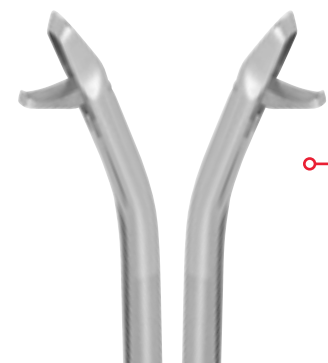

Curved left and curved right: Curved on the shaft left or right

SMALL JOINT INSTRUMENTS

Classic Handle

Scissors, basket punches and graspers are equipped with our traditional classic handle



Slide Lock Handle

All graspers are equipped with this infinite position locking handle design



SMALL JOINT INSTRUMENTS

Designed especially for small joints, these instruments have shorter stems and smaller jaws to provide ideal access for the elbow, wrist and ankle

Punch

Punch / oval Jr. / 3 3/4" shaft / 2.30 mm bite width / 3.50 tip width / classic handle

- 1273-151 straight shaft
- 1273-153 left Cvd Shaft
- 1273-152 right Cvd Shaft



Basket Punch / Jr. / 3 3/4" straight shaft / 2.30 mm bite width / 3.50 tip width / classic handle

- 1273-150
- 1273-150L left curved shaft



Basket Punch / Jr. / upbiter / 3 3/4" straight shaft / 2.30 mm bite width / 3.50 tip width / classic handle

- 1273-154



Basket Punch / blunt Jr. / 3 3/4" straight shaft / 1.70 mm bite width / 3.00 tip width / classic handle

- 1273-155



Scissors

Hook Scissors / 3 3/4" straight shaft / classic handle

- 1273-156



Rongeur

Rongeur Raptor / Jr. / 3 3/4" straight shaft / classic handle

- 1273-161



Forceps

Grasping Forceps Alligator / Jr. / 3 3/4" straight shaft / slide-lock handle

- 1273-122



Grasping Forceps Alligator / Jr. / 1x2 teeth / 3 3/4" shaft / slide-lock handle

- 1273-123



SHOULDER INSTRUMENTS

155 mm

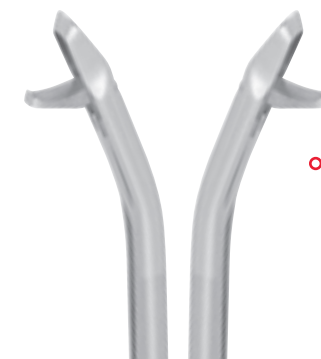
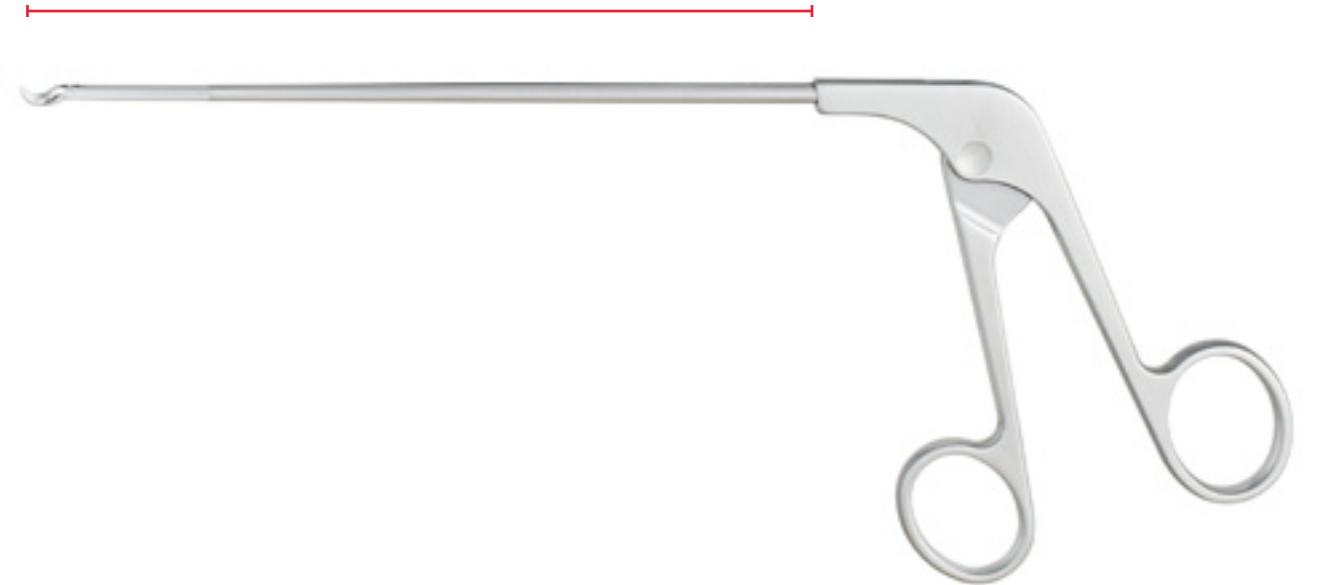

Straight: The primary style for direct approach

Upbiter: Angled up at the tip

Upswept: Angled up on the shaft

Curved left and curved right: Curved on the shaft left or right

SHOULDER INSTRUMENTS

Classic Handle

Scissors, basket punches and graspers are equipped with our traditional classic handle



Slide Lock Handle

All graspers are equipped with this infinite position locking handle design



Positioning Handle



SHOULDER INSTRUMENTS

Hook

Clever Suture Hook / 6" straight shaft

- 1273-408 green handle pointed tip left
- 1273-407 red handle pointed tip right



Sixter Suture Hook / 6" straight shaft

- 1273-410 green handle tip turned left
- 1273-409 red handle tip turned right



SHOULDER INSTRUMENTS

These instruments were designed specifically for the shoulder area. The low-profile and highly sharpened tip allows easy passage through tissue in order to retrieve or apply a suture. Also the instruments for grasping the engagement is facilitated by the shape of the jaw.

Forceps

Bird Beak Suture Hook Forceps / 6" straight shaft / classic handle

1273-401



Bird Beak Suture Hook Forceps / 6" straight shaft / classic handle

1273-403 45° angled left jaw
1273-402 45° angled right jaw



Bird Beak Suture Hook Forceps / upbiter / 6" straight shaft / classic handle

1273-404 20° up jaw
1273-405 40° up jaw



Grasper

Suture Retriever Grasper / serrated / 6" straight shaft / slide-lock handle

1273-415



Suture Retriever Grasper / serrated / 6" straight shaft / slide-lock handle

1273-418 45° angled left jaw
1273-417 45° angled right jaw



Suture Retriever Grasper / serrated / 15° angled up jaw / 6" straight shaft / slide-lock handle

1273-416



King Suture Retriever Grasper / cross-serrated / 6" straight shaft / slide-lock handle

1273-420



Forceps

Tissue Grasping Forceps / 6" straight shaft / slide-lock handle

1273-422



SHOULDER INSTRUMENTS

Punch

Suture Punch / 6" straight shaft / classic handle

1273-424



Hook

Double Hook Suture Hook / 6" straight shaft / classic handle

1273-426



Hook

Sliding Suture Hook / 6" straight shaft / positioning handle

1273-428



HIP INSTRUMENTS

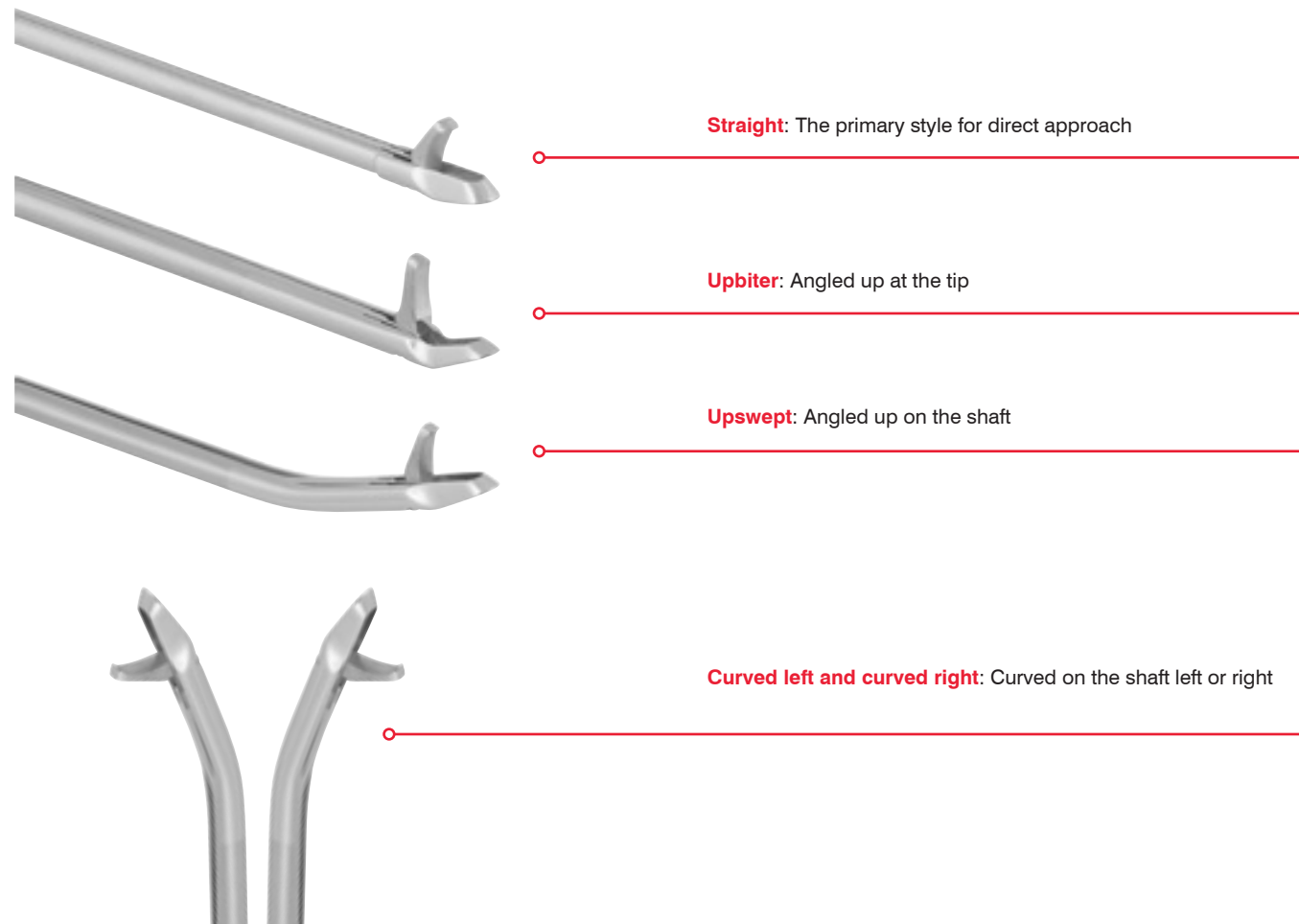
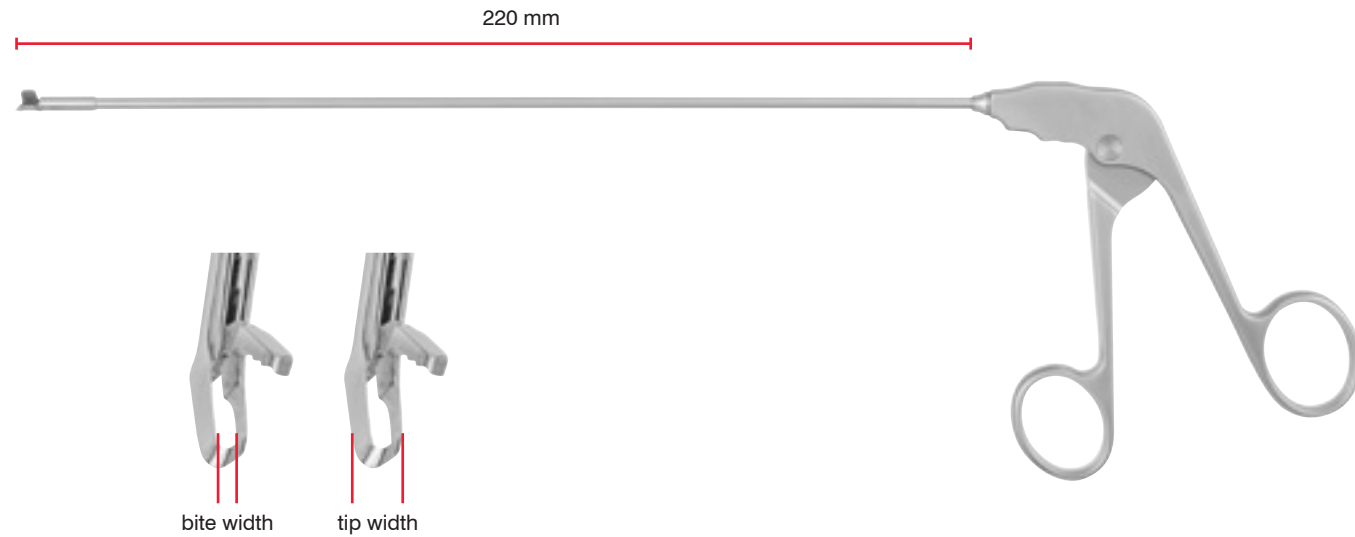

HIP INSTRUMENTS

Classic Handle

Scissors, basket punches and graspers are equipped with our traditional classic handle



Slide Lock Handle

All graspers are equipped with this infinite position locking handle design



Rotatable Handle

Available on rotary basket punches and scissors



HIP INSTRUMENTS

These instruments were specifically designed with the additional challenges of hip arthroscopy in mind. Their extra length and low profile offer excellent access to the hip joint.

Punch

Hook Punch small / 8 1/4" straight shaft / 1.67 mm bite width / 2.89 tip width / classic handle
1273-440



Hook Punch small / upbiter / 8 1/4" straight shaft / 1.67 mm bite width / 2.89 tip width / classic handle
1273-441



Basket Punch small / 8 1/4" straight shaft / 1.67 mm bite width / 2.89 tip width / classic handle
1273-435 45° down left
1273-434 45° down right



Gawsling Punch medium / 8 1/4" straight shaft / 3.20 mm bite width / 5.00 tip width / classic handle
1273-431
1273-433 upswept shaft



Gawsling Punch medium / upbiter / 8 1/4" straight shaft / 3.20 mm bite width / 5.00 tip width / classic handle
1273-432



Basket Punch unicorn / 8 1/4" straight shaft / 2.38 mm bite width / 5.58 tip width / classic handle
1273-437 left cut
1273-436 right cut



Rongeur

Rongeur Raptor / 8 1/4" straight shaft / classic handle
1273-447



Punch

Rotary Basket Punch / 2.2 mm 8 1/4" straight shaft / 2.20 mm bite width / 4.10 tip width / rotatable handle
1273-439 90° angled left jaw
1273-438 90° angled right jaw



HIP INSTRUMENTS

Forceps

Grasping Forceps / 1x2 teeth / 8 1/4" straight shaft / slide-lock handle
1273-442



Grasping Forceps / cupped / serrated / 8 1/4" straight shaft / slide-lock handle
1273-443 2.7 mm shaft
1273-444 3.4 mm shaft



Grasping Forceps Alligator / 8 1/4" straight shaft / slide-lock handle
1273-445



Arthroscopic Crocodile Grasping Forceps

Straight / 2.7 mm jaw / 5" (13 cm) shaft

- 1273-112 with locking mechanism
- 1273-113 without locking mechanism



Arthroscopic Rottweiler Loosebody Grasping Forceps

With locking mechanism / 1 x 2 teeth / 2.7 mm / 6 1/2" (16.5 cm)

- 1273-114 with locking mechanism
- 1273-1141 without locking mechanism



Rottweiler Junior Loosebody Grasping Forceps

With locking mechanism / straight / 1 x 2 teeth / 2.7 mm / 5" (12.7 cm)
1273-115



Arthroscopic Velociraptor Biopsy Forceps

Straight / 3.4 mm jaw / 5" (13 cm) shaft
1273-162



Arthroscopic Velociraptor Junior Biopsy Forceps

Straight / 2.7 mm jaw / 3 1/2" (9 cm) shaft
1273-171

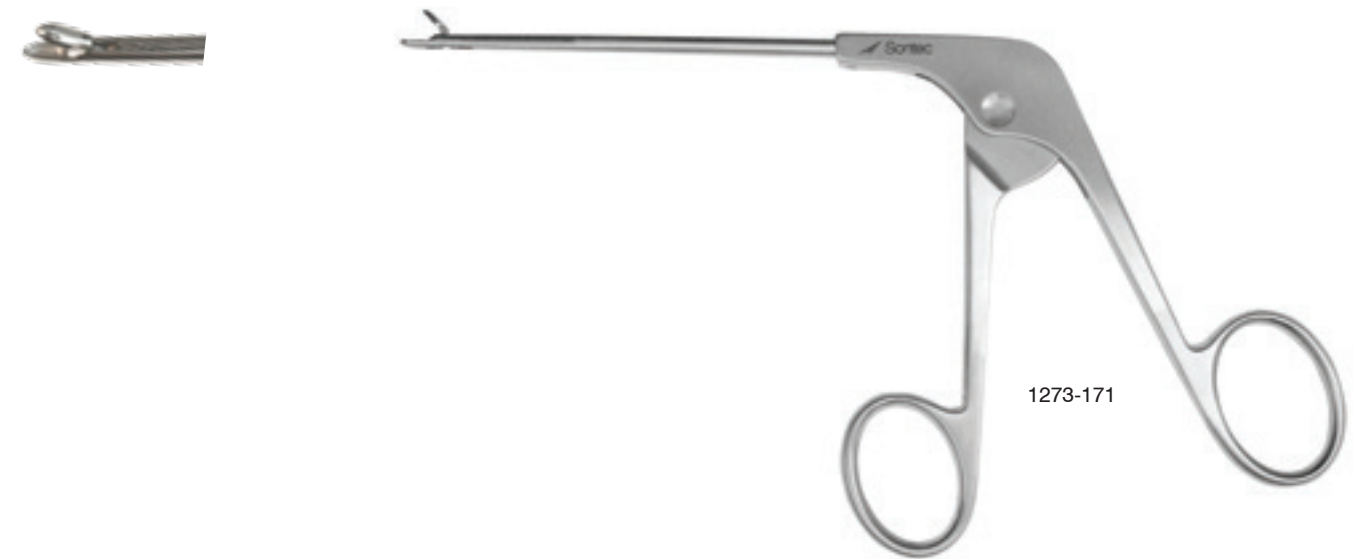

Arthroscopic Gawling Basket Punch

Up-bite / 3.2 mm jaw / 6 1/2" (16.5 cm) shaft
1273-146



Arthroscopic Saber Scissor Punch

Straight / 2.7 mm / 6 1/2" (16.5 cm) shaft
1273-135





 Sontec Instruments®

Bone & NAIL CUTTING Forceps

Liston Bone Cutting Forceps

5 1/2" (14 cm)

- 315-765 straight
- 315-775 angled

6 1/2" (16.5 cm)

- 315-766 straight
- 315-776 angled

7 1/2" (19 cm)

- 315-767 straight
- 315-777 angled
- 315-779 angled to side

8 1/2" (21.5 cm)

- 315-768 straight
- 315-778 angled



315-776

Ruskin-Liston Bone Cutting Forceps

Double-action

- 1103-092 straight 5 3/4" (14.5 cm)
- 1103-093 angled 5 3/4" (14.5 cm)
- 1103-094 straight 7 1/4" (18.5 cm)
- 1103-095 angled 7 1/4" (18.5 cm)

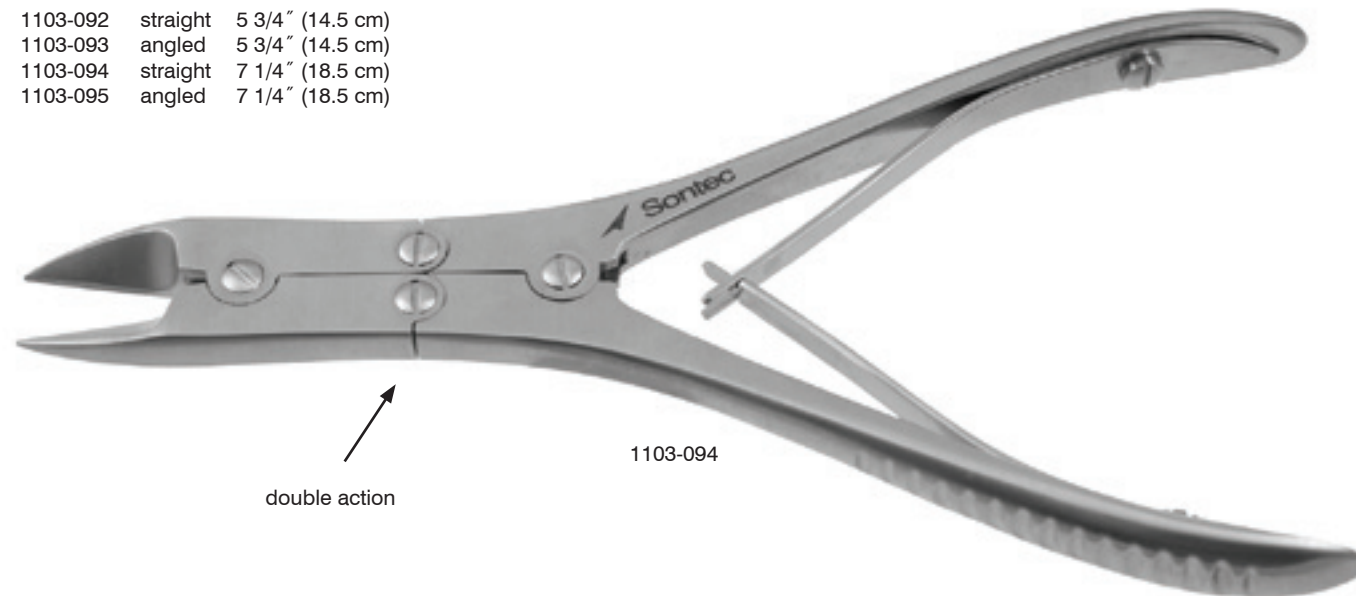

1103-094

Councilman Bone Cutter

15" (38 cm)

- 315-762



315-762

Stille-Liston Bone Cutting Forceps

Double-action / 9" (23 cm)

- 315-752 angled up

Double-action / 10 1/2" (26 cm)

- 315-754 straight
- 315-756 angled



315-754

McIndoe Bone Cutting Forceps

Double-action / angled / 7 1/4" (18.5 cm)
315-781

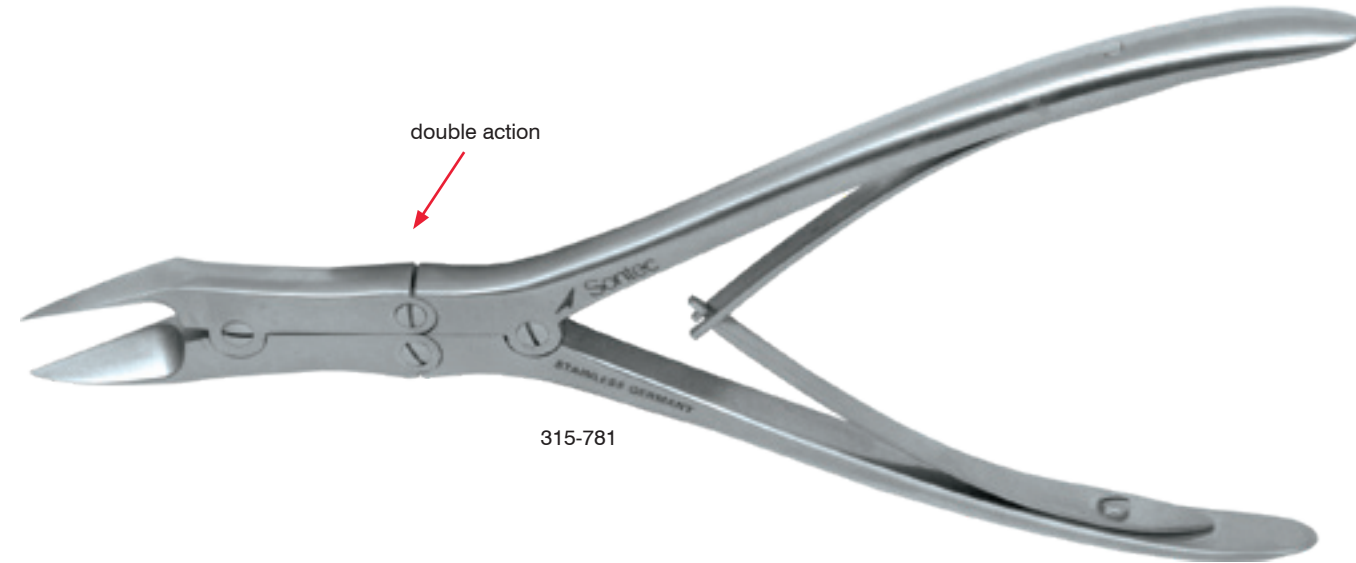

315-781

Tissue Nipper

- 199-220 6 mm 4" (10 cm)
- 199-221 9 mm 4" (10 cm)
- 199-222 11 mm 4 1/2" (11.5 cm)
- 199-223 14 mm 5" (13 cm)



199-220

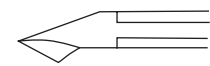

199-220



199-221



199-222



199-223

Tissue and Cuticle Nipper

Convex jaw / 4" (10 cm)
199-240

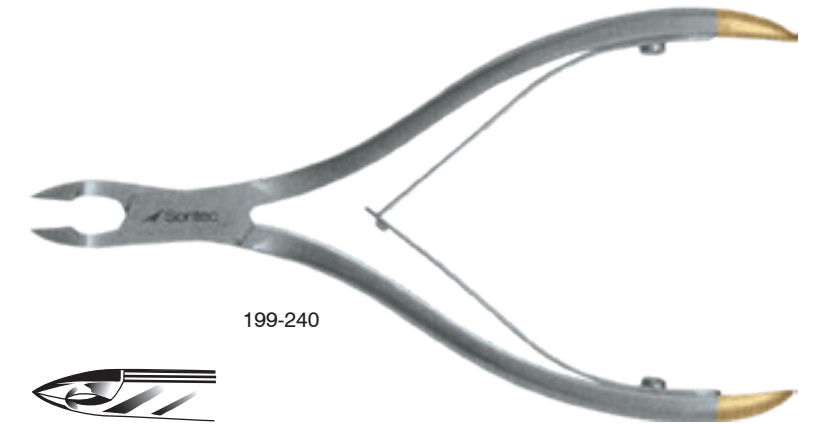

199-240



Nail Splitter Forcep

- Straight / tapered**
- 199-276 4" (10 cm)
 - 199-277 4 1/2" (11.5 cm)
 - 199-278 5" (13 cm)
 - 199-279 6" (15 cm)
 - 199-280 4 1/2" (11.5 cm) delicate



199-276

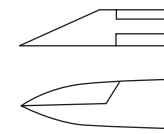

199-276

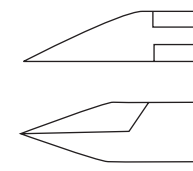

199-277

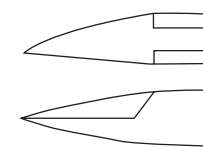

199-280

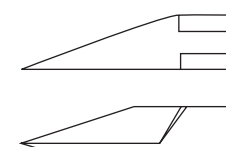

199-278

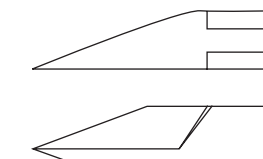

199-279

Stille-Horsley Bone Cutter

S-shaped / up-angle jaw / 10 1/2" (26.7 cm)
315-760



315-760

Short Jaw Nail Splitter

199-283 5" (13 cm)
199-284 6" (15 cm)

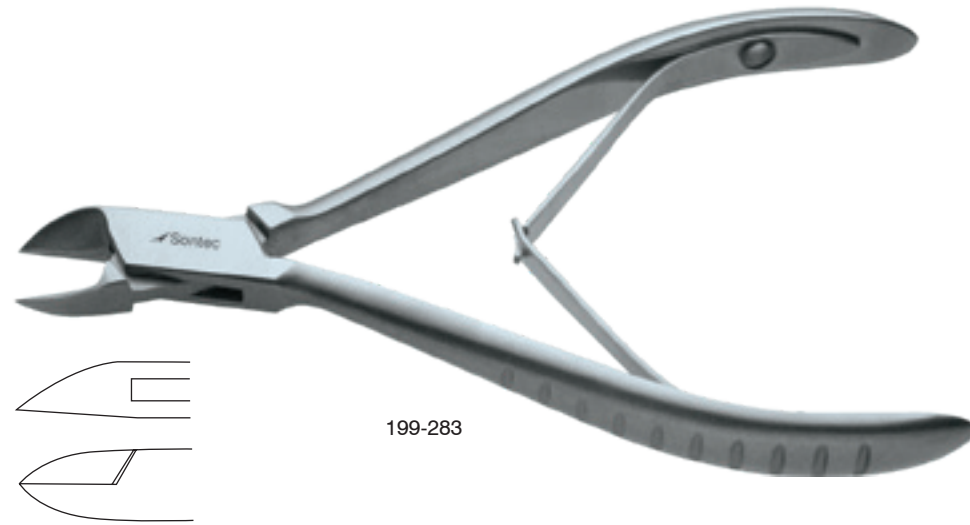

199-283

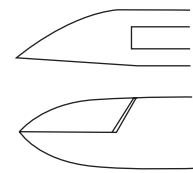

Nail Nipper

Concave / narrow / 5" (13 cm)
199-218

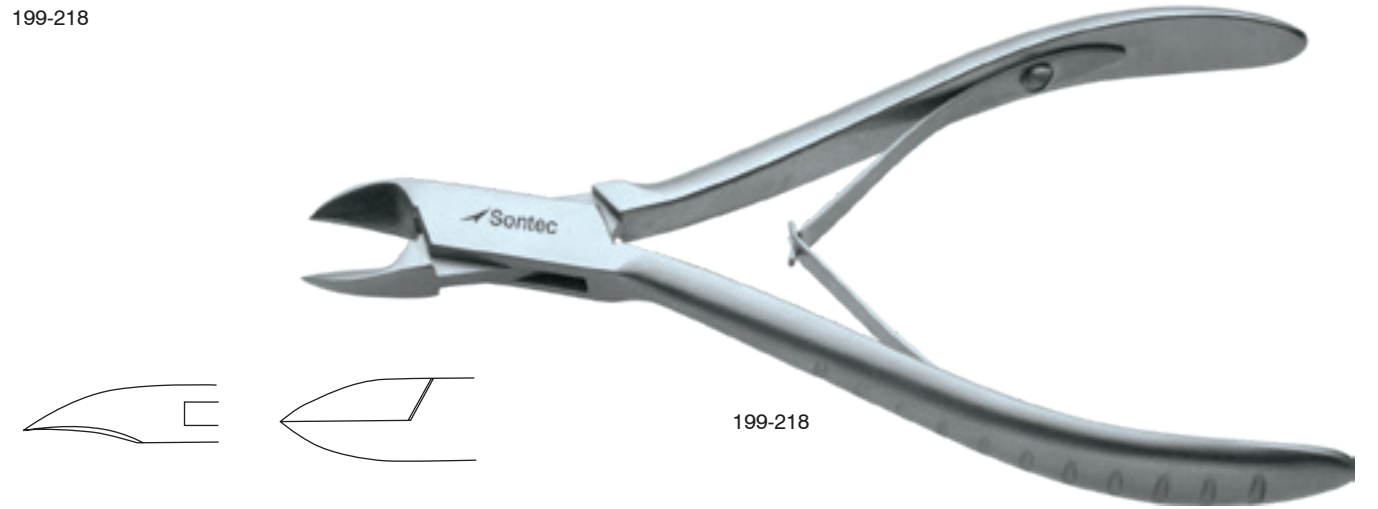

199-218



Nail Splitter

199-271 4" (10 cm)
199-272 4 1/2" (11.5 cm)
199-273 5" (13 cm)
199-275 5" (13 cm) narrow
199-274 6" (15 cm)

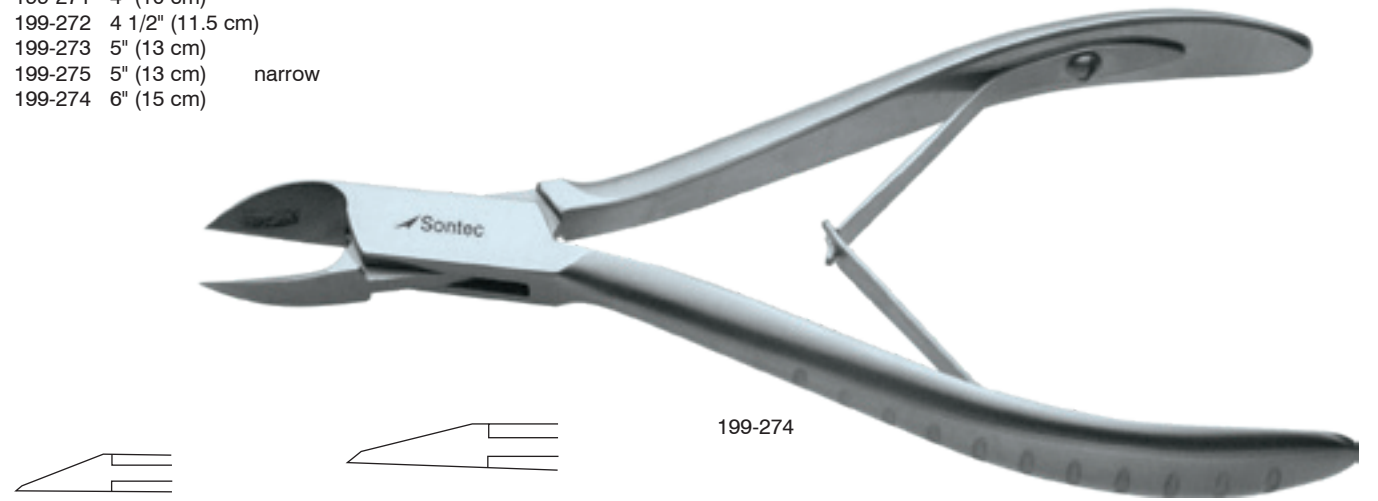

199-274

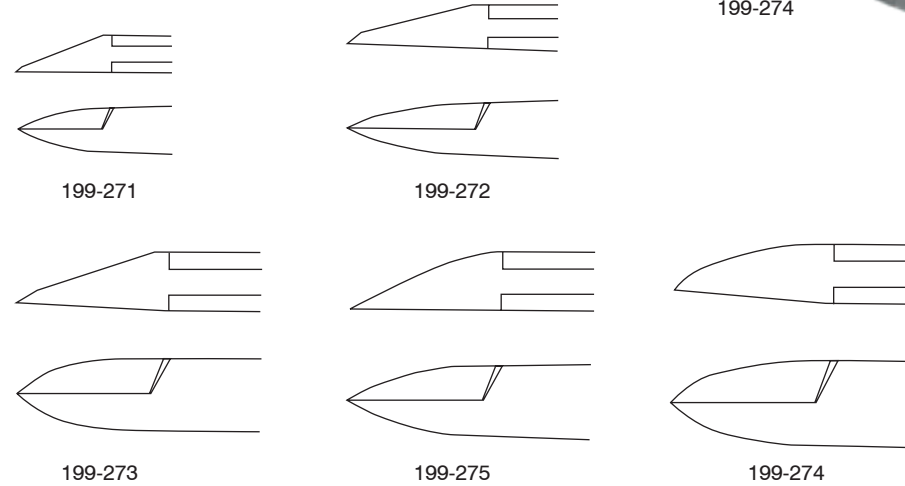

Pigtooth Nipper

5 1/2" (14 cm)
1100-765

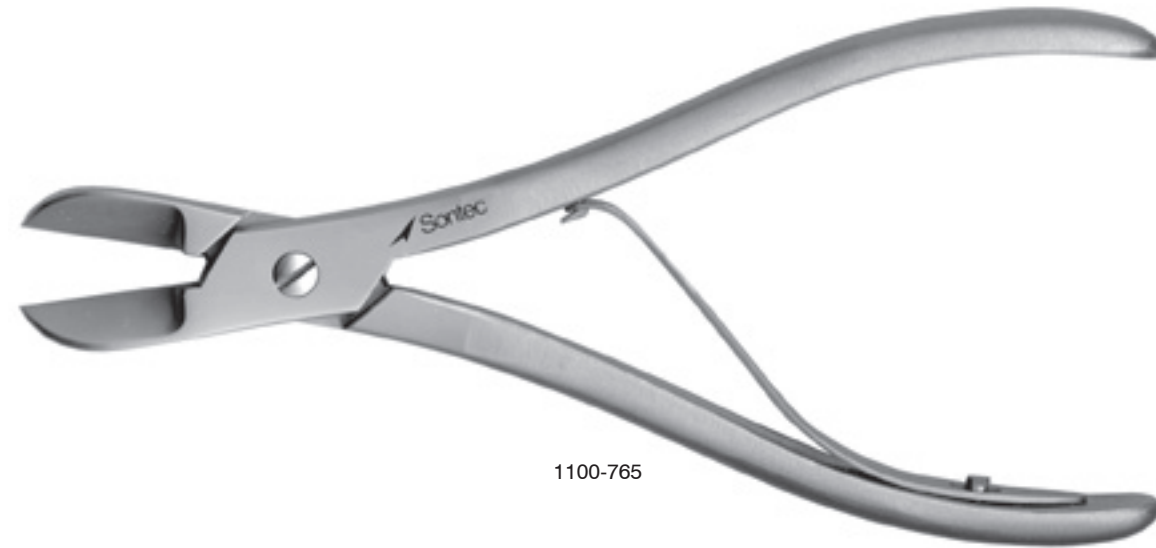

1100-765

Heavy Nail Nipper

199-212 5 1/2" (14 cm) concave
199-216 5 1/2" (14 cm) straight
199-214 6 1/2" (16.5 cm) concave



199-214

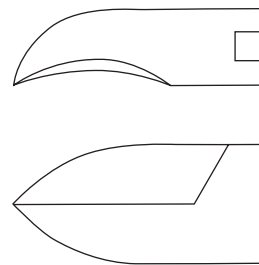

199-212
199-214

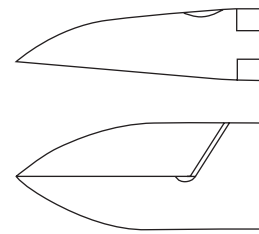

199-216

Ingrown Nail Forcep

Straight / anvil pattern / narrow
blade / 5" (13 cm)
199-282

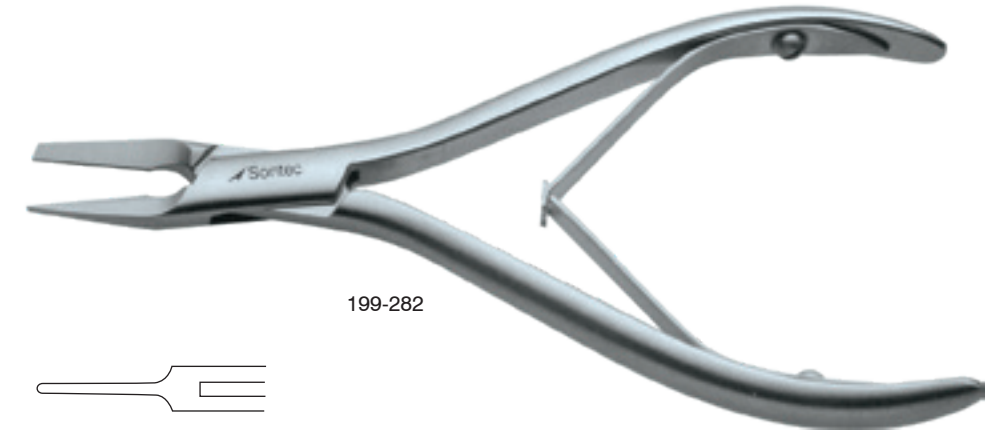

199-282

Bone Cutter / Nail Nipper

Double-action / 6" (15 cm)
1103-090



1103-090

Concave Nail Nipper

Barrel spring / chrome / 4 1/2" (11.4 cm)
199-207

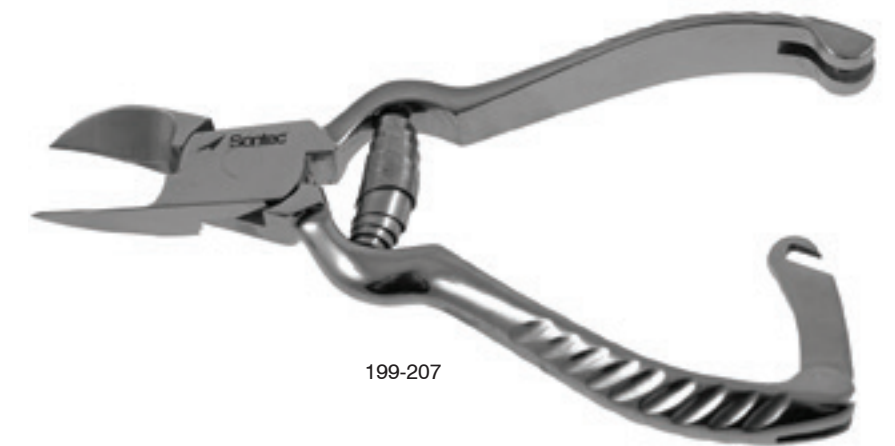

199-207

Ingrown Nail Splitting Scissors

Straight / 1 blade serrated / 6 3/4" (17.1 cm)
1103-613



Nail Nipper

5 1/2" (14 cm)
199-211 str
199-213 cvd

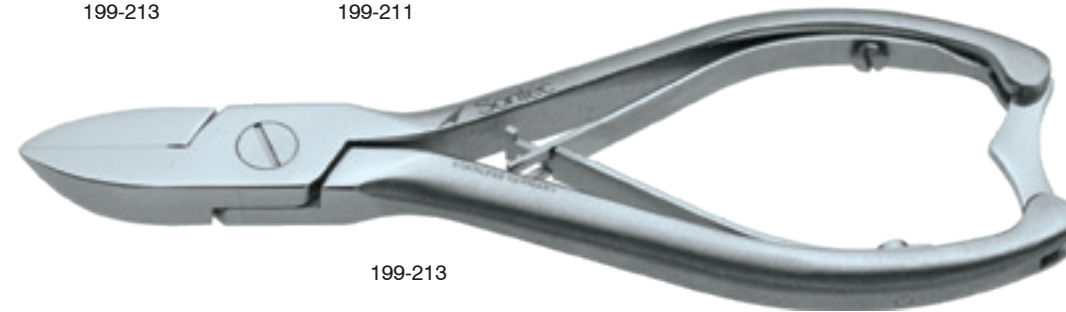
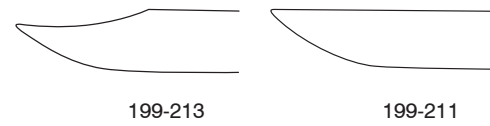

White Toe Nail Scissor

4 1/2" (11.5 cm)
1100-766



Feline Nail Cutter

Smaller / 3" (7.5 cm)
1100-759



Avian Nail Trimmer

Blue ring handle / 3 3/4" (9.5 cm)
1103-615





 Sontec Instruments®

Kerrison RONGEURS

Universal Klick Kerrison Rongeur Set with Tray

- 404-608-SET Set
 Classic Standard Set includes:
 404-6081 1 mm 40° 8" shaft
 404-6082 2 mm 40° 8" shaft
 404-6083 3 mm 40° 8" shaft
 404-6084 4 mm 40° 8" shaft
 404-6085 5 mm 40° 8" shaft
 404-6086 2 universal handles

18-3564 tray only

To configure you own personalized set, refer to "Kerrison Section" > "Kerrison Universal Rotating 360° Rongeur" for all possible options

*different size shafts available up request



Kerrison Universal Rotating 360° Rongeur

Special

404-606B handle *special order

Bayonet shaft / black ceramic / 12 1/2" (31.8 cm)

- 404-6061B 1 mm bite 40°
 404-6062B 2 mm bite 40°
 404-6063B 3 mm bite 40°

Endoscopic / black ceramic / 16" (40.6 cm)

404-6063EB 3 mm bite 40°

Quick trigger release / shaft locks in 8 positions through a 360° rotation / 8" (20cm) shaft

- 404-6082B 2 mm bite 40° up curved with tissue ejector
 404-6082C 2 mm bite 40° down curved with tissue ejector
 404-60825E 2.5 mm bit 40°
 404-6083B 3 mm bite 40° up curved with tissue ejector
 404-6083E 3 mm bite 40° endoscopic



404-6083B



404-6083E



404-60825E



with tissue ejector

404-6082B



404-6082C



404-6062B



404-6063B



404-6063EB

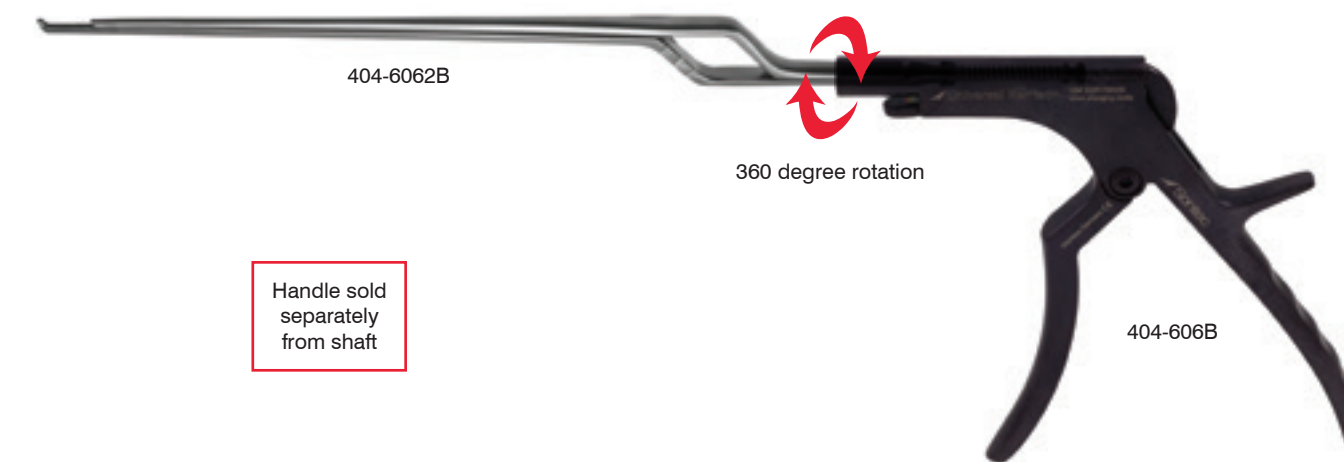

404-6062B

360 degree rotation

Handle sold separately from shaft

404-606B

Kerrison Universal Rotating 360° Rongeur

Quick trigger release / with tissue ejector / shaft locks in 8 positions through a 360° rotation / 8" (20cm) shaft / 40°

- 404-606 handle
- 404-605 full set includes: handle all 40° sizes 8", all 90° sizes 8"
- 404-6081 1 mm bite
- 404-6082 2 mm bite
- 404-6083 3 mm bite
- 404-6084 4 mm bite
- 404-6085 5 mm bite

With tissue ejector / 10" (25.5cm) shaft

- 404-606 handle
- 404-607 full set includes: handle all 40° sizes 10", all 90° sizes 10"
- 404-6086 1 mm bite
- 404-6087 2 mm bite
- 404-6088 3 mm bite
- 404-6089 4 mm bite
- 404-6090 5 mm bite

7" (17.5cm) shaft

- 404-6091 0.8 mm bite
- 404-6093 1.5 mm bite

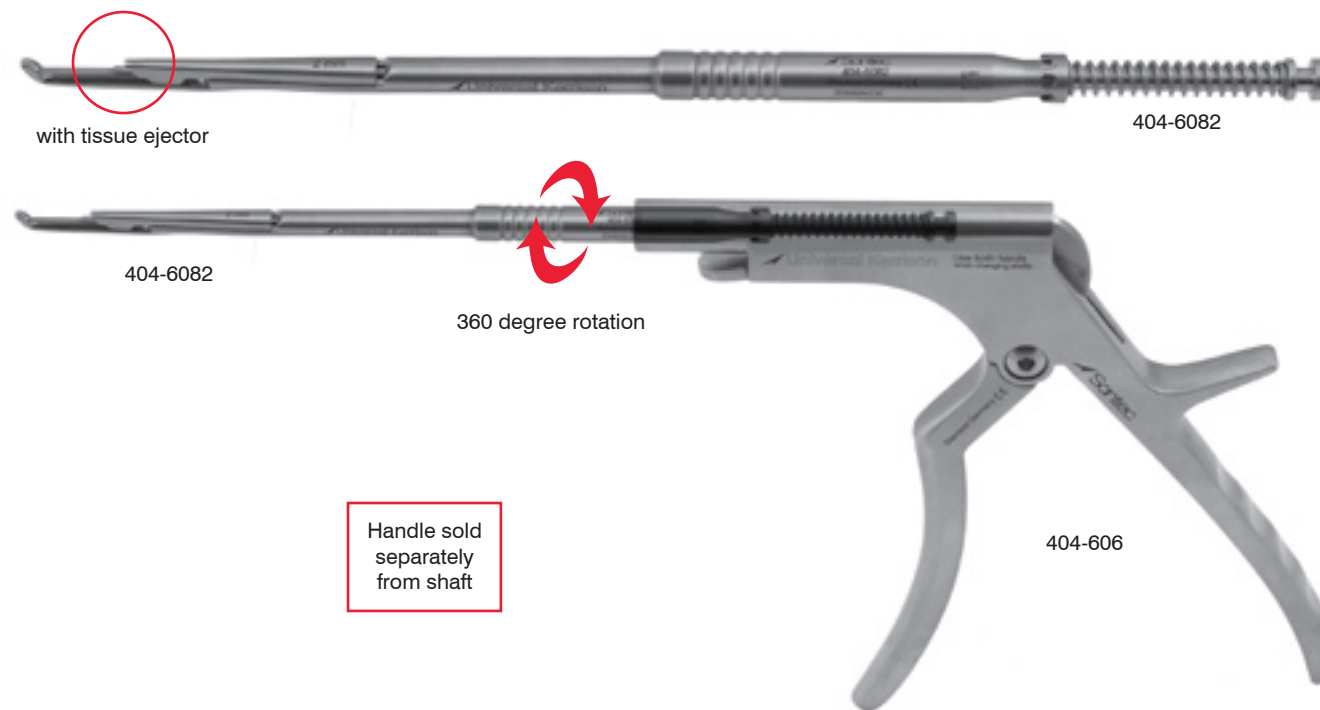

Kerrison Universal Rotating 360° Rongeur

Quick trigger release / with tissue ejector / shaft locks in 8 positions through a 360° rotation / 8" (20cm) shaft / 90°

- 404-606 handle
- 404-605 full set includes: handle all 40° sizes 8", all 90° sizes 8"
- 404-6071 1 mm bite 90°
- 404-6072 2 mm bite 90°
- 404-6073 3 mm bite 90°
- 404-6074 4 mm bite 90°
- 404-6075 5 mm bite 90°

With tissue ejector / 10" (25.5cm) shaft

- 404-606 handle
- 404-607 full set includes: handle all 40° sizes 10", all 90° sizes 10"
- 404-6076 1 mm bite 90°
- 404-6077 2 mm bite 90°
- 404-6078 3 mm bite 90°
- 404-6079 4 mm bite 90°
- 404-6080 5 mm bite 90°

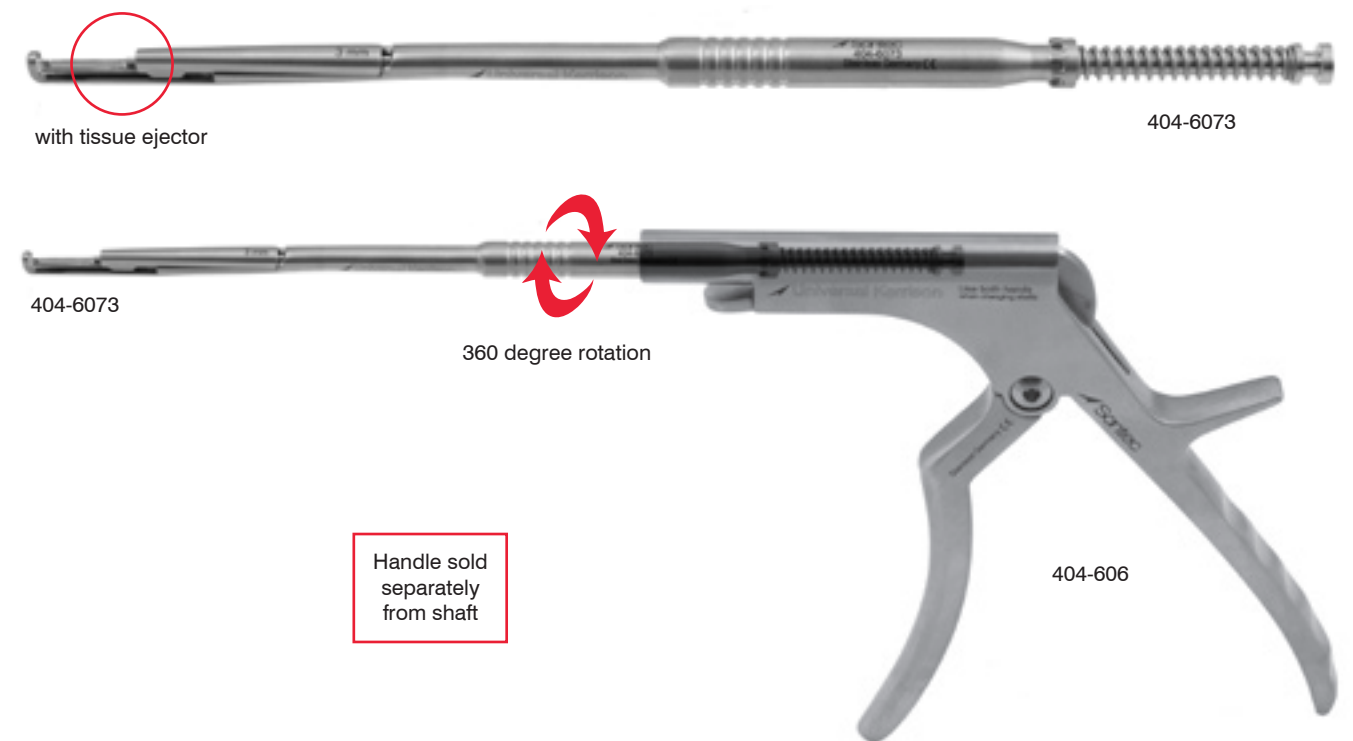

Kerrison Universal Rotating 360° Rongeur Handle

- 404-606 stainless steel
- 404-606B black ceramic
- 404-606SB black ceramic silicone handle



404-606



404-606SB



404-606B

Sontec Beatty Foraminotomy Rongeur

7 3/4" (19.5 cm) shaft / curved up

- 404-461 2 mm bite
- 404-462 3 mm bite
- 404-463 4 mm bite

7 3/4" (19.5 cm) shaft / curved down

- 404-450 2 mm bite
- 404-451 3 mm bite
- 404-452 4 mm bite

* Also available with rounded footplate



slightly curved up



curved up

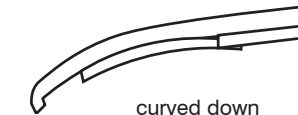

curved down



404-462

Beatty Foraminotomy Rongeur

Black ceramic coating / 8" (20.3 cm) shaft / slightly curved up

- 404-461B 2 mm bite
- 404-462B 3 mm bite
- 404-463B 4 mm bite

* Also available with rounded footplate

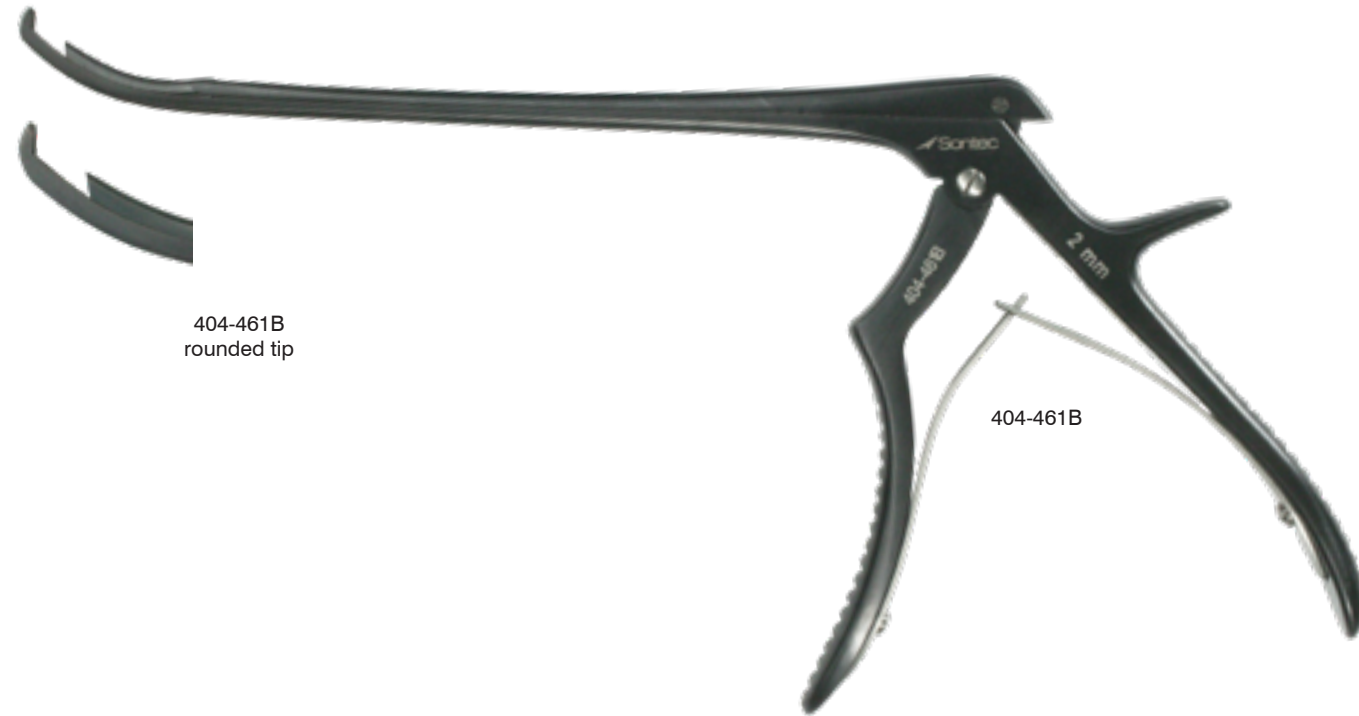

404-461B rounded tip

404-461B



404-462B rounded tip

404-462B

Kerrison 40° Rongeur

Black ceramic coated / thin footplate punch / 10 mm opening

| | Bite Width | Length of Shaft | | |
|--------------|------------|-----------------|-----------------------------|------------|
| | | 6" / 15 cm | 7" / 18 cm | 8" / 21 cm |
| 40° Up-Angle | 1 mm | 404-490B | 404-539B | 404-400B |
| | 1.5 mm | | NEW SIZE 404-5391 | |
| | 2 mm | 404-491B | 404-540B | 404-402B |
| | 2.5 mm | | NEW SIZE 404-5401 | |
| | 3 mm | 404-492B | 404-541B | 404-404B |
| | 4 mm | 404-493B | 404-542B | 404-406B |
| | 5 mm | 404-494B | 404-543B | 404-408B |
| | 6 mm | 404-495B | 404-544B | 404-410B |



404-492B

Kerrison 90° Rongeur

Black ceramic coated / 10 mm opening

| | Bite Width | Length of Shaft | | |
|---------|------------|-----------------|------------|------------|
| | | 6" / 15 cm | 7" / 18 cm | 8" / 21 cm |
| Up-Bite | 1 mm | 404-470B | 404-519B | 404-412B |
| | 2 mm | 404-471B | 404-520B | 404-414B |
| | 3 mm | 404-472B | 404-521B | 404-416B |
| | 4 mm | 404-473B | 404-522B | 404-418B |
| | 5 mm | 404-474B | 404-523B | 404-420B |
| | 6 mm | 404-475B | 404-524B | 404-422B |



404-520B

Kerrison 90° Rongeur

Thin footplate-punch / ceramic coating

| | Bite Width | Length of Shaft | | |
|---------------|------------|-----------------|------------|------------|
| | | 6" / 15 cm | 7" / 18 cm | 8" / 21 cm |
| 90° Down-Bite | 1 mm | 404-480B | 404-530B | 404-424B |
| | 2 mm | 404-481B | 404-525B | 404-426B |
| | 3 mm | 404-482B | 404-526B | 404-428B |
| | 4 mm | 404-483B | 404-527B | 404-430B |
| | 5 mm | 404-484B | 404-528B | 404-432B |
| | 6 mm | 404-485B | 404-529B | 404-434B |



404-526B

Kerrison 40° Laminectomy/Lumbar Rongeur

Black ceramic coating / 8" (20 cm) shaft / wide mouth 15 mm jaw opening / with & without ejection pin

| | Bite Width | w/Ejector Pin | wo/Ejector Pin | wo/Ejector Pin Stainless Steel |
|--------------|------------|---------------|----------------|-----------------------------------|
| 40° Up-Angle | 1 mm | | 404-337B | 404-332 |
| | 2 mm | 404-332B | 404-338B | 404-333 |
| | 3 mm | 404-333B | 404-339B | 404-334 |
| | 4 mm | 404-334B | 404-340B | 404-335 |
| | 5 mm | 404-335B | 404-341B | |



Kerrison 40° Rongeur

Thin footplate-punch / 10 mm opening

| | Bite Width | Length of Shaft | | |
|--------------|------------|-----------------|------------|------------|
| | | 6" / 15 cm | 7" / 18 cm | 8" / 21 cm |
| 40° Up-Angle | 1 mm | 404-490 | 404-539 | 404-400 |
| | 2 mm | 404-491 | 404-540 | 404-402 |
| | 3 mm | 404-492 | 404-541 | 404-404 |
| | 4 mm | 404-493 | 404-542 | 404-406 |
| | 5 mm | 404-494 | 404-543 | 404-408 |
| | 6 mm | 404-495 | 404-544 | 404-410 |



Kerrison 90° Rongeur

Thin footplate punch / 10 mm opening / up

| | Bite Width | Length of Shaft | | |
|---------|------------|-----------------|------------|------------|
| | | 6" / 15 cm | 7" / 18 cm | 8" / 21 cm |
| Up-Bite | 1 mm | 404-470 | 404-519 | 404-412 |
| | 2 mm | 404-471 | 404-520 | 404-414 |
| | 3 mm | 404-472 | 404-521 | 404-416 |
| | 4 mm | 404-473 | 404-522 | 404-418 |
| | 5 mm | 404-474 | 404-523 | 404-420 |
| | 6 mm | 404-475 | 404-524 | 404-422 |



404-520

Sontec Kerrison Rongeur 90° Down Bite Rongeur

Thin footplate / 10mm opening down

| | Bite Width | Length of Shaft | | |
|---------------|------------|-----------------|------------|------------|
| | | 6" / 15 cm | 7" / 18 cm | 8" / 21 cm |
| 90° Down Bite | 1 mm | 404-480 | 404-530 | 404-424 |
| | 2 mm | 404-481 | 404-525 | 404-426 |
| | 3 mm | 404-482 | 404-526 | 404-428 |
| | 4 mm | 404-483 | 404-527 | 404-430 |
| | 5 mm | 404-484 | 404-528 | 404-432 |
| | 6 mm | 404-485 | 404-529 | 404-434 |



404-524

Sontec Kerrison 40° Rongeur

Thin footplate / 10 mm opening / down

| | Bite Width | Length of Shaft | |
|--|------------|-----------------|------------|
| | | 7" / 18 cm | 8" / 21 cm |
| | 1 mm | 404-5301 | 404-553 |
| | 2 mm | 404-5302 | 404-554 |
| | 3 mm | 404-5303 | 404-556 |
| | 4 mm | 404-5304 | 404-557 |
| | 5 mm | 404-5305 | 404-558 |
| | 6 mm | 404-5306 | 404-559 |



Kerrison 40° Rongeur

Black and gold ceramic coating / thin footplate-punch / up / 8" (20.3 cm)

| | Bite Width | Metal |
|--|------------|------------|
| | | Black/Gold |
| | 1 mm | 404-400BG |
| | 2 mm | 404-402BG |
| | 3 mm | 404-403BG |
| | 4 mm | 404-404BG |
| | 5 mm | 404-405BG |



Kerrison Bayonet 40° Rongeur

Thin footplate / 10 mm opening / 8" (20 cm) shaft / with & without ejection pin

| | Bite Width | With Pin | Without Pin |
|--------------|------------|----------|-------------|
| 40° Up-Angle | 1 mm | NA | 404-401 |
| | 2 mm | 404-4052 | 404-409 |
| | 3 mm | 404-405 | 404-4033 |
| | 4 mm | 404-4054 | 404-407 |
| | 5 mm | 404-4055 | 404-403 |
| | | | |



Kerrison Bayonet 40° Rongeur

Black ceramic coating / thin footplate / 10 mm opening / 8" (20 cm) shaft / with & without ejection pin

| | Bite Width | With Pin | Without Pin |
|--------------|------------|-----------|-------------|
| 40° Up-Angle | 1 mm | NA | 404-401B |
| | 2 mm | 404-4052B | 404-409B |
| | 3 mm | 404-405B | 404-4033B |
| | 4 mm | 404-4054B | 404-407B |
| | 5 mm | 404-4055B | 404-403B |
| | | | |



Kerrison Bayonet Foraminotomy Rongeur

Curved up / 10" (25.4 cm) shaft







- 404-468 2 mm jaw with thin footplate
- 404-4683 3 mm jaw with thin footplate
- 404-4684 4 mm jaw with thin footplate



Kerrison Convertible 40° Rongeur

8" (20.3 cm) shaft / 10 mm opening / without
ejection pin / ejector pin for 3 mm sizes and
longer only

- * Other tip sizes & lengths available upon request.
- * Swing system for easy cleaning
- * Sizes available 4-6 mm with pin

| | | Bite Width | | |
|--------------|---|------------|----------|-------------|
| 40° Up-Angle |  | 1 mm | 404-337C | without pin |
| |  | 2 mm | 404-338C | without pin |
| |  | 3 mm | 404-339C | with pin |
| |  | 4 mm | 404-340C | with pin |
| |  | 5 mm | 404-341C | with pin |
| |  | 6 mm | 404-342C | with pin |

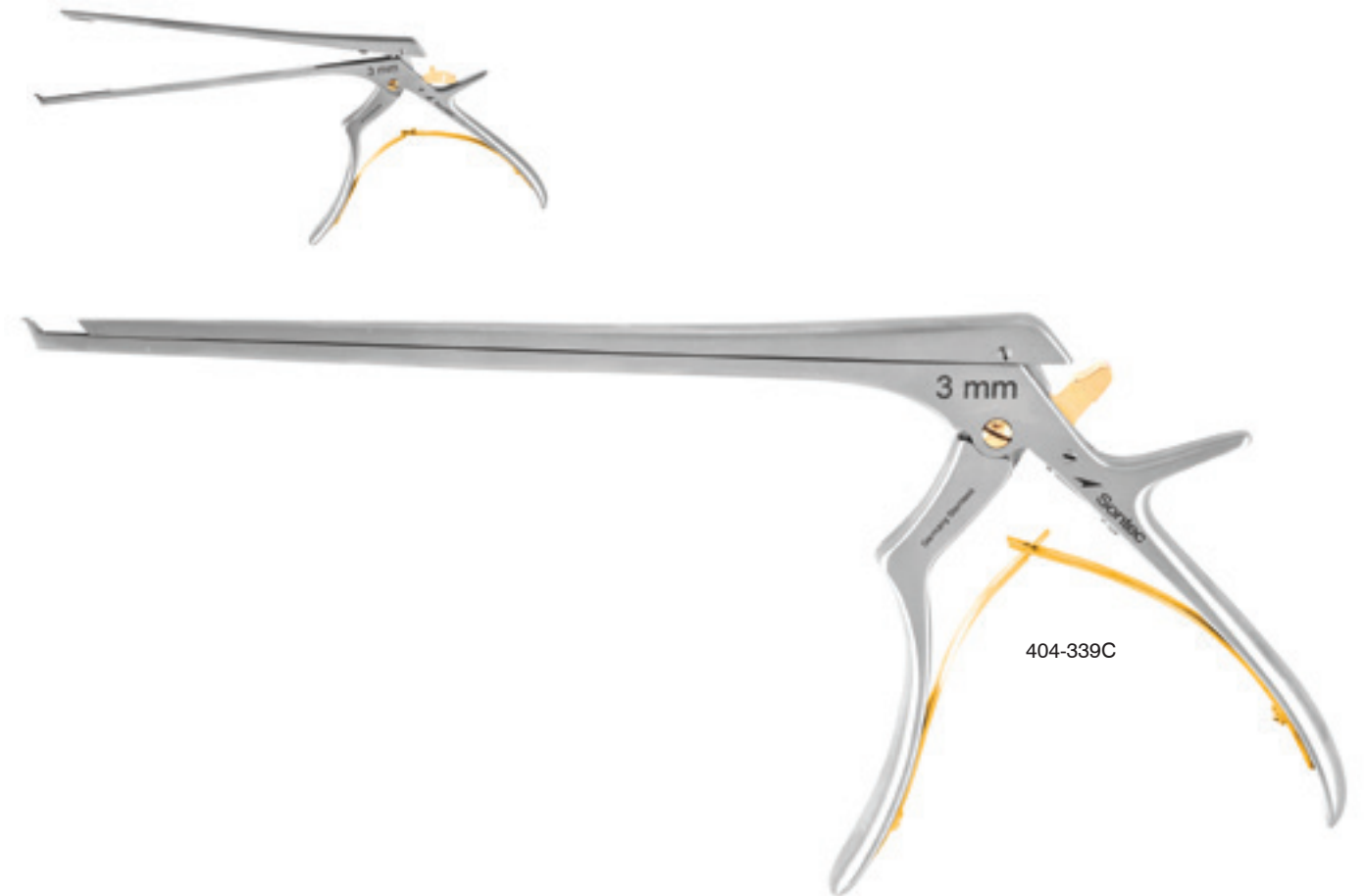

Kerrison 40° Rongeur Titanium

7" (18 cm)
2603-541 3 mm



Sontec Kerrison 40° Rongeur

10 mm opening / up / with ejection pin

| | Bite Width | Length of Shaft | |
|--------------|------------|-----------------|------------|
| | | 7" / 18 cm | 8" / 21 cm |
| 40° Up-Angle | 2 mm | 404-540EJ | 404-402EJ |
| | 3 mm | 404-541EJ | 404-404EJ |
| | 4 mm | 404-542EJ | 404-406EJ |
| | 5 mm | 404-543EJ | 404-408EJ |
| | | | |



Kerrison Punch (Occular-plasti) 90° Rongeur

4" (10 cm) shaft

| | | |
|---------|--------|-----------|
| 16-2100 | 1.0 mm | wide up |
| 16-2101 | 1.5 mm | wide up |
| 16-2102 | 2.0 mm | wide up |
| 16-2106 | 2.5 mm | wide up |
| 16-2103 | 3.0 mm | wide up |
| 16-2104 | 3.0 mm | wide down |
| 16-2105 | 4.0 mm | wide down |
| 16-2107 | 4.0 mm | wide up |

Black ceramic coating / 4" (10 cm) shaft

| | | |
|----------|--------|---------|
| 16-2101B | 1.5 mm | wide up |
| 16-2102B | 2 mm | wide up |



16-2101



16-2103



16-2105



16-2107



16-2102



16-2104



16-2106



Kerrison Punch (Occular-plasti) 40° Rongeur

4" (10 cm) shaft

| | |
|---------|-------------|
| 16-2096 | 1.0 mm wide |
| 16-2097 | 1.5 mm wide |
| 16-2098 | 2.0 mm wide |
| 16-2099 | 3.0 mm wide |

Black ceramic coating / 4" (10 cm) shaft

| | |
|----------|-------------|
| 16-2096B | 1.0 mm wide |
| 16-2097B | 1.5 mm wide |
| 16-2098B | 2.0 mm wide |

| | | Bite Width | |
|--------------|--|------------|---------|
| 40° Up-Angle | | 1 mm | 16-2096 |
| | | 1.5 mm | 16-2097 |
| | | 2 mm | 16-2098 |
| | | 3 mm | 16-2099 |



16-2098

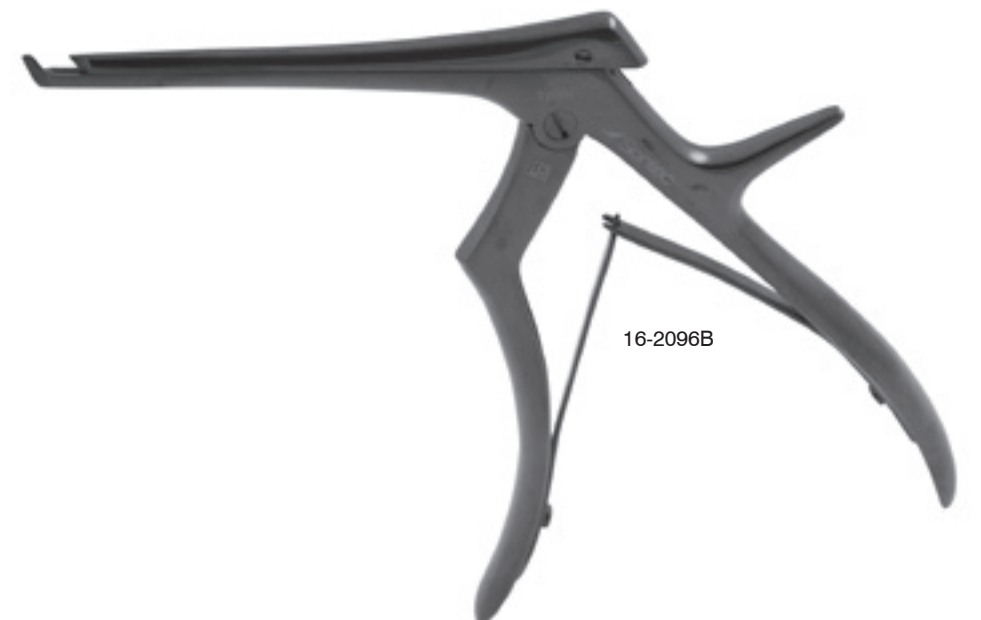
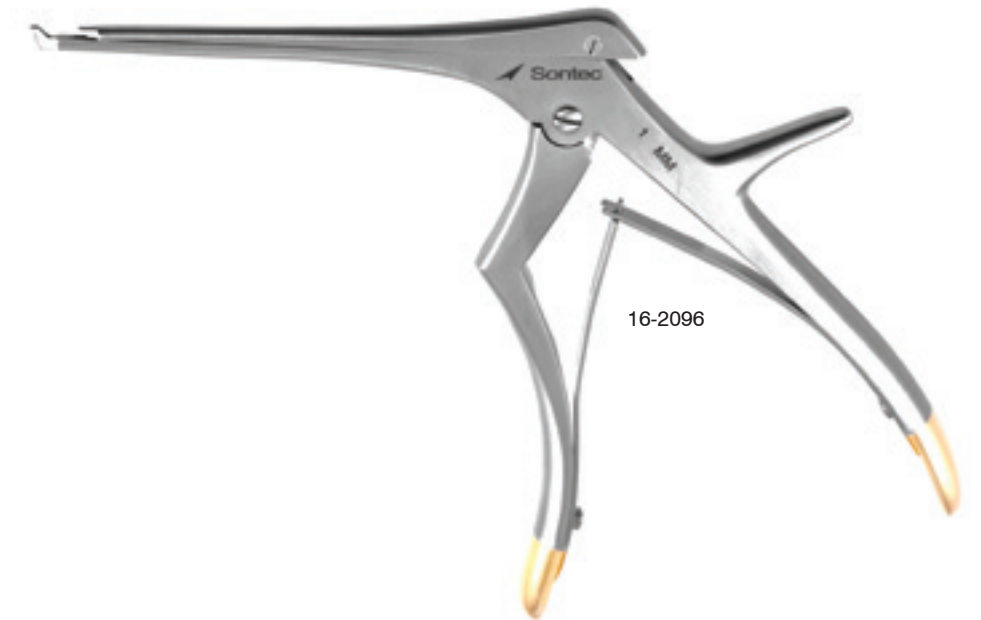

Sontec Kerrison Rongeur

40° / easy clean / 8" (20.3 cm)

- 404-400E 1 mm
- 404-402E 2 mm with ejector pin
- 404-404E 3 mm with ejector pin
- 404-406E 4 mm with ejector pin
- 404-408E 5 mm with ejector pin

| | Bite Width | With Pin | Without Pin |
|--|------------|----------|-------------|
| | 1 mm | NA | 404-400E |
| | 2 mm | 404-402E | NA |
| | 3 mm | 404-404E | NA |
| | 4 mm | 404-406E | NA |
| | 5 mm | 404-408E | NA |



Rongeurs Tray

Anodized aluminum tray / 9" x 13" x 6"

18-3562



18-3562



Care and Maintenance for the Universal Rotating 360° Kerrison Rongeur Shafts & Handles

The Universal Rotating 360° Kerrison Rongeur shafts are comprised of four parts:
 A: outside shaft with frontal jaw blade
 B: Inner shaft with threading at the tip
 C: Back side blade/ jaw with screw port at the end
 D: spring

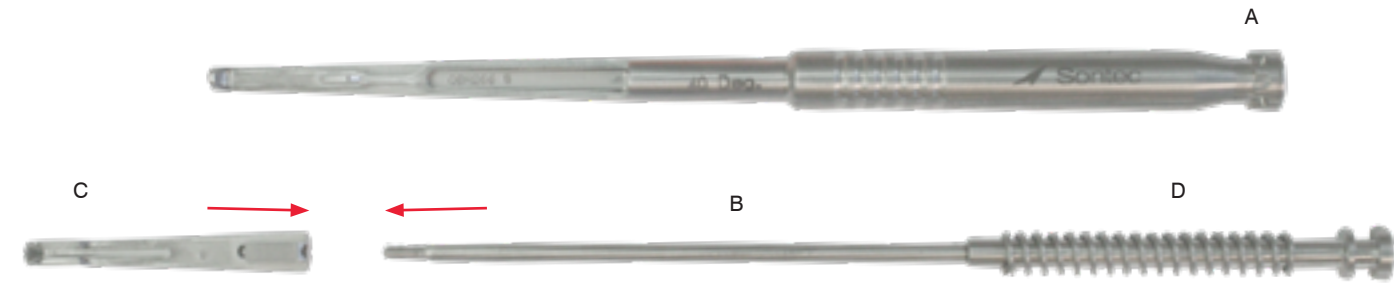

Slide inner shaft (B) through outer shaft (A).
 Then screw jaw (C) into inner shaft (B).



Screw inner shaft (B) and jaw (C) completely together (only after Inner shaft (B) and outer shaft (A) are together.)

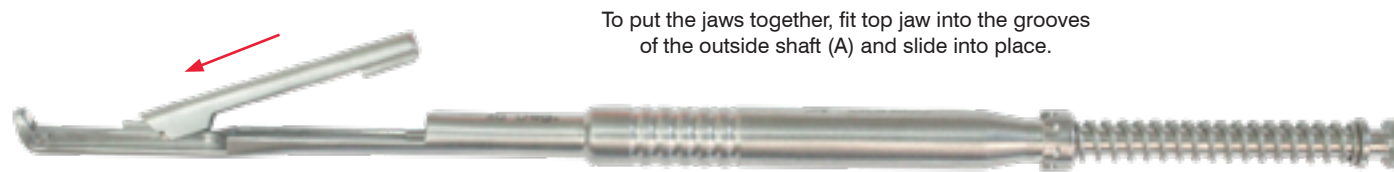

To put the jaws together, fit top jaw into the grooves of the outside shaft (A) and slide into place.

Use the grooves on the outside shaft (A) and the back side jaw/ blade (C) to fit the two parts into position.



This is the point where the jaw/ blade (C) and inner shaft (B) are screwed together. You must make sure the two parts are fully screwed together for the Rongeur to work properly.

RELEASING SHAFT

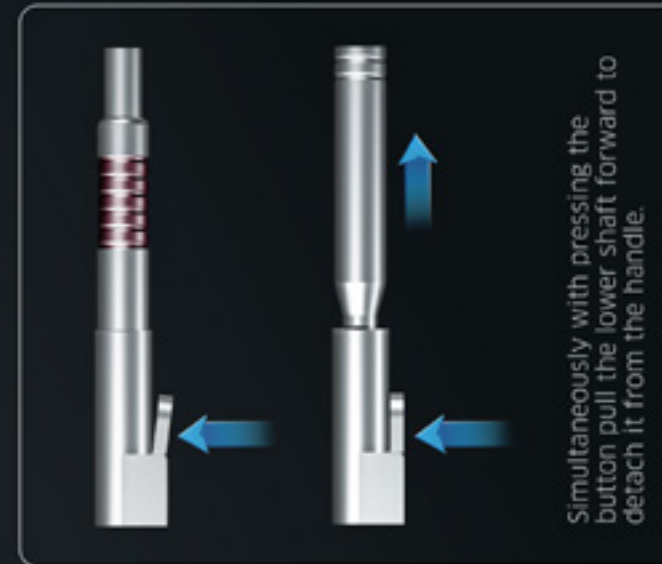

Simultaneously with pressing the button pull the lower shaft forward to detach it from the handle.

INSERTING SHAFT

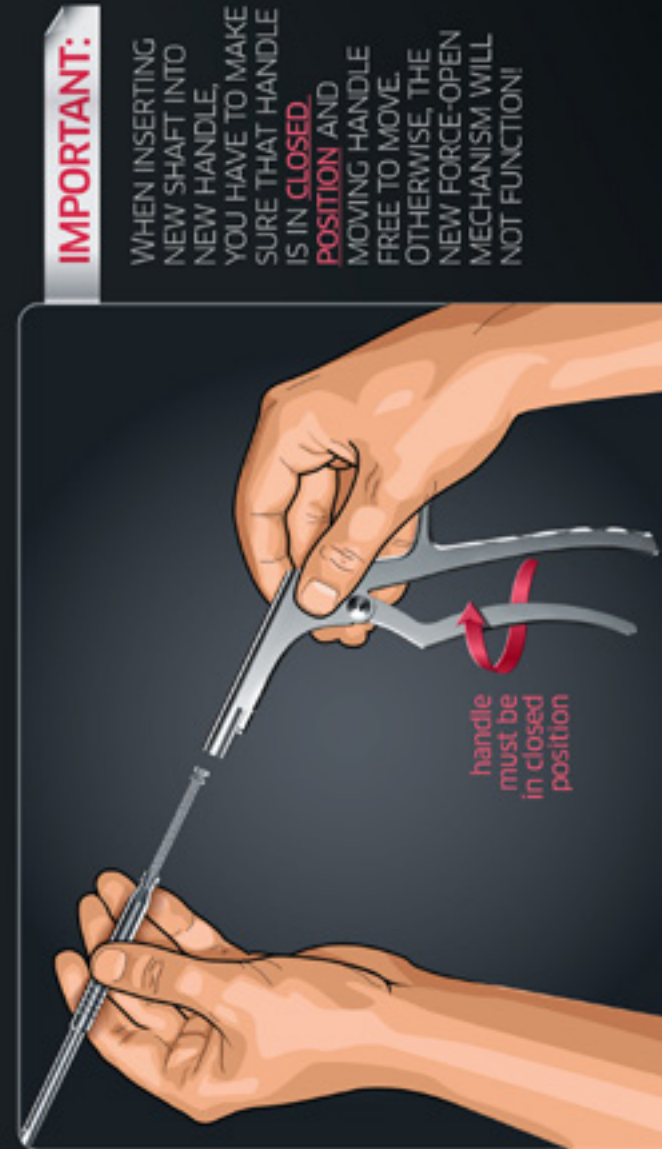

IMPORTANT:

WHEN INSERTING NEW SHAFT INTO NEW HANDLE, YOU HAVE TO MAKE SURE THAT HANDLE IS IN **CLOSED POSITION** AND MOVING HANDLE FREE TO MOVE. OTHERWISE, THE NEW FORCE-OPEN MECHANISM WILL NOT FUNCTION!

handle must be in closed position

low and the positive results are almost immediately visible.

For detailed information regarding training and available additional instruction see the contacts on the back cover of this brochure.

This new kind of Kerrison's approach, besides significant financial savings simplifies the entire working process. Your productivity will not be affected by a very short training period. The costs of migration to this new product are very

Click Kerrison punches are suitable for all kinds of shafts: Straight, Bayonet, Curved up and down. You do not need to keep a large stock of Kerrisons, only the shafts are necessary.



 Sontec Instruments®

Pistol Grip RONGEURS

Weil-Blakesley Rongeur

Pointed elliptical fenestrated jaw / 4 1/2" (11.5 cm) shaft

- 404-767 3 x 8 mm jaw
- 404-768 4 x 12 mm jaw
- 404-769 5 x 12.5 mm jaw
- 404-770 6 x 13 mm jaw

Pointed elliptical fenestrated jaw / 45° / 4 1/2" (11.5 cm) shaft

- 404-766 3 x 8 mm jaw
- 404-771 4 x 12 mm jaw
- 404-772 5 x 12.5 mm jaw

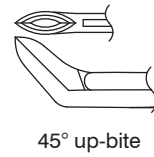
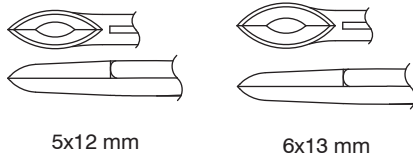
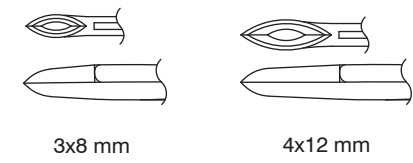

Wilde Ethmoid Rongeur

Rounded elliptical fenestrated jaw / 4 1/2" (11.5 cm) shaft

- 468-600 3x8 mm jaw
- 468-610 4x12 mm jaw
- 468-620 5x12.5 mm jaw

Rounded elliptical fenestrated jaw / 45° up-bite / 4 1/2" (11.5 cm) shaft

- 468-606 3x8 mm jaw
- 468-616 4x12 mm jaw
- 468-622 5x12.5 mm jaw

Rounded elliptical fenestrated jaw / 3x8.0 mm jaw / with suction / 4 1/2" (11.5 cm) shaft

- 468-636 straight
- 468-638P 45° up-bite

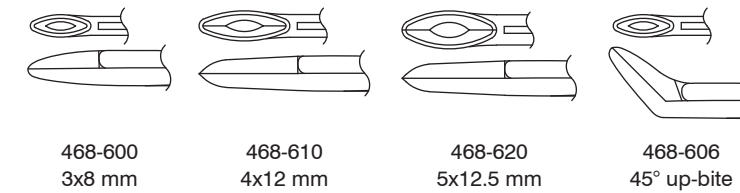

Weil Nasal Rongeur

5 mm bite / 4 1/4" (10.5 cm) shaft

- 468-548 straight
- 468-550 45° angled up

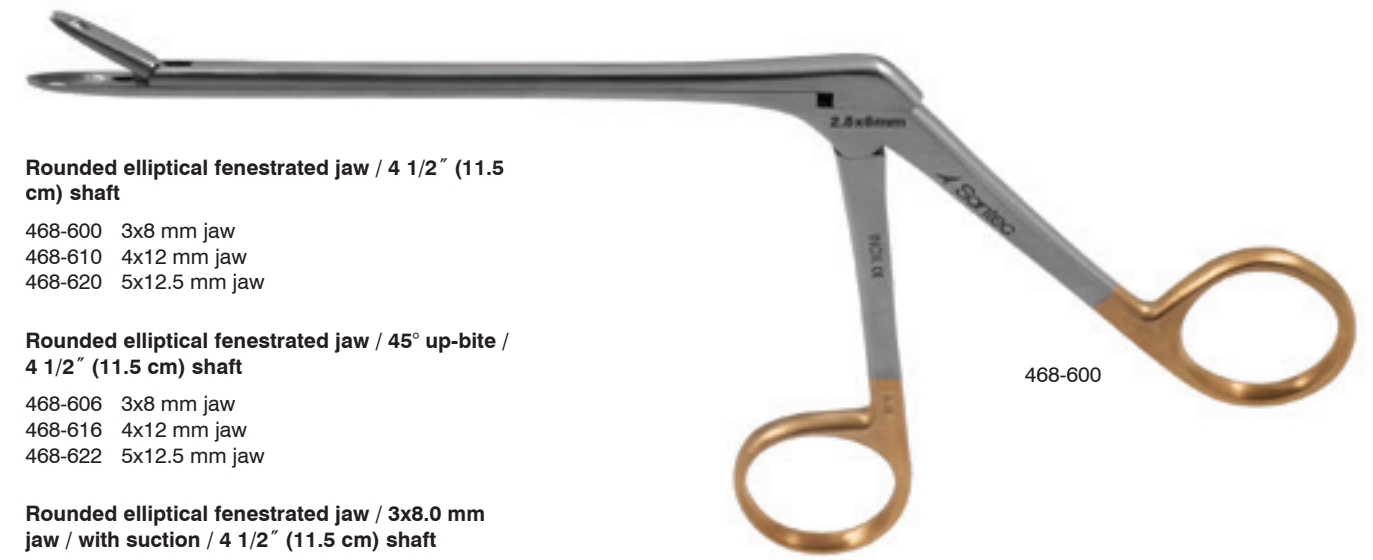

Wilde Ethmoid Arthroscopic Rongeur

Fenestrated jaw / 7" (17.8 cm) shaft / 2.5 mm

- 404-774 straight
- 404-775 up-bite
- 404-776 down-bite



Ethmoid Pediatric Rongeur

2.5 mm micro jaw / 3 3/4" (9.5 cm) shaft

- 468-580 straight
- 468-585 45° up-angle
- 468-590 90° up-angle



468-590



Blakesley-Ethmoid Rongeur

3.5 mm jaw / 4 1/4" (11 cm) shaft

- 468-680 45° up-angle
- 468-682 90° up-angle



468-682



468-680

Blakesley Ethmoid Rongeur

4.5 mm x 11 mm fenestrated jaw / 4 1/4" (10.8 cm)

- 468-684 40° angle
- 468-686 90° up-angle



468-686

Williams-Sontec Rongeur

For arthroscopy & discectomy / very sharp / 2 mm x 5 mm jaw / 1 x 2 teeth / 5 1/2" (14 cm) shaft

404-824



actual size



404-824

Mcllwraith Basket Cutter Rongeur

5" (12.5 cm)

1404-857 2.5 mm x 8 mm jaw

1404-858 3.5 mm x 8 mm jaw



actual size



1404-857

Mcllwraith Arthroscopic Scissors Rongeur

Scissor action / serrated / 1 mm x 14 mm cup / 5" (12.5 cm) shaft

1404-855



1404-855

Mcllwraith-Peapod Rongeur

Longer shaft available by special order



404-783

Straight / 5 1/2" (14 cm) shaft

404-782 2.2 mm x 6 mm jaw cup

Up-angled / 5 1/2" (14 cm) shaft

404-783 2.2 mm x 6 mm jaw cup small

404-784 3 mm x 6 mm jaw cup medium

404-785 4 mm x 6 mm jaw cup large

Peapod-McIlwraith Rongeur



Straight / 3.2 mm x 6 mm jaw cup / 5 1/2" (14 cm)

1404-866

Bailey Rongeur



3 x 6 mm, 4 1/2" (11.4 cm)

- 440-308 straight
- 440-309 25° down
- 440-310 70° down
- 440-311 90° down
- 440-312 45° left
- 440-313 45° right



440-309



440-310



440-311



440-312



440-313

Peapod Extended Shaft Rongeur

Up-angled / 6 1/4" (16 cm) shaft

- 404-779 2.2 mm x 6 mm jaw cup small
- 404-780 3 mm x 6 mm jaw cup medium
- 404-781 4 mm x 6 mm jaw cup large



Selverstone Peapod Rongeur

Straight / 2 mm x 5 mm jaw / 6" (15.5 cm) shaft

404-789



Takahashi Rongeur

2.5 mm x 10 mm jaw cup / straight

- 404-786 3 1/2" (9 cm) shaft
- 404-787 4 1/2" (11.5 cm) shaft
- 404-788 5 1/2" (14 cm) shaft

3 mm x 10 mm jaw cup / 4 1/2" (11.5 cm) shaft

- 404-788U up-angled
- 404-7871 straight

3 mm x 8 mm oval jaw cup / straight

- 404-7885 5 1/2" (14 cm) shaft

3.5 mm x 10 mm jaw cup / straight

- 404-7875 4" (10 cm) shaft



404-788U



404-7871



404-7875

McIlwraith Cup Rongeur

Round cup / straight / 7" (18 cm) shaft

- 1404-845A 2 mm cup
- 1404-845B 4 mm cup
- 1404-845D 6 mm cup

Round cup / up-angled / 7" (18 cm) shaft

- 1404-846A 2 mm cup
- 1404-846B 4 mm cup
- 1404-846D 6 mm cup



1404-846D



1404-845A



1404-845D

Sheen Fragment Retriever Forceps

Low profile / 7" (18 cm)

- 469-035



469-035

Cushing Pituitary Rongeur

2 mm x 10 mm bite

| | | |
|----------|-------------|---------------------|
| 404-712 | straight | 5" (13 cm) shaft |
| 404-714 | up-angled | 5" (13 cm) shaft |
| 404-716 | down-angled | 5" (13 cm) shaft |
| 404-719 | straight | 7" (18 cm) shaft |
| 404-721 | up-angled | 7" (18 cm) shaft |
| 404-723 | down-angled | 7" (18 cm) shaft |
| 404-711 | straight | 12" (30.5 cm) shaft |
| 404-711U | up | 12" (30.5 cm) shaft |
| 404-711D | down | 12" (30.5 cm) shaft |

bite size

 2 x 10 mm



404-719



404-721



404-723

Love-Gruenwald Pituitary Rongeur

3 mm x 10 mm bite

| | | |
|----------|-------------|---------------------|
| 404-727 | straight | 5" (13 cm) shaft |
| 404-729 | up-angled | 5" (13 cm) shaft |
| 404-731 | down-angled | 5" (13 cm) shaft |
| 404-734 | straight | 7" (18 cm) shaft |
| 404-736 | up-angled | 7" (18 cm) shaft |
| 404-737 | down-angled | 7" (18 cm) shaft |
| 404-738 | straight | 12" (30.5 cm) shaft |
| 404-738U | up | 12" (30.5 cm) shaft |
| 404-738D | down | 12" (30.5 cm) shaft |

bite size

 3 x 10 mm



404-727



404-729



404-734

Schlesinger (Cloward) Rongeur

Serrated bite / straight / 6" (15 cm) shaft

- 404-754 2 mm x 10 mm bite
- 404-755 3 mm x 10 mm bite
- 404-755L 3 mm x 10 mm bite
- 404-756 4 mm x 10 mm bite
- 404-761 6 mm x 10 mm bite

7" shaft

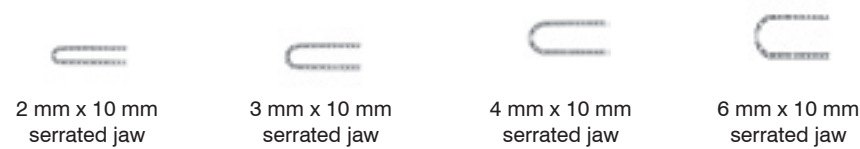

Longer shaft available by special order

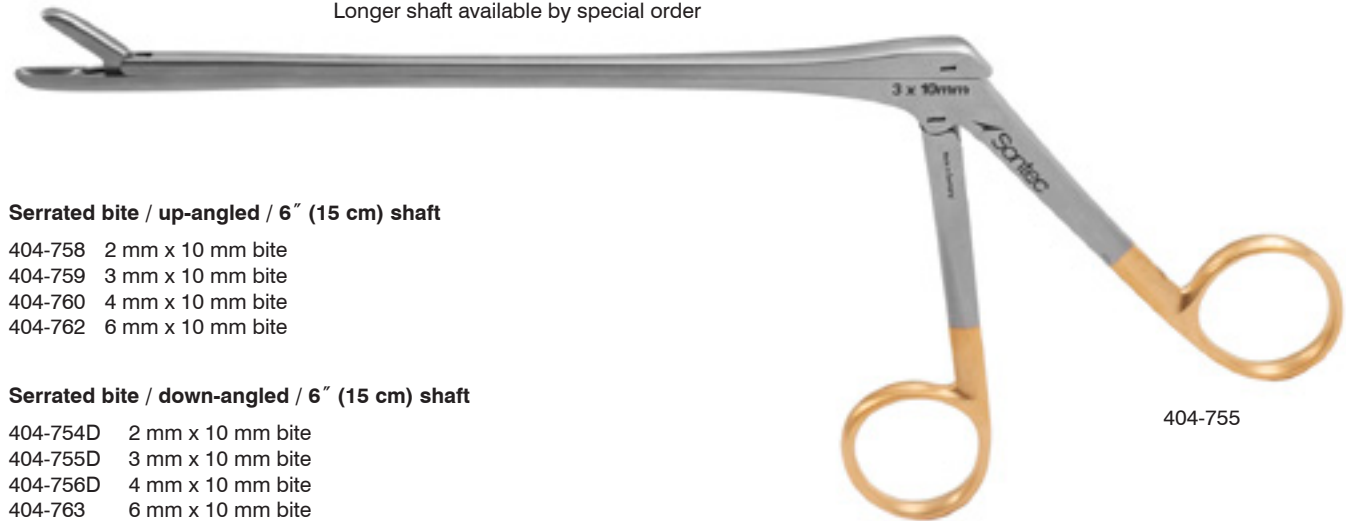

Serrated bite / up-angled / 6" (15 cm) shaft

- 404-758 2 mm x 10 mm bite
- 404-759 3 mm x 10 mm bite
- 404-760 4 mm x 10 mm bite
- 404-762 6 mm x 10 mm bite

Serrated bite / down-angled / 6" (15 cm) shaft

- 404-754D 2 mm x 10 mm bite
- 404-755D 3 mm x 10 mm bite
- 404-756D 4 mm x 10 mm bite
- 404-763 6 mm x 10 mm bite

Spurling Pituitary Rongeur

4 mm x 10 mm bite

- 404-740 straight 5" (12.5 cm) shaft
- 404-742 up-angled 5" (12.5 cm) shaft
- 404-744 down-angled 5" (12.5 cm) shaft
- 404-747 straight 7" (18 cm) shaft
- 404-749 up-angled 7" (18 cm) shaft
- 404-751 down-angled 7" (18 cm) shaft
- 404-739 straight 12" (30.5 cm) shaft
- 404-739U up angle 12" (30.5 cm) shaft
- 404-739D down angle 12" (30.5 cm) shaft

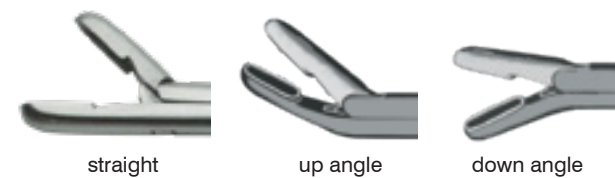

NEW EASY CLEAN

Cushing Pituitary Rongeur

Easy clean / straight / 2 mm x 10 mm jaw / 7" (17.8 cm)

404-719E



Love Gruenwald Pituitary Rongeur

Easy clean / straight / 3 mm x 10 mm jaw / 7" (17.8 cm)

404-734E



Spurling Pituitary Rongeur

Easy clean / straight / 4 mm x 10 mm jaw / 7" (17.8 cm)

404-747E



Caspar Grasping Rongeur

Straight / 5 1/2" (14 cm) shaft

- 53-0510 2 mm x 12 mm jaw
- 53-0512 3 mm x 12 mm jaw
- 53-0514 4 mm x 14 mm jaw
- 53-0516 5 mm x 14 mm jaw
- 53-0518 6 mm x 16 mm jaw

Straight / 6 1/4" (16 cm) shaft

- 53-0520 2 mm x 12 mm jaw
- 53-0522 3 mm x 12 mm jaw
- 53-0524 4 mm x 14 mm jaw
- 53-0526 5 mm x 14 mm jaw
- 53-0528 6 mm x 16 mm jaw

Straight / 7 1/4" (18.5 cm)

- 53-0530 2 mm x 12 mm jaw
- 53-0532 3 mm x 12 mm jaw
- 53-0534 4 mm x 14 mm jaw
- 53-0536 5 mm x 14 mm jaw
- 53-0538 6 mm x 16 mm jaw

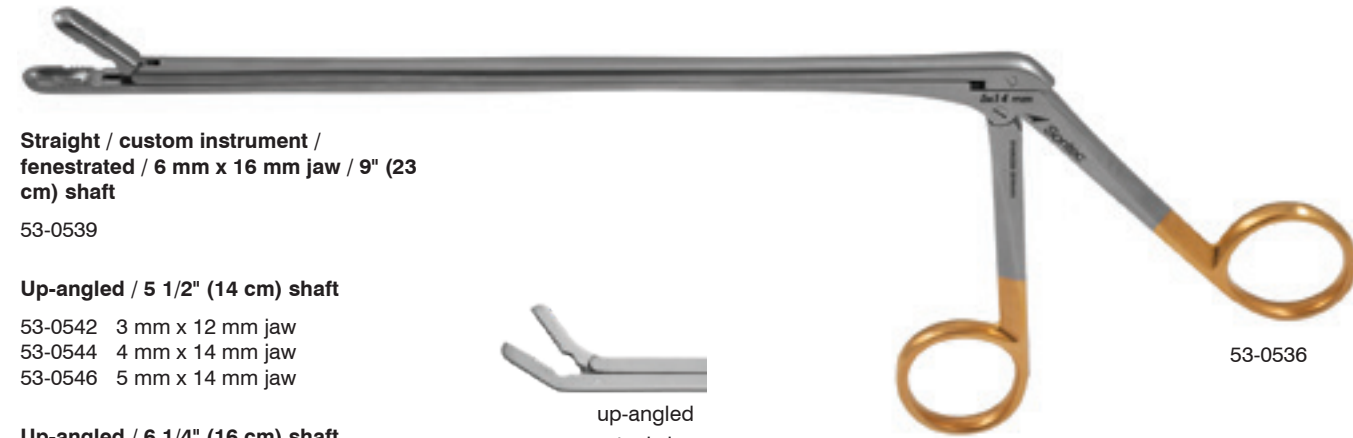

Straight / custom instrument / fenestrated / 6 mm x 16 mm jaw / 9" (23 cm) shaft

53-0539

Up-angled / 5 1/2" (14 cm) shaft

- 53-0542 3 mm x 12 mm jaw
- 53-0544 4 mm x 14 mm jaw
- 53-0546 5 mm x 14 mm jaw



up-angled
actual size

Up-angled / 6 1/4" (16 cm) shaft

- 53-0552 3 mm x 12 mm jaw
- 53-0554 4 mm x 14 mm jaw
- 53-0556 5 mm x 14 mm jaw

Up-angled / 7 1/4" (18.5 cm) shaft

- 53-0560 2 mm x 12 mm jaw
- 53-0562 3 mm x 12 mm jaw
- 53-0564 4 mm x 14 mm jaw
- 53-0566 5 mm x 14 mm jaw

Down-angled / 5 1/2" (14 cm) shaft

- 53-0572 3 mm x 12 mm jaw
- 53-0574 4 mm x 14 mm jaw







down-angled
actual size

Down-angled / 6 1/4" (16 cm) shaft

- 53-0582 3 mm x 12 mm jaw
- 53-0584 4 mm x 14 mm jaw

Down-angled / 7 1/4" (18.5 cm) shaft

- 53-0590 2 mm x 12 mm jaw
- 53-0592 3 mm x 12 mm jaw
- 53-0594 4 mm x 14 mm jaw

-  2 mm x 12 mm
-  3 mm x 12 mm
-  4 mm x 14 mm
-  5 mm x 14 mm
-  6 mm x 16 mm

53-0536

Ferris-Smith Arthroscopic Rongeur

4 mm x 6 mm / 7" (18 cm) shaft

- 404-813 round jaw
- 404-814 square jaw



404-813



404-814

Ferris-Smith Arthroscopic Rongeur

Low profile / straight / 7" (18 cm) shaft

| | |
|------------|----------------------------|
| 404-790LP | 2 mm x 10 mm bite |
| 404-791LP | 3 mm x 10 mm bite |
| 404-792LP | 4 mm x 10 mm bite |
| 404-793LP | 4 mm x 8 mm bite |
| 404-796LP | 5 mm x 10 mm bite |
| 404-794LP | 6 mm x 10 mm bite |
| 404-795LP | 6 mm x 12 mm bite |
| 404-795SLP | 6 mm x 12 mm bite serrated |

Low profile / up-angled / 7" (18 cm) shaft

| | |
|-----------|-------------------|
| 404-800LP | 2 mm x 10 mm bite |
| 404-801LP | 3 mm x 10 mm bite |
| 404-802LP | 4 mm x 10 mm bite |
| 404-803LP | 6 mm x 10 mm bite |

Low profile / down-angled / 7" (18 cm) shaft

| | |
|-----------|-------------------|
| 404-810LP | 2 mm x 10 mm bite |
| 404-811LP | 3 mm x 10 mm bite |
| 404-812LP | 4 mm x 10 mm bite |



404-792LP



404-800LP

Ferris-Smith Arthroscopic Rongeur

Straight / 7" (18 cm) shaft

| | |
|----------|-----------------------------|
| 404-790 | 2 mm x 10 mm bite |
| 404-791 | 3 mm x 10 mm bite |
| 404-792 | 4 mm x 10 mm bite |
| 404-792B | 4 mm x 10 mm bite Ceramitec |
| 404-793 | 4 mm x 8 mm bite |
| 404-792S | 4 mm x 10 mm bite serrated |
| 404-796 | 5 mm x 10 mm bite |
| 404-794 | 6 mm x 10 mm bite |
| 404-795 | 6 mm x 12 mm bite |

Straight / 8" (20.5 cm) shaft / special order

| | |
|---------|-------------------|
| 404-825 | 2 mm x 10 mm bite |
| 404-826 | 3 mm x 10 mm bite |
| 404-827 | 4 mm x 10 mm bite |
| 404-828 | 5 mm x 10 mm bite |
| 404-829 | 6 mm x 10 mm bite |

Straight / 9" (23 cm) shaft

| | |
|----------|-------------------|
| 404-7929 | 4 mm x 10 mm bite |
| 404-7959 | 6 mm x 12 mm bite |

Up-angled / 7" (18 cm) shaft

| | |
|----------|----------------------------|
| 404-800 | 2 mm x 10 mm bite |
| 404-801 | 3 mm x 10 mm bite |
| 404-802 | 4 mm x 10 mm bite |
| 404-802S | 4 mm x 10 mm bite serrated |
| 404-803 | 6 mm x 10 mm bite |

Up-angled / 8" (20.5) shaft / special order

| | |
|---------|-------------------|
| 404-830 | 2 mm x 10 mm bite |
| 404-831 | 3 mm x 10 mm bite |
| 404-832 | 4 mm x 10 mm bite |
| 404-833 | 5 mm x 10 mm bite |
| 404-834 | 6 mm x 10 mm bite |

*special order

Down-angled / 7" (18 cm) shaft

| | |
|---------|-------------------|
| 404-810 | 2 mm x 10 mm bite |
| 404-811 | 3 mm x 10 mm bite |
| 404-812 | 4 mm x 10 mm bite |

Down-angled / 8" (20.5 cm) shaft / special order

| | |
|---------|-------------------|
| 404-835 | 2 mm x 10 mm bite |
| 404-836 | 3 mm x 10 mm bite |
| 404-837 | 4 mm x 10 mm bite |
| 404-838 | 5 mm x 10 mm bite |
| 404-839 | 6 mm x 10 mm bite |

*special order

2 mm x 10 mm 3 mm x 10 mm 4 mm x 8 mm 4 mm x 10 mm 6 mm x 10 mm 6 mm x 12 mm

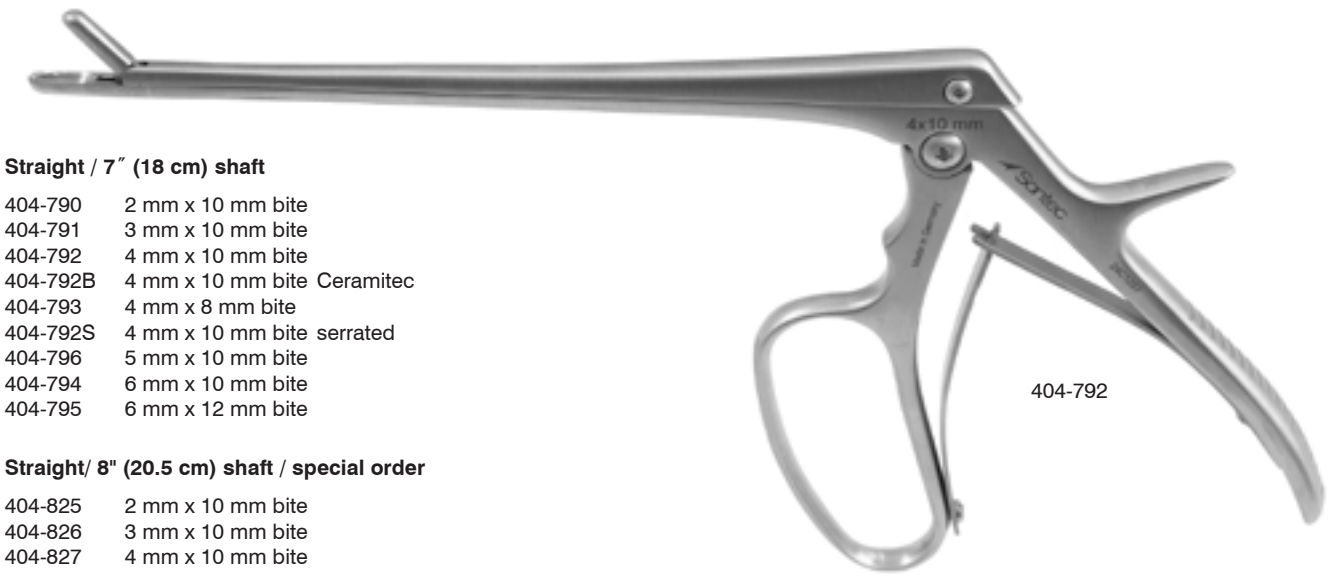

404-792



404-792B



404-792

404-802S

404-792S

Ferris-Smith Rongeur

With Kerrison handle / straight / 4 mm x 8 mm / 7" (18 cm) shaft

404-793K



Ferris-Smith Wilde Rongeur

Straight / powerful, low profile, tapered Wilde jaw design / 5 mm x 10 mm bite / 7" (18 cm) shaft

404-777



Ferris-Smith Arthroscopic Ultra-Low Profile Rongeur with Enhanced Jaw Power

5 mm x 10 mm / straight jaw

404-797 with fenestrated jaw

404-798 without fenestrated jaw



Ferris-Smith Spinal Extended Shaft Rongeur

Extra long shaft / straight / 12" (30.5 cm) shaft

404-822 4mm x 10mm bite serrated

404-823 3mm x 10mm bite

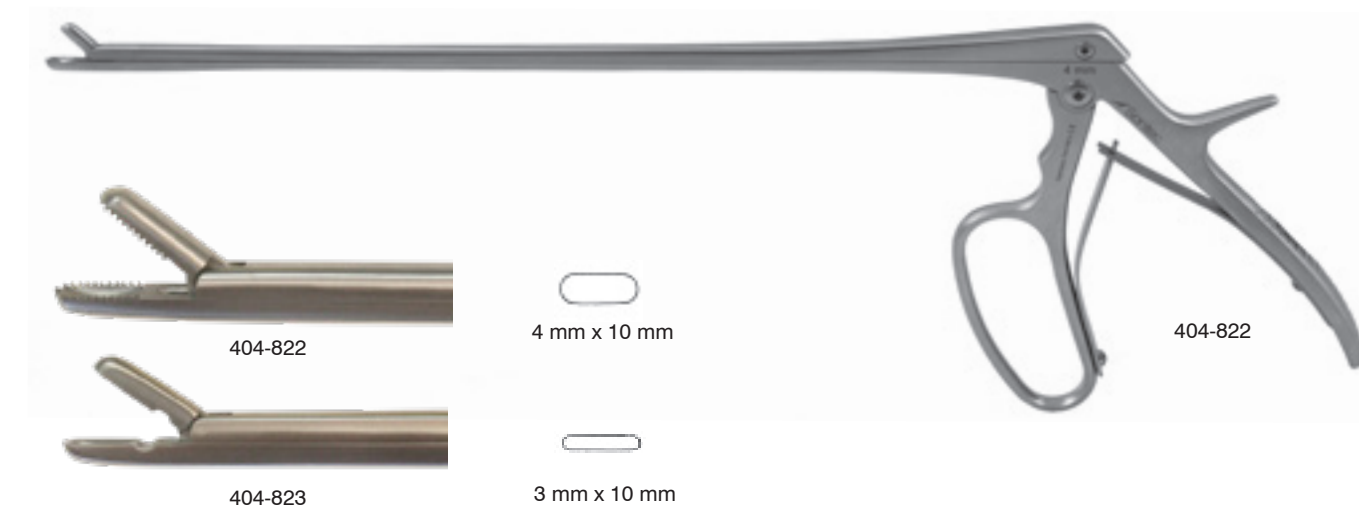

Ferris-Smith Arthroscopic Rongeur Boyonet

Straight / 4 x 10 mm / 7" working length / 10" overall length

404-469



Hoen Grasping Forceps

1 x 2 teeth / 5 1/2" (14 cm) shaft

1404-862



Decker Micro Rongeur

2 mm x 6 mm bite

- 469-053 straight 3 1/2" (9 cm) shaft
- 469-056 straight 6" (15 cm) shaft
- 469-057 cvd right 6" (15 cm) shaft
- 469-058 cvd left 6" (15 cm) shaft
- 469-055 angled up 6" (15 cm) shaft

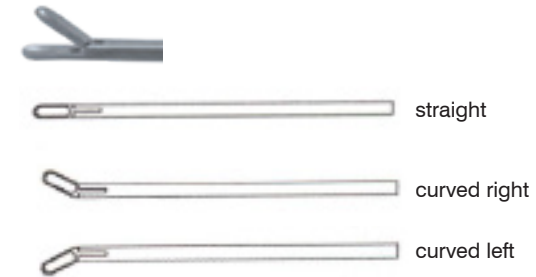

McIlwraith Arthroscopic Grasping Rongeur

Heavy duty / 1 x 2 teeth / 6 1/2" (16.5 cm) shaft

- 1404-860 4 mm x 10 mm jaw
- 1404-865 3.4 mm x 10 mm standard
- 1404-861 3 mm x 10 mm jaw delicate

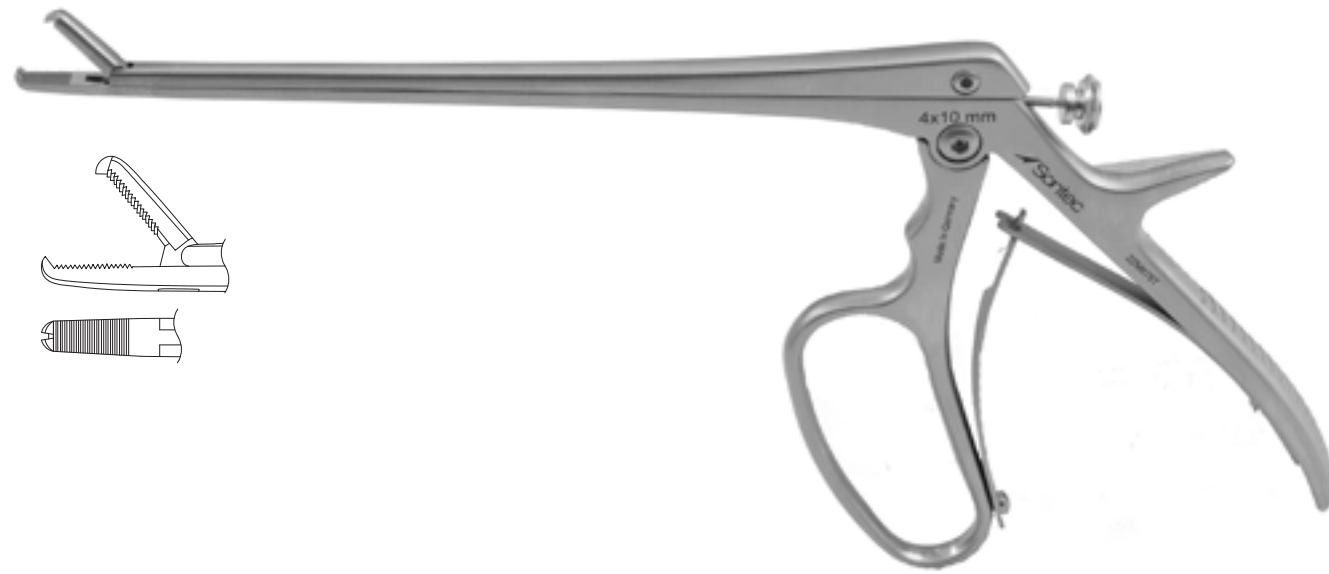

1404-860



1404-861

Micro Neuro Biopsy Rongeur

2.6 mm tip / 10 1/4" WL

1271-089



1271-089

McIlwraith Arthroscopic Grasping Rongeur

Straight / 4 mm round cup / 4" (10.2 cm) shaft

1404-842



1404-842



 Sontec Instruments®

Orthopedic DOUBLE ACTION RONGEURS

Ruskin Rongeur

Double action / 6" (15.5 cm)

| | | |
|---------|----------|--------------|
| 315-585 | 2 mm jaw | str |
| 315-587 | 2 mm jaw | cvd |
| 315-590 | 3 mm jaw | str |
| 315-588 | 3 mm jaw | slight curve |
| 315-589 | 3 mm jaw | full curve |
| 315-586 | 4 mm jaw | str |
| 315-593 | 4 mm jaw | cvd |

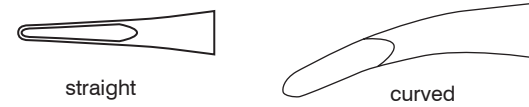

Double action / 7 1/4" (18.5 cm)

| | | |
|---------|----------|-----|
| 315-610 | 5 mm jaw | str |
| 315-612 | 5 mm jaw | cvd |
| 315-614 | 6 mm jaw | str |
| 315-616 | 6 mm jaw | cvd |

Double action / 5 mm / 9 1/2" (23.1 cm)

| | |
|---------|-----|
| 315-619 | str |
| 315-621 | cvd |

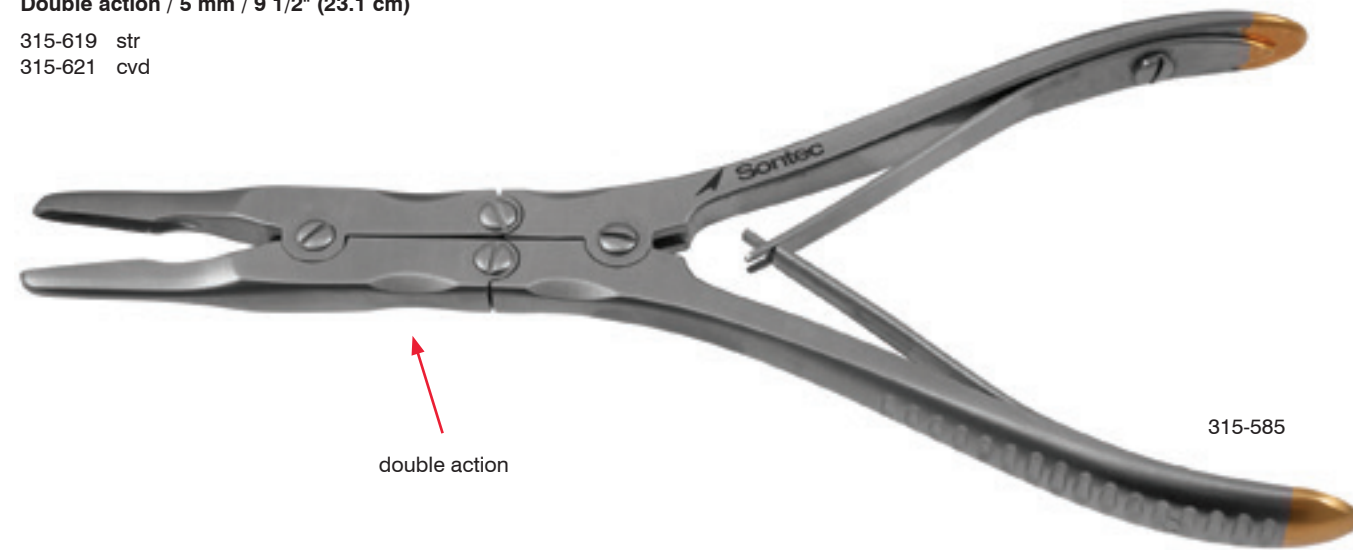

double action

315-585

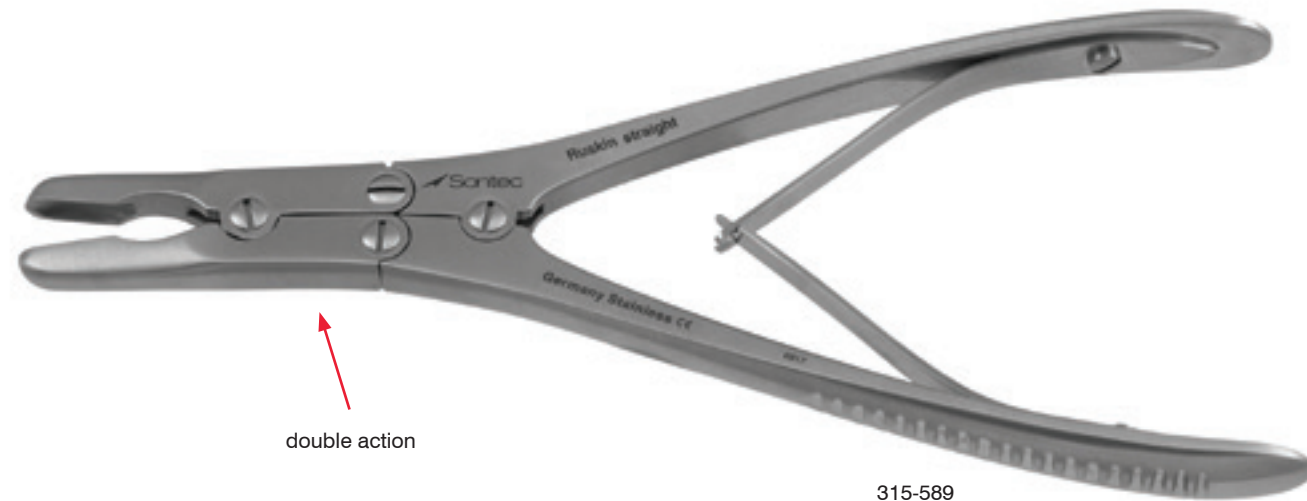

double action

315-589

Black Ruskin Rongeur

Curved / double action / ceramic coated / 4 mm / 7 1/4" (18.5 cm)

315-595

double action

315-595

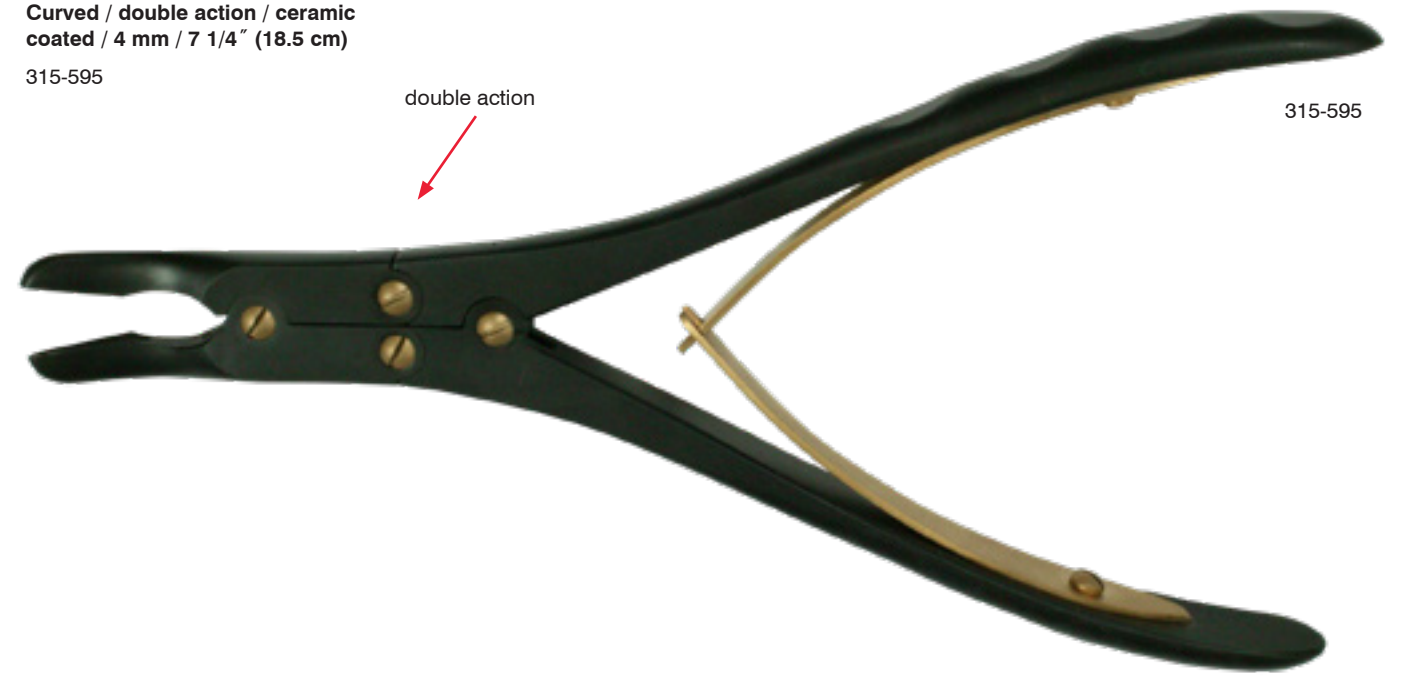

Kleinert-Kutz Duckbill Synovectomy Rongeur

Double action / 2 mm x 10 mm jaw / curved to side / 6" (15.5 cm)

315-622

double action

315-622

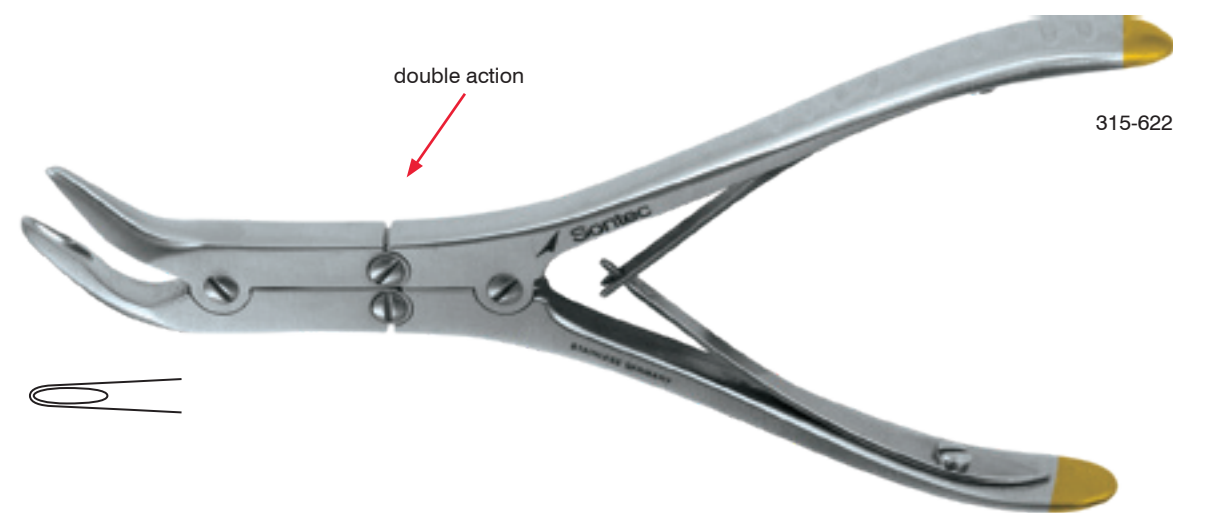

Ruskin Duckbill Rongeur

Double action / 5 mm jaw / curved to side / 7 1/4" (18.5 cm)

315-620

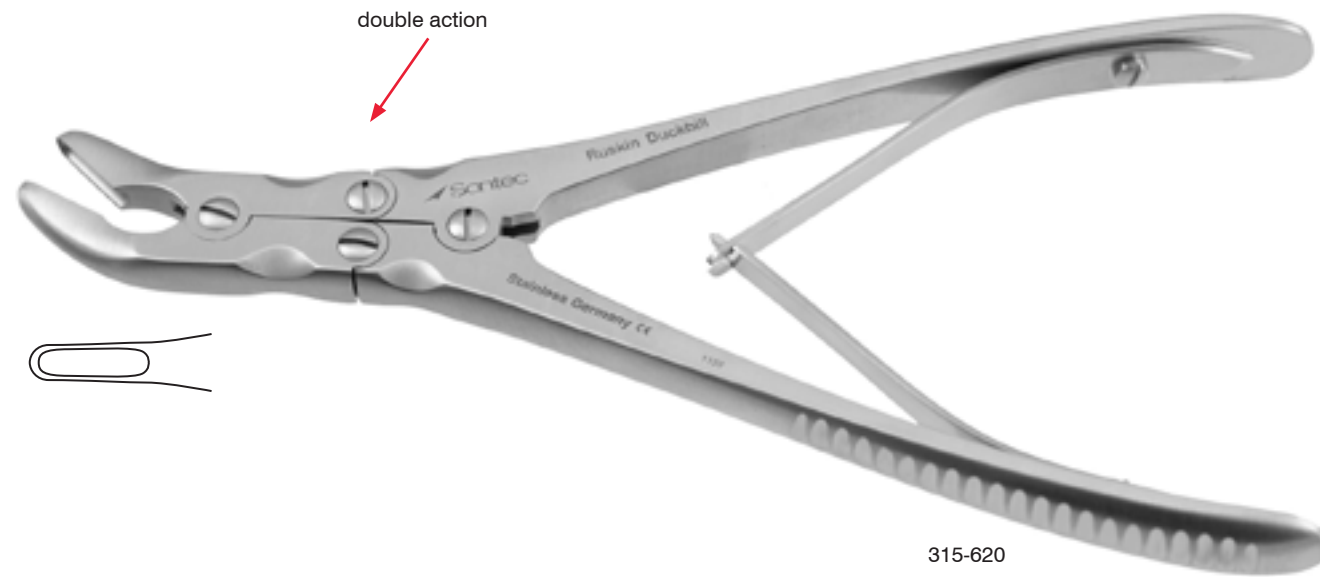

Beyer Rongeur

Double-action / curved / 7" (18 cm)

- 315-597 2.3 mm jaw
- 315-598 3.0 mm jaw
- 315-599 4.0 mm jaw

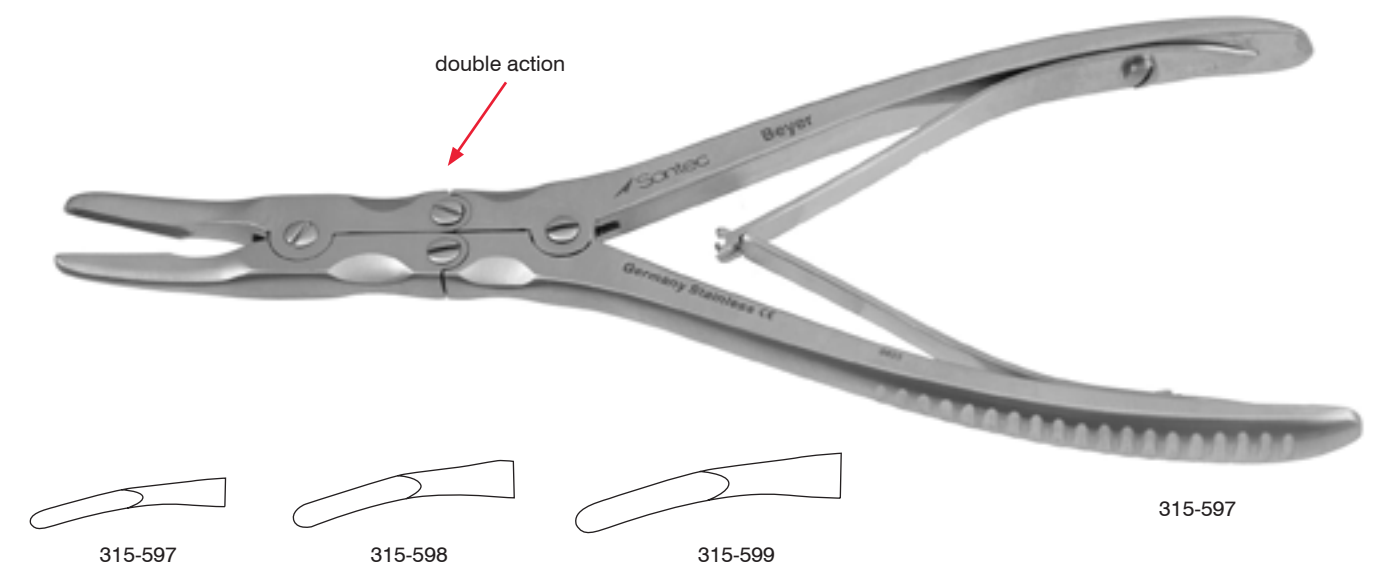

Zaufel-Jansen Rongeur

Double-action / 4 mm jaw / 7" (18 cm)

315-600

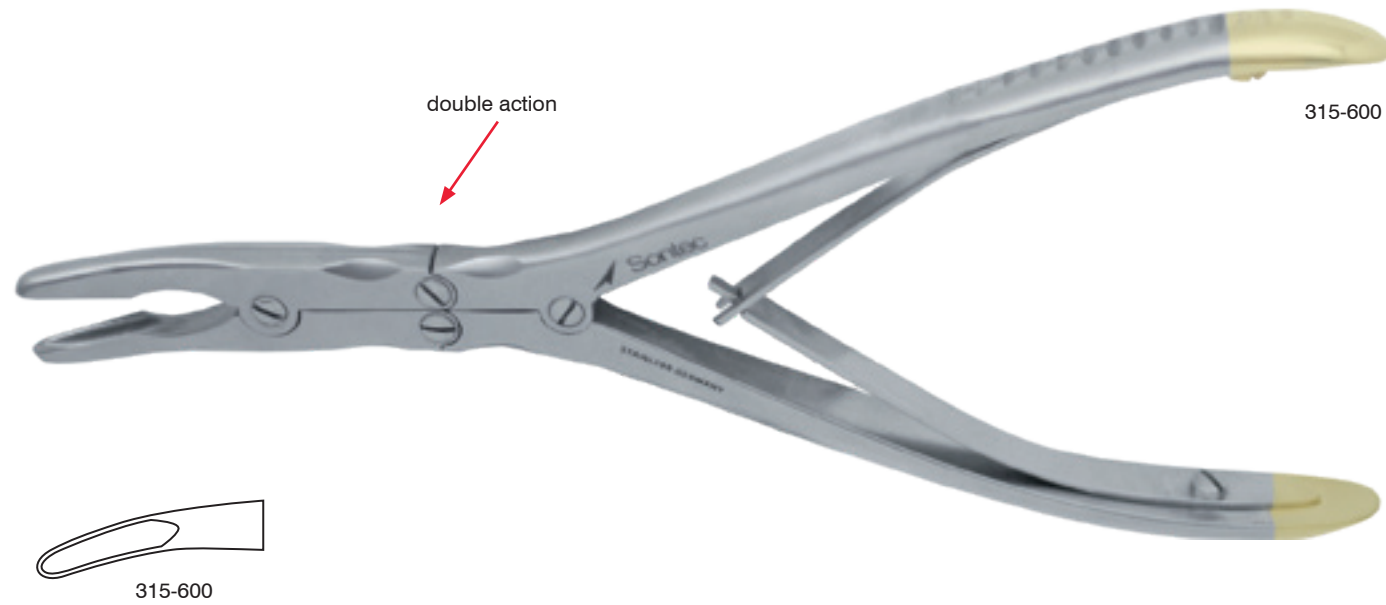

Smith-Peterson Sontec Streamlined Laminectomy Rongeur

Unique delicate shape / modified model / double action / curved / 3 mm jaw / 7 1/2" (19 cm)

315-691



Smith-Peterson Laminectomy Rongeur

Stout model / 3 mm jaw / 7 1/2" (19 cm)

- 315-685 straight
- 315-689 slight curve
- 315-687 full curve

Standard / 3 mm jaw / 9 1/2" (24 cm)

- 315-686 straight
- 315-688 slight curve
- 315-690 full curve

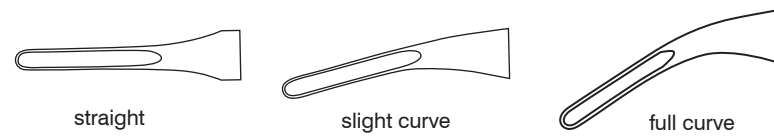

Leksell Duckbill Rongeur

Double action / curved to side / 9" (23 cm)

- 315-674 3 mm x 16 mm jaw
- 315-671 4 mm x 16 mm jaw
- 315-673 5 mm x 16 mm jaw
- 315-677 6 mm x 16 mm jaw
- 315-679 7 mm x 16 mm jaw
- 315-680 8 mm x 16 mm jaw

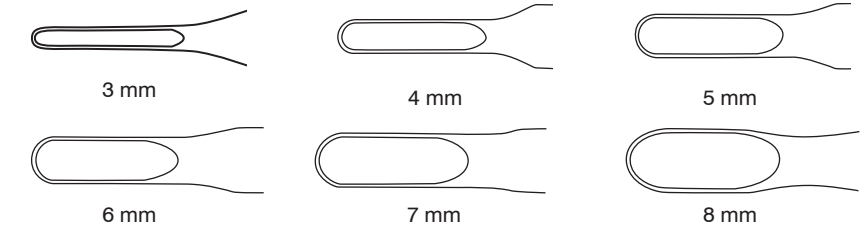

Double action / curved to side / full curve / 9" (23 cm)

- 315-676 3 mm x 16 mm jaw
- 315-672 4 mm x 16 mm jaw
- 315-675 5 mm x 13 mm jaw
- 315-678 6 mm x 16 mm jaw
- 315-681 7 mm x 16 mm jaw
- 315-682 8 mm x 16 mm jaw

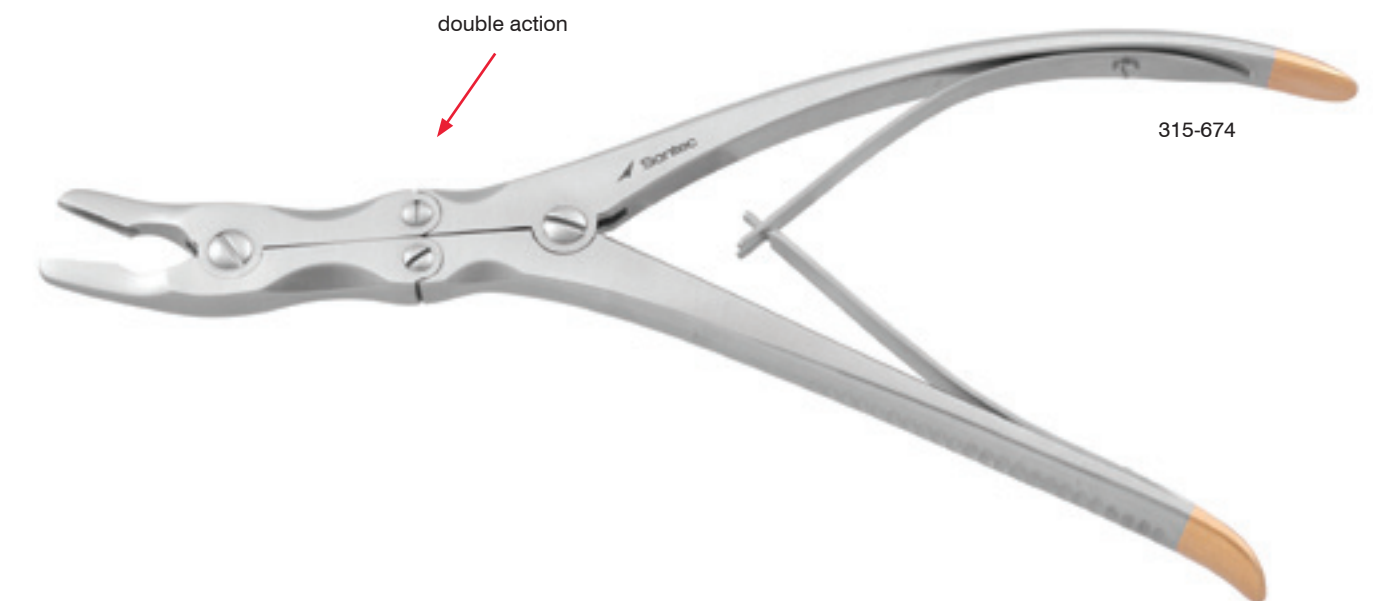
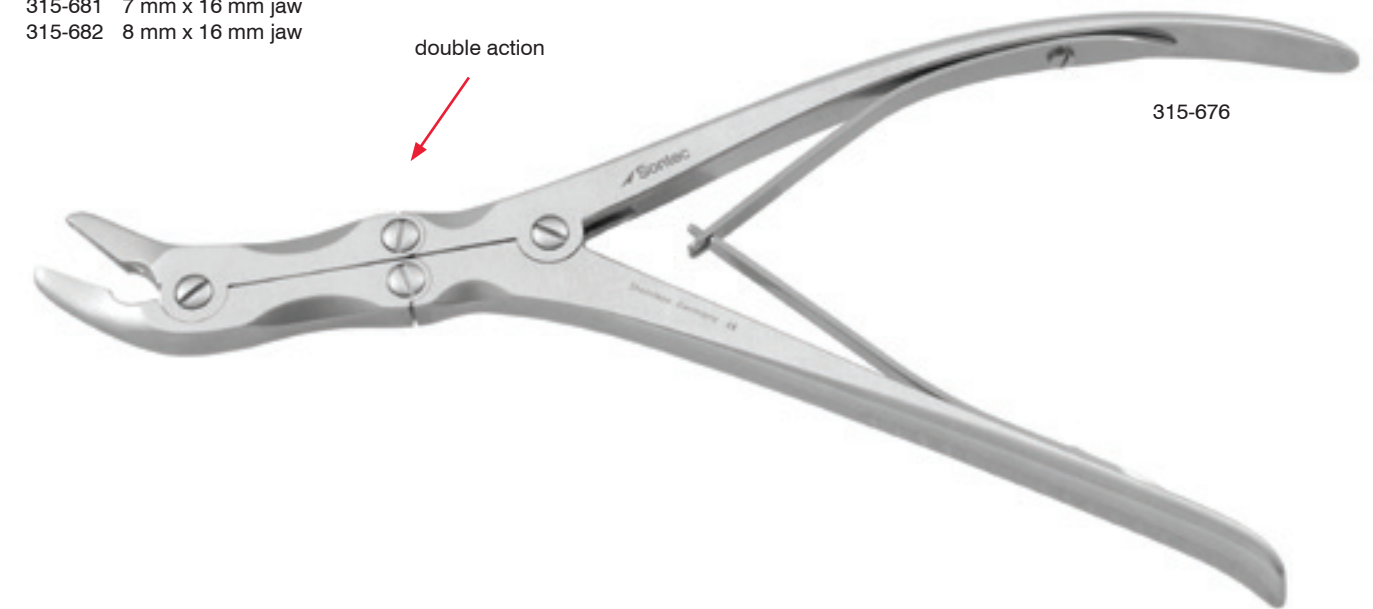

Marquardt Neuro Rongeur

Unique delicate shape / curved / double action / 2 mm jaw / 7 3/4" (19.7 cm)

315-697



315-697

Leksell Bayonet Rongeur

4 mm jaw / 8 3/4" (22 cm)

315-669 left
315-670 right

4 mm jaw / ceramic coated / 8 3/4" (22 cm)

315-669B left
315-670B right



315-670B

Echlin Duckbill Rongeur

Double action / curved to side / 9" (23 cm)

315-657 2 x 12mm bite
315-659 3 x 12mm bite
315-661 4 x 12mm bite

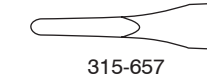

315-657

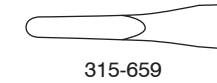

315-659

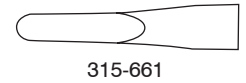

315-661

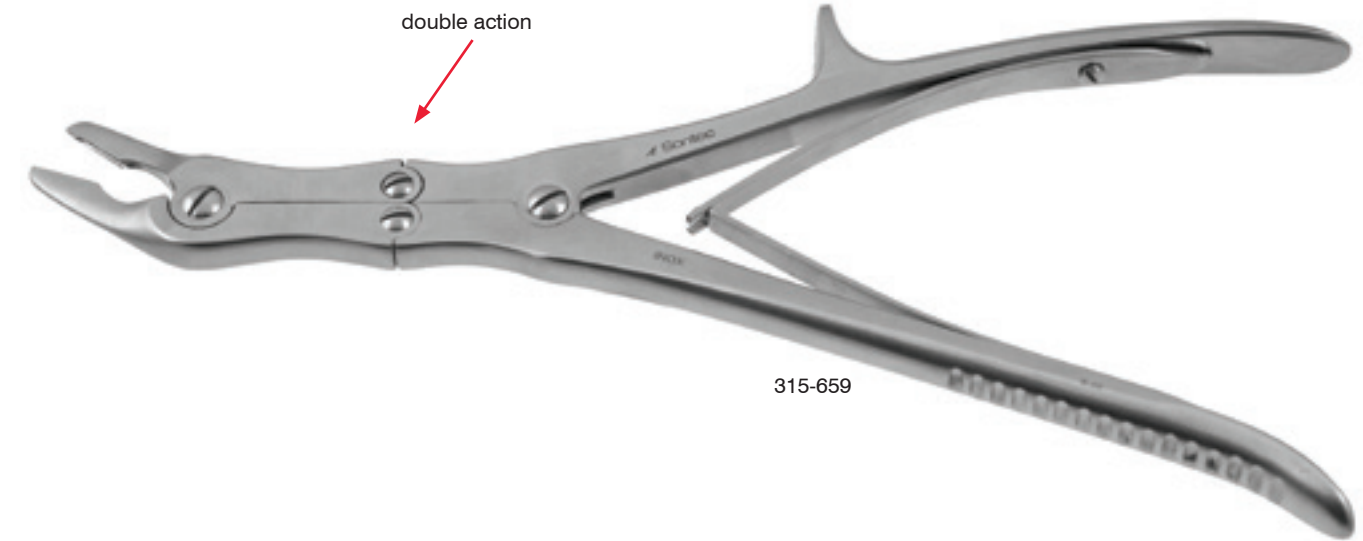

double action

315-659



315-661

Stille-Luer Rongeur

Double-action / 10 mm x 22 mm jaw

- 315-640 str 8 3/4" (22.2 cm)
- 315-642 cvd 8 3/4" (22.2 cm)
- 315-646 str 10 1/2" (26 cm)
- 315-648 cvd 10 1/2" (26 cm)

**Double-action / 10 mm x 16 mm jaw
/ curved to the side**

- 315-653 8 3/4" (22.2 cm)

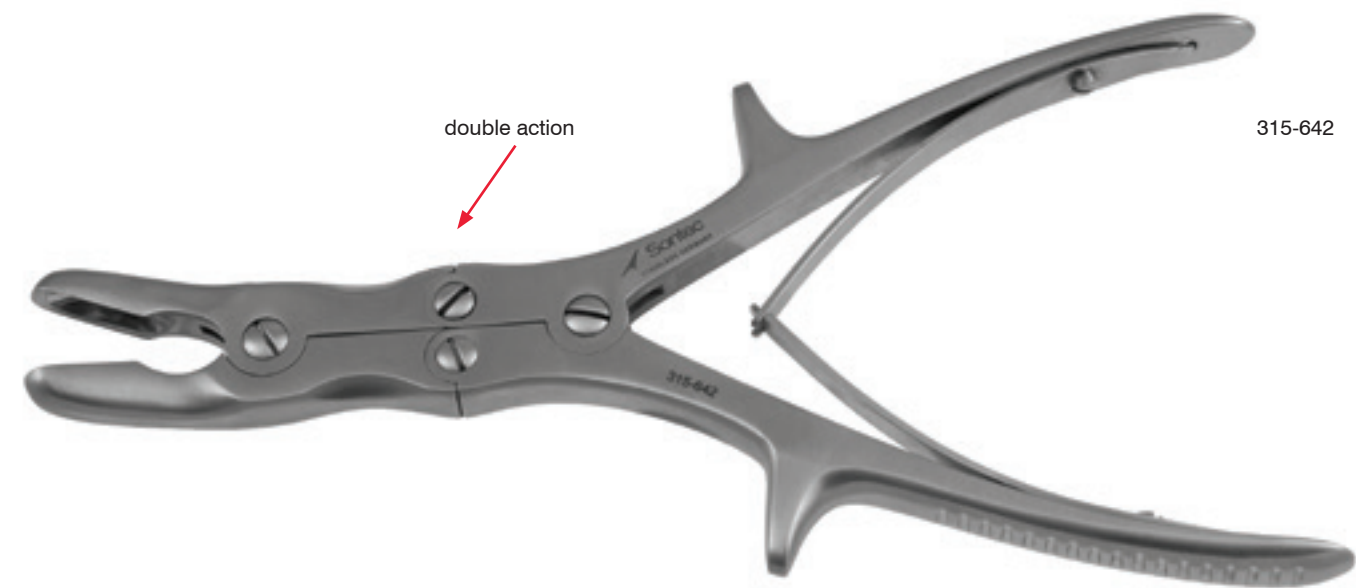
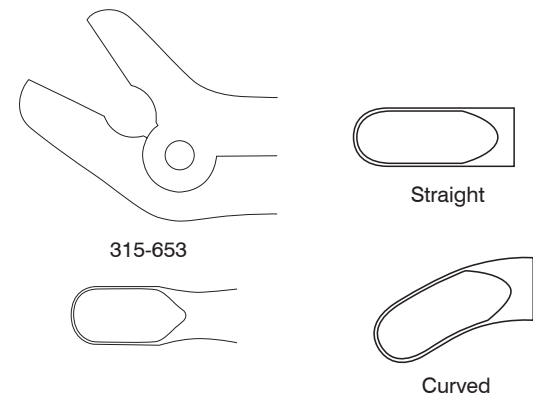

Stille-Luer Rongeur

**Double-action / 17 mm x 22 mm jaw
/ 8 1/2" (21.6 cm)**

- 315-649 str
- 315-650 cvd

**Double-action / 17 mm x 25 mm jaw
/ 10 1/2" (26.7 cm)**

- 315-651 str
- 315-6512 cvd



315-649

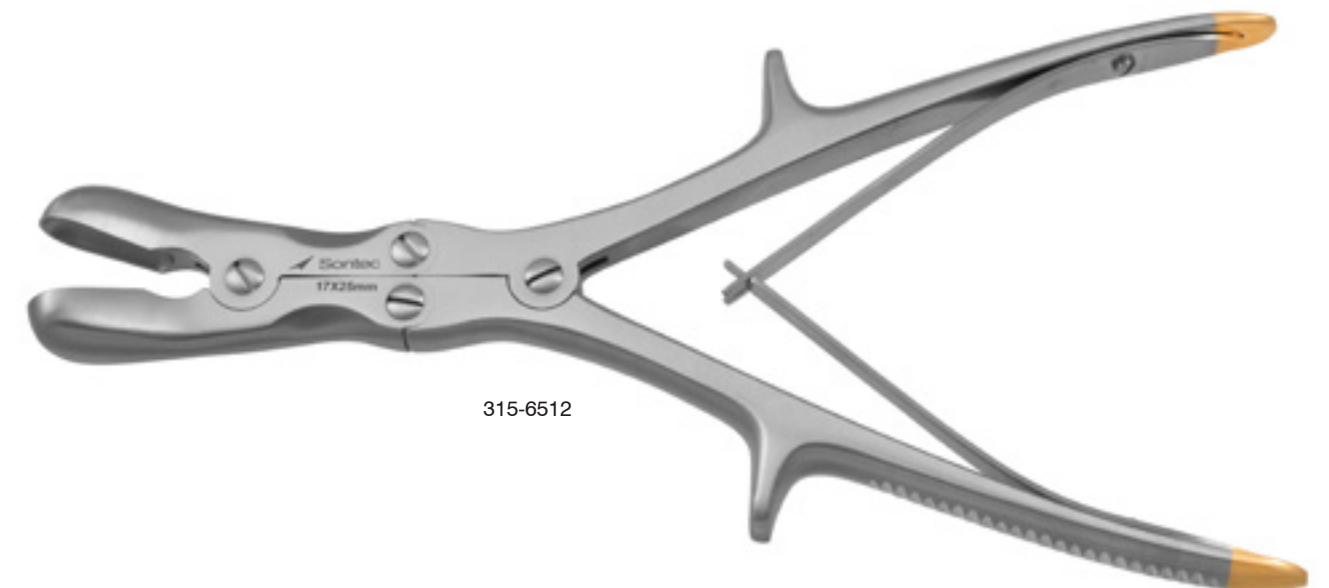

315-6512

Stille-Luer Duckbill Rongeur

Double-action / curved to side / 6 x 16 mm bite / 9" (22.9 cm)

- 315-652 standard
- 315-652B black coated

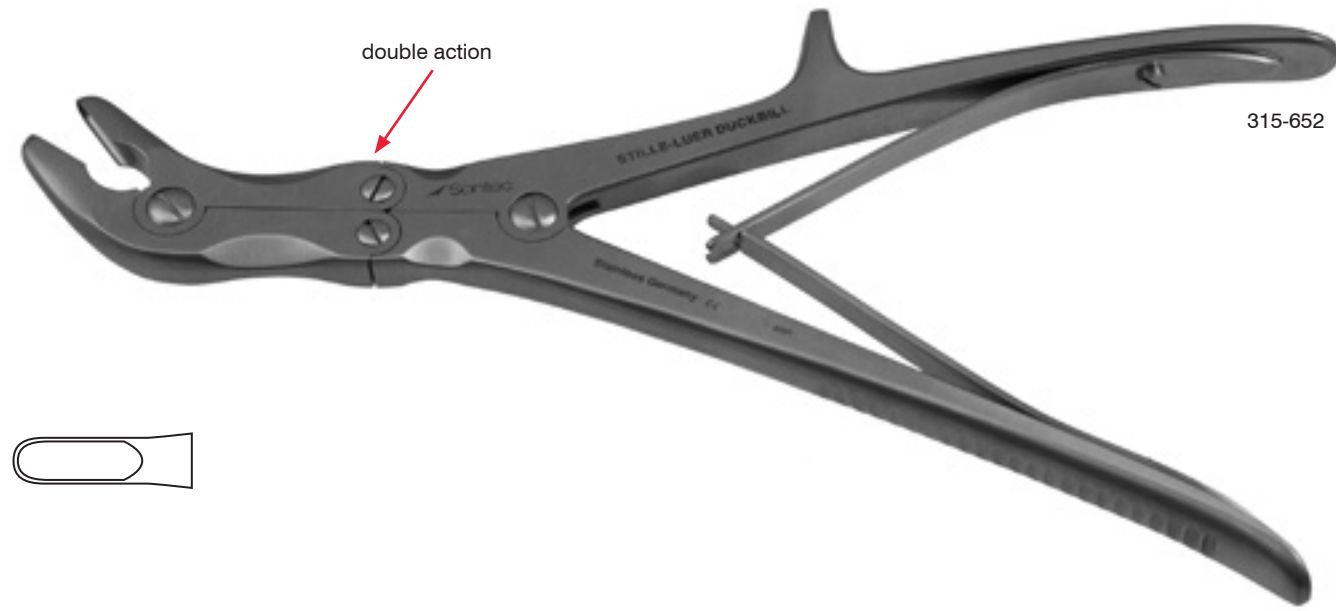

315-652

Semb Bone Rongeur

17 mm x 14 mm bite / 9" (22.9 cm)

- 315-639



315-639

Stille-Luer Echlin Duckbill Rongeur

Double action / curved to side / 6 x 15mm bite / 9" (23 cm)

315-664

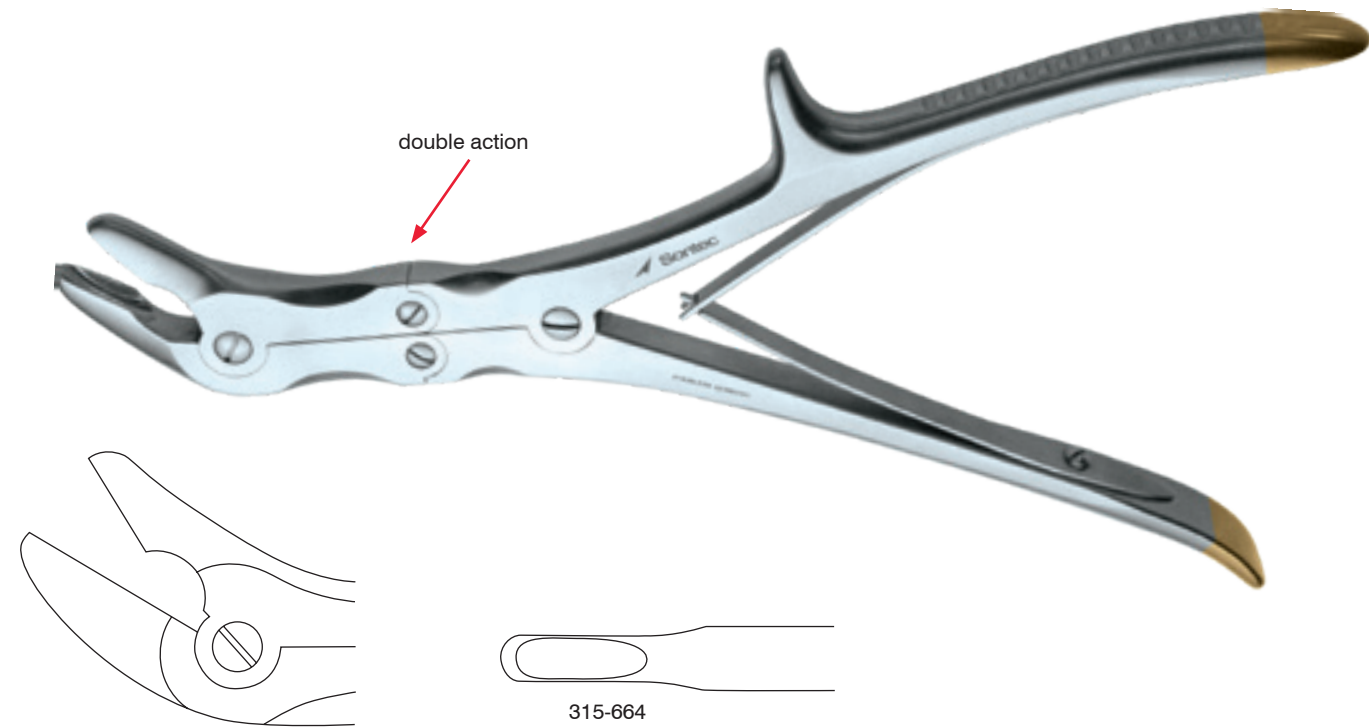

Stille-Luer Echlin Duckbill Bayonet Rongeur

Double angle jaw / 5 mm / right / 9" (23 cm)

315-655



Leksell Extended Bone Rongeur

Light curve / 5 mm jaw / 15 3/4" (40 cm)

1100-549



Sypert Extended Rongeur

Curved only / 14" (35.5 cm)

- 1100-557B 4 x 16mm bite
- 1100-557 5 x 16mm bite
- 1100-557C 8 x 16mm bite
- 1100-557D 12 x 16mm bite

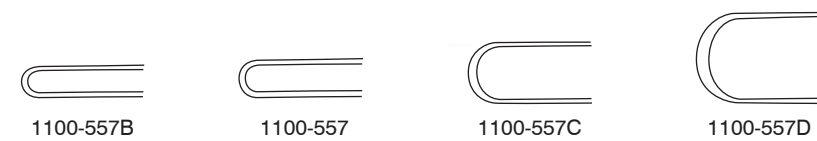



 Sontec Instruments®

Orthopedic SINGLE ACTION RONGEURS

Mini Neuro Rongeur

5 1/2" (14 cm)

- 1106-080 str 0.75 mm jaw
- 1106-082 cvd 0.75 mm jaw
- 1106-084 str 1.0 mm jaw
- 1106-086 cvd 1.0 mm jaw
- 1100-577S str 1.3 mm jaw
- 1100-577 cvd 1.3 mm jaw



1100-576

1.4 mm jaw / 6" (15 cm)

- 1100-574 str
- 1100-576 cvd

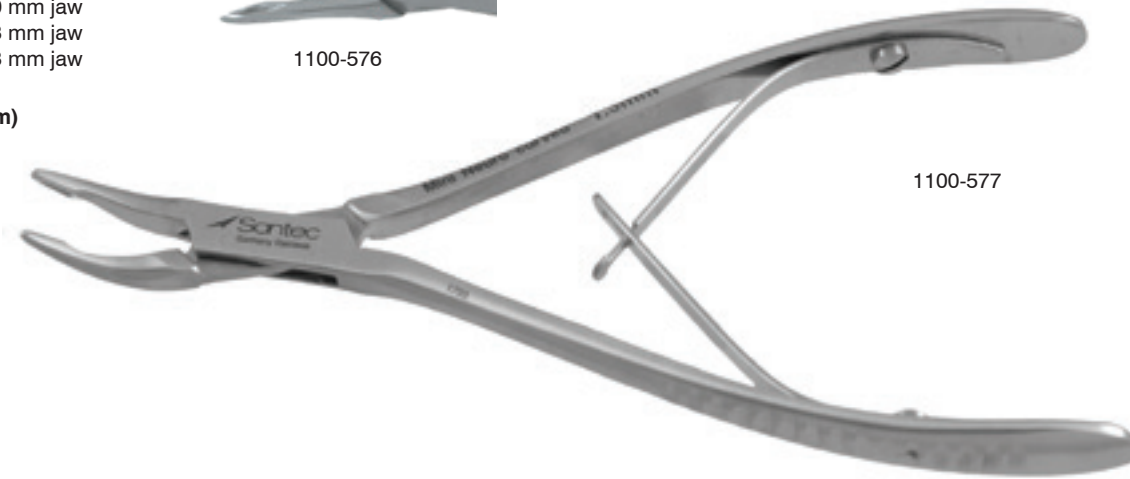

1100-577

Mini Neuro Premier Rongeur

0.5 mm tip / 5 1/2" (14 cm)

- 1106-091 str
- 1106-092 cvd



1106-091



1106-092

Micro Friedman Ring Handle Rongeur

5 1/2" (14 cm)

- 1106-076 1.3 mm straight
- 1106-077 1.3 mm curved
- 1106-078 1.3 mm full curved
- 1106-079 2.0 mm curved
- 1106-0791 2.0 mm full curved



1106-077



1106-078



1106-079



1106-0791

Kleinert-Kutz Rongeur

2 mm x 6 mm jaw / 5 1/4" (13 cm)

- 315-581 slight curve
- 315-580 full curve



315-581



315-581



315-580

Micro Friedman Rongeur

1.5 mm x 5 mm jaw / 5 1/2" (14 cm)

- 315-505S str
- 315-505C 30° angle
- 315-505 90° angle



Mini Friedman Rongeur

2 mm x 8 mm jaw / 5 1/2" (14 cm)

- 1106-070 str
- 1106-075 cvd



Shearer Chickenbill Rongeur

Curved / 3 mm x 12 mm jaw

- 315-511 5 1/2" (14 cm)
- 315-513 6 1/2" (16.5 cm)
- 315-515 7" (18 cm)



Hakansson Rongeur

2.5 mm x 12 mm jaw / curved / 6 1/4" (16cm)

1103-230



Stellbrink Rongeur

2 mm x 8 mm jaw / 6 1/2" (16.5 cm)

- 315-566 slight curve
- 315-567 full curve



Classic Lempert Rongeur

2.5 mm x 10 mm jaw

- 315-542 straight 6 1/4" (16 cm)
- 315-544 curved 6 1/4" (16 cm)
- 315-548 straight 7 1/2" (19 cm)
- 315-550 curved 7 1/2" (19 cm)



* Additional Rongeurs available. Please call for styles, sizes & details



Sontec Lempert Rongeur

2.5 mm jaw / 6 1/2" (16.6 cm)

- 1100-542 straight
- 1100-544 curved



Jeurs Lempert Neuro Rongeur

Curved to side / 2.5 mm jaw / 7 1/2" (19 cm)

1100-578

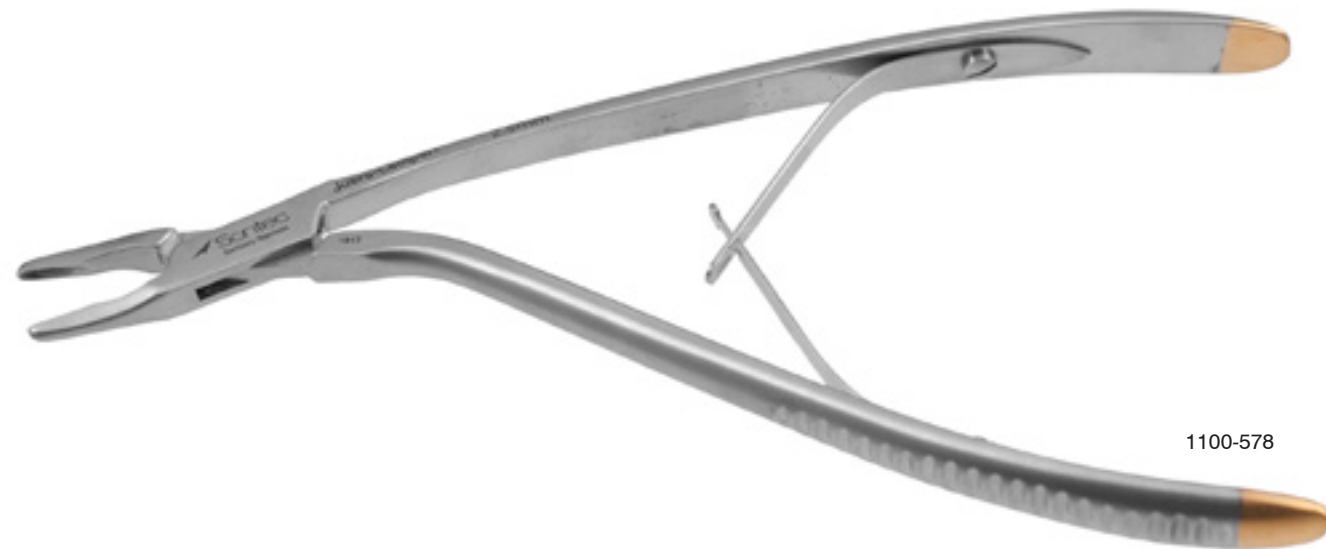

1100-578

Levesque Neuro Rongeur

Curved to side / low profile / extra delicate / 1.3 mm jaw / 7 1/2" (19 cm)

1100-578A

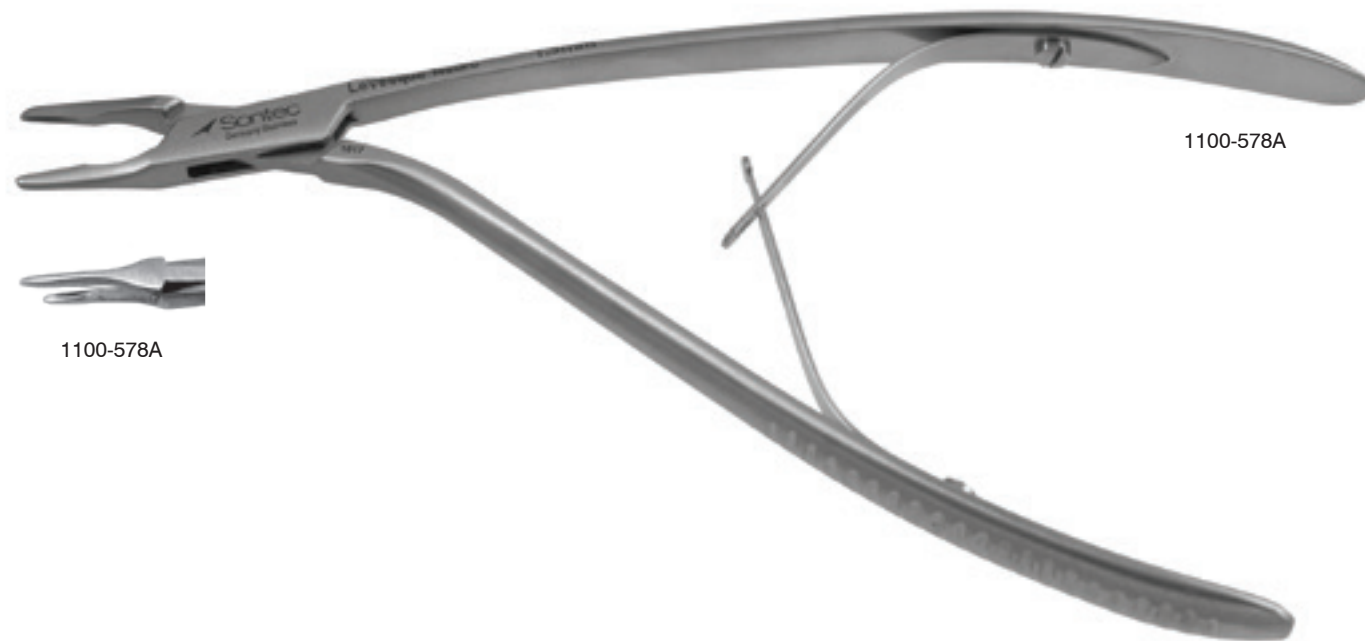

1100-578A

1100-578A

Cicherelli Rongeur

3 mm x 12 mm jaw / full curve / 6 1/2" (16.5 cm)

315-559



315-559

Cleveland Rongeur

Curved

315-526 5 1/2" (14 cm)

315-527 6 3/4" (17cm)



315-527

Bane Single Action Rongeur

Curved / 7" (17.8 cm)

315-538 small 4 mm bite
315-540 large 5 mm bite



315-540

Blumenthal Rongeur

Tapered jaw / delicate / 4 1/2" (11.5 cm)

315-500M 30° angle
315-501M 45° angle

Curved / 2.5 mm x 10 mm jaw / 6" (15 cm)

315-500 30° angle
315-501 45° angle

Curved / 2.5 mm x 10 mm jaw / 7" (15 cm)

315-499 30° angle



315-501M

Mead Rongeur

Curved / 4 mm x 15 mm jaw
/ 6 1/2" (16.5 cm)

315-495



315-495

Olivecrona Rongeur

3 mm x 18 mm jaw / curved / 8" (20.3cm)

315-630



315-630

Defourmental Rongeur

Straight / 7" (18 cm)

315-524



315-524

Bacon Duckbill Rongeur

Single-action / curved to side / 4.5 mm x 14 mm jaw / 8" (20 cm)

315-569



315-569

Hartman Rongeur

4.5 mm x 12 mm jaw / 5 3/4" (14.5 cm)

- 315-530 str
- 315-532 half curve
- 315-534 full curve



315-530



315-532



315-534



315-530



315-534

Cushing Rongeur

6 mm x 14 mm jaw / 8" (20.5 cm)

- 315-574 straight
- 315-576 curved

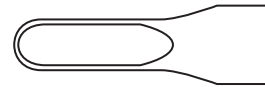

315-574



315-576

Serrated jaw / 6 mm x 14 mm jaw / 8" (20.5 cm)

- 315-572 straight
- 315-573 curved



315-574



315-572

Adson Rongeur

7 mm x 15 mm bite / 8" (20 cm)

- 315-564 straight
- 315-565 curved to side



315-565



315-564





 Sontec Instruments®

RASPS

Double-Ended Rasp

Single-sided / 7" (18 cm)

1103-224



1103-224

Sontec® Fomon Rasp

Double-ended / four-sided / 8 1/2" (21.5 cm)

- 1100-492 straight
- 1100-492A straight fine
- 1100-492B one end concave
- 1100-492C one end convex



1100-492



1100-492A



1100-492B

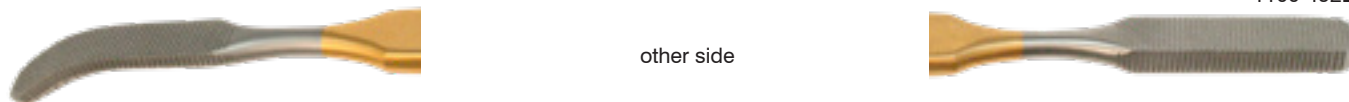

other side



1100-492C

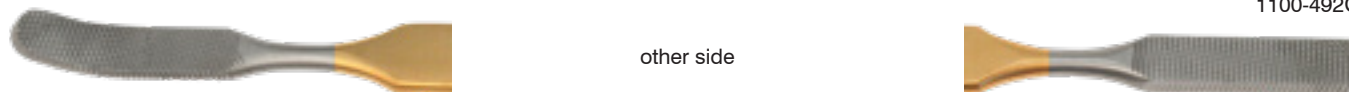

other side

Fomon Rasp

Double ended / single-sided / 8 1/2" (21.5 cm)

- 1100-492F straight
- 1100-492G one side concave
- 1100-492D one side convex



1100-492F



1100-492G

Foman TC Insert Rasp

TC / double-ended / single-sided / 8 1/2" (21.5 cm)

- 345-289 9 / 10
- 345-287 7 / 8
- 345-285 5 / 6
- 345-283 3 / 4
- 345-281 1 / 2



345-289

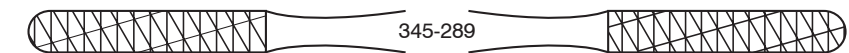

345-289

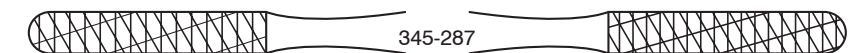

345-287

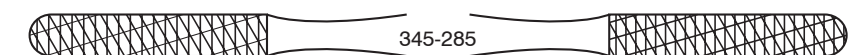

345-285

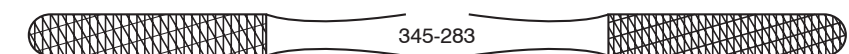

345-283

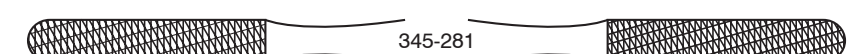

345-281

Foman TC Insert Rasp Angled

TC / double ended / single sided / angled

- 345-281A 1 / 2
- 345-283A 3 / 4
- 345-285A 5 / 6
- 345-287A 7 / 8
- 345-289A 9 / 10



345-281A



345-283A



345-285A



345-287A



345-289A

Foman Rasp

Serrated / double ended / single sided / 8" (20.3 cm)

- 345-290 1 / 2
- 345-291 3 / 4
- 345-292 5 / 6
- 345-293 7 / 8
- 345-294 9 / 10



345-290



345-291



345-292



345-293



345-294

Foman Rasp

TC serrated / double ended / 9" (22.9 cm)

- 345-2951 #1
- 345-2952 #2
- 345-2953 #3
- 345-2954 #4
- 345-2955 #5
- 345-2956 #6
- 345-2957 #7
- 345-2958 #8
- 345-2959 #9
- 345-2950 #10



Foman "R" Rasp

Double ended / TC / 8
1/4" (21 cm)
345-279



Polokoff Bone Rasp Double-Ended Single-Sided

1103-241 5.5 mm / 6 mm 8"
1103-242 3 mm / 4 mm 7 1/2"



Howard Bone Rasp Double-Ended Single-Side

7 1/8"
1103-223 #12
1103-225 #12A
1103-226 #12CA



Miller Bone Rasp Double-Ended Single-Sided Serrated

7"
345-241 5 mm / 6 mm #33
345-242 3 mm / 4 mm #64
1103-233 6 mm / 7 mm #10

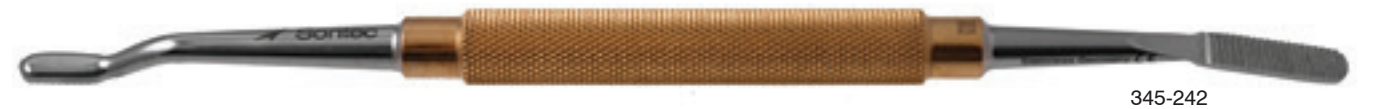

Miller Bone Rasp Double-Ended Single-Sided

7 1/2"
1103-229 6 mm / 7 mm #45



Miller Rasp

Concave / single
ended / TC / 8"
(20.25 cm)
345-305



Sontec-Miller TC Insert Rasp

Double-ended / TC / 7 1/8" (18.25 cm)
345-300 serrated
345-302 cross-serrated



Miller Cross Serrated Rasp

Double-ended / cross-serrated / up & down rasping / 7 1/8" (18.25 cm)

- 1103-232 4 mm & 4 mm wide
- 1100-490C 5 mm & 6 mm wide
- 1103-225C 5 mm & 7 mm wide
- 1100-491 6 mm & 7 mm wide

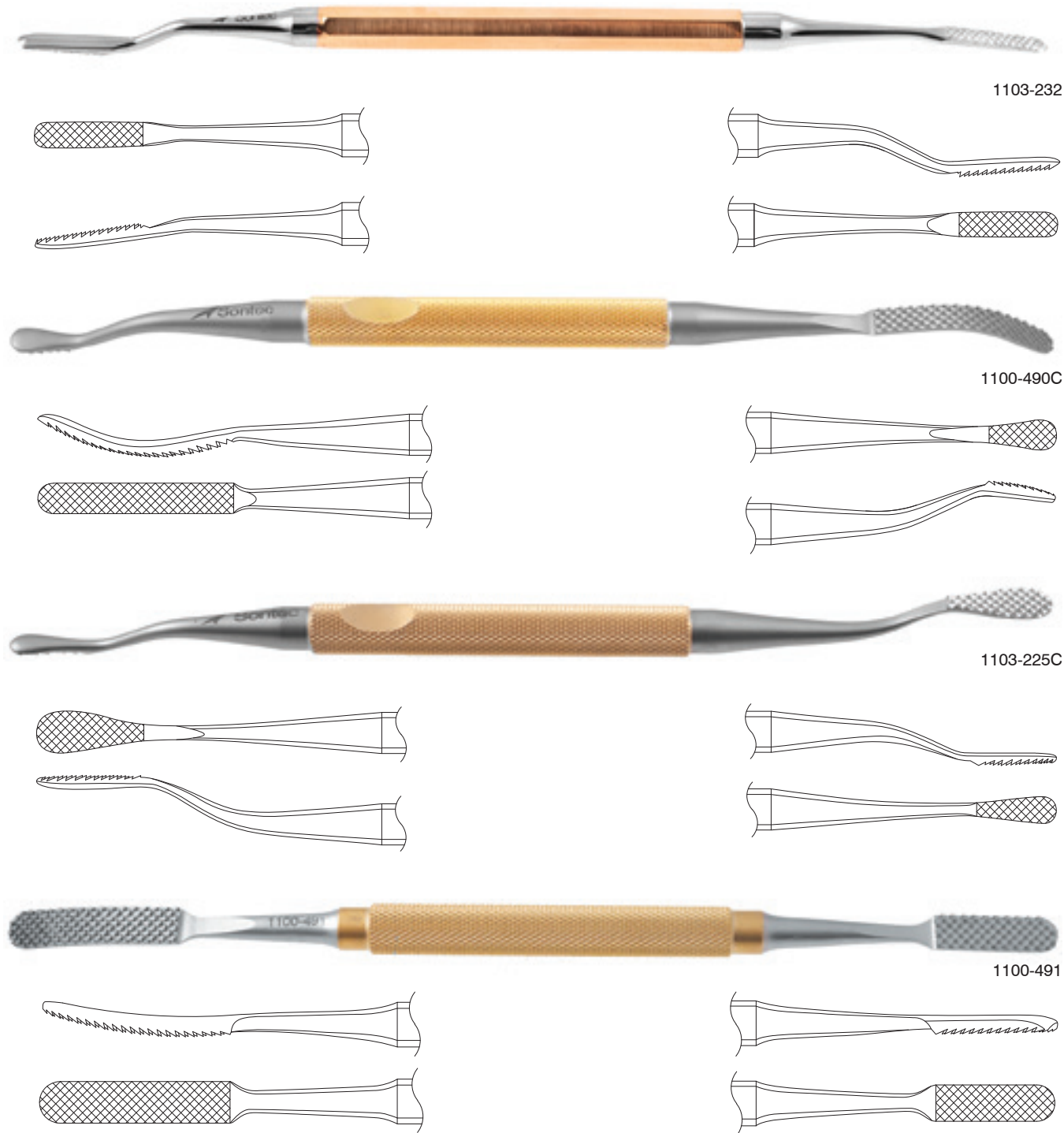

Miller Parallel Serrated Rasp

Double-ended / regular cut / down rasping / 7 1/8" (18.25 cm)

- 1103-228 4 mm & 4 mm wide
- 1100-490 5 mm & 5 mm wide
- 1103-238 5 mm & 7 mm wide
- 1103-236 5 mm & 8 mm wide
- 1103-237 6 mm & 7 mm wide

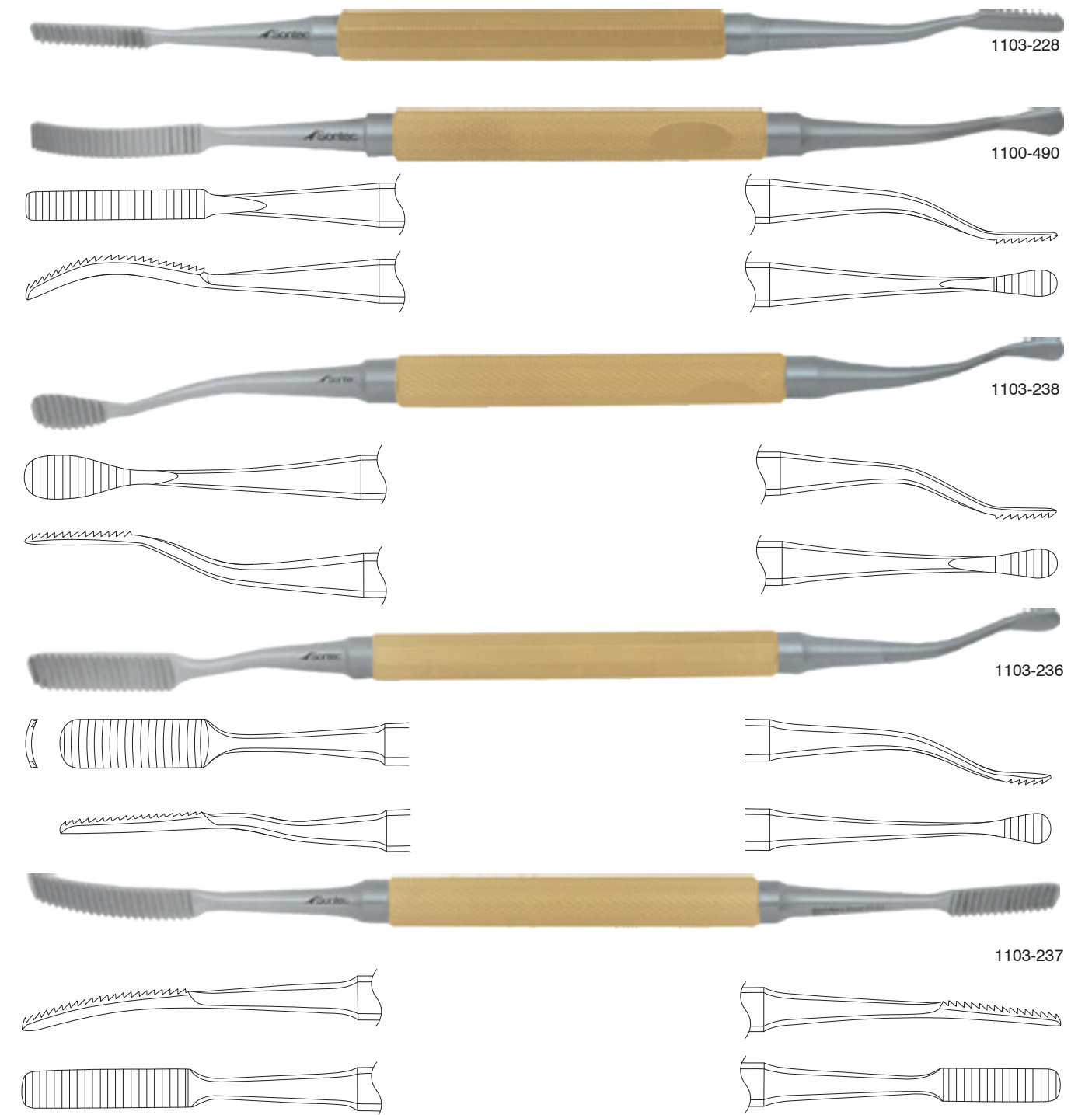

Sontec Micro Rasp

Single-ended / double-sided / 5 1/2" (14 cm)

- 345-265 straight 2.1 mm x 30 mm x 1 mm
- 345-264 curved 3.2 mm x 30 mm x 2.5 mm

Single-ended / single-sided / special order

- 345-266 5 1/2" (14 cm) 3 mm x 30 mm x 2.0 mm
- 345-267 7" (18 cm) 3 mm x 30 mm x 2.0 mm



345-265



345-264



345-267

Nail Rasp

Single-sided /

6 3/4" (17 cm)

- 345-243



345-243

Maltz Single-Ended Rasp

Single-sided / 7" (18 cm)

- 345-310 reverse
- 345-311 forward cut



345-310 (reverse)



345-311 (forward cut)



345-310



345-311

Rhinoplasty Rasp

Straight / 7 3/4" (20 cm)

- 345-312 teeth down
- 345-314 teeth up



345-312



345-314

Maltz Improved Double Ended Rasp

Single-sided / up & down rasping / 8 1/4" (21 cm)

- 1103-235



1103-235

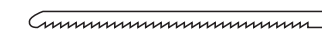

McCollough Twist Fomon Raspatory

Double-Ended-Single-Ended / TC / 8 1/2" (21.6 cm)

- 345-350 #2/3
- 345-352 #4/6



345-352

Putti Bone Rasp

- 345-220 leaflet / leaflet 10 1/2" (26.7 cm)
- 345-218 conical / leaflet 12" (30.5 cm)



345-218

Putti Bone Rasp

Round blade / T-handle / 12" (30.5 cm)

345-224



345-224

Putti Bone Rasp

Single-ended / phenolic handle

345-226 leaflet 9 3/4" (24.8 cm)

345-228 conical 10" (25.4 cm)



345-226



345-228

Single Side Rasp

8" / phenolic handle / flat

345-222 straight 0.5" x 1.5" tip



345-222

Combination Bone Rasp

With 3 interchangeable heads

1100-485-SET

set includes the following:

- 1100-485 combination bone rasp handle only
- 1100-4851 combination bone rasp round tip only
- 1100-4852 combination bone rasp putti leaflet only
- 1100-4853 combination bone rasp flat round tip only



1100-485



1100-4851

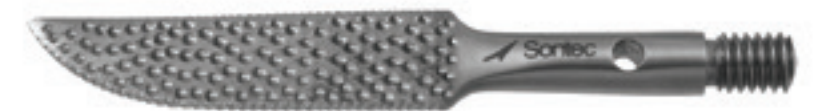

1100-4852



1100-4853

Gallaher Bone Rasp Set

7 1/8" (18.25 cm)

- 77-0450 str
- 77-0451 convex curve
- 77-0452 concave curve

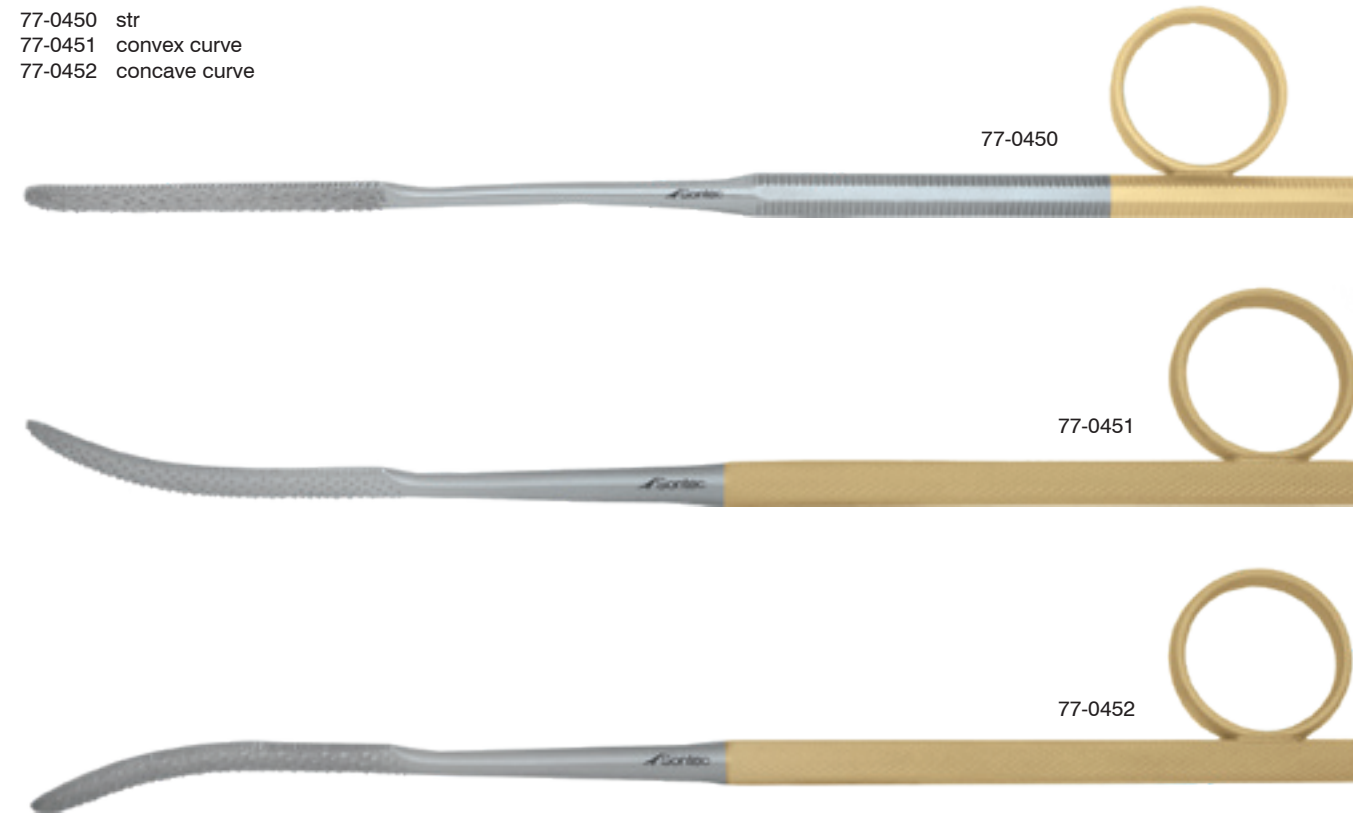

Good Bone Rasp

Conical / 6 1/2" (16.5 cm)

- 345-263 straight
- 345-262 curved

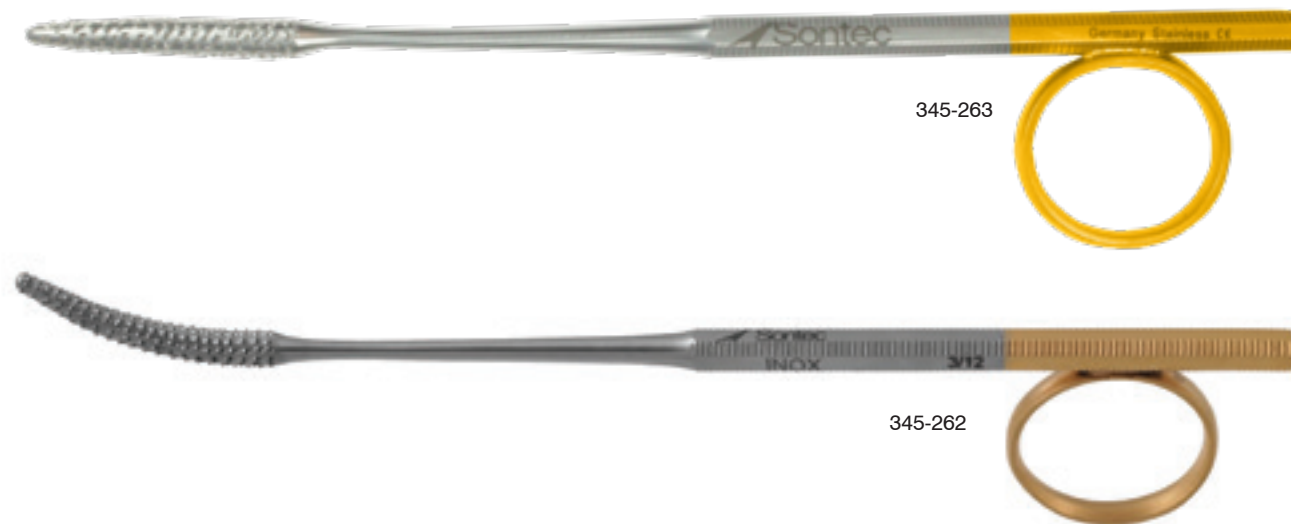

Sontec Ear Rasp Set

Serrated / 6" (15.2 cm)

- 475-596 curved left
- 475-598 curved right

7 1/4" (18.5 cm)

- 475-610 curved right
- 475-605 curved right serrated
- 475-600 curved left serrated
- 475-615 set of all three

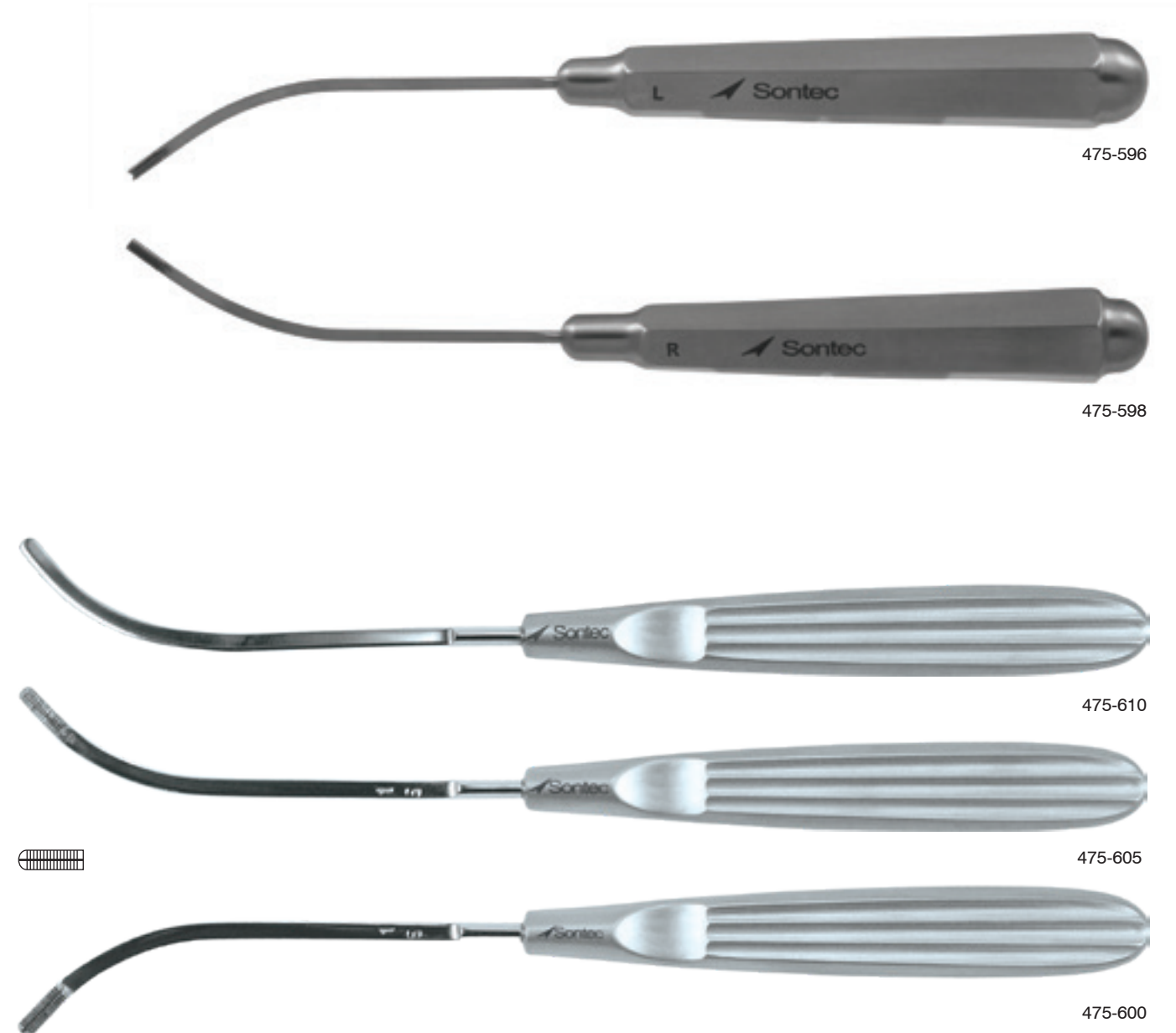

Kistler Ear Cartilage Rasp

Curved / 6 1/2" (16.5 cm)

475-618L left
475-618R right



475-618L



475-618R

Glabella Masing Rasp

TC / 7 3/4" (19.5 cm)

345-340



345-340

Sontec Glabella Pull Push Curved Tip Rasp

Single-ended / curved / 7 1/2" (19 cm)

345-342 teeth cut down pull
345-344 teeth cut up push



345-342



345-344

Sontec Patella Raspatory

#4 / TC insert / 7 1/8" (18 cm)

345-247



345-247

Masing Rasp

Single ended / straight
/ TC / 7 3/4" (19.5 cm)

345-289R course
345-338 fine



345-289R



345-338

Sontec Diamond Surface Rasp

7 3/8" (18 cm)

345-345 straight
345-346 curved



345-345



345-346

Obwegeser Fenestrated Serrations Rasp

Double-ended / flat, straight / infinity cut / 7 1/2" (19 cm)

- 345-320 fine grit
- 345-322 medium grit



345-322

Double-ended / flat, curved / infinity cut / 7 1/2" (19 cm)

- 345-324 fine grit
- 345-326 medium grit



345-326

Double-ended / concave / infinity cut / 7 1/2" (19 cm)

- 345-330 fine grit
- 345-332 medium grit



345-332

Sontec®-Glabella Sculpting TC Insert Rasp

TC / 7" (18 cm)

- 345-246



345-246

Webster Glabella Sculpting Rasp

TC serrated tip / 4 mm x 8 mm / 8 1/4" (21 cm)

- 345-246A



345-246A

Obwegeser Solid Fine Grit Nasal Rasp

Double-ended / 7 1/2" (19 cm)

- 345-320S straight
- 345-324S curved



345-320S



345-324S

Sontec Spinal File/Rasp

Phenolic handle / TC / 10" (25.4 cm)
/ curved

345-270



345-270

Phenolic handle / cross-serrated /
straight / 6.5 mm / 15" (38 cm)

345-216



345-216

Black plastic handle / 6 mm

345-216B straight 15" (38.1 cm)

345-215B angled 14 1/2" (36.8 cm)



345-216B



345-215B

Long Handle File

Black plastic handle /
square file / 18" (45.7 cm)

320-591 straight

320-592 15° angle

Black plastic handle / round
file / straight / 18" (45.7 cm)

320-593



320-591



320-593



320-592

JPS Bone File

8 3/4" (22.2 cm)

345-217



back



front

345-217



 Sontec Instruments®

Headlights & Cameras

Sontec Elite Wireless LED Headlight

Includes: 2 batteries, sterilizable lever, universal transformer with adapters, lightweight carrying case, wireless LED headlight and operator manual

100-5500 LED 5500 30,000 lux output at 16" / 40 cm distance



Sontec Elite Wireless LED Headlight

Includes: 2 batteries, sterilizable lever, universal transformer with adapters, lightweight carrying case, wireless LED headlight and operator manual

100-9500 LED 9500 70,000 lux output at 16" / 40 cm distance



Sontec LED Plus+ Headlight

Up to 4.25 hours of runtime per battery / 10 - 100 mm @ 400 mm working distance of sport control / > 40,000 lux @ 30 cm of illumination / > 50,000 hours of LED Life / 3.6 hours for normal recharge time / 2 hours of quick recharge time for 3 hours of maximum intensity

Warranty
2 years on LED Headlight
1 year on Battery Pack
SIL-2410



Sontec Magnum LED Headlight

12 oz./350 grams of battery and holster weight / 10 oz./300 grams of headlamp weight / 3 intensity levels of 30k lux, 50k lux & 70k lux, all @ 12"/30 cm / 75k lux of light output @ 12" / 2 hours, for 8 hours of maximum intensity for quick recharge time / 7 hours of continuous operation at Hi intensity for operating time / headband is lightweight comfortable with washable foam inserts

Warranty
2 years on LED Headlight
1 year on Battery Pack
SIL-2399



Sontec proCam 4K Micro Camera System

4k UHD, 30 fps video resolution / 8/13 mpx resolution still / 32 x 28 x 23 mm size without lens / 23 grams body weight ONLY / 3x built-in zoom / UHD video, high resolution, documentation for strength / USB 2 connection / standard 16 mm, Hi magnification 25 mm UHD, wide angle 12 mm and 8 mm lenses / compatible with Windows, Mac and Android

SIL-2480

*headlight sold separately



Index

| | | | | | |
|-----------------|-----|---------|---------|----------|-----|
| T136-688 | 134 | 16-2106 | 690 | 100-5500 | 778 |
| 9-15-450-02-SET | 460 | 16-2107 | 690 | 100-9500 | 779 |
| 9-15-452-02 | 460 | 16-2760 | 139 | 103-109 | 32 |
| 9-15-452-08 | 460 | 18-3120 | 15 | 103-110 | 32 |
| 9-15-452-12 | 460 | 18-3121 | 15 | 103-111 | 32 |
| 9-15-452-20 | 460 | 18-3122 | 15 | 103-115 | 33 |
| 9-15-460-02-SET | 460 | 18-3123 | 15 | 103-117 | 33 |
| 9-15-462-02 | 460 | 18-3209 | 23 | 103-119 | 33 |
| 9-15-462-07 | 460 | 18-3213 | 21 | 105-540 | 37 |
| 9-15-462-08 | 460 | 18-3214 | 21 | 105-541 | 37 |
| 9-15-462-09 | 460 | 18-3215 | 21 | 105-542 | 37 |
| 9-15-462-12 | 460 | 18-3270 | 23 | 105-543 | 37 |
| 9-15-462-13 | 460 | 18-3505 | 10 | 105-544 | 37 |
| 9-15-462-14 | 460 | 18-3510 | 10 | 105-550 | 37 |
| 9-15-462-15 | 460 | 18-3515 | 10 | 105-551 | 37 |
| 9-15-462-16 | 460 | 18-3519 | 10 | 105-552 | 37 |
| 9-15-462-17 | 460 | 18-3520 | 11 | 105-553 | 37 |
| 9-15-462-18 | 460 | 18-3525 | 11 | 105-570 | 37 |
| 9-15-462-19 | 460 | 18-3530 | 11 | 105-571 | 37 |
| 9-15-462-20 | 460 | 18-3560 | 14 | 105-572 | 37 |
| 9-15-462-21 | 460 | 18-3562 | 693 | 105-573 | 37 |
| 9-15-462-22 | 460 | 18-3564 | 16, 668 | 105-574 | 37 |
| 9-15-462-23 | 460 | 18-8301 | 56 | 105-575 | 37 |
| 9-15-462-24 | 460 | 19-1801 | 48 | 105-576 | 37 |
| 9-15-462-26 | 460 | 20-0847 | 236 | 105-577 | 37 |
| 9-15-462-27 | 460 | 20-0848 | 236 | 105-578 | 37 |
| 9-15-462-28 | 460 | 20-0871 | 236 | 105-579 | 37 |
| 12-9200 | 52 | 20-0874 | 236 | 105-580 | 37 |
| 12-9300 | 52 | 48-0339 | 479 | 105-581 | 37 |
| 12-9300D | 52 | 48-0340 | 479 | 105-590 | 37 |
| 12-9305 | 52 | 52-1301 | 486 | 105-600 | 37 |
| 12-9310 | 52 | 53-0510 | 712 | 105-602 | 37 |
| 12-9310D | 52 | 53-0512 | 712 | 105-610 | 37 |
| 12-9315 | 52 | 53-0514 | 712 | 105-612 | 37 |
| 12-9316 | 52 | 53-0516 | 712 | 105-614 | 37 |
| 12-9318 | 52 | 53-0518 | 712 | 105-616 | 37 |
| 12-9320 | 53 | 53-0520 | 712 | 105-618 | 37 |
| 12-9325 | 53 | 53-0522 | 712 | 105-620 | 37 |
| 12-9330 | 53 | 53-0524 | 712 | 105-622 | 37 |
| 12-9335 | 53 | 53-0526 | 712 | 105-624 | 37 |
| 12-9340 | 55 | 53-0528 | 712 | 105-626 | 37 |
| 12-9400 | 54 | 53-0530 | 712 | 105-628 | 37 |
| 12-9425 | 54 | 53-0532 | 712 | 105-630 | 37 |
| 12-9450 | 54 | 53-0534 | 712 | 105-632 | 37 |
| 12-9500 | 57 | 53-0536 | 712 | 105-640 | 37 |
| 12-9600 | 55 | 53-0538 | 712 | 105-642 | 37 |
| 12-9630 | 55 | 53-0542 | 712 | 105-644 | 37 |
| 14-6560 | 136 | 53-0544 | 712 | 105-646 | 37 |
| 14-6562 | 136 | 53-0546 | 712 | 105-650 | 37 |
| 14-6564 | 136 | 53-0552 | 712 | 105-652 | 37 |
| 16-2096 | 691 | 53-0554 | 712 | 105-654 | 37 |
| 16-2096B | 691 | 53-0556 | 712 | 105-656 | 37 |
| 16-2097 | 691 | 53-0560 | 712 | 105-660 | 37 |
| 16-2097B | 691 | 53-0562 | 712 | 105-662 | 37 |
| 16-2098 | 691 | 53-0564 | 712 | 105-664 | 37 |
| 16-2098B | 691 | 53-0566 | 712 | 105-666 | 37 |
| 16-2099 | 691 | 53-0574 | 712 | 105-670 | 37 |
| 16-2100 | 690 | 53-0582 | 712 | 105-672 | 37 |
| 16-2101 | 690 | 53-0584 | 712 | 105-674 | 37 |
| 16-2101B | 690 | 53-0590 | 712 | 105-676 | 37 |
| 16-2102 | 690 | 53-0592 | 712 | 105-686 | 37 |
| 16-2102B | 690 | 53-0594 | 712 | 105-688 | 37 |
| 16-2103 | 690 | 77-0450 | 768 | 105-690 | 37 |
| 16-2104 | 690 | 77-0451 | 768 | 105-692 | 37 |
| 16-2105 | 690 | 77-0452 | 768 | 105-694 | 37 |

| | | | | | |
|----------|----|----------|-----|----------|-----|
| 105-696 | 37 | 125-639 | 34 | 136-634 | 120 |
| 105-700 | 38 | 125-640 | 34 | 136-636 | 120 |
| 105-702 | 38 | 125-642 | 34 | 136-637 | 120 |
| 105-704 | 38 | 125-644 | 34 | 136-639 | 120 |
| 105-706 | 38 | 125-646 | 34 | 136-640 | 120 |
| 105-708 | 38 | 125-655 | 34 | 136-641 | 120 |
| 105-710 | 38 | 125-656 | 34 | 136-642 | 120 |
| 105-712 | 38 | 125-657 | 34 | 136-643 | 120 |
| 105-714 | 38 | 125-658 | 34 | 136-644 | 120 |
| 105-716 | 38 | 125-659 | 34 | 136-645 | 120 |
| 105-720 | 37 | 125-661 | 34 | 136-646 | 120 |
| 105-722 | 37 | 125-662 | 34 | 136-648 | 120 |
| 105-723 | 37 | 125-663 | 34 | 136-649 | 120 |
| 105-724 | 37 | 125-664 | 34 | 136-650 | 120 |
| 105-725 | 37 | 125-666 | 34 | 136-652 | 120 |
| 105-726 | 37 | 125-667 | 34 | 136-653 | 120 |
| 105-727 | 37 | 125-668 | 34 | 136-659 | 136 |
| 105-730 | 36 | 125-669 | 34 | 136-659D | 136 |
| 105-732 | 36 | 125-670 | 34 | 136-660 | 131 |
| 105-734 | 36 | 125-671 | 34 | 136-660A | 131 |
| 105-736 | 36 | 125-673 | 34 | 136-661 | 131 |
| 105-738 | 36 | 125-674 | 34 | 136-662 | 131 |
| 105-742 | 36 | 125-675 | 34 | 136-662T | 131 |
| 105-744 | 36 | 125-676 | 34 | 136-663 | 131 |
| 105-746 | 36 | 127-226 | 35 | 136-664 | 133 |
| 105-748 | 36 | 127-227 | 35 | 136-664D | 133 |
| 105-750 | 36 | 127-228 | 35 | 136-665 | 133 |
| 105-780 | 36 | 127-229 | 35 | 136-666 | 128 |
| 105-781 | 36 | 134-240 | 162 | 136-667 | 128 |
| 105-782 | 36 | 134-242 | 162 | 136-668 | 128 |
| 105-783 | 36 | 134-243 | 164 | 136-668A | 129 |
| 105-784 | 36 | 134-245 | 164 | 136-669 | 128 |
| 105-785 | 36 | 134-247 | 165 | 136-671A | 137 |
| 105-786 | 36 | 134-248 | 165 | 136-671B | 137 |
| 105-787 | 36 | 134-267 | 164 | 136-671C | 137 |
| 105-789 | 36 | 134-268 | 165 | 136-671D | 137 |
| 105-790 | 36 | 134-276 | 162 | 136-672 | 128 |
| 105-791 | 36 | 134-277 | 164 | 136-674 | 129 |
| 105-791A | 36 | 134-277M | 164 | 136-674D | 129 |
| 105-792 | 36 | 134-278 | 164 | 136-675 | 136 |
| 105-793 | 36 | 134-278M | 164 | 136-676 | 128 |
| 105-794 | 36 | 134-280 | 164 | 136-677 | 136 |
| 105-796 | 36 | 134-280M | 164 | 136-678 | 131 |
| 105-797 | 36 | 134-281 | 164 | 136-678L | 131 |
| 105-798 | 36 | 134-281M | 164 | 136-678P | 136 |
| 105-799 | 36 | 134-282A | 164 | 136-679 | 129 |
| 105-7951 | 36 | 134-282B | 164 | 136-679S | 131 |
| 117-555 | 49 | 136-578 | 123 | 136-680 | 126 |
| 117-559 | 46 | 136-580 | 123 | 136-682 | 128 |
| 117-560 | 45 | 136-590 | 124 | 136-682P | 128 |
| 117-561 | 45 | 136-600 | 122 | 136-683 | 128 |
| 117-564 | 45 | 136-602 | 122 | 136-684 | 126 |
| 117-566 | 45 | 136-605 | 122 | 136-686 | 135 |
| 117-576A | 47 | 136-607 | 122 | 136-686C | 135 |
| 117-577 | 44 | 136-610 | 122 | 136-686D | 135 |
| 117-578 | 44 | 136-612T | 117 | 136-687 | 135 |
| 117-582 | 45 | 136-613 | 122 | 136-688 | 135 |
| 117-583 | 47 | 136-615 | 122 | 136-688S | 135 |
| 117-585 | 48 | 136-616T | 117 | 136-688T | 134 |
| 117-588 | 48 | 136-617 | 122 | 136-689 | 135 |
| 117-593 | 48 | 136-619 | 122 | 136-690 | 109 |
| 117-594 | 49 | 136-621 | 120 | 136-691 | 109 |
| 117-602 | 49 | 136-624 | 120 | 136-692 | 109 |
| 117-5781 | 44 | 136-626 | 120 | 136-694 | 109 |
| 125-634 | 34 | 136-626F | 120 | 136-695 | 109 |
| 125-635 | 34 | 136-629 | 120 | 136-697 | 135 |
| 125-636 | 34 | 136-632 | 120 | 136-698 | 135 |
| 125-637 | 34 | 136-632B | 120 | 136-699 | 129 |
| 125-638 | 34 | 136-633 | 120 | 136-700 | 135 |

| | | | | | |
|-----------|----------|----------|-----|-------------|----------|
| 136-701 | 118 | 140-368 | 118 | 190-246 | 550 |
| 136-702 | 118 | 140-369 | 118 | 199-207 | 663 |
| 136-704 | 118 | 140-372 | 108 | 199-211 | 664 |
| 136-706 | 118 | 140-374 | 108 | 199-212 | 662 |
| 136-708 | 118 | 140-376 | 117 | 199-213 | 664 |
| 136-711 | 119 | 140-376B | 118 | 199-214 | 662 |
| 136-712 | 119 | 140-378 | 117 | 199-216 | 662 |
| 136-730 | 115 | 140-379 | 117 | 199-218 | 661 |
| 136-732 | 115 | 140-382 | 119 | 199-220 | 658 |
| 136-735 | 115 | 140-389 | 106 | 199-221 | 658 |
| 136-737 | 115 | 140-500 | 123 | 199-222 | 658 |
| 136-740 | 115 | 140-502 | 123 | 199-223 | 658 |
| 136-742 | 115 | 140-504A | 122 | 199-240 | 659 |
| 136-746 | 115 | 140-504B | 122 | 199-271 | 661 |
| 136-748 | 115 | 140-505T | 122 | 199-272 | 661 |
| 136-766 | 109 | 140-512 | 119 | 199-273 | 661 |
| 136-767 | 109 | 140-514 | 119 | 199-274 | 661 |
| 136-769 | 109 | 140-517 | 117 | 199-275 | 661 |
| 136-771 | 109 | 140-517G | 117 | 199-276 | 659 |
| 136-773 | 109 | 140-517M | 117 | 199-277 | 659 |
| 136-775 | 109 | 140-519 | 117 | 199-278 | 659 |
| 136-776 | 109 | 140-519G | 117 | 199-279 | 659 |
| 136-787 | 157 | 140-519M | 117 | 199-280 | 659 |
| 136-798 | 158 | 140-3032 | 130 | 199-282 | 663 |
| 136-801T | 501 | 140-3042 | 130 | 199-283 | 660 |
| 136-6508 | 120 | 140-3821 | 119 | 199-284 | 660 |
| 136-6621T | 131 | 142-103 | 110 | 199-365 | 126 |
| 136-6741 | 127 | 142-104 | 110 | 199-365S | 126 |
| 136-6861 | 133 | 142-106 | 110 | 199-365T | 126 |
| 136-6891 | 135 | 142-107 | 110 | 199-368 | 126 |
| 140-198 | 131 | 142-108 | 110 | 205-849 | 468, 470 |
| 140-201 | 132 | 142-110 | 110 | 205-849B | 468, 470 |
| 140-202 | 130 | 142-111 | 110 | 207-254 | 463 |
| 140-203 | 130 | 142-112 | 110 | 207-259 | 461 |
| 140-204 | 132 | 142-113 | 110 | 207-300 | 463 |
| 140-205 | 132 | 142-114 | 110 | 207-319-SET | 472 |
| 140-207 | 130 | 142-199 | 362 | 207-321 | 472 |
| 140-220 | 157 | 180-403 | 295 | 207-323 | 472 |
| 140-220B | 158 | 180-404 | 295 | 207-326 | 469, 471 |
| 140-222B | 158 | 180-404S | 294 | 207-328 | 469, 471 |
| 140-273 | 115 | 180-405 | 295 | 207-330 | 469, 471 |
| 140-297 | 132, 133 | 180-405S | 294 | 207-333 | 469, 471 |
| 140-297T | 126 | 180-406 | 295 | 207-338 | 469, 471 |
| 140-298 | 132 | 180-406S | 294 | 207-340 | 469, 471 |
| 140-298T | 126 | 180-407 | 295 | 207-342 | 469, 471 |
| 140-299 | 132 | 180-407S | 294 | 207-345 | 469, 471 |
| 140-301 | 132 | 180-408 | 295 | 207-350 | 473 |
| 140-302 | 129 | 180-408S | 294 | 207-352 | 473 |
| 140-302D | 129 | 180-409 | 295 | 207-354 | 473 |
| 140-302F | 129 | 180-409S | 294 | 207-356 | 473 |
| 140-302T | 127 | 180-410 | 295 | 207-358 | 472 |
| 140-303 | 130 | 180-410S | 294 | 207-360 | 472 |
| 140-303F | 129 | 180-411 | 295 | 207-362 | 472 |
| 140-304 | 130 | 180-411S | 294 | 207-364 | 472 |
| 140-304F | 130 | 180-412 | 295 | 207-389 | 464 |
| 140-304T | 126 | 180-412S | 294 | 207-390 | 464 |
| 140-305 | 130 | 180-420 | 312 | 207-391 | 464 |
| 140-305F | 130 | 180-422 | 311 | 207-405 | 478 |
| 140-306 | 130 | 180-424 | 311 | 207-411 | 465 |
| 140-307 | 130 | 180-427 | 312 | 207-413 | 465 |
| 140-309 | 130 | 180-432 | 309 | 207-415 | 465 |
| 140-350 | 118 | 180-433 | 309 | 207-454 | 466 |
| 140-352 | 118 | 180-436 | 309 | 207-455 | 466 |
| 140-354 | 118 | 180-439 | 309 | 207-456 | 466 |
| 140-358 | 118 | 180-440 | 309 | 207-460 | 466 |
| 140-360 | 118 | 180-447 | 310 | 207-461 | 466 |
| 140-362 | 118 | 180-448 | 310 | 207-462 | 466 |
| 140-364 | 118 | 180-449 | 310 | 207-463 | 466 |
| 140-366 | 118 | 180-451 | 310 | 207-464 | 466 |

| | | | | | |
|----------|-----|----------|-----|----------|-----|
| 207-465 | 466 | 305-370 | 335 | 315-616 | 724 |
| 207-466 | 466 | 305-370A | 335 | 315-619 | 724 |
| 207-467 | 466 | 305-370B | 335 | 315-620 | 726 |
| 207-468 | 466 | 305-380 | 332 | 315-621 | 724 |
| 207-469 | 466 | 305-460 | 333 | 315-622 | 725 |
| 207-470 | 466 | 305-465 | 333 | 315-630 | 749 |
| 207-471 | 466 | 305-470 | 333 | 315-639 | 735 |
| 207-472 | 466 | 305-475 | 333 | 315-640 | 732 |
| 207-473 | 466 | 305-480 | 333 | 315-642 | 732 |
| 207-474 | 466 | 305-485 | 333 | 315-646 | 732 |
| 207-482 | 465 | 305-496 | 334 | 315-648 | 732 |
| 207-484 | 465 | 305-497 | 334 | 315-649 | 733 |
| 207-486 | 465 | 305-910 | 163 | 315-650 | 733 |
| 207-488 | 465 | 310-160 | 462 | 315-651 | 733 |
| 207-490 | 465 | 310-171 | 475 | 315-652 | 734 |
| 214-052 | 467 | 310-173 | 475 | 315-652B | 734 |
| 220-114 | 457 | 310-174 | 475 | 315-653 | 732 |
| 220-126 | 459 | 310-176 | 475 | 315-655 | 736 |
| 220-128 | 459 | 310-177 | 474 | 315-657 | 731 |
| 220-130 | 459 | 310-178 | 474 | 315-659 | 731 |
| 220-132 | 459 | 310-179 | 474 | 315-661 | 731 |
| 220-136 | 459 | 310-180 | 474 | 315-664 | 736 |
| 220-138 | 459 | 310-182 | 474 | 315-669 | 730 |
| 220-140 | 459 | 315-495 | 749 | 315-669B | 730 |
| 220-220 | 458 | 315-505 | 742 | 315-670 | 730 |
| 220-222 | 458 | 315-505C | 742 | 315-670B | 730 |
| 220-224 | 458 | 315-505S | 742 | 315-671 | 729 |
| 230-337 | 277 | 315-511 | 743 | 315-672 | 729 |
| 230-338 | 277 | 315-513 | 743 | 315-673 | 729 |
| 230-347 | 278 | 315-515 | 743 | 315-674 | 729 |
| 230-352 | 276 | 315-524 | 750 | 315-675 | 729 |
| 230-354 | 276 | 315-526 | 747 | 315-676 | 729 |
| 230-357 | 276 | 315-527 | 747 | 315-677 | 729 |
| 230-360 | 276 | 315-530 | 751 | 315-678 | 729 |
| 230-365 | 275 | 315-532 | 751 | 315-679 | 729 |
| 230-371 | 266 | 315-534 | 751 | 315-680 | 729 |
| 230-372 | 266 | 315-538 | 748 | 315-681 | 729 |
| 230-373 | 266 | 315-540 | 748 | 315-682 | 729 |
| 230-374 | 267 | 315-542 | 745 | 315-685 | 728 |
| 230-375 | 267 | 315-544 | 745 | 315-686 | 728 |
| 230-376 | 268 | 315-548 | 745 | 315-687 | 728 |
| 230-378 | 268 | 315-550 | 745 | 315-688 | 728 |
| 230-405 | 264 | 315-559 | 747 | 315-689 | 728 |
| 230-406N | 265 | 315-564 | 753 | 315-690 | 728 |
| 230-406T | 265 | 315-565 | 753 | 315-691 | 727 |
| 230-445 | 273 | 315-566 | 744 | 315-697 | 730 |
| 230-480 | 270 | 315-567 | 744 | 315-752 | 657 |
| 230-486 | 270 | 315-569 | 750 | 315-754 | 657 |
| 230-4901 | 273 | 315-572 | 752 | 315-756 | 657 |
| 240-695 | 523 | 315-573 | 752 | 315-760 | 660 |
| 240-700 | 523 | 315-574 | 752 | 315-762 | 657 |
| 303-490 | 333 | 315-576 | 752 | 315-765 | 656 |
| 303-495 | 333 | 315-580 | 741 | 315-766 | 656 |
| 305-328 | 323 | 315-581 | 741 | 315-767 | 656 |
| 305-332 | 323 | 315-585 | 724 | 315-768 | 656 |
| 305-334 | 323 | 315-586 | 724 | 315-775 | 656 |
| 305-336 | 323 | 315-587 | 724 | 315-776 | 656 |
| 305-338 | 323 | 315-588 | 724 | 315-777 | 656 |
| 305-344A | 322 | 315-589 | 724 | 315-778 | 656 |
| 305-347 | 323 | 315-590 | 724 | 315-779 | 656 |
| 305-365 | 321 | 315-593 | 724 | 315-781 | 658 |
| 305-365M | 321 | 315-595 | 725 | 315-6512 | 733 |
| 305-366 | 321 | 315-597 | 727 | 320-580 | 539 |
| 305-367 | 321 | 315-598 | 727 | 320-581 | 539 |
| 305-367S | 321 | 315-599 | 727 | 320-582 | 539 |
| 305-368 | 321 | 315-600 | 726 | 320-583 | 539 |
| 305-368A | 321 | 315-610 | 724 | 320-584 | 539 |
| 305-369 | 321 | 315-612 | 724 | 320-585 | 539 |
| 305-369A | 321 | 315-614 | 724 | 320-586 | 539 |

| | | | | | |
|----------|----------|----------|-----|---------------|----------|
| 320-587 | 539 | 320-761 | 371 | 320-835T | 369, 530 |
| 320-588 | 539 | 320-778 | 370 | 320-836 | 367 |
| 320-589 | 539 | 320-779 | 370 | 320-837 | 367 |
| 320-590 | 539 | 320-780 | 370 | 320-838 | 367 |
| 320-591 | 260, 775 | 320-800A | 545 | 320-847 | 530 |
| 320-592 | 260, 775 | 320-800B | 545 | 320-848 | 367 |
| 320-593 | 260, 775 | 320-800C | 545 | 320-848T | 530 |
| 320-615 | 537 | 320-800D | 545 | 320-849 | 367 |
| 320-617 | 537 | 320-800E | 545 | 320-849T | 530 |
| 320-621 | 538 | 320-800F | 545 | 320-850 | 367 |
| 320-622 | 538 | 320-801A | 545 | 320-850T | 530 |
| 320-623 | 538 | 320-801B | 545 | 320-851 | 367 |
| 320-624 | 538 | 320-801C | 545 | 320-851T | 530 |
| 320-625 | 538 | 320-801D | 545 | 320-852 | 367 |
| 320-626B | 540 | 320-801E | 545 | 320-852T | 530 |
| 320-626G | 540 | 320-801F | 545 | 320-853 | 367 |
| 320-627B | 202 | 320-802A | 545 | 320-853T | 530 |
| 320-627G | 202 | 320-802B | 545 | 320-854 | 367 |
| 320-628B | 202 | 320-802C | 545 | 320-854T | 530 |
| 320-628G | 202 | 320-802D | 545 | 320-855 | 367 |
| 320-629B | 540 | 320-802E | 545 | 320-855T | 369 |
| 320-629G | 540 | 320-802F | 545 | 320-856 | 367 |
| 320-630B | 540 | 320-803A | 544 | 320-857 | 367 |
| 320-630G | 540 | 320-803B | 544 | 320-858 | 367 |
| 320-634T | 541 | 320-803C | 544 | 320-859 | 534 |
| 320-636T | 541 | 320-803D | 544 | 320-859A | 534 |
| 320-638 | 541 | 320-803E | 544 | 320-860 | 534 |
| 320-639 | 541 | 320-803F | 544 | 320-860-9-0 | 546 |
| 320-640 | 541 | 320-804A | 544 | 320-861 | 534 |
| 320-641 | 541 | 320-804B | 544 | 320-861-9-1 | 546 |
| 320-642 | 541 | 320-804C | 544 | 320-861A | 534 |
| 320-643 | 541 | 320-804D | 544 | 320-862 | 534 |
| 320-644 | 541 | 320-804E | 544 | 320-862-9-2 | 546 |
| 320-645 | 541 | 320-804F | 544 | 320-862A | 534 |
| 320-646 | 541 | 320-805A | 544 | 320-863 | 534 |
| 320-647 | 541 | 320-805B | 544 | 320-863-9-3 | 546 |
| 320-658 | 541 | 320-805C | 544 | 320-863A | 534 |
| 320-659 | 541 | 320-805D | 544 | 320-864 | 534 |
| 320-660 | 541 | 320-805E | 544 | 320-864-9-4 | 546 |
| 320-661 | 541 | 320-805F | 544 | 320-864A | 534 |
| 320-662 | 541 | 320-808 | 367 | 320-865 | 534 |
| 320-663 | 541 | 320-809 | 367 | 320-865-9-5 | 546 |
| 320-664 | 541 | 320-810 | 367 | 320-865A | 534 |
| 320-665 | 541 | 320-810P | 368 | 320-866 | 534 |
| 320-666 | 541 | 320-811 | 367 | 320-866-9-000 | 546 |
| 320-667 | 541 | 320-811P | 368 | 320-866A | 534 |
| 320-670 | 541 | 320-812 | 367 | 320-867-9-6 | 546 |
| 320-678 | 535 | 320-813 | 367 | 320-868-15-00 | 546 |
| 320-679 | 535 | 320-814 | 367 | 320-868-15-1 | 546 |
| 320-680 | 535 | 320-815 | 367 | 320-868B-15-6 | 546 |
| 320-681 | 535 | 320-816 | 367 | 320-869L | 532 |
| 320-682 | 535 | 320-817 | 367 | 320-869S | 532 |
| 320-683 | 535 | 320-818 | 367 | 320-870 | 369 |
| 320-684 | 535 | 320-826T | 530 | 320-870A | 369 |
| 320-685 | 535 | 320-827 | 367 | 320-871 | 369 |
| 320-686 | 535 | 320-827T | 530 | 320-871A | 369 |
| 320-687 | 535 | 320-829 | 367 | 320-872 | 369 |
| 320-708 | 366 | 320-829T | 530 | 320-872A | 369 |
| 320-709 | 366 | 320-830 | 367 | 320-873 | 369 |
| 320-710 | 366 | 320-830T | 530 | 320-873A | 369 |
| 320-711 | 366 | 320-831 | 367 | 320-874 | 369 |
| 320-712 | 366 | 320-831T | 530 | 320-874A | 369 |
| 320-713 | 366 | 320-832 | 367 | 320-875 | 369 |
| 320-714 | 366 | 320-832T | 530 | 320-875A | 369 |
| 320-715 | 366 | 320-833 | 367 | 320-876 | 369 |
| 320-716 | 366 | 320-833T | 530 | 320-876A | 369 |
| 320-717 | 366 | 320-834 | 367 | 320-877 | 369 |
| 320-718 | 366 | 320-834T | 530 | 320-877A | 369 |
| 320-760 | 371 | 320-835 | 367 | 320-878 | 369 |

| | | | | | |
|----------|-----|----------|-----|---------|-----|
| 320-878A | 369 | 320-922A | 535 | 330-500 | 386 |
| 320-879 | 532 | 320-922B | 535 | 330-511 | 386 |
| 320-881A | 536 | 320-922C | 535 | 330-512 | 386 |
| 320-881B | 536 | 320-923A | 535 | 330-513 | 386 |
| 320-881C | 536 | 320-923C | 535 | 330-514 | 386 |
| 320-881D | 536 | 320-924A | 532 | 330-515 | 386 |
| 320-882A | 536 | 320-924B | 532 | 330-516 | 386 |
| 320-882B | 536 | 320-932B | 535 | 330-517 | 386 |
| 320-882C | 536 | 320-936 | 520 | 330-518 | 386 |
| 320-882D | 536 | 320-940 | 371 | 330-519 | 386 |
| 320-883A | 536 | 320-941 | 371 | 330-530 | 386 |
| 320-883B | 536 | 320-942 | 371 | 330-531 | 386 |
| 320-883C | 536 | 320-944 | 371 | 330-532 | 386 |
| 320-883D | 536 | 320-946 | 371 | 330-533 | 386 |
| 320-884A | 543 | 320-948 | 371 | 330-534 | 386 |
| 320-884B | 543 | 320-950 | 370 | 330-535 | 386 |
| 320-884C | 543 | 320-951 | 370 | 330-536 | 386 |
| 320-884D | 543 | 320-952 | 370 | 330-537 | 386 |
| 320-884E | 543 | 320-953 | 370 | 330-538 | 386 |
| 320-884F | 543 | 320-954 | 370 | 330-539 | 386 |
| 320-885A | 543 | 320-955 | 370 | 330-550 | 392 |
| 320-885B | 543 | 320-958 | 533 | 330-551 | 392 |
| 320-885C | 543 | 320-959 | 533 | 330-552 | 392 |
| 320-885D | 543 | 320-960 | 533 | 330-553 | 392 |
| 320-885E | 543 | 320-962 | 533 | 330-554 | 392 |
| 320-885F | 543 | 325-130 | 18 | 330-555 | 392 |
| 320-886A | 543 | 330-001 | 400 | 330-556 | 392 |
| 320-886B | 543 | 330-002 | 400 | 330-557 | 392 |
| 320-886C | 543 | 330-003 | 400 | 330-558 | 392 |
| 320-886D | 543 | 330-004 | 400 | 330-559 | 392 |
| 320-886E | 543 | 330-005 | 400 | 330-570 | 392 |
| 320-886F | 543 | 330-010 | 400 | 330-571 | 392 |
| 320-887A | 542 | 330-011 | 400 | 330-572 | 392 |
| 320-887B | 542 | 330-012 | 400 | 330-573 | 392 |
| 320-887C | 542 | 330-013 | 400 | 330-574 | 392 |
| 320-887D | 542 | 330-014 | 400 | 330-575 | 392 |
| 320-887E | 542 | 330-015 | 400 | 330-576 | 392 |
| 320-887F | 542 | 330-016 | 401 | 330-577 | 392 |
| 320-888A | 542 | 330-017 | 401 | 330-578 | 392 |
| 320-888B | 542 | 330-018 | 401 | 330-579 | 392 |
| 320-888C | 542 | 330-020 | 385 | 330-590 | 386 |
| 320-888D | 542 | 330-021 | 385 | 330-591 | 386 |
| 320-888E | 542 | 330-022 | 385 | 330-592 | 386 |
| 320-888F | 542 | 330-023 | 385 | 330-593 | 386 |
| 320-889A | 542 | 330-024 | 385 | 330-594 | 386 |
| 320-889B | 542 | 330-030 | 385 | 330-595 | 386 |
| 320-889C | 542 | 330-031 | 385 | 330-596 | 386 |
| 320-889D | 542 | 330-032 | 385 | 330-597 | 386 |
| 320-889E | 542 | 330-033 | 385 | 330-598 | 386 |
| 320-889F | 542 | 330-034 | 385 | 330-599 | 386 |
| 320-896 | 547 | 330-035 | 385 | 330-600 | 386 |
| 320-897 | 547 | 330-100 | 401 | 330-601 | 386 |
| 320-898 | 547 | 330-105 | 401 | 330-602 | 386 |
| 320-899 | 547 | 330-110 | 401 | 330-603 | 386 |
| 320-900 | 547 | 330-120 | 401 | 330-604 | 386 |
| 320-901 | 547 | 330-125 | 401 | 330-605 | 386 |
| 320-902 | 547 | 330-130 | 401 | 330-606 | 386 |
| 320-903 | 547 | 330-135 | 401 | 330-607 | 386 |
| 320-904 | 547 | 330-450 | 57 | 330-608 | 386 |
| 320-910 | 547 | 330-452 | 57 | 330-609 | 386 |
| 320-911 | 547 | 330-454 | 57 | 330-610 | 390 |
| 320-912 | 547 | 330-456 | 57 | 330-611 | 390 |
| 320-913 | 547 | 330-460 | 387 | 330-612 | 390 |
| 320-914 | 547 | 330-462 | 387 | 330-613 | 390 |
| 320-915 | 547 | 330-464 | 387 | 330-614 | 390 |
| 320-916 | 547 | 330-466 | 387 | 330-615 | 390 |
| 320-917 | 547 | 330-468 | 387 | 330-616 | 390 |
| 320-918 | 547 | 330-470 | 387 | 330-620 | 391 |
| 320-920 | 534 | 330-472 | 387 | 330-621 | 391 |

| | | | | | |
|-----------|-----|--------------|-----|----------|----------|
| 330-622 | 391 | 330-792M | 398 | 335-207 | 377 |
| 330-623 | 391 | 330-792MB | 400 | 335-210 | 377 |
| 330-624 | 391 | 330-793M | 398 | 335-212 | 377 |
| 330-625 | 391 | 330-793MB | 400 | 335-226 | 379 |
| 330-626 | 391 | 330-794M | 398 | 335-250 | 380 |
| 330-630 | 384 | 330-794MB | 400 | 335-254 | 380 |
| 330-631 | 384 | 330-795M | 398 | 335-255 | 380 |
| 330-632 | 384 | 330-795MB | 400 | 335-260 | 380 |
| 330-633 | 384 | 330-796M | 398 | 335-265 | 380 |
| 330-634 | 384 | 330-796MB | 400 | 335-270 | 381 |
| 330-635 | 384 | 330-799-SET | 398 | 335-275 | 381 |
| 330-636 | 384 | 330-800M-SET | 398 | 335-280 | 381 |
| 330-640 | 384 | 330-801M | 398 | 335-285 | 381 |
| 330-641 | 384 | 330-802M | 398 | 335-320 | 201 |
| 330-642 | 384 | 330-803M | 398 | 335-322 | 201 |
| 330-643 | 384 | 330-804M | 398 | 335-324 | 201 |
| 330-644 | 384 | 330-805M | 398 | 335-325 | 201 |
| 330-645 | 384 | 330-806M | 398 | 335-326 | 201 |
| 330-646 | 384 | 330-807M | 398 | 335-326A | 201 |
| 330-650 | 384 | 330-808 | 405 | 335-326B | 201 |
| 330-651 | 384 | 330-811 | 406 | 335-326C | 201 |
| 330-652 | 384 | 330-814 | 406 | 335-326D | 201 |
| 330-653 | 384 | 330-814R | 406 | 335-326E | 201 |
| 330-654 | 200 | 330-817 | 405 | 335-327A | 201 |
| 330-654A | 200 | 330-818 | 408 | 335-327B | 201 |
| 330-655 | 200 | 330-819 | 405 | 335-327C | 201 |
| 330-655A | 200 | 330-823 | 412 | 335-327D | 201 |
| 330-656 | 200 | 330-824 | 407 | 335-327E | 201 |
| 330-656A | 200 | 330-824NH | 407 | 335-350 | 202 |
| 330-657 | 200 | 330-824S | 407 | 335-355 | 202 |
| 330-657A | 200 | 330-824SH | 407 | 335-360 | 202 |
| 330-658 | 200 | 330-827 | 412 | 335-380 | 525 |
| 330-658A | 200 | 330-832 | 410 | 335-390 | 524 |
| 330-660 | 393 | 330-833 | 408 | 335-391 | 524 |
| 330-661 | 393 | 330-834 | 409 | 335-392 | 524 |
| 330-662 | 393 | 330-835 | 409 | 335-393 | 524 |
| 330-663 | 393 | 330-839 | 410 | 335-396 | 524 |
| 330-664 | 393 | 330-840 | 411 | 335-397 | 524 |
| 330-665 | 393 | 330-841 | 411 | 335-398 | 524 |
| 330-670 | 393 | 330-842 | 411 | 335-399 | 524 |
| 330-671 | 393 | 330-844 | 413 | 335-400 | 525 |
| 330-672 | 393 | 330-845 | 413 | 335-404 | 525 |
| 330-673 | 393 | 330-846 | 413 | 335-406 | 525 |
| 330-674 | 393 | 330-847 | 413 | 345-215B | 774 |
| 330-675 | 393 | 330-849A | 396 | 345-216 | 774 |
| 330-690 | 395 | 330-849B | 396 | 345-216B | 774 |
| 330-691 | 395 | 330-849C | 396 | 345-217 | 261, 775 |
| 330-692 | 395 | 330-849D | 396 | 345-218 | 765 |
| 330-693 | 395 | 330-849E | 396 | 345-220 | 765 |
| 330-694 | 395 | 330-882 | 394 | 345-224 | 766 |
| 330-695 | 395 | 330-883 | 394 | 345-226 | 766 |
| 330-696 | 395 | 330-884 | 394 | 345-228 | 766 |
| 330-700 | 395 | 330-885 | 394 | 345-241 | 761 |
| 330-701 | 395 | 330-886 | 394 | 345-242 | 761 |
| 330-702 | 395 | 330-887 | 394 | 345-243 | 764 |
| 330-703 | 395 | 330-888 | 394 | 345-246 | 773 |
| 330-704 | 395 | 330-889 | 394 | 345-246A | 773 |
| 330-705 | 395 | 330-890 | 394 | 345-247 | 771 |
| 330-706 | 395 | 330-891 | 394 | 345-262 | 768 |
| 330-708 | 394 | 330-892 | 394 | 345-263 | 768 |
| 330-708A | 394 | 330-895 | 394 | 345-264 | 764 |
| 330-730 | 397 | 335-135 | 378 | 345-265 | 764 |
| 330-731 | 397 | 335-136 | 378 | 345-266 | 764 |
| 330-732 | 397 | 335-137 | 378 | 345-267 | 764 |
| 330-733 | 397 | 335-138 | 378 | 345-270 | 774 |
| 330-790M | 398 | 335-139 | 378 | 345-279 | 760 |
| 330-790MB | 400 | 335-140 | 378 | 345-281 | 757 |
| 330-791M | 398 | 335-141 | 378 | 345-281A | 758 |
| 330-791MB | 400 | 335-205 | 377 | 345-283 | 757 |

| | | | | | |
|-----------|-----|-------------|---------------|-----------|----------|
| 345-283A | 758 | 355-163L | 518 | 400-105 | 154 |
| 345-285 | 757 | 355-170 | 519 | 400-107 | 154 |
| 345-285A | 758 | 355-171 | 519 | 400-109 | 154 |
| 345-287 | 757 | 355-171L | 519 | 400-111 | 154 |
| 345-287A | 758 | 355-172 | 519 | 400-113 | 154 |
| 345-289 | 757 | 355-173 | 519 | 400-115 | 154 |
| 345-289A | 758 | 355-173L | 519 | 400-293 | 154 |
| 345-289R | 761 | 355-182 | 428 | 400-294 | 154 |
| 345-290 | 759 | 355-183 | 428 | 400-358 | 156 |
| 345-291 | 759 | 355-186 | 572 | 400-359 | 156 |
| 345-292 | 759 | 355-187 | 572 | 400-360 | 156 |
| 345-293 | 759 | 355-188 | 572 | 400-361 | 156 |
| 345-294 | 759 | 355-189 | 571 | 400-362 | 156 |
| 345-300 | 761 | 355-190 | 571, 582 | 400-363 | 156 |
| 345-302 | 761 | 355-191 | 571 | 400-364 | 156 |
| 345-305 | 761 | 355-192 | 571, 582 | 400-365 | 156 |
| 345-310 | 764 | 355-193 | 571, 572, 582 | 400-419T | 191 |
| 345-311 | 764 | 355-196 | 569 | 400-420T | 190, 191 |
| 345-312 | 765 | 355-198 | 582 | 400-421T | 190 |
| 345-314 | 765 | 355-199 | 582 | 400-422T | 190 |
| 345-320 | 772 | 355-202 | 577 | 400-423T | 190 |
| 345-320S | 773 | 355-206 | 583 | 400-428 | 49 |
| 345-322 | 772 | 355-207 | 578 | 400-428A | 49 |
| 345-324 | 772 | 355-209 | 577 | 400-431T | 194 |
| 345-324S | 773 | 355-210 | 577 | 400-436T | 194 |
| 345-326 | 772 | 355-211 | 579 | 400-437T | 194 |
| 345-330 | 772 | 355-212 | 574 | 400-438T | 194 |
| 345-332 | 772 | 355-213 | 574 | 400-445 | 178 |
| 345-338 | 771 | 355-214 | 574 | 400-445L | 178 |
| 345-340 | 770 | 355-219 | 568 | 400-446 | 178 |
| 345-342 | 770 | 355-221 | 491 | 400-446L | 178 |
| 345-344 | 770 | 355-222 | 490 | 400-447 | 178 |
| 345-345 | 771 | 355-223 | 490 | 400-447L | 178 |
| 345-346 | 771 | 355-226 | 490 | 400-448 | 178 |
| 345-350 | 765 | 355-230 | 436 | 400-448L | 178 |
| 345-352 | 765 | 355-235 | 436 | 400-461T | 182 |
| 345-2950 | 759 | 355-236A | 437 | 400-462T | 182 |
| 345-2951 | 759 | 355-236B | 437 | 400-463T | 182 |
| 345-2952 | 759 | 355-236N | 437 | 400-464T | 182 |
| 345-2953 | 759 | 355-236-SET | 437 | 404-340C | 687 |
| 345-2954 | 759 | 355-238 | 493 | 404-341C | 687 |
| 345-2955 | 759 | 355-239 | 493 | 404-342C | 687 |
| 345-2956 | 759 | 355-240 | 494 | 404-400 | 679 |
| 345-2957 | 759 | 355-241 | 494 | 404-400B | 675 |
| 345-2958 | 759 | 355-244 | 433 | 404-400BG | 683 |
| 345-2959 | 759 | 355-245 | 435 | 404-400E | 692 |
| 345A-P16 | 40 | 355-250 | 232 | 404-402 | 679, 689 |
| 345A-PAG1 | 40 | 355-272 | 521 | 404-402B | 675 |
| 345B-16 | 40 | 355-273 | 521 | 404-402BG | 683 |
| 345B-G1 | 40 | 355-300 | 558 | 404-402E | 692 |
| 345F-CT22 | 41 | 355-2213 | 491 | 404-403BG | 683 |
| 345P-MX16 | 40 | 355-2214 | 491 | 404-404 | 679, 689 |
| 345P-MXG1 | 40 | 355-2215 | 491 | 404-404B | 675 |
| 345P-RP08 | 41 | 355-2217 | 491 | 404-404BG | 683 |
| 345P-RP22 | 41 | 400-050 | 156 | 404-404E | 692 |
| 350-805 | 95 | 400-050T | 156 | 404-405BG | 683 |
| 350-807 | 95 | 400-070 | 154 | 404-406 | 679, 689 |
| 350-836 | 418 | 400-071 | 154 | 404-406B | 675 |
| 350-838 | 418 | 400-074 | 154 | 404-406E | 692 |
| 350-866 | 358 | 400-075 | 154 | 404-408 | 679, 689 |
| 350-867 | 358 | 400-076 | 154 | 404-408B | 675 |
| 350-869 | 358 | 400-077 | 154 | 404-408E | 692 |
| 350-871 | 358 | 400-080 | 155 | 404-410 | 679 |
| 350-880 | 362 | 400-091 | 154 | 404-410B | 675 |
| 350-884 | 358 | 400-093 | 154 | 404-412 | 680 |
| 350-885 | 358 | 400-095 | 154 | 404-412B | 676 |
| 355-161 | 520 | 400-097 | 154 | 404-414 | 680 |
| 355-162 | 518 | 400-101 | 154 | 404-414B | 676 |
| 355-163 | 518 | 400-103 | 154 | 404-416 | 680 |

| | | | | | |
|----------|--------------------|-------------|--------------------|------------|-----|
| 404-416B | 676 | 404-520B | 676 | 404-742 | 710 |
| 404-418 | 680 | 404-521 | 680 | 404-744 | 710 |
| 404-418B | 676 | 404-521B | 676 | 404-747 | 710 |
| 404-420 | 680 | 404-522 | 680 | 404-747E | 711 |
| 404-420B | 676 | 404-522B | 676 | 404-749 | 710 |
| 404-422 | 680 | 404-523 | 680 | 404-751 | 710 |
| 404-422B | 676 | 404-523B | 676 | 404-754 | 710 |
| 404-424 | 681 | 404-524 | 680 | 404-754D | 710 |
| 404-424B | 677 | 404-524B | 676 | 404-755 | 710 |
| 404-426 | 681 | 404-525 | 681 | 404-755D | 710 |
| 404-426B | 677 | 404-525B | 677 | 404-755L | 710 |
| 404-428 | 681 | 404-526 | 681 | 404-756 | 710 |
| 404-428B | 677 | 404-526B | 677 | 404-756D | 710 |
| 404-430 | 681 | 404-527 | 681 | 404-758 | 710 |
| 404-430B | 677 | 404-527B | 677 | 404-759 | 710 |
| 404-432 | 681 | 404-528 | 681 | 404-760 | 710 |
| 404-432B | 677 | 404-528B | 677 | 404-761 | 710 |
| 404-434 | 681 | 404-529 | 681 | 404-762 | 710 |
| 404-434B | 677 | 404-529B | 677 | 404-763 | 710 |
| 404-450 | 673 | 404-530 | 681 | 404-764 | 612 |
| 404-451 | 673 | 404-530B | 677 | 404-765 | 612 |
| 404-452 | 673 | 404-539 | 679, 687 | 404-766 | 698 |
| 404-461 | 673 | 404-539B | 675, 678, 684, 685 | 404-767 | 698 |
| 404-461B | 674 | 404-540 | 679, 687, 689 | 404-768 | 698 |
| 404-462 | 673 | 404-540B | 675, 678, 684, 685 | 404-769 | 698 |
| 404-462B | 674 | 404-541 | 679, 687, 689 | 404-770 | 698 |
| 404-463 | 673 | 404-541B | 675, 678, 684, 685 | 404-771 | 698 |
| 404-463B | 674 | 404-542 | 679, 689 | 404-772 | 698 |
| 404-468 | 686 | 404-542B | 675, 678, 684, 685 | 404-774 | 700 |
| 404-469 | 718 | 404-543 | 679, 689 | 404-775 | 700 |
| 404-470 | 680 | 404-543B | 675, 678, 684, 685 | 404-776 | 700 |
| 404-470B | 676 | 404-544 | 679 | 404-777 | 716 |
| 404-471 | 680 | 404-544B | 675 | 404-779 | 705 |
| 404-471B | 676 | 404-553 | 682 | 404-780 | 705 |
| 404-472 | 680 | 404-554 | 682 | 404-781 | 705 |
| 404-472B | 676 | 404-556 | 682 | 404-782 | 703 |
| 404-473 | 680 | 404-557 | 682 | 404-783 | 703 |
| 404-473B | 676 | 404-558 | 682 | 404-784 | 703 |
| 404-474 | 680 | 404-559 | 682 | 404-785 | 703 |
| 404-474B | 676 | 404-605 | 670, 671 | 404-786 | 706 |
| 404-475 | 680 | 404-606 | 670, 671, 672 | 404-787 | 706 |
| 404-475B | 676 | 404-606B | 669, 672 | 404-788 | 706 |
| 404-480 | 681 | 404-606SB | 672 | 404-788U | 706 |
| 404-480B | 677 | 404-607 | 670, 671 | 404-789 | 705 |
| 404-481 | 681 | 404-608-SET | 668 | 404-790 | 715 |
| 404-481B | 677 | 404-711 | 708 | 404-790LP | 714 |
| 404-482 | 681 | 404-711D | 708 | 404-791 | 715 |
| 404-482B | 677 | 404-711U | 708 | 404-791LP | 714 |
| 404-483 | 681 | 404-712 | 708 | 404-792 | 715 |
| 404-483B | 677 | 404-714 | 708 | 404-792B | 715 |
| 404-484 | 681 | 404-716 | 708 | 404-792LP | 714 |
| 404-484B | 677 | 404-719 | 708 | 404-792S | 715 |
| 404-485 | 681 | 404-719E | 711 | 404-793 | 715 |
| 404-485B | 677 | 404-721 | 708 | 404-793K | 716 |
| 404-490 | 679 | 404-723 | 708 | 404-793LP | 714 |
| 404-490B | 675 | 404-727 | 709 | 404-794 | 715 |
| 404-491 | 679 | 404-729 | 709 | 404-794LP | 714 |
| 404-491B | 675, 678, 684, 685 | 404-731 | 709 | 404-795 | 715 |
| 404-492 | 679 | 404-734 | 709 | 404-795LP | 714 |
| 404-492B | 675, 678, 684, 685 | 404-734E | 711 | 404-795SLP | 714 |
| 404-493 | 679 | 404-736 | 709 | 404-796 | 715 |
| 404-493B | 675, 678, 684, 685 | 404-737 | 709 | 404-796LP | 714 |
| 404-494 | 679 | 404-738 | 709 | 404-797 | 717 |
| 404-494B | 675, 678, 684, 685 | 404-738D | 709 | 404-798 | 717 |
| 404-495 | 679 | 404-738U | 709 | 404-800 | 715 |
| 404-495B | 675 | 404-739 | 710 | 404-800LP | 714 |
| 404-519 | 680 | 404-739D | 710 | 404-801 | 715 |
| 404-519B | 676 | 404-739U | 710 | 404-801LP | 714 |
| 404-520 | 680 | 404-740 | 710 | 404-802 | 715 |

| | | | | | |
|------------|----------|------------|-----|-------------|---------------|
| 404-802LP | 714 | 404-6093 | 670 | 412-618T | 186 |
| 404-802S | 715 | 404-7871 | 706 | 412-620 | 250 |
| 404-803 | 715 | 404-7875 | 706 | 412-621 | 250 |
| 404-803LP | 714 | 404-7885 | 706 | 412-622 | 250 |
| 404-810 | 715 | 404-7929 | 715 | 412-623 | 250 |
| 404-810LP | 714 | 404-7959 | 715 | 412-624A | 250 |
| 404-811 | 715 | 404-60825E | 669 | 412-624B | 250 |
| 404-811LP | 714 | 412-414 | 186 | 412-625A | 250 |
| 404-812 | 715 | 412-415 | 186 | 412-625B | 250 |
| 404-812LP | 714 | 412-422 | 187 | 412-671 | 301 |
| 404-813 | 713 | 412-438 | 184 | 412-672H | 314 |
| 404-814 | 713, 717 | 412-440 | 184 | 412-672-SET | 314 |
| 404-822 | 717 | 412-442 | 184 | 412-673 | 314 |
| 404-823 | 717 | 412-442L | 179 | 412-674 | 314 |
| 404-824 | 702 | 412-442R | 179 | 412-675 | 314 |
| 404-825 | 715 | 412-443 | 178 | 412-676 | 314 |
| 404-826 | 715 | 412-444 | 179 | 412-677I | 291 |
| 404-827 | 715 | 412-444KL | 179 | 412-677L | 289 |
| 404-828 | 715 | 412-444KR | 179 | 412-677M | 288 |
| 404-829 | 715 | 412-444L | 179 | 412-678 | 286 |
| 404-830 | 715 | 412-444LT | 179 | 412-678I | 291 |
| 404-831 | 715 | 412-444T | 179 | 412-678L | 289 |
| 404-832 | 715 | 412-445A | 180 | 412-678M | 288 |
| 404-833 | 715 | 412-445AL | 180 | 412-679 | 291 |
| 404-834 | 715 | 412-445ALT | 181 | 412-679I | 291 |
| 404-835 | 715 | 412-445AT | 181 | 412-679L | 289 |
| 404-836 | 715 | 412-445B | 180 | 412-680 | 286, 291 |
| 404-837 | 715 | 412-445BL | 180 | 412-680I | 291 |
| 404-838 | 715 | 412-445BLT | 181 | 412-680L | 289 |
| 404-839 | 715 | 412-445BT | 181 | 412-680M | 288 |
| 404-4683 | 686 | 412-445C | 180 | 412-681 | 286, 291 |
| 404-4684 | 686 | 412-445CL | 180 | 412-681I | 291 |
| 404-5301 | 682 | 412-445CLT | 181 | 412-681L | 289 |
| 404-5302 | 682 | 412-445CT | 181 | 412-681M | 288 |
| 404-5303 | 682 | 412-445D | 180 | 412-681R | 292 |
| 404-5304 | 682 | 412-445DT | 181 | 412-682 | 286, 291 |
| 404-5305 | 682 | 412-445EL | 180 | 412-682I | 291 |
| 404-5306 | 682 | 412-445ELT | 181 | 412-682L | 289 |
| 404-5391 | 675 | 412-472 | 237 | 412-682M | 288 |
| 404-5401 | 675 | 412-488 | 178 | 412-682R | 292 |
| 404-6061B | 669 | 412-518 | 379 | 412-683 | 286, 291 |
| 404-6062B | 669 | 412-520 | 376 | 412-683I | 291 |
| 404-6063B | 669 | 412-522 | 376 | 412-683L | 289 |
| 404-6063EB | 669 | 412-524 | 376 | 412-683M | 288 |
| 404-6071 | 671 | 412-526 | 376 | 412-684 | 286, 291 |
| 404-6072 | 671 | 412-528 | 376 | 412-684I | 291 |
| 404-6073 | 671 | 412-530 | 377 | 412-684L | 289 |
| 404-6074 | 671 | 412-545 | 195 | 412-684M | 288 |
| 404-6075 | 671 | 412-546 | 195 | 412-685 | 286, 291 |
| 404-6076 | 671 | 412-547 | 196 | 412-685F | 299 |
| 404-6077 | 671 | 412-547T | 196 | 412-685I | 291 |
| 404-6078 | 671 | 412-548 | 196 | 412-685L | 289 |
| 404-6079 | 671 | T412-548 | 196 | 412-685M | 288 |
| 404-6080 | 671 | 412-549 | 196 | 412-686 | 286, 291 |
| 404-6081 | 670 | T412-549 | 196 | 412-686H | 299 |
| 404-6082 | 670 | 412-550 | 196 | 412-686I | 291 |
| 404-6082B | 669 | 412-551 | 196 | 412-686L | 289 |
| 404-6082C | 669 | T412-551 | 196 | 412-686M | 288 |
| 404-6083 | 670 | 412-552 | 196 | 412-686R | 292 |
| 404-6083B | 669 | 412-552T | 196 | 412-688 | 286 |
| 404-6083E | 669 | 412-605 | 244 | 412-688M | 288 |
| 404-6084 | 670 | 412-607 | 245 | 412-689 | 286, 290, 291 |
| 404-6085 | 670 | 412-608 | 245 | 412-690 | 290 |
| 404-6086 | 670 | 412-609 | 245 | 412-691 | 290 |
| 404-6087 | 670 | 412-610 | 246 | 412-692 | 290 |
| 404-6088 | 670 | 412-612 | 246 | 412-694 | 290 |
| 404-6089 | 670 | 412-614 | 246 | 412-696 | 290 |
| 404-6090 | 670 | 412-615 | 183 | 412-700 | 290 |
| 404-6091 | 670 | 412-616T | 184 | 412-701 | 290 |

| | | | | | |
|-------------|-----|-----------|----------|----------|----------|
| 412-702 | 290 | 412-787 | 237 | 413-007S | 255 |
| 412-704 | 290 | 412-789 | 237 | 413-008 | 255 |
| 412-705 | 287 | 412-790 | 241 | 413-008S | 255 |
| 412-706 | 290 | 412-791 | 241 | 413-009 | 255 |
| 412-710 | 297 | 412-792 | 241 | 413-009S | 255 |
| 412-712 | 297 | 412-793 | 241 | 413-010 | 256 |
| 412-713 | 297 | 412-794 | 241 | 413-010S | 256 |
| 412-714 | 297 | 412-795 | 241 | 413-011 | 256 |
| 412-715 | 305 | 412-796 | 241 | 413-011S | 256 |
| 412-715A | 305 | 412-797 | 241 | 413-012 | 256 |
| 412-715B | 305 | 412-798 | 241 | 413-012S | 256 |
| 412-715C | 305 | 412-799 | 241 | 413-013 | 256 |
| 412-715D | 305 | 412-800 | 313 | 413-013S | 256 |
| 412-716 | 305 | 412-805 | 313 | 413-014 | 256 |
| 412-716A | 305 | 412-810 | 313 | 413-014S | 256 |
| 412-717 | 305 | 412-815 | 313 | 413-015 | 256 |
| 412-718 | 305 | 412-830 | 304 | 413-015S | 256 |
| 412-719 | 305 | 412-839 | 293 | 413-016 | 257 |
| 412-721 | 247 | 412-840 | 293 | 413-016S | 257 |
| 412-722 | 247 | 412-841 | 293 | 413-017 | 257 |
| 412-723 | 248 | 412-844 | 293 | 413-017S | 257 |
| 412-724 | 313 | 412-845 | 293 | 413-018 | 257 |
| 412-727A | 304 | 412-846 | 293 | 413-018S | 257 |
| 412-727B | 304 | 412-847 | 293 | 413-019 | 257 |
| 412-728 | 304 | 412-848 | 293 | 413-019S | 257 |
| 412-728B | 304 | 412-849 | 293 | 413-020 | 206 |
| 412-729 | 304 | 412-850 | 293 | 413-021 | 206 |
| 412-729B | 304 | 412-851 | 293 | 413-022 | 206 |
| 412-736-1 | 304 | 412-852 | 293 | 413-023 | 206 |
| 412-736-2 | 304 | 412-853 | 296 | 413-024 | 206 |
| 412-736-3 | 304 | 412-854 | 296 | 413-030 | 206 |
| 412-736-4 | 304 | 412-855 | 296 | 413-031 | 206 |
| 412-737-11 | 302 | 412-856 | 296 | 413-032 | 206 |
| 412-737-14 | 302 | 412-857 | 296 | 413-033 | 206 |
| 412-737-15 | 302 | 412-858 | 296 | 413-040 | 530 |
| 412-737-16 | 302 | 412-859 | 296 | 413-044 | 531 |
| 412-737-17 | 302 | 412-860 | 296 | 413-045 | 531 |
| 412-737-18 | 302 | 412-861 | 296 | 413-050 | 531 |
| 412-737-19 | 302 | 412-900 | 300 | 413-051 | 531 |
| 412-737-20 | 302 | 412-902 | 300 | 413-052 | 531 |
| 412-737-21 | 302 | 412-904 | 300 | 413-055 | 531 |
| 412-737-22 | 302 | 412-906 | 300 | 413-057 | 531 |
| 412-737-24 | 302 | 412-908 | 300 | 413-058 | 531 |
| 412-737-25 | 302 | 412-910 | 300 | 416-100 | 229 |
| 412-737-26 | 302 | 412-5374 | 379 | 416-101 | 229 |
| 412-738 | 303 | 412-5375 | 379 | 416-102 | 229 |
| 412-738-11 | 303 | 412-5377 | 379 | 416-103 | 229 |
| 412-738-12 | 303 | 412-7081 | 297 | 416-104 | 229 |
| 412-738-13 | 303 | 412-7082 | 297 | 416-105 | 229 |
| 412-738-50 | 303 | 412-7083 | 297 | 416-106 | 229 |
| 412-738-55 | 303 | 412-7084 | 297 | 416-130 | 228 |
| 412-738-55S | 303 | 412-7151B | 305 | 416-131 | 228 |
| 412-740 | 314 | 412-7256 | 247, 301 | 416-132 | 228 |
| 412-741 | 314 | 412-7257 | 247, 301 | 416-133 | 228 |
| 412-766 | 240 | 412-7258 | 247, 301 | 416-134 | 228 |
| 412-767 | 240 | 412-53765 | 379 | 416-135 | 228 |
| 412-768 | 240 | 413-001 | 254 | 416-136 | 228 |
| 412-769 | 240 | 413-001S | 254 | 416-137 | 486 |
| 412-770 | 239 | 413-002 | 254 | 416-138 | 228 |
| 412-771 | 239 | 413-002S | 254 | 416-139 | 228 |
| 412-772 | 239 | 413-003 | 254 | 416-140 | 228 |
| 412-773 | 239 | 413-003S | 254 | 416-141 | 228 |
| 412-774 | 239 | 413-004 | 254 | 416-150 | 230, 231 |
| 412-775 | 239 | 413-004S | 254 | 416-152 | 231 |
| 412-776 | 239 | 413-005 | 254 | 416-153 | 231 |
| 412-777 | 239 | 413-005S | 254 | 416-154 | 231 |
| 412-779 | 238 | 413-006 | 255 | 416-157 | 231 |
| 412-781 | 238 | 413-006S | 255 | 416-158 | 231 |
| 412-783 | 238 | 413-007 | 255 | 416-159 | 231 |

| | | | | | |
|----------|-----|----------|-----|-----------|----------|
| 416-161 | 231 | 416-534 | 215 | 417-048R | 455 |
| 416-162 | 231 | 416-536 | 215 | 417-049 | 482 |
| 416-163 | 231 | 416-538 | 215 | 417-0050 | 225 |
| 416-199 | 233 | 416-550 | 216 | 417-0051 | 225 |
| 416-200 | 213 | 416-552 | 216 | 417-0052 | 225 |
| 416-201 | 214 | 416-554 | 216 | 417-0053 | 225 |
| 416-202 | 214 | 416-556 | 216 | 417-055 | 487 |
| 416-220 | 217 | 416-558 | 216 | 417-055L | 487 |
| 416-220B | 217 | 416-559 | 216 | 417-055S | 487 |
| 416-220L | 217 | 416-560 | 216 | 417-056 | 484 |
| 416-225 | 218 | 416-562 | 216 | 417-056D | 484 |
| 416-230 | 212 | 416-564 | 216 | 417-057 | 484 |
| 416-250 | 212 | 416-566 | 216 | 417-058 | 226 |
| 416-260 | 211 | 416-568 | 216 | 417-058D | 226 |
| 416-280 | 210 | 416-580 | 219 | 417-0060 | 225, 482 |
| 416-298 | 217 | 416-582 | 219 | 417-060A | 482 |
| 416-299 | 217 | 416-584 | 219 | 417-060B | 482 |
| 416-300 | 220 | 416-586 | 219 | 417-060C | 482 |
| 416-305 | 220 | 416-588 | 219 | 417-060D | 482 |
| 416-312 | 222 | 416-590 | 219 | 417-060E | 482 |
| 416-314 | 222 | 416-600 | 281 | 417-0061 | 225, 453 |
| 416-316 | 222 | 416-601 | 279 | 417-0062 | 225, 451 |
| 416-330 | 222 | 416-602 | 280 | 417-062A | 451 |
| 416-335 | 222 | 416-603 | 279 | 417-062B | 451 |
| 416-340 | 221 | 416-604 | 279 | 417-062C | 451 |
| 416-342 | 221 | 416-605 | 280 | 417-062D | 452 |
| 416-400 | 216 | 416-610 | 281 | 417-0063 | 225, 484 |
| 416-402 | 216 | 416-615 | 281 | 417-0064 | 225, 483 |
| 416-404 | 216 | 416-650 | 218 | 417-064A | 483 |
| 416-406 | 216 | 416-655 | 218 | 417-064B | 483 |
| 416-408 | 216 | 416-660 | 211 | 417-064C | 483 |
| 416-410 | 216 | 416-680 | 210 | 417-064D | 483 |
| 416-412 | 216 | 416-700 | 213 | 417-064E | 483 |
| 416-414 | 216 | 416-800 | 223 | 417-064F | 483 |
| 416-416 | 216 | 416-801 | 223 | 417-070 | 461 |
| 416-418 | 216 | 416-802 | 223 | 417-072 | 461 |
| 416-420 | 216 | 416-803 | 223 | 417-088 | 265 |
| 416-422 | 216 | 416-804 | 223 | 417-098 | 224 |
| 416-424 | 216 | 416-805 | 223 | 417-0135 | 225 |
| 416-426 | 216 | 416-806 | 223 | 417-0136 | 225 |
| 416-428 | 216 | 416-807 | 223 | 417-0137 | 225 |
| 416-450 | 215 | 416-808 | 223 | 417-0138 | 225 |
| 416-452 | 215 | 416-809 | 223 | 417-0139 | 225 |
| 416-454 | 215 | 416-810 | 223 | 417-0140 | 225 |
| 416-456 | 215 | 416-820 | 222 | 417-0141 | 225 |
| 416-458 | 215 | 416-821 | 222 | 417-0142 | 225 |
| 416-460 | 215 | 416-822 | 222 | 417-0143 | 225 |
| 416-462 | 215 | 416-823 | 222 | 417-0144 | 225 |
| 416-464 | 215 | 416-824 | 222 | 417-0482 | 456 |
| 416-466 | 215 | 416-825 | 222 | 417-0482B | 456 |
| 416-468 | 215 | 416-826 | 222 | 419-378 | 551 |
| 416-500 | 215 | 416-827 | 222 | 419-380 | 551 |
| 416-502 | 215 | 416-844 | 227 | 419-382 | 551 |
| 416-504 | 215 | 416-846 | 227 | 419-384 | 551 |
| 416-506 | 215 | 416-848 | 227 | 419-386 | 551 |
| 416-508 | 215 | 416-850 | 227 | 419-388 | 553 |
| 416-510 | 215 | 417-006 | 225 | 419-392 | 553 |
| 416-512 | 215 | 417-0030 | 225 | 419-393 | 553 |
| 416-514 | 215 | 417-0031 | 225 | 419-394 | 553 |
| 416-516 | 215 | 417-0032 | 225 | 419-395 | 553 |
| 416-518 | 215 | 417-0033 | 225 | 419-396 | 553 |
| 416-519 | 215 | 417-0034 | 225 | 419-397 | 553 |
| 416-520 | 215 | 417-0035 | 225 | 419-398 | 553 |
| 416-522 | 215 | 417-0036 | 225 | 440-308 | 704 |
| 416-524 | 215 | 417-0037 | 225 | 440-309 | 704 |
| 416-526 | 215 | 417-045 | 278 | 440-310 | 704 |
| 416-528 | 215 | 417-046 | 485 | 440-311 | 704 |
| 416-530 | 215 | 417-047 | 485 | 440-312 | 704 |
| 416-532 | 215 | 417-048 | 455 | 440-313 | 704 |

| | | | | | |
|----------|-----|----------|-----|------------|-----|
| 440-420 | 195 | 468-339 | 82 | 469-083 | 87 |
| 440-421 | 195 | 468-340 | 77 | 469-084 | 87 |
| 440-423 | 195 | 468-342 | 77 | 475-490 | 134 |
| 442-210 | 104 | 468-343 | 77 | 475-492 | 134 |
| 442-212 | 104 | 468-344 | 77 | 475-596 | 769 |
| 442-214 | 104 | 468-548 | 699 | 475-598 | 769 |
| 442-215 | 104 | 468-550 | 699 | 475-600 | 769 |
| 442-216 | 104 | 468-580 | 700 | 475-605 | 769 |
| 442-218 | 104 | 468-585 | 700 | 475-610 | 769 |
| 442-219 | 104 | 468-590 | 700 | 475-615 | 769 |
| 442-236 | 101 | 468-600 | 699 | 475-618L | 770 |
| 442-238 | 101 | 468-606 | 699 | 475-618R | 770 |
| 442-238P | 101 | 468-610 | 699 | 475-803 | 384 |
| 442-239 | 101 | 468-616 | 699 | 475-804 | 384 |
| 442-240 | 101 | 468-620 | 699 | 475-805 | 384 |
| 442-242 | 106 | 468-622 | 699 | 475-806 | 384 |
| 442-244 | 106 | 468-636 | 699 | 502-271 | 86 |
| 442-246 | 106 | 468-638P | 699 | 502-272 | 86 |
| 442-2123 | 104 | 468-680 | 701 | 502-273 | 86 |
| 467-310 | 155 | 468-682 | 701 | 502-274 | 86 |
| 467-311 | 155 | 468-684 | 701 | 502-276 | 86 |
| 467-314T | 159 | 468-686 | 701 | 502-277 | 87 |
| 467-315 | 159 | 469-009 | 63 | 508-523 | 312 |
| 467-317 | 159 | 469-010 | 63 | 515-505 | 162 |
| 467-317B | 155 | 469-012 | 63 | 516-002 | 85 |
| 467-318 | 159 | 469-015 | 65 | 516-003 | 85 |
| 467-320 | 155 | 469-020 | 68 | 516-005 | 85 |
| 467-331L | 89 | 469-020S | 68 | 516-006 | 85 |
| 467-331M | 89 | 469-021 | 68 | 516-007 | 85 |
| 467-331S | 89 | 469-026 | 68 | 516-008 | 85 |
| 467-332 | 94 | 469-033T | 94 | 525-364 | 351 |
| 467-333 | 89 | 469-035 | 707 | 1100-165 | 120 |
| 467-334 | 92 | 469-036 | 61 | 1100-167 | 120 |
| 467-335 | 90 | 469-036B | 69 | 1100-169 | 120 |
| 467-335E | 90 | 469-038 | 67 | 1100-179 | 120 |
| 467-336 | 91 | 469-039 | 67 | 1100-183 | 101 |
| 467-339 | 74 | 469-040 | 61 | 1100-185 | 127 |
| 467-339U | 74 | 469-041 | 67 | 1100-187 | 120 |
| 467-350 | 93 | 469-041B | 69 | 1100-328 | 62 |
| 467-352 | 66 | 469-041Q | 64 | 1100-328B | 72 |
| 467-352B | 71 | 469-042Q | 64 | 1100-328L | 60 |
| 467-414 | 522 | 469-044 | 67 | 1100-328LB | 71 |
| 468-169 | 184 | 469-046Q | 64 | 1100-328S | 63 |
| 468-170 | 184 | 469-048 | 61 | 1100-330 | 62 |
| 468-171 | 184 | 469-048B | 70 | 1100-330S | 60 |
| 468-172 | 184 | 469-050 | 61 | 1100-331 | 61 |
| 468-181 | 186 | 469-050B | 70 | 1100-332 | 62 |
| 468-182 | 186 | 469-051 | 65 | 1100-333 | 60 |
| 468-183 | 186 | 469-053 | 719 | 1100-334 | 60 |
| 468-184 | 186 | 469-055 | 719 | 1100-426 | 346 |
| 468-185 | 186 | 469-056 | 719 | 1100-426M | 346 |
| 468-300 | 157 | 469-057 | 719 | 1100-451 | 327 |
| 468-321 | 83 | 469-058 | 719 | 1100-452 | 327 |
| 468-322 | 83 | 469-062 | 87 | 1100-460E | 551 |
| 468-323 | 84 | 469-063 | 87 | 1100-460L | 551 |
| 468-324 | 84 | 469-063A | 87 | 1100-460M | 551 |
| 468-325 | 83 | 469-063L | 87 | 1100-460S | 551 |
| 468-326 | 83 | 469-063M | 87 | 1100-460T | 551 |
| 468-327 | 84 | 469-063X | 87 | 1100-460X | 551 |
| 468-328 | 84 | 469-070 | 73 | 1100-461S | 407 |
| 468-330 | 78 | 469-070B | 73 | 1100-462S | 404 |
| 468-331 | 78 | 469-071 | 73 | 1100-462SH | 404 |
| 468-332 | 79 | 469-072 | 73 | 1100-463S | 404 |
| 468-333 | 79 | 469-074 | 73 | 1100-479A | 399 |
| 468-334 | 80 | 469-076 | 73 | 1100-479B | 399 |
| 468-335 | 80 | 469-078 | 73 | 1100-479C | 399 |
| 468-336 | 81 | 469-080 | 87 | 1100-479D | 399 |
| 468-337 | 81 | 469-081 | 87 | 1100-479E | 399 |
| 468-338 | 82 | 469-082 | 87 | 1100-479F | 399 |

| | | | | | |
|--------------|-----|---------------|----------|-----------|-----|
| 1100-479G | 399 | 1100-630ER | 446 | 1100-673E | 476 |
| 1100-479H | 399 | 1100-630G | 448 | 1100-674 | 476 |
| 1100-479J | 399 | 1100-630GR | 448 | 1100-675 | 476 |
| 1100-479K | 399 | 1100-630N | 443 | 1100-676 | 476 |
| 1100-479L | 399 | 1100-631 | 440 | 1100-677 | 476 |
| 1100-479M | 399 | 1100-631A | 440 | 1100-678 | 477 |
| 1100-479N | 399 | 1100-631B | 440 | 1100-679 | 477 |
| 1100-479-SET | 399 | 1100-631G | 448 | 1100-680 | 477 |
| 1100-485 | 767 | 1100-631GR | 448 | 1100-682 | 462 |
| 1100-485-SET | 767 | 1100-631M | 450 | 1100-684 | 462 |
| 1100-490 | 763 | 1100-631N | 443 | 1100-686 | 462 |
| 1100-490C | 762 | 1100-631S | 440 | 1100-710A | 88 |
| 1100-491 | 762 | 1100-632 | 445 | 1100-710B | 88 |
| 1100-492 | 756 | 1100-632AB | 444 | 1100-710C | 88 |
| 1100-492A | 756 | 1100-632ABR-7 | 447 | 1100-712A | 88 |
| 1100-492B | 756 | 1100-632ABR-8 | 447 | 1100-712B | 88 |
| 1100-492C | 756 | 1100-632G | 448 | 1100-712C | 88 |
| 1100-492D | 757 | 1100-632GR | 448 | 1100-714A | 88 |
| 1100-492F | 757 | 1100-632R | 443 | 1100-714B | 88 |
| 1100-492G | 757 | 1100-633A | 442 | 1100-714C | 88 |
| 1100-496 | 591 | 1100-633B | 442 | 1100-716A | 88 |
| 1100-496D | 593 | 1100-633BR | 442 | 1100-716B | 88 |
| 1100-496L | 592 | 1100-633C | 442 | 1100-716C | 88 |
| 1100-512 | 379 | 1100-633D | 442 | 1100-718A | 88 |
| 1100-529 | 576 | 1100-633E | 442 | 1100-718B | 88 |
| 1100-530 | 576 | 1100-633F | 443 | 1100-718C | 88 |
| 1100-530A | 573 | 1100-633G | 443 | 1100-720A | 88 |
| 1100-531 | 573 | 1100-633H | 443 | 1100-720B | 88 |
| 1100-532 | 428 | 1100-633HR | 443 | 1100-720C | 88 |
| 1100-533 | 428 | 1100-633I | 443 | 1100-722A | 88 |
| 1100-533A | 428 | 1100-635 | 457 | 1100-722B | 88 |
| 1100-536 | 428 | 1100-635C | 457 | 1100-722C | 88 |
| 1100-542 | 745 | 1100-636 | 269 | 1100-724A | 88 |
| 1100-544 | 745 | 1100-638 | 269 | 1100-724B | 88 |
| 1100-549 | 737 | 1100-640 | 269 | 1100-724C | 88 |
| 1100-557 | 737 | 1100-642 | 269 | 1100-732 | 117 |
| 1100-557B | 737 | 1100-644 | 269 | 1100-733 | 117 |
| 1100-557C | 737 | 1100-644B | 269 | 1100-735F | 135 |
| 1100-557D | 737 | 1100-645B | 273 | 1100-739A | 122 |
| 1100-574 | 740 | 1100-645S | 273 | 1100-739B | 122 |
| 1100-576 | 740 | 1100-646 | 277 | 1100-740 | 44 |
| 1100-577 | 740 | 1100-648 | 467 | 1100-741 | 44 |
| 1100-577S | 740 | 1100-648B | 467 | 1100-742 | 46 |
| 1100-578 | 746 | 1100-650 | 467 | 1100-759 | 665 |
| 1100-578A | 746 | 1100-650B | 467 | 1100-765 | 662 |
| 1100-608 | 275 | 1100-652 | 467 | 1100-766 | 664 |
| 1100-616 | 272 | 1100-652B | 467 | 1100-769 | 88 |
| 1100-617 | 272 | 1100-654 | 467 | 1100-770 | 88 |
| 1100-618 | 272 | 1100-654B | 467 | 1100-771A | 88 |
| 1100-619 | 272 | 1100-656 | 467 | 1100-771B | 88 |
| 1100-620 | 272 | 1100-656B | 467 | 1100-788 | 35 |
| 1100-621 | 272 | 1100-658 | 467 | 1100-791 | 203 |
| 1100-622 | 272 | 1100-658B | 467 | 1100-798 | 374 |
| 1100-623 | 272 | 1100-660 | 467 | 1100-798A | 374 |
| 1100-624 | 272 | 1100-660B | 467 | 1100-798B | 375 |
| 1100-625 | 272 | 1100-662 | 467 | 1100-798C | 375 |
| 1100-628 | 445 | 1100-662B | 467 | 1100-798D | 375 |
| 1100-628A | 440 | 1100-668 | 468, 470 | 1100-798E | 374 |
| 1100-628B | 445 | 1100-668B | 468, 470 | 1100-798F | 374 |
| 1100-628C | 440 | 1100-668T | 468, 470 | 1100-798H | 376 |
| 1100-628G | 448 | 1100-669 | 468, 470 | 1100-798S | 374 |
| 1100-628GR | 448 | 1100-669B | 468, 470 | 1100-858 | 125 |
| 1100-629 | 445 | 1100-670 | 473 | 1100-859 | 125 |
| 1100-629A | 440 | 1100-670B | 473 | 1100-860 | 125 |
| 1100-629B | 445 | 1100-671 | 476 | 1100-861 | 125 |
| 1100-629G | 448 | 1100-671E | 476 | 1100-862 | 125 |
| 1100-629GR | 448 | 1100-672 | 476 | 1100-863 | 125 |
| 1100-630 | 445 | 1100-672E | 476 | 1100-864 | 125 |
| 1100-630A | 445 | 1100-673 | 476 | 1100-865 | 125 |

| | | | | | |
|-----------|----------|------------|----------|---------------|---------------|
| 1100-866 | 45 | 1103-039N | 341 | 1103-109 | 570 |
| 1100-868 | 45 | 1103-039S | 340 | 1103-110 | 569 |
| 1100-870 | 47 | 1103-040 | 348 | 1103-115 | 568 |
| 1100-872 | 47 | 1103-040A | 345 | 1103-117 | 580 |
| 1100-874 | 125 | 1103-040AS | 345 | 1103-120 | 494 |
| 1100-875 | 125 | 1103-040B | 345 | 1103-122 | 429 |
| 1100-876 | 125 | 1103-040BS | 345 | 1103-123 | 429 |
| 1100-877 | 125 | 1103-040C | 345 | 1103-125 | 427 |
| 1100-878 | 125 | 1103-040R | 348 | 1103-126 | 427 |
| 1100-879 | 125 | 1103-041 | 348 | 1103-126R | 427 |
| 1100-880 | 125 | 1103-041A | 349 | 1103-127 | 427 |
| 1100-881 | 125 | 1103-041B | 349 | 1103-127A | 427 |
| 1100-8851 | 767 | 1103-041C | 349 | 1103-133L | 559 |
| 1100-8852 | 767 | 1103-042 | 348 | 1103-133M | 559 |
| 1100-8853 | 767 | 1103-043 | 348 | 1103-133S | 559 |
| 1100-6251 | 274 | 1103-044 | 346 | 1103-134 | 492 |
| 1100-6252 | 274 | 1103-044S | 346 | 1103-137L | 558 |
| 1100-6253 | 274 | 1103-045 | 341 | 1103-137M | 558 |
| 1100-6280 | 445 | 1103-046 | 347 | 1103-137S | 558 |
| 1100-6282 | 449 | 1103-048 | 340 | 1103-138 | 495 |
| 1100-6283 | 449 | 1103-049 | 338 | 1103-140 | 575 |
| 1100-6292 | 449 | 1103-049L | 338 | 1103-140A | 575 |
| 1100-6293 | 449 | 1103-050 | 329 | 1103-140J | 575 |
| 1100-6312 | 449 | 1103-051 | 339 | 1103-141 | 559 |
| 1100-6313 | 449 | 1103-054A | 350 | 1103-142 | 559 |
| 1100-6315 | 441 | 1103-054B | 350 | 1103-144 | 557 |
| 1100-6317 | 441 | 1103-054C | 350 | 1103-145 | 557 |
| 1100-6322 | 449 | 1103-054D | 350 | 1103-147 | 586 |
| 1100-6323 | 449 | 1103-055 | 351 | 1103-150 | 590 |
| 1100-6332 | 449 | 1103-056 | 351 | 1103-152 | 587 |
| 1100-6333 | 449 | 1103-060 | 351 | 1103-152A | 591 |
| 1100-6334 | 449 | 1103-061 | 351 | 1103-153 | 587 |
| 1100-6335 | 449 | 1103-065 | 328 | 1103-154S | 587 |
| 1100-6691 | 463 | 1103-067 | 331 | 1103-155 | 589 |
| 1100-6692 | 463 | 1103-068 | 319 | 1103-156 | 492 |
| 1100-6696 | 477 | 1103-069 | 319, 322 | 1103-158 | 593 |
| 1100-6780 | 477 | 1103-070 | 318 | 1103-158B | 592 |
| 1100-7334 | 117 | 1103-071 | 318 | 1103-158M | 590 |
| 1100-7335 | 117 | 1103-071J | 320 | 1103-158S | 593 |
| 1100-7411 | 44 | 1103-071L | 320 | 1103-159 | 588 |
| 1100-7413 | 46 | 1103-073 | 318 | 1103-160 | 564 |
| 1103-003 | 324 | 1103-073J | 320 | 1103-161 | 511 |
| 1103-004 | 324 | 1103-073L | 320 | 1103-162A | 511 |
| 1103-005 | 324 | 1103-074 | 318 | 1103-162B | 511 |
| 1103-006 | 325 | 1103-075 | 318 | 1103-162C | 511 |
| 1103-008 | 325 | 1103-075D | 318 | 1103-162D | 512 |
| 1103-010 | 325 | 1103-077 | 318 | 1103-162E | 512 |
| 1103-011 | 325 | 1103-077J | 320 | 1103-162M | 512 |
| 1103-013 | 326 | 1103-077L | 320 | 1103-162S-SET | 511 |
| 1103-014 | 326 | 1103-078 | 318 | 1103-165 | 562 |
| 1103-015 | 326 | 1103-078J | 320 | 1103-166 | 562 |
| 1103-017 | 326 | 1103-078L | 320 | 1103-166X | 562 |
| 1103-020 | 340 | 1103-079 | 318 | 1103-167 | 562 |
| 1103-021 | 344 | 1103-079J | 320 | 1103-168 | 510 |
| 1103-021A | 344 | 1103-079L | 320 | 1103-168-SET | 510 |
| 1103-023 | 343 | 1103-080 | 318 | 1103-170 | 54 |
| 1103-023A | 344 | 1103-088 | 347 | 1103-171 | 592 |
| 1103-023B | 344 | 1103-090 | 663 | 1103-176 | 506 |
| 1103-024 | 343, 344 | 1103-092 | 656 | 1103-178A | 423 |
| 1103-027 | 343 | 1103-093 | 656 | 1103-178C | 423 |
| 1103-031 | 354 | 1103-094 | 656 | 1103-179 | 422 |
| 1103-033 | 339 | 1103-095 | 656 | 1103-180 | 510 |
| 1103-036 | 352 | 1103-100 | 581 | 1103-180T | 510 |
| 1103-036R | 352 | 1103-102 | 576 | 1103-184K | 504, 508 |
| 1103-037 | 353 | 1103-103V | 576 | 1103-184-SET | 508 |
| 1103-037A | 353 | 1103-104 | 570 | 1103-184T-SET | 508 |
| 1103-037S | 353 | 1103-105 | 581 | 1103-185K | 504, 508 |
| 1103-038 | 354 | 1103-107 | 580 | 1103-185-SET | 508 |
| 1103-039L | 341 | 1103-108 | 570 | 1103-185T | 506, 508, 509 |

| | | | | | |
|---------------|---------------|-----------|--------------|------------|-----|
| 1103-185T-SET | 508 | 1103-280C | 394 | 1103-856 | 331 |
| 1103-186X | 507 | 1103-281 | 394 | 1103-856R | 331 |
| 1103-187 | 507, 508, 509 | 1103-281C | 394 | 1103-1381 | 495 |
| 1103-190 | 504, 508 | 1103-282 | 394 | 1103-1551 | 589 |
| 1103-190H | 505, 508, 509 | 1103-282C | 394 | 1103-1552 | 589 |
| 1103-191 | 504, 508 | 1103-283 | 394 | 1103-1601 | 515 |
| 1103-191H | 505, 508 | 1103-283C | 394 | 1103-1622 | 514 |
| 1103-193 | 504, 509 | 1103-284 | 394 | 1103-1623 | 514 |
| 1103-193K | 504, 509 | 1103-284C | 394 | 1103-1624 | 514 |
| 1103-193-SET | 509 | 1103-285 | 394 | 1103-1625 | 512 |
| 1103-193T-SET | 509 | 1103-285C | 394 | 1103-1626 | 512 |
| 1103-194 | 505, 509 | 1103-286 | 394 | 1103-1627 | 512 |
| 1103-194-SET | 509 | 1103-286C | 394 | 1103-1661 | 563 |
| 1103-194T-SET | 509 | 1103-287 | 394 | 1103-1662 | 563 |
| 1103-195 | 526 | 1103-287C | 394 | 1103-2011 | 423 |
| 1103-197A | 526 | 1103-288 | 394 | 1103-2063 | 417 |
| 1103-197B | 526 | 1103-288C | 394 | 1103-16820 | 510 |
| 1103-197C | 526 | 1103-289 | 394 | 1103-16827 | 510 |
| 1103-200 | 426 | 1103-289C | 394 | 1103-16835 | 510 |
| 1103-201 | 424 | 1103-290 | 454 | 1106-019 | 355 |
| 1103-201A | 423 | 1103-291 | 394 | 1106-020 | 355 |
| 1103-201B | 423 | 1103-291C | 394 | 1106-022 | 355 |
| 1103-201C | 423 | 1103-292 | 394 | 1106-023 | 355 |
| 1103-201D | 423 | 1103-292C | 394 | 1106-024 | 355 |
| 1103-201E | 423 | 1103-293 | 394 | 1106-070 | 742 |
| 1103-201F | 423 | 1103-293C | 394 | 1106-075 | 742 |
| 1103-201G | 423 | 1103-297 | 454 | 1106-076 | 741 |
| 1103-201H | 424 | 1103-0331 | 342 | 1106-077 | 741 |
| 1103-202 | 360 | 1103-354 | 748 | 1106-078 | 741 |
| 1103-202D | 361 | 1103-0391 | 342 | 1106-079 | 741 |
| 1103-203 | 360 | 1103-0425 | 348 | 1106-080 | 740 |
| 1103-203D | 361 | 1103-0453 | 342 | 1106-082 | 740 |
| 1103-204 | 359 | 1103-0454 | 342 | 1106-084 | 740 |
| 1103-204A | 359 | 1103-613 | 664 | 1106-086 | 740 |
| 1103-205 | 418 | 1103-615 | 665 | 1106-091 | 740 |
| 1103-206 | 416 | 1103-702 | 20 | 1106-092 | 740 |
| 1103-208 | 418 | 1103-702D | 20 | 1106-124 | 426 |
| 1103-209 | 416 | 1103-703 | 20 | 1106-130 | 556 |
| 1103-210 | 379 | 1103-705 | 20 | 1106-131 | 556 |
| 1103-211 | 416 | 1103-708 | 12 | 1106-132 | 556 |
| 1103-213 | 416 | 1103-709 | 13 | 1106-133 | 557 |
| 1103-215 | 332 | 1103-710 | 20 | 1106-140 | 556 |
| 1103-223 | 760 | 1103-712 | 22 | 1106-185 | 434 |
| 1103-224 | 756 | 1103-715 | 20 | 1106-190 | 56 |
| 1103-225 | 760 | 1103-716 | 20 | 1106-196 | 425 |
| 1103-225C | 762 | 1103-717 | 22 | 1106-197 | 432 |
| 1103-226 | 760 | 1103-717D | 22 | 1106-198 | 425 |
| 1103-228 | 763 | 1103-719 | 19 | 1106-199 | 424 |
| 1103-229 | 761 | 1103-720 | 19 | 1106-200 | 432 |
| 1103-230 | 743 | 1103-723 | 20, 398, 399 | 1106-205 | 432 |
| 1103-232 | 762 | 1103-724 | 20 | 1106-206 | 425 |
| 1103-233 | 761 | 1103-729 | 233 | 1106-207 | 433 |
| 1103-235 | 765 | 1103-730 | 35 | 1106-210 | 432 |
| 1103-236 | 763 | 1103-808 | 136 | 1106-212 | 433 |
| 1103-237 | 763 | 1103-809 | 136 | 1106-260 | 498 |
| 1103-238 | 763 | 1103-810 | 136 | 1106-261 | 498 |
| 1103-241 | 760 | 1103-811 | 137 | 1106-262 | 498 |
| 1103-242 | 760 | 1103-811T | 137 | 1106-263 | 498 |
| 1103-263 | 366 | 1103-812 | 136 | 1106-264 | 499 |
| 1103-264 | 366 | 1103-812T | 127 | 1106-266 | 499 |
| 1103-265 | 366 | 1103-841 | 564 | 1106-268 | 499 |
| 1103-266 | 366 | 1103-843 | 328 | 1106-270S | 498 |
| 1103-267 | 366 | 1103-844 | 328 | 1106-271 | 498 |
| 1103-268 | 366 | 1103-845 | 330 | 1106-280 | 499 |
| 1103-269 | 366 | 1103-846 | 330 | 1106-281 | 499 |
| 1103-270 | 366 | 1103-846R | 330 | 1106-284 | 499 |
| 1103-271 | 366 | 1103-847 | 565 | 1106-285 | 499 |
| 1103-272 | 366 | 1103-848 | 565 | 1106-287 | 500 |
| 1103-280 | 394 | 1103-848S | 565 | 1106-288 | 501 |

| | | | | | |
|-----------|----------|-----------|--------------|-------------|------------------------|
| 1106-289A | 500, 501 | 1270-107 | 607 | 1271-095 | 606 |
| 1106-289B | 500, 501 | 1270-107R | 609 | 1271-101 | 606 |
| 1106-375 | 513 | 1270-108 | 607 | 1271-101R | 608 |
| 1106-384 | 513 | 1270-109 | 607 | 1271-102 | 606 |
| 1106-385 | 513 | 1270-110 | 607 | 1271-103 | 606 |
| 1106-387 | 513 | 1270-111 | 607 | 1271-104 | 606 |
| 1106-388 | 513 | 1270-112 | 607 | 1271-105 | 606 |
| 1106-391 | 513 | 1271-005 | 76, 603 | 1271-106 | 606 |
| 1106-400 | 163 | 1271-005A | 76, 603 | 1271-107 | 606 |
| 1106-401 | 163 | 1271-006 | 76, 603 | 1271-107R | 609 |
| 1106-402 | 163 | 1271-007 | 76, 603 | 1271-108 | 606 |
| 1106-403 | 163 | 1271-008 | 76, 603 | 1271-109 | 606 |
| 1106-404 | 163 | 1271-009 | 76 | 1271-110 | 606 |
| 1106-0791 | 741 | 1271-010 | 62 | 1271-111 | 606 |
| 1106-848 | 515 | 1271-011 | 62 | 1271-112 | 606 |
| 1106-965 | 499 | 1271-012 | 62 | 1271-113 | 610 |
| 1106-967 | 499 | 1271-013 | 62 | 1271-115 | 617 |
| 1106-2871 | 500 | 1271-016 | 75, 603 | 1271-116T | 617 |
| 1106-2881 | 501 | 1271-018 | 75, 603 | 1271-116U | 617 |
| 1270-060 | 607 | 1271-020 | 75, 603, 625 | 1271-117 | 623, 624 |
| 1270-060R | 607 | 1271-020R | 75 | 1271-117-1 | 623, 624, 625 |
| 1270-061 | 607 | 1271-021 | 75, 603 | 1271-117-2 | 623, 624, 625 |
| 1270-061R | 607 | 1271-021A | 75, 603 | 1271-117-3 | 623, 624, 625 |
| 1270-062 | 607 | 1271-040 | 609 | 1271-117-4 | 623, 624 |
| 1270-062R | 607 | 1271-041 | 611 | 1271-117-5 | 623 |
| 1270-063 | 607 | 1271-042 | 610 | 1271-118T | 614 |
| 1270-063R | 607 | 1271-060 | 606 | 1271-119T | 614 |
| 1270-064 | 607 | 1271-060R | 606, 625 | 1271-120 | 520, 619 |
| 1270-064R | 607 | 1271-061 | 606 | 1271-120U | 618 |
| 1270-065 | 607 | 1271-061R | 606 | 1271-121 | 618 |
| 1270-065R | 607 | 1271-062 | 606 | 1271-121A | 618 |
| 1270-066 | 607 | 1271-062R | 606 | 1271-121B | 618 |
| 1270-066R | 607 | 1271-063 | 606 | 1271-121C | 618 |
| 1270-067 | 607 | 1271-063R | 606 | 1271-121PT | 614 |
| 1270-067R | 607 | 1271-064 | 606 | 1271-121T | 614 |
| 1270-068 | 607 | 1271-064R | 606 | 1271-121U | 618, 625 |
| 1270-068R | 607 | 1271-065 | 606 | 1271-122 | 618 |
| 1270-069 | 607 | 1271-065R | 606 | 1271-122U | 618, 625 |
| 1270-069R | 607 | 1271-066 | 606 | 1271-123 | 619 |
| 1270-070 | 607 | 1271-066R | 606 | 1271-123LW | 619 |
| 1270-070R | 607 | 1271-067 | 606 | 1271-125T | 614 |
| 1270-071 | 607 | 1271-067R | 606 | 1271-126T | 614 |
| 1270-071R | 607 | 1271-068 | 606 | 1271-127T | 614 |
| 1270-072 | 607 | 1271-068R | 606 | 1271-127U | 625 |
| 1270-072R | 607 | 1271-069 | 606 | 1271-128T | 614 |
| 1270-073 | 607 | 1271-069R | 606 | 1271-129 | 619 |
| 1270-073R | 607 | 1271-070 | 606 | 1271-130 | 619 |
| 1270-074 | 607 | 1271-070R | 606 | 1271-130PH | 619 |
| 1270-074R | 607 | 1271-071 | 606 | 1271-133AU | 620 |
| 1270-085 | 607 | 1271-071R | 606 | 1271-133U | 620 |
| 1270-085R | 607 | 1271-072 | 606 | 1271-134 | 618 |
| 1270-086 | 607 | 1271-072R | 606 | 1271-135T | 614 |
| 1270-086R | 607 | 1271-073 | 606 | 1271-136T | 614 |
| 1270-087 | 607 | 1271-073R | 606 | 1271-138T | 614 |
| 1270-087R | 607 | 1271-074 | 606 | 1271-139C | 419 |
| 1270-090 | 607 | 1271-074R | 606 | 1271-139D | 419 |
| 1270-090R | 608 | 1271-085 | 606 | 1271-139ST | 614 |
| 1270-091 | 607 | 1271-085R | 606 | 1271-139T | 614 |
| 1270-092 | 607 | 1271-086 | 606 | 1271-139U | 625 |
| 1270-093 | 607 | 1271-086R | 606 | 1271-140 | 617 |
| 1270-094 | 607 | 1271-087 | 606 | 1271-140U | 617, 625 |
| 1270-095 | 607 | 1271-087R | 606 | 1271-0141 | 66 |
| 1270-101 | 607 | 1271-089 | 721 | 1271-0142 | 66 |
| 1270-101R | 608 | 1271-090 | 606, 625 | 1271-0142LT | 614 |
| 1270-102 | 607 | 1271-090R | 608 | 1271-142RT | 614 |
| 1270-103 | 607 | 1271-091 | 606 | 1271-142T | 614 |
| 1270-104 | 607 | 1271-092 | 606 | 1271-142U | 625 |
| 1270-105 | 607 | 1271-093 | 606 | 1271-0143 | 66, 617, 618, 620, 625 |
| 1270-106 | 607 | 1271-094 | 606 | 1271-0144 | 66 |

| | | | | | |
|-----------|----------|----------|---------------|------------|----------|
| 1271-145 | 370, 371 | 1271-421 | 598, 604 | 1271-540 | 601, 605 |
| 1271-146 | 371 | 1271-422 | 598, 604 | 1271-541 | 601, 605 |
| 1271-147 | 371 | 1271-423 | 598, 604 | 1271-542 | 601, 605 |
| 1271-148S | 617 | 1271-424 | 598, 604 | 1271-543 | 601, 605 |
| 1271-148T | 617 | 1271-425 | 598, 604 | 1271-544 | 601, 605 |
| 1271-149 | 617 | 1271-426 | 611 | 1271-545 | 601, 605 |
| 1271-0151 | 74 | 1271-430 | 598, 604 | 1271-550 | 602, 605 |
| 1271-0152 | 74 | 1271-431 | 598, 604 | 1271-551 | 602, 605 |
| 1271-0153 | 74 | 1271-432 | 598, 604 | 1271-552 | 602, 605 |
| 1271-0154 | 74 | 1271-433 | 598, 604 | 1271-553 | 602, 605 |
| 1271-0156 | 85 | 1271-434 | 598, 604 | 1271-554 | 602, 605 |
| 1271-183 | 419 | 1271-435 | 598, 604 | 1271-555 | 602, 605 |
| 1271-315 | 620 | 1271-440 | 598, 604 | 1271-610 | 606 |
| 1271-316 | 620 | 1271-441 | 598, 604 | 1271-611 | 606 |
| 1271-317 | 620 | 1271-442 | 598, 604 | 1271-612 | 606 |
| 1271-318 | 620 | 1271-443 | 598, 604 | 1271-613 | 606 |
| 1271-319 | 620 | 1271-444 | 598, 604 | 1271-614 | 606 |
| 1271-320 | 621 | 1271-445 | 598, 604 | 1271-615 | 606 |
| 1271-321 | 621 | 1271-450 | 602, 604 | 1271-620 | 606 |
| 1271-322 | 621 | 1271-451 | 602, 604 | 1271-621 | 606 |
| 1271-323 | 621 | 1271-452 | 602, 604 | 1271-622 | 606 |
| 1271-324 | 621 | 1271-453 | 602, 604 | 1271-623 | 606 |
| 1271-325 | 621 | 1271-454 | 602, 604 | 1271-624 | 606 |
| 1271-326 | 621 | 1271-460 | 602, 604 | 1271-625 | 606 |
| 1271-327 | 621 | 1271-461 | 602, 604 | 1271-640 | 606 |
| 1271-330 | 621 | 1271-462 | 602, 604 | 1271-641 | 606 |
| 1271-340 | 522 | 1271-463 | 602, 604 | 1271-642 | 606 |
| 1271-342 | 522 | 1271-464 | 602, 604 | 1271-643 | 606 |
| 1271-350 | 599, 604 | 1271-470 | 602, 604 | 1271-644 | 606 |
| 1271-351 | 599, 604 | 1271-471 | 602, 604 | 1271-645 | 606 |
| 1271-352 | 599, 604 | 1271-472 | 602, 604 | 1271-650 | 606 |
| 1271-353 | 599, 604 | 1271-473 | 602, 604 | 1271-651 | 606 |
| 1271-354 | 599, 604 | 1271-474 | 602, 604 | 1271-652 | 606 |
| 1271-355 | 599, 604 | 1271-480 | 599, 605, 625 | 1271-653 | 606 |
| 1271-360 | 599, 604 | 1271-481 | 599, 605 | 1271-654 | 606 |
| 1271-361 | 599, 604 | 1271-482 | 599, 605 | 1271-655 | 606 |
| 1271-362 | 599, 604 | 1271-483 | 599, 605 | 1271-1204U | 618 |
| 1271-363 | 599 | 1271-484 | 599, 605 | 1271-1218 | 618 |
| 1271-364 | 599, 604 | 1271-485 | 599, 605 | 1273-031 | 649 |
| 1271-365 | 599, 604 | 1271-490 | 599, 605 | 1273-100 | 613 |
| 1271-370 | 598, 604 | 1271-491 | 599, 605 | 1273-101 | 613 |
| 1271-371 | 598, 604 | 1271-492 | 599, 605 | 1273-103 | 613 |
| 1271-372 | 598, 604 | 1271-493 | 599, 605 | 1273-105 | 613 |
| 1271-373 | 598, 604 | 1271-494 | 599, 605 | 1273-112 | 648 |
| 1271-374 | 598, 604 | 1271-495 | 599, 605 | 1273-113 | 648 |
| 1271-375 | 598, 604 | 1271-500 | 599, 605 | 1273-114 | 649 |
| 1271-380 | 598, 604 | 1271-501 | 599, 605 | 1273-115 | 650 |
| 1271-381 | 598, 604 | 1271-502 | 599, 605 | 1273-122 | 638 |
| 1271-382 | 598, 604 | 1271-503 | 599, 605 | 1273-123 | 638 |
| 1271-383 | 598, 604 | 1271-504 | 599, 605 | 1273-135 | 652 |
| 1271-384 | 598, 604 | 1271-505 | 599, 605 | 1273-146 | 652 |
| 1271-385 | 598, 604 | 1271-510 | 600, 605 | 1273-150 | 638 |
| 1271-390 | 598, 604 | 1271-511 | 600, 605 | 1273-150L | 638 |
| 1271-391 | 598, 604 | 1271-512 | 600, 605 | 1273-151 | 638 |
| 1271-392 | 598, 604 | 1271-513 | 600, 605 | 1273-152 | 638 |
| 1271-393 | 598, 604 | 1271-514 | 600, 605 | 1273-153 | 638 |
| 1271-394 | 598, 604 | 1271-515 | 600, 605 | 1273-154 | 638 |
| 1271-395 | 598, 604 | 1271-520 | 600, 605 | 1273-155 | 638 |
| 1271-400 | 599, 604 | 1271-521 | 600, 605 | 1273-156 | 638 |
| 1271-401 | 599, 604 | 1271-522 | 600, 605 | 1273-161 | 638 |
| 1271-402 | 599, 604 | 1271-523 | 600, 605 | 1273-162 | 651 |
| 1271-403 | 599, 604 | 1271-524 | 600, 605 | 1273-171 | 651 |
| 1271-404 | 599, 604 | 1271-525 | 600, 605 | 1273-1141 | 649 |
| 1271-410 | 599, 604 | 1271-530 | 601, 605 | 1404-842 | 721 |
| 1271-411 | 599, 604 | 1271-531 | 601, 605 | 1404-845A | 707 |
| 1271-412 | 599, 604 | 1271-532 | 601, 605 | 1404-845B | 707 |
| 1271-413 | 599, 604 | 1271-533 | 601, 605 | 1404-845D | 707 |
| 1271-414 | 599, 604 | 1271-534 | 601, 605 | 1404-846A | 707 |
| 1271-420 | 598, 604 | 1271-535 | 601, 605 | 1404-846B | 707 |

| | | | | | |
|-----------|----------|-----------|-----|------------|-----|
| 1404-846D | 707 | 2200-099P | 103 | 2200-383 | 116 |
| 1404-852 | 613 | 2200-100 | 103 | 2200-387 | 116 |
| 1404-853 | 613 | 2200-101 | 102 | 2200-389 | 116 |
| 1404-854 | 613 | 2200-101A | 102 | 2200-394 | 116 |
| 1404-855 | 703 | 2200-101F | 105 | 2200-396 | 116 |
| 1404-857 | 702 | 2200-102 | 102 | 2200-403 | 363 |
| 1404-858 | 702 | 2200-102A | 102 | 2200-405 | 363 |
| 1404-860 | 720 | 2200-102F | 105 | 2200-0459 | 113 |
| 1404-861 | 720 | 2200-103 | 102 | 2200-700 | 124 |
| 1404-862 | 612, 718 | 2200-103A | 103 | 2200-750 | 121 |
| 1404-865 | 720 | 2200-103F | 105 | 2200-752 | 121 |
| 1404-866 | 704 | 2200-104 | 102 | 2200-789 | 116 |
| 1404-870 | 378 | 2200-104F | 105 | 2200-790 | 116 |
| 1404-871 | 378 | 2200-105 | 102 | 2200-0902 | 103 |
| 1404-875 | 417 | 2200-105A | 102 | 2200-0912 | 103 |
| 1404-875L | 417 | 2200-105B | 102 | 2200-0922 | 103 |
| 1463-140 | 55 | 2200-105C | 105 | 2200-1112 | 102 |
| 1463-141 | 55 | 2200-106 | 103 | 2200-1112B | 105 |
| 1463-142 | 55 | 2200-107 | 102 | 2200-1112P | 102 |
| 1463-143 | 55 | 2200-107A | 103 | 2200-1132 | 102 |
| 1463-461 | 315 | 2200-107B | 105 | 2200-1132B | 105 |
| 1463-500 | 298 | 2200-107C | 103 | 2200-1133 | 102 |
| 1463-501 | 298 | 2200-107P | 102 | 2200-1151 | 153 |
| 1463-503 | 298 | 2200-108 | 102 | 2200-1365 | 108 |
| 1463-504 | 298 | 2200-108B | 105 | 2200-1431 | 109 |
| 1463-506 | 298 | 2200-108P | 102 | 2200-1441 | 109 |
| 1463-507 | 298 | 2200-109 | 102 | 2205-650 | 114 |
| 2200-015 | 110 | 2200-109B | 105 | 2205-655 | 114 |
| 2200-016 | 110 | 2200-110 | 102 | 2300-599 | 586 |
| 2200-017 | 110 | 2200-110P | 102 | 2300-600 | 587 |
| 2200-018 | 110 | 2200-111 | 102 | 2300-601 | 587 |
| 2200-029 | 113 | 2200-111P | 102 | 2300-602 | 587 |
| 2200-030 | 113 | 2200-112 | 102 | 2300-604 | 587 |
| 2200-032 | 113 | 2200-113 | 102 | 2500-313 | 185 |
| 2200-034 | 113 | 2200-114 | 101 | 2500-313T | 185 |
| 2200-036 | 113 | 2200-115 | 153 | 2500-315 | 185 |
| 2200-040 | 113 | 2200-117A | 153 | 2500-315T | 185 |
| 2200-041 | 113 | 2200-126 | 115 | 2500-320 | 185 |
| 2200-042 | 113 | 2200-129 | 108 | 2500-320T | 185 |
| 2200-043 | 113 | 2200-130 | 108 | 2600-302 | 127 |
| 2200-044 | 113 | 2200-131 | 108 | 2600-307 | 127 |
| 2200-045 | 113 | 2200-132 | 108 | 2600-311 | 127 |
| 2200-046 | 113 | 2200-133 | 108 | 2600-335 | 116 |
| 2200-047 | 113 | 2200-134 | 108 | 2600-339 | 116 |
| 2200-058 | 134 | 2200-135 | 108 | 2600-340 | 99 |
| 2200-060 | 134 | 2200-136 | 108 | 2600-341 | 99 |
| 2200-062 | 134 | 2200-137 | 108 | 2600-345 | 99 |
| 2200-064 | 134 | 2200-138 | 108 | 2600-350 | 98 |
| 2200-073B | 114 | 2200-140 | 108 | 2600-355 | 100 |
| 2200-073C | 114 | 2200-141 | 108 | 2600-357 | 100 |
| 2200-073D | 114 | 2200-141A | 108 | 2600-359 | 100 |
| 2200-074 | 103 | 2200-142 | 108 | 2600-361 | 100 |
| 2200-074B | 114 | 2200-144 | 108 | 2600-362 | 100 |
| 2200-075 | 103 | 2200-145 | 108 | 2600-364 | 100 |
| 2200-076 | 103 | 2200-146 | 108 | 2600-365 | 100 |
| 2200-077 | 103 | 2200-152 | 106 | 2600-367 | 100 |
| 2200-078 | 103 | 2200-152N | 106 | 2600-369 | 100 |
| 2200-079 | 103 | 2200-154 | 108 | 2600-370 | 100 |
| 2200-080 | 103 | 2200-155 | 108 | 2600-371 | 100 |
| 2200-081 | 103 | 2200-0175 | 110 | 2600-373 | 100 |
| 2200-085 | 103 | 2200-245 | 99 | 2600-374 | 100 |
| 2200-090 | 103 | 2200-361 | 111 | 2600-375 | 100 |
| 2200-091 | 103 | 2200-362 | 111 | 2600-376 | 100 |
| 2200-092 | 103 | 2200-362W | 111 | 2600-377 | 100 |
| 2200-096 | 103 | 2200-376 | 111 | 2600-379 | 100 |
| 2200-097 | 103 | 2200-377 | 111 | 2600-380 | 112 |
| 2200-098 | 103 | 2200-377W | 111 | 2600-381 | 112 |
| 2200-098P | 103 | 2200-378 | 111 | 2600-382 | 112 |
| 2200-099 | 103 | 2200-382 | 110 | 2600-384 | 107 |

| | | | | | |
|------------|----------|-----------|-----|------------|----------|
| 2600-385 | 107 | 2602-205 | 173 | 2700-501 | 178 |
| 2600-385S | 107 | 2602-206 | 173 | 2700-502 | 178 |
| 2600-387 | 107 | 2602-207 | 173 | 2700-504 | 187 |
| 2600-388 | 107 | 2602-208 | 173 | 2700-550NS | 147 |
| 2600-389 | 107 | 2602-209 | 173 | 2700-552NS | 147 |
| 2600-391 | 121 | 2602-210 | 174 | 2700-554NS | 147 |
| 2600-392 | 121 | 2602-211 | 174 | 2700-556NS | 147 |
| 2600-490 | 107 | 2602-212 | 174 | 2700-558NS | 147 |
| 2600-491 | 107 | 2602-300 | 170 | 2700-560NS | 147 |
| 2600-492 | 107 | 2602-301 | 170 | 2700-810 | 147 |
| 2600-492P | 107 | 2602-302 | 170 | 2700-812 | 147 |
| 2600-493 | 107 | 2602-303 | 170 | 2700-814 | 147 |
| 2600-493P | 107 | 2602-304 | 170 | 2700-815 | 147 |
| 2600-493P1 | 107 | 2602-305 | 171 | 2700-817 | 147 |
| 2600-494 | 107 | 2602-306 | 171 | 2700-819 | 147 |
| 2600-494A | 107 | 2602-307 | 171 | 2700-830NS | 141 |
| 2600-494D | 107 | 2602-308 | 171 | 2700-837NS | 146 |
| 2600-495 | 107 | 2602-1031 | 168 | 2700-839NS | 146 |
| 2600-496 | 107 | 2602-1051 | 169 | 2700-840NS | 146 |
| 2600-497 | 107 | 2602-1201 | 168 | 2700-842NS | 146 |
| 2600-498 | 99 | 2603-541 | 688 | 2700-844NS | 146 |
| 2600-499 | 99 | 2700-150 | 194 | 2700-850NS | 146 |
| 2600-565 | 99 | 2700-152 | 194 | 2700-852NS | 146 |
| 2600-618 | 271 | 2700-152T | 194 | 2700-854NS | 146 |
| 2600-3611 | 98 | 2700-153 | 194 | 2700-856NS | 146 |
| 2600-3641 | 98 | 2700-154 | 194 | 2700-858NS | 146 |
| 2600-3651 | 98 | 2700-154T | 194 | 2700-859NS | 146 |
| 2600-3714 | 100 | 2700-160 | 195 | 2700-860NS | 146 |
| 2600-5860 | 98 | 2700-162 | 195 | 2700-862NS | 145 |
| 2600-5862 | 98 | 2700-164 | 195 | 2700-864NS | 145 |
| 2600-5863 | 98 | 2700-165 | 195 | 2700-879NS | 144 |
| 2601-255 | 152 | 2700-166 | 195 | 2700-880NS | 144 |
| 2601-260 | 149 | 2700-168 | 195 | 2700-881NS | 144 |
| 2601-262 | 152 | 2700-170 | 195 | 2700-887 | 144 |
| 2601-264 | 152 | 2700-300 | 306 | 2700-890NS | 144 |
| 2601-270 | 149 | 2700-301 | 306 | 2700-891NS | 144 |
| 2601-274 | 149 | 2700-301R | 307 | 2700-900 | 138 |
| 2601-275 | 151 | 2700-302 | 306 | 2700-902 | 138 |
| 2601-278 | 151 | 2700-303R | 307 | 2700-902F | 138 |
| 2601-280 | 150 | 2700-304 | 306 | 2700-903NS | 138 |
| 2601-282 | 150 | 2700-306 | 306 | 2700-905 | 138 |
| 2601-283 | 150 | 2700-307R | 308 | 2700-906 | 138 |
| 2601-285 | 150 | 2700-308 | 308 | 2700-908NS | 138 |
| 2601-288 | 152 | 2700-308R | 308 | 2700-915 | 139 |
| 2601-289 | 152 | 2700-309 | 309 | 2700-918 | 138 |
| 2601-290 | 148 | 2700-310 | 200 | 2700-920 | 139 |
| 2601-291 | 148 | 2700-312 | 200 | 2700-922 | 139 |
| 2601-292 | 148 | 2700-314 | 200 | 2700-924NS | 139 |
| 2601-293 | 148 | 2700-390 | 311 | 2700-925 | 139 |
| 2601-294 | 153 | 2700-392 | 311 | 2700-930 | 145 |
| 2601-295 | 148 | 2700-394 | 311 | 2700-931 | 140 |
| 2601-295C | 148 | 2700-405 | 187 | 2700-940 | 140 |
| 2601-296 | 148, 149 | 2700-410 | 191 | 2700-947 | 145 |
| 2601-298 | 149 | 2700-412 | 191 | 2700-955 | 143 |
| 2601-299 | 149 | 2700-414 | 191 | 2700-959 | 145 |
| 2601-300 | 112 | 2700-416 | 191 | 2700-960 | 143 |
| 2602-100 | 168 | 2700-418 | 191 | 2700-965 | 141, 143 |
| 2602-101 | 168 | 2700-420 | 191 | 2700-967 | 143 |
| 2602-102 | 168 | 2700-422 | 191 | 2700-968 | 143 |
| 2602-103 | 168 | 2700-424 | 191 | 2700-968NS | 144 |
| 2602-104 | 169 | 2700-426 | 191 | 2700-974 | 142 |
| 2602-105 | 169 | 2700-428 | 191 | 2700-975 | 142 |
| 2602-106 | 169 | 2700-431 | 183 | 2700-978 | 140 |
| 2602-107 | 169 | 2700-432 | 183 | 2700-983 | 142 |
| 2602-200 | 172 | 2700-433 | 183 | 2700-984 | 142 |
| 2602-201 | 172 | 2700-450 | 182 | 2700-987 | 142 |
| 2602-202 | 172 | 2700-451 | 182 | 2700-988 | 142 |
| 2602-203 | 172 | 2700-470 | 182 | 2700-990 | 141 |
| 2602-204 | 173 | 2700-470A | 182 | 2700-990NS | 141 |

| | | | |
|-------------|----------|----------------|--------|
| 2700-995 | 145 | ST72-K | 31 |
| 2700-995NS | 145 | ST75 | 30 |
| 2700-8581NS | 146 | ST83 | 24 |
| 2700-8591NS | 146 | ST83-2 | 24 |
| 2700-8601NS | 146 | ST100 | 30 |
| 2700-8815NS | 144 | ST106 | 30 |
| 2700-8915NS | 144 | ST107 | 30 |
| 2800-450 | 183 | ST148 | 30 |
| 2800-451 | 183 | ST170-0 | 24 |
| 9B-010 . 39 | | ST170-2 | 24 |
| 9B-020 . 39 | | ST302-2 | 26 |
| 9B-025 . 39 | | ST402-2 | 25 |
| SC94-0312 | 623 | ST602-2 | 25 |
| SC94-0313 | 623 | ST952 . 24, 25 | |
| SC94-0314 | 623 | ST952-2 | 25 |
| SC94-0315 | 623 | ST952D-2 | 24 |
| SC94-0316 | 623 | ST953 . 24, 25 | |
| SC94-0317 | 623 | ST1002 . 25 | |
| SC94-0318 | 623 | ST1002-2 | 25 |
| SC94-0319 | 623 | ST1082-2 | 25 |
| SC94-0320 | 623 | ST1202 . 25 | |
| SC94-0321 | 623 | ST1202-2 | 25 |
| SC94-0322 | 623 | ST1311-2 | 24, 26 |
| SC94-0410 | 552 | ST1650-2 | 25 |
| SC94-0412 | 552 | ST2000-2 | 24, 26 |
| SC94-0415 | 552 | STE902 | 25 |
| SC94-0417 | 552 | STE1082 | 25 |
| SC94-0420 | 552 | STE1650 | 25 |
| SC94-0422 | 552 | STE1654 | 25 |
| SC94-03157 | 623 | STE2302 | 25 |
| SC94-03158 | 623 | STE2304 | 25 |
| SC94-03159 | 623 | STE06062 | 25 |
| SC95-0305 | 621 | STE06064 | 25 |
| SC95-0306 | 621 | STE06066 | 25 |
| SC95-0315 | 625 | STE10062 | 25 |
| SC95-0420 | 624, 625 | STE10064 | 25 |
| SC95-0421 | 624, 625 | STE10066 | 25 |
| SC95-0422 | 624, 625 | STE12062 | 26 |
| SC95-0423 | 624, 625 | STE12064 | 26 |
| SC95-0424 | 624 | STE12066 | 26 |
| SC95-0425 | 624 | STE12102 | 26 |
| ST2 | 31 | STE12104 | 24, 26 |
| ST3-926 | 28 | STE12106 | 26 |
| ST3-927 | 28 | STE20122 | 26 |
| ST3-929 | 28 | STE20124 | 24, 26 |
| ST3-930 | 28 | STE20126 | 24, 26 |
| ST6 | 27 | STP12102 | 24 |
| ST6G | 29 | STP12104 | 24 |
| ST8 | 27 | STP20122 | 24 |
| ST10 | 27 | STP20124 | 24 |
| ST10-F | 27 | STS12062 | 26 |
| ST10-F-PMT | 27 | STS12064 | 26 |
| ST12 | 27 | STS12066 | 26 |
| ST13-F | 27 | STS12102 | 26 |
| ST14G | 29 | STS12104 | 26 |
| ST14-K | 31 | STS12106 | 26 |
| ST15-20 | 27 | STS20122 | 26 |
| ST15-F | 27 | STS20124 | 26 |
| ST15-F-PMT | 27 | STS20126 | 26 |
| ST17-F | 27 | | |
| ST17-F-PMT | 27 | | |
| ST19-F | 27 | | |
| ST19-F-PMT | 27 | | |
| ST32-K | 31 | | |
| ST43 | 25 | | |
| ST43-2 | 25 | | |
| ST52 | 30 | | |
| ST63 | 25 | | |
| ST63-2 | 25 | | |

A

| | |
|---|-----|
| Abdominal Spatula | 236 |
| Adapter | |
| Power Drill Adapter for Sontec I.M. Pin | |
| Chuck | 506 |
| Aderer Wire Bending Pliers | 494 |
| Adson Bipolar Forceps | 138 |
| Adson Cerebella Retractor | 270 |

| | |
|--|----------|
| Adson-Derlacki Forceps | 133 |
| Adson Dressing Cross-Serrated Forceps | 133 |
| Adson Dressing Serrated Forceps | 131 |
| Adson Dressing TC Dust Forceps | 132 |
| Adson Dressing TC Serrated Platform Forceps | 132 |
| Adson Forceps with Skin Hook | 134 |
| Adson Harris Ring Tip Forceps | 136 |
| Adson-Harris Ring Tip Forceps Titanium | 127 |
| Adson Helms Forceps | 133 |
| Adson Periosteal Elevator | 376 |
| Adson Rongeur | 753 |
| Adson Suction | 313 |
| Adson Tissue Cross Serrated Forceps | 131 |
| Adson Tissue Forceps | 128 |
| Adson Tissue Forceps Titanium | 126, 127 |
| Adson Tissue Smooth Platform Forceps | 129 |
| Adson Tissue TC Dust Platform Forceps | 129 |
| Adson Tissue TC Serrated Platform Forceps | 130 |
| Allen Inge Stifle Retractor | 454 |
| Alligator Forceps | 63 |
| Alligator Forceps Tubular Shaft | 62 |
| Alligator Forceps with Malleable Shaft | 66 |
| Alligator Sterilizing Rack | 18 |
| Andrews Pynchon Suction | 309 |
| Anterior Spinal Curette | 546 |
| Anthony Suction | 309 |
| Anti-Buckle Wire Twister | 588 |
| AO Tap Cannulated | 513 |
| AO Type Bending Pliers Set | 437 |
| AO-Type Bone Reduction Clamp | 339 |
| AO Type Mallet | 410 |
| A.O. Type Universal Screw Driver | 499 |
| AO Type Universal Screwdriver Set | 501 |
| Arthroscopic | 603 |
| Arthroscopic Biopsy Grasping Forceps | 608, 609 |
| Arthroscopic Crocodile Grasping Forceps | 648 |
| Arthroscopic Curette & Ring Curette | 617 |
| Arthroscopic Dilation Needle | 624 |
| Arthroscopic Gawsling Basket Punch | 652 |
| Arthroscopic Grasping & Biopsy Combo Rongeur Forceps | 75 |
| Arthroscopic Grasping Forceps | 606, 607 |
| Arthroscopic Hook Probe | 618 |
| Arthroscopic Hook Probe with Conical Handle | 618 |
| Arthroscopic Hook Punch | 598 |
| Arthroscopic Low Profile Toothed Punch | 600 |
| Arthroscopic Maxi Grasper | 612 |
| Arthroscopic Meniscotomes Hook | 615, 616 |
| Arthroscopic Metzenbaum Hook Scissors | 602 |
| Arthroscopic Mini Grasper | 612 |
| Arthroscopic Mini Low Profile Hook Punch | 599 |
| Arthroscopic Mini Scissors | 603 |
| Arthroscopic Mini Scissors Forceps Biopsy Grasping Forceps | 603 |
| Arthroscopic Needle Holder | 610 |
| Arthroscopic Punch Rongeur | 605 |
| Arthroscopic Punch & Scissors | 604 |
| Arthroscopic Rasp | 618, 620 |
| Arthroscopic Right Left Side Punch | 601 |
| Arthroscopic Rottweiler Loosebody Grasping Forceps | 649 |

| | |
|---|----------|
| Arthroscopic Saber Scissor Punch | 652 |
| Arthroscopic Switch Stick | 623, 624 |
| Arthroscopic Velociraptor Biopsy Forceps | 651 |
| Arthroscopic Velociraptor Junior Biopsy Forceps | 651 |
| Aufranc Cobra Retractor | 462 |
| Avian Mini Wire Passer | 565 |
| Avian Nail Trimmer | 665 |
| Awl | |
| Daniel Nasal Awl | 522 |
| Liska Awl | 522 |
| Perthes Awl | 522 |
| Axel Wire Twister | 589 |

B

| | |
|--|-----|
| Babcock Bone Holding Clamp | 328 |
| Baby GOLD-CUT HERCULES® Pin Cutter | 572 |
| Baby Poole Suction | 312 |
| Bacon Duckbill Rongeur | 750 |
| Bailey Rongeur | 704 |
| Bane Single Action Rongeur | 748 |
| Barnes Mini Suction Tube | 297 |
| Baron Suction | 297 |
| Barrier Wrap | |
| Sontec Instrument Fabric Barrier Wrap 2PLY | 33 |
| Basin | |
| Emesis Basin | 27 |
| Basket Standard | 599 |
| Bayonet Bipolar Forceps | 141 |
| Bayonet Curette Titanium | 530 |
| Bayonet Forceps | 155 |
| Bayonet Nerve Hook | 183 |
| Bayonet Nerve Hook Titanium | 184 |
| Bayonet Ring Curette Titanium | 531 |
| Bayonet Spinal Knife Handle | 49 |
| Bayonet Suction Tube | 300 |
| Beasley-Babcock Tissue Forceps | 129 |
| Beatty Foraminotomy Rongeur | 674 |
| Beaver Blade Chuck Handle #3K | 45 |
| Beaver Blade Chuck Handle #3KD | 46 |
| Beckman-Adson Retractor | 273 |
| Beckman-Eaton Retractor | 277 |
| Beckman Retractor | 273 |
| Bender | |
| Black Vickers K-Wire Pin Bender | 423 |
| Sontec Pin Driver / Bender | 424 |
| Vickers Easy Driver / Bender / Puller | 422 |
| Bending Iron | |
| Mini Plate Bending Iron | 432 |
| Plate Bending Iron | 433 |
| Plate Bending Iron Lateral & Contour | 433 |
| Small Plate Bending Iron | 432 |
| Standard Plate Bending Iron | 432 |
| Bespoke Wroblewski Bone Trephine | 553 |
| Beyer Rongeur | 727 |
| Bio-Met Type Wire Twister | 592 |
| Bio-Met Wire Twister | 592 |
| Biopsy & Grasping Rongeur Forceps | 603 |
| Bipolar Bayonet Suction Wide Grip Forceps | 147 |
| Bipolar Bayonet Wide Grip Forceps | 146 |
| Bipolar Cord | |
| Reusable Bipolar Cord | 143 |
| Bircher-Ganske Cartilage Clamp | 358 |
| Bishop Bone Clamp | 332 |

| | |
|--|---------------|
| Bit | |
| Countersink Bit Cannulated | 513 |
| Black Monopolar Suction Tube | 147 |
| Black Ruskin Rongeur | 725 |
| Black Vickers K-Wire Pin Bender | 423 |
| Blade | |
| Blunt Blade | 228 |
| Caspar Blunt Smooth Blade | 216 |
| Caspar Serrated Lateral Blade | 215, 223 |
| Caspar V-Blunt Blade | 215 |
| Medial Blade | 216 |
| Round Blade | 228 |
| Scoville Lumbar Blade | 225 |
| Scoville Middle Lumbar Blade | 225 |
| SL - Connect Blunt Blade Titanium | 219 |
| SL - Connect Lateral Blade Titanium | 219 |
| Toothed Blade | 229 |
| Blade Holder | |
| Blake Blade Holder | 46 |
| Blade Insert Instrument | |
| SL - Connect Blade Insert Instrument | 218 |
| Blake Blade Holder | 46 |
| Blakesley Ethmoid Rongeur | 701 |
| Blakesley-Ethmoid Rongeur | 701 |
| Blumenthal Rongeur | 748 |
| Blunt Blade | 228 |
| Bone Chip Packer | |
| Hibbs Bone Chip Packer | 525 |
| Bone Clamp | |
| Kern Bone Clamp | 323 |
| Kern Hybrid Bone Clamp | 322 |
| Ulrich Bone Clamp | 321 |
| Ulrich Swivel Jaw Bone Clamp | 335 |
| Verbrugge Bone Clamp | 318, 319, 320 |
| Verbrugge Reverse Jaw Bone Clamp | 320 |
| Verbrugge-Rogalski Bone Clamp | 322 |
| Bone Cutter / Nail Nipper | 663 |
| Bone Forceps | |
| Sequestrum Sontec Bone Forceps | 326 |
| Bone Holding Forcep | |
| Stefan Bone Holding Forcep | 325 |
| Bone Holding Forceps | 347 |
| Bone Hook | |
| T-Handle Bone Hook | 520 |
| Bone Mill Set | 527 |
| Bone Pick Micro Fracture | 621 |
| Bone Reduction Clamp | 353 |
| Deluxe Bone Reduction Clamp | 347 |
| Schroeder Vulsellum Bone Reduction Clamp | 351 |
| Bone Reduction Clamp Extra Large | 338 |
| Bone Reduction Forceps | |
| Plate & Bone Reduction Forceps | 354 |
| Bone Reduction K-Wire Guide Clamp | 342 |
| Bone Scraper Set | 521 |
| Bone Tamp | 526 |
| Pin Driver & Bone Tamp | 423 |
| Bone Tunnel Borer | 515 |
| Bonney Tissue Forceps | 123 |
| Borer | |
| Bone Tunnel Borer | 515 |
| Bowl | |
| Sponge Bowl | 30 |
| Braake Tendon Knife | 419 |
| Brass Head Mallet | 406 |
| Braun Fixed Caliper | 55 |
| Braun-Ralph Suction | 309 |

| | |
|-------------------------------------|----------|
| Broni-Adson Forceps | 134 |
| Brown-Adson Cooley Forceps | 135 |
| Brown-Adson Tissue Forceps | 135 |
| Brown Adson Tissue Forceps Titanium | 134 |
| Brown-Cushing Bayonet Forceps | 158 |
| Brown Forceps | 136 |
| Brown Tissue Forceps | 109 |
| Bruns Hexagonal Handle Curette | 369 |
| Bruns Oval Cup Curette | 367, 368 |
| Bruns Ring Curette | 371 |
| Bruns Round Cup Curette | 366 |
| Bruns Solid Hexagonal Curette | 369 |
| Brush | |
| Whisk 'R Brush | 39 |
| Bryant Mitral Hook Retractor | 185 |
| Buie Suction Tube | 312 |
| Bunt Forceps Holder Ring | 35 |

C

| | |
|--|----------|
| Caliper | |
| Braun Fixed Caliper | 55 |
| Castroviejo Caliper | 52, 53 |
| House Ear Caliper | 55 |
| Jameson Caliper | 54 |
| Mini Caliper | 54 |
| Neuro Caliper | 232 |
| Orthopedic Vernier Caliper | 54 |
| Stahl Caliper | 55 |
| Thorpe Caliper | 54 |
| Camera | |
| Sontec proCam 4K Micro Camera System | 782 |
| Cannula | |
| Egress Cannula Set | 622, 623 |
| Inflow Cannula Set | 621 |
| Small Joint Arthroscopic Cannula | 624 |
| Carpentier Vascular Hook Titanium | 183 |
| Carrier | |
| Eyebrow Lifting Ligature Carrier | 165 |
| Facia Ligature Carrier | 165 |
| Sanders Brown Ligature Carrier | 165 |
| Carroll Tendon Pulling Forceps | 95 |
| Caspar Blade Removal Forceps | 217 |
| Caspar Blunt Smooth Blade | 216 |
| Caspar Cervical Vertebral Column Quick Release Retractor Frame | 218 |
| Caspar Cervical Vertebral Column Retractor Frame | 214 |
| Caspar Cervical Vertebral Retractor Frame | 210 |
| Caspar Counter Retractor | 223 |
| Caspar Distractor Vertebral Retractor | 220 |
| Caspar Drill Guide | 221 |
| Caspar Grasping Rongeur | 712 |
| Caspar Hand Universal Retractor | 217 |
| Caspar Lumbar Speculum | 222 |
| Caspar MIS Cervical Vertebral Column Retractor Frame | 213 |
| Caspar Nerve-Root Retractor | 227 |
| Caspar Screwdriver | 222 |
| Caspar Screw Post | 222 |
| Caspar Serrated Lateral Blade | 215, 223 |
| Caspar System Complete Set | 233 |
| Caspar Twist Drill | 222 |
| Caspar V-Blunt Blade | 215 |
| Cassio Ligature Carrier | 162 |

| | |
|---|--|
| Castroviejo Body Caliper 53 | Spinal Distractor/Compressor 279 |
| Castroviejo Caliper 52, 53 | Concave Nail Nipper 663 |
| Cast Spreader | Cone Ring Curette 370 |
| Henning Cast Spreader 523 | Cone Ring Two Handed Curette 536, 537 |
| Catheter Tray & Dome Lid Cover 24 | Cooley Vascular Tissue Forceps 106 |
| Cerclage Double Torpedo Type Wire Twister 593 | Cord |
| Cerclage Torpedo Type Wire Twister 591 | Disposable Bipolar Cord 143 |
| Charnley Curette 532 | CORD-1001 143 |
| Charnley Initial Incision Retractor 460 | CORD-2000 143 |
| Chisel | Cottle Lower Antrum Forceps 157 |
| Hibbs Chisel 386 | Cottle Mallet 407 |
| Sontec Chisel 387 | Cottle Plastic Osteotome 396 |
| Chondro Pick 620 | Councilman Bone Cutter 657 |
| Chuck | Countersink Bit Cannulated 513 |
| Collett Chuck for Knife Handle 48 | Coupland Suction Set 314 |
| Sontec Hybrid I.M. Pin Chuck 504 | Coupling |
| Sontec I.M. Pin Chuck 504 | Drill Bit Quick Coupling 513 |
| Sontec Keyless I.M. Pin Drill Chuck 505 | Cover |
| Chuck Handle | Stainless Steel Instrument Tray, Lid Cover & Perforated Nesting Sterilization Instrument Tray 24 |
| Beaver Blade Chuck Handle #3K 45 | Tip Cover 36 |
| Beaver Blade Chuck Handle #3KD 46 | Covers |
| Chuck Knife Handle #3HL 45 | Catheter Tray & Dome Lid Cover 24 |
| Cicherelli Rongeur 747 | Stainless Steel Instrument Tray & Lid Cover 25, 26 |
| Clamp . 338 | CSU Kloop Neuro Spatula 237 |
| AO-Type Bone Reduction Clamp 339 | CSU Meniscus Clamp 359 |
| Babcock Bone Holding Clamp 328 | Culler Neuro Round Handle Hook 180 |
| Bishop Bone Clamp 332 | Culler Neuro Round Handle Hook Titanium 181 |
| Bone Reduction Clamp 353 | Cup |
| Bone Reduction K-Wire Guide Clamp 342 | Iodine Cup 29 |
| DeBakey Meniscus Clamp 362 | Medicine Cup 31 |
| Doolen Bone Holding Clamp 331 | Curette |
| Ikuta Bone Clamp 350 | Anterior Spinal Curette 546 |
| Kristler Manus Bone Reduction Clamp 342 | Arthroscopic Curette & Ring Curette 617 |
| KUV Richards Bone Clamp 331 | Bayonet Curette Titanium 530 |
| Locke Bone Reduction Clamp 343 | Bayonet Ring Curette Titanium 531 |
| Mini Doolen Bone Holding Clamp 328 | Bruns Hexagonal Handle Curette 369 |
| Patella 2 x 2 Prong Bone Clamp 332 | Bruns Oval Cup Curette 367, 368 |
| Sontec Delicate Meniscus Clamp 361 | Bruns Ring Curette 371 |
| Sontec Meniscus Clamp 360 | Bruns Round Cup Curette 366 |
| Sontec Mesh Meniscus Clamp 362 | Bruns Solid Hexagonal Curette 369 |
| Verbrugge Reverse Jaw Bone Clamp 320 | Charnley Curette 532 |
| Classic Lempert Rongeur 745 | Cobb Spinal Curette 547 |
| Cleaner | Cone Ring Curette 370 |
| Endozime AW Triple Plus 40 | Cone Ring Two Handed Curette 536, 537 |
| F*A*C*T*S 41 | Down Pushing Curette 532 |
| Premixslip 40 | Extra Long Spinal Curette 534 |
| Prepzyme 41 | Hatt Spoon Curette 370 |
| Surgistain 40 | Jansen Curette 371 |
| Cleveland Rongeur 747 | Lampert Curette 530 |
| Cloward Cervical Retractor 228, 229 | Long Handle Curette 540 |
| Cloward Depth Gauge 520 | Micro Axial Bayonet Extra Long Curette 545 |
| Cloward Dura Hook 186 | Micro Axial Bayonet Long Curette 544 |
| Cloward Lamina Spreader 486 | Micro Axial Bayonet Regular Length Curette 543 |
| Cloward Vertebral Cervical Spreader Retractor 486 | Micro Spinal Curette 542 |
| Coaptation Bipolar Forceps 145 | Neuro Ring Curette 531 |
| Cobb Spinal Curette 547 | O'Brien Curette 532 |
| Cobb Spinal Elevator 200, 201 | Rhoton Curette 256 |
| Cobb Spinal Elevator with Unique Handle 202 | Spinal Curette 534 |
| Cobb Type Spinal Gouge 384 | Spinal Fusion Curette 546 |
| Collett Chuck for Knife Handle 48 | Stille Curette 366 |
| Collin Lucae Mallet 408 | Tear Drop Curette 539 |
| Combination Bone Rasp 767 | |
| Compressor | |
| Double-Action Compressor 281 | |
| Spinal Compressor 280, 281 | |

| | |
|--|---|
| Tear Drop Spinal Curette 533 | Ochsner-Sontec Straight Dissector 194 |
| Two Handed Curette 538, 539 | Olivecrona Dissector 195 |
| Two Handed Large Grip Curette 541 | Rhoton Circular Dissector 45° 254 |
| USA Curette 535 | Rhoton Dissector / Raspatory 254, 255 |
| USA Ring Curette 535 | Titanium Sontec Dissector 195 |
| Volkman Curette 371 | Yasargil Dissector Raspatory Titanium 194 |
| Cushing Bayonet Bipolar Forceps 140 | Dissectors |
| Cushing Bayonet Forceps 157 | Ochsner Dissector 194 |
| Cushing Bipolar Forceps 145 | Distractor |
| Cushing Brain Depressor Spatula 237 | Double-Action Distractor 281 |
| Cushing Dressing Bayonet Forceps 157 | Foremann Kwire Distractor 451, 452 |
| Cushing Dura Hook 186 | Mini Foremann Distractor 453 |
| Cushing Forceps Titanium 116 | Spinal Distractor 279, 280 |
| Cushing Pituitary Rongeur 708, 711 | Spinal Distractor/Compressor 279 |
| Cushing Rongeur 752 | Distractor, Foremann Kwire 451, 452 |
| Cushing Tying Forceps 116 | Doolen Bone Holding Clamp 330, 331 |
| Cutter | Doolen Neuro Hook 178 |
| Large Pin / Bolt Cutter 574 | Double-Action Compressor 281 |
| Micro Double Action Wire Cutter 573 | Double-Action Distractor 281 |
| Rod Cutter 578 | Double Action Wire Cutter 573, 576 |
| Rod Flush Cutter 579 | Double Drill Guide 514 |
| Table Top Rod Cutter 583 | Double-Ended Rasp 756 |
| Cutters | Down Pushing Curette 532 |
| Councilman Bone Cutter 657 | Dressing Jar 31 |
| Plate Cutter for Titanium Plates 568 | Drill |
| Stille-Horsley Bone Cutter 660 | Caspar Twist Drill 222 |
| Cylindrical Osteotome | Micro Tap/ Drill Sleeve 512 |
| Shepard Cylindrical Osteotome 552 | Tap/ Drill Sleeve 512 |

D

| | |
|--|---|
| Dandy Nerve Hook 184 | Daniell Drill Guide 511 |
| Daniel Nasal Awl 522 | Caspar Drill Guide 221 |
| Davis Brain Black Silicone Spatula 240 | Double Drill Guide 514 |
| Davis Brain Spatula 239, 241 | Parallel Drill Guide 514 |
| Davis Stifle Retractor 454 | Taylor Drill Guide 512 |
| DeBakey-Adson Tissue Forceps 127 | Universal Drill Guide 510 |
| DeBakey Angled Tissue Forceps 103 | Drill Guides |
| DeBakey Bayonet Forceps 153 | Valkyrie Mach Holder / Drill Guide 515 |
| DeBakey Ergonomic-Handle Forceps 105 | Driver |
| DeBakey Ergonomic-Handle Forceps Titanium 105 | K-Wire Pin Driver 510 |
| DeBakey Forceps Titanium 98 | Piermattei Pin Bender / Driver 426 |
| DeBakey Meniscus Clamp 362 | Vickers Easy Driver / Bender / Puller 422 |
| DeBakey Mosquito Forceps 363 | Duckbill Ear Alligator Forceps 65 |
| DeBakey Needle-Pulling Tissue Forceps 103 | Duehrssen Tissue Forceps 124 |
| DeBakey Needle Pulling Tissue Forceps Titanium 98 | Durrani Dorsal Vein Complex Ligation Needle 162 |
| DeBakey Premier Knurled Handle Forceps Titanium 99 | |
| DeBakey Thoracic Forceps 104 | |
| DeBakey Tissue Forceps 102 | |
| DeBakey Tissue Forceps Titanium 100 | |
| DeBakey Vascular Forceps 101 | |
| DeBakey Vascular Forceps Titanium 98 | |
| Decker Micro Rongeur 719 | |
| Defourmentel Rongeur 750 | |
| Deluxe Bone Reduction Clamp 347 | |
| Depressor | |
| Cushing Brain Depressor Spatula 237 | |
| Depth Gauge 518 | |
| Depth Gauge EZ Clean 519 | |
| Deschamps Ligature Carrier 164 | |
| Dietrich-DeBakey Tissue Forceps 101 | |
| Dilation Needle 624 | |
| Disposable Bipolar Cord 143 | |
| Dissector | |
| Lemmon Dissector 195 | |

| | |
|---|--|
| Freer Periosteal Elevator 374, 375, 376 | Hoer Periosteal Elevator 377 |
| Joker Periosteal Elevator 379 | Key Periosteal Elevator 378 |
| Lane Periosteal Elevator 377 | Langenbeck Periosteal Elevator 377 |
| Love Adson Periosteal Elevator 376 | McIlwraith Periosteal Elevator 378 |
| Nelms Suction Elevator 200 | Piermattei Shoulder Elevator 379 |
| Sayre Elevator 379 | Sedillot Elevator 379 |
| Sontec A O Type Elevator / Raspatory 380, 381 | Sontec Lane Lever Elevator 477 |
| Sontec Periosteal Elevator Titanium 200 | Williger Periosteal Elevator 379 |
| Yasargil Bayonet Elevator Titanium 200 | Elevators |
| Foerner Sesamoid Knife Elevator 417 | Emesis Basin 27 |
| End Cutter | Pin End Cutter 577 |
| Endozime AW Triple Plus® 40 | End Pin Cutter 570 |
| Entner Ligature Carrier 164 | Ethmoid Pediatric Rongeur 700 |
| Evans Tissue Forceps 110 | Extensions |
| Sontec I.M. Pin Chuck Extensions 507 | Extra 534 |
| Eye Brow Lifting Ligature Carrier 165 | |

| | |
|--|---|
| Facia Ligature Carrier 165 | F*A*C*T*S® 41 |
| Feline Nail Cutters 665 | Femoral Head Disarticulator Knife 416 |
| Ferlit Micro Forceps 122 | Ferris-Smith Arthroscopic Rongeur 713, 714, 715 |
| Ferris-Smith Arthroscopic Rongeur Boyonet 718 | Ferris-Smith Arthroscopic Ultra-Low Profile Rongeur with Enhanced Jaw Power 717 |
| Ferris Smith Rod Holder 490 | Ferris-Smith Rongeur 716 |
| Ferris-Smith Spinal Extended Shaft Rongeur 717 | Ferris-Smith Tissue Forceps 119 |
| Ferris-Smith Wilde Rongeur 716 | File |
| Long Handle File 260, 775 | Sontec Spinal File/Rasp 774 |
| Finger Goniometer 53 | Finsen Self-Retaining Retractor 459 |
| Flush Cut Pin Cutter 580 | Foerner Sesamoid Knife Elevator 417 |
| Foerner Sesamoid Knife Elevator 417 | Foman Rasp 759 |
| Foman "R" Rasp 760 | Foman TC Insert Rasp 757 |
| Foman TC Insert Rasp Angled 758 | Foman Rasp 757 |
| Fomon Rasp 757 | Forcep |
| Side Biting Alligator 63 | |

| | |
|---|--|
| Forceps 603 | Adson Bipolar Forceps 138 |
| Adson-Derlacki Forceps 133 | Adson Dressing Cross-Serrated Forceps 133 |
| Adson Dressing Serrated Forceps 131 | Adson Dressing TC Dust Forceps 132 |
| Adson Dressing TC Serrated Platform Forceps 132 | Adson Forceps with Skin Hook 134 |
| Adson Harris Ring Tip Forceps 136 | Adson-Harris Ring Tip Forceps Titanium 127 |
| Adson Helms Forceps 133 | Adson Tissue Cross Serrated Forceps 131 |
| Adson Tissue Cross Serrated Forceps Titanium 126, 127 | Adson Tissue Forceps Titanium 129 |
| Adson Tissue Smooth Platform Forceps 129 | Adson Tissue TC Serrated Platform Forceps 130 |
| Alligator Forceps 63 | Alligator Forceps Tubular Shaft 62 |
| Alligator Forceps with Malleable Shaft 66 | Arthroscopic Biopsy Grasping Forceps 608, 609 |
| Arthroscopic Crocodile Grasping Forceps 648 | Arthroscopic, Forceps, Biopsy & Grasping Rongeur Forceps 603 |
| Arthroscopic Grasping & Biopsy Combo Rongeur Forceps 75 | Arthroscopic Grasping Forceps 606, 607 |
| Arthroscopic Rottweiler Loosebody Grasping Forceps 649 | Arthroscopic Velociraptor Biopsy Forceps 651 |
| Arthroscopic Velociraptor Junior Biopsy Forceps 651 | Bayonet Bipolar Forceps 141 |
| Bayonet Forceps 155 | Beasley-Babcock Tissue Forceps 129 |
| Bipolar Bayonet Suction Wide Grip Forceps 147 | Bipolar Bayonet Wide Grip Forceps 146 |
| Bone Holding Forceps 347 | Bonney Tissue Forceps 123 |
| Broli-Adson Forceps 134 | Brown-Adson Cooley Forceps 135 |
| Brown-Adson Tissue Forceps 135 | Brown Adson Tissue Forceps Titanium 134 |
| Brown-Cushing Bayonet Forceps 158 | Brown Forceps 136 |
| Brown Tissue Forceps 109 | Carroll Tendon Pulling Forceps 95 |
| Caspar Blade Removal Forceps 217 | Coaptation Bipolar Forceps 145 |
| Cooley Vascular Tissue Forceps 106 | Cottle Lower Antrum Forceps 157 |
| Cushing Bayonet Bipolar Forceps 140 | Cushing Bayonet Forceps 157 |
| Cushing Bipolar Forceps 145 | Cushing Dressing Bayonet Forceps 157 |
| Cushing Dressing Bayonet Forceps 157 | Cushing Forceps Titanium 116 |
| Cushing Tying Forceps 116 | DeBakey-Adson Tissue Forceps 127 |

DeBakey Angled Tissue Forceps 103
 DeBakey Bayonet Forceps 153
 DeBakey Ergonomic-Handle Forceps. 105
 DeBakey Ergonomic-Handle Forceps Titanium 105
 DeBakey Forceps Titanium 98
 DeBakey Mosquito Forceps 363
 DeBakey Needle-Pulling Tissue Forceps 103
 DeBakey Needle Pulling Tissue Forceps Titanium 98
 DeBakey Premier Knurled Handle Forceps Titanium 99
 DeBakey Thoracic Forceps 104
 DeBakey Tissue Forceps. 102
 DeBakey Tissue Forceps Titanium 100
 DeBakey Vascular Forceps 101
 DeBakey Vascular Forceps Titanium. 98
 Dietrich-DeBakey Tissue Forceps. 101
 Duckbill Ear Alligator Forceps. 65
 Duehrssen Tissue Forceps 124
 Electro Blue Coated Cushing Bayonet Tissue Forceps 158
 Electro Blue Coated DeBakey Forceps 105
 Electro Blue Coated Potts-Smith Tissue Forceps 114
 Electro Blue Coated Skinner Tissue Forceps 118
 Evans Tissue Forceps 110
 Ferlit Micro Forceps. 122
 Ferris-Smith Tissue Forceps 119
 Foreign Body Removal / Grasping Forceps 85
 Fraenkel Laryngeal Forceps 87
 Frontal Sinus Giraffe Forceps 78, 79, 80, 81, 82, 83, 84
 Gerald Bayonet Bipolar Forceps. 141
 Gerald Bayonet Forceps 153
 Gerald Brown Tissue Forceps. 106
 Gerald Lightweight Micro Tissue Forceps Titanium 107
 Gerald Tissue Forceps. 106, 108
 Gillies Forceps 124
 Goodhill Alligator Forceps. 66
 Goodhill Ear Forceps. 71
 Gorney-Adson Forceps 127
 Greven Alligator Forceps. 65
 Gruenwald (Jansen) Ear Forceps. 159
 Hardy Bayonet Bipolar Forceps 141, 145
 Hardy Bayonet Coagulation Forceps 143
 Harris Ring Tip Forceps. 137
 Hartman Alligator Forceps. 61, 72
 Hartman Ear Forceps 93
 Hartmann Ear Alligator Forceps 90
 Hartmann Nasal Alligator Forceps 89
 Hartmann-Noyes Alligator Forceps 74
 Heyman Septum Alligator Forceps 89
 Hypophyseal Bayonet Forceps 156
 Jackson / Biopsy Forceps 88
 Jacobson Micro Bayonet Forceps 156
 Jansen Bayonet Ear Forceps Titanium. 159
 Jansen Bipolar Forceps. 144
 Jensen Bipolar Bayonet Irrigation Forceps 144
 Jewelers Bipolar Forceps 138, 139

Jewelry-McPherson Bipolar Forceps 139
 Jurasz Laryngeal Forceps 86
 Liston Bone Cutting Forceps. 656
 Long Tissue Forceps 125
 Lucae Ear Forceps. 155
 McGravey Tissue Forceps. 109
 McIndoe Bone Cutting Forceps 658
 McIndoe Dressing and Tissue Forceps 121
 McIndoe Forceps Titanium 121
 McPherson Bipolar Forceps 139
 Meniscus Grasping Forceps 613
 Micro Alligator Grasping Forceps 71
 Micro Bayonet Forceps 154
 Micro Biopsy Forceps with Flexible Tubular Shaft 74
 Micro Ear Alligator Forceps. 68, 69, 70
 Micro Gerald Tissue Forceps 109
 Micro House Alligator Forceps 64
 Micro House Biopsy Alligator Forceps 73
 Micro Round Handle 6" Forceps Titanium 172
 Micro Round Handle Forceps Titanium 173
 Micro Sontec Alligator Forceps 67, 72
 Micro Straight Round Handle Forceps Titanium 174
 Micro Tying Forceps 99
 Micro Tying Forceps Titanium 99
 Nadler Coaptation Bipolar Forceps. 140
 Oehler Forceps 119
 Original DeBakey Forceps. 101
 Potts Cooley Tissue Forceps. 114
 Potts Nevins Forceps. 115
 Potts-Smith Dressing Forceps. 115
 Potts-Smith Tissue Forceps. 113
 Potts-Smith Tissue Forceps. 115
 Raleigh Bone Holding Forceps 345
 Reil Bone Holding Forceps 340
 Resano Brown Vascular Forceps 111
 Resano Brown Vascular Forceps Titanium 112
 Resano Double Action Vascular Forceps Titanium 112
 Reul Coronary Artery Forceps. 115
 Rottweiler Junior Loosebody Grasping Forceps 650
 Ruskin-Liston Bone Cutting Forceps. 656
 Russian Adson Micro Forceps 137
 Russian Tissue Forceps. 109
 Scoville Bayonet Bipolar Forceps 143
 Scoville Bipolar Forceps 144
 Screw Holding Forceps 501
 Selman Tissue Forceps. 110
 Semken Forceps 118
 Sheen Fragment Retriever Forceps 707
 Side Biting Alligator Forceps. 63
 Silver Ear Dressing Alligator Forceps 91
 Singley Tuttle Forceps 110
 Skinner Tissue Forceps. 117
 Sontec Alligator Forceps 60, 62
 Sontec D'Errico Tissue Forceps 109
 Sontec Forceps Holder 34
 Sontec Micro Alligator Forceps. 61
 Sontec Micro Biopsy Forceps 87

Sontec Septal Platform Forceps 94
 Sontec Septal Platform Forceps Titanium 94
 Stefan Mini Bone Holding Forceps 324
 Stille-Adson Dressing Forceps 136
 Stille-Adson Tissue Forceps 136
 Stille-Liston Bone Cutting Forceps 657
 Tenzel Bipolar Forceps 139
 Thumb Dressing Forceps 122
 Thumb Forceps Titanium. 117
 Tissue Bipolar Forceps 145
 Tissue Forceps with TC Inserts 117
 Tissue Forceps with Teeth 120
 Titanium Bayonet Bipolar Forceps 143
 Tobey Ear Dressing Forceps. 92
 Troutman Micro Hook Forceps 126
 Wangenstein Tissue Forceps. 110
 Wilde Ear Forceps 155
 Yasargil Atrauma Forceps 155
 Yasargil Bayonet Bipolar Forceps 142
 Yasargil Bayonet Forceps Titanium 152
 Yasargil Forceps Titanium 148, 149
 Yasargil Micro Bayonet Forceps 154
 Yasargil Micro Forceps Titanium 150, 153
 Yasargil Tumor Bayonet Forceps. 154
 Yasargil Tumor Grasping Bayonet Forceps 156
 Yasargil Tumor Grasping Bayonet Forceps Titanium 152
 Yasargil Tumor Grasping Forceps Titanium 151
 Foreign Body Removal / Grasping Forceps 85
 Fraenkel Laryngeal Forceps. 87
 Frame Caspar MIS Cervical Vertebral Column Retractor Frame 213
 Frazier Angled Suction 286, 287, 288, 289
 Frazier Dorsey Dura Separator 178
 Frazier Insulated Suction 291
 Frazier Lamina Retractor 275
 Frazier-Rhoton Angled Suction. 292
 Frazier Straight Suction 290
 Freer/Pennington Extra Long Spinal Elevator 203
 Freer Periosteal Elevator. 374, 375, 376
 Frontal Sinus Giraffe Forceps. 78, 79, 80, 81, 82, 83, 84
 Frontal Sinus Giraffe Punch 77
 Fukushima Suction 294, 295

G

Gallaher Bone Rasp Set 768
 Galt Trepheine 551
 Gauge
 Cloward Depth Gauge. 520
 Depth Gauge 518
 Depth Gauge EZ Clean 519
 Measuring Gauge 513
 Mini Depth Gauge 520
 Stahl A/C Lens Gauge. 55
 TPLO Double-Ended Gauge 57
 Gelpi
 Gelpi Offset Arm Left & Right. 449
 Gelpi 1st Generation Deep Angle Retractor 448

Gelpi Classic Retractor 444, 445
 Gelpi Deep Angle Neroma (Crossover) Retractor 443
 Gelpi Deep Angle Retractor 440
 Gelpi Neroma (Crossover) Retractor 442
 Gelpi Offset Arm Left & Right 449
 Gelpi Original Spinal Retractor. 264
 Gelpi Retractor 441, 446, 447, 450
 Gelpi Retractor Titanium 265
 Gelpi Spinal Retractor 265, 266, 267, 275
 Gerald Bayonet Bipolar Forceps 141
 Gerald Bayonet Forceps. 153
 Gerald Brown Tissue Forceps 106
 Gerald Lightweight Micro Tissue Forceps Titanium 107
 Gerald Tissue Forceps 106, 108
 Gersten Traction Bar 334
 Gillies Forceps 124
 Glabella Masing Rasp 770
 GOLD-CUT HERCULES Front & Side Pin Cutter 582
 GOLD-CUT HERCULES Pin Cutter. 571
 Goniometer
 Finger Goniometer. 53
 Good Bone Rasp 768
 Goodhill Alligator Forceps 66
 Goodhill Ear Forceps 71
 Gorney-Adson Forceps. 127
 Gouge
 Cobb Type Spinal Gouge 384
 Hibbs Gouge 386
 Lexer Gouge 385
 Mini Lexer Gouge. 385
 Sontec Micro Gouge 384
 Graft Passer Ligature Carrier 163
 Graham Dura Hook. 187
 Grasper
 Arthroscopic Mini Grasper. 612
 Greven Alligator Forceps 65
 Gruenwald (Jansen) Ear Forceps. 159
 Gubisch Surgical Pen Replacement Tip. 49
 Gubish Surgical Pen Holder Set. 48

H

Hakansson Rongeur 743
 Handle
 Kerrison Universal Rotating 360° Rongeur Handle 672
 Self-Locking 3K Chuck Blade Handle. 49
 Sontec I.M. Pin Chuck Aluminum Handle 505
 Sontec I.M. Pin Chuck T-Handle 506
 Sontec Knife Handle #3XXL 45
 Staley Round Knurled Knife Handle 45
 Universal Adjustable Angle Knife Handle #3. 44
 Wide Barrel Grip Knife Handle #3. 44
 Handles
 Chuck Knife Handle #3HL. 45
 Hand Surgery Osteotome. 394
 Hardt Micro Cartilage Osteotome Set (with bag) 398
 Hardt Micro Cartilage Osteotome Set (with tray) 398
 Hardt Micro Ceramitec Osteotome. 400
 Hardy Bayonet Bipolar Forceps 141, 145
 Hardy Bayonet Coagulation Forceps 143
 Harris Ring Tip Forceps 137

Hartman Alligator Forceps 61, 72
 Hartman Ear Forceps 93
 Hartmann Ear Alligator Forceps 90
 Hartmann Nasal Alligator Forceps 89
 Hartmann-Noyes Alligator Forceps 74
 Hartman Rongeur 751
 Hatt Spoon Curette 370
 Headlight
 Sontec Elite Wireless LED Headlight 778, 779
 Sontec LED Plus+ Headlight 780
 Sontec Magnum LED Headlight 781
 Heartline Nerve & Vessel Hook. 183
 Heartline Ross Sump Sucker 311
 Heartline Ross Ventricular Vent 311
 Heavy Nail Nipper 662
 Heavyweight Mallet. 410
 Henning Cast Spreader 523
 Herbst-Doolen Wire Passer 564
 Herbst Wire Passer 564
 HERCULES GRIP Pin Puller 428
 Hess Nerve Retractor 250
 Hexagonal Screw Driver 498
 Heyman Septum Alligator Forceps. 89
 Hibbs Bone Chip Packer 525
 Hibbs Chisel 386
 Hibbs Gouge. 386
 Hibbs Osteotome 392
 Hibbs Retractor. 464
 Hip & Knee Retractor 478
 Hip Reduction Clamp 355
 HL MIS Retractor Frame Medium. 214
 Hoen Grasping Forceps 718
 Hoen Periosteal Elevator 377
 Hohman Elevator Retractor 476
 Hoke Osteotome. 395
 Holder
 Bunt Forceps Holder Ring. 35
 Ferris Smith Rod Holder 490
 Holding Device
 Pashley Pipe Suction Tube Holding Device 315
 Hook 599, 614
 Arthroscopic Hook Probe 618
 Bayonet Nerve Hook 183
 Bayonet Nerve Hook Titanium. 184
 Carpentier Vascular Hook Titanium. 183
 Cloward Dura Hook 186
 Culler Neuro Round Handle Hook 180
 Culler Neuro Round Handle Hook Titanium 181
 Cushing Dura Hook 186
 Dandy Nerve Hook 184
 Doolen Neuro Hook 178
 Graham Dura Hook 187
 Heartline Nerve & Vessel Hook 183
 Jacobson Hook 255
 Kraysenbuehl Nerve Hook 178
 Kraysenbuehl Nerve Hook Extra Long Version. 178
 Kraysenbuehl Nerve Hook Titanium 182
 Lucae Ear Hook 184
 McIlwraith Arthroscopic Hook Probe. 619
 Micro Hook Titanium 187
 Nerve Hook Titanium. 186
 Rhoton Hook 256
 Sontec Nerve Hook Titanium. 182
 Taylor Micro Arthroscopic Hook Probe & Pick. 619

Triangle Handle Arthroscopic Meniscope, Hook, Probe & Knife 614
 Wagner Hook 186
 Yasargil Galea Spring Neuro Hook 187
 Hook Punch 611
 Hooks 614
 Nerve & Vessel Hook Titanium 182
 Taylor Micro Arthroscopic Hook Probe 619
 House-Baron Suction 304
 House Cutoff Suction Adapter 303
 House Ear Caliper. 55
 House Irrigator/Suction. 305
 Howard Bone Rasp Double-Ended Single-Side 760
 Hybrid Herbst Wire Passer 563
 Hypophyseal Bayonet Forceps 156
I
 Ikuta Bone Clamp 350
 Inflow Cannula Set 621
 Inge Lamina Retractor. 487
 Inge Lamina Spreader 482, 483
 Inge Lamina Spreader Extra Large Retractor. 484
 Inge Micro Ring Handle Lamina Spreader 485
 Inge Neroma Retractor 455
 Ingrown Nail Forcep 663
 Ingrown Nail Splitting Scissors. 664
 Instrument Tray 27
 Iodine Cup. 29
 Irrigator
 House Irrigator/Suction 305
J
 Jackson / Biopsy Forceps 88
 Jacobson Button End Hook Probe. 257
 Jacobson Button End Probe 256
 Jacobson Hook 255
 Jacobson Hook Probe 257
 Jacobson Micro Bayonet Forceps 156
 Jacobson Respiratory/Probe Set 191
 Jameson Caliper 54
 Jansen Bayonet Ear Forceps Titanium 159
 Jansen Bipolar Forceps 144
 Jansen Curette 371
 Jar
 Dressing Jar. 31
 Jensen Bipolar Bayonet Irrigation Forceps 144
 Jet Wire Twister 593
 Jeurs Lempert Neuro Rongeur. 746
 Jewelers Bipolar Forceps 138, 139
 Jewelers-McPherson Bipolar Forceps 139
 Joker Periosteal Elevator 379
 JPS Bone File 261, 775
 Jurasz Laryngeal Forceps. 86
K
 Kelly Retractor 472
 Kern Bone Clamp 323
 Kern Hybrid Bone Clamp 322
 Kerrison
 Kerrison 40° Rongeur Titanium. 688
 Kerrison 40° Laminectomy/Lumbar 678
 Kerrison 40° Rongeur. 675, 679, 683

Kerrison 40° Rongeur Titanium 688
 Kerrison 90° Rongeur 676, 680
 Kerrison 90° Rongeur 677
 Kerrison Bayonet 40° Rongeur 684, 685
 Kerrison Bayonet Foraminotomy Rongeur . 686
 Kerrison Convertible 40° Rongeur 687
 Kerrison Punch (Occular-plasti) 40° Rongeur . 691
 Kerrison Punch (Occular-plasti) 90° Rongeur . 690
 Kerrison Universal Rotating 360° Rongeur . 669, 670, 671
 Kerrison Universal Rotating 360° Rongeur Handle 672
 Key Periosteal Elevator 378
 Killian (Von Eicken) Suction 313
 Kistler Ear Cartilage Rasp 770
 Kleinert-Kutz Duckbill Synovectomy Rongeur . 725
 Kleinert-Kutz Rongeur 741
 Knife
 Arthroscopic Meniscotomes Hook, Probe & Knife 615, 616
 Braake Tendon Knife 419
 Femoral Head Disarticulator Knife 416
 Nixon XXL Banana Knife 419
 Rosin Root Meniscotome 418
 Smillie Meniscus 418
 Triangle Handle Arthroscopic Meniscotome, Hook, Probe & Knife 614
 Knife Handle
 Bayonet Spinal Knife Handle 49
 Knife Handle #3 44
 Knife Handle #3KL 45
 Knife Handle #3L 45
 Knife Handle #4 46
 Knife Handle #4L 47
 Knife Handle #7 47
 Knife Handle #9 48
 Siegel Knife Handle 48
 Knife Handle #3 44
 Knife Handle #3KL 45
 Knife Handle #3L 45
 Knife Handle #4 46
 Knife Handle #4L 47
 Knife Handle #7 47
 Knife Handle #9 48
 Knives
 Smillie Meniscus Knife 418
 Kraysenbuehl Nerve Hook 178
 Kraysenbuehl Nerve Hook Extra Long Version . 178
 Kraysenbuehl Nerve Hook Titanium 182
 Kristler Manus Bone Reduction Clamp . 342
 Kujat Shoulder Retractor 461
 Kurtz Cutt-Off Suction Adapter 303
 KUV Richards Bone Clamp 331
 K-Wire Pin Driver 510

L
 Lahey Retractor 463
 Lambert-Lowman Bone Holding Clamp. 334
 Lambotte Osteotome 393
 Lamina Spreader
 Inge Micro Ring Handle Lamina Spreader . 485

Lampert Curette 530
 Lane Periosteal Elevator 377
 Langenbeck Periosteal Elevator 377
 Large Pin / Bolt Cutter 574
 Large Sontec Combo Mallet 407
 Lateral Plate Bending Pliers 435
 Lead Hand Stabilizing Restrainer 479
 Leksell Bayonet Rongeur 730
 Leksell Duckbill Rongeur 729
 Leksell Extended Bone Rongeur 737
 Lemmon Dissector 195
 Lever
 Sontec Stifle Thrust Lever 463
 Levesque Neuro Rongeur 746
 Lewin Bone Reduction Clamp 346
 Lexer Gouge 385
 Lexer Osteotome 400, 401
 Lid Cover & Perforated Nesting Sterilization Instrument Tray 24

Lids
 Stainless Steel Instrument Tray & Lid Cover . 26
 Ligature Carrier
 Cassio Ligature Carrier 162
 Deschamps Ligature Carrier 164
 Entner Ligature Carrier 164
 Graft Passer Ligature Carrier 163
 Reverdin Needle/Ligature Carrier 162
 Schmieden-Dick Ligature Carrier 164
 Sontec Reverdin Blunt Needle/Ligature Carrier 162
 Tendon Passer Ligature Carrier 163
 Lighted Smith Nerve Retractor 248
 Liska Awl 522
 Liston Bone Cutting Forceps 656
 Locke Bone Reduction Clamp 343
 Locke CSU Bone Reduction Clamp 344
 Long Handle Curette 540
 Long Handle Curette & Elevator 540
 Long Handle File 260, 775
 Long Tissue Forceps 125
 Loute Wire Twister 592
 Love Adson Periosteal Elevator 376
 Love Gruenwald Pituitary Rongeur 711
 Love-Gruenwald Pituitary Rongeur 709
 Love Nerve Root Retractor 244, 246
 Lowman Bone Clamp 333
 Lowman Bone Holding Clamp 333
 Lubra Screw Driver 499
 Lucae Ear Forceps 155
 Lucae Ear Hook 184
 Lumbar & Cervical Impactor 524
 Lumbar Implant Holder/ Disk Marker . 525

M

Mach Holders
 Valkyrie Mach Holder / Drill Guide 515
 Maltz Improved Double Ended Rasp . 765
 Malleable Ribbon Retractor 465, 466
 Mallet
 AO Type Mallet 410
 Brass Head Mallet 406
 Collin Lucae Mallet 408
 Cottle Mallet 407
 Heavyweight Mallet 410
 Large Sontec Combo Mallet 407
 Mead Mallet 406
 No Recoil Mallet 412

Phenolic Spinal Mallet 413
 Sontec Combo Nylon Mallet 404
 Sontec Double Nylon Mallet 405
 Sontec Large Handle Mallet 411
 Sontec Large Mallet 409
 Sontec Micro Mallet 405
 USA Model Mallet 408
 Maltz Single-Ended Rasp 764
 Marquardt Neuro Rongeur 730
 Martin Cartilage Clamp 358
 Masing Rasp 771
 Mat
 Silicone Mat 15
 Mathieu Retractor 463
 McCollough Twist Fomon Raspatory . 765
 McCullough Retractor Set 230, 231
 McGravey Tissue Forceps 109
 Mcllwraith 619
 Mcllwraith Arthroscopic Grasping Rongeur . 720, 721
 Mcllwraith Arthroscopic Hook Probe . 619
 Mcllwraith Arthroscopic Scissors Rongeur . 703
 Mcllwraith Basket Cutter Rongeur 702
 Mcllwraith Cup Rongeur 707
 Mcllwraith-Peapod Rongeur 703
 Mcllwraith Periosteal Elevator 378
 Mcllwraith Suction Arthroscopic Cut Through Punch Rongeur 611
 McIndoe Bone Cutting Forceps 658
 McIndoe Dressing and Tissue Forceps . 121
 McIndoe Forceps Titanium 121
 McPherson Bipolar Forceps 139
 Mead Mallet 406
 Mead Rongeur 749
 Measuring Gauge 513
 Medial Blade 216
 Medicine Cup 31
 Medi-Mark™ Tape 38
 Meniscotome
 Arthroscopic Meniscotomes Hook, Probe & Knife 615, 616
 Mini V-Blade Meniscotome 417
 Piermattei Smillie Meniscotome 418
 Triangle Handle Arthroscopic Meniscotome, Hook, Probe & Knife 614
 V Blade Meniscotome 416
 Meniscus Grasping Forceps 613
 Metal Micro Instrument Tray 10, 11
 Meyerding Retractor 465
 Michele Trephine 551
 Micro Alligator Grasping Forceps 71
 Micro Axial Bayonet Extra Long Curette. 545
 Micro Axial Bayonet Long Curette 544
 Micro Axial Bayonet Regular Length Curette. 543
 Micro Bayonet Forceps 154
 Micro Biopsy Forceps with Flexible Tubular Shaft 74
 Micro Bone Reduction Clamp 353
 Micro Double Action Wire Cutter 573
 Micro Ear Alligator Forceps 68, 69, 70
 Micro Friedman Ring Handle Rongeur . 741
 Micro Friedman Rongeur 742
 Micro Gerald Tissue Forceps 109
 Micro Hook Titanium 187
 Micro House Alligator Forceps 64
 Micro House Biopsy Alligator Forceps ... 73

Micro Inge Lamina Spreader 484
 Micro Lamina Spreader 226
 Micro Neuro Biopsy Rongeur 721
 Micro Round Handle 6" Forceps Titanium . 172
 Micro Round Handle Forceps Titanium . 173
 Micro Scissors Long 14 mm Blades Round Handle Titanium 168
 Micro Scissors Small 8 mm Blades Round Handle Titanium 169
 Micro Sontec Alligator Forceps 67, 72
 Micro Spinal Curette 542
 Micro Straight Round Handle Forceps Titanium 174
 Micro Tap/ Drill Sleeve 512
 Micro TCD Round Handle 5 1/2" Needle Holder Titanium 170
 Micro TCD Round Handle 7" Needle Holder Titanium 171
 Micro Tying Forceps 99
 Micro Tying Forceps Titanium 99
 Miller Bone Rasp Double-Ended Single-Sided 761
 Miller Bone Rasp Double-Ended Single-Sided Serrated 761
 Miller Cross Serrated Rasp 762
 Miller Parallel Serrated Rasp 763
 Miller Rasp 761
 Mini Arthroscopic Small Joints Rongeur Set. 76
 Mini Caliper 54
 Mini Depth Gauge 520
 Mini Doolen Bone Holding Clamp 328
 Mini Foremann Distractor 453
 Mini Friedman Rongeur 742
 Mini Hohman Elevator Retractor 477
 Mini Inge Neroma Ceramitec Retractor . 456
 Mini Inge Neroma Retractor 456
 Mini Jet Wire Twister Needle Holder . 590
 Mini Lexer Gouge 385
 Mini Lexer Osteotome 400
 Mini Neuro Premier Rongeur 740
 Mini Neuro Rongeur 740
 Mini Plate Bending Iron 432
 Mini Rod Holder 491
 Mini V-Blade Meniscotome 417
 Miskimon Cerebellum Retractor 278
 Modified Ferguson-Frazier Suction . 299
 Mollison Retractor 274
 Murphy Ball End Probe 206
 Murphy-Lane Bone Skid 462

N
 Nadler Coaptation Bipolar Forceps . 140
 Nail Cutter
 Feline Nail Cutter 665
 Nail Nipper 661, 664
 Nail Rasp 764
 Nail Scissor
 White Toe Nail Scissor 664
 Nail Splitter 661
 Nail Splitter Forcep 659
 Needle
 Durrans Dorsal Vein Complex Ligation Needle 162
 Reverdin Needle/Ligature Carrier 162
 Sontec Reverdin Blunt Needle/Ligature Carrier 162

Needle Boat / Spiral Rack 35
 Needle Holder
 Arthroscopic Needle Holder 610
 Micro TCD Round Handle 5 1/2" Needle Holder Titanium 170
 Micro TCD Round Handle 7" Needle Holder Titanium 171
 Mini Jet Wire Twister Needle Holder . 590
 New Orleans Wire Twister Needle Holder . 587
 Obwegeser Wire Twister Needle Holder . 586
 Rubio Wire Twister Needle Holder 586
 Sternal Wire Twister Needle Holder . 587
 TC Jet Wire Twister Corkscrew Design Heavy Needle Holder 591
 Needle Nose Locking Pliers 558
 Needle Nose Pliers 557
 Nelms Suction Elevator 200
 Neroma Gelpi Spinal Retractor 268
 Nerve Hook Titanium 186
 Nerve & Vessel Hook Titanium 182
 Nested Trocar Set 550
 Neuro Caliper 232
 Neuro Ring Curette 531
 New Orleans Wire Twister Needle Holder . 587
 Nipper
 Tissue and Cuticle Nipper 659
 Nippers 662
 Concave Nail Nipper 663
 Nixon XXL Banana Knife 419
 Non-Perforated Mayo Tray 28
 No Recoil Mallet 412

O
 O'Brien Curette 532
 Obturator
 Shepard Ram Obturator 552
 Obwegeser Fenestrated Serrations Rasp . 772
 Obwegeser Solid Fine Grit Nasal Rasp . 773
 Obwegeser Split Osteotome 401
 Obwegeser Wedge Osteotome 401
 Obwegeser Wire Twister Needle Holder. 586
 Ochsner Dissector 194
 Ochsner-Sontec Straight Dissector . 194
 Oehler Forceps 119
 Olivecrona Dissector 195
 Olivecrona Rongeur 749
 Omega Mini Screwdriver Set 500
 Original DeBakey Forceps 101
 Orthopedic Vernier Caliper 54
 Osteotome
 Cottle Plastic Osteotome 396
 Hand Surgery Osteotome 394
 Hibbs Osteotome 392
 Hoke Osteotome 395
 Lambotte Osteotome 393
 Lexer Osteotome 400, 401
 Mini Lexer Osteotome 400
 Obwegeser Split Osteotome 401
 Obwegeser Wedge Osteotome 401
 Sheehan Osteotome 394
 Smith Peterson Osteotome 390, 391
 Stille Osteotome 397

West Osteotome 394
 Osteotomes
 Hardt Micro Ceramitec Osteotome 400

P
 Pants
 Sontec Scrub Pants 32
 Papavero Cannula Suction 301
 Parallel Drill Guide 514
 Parallel Wire Extraction Pliers 427
 Pashley-Frazier Suction 298
 Pashley Pipe Suction Tube Holding Device . 315
 Patella 2 x 2 Prong Bone Clamp 332
 Peapod Extended Shaft Rongeur 705
 Peapod-Mcllwraith Rongeur 704
 Penfield Dissector Set 196
 Perforated Mayo Tray 27
 Perthes Awl 522
 Peterson Fully Cannulated Pin Bender . 424
 Phenolic Spinal Mallet 413
 Pick
 Bone Pick Micro Fracture 621
 Chondro Pick 620
 Rhoton Pick 256
 Taylor Micro Arthroscopic Hook Probe & Pick 619
 Taylor Micro Arthroscopic Pick 520
 Piermattei Pin Bender / Driver 426
 Piermattei Shoulder Elevator 379
 Piermattei Smillie Meniscotome 418
 Pig Tail Neuro Hook Probe 179
 Pigtooth Nipper 662
 Pigtooth Nippers 662
 Pin Bender
 Peterson Fully Cannulated Pin Bender . 424
 Piermattei Pin Bender / Driver 426
 Pin Bender Double-Ended 425
 Pin Bender Double-Ended 425
 Pin Cutter
 Baby GOLD-CUT HERCULES Pin Cutter . 572
 End Pin Cutter 570
 Flush Cut Pin Cutter 580
 GOLD-CUT HERCULES Front & Side Pin Cutter 582
 GOLD-CUT HERCULES Pin Cutter 571
 Large Plate & Pin Cutter 570
 Pin Cutter Specialty Harden Jaws 575
 Sontec Pin Cutter 577
 TC Pin Cutter 569, 575
 The Big GOLD-CUT HERCULES® Pin Cutter 571
 Pin Cutter Specialty Harden Jaws 575
 Pin Driver
 Pin Driver & Bone Tamp 423
 Sontec Pin Driver / Bender 424
 Pin Driver & Bone Tamp 423
 Pin End Cutter 577
 Pin Puller 429
 HERCULES GRIP Pin Puller 428
 Pin Puller 429
 Pin Pulling Double Action Pliers 428
 Pin Pulling Pliers 556
 Plate Bending Iron 433
 Plate Bending Iron Lateral & Contour . 433
 Plate Bending Pliers 433

Punched Hole Gauge Ruler 56
 Ruskin Duckbill Rongeur 726
 Ruskin-Liston Bone Cutting Forceps 656
 Ruskin Rongeur 724
 Russian Adson Micro Forceps 137
 Russian Tissue Forceps 109

S

Sanders Brown Ligature Carrier 165
 Sayre Elevator 379
 SC95-0300-SET 621
 SC95-0302-SET 621
 SC95-0310-SET 622
 SC95-0315-SET 622
 SC95-0415-SET 622
 Schiötz Tonometer 56
 Schlesinger (Cloward) Rongeur 710
 Schmid Suction Tips 304
 Schmieden-Dick Ligature Carrier 164
 Schroeder Vulsellum Bone Reduction Clamp 351
 Scissors
 Arthroscopic Metzenbaum Hook Scissors 602
 Arthroscopic Punch & Scissors 604
 Ingrown Nail Splitting Scissors 664
 Micro Scissors Long 14 mm Blades Round Handle Titanium 168
 Micro Scissors Small 8 mm Blades Round Handle Titanium 169
 Rotary Arthroscopic Scissors 613
 Scoville Bayonet Bipolar Forceps 143
 Scoville Bipolar Forceps 144
 Scoville Lumbar Blade 225
 Scoville Middle Lumbar Blade 225
 Scoville Nerve Root Retractor 251
 Scoville Retractor Frame 224
 Screwdriver
 Caspar Screwdriver 222
 Screw Driver
 A.O. Type Universal Screw Driver 499
 Hexagonal Screw Driver 498
 Lubra Screw Driver 499
 Screw Holding Forceps 501
 Screw Post
 Caspar Screw Post 222
 Sedillot Elevator 379
 Self-Locking 3K Chuck Blade Handle 49
 Selman Tissue Forceps 110
 Selverstone Peapod Rongeur 705
 Semb Bone Rongeur 735
 Semken Forceps 118
 Separator
 Frazier Dorsey Dura Separator 178
 Sequestrum Sontec Bone Forceps 326
 Sesamoidectomy Bone Clamp 329
 Set
 AO Type Bending Pliers Set 437
 AO Type Universal Screwdriver Set 501
 Bone Mill Set 527
 Bone Scraper Set 521
 Caspar System Complete Set 233
 Coupland Suction Set 314
 Gallaher Bone Rasp Set 768
 Gubish Surgical Pen Holder Set 48
 Jacobson Raspatory/Probe Set 191
 McCullough Retractor Set 230, 231

Mini Arthroscopic Small Joints Rongeur Set 76
 Omega Mini Screwdriver Set 500
 Penfield Dissector Set 196
 Rubber Jaws Replacement Set for Hercules Wire Cutter 582
 Small Joint Arthroscopic Cannula Switch Stick Set 624
 Sontec-Cottle Osteotome Set 399
 Sontec Ear Rasp Set 769
 Sontec Hybrid I.M. Pin Chuck Set 509
 Sontec I.M. Pin Chuck Set 508
 Sontec Keyless I.M. Pin Chuck Set 509
 TC Blades Replacement Set For Hercules Wire Cutter 582
 TC Inserts with Rubber Jaws Replacement Set for Hercules Front & Side Cutter 582
 Universal Klick Kerrison Rongeur Set with Tray 668
 Yasargil Raspatory Probe Set 191
 Sets
 Hardt Micro Cartilage Osteotome Set (with tray) 398
 Shearer Chickenbill Rongeur 743
 Sheehan Osteotome 394
 Sheen Fragment Retriever Forceps 707
 Shepard Cross Pin 552
 Shepard Ram Obturator 552
 Shepard Trocar 552
 Short Jaw Nail Splitter 660
 Side Biting Alligator 63
 Side Biting Alligator Forceps 63
 Siegel Knife Handle 48
 SIL-239 . 781
 SIL-2410 780
 SIL-2480 782
 Silicone Mat 15
 Silver Ear Dressing Alligator Forceps 91
 Single Side Rasp 766
 Singley Tuttle Forceps 110
 Sisson Spring Retractor 457
 Skid
 Murphy-Lane Bone Skid 462
 Skinner Tissue Forceps 117
 Slap Hammer / Hip Dislodger 558
 SL - Connect Blade Insert Instrument 218
 SL - Connect Blunt Blade Titanium 219
 SL - Connect Lateral Blade Titanium 219
 Slip Joint Pliers 559
 Slocum Type Army Navy Retractor 461
 Small Joint Arthroscopic Cannula 624
 Small Joint Arthroscopic Cannula Switch Stick Set 624
 Small Joint Complete Arthroscopic Set 625
 Small Plate Bending Iron 432
 Smillie Meniscus 418
 Smillie Meniscus Knife 418
 Smith-Petersen Gouge 384
 Smith-Petersen Laminectomy Rongeur 728
 Smith-Peterson Osteotome 390, 391
 Smith-Peterson Sontec Streamlined Laminectomy Rongeur 727
 Sontec Alligator Forceps 60, 62
 Sontec A O Type Elevator / Raspatory 380, 381
 Sontec Beatty Foraminotomy Rongeur 673
 Sontec Brain Spatula 238
 Sontec Chisel 387

Sontec Combo Nylon Mallet 404
 Sontec-Condial Reduction Clamp 352
 Sontec-Cottle Osteotome Set 399
 Sontec Delicate Meniscus Clamp 361
 Sontec D'Errico Tissue Forceps 109
 Sontec Diamond Surface Rasp 771
 Sontec Double Nylon Mallet 405
 Sontec Ear Rasp Set 769
 Sontec Elite Wireless LED Headlight 778, 779
 Sontec Fomon Rasp 756
 Sontec Forcep Holder 34
 Sontec Glabella Pull Push Curved Tip Rasp 770
 Sontec-Glabella Sculpting Rasp 773
 Sontec-Glabella Sculpting TC Insert Rasp 773
 Sontec-Hohmann Elevator Retractor 474, 475
 Sontec-Hohman Retractor 476
 Sontec Hybrid I.M. Pin Chuck 504
 Sontec Hybrid I.M. Pin Chuck Set 509
 Sontec I.M. Pin Chuck 504
 Sontec I.M. Pin Chuck Aluminum Handle 505
 Sontec I.M. Pin Chuck Extensions 507
 Sontec I.M. Pin Chuck Set 508
 Sontec I.M. Pin Chuck T-Handle 506
 Sontec Instrument Fabric Barrier Wrap 2PLY 33
 Sontec Kerrison 40° Rongeur 682, 689
 Sontec Kerrison Rongeur 692
 Sontec Kerrison Rongeur 90° Down Bite Rongeur 681
 Sontec Keyless I.M. Pin Chuck Set 509
 Sontec Keyless I.M. Pin Drill Chuck 505
 Sontec Knife Handle #3XXL 45
 Sontec Lane Lever Elevator 477
 Sontec Large Handle Mallet 411
 Sontec Large Mallet 409
 Sontec LED Plus+ Headlight 780
 Sontec Lempert Rongeur 745
 Sontec-Love Nerve Root Retractor 245
 Sontec Magnum LED Headlight 781
 Sontec Meniscus Clamp 360
 Sontec Mesh Meniscus Clamp 362
 Sontec Micro Alligator Forceps 61
 Sontec Micro Biopsy Forceps 87
 Sontec Micro Gouge 384
 Sontec Micro Mallet 405
 Sontec Micro Pediatric Suction 306, 307, 308
 Sontec Micro Rasp 764
 Sontec-Miller TC Insert Rasp 761
 Sontec Multi-Level Gelpi Retractor 276, 278
 Sontec Multi-Level Off Set Arms Gelpi Retractor 277
 Sontec Nerve Hook Titanium 182
 Sontec Neuro Suction 296
 Sontec Patella Raspatory 771
 Sontec Perfusion Cannula Suction 314
 Sontec Pin Cutter 577
 Sontec Pin Driver / Bender 424
 Sontec proCam 4K Micro Camera System 782
 Sontec Reverdin Blunt Needle/Ligature Carrier 162
 Sontec Scrub Pants 32
 Sontec Septal Platform Forceps 94

Sontec Septal Platform Forceps Titanium 94
 Sontec Sheet Tape 37
 Sontec Single End Wire Passer 562
 Sontec Slim Thermoplastic Instrument Tray 23
 Sontec Spinal File/Rasp 774
 Sontec Stifle Thrust Lever 463
 Spatula
 CSU Kloop Neuro Spatula 237
 Cushing Brain Depressor Spatula 237
 Davis Brain Spatula 239, 241
 Sontec Brain Spatula 238
 Spatulas
 Davis Brain Black Silicone Spatula 240
 Speculum
 Caspar Lumbar Speculum 222
 Spinal Compressor 280, 281
 Spinal Curette 534
 Spinal Distractor 279, 280
 Spinal Distractor/Compressor 279
 Spinal Fusion Curette 546
 Sponge Bowl 30
 Spreader
 Cloward Lamina Spreader 486
 Inge Lamina Spreader 482, 483
 Micro Inge Lamina Spreader 484
 Micro Lamina Spreader 226
 Platipus Micro Inge Lamina Spreader 482
 Spurling Pituitary Rongeur 710, 711
 Square Standard 599
 ST2J 31
 ST3J 31
 ST4J 31
 ST15-20-PMT 27
 Stabilizing Restrainer
 Lead Hand Stabilizing Restrainer 479
 Stahl A/C Lens Gauge 55
 Stahl Caliper 55
 Stainless Steel Instrument Tray 24
 Stainless Steel Instrument Tray & Lid Cover 25, 26
 Staley Round Knurled Knife Handle 45
 Standard Plate Bending Iron 432
 Stefan Bone Holding Forceps 325
 Stefan Mini Bone Holding Forceps 324
 Steinman Pin Puller 426
 Stellbrink Rongeur 744
 Sterilizing Rack
 Alligator Sterilizing Rack 18
 Sternal Wire Twister Needle Holder 587
 Stille-Adson Dressing Forceps 136
 Stille-Adson Tissue Forceps 136
 Stille Curette 366
 Stille-Horsley Bone Cutter 660
 Stille-Liston Bone Cutting Forceps 657
 Stille-Luer Duckbill Rongeur 734
 Stille-Luer Echlin Duckbill Bayonet Rongeur 736
 Stille-Luer Echlin Duckbill Rongeur 736
 Stille-Luer Rongeur 732, 733
 Stille Osteotome 397
 Stringer Forceps Holder 35
 Suction
 Adson Suction 313
 Andrews Pynchon Suction 309
 Anthony Suction 309
 Baby Poole Suction 312

Baron Suction 297
 Braun-Ralph Suction 309
 Frazier Angled Suction 286, 287, 288, 289
 Frazier Insulated Suction 291
 Frazier-Rhoton Angled Suction 292
 Frazier Straight Suction 290
 Fukushima Suction 294, 295
 House-Baron Suction 304
 House Irrigator/Suction 305
 Killian (Von Eicken) Suction 313
 Kurtz Cut-Off Suction Adapter 303
 Modified Ferguson-Frazier Suction 299
 Papavero Cannula Suction 301
 Pashley-Frazier Suction 298
 Poole Suction 311
 Poole Suction Deluxe 312
 Rhoton Micro Neuro Suction 293
 Rosen Suction Tips 302
 Schmid Suction Tips 304
 Sontec Micro Pediatric Suction 306, 307, 308
 Sontec Neuro Suction 296
 Sontec Perfusion Cannula Suction 314
 Yankauer Suction 310
 Suction Adapter
 House Cutoff Suction Adapter 303
 Suction Arthroscopic Cut Through Punch Rongeur 609, 610
 Suction Handle
 Wullstein Suction Handle 303
 Suction Nerve Retractor 247, 301
 Suction Tube
 Barnes Mini Suction Tube 297
 Bayonet Suction Tube 300
 Black Monopolar Suction Tube 147
 Buie Suction Tube 312
 Wullstein Ear Suction Tube 303
 Sump Sucker
 Heartline Ross Sump Sucker 311
 Surgical Blade Remover 49
 Surgistain® 40
 Switch Stick 624
 Arthroscopic Switch Stick 623
 Sypert Extended Rongeur 737

T

T12-9300 52
 T117-560 45
 T136-686 134
 Table Top Rod Cutter 583
 Takahashi Rongeur 706
 Tap
 AO Tap Cannulated 513
 Tap/ Drill Sleeve 512
 Tape
 Medi-Mark™ Tape 38
 Sontec Sheet Tape 37
 Tap Sleeve & Insert Drill Sleeve Set 511
 Taylor-Dingmann Bone Clamp 327
 Taylor Drill Guide 512
 Taylor Micro Arthroscopic Hook Probe 619
 Taylor Micro Arthroscopic Hook Probe & Pick 619
 Taylor Micro Arthroscopic Pick 520
 Taylor Spinal Retractor 461
 TC Blades Replacement Set For Hercules

Wire Cutter 582
 TC Inserts with Rubber Jaws Replacement Set for Hercules Front & Side Cutter 582
 TC Jet Wire Twister Corkscrew Design Heavy Needle Holder 591
 TC Pin Cutter 569, 575
 Tear Drop Curette 539
 Tear Drop Spinal Curette 533
 Tendon Passer Ligature Carrier 163
 Tenzel Bipolar Forceps 139
 T-Handle Bone Hook 520
 The Big GOLD-CUT HERCULES Pin Cutter 571
 Thermoplastic Instrument Tray 19, 20, 21
 Thermoplastic Instrument Trays 22
 Thorpe Caliper 54
 3 / 1 Drill Guide 511
 Thumb Dressing Forceps 122
 Thumb Forceps Titanium 117
 Tip
 Gubisch Surgical Pen Replacement Tip 49
 Tip Cover 36
 Tissue and Cuticle Nipper 659
 Tissue Bipolar Forceps 145
 Tissue Forceps with TC Inserts 117
 Tissue Forceps with Teeth 120
 Tissue Nipper 658
 Titanium Bayonet Bipolar Forceps 143
 Titanium Sontec Dissector 195
 Tobey Ear Dressing Forceps 92
 Tonometer
 Schiötz Tonometer 56
 Toothed Blade 229
 TPLO Double-Ended Gauge 57
 Tray
 Catheter Tray & Dome Lid Cover 24
 Instrument Tray 27
 Metal Micro Instrument Tray 10, 11
 Non-Perforated Mayo Tray 28
 Perforated Mayo Tray 27
 Rongeurs Tray 693
 Sontec Slim Thermoplastic Instrument Tray 23
 Stainless Steel Instrument Tray, Lid Cover & Perforated Nesting Sterilization Instrument Tray 24
 Thermoplastic Instrument Tray 19, 20, 21
 Thermoplastic Instrument Trays 22
 Universal Kerrison Klick Rongeur Tray for Set 16
 Universal Surgery Tray 14
 Trays
 Stainless Steel Instrument Tray & Lid Cover 25
 Trepine
 Bespoke Wroblewski Bone Trepine 553
 Galt Trepine 551
 Michele Trepine 551
 Triangle Handle Arthroscopic Meniscotome 614
 Trocar
 Nested Trocar Set 550
 Shepard Trocar 552
 Troutman Micro Hook Forceps 126
 Tufts Pigtail Neuro Hook Probe 178, 179

Two Handed Curette 538, 539
 Two Handed Large Grip Curette. 541

U

Ulrich Bone Clamp 321
 Ulrich Swivel Jaw Bone Clamp. 335
 Universal Adjustable Angle Knife Handle #3.
 44
 Universal Drill Guide 510
 Universal Kerrison Klick Rongeur Tray for Set
 . 16
 Universal Klick Kerrison Rongeur Set with
 Tray. 668
 Universal Surgery Tray 14
 USA Curette 535
 USA Model Mallet 408
 USA Ring Curette 535
 U.S. Army-Navy Retractor. 473

V

Valkyrie Mach Holder / Drill Guide 515
 V Blade Meniscotome. 416
 Ventricular Vent
 Heartline Ross Ventricular Vent 311
 Verbrugge Bone Clamp 318, 319, 320
 Verbrugge Reverse Jaw Bone Clamp 320
 Verbrugge-Rogalski Bone Clamp. 322
 Vickers Easy Driver / Bender / Puller 422
 Vickers Self-Retaining Retractor. 458
 Vise Grip Pliers 559
 Volkman Curette 371
 Volkman Retractor. 467

W

Wagner Hook 186
 Waldsachs Universal Pin Bender Pliers 495
 Wangenstein Tissue Forceps 110
 Webster Glabella Sculpting Rasp. 773
 Weil-Blakesley Rongeur 698
 Weil Nasal Rongeur 699
 Weitlaner Extended Blades Retractor 273
 Weitlaner Retractor 269, 272
 Weitlaner Retractor Titanium. 271
 Wellace Stifle Retractor. 457
 West Osteotome 394
 Whale Nose Plate Bending Pliers. 436
 Whisk 'R Brush™ 39
 White Toe Nail Scissor 664
 Wide Barrel Grip Knife Handle #3 44
 Wide Scoville Nerve Root Retractor
 . 249
 Wide Scoville Nerve Root Retractor 249
 Wilde Ear Forceps. 155
 Wilde Ethmoid Arthroscopic Rongeur 700
 Wilde Ethmoid Rongeur 699
 Williams-Sontec Rongeur 702
 Williger Periosteal Elevator. 379
 Wire Bender 492
 Wire Bender. 492
 Wire Cutter
 Double Action Wire Cutter.
 573, 576
 Wire End Cutter
 569, 580, 581
 Wire Side Cutter. 568
 Wire End Cutter. 569, 580, 581

Wire Extraction Pliers 556
 Wire Passer
 Avian Mini Wire Passer 565
 Herbst-Doolen Wire Passer 564
 Herbst Wire Passer 564
 Hybrid Herbst Wire Passer 563
 Sontec Single End Wire Passer. 562
 Wire Rod Holder & Bender. 492
 Wire Side Cutter 568
 Wire Twister. 590
 Anti-Buckle Wire Twister 588
 Axel Wire Twister 589
 Bio-Met Type Wire Twister 592
 Bio-Met Wire Twister 592
 Cerclage Double Torpedo Type Wire
 Twister. 593
 Cerclage Torpedo Type Wire Twister. 591
 Jet Wire Twister 593
 Loute Wire Twister 592
 Mini Jet Wire Twister Needle Holder 590
 New Orleans Wire Twister Needle Holder
 . 587
 Obwegeser Wire Twister Needle Holder
 . 586
 Rubio Wire Twister Needle Holder. 586
 Sternal Wire Twister Needle Holder. 587
 Wire Twister 590
 Wullstein Ear Suction Tube. 303
 Wullstein Suction Handle 303

Y

Yankauer Suction 310
 Yasargil Atrauma Forceps. 155
 Yasargil Bayonet Bipolar Forceps. 142
 Yasargil Bayonet Elevator Titanium 200
 Yasargil Bayonet Forceps Titanium 152
 Yasargil Dissector Raspatory Titanium 194
 Yasargil Forceps Titanium. 148, 149
 Yasargil Galea Spring Neuro Hook. 187
 Yasargil Micro Bayonet Forceps 154
 Yasargil Micro Forceps Titanium 150, 153
 Yasargil Raspatory Probe Set. 191
 Yasargil Raspatory Titanium 191
 Yasargil Tumor Bayonet Forceps 154
 Yasargil Tumor Grasping Bayonet Forceps .
 156
 Yasargil Tumor Grasping Bayonet Forceps
 Titanium 152
 Yasargil Tumor Grasping Forceps Titanium .
 151

Z

Zaufel-Jansen Rongeur. 726



In Business for Over 50 Years

Bringing the Highest Quality Surgical
Instrumentation to the World since 1970



Sontec Instruments®

A TRADITION OF FINE SURGICAL INSTRUMENTS

Sontec Instruments, Inc.
7248 South Tucson Way
Centennial, Colorado 80112 USA
Toll-free / 800.821.7496
Local / 303.790.9411
Fax / 303.792.2606

SontecInstruments.com