



# Sontec Instruments®

A TRADITION OF FINE SURGICAL INSTRUMENTS

PLASTIC ENT CATALOG

Dear Customer,

Sontec Instruments, Inc. is a family owned & operated medical company, providing personalized service featuring the finest in surgical instrumentation for over half a century.

Our surgical instruments encompass the entire human anatomy including specialty products specific to small and large animal surgery.

Owner of Sontec Instruments, Dennis Russell Scanlan III and his sons, Johann, Stefan and Angus Scanlan bring with them a lifetime of experience creating the highest quality products made by the world's leading manufacturing facilities featuring, cutting edge robotic technology, handmade workmanship combined with an understanding how to make exactly what our valued customers have come to expect.

Dennis R. Scanlan, III President & CEO and his wife Caron C. Scanlan thank you, for the opportunity to present our specialty Plastic ENT catalog.

Sincerely,



Dennis Russell Scanlan III

---

## Table of Contents

---

KNIFE & BLADE Handles .....	9
ENT SINUSCOPY .....	13
Scissors .....	35
Needle Holders .....	85
Forceps .....	115
ENT CURETTES .....	175
GOUGES .....	183
ENT Plastic OSTEOTOMES .....	191
ENT Plastic ELEVATORS .....	203
ENT Plastic SUCTION ELEVATORS .....	221
ENT SPECULUMS .....	225
ENT Plastic HOOKS .....	239
ENT Plastic DISSECTORS .....	259
Plastic Liposuction Cannulas .....	263
ENT Plastic RETRACTORS .....	269
Plastic Endoscopic Face Lifting .....	311
ENT RONGEURS .....	315
ENT KNIVES .....	325
CALIPERS & RULERS .....	333
RASPS .....	341
Plastic SPECIALTY .....	355
Ligature Carriers .....	375
SUCTION Selection .....	381
ENT SAWS .....	401
Eye OCULAR PLASTIC .....	405
Orthopedic MALLETS .....	435
Orthopedic SINGLE ACTION RONGEURS .....	439
Index .....	466

Conversion Table

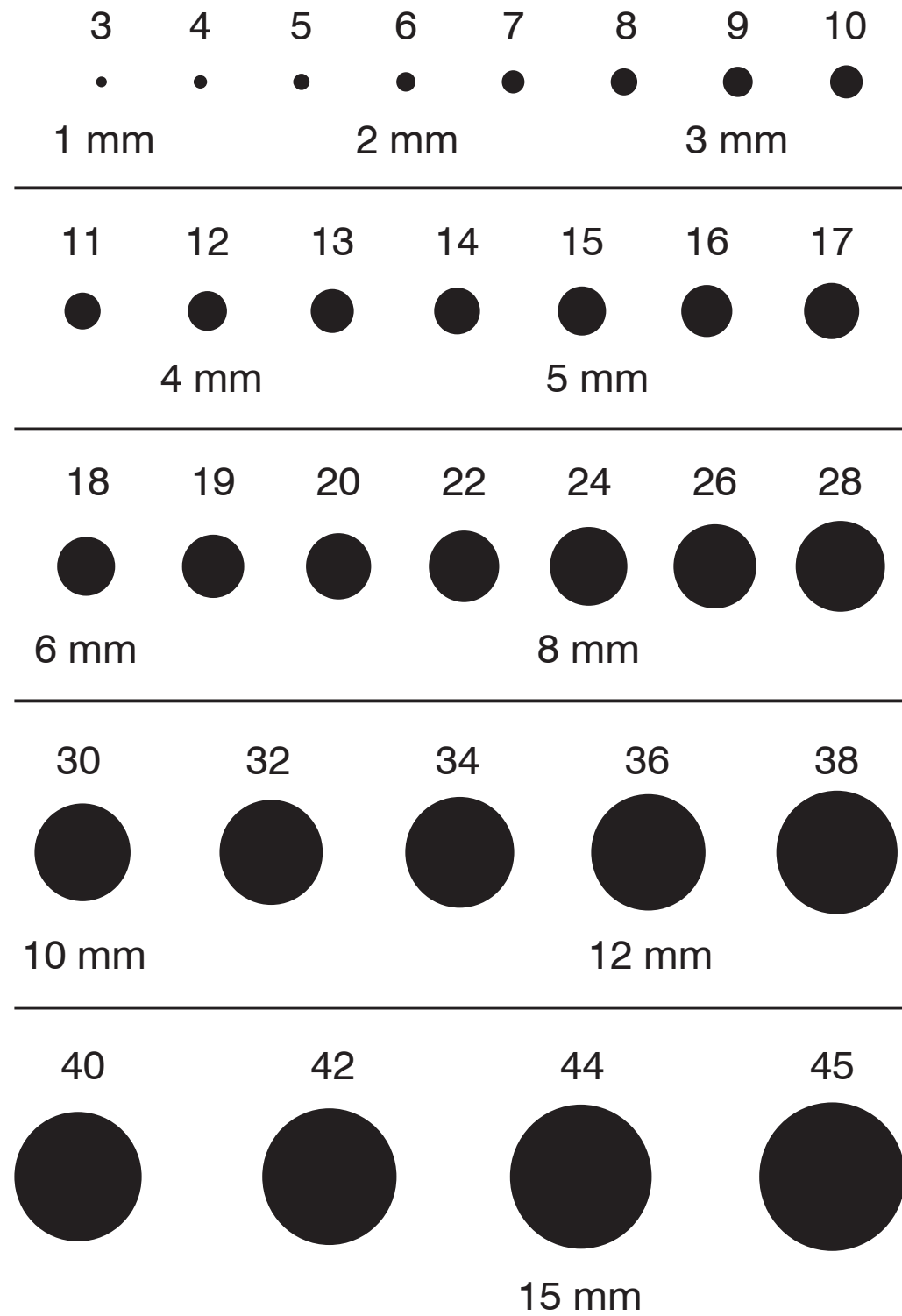

Conversion Table

Multiply	By	To Obtain
Millimeters	0.1	Centimeters
Millimeters	0.03937	Inches
Centimeters	0.3937	Inches
Centimeters	0.01	Meters
Centimeters	10	Millimeters
Inches	2.540	Centimeters
$1/8'' = 3.175$ millimeters		
$1/4'' = 6.350$ millimeters		
$3/8'' = 9.525$ millimeters		
$1/2'' = 12.70$ millimeters		
$1'' = 25.40$ millimeters		

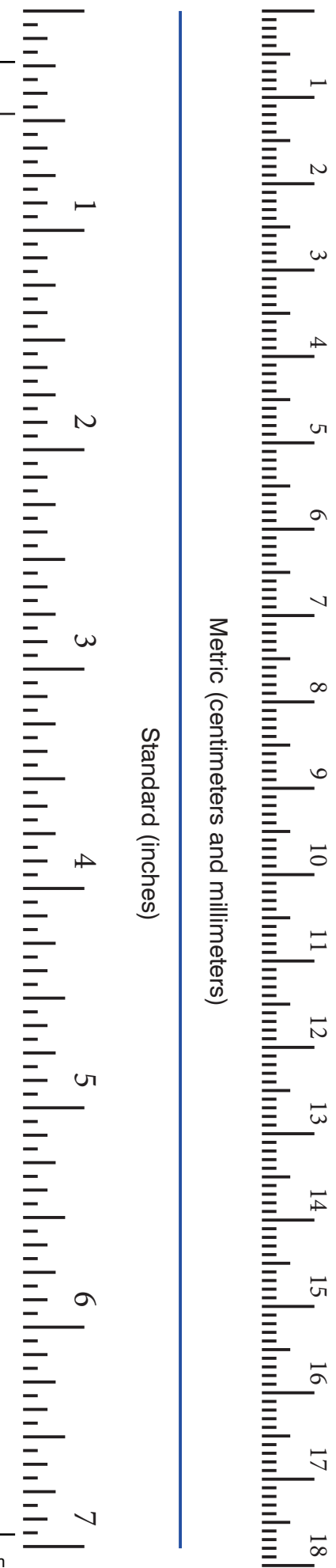

## Important Information

### Guarantee & Repairs Policy

Sontec® surgical instruments are guaranteed to be free of defects in materials and workmanship. Any Sontec® instrument that is defective will be repaired or replaced at our discretion. Instruments not properly cared for, used for unintended purposes, or beyond their designed capacity will not be covered under this guarantee. Our liability under this guarantee is limited to the repair or replacement of the defective merchandise.

Sontec® has its own repair department where most mechanically functional instruments can be returned to like-new condition.

Sontec® performs a variety of repairs, such as replacing worn TC jaws or sharpening scissors. In addition, we complete a comprehensive evaluation of your instruments to determine if further service is required.

For repair service, please send the following directly to the address below:

- Instruments clean, sterilized, securely wrapped and carefully packaged.
- Purchase and/or repair order
- A note with contact and shipping information
- Sending multiple items eliminates \$50 minimum charge

### Return Policy

The return of new, unused instruments in their original packaging is accepted within 30 days of purchase with an authorized "Return Merchandise Authorization". Please contact Sontec directly by phone or email with your invoice or proof of purchase in order to obtain your RMA slip and instructions. Restocking fee applies and credit will not be issued for shipping charges or handling fees. Proper credit is not guaranteed without an RMA. Custom, Special Order or Modified items are non-returnable.

Sontec Instruments, Inc.  
Toll free: 800.821.7496  
Local: 303.790.9411  
returns@sontecinstruments.com

### Remember

Sontec® offers other catalogs for a variety of surgical instrumentation, including:

- Alligator, Grasping, & Biopsy Forceps
- Avian & Exotic
- Bandage Scissors
- Cardiovascular & Thoracoscopic
- Caspar & Cloward Retractor Systems
- Colon & Rectal
- Cranial Cruciate Ligament Lateral Suture

#### System

- Equine (Arthroscopic)
- Eye
- Neurology & Orthopedic
- Orthopedic & Arthroscopic
- Urology
- Veterinary Dental
- Veterinary Eye
- General Veterinary Instrumentation

Also, if you do not find what you are looking for, please contact us.

### Instrument Care

Designed and crafted to exacting specifications, surgical instruments will perform for a number of years, provided they are maintained correctly and used for their intended purpose. A strict maintenance schedule will help reduce the need for premature replacements, thus cutting costs. For proper safeguarding of surgical instruments, please read and share the following information.

- Never substitute sterilization for cleanliness
- Wash brand new instruments prior to the first sterilization
- Remove saline solution, bleach, blood and tissue from instruments quickly and thoroughly
- Always use distilled water for cleaning instruments
- Never use saline solution for cleaning instruments
- Prevent cross-corrosion by separating corroded instruments from other instruments
- Never autoclave econo-grade stainless with superior-grade stainless.
- Always autoclave instruments with box lock open to alleviate pressure at the joint and to prevent fracture
- Lubricate joint and box lock after cleaning with an anti-microbial, water soluble lubricant
- Protect the tips of delicate instruments with protective covers (see page a.)
- Never use an instrument for anything other than its intended use

### Additional Safeguarding Guidelines

#### Scissors and Other Blades

- Perform routine inspections for sharpness, as a blade becomes duller with each stroke (all operating and Mayo scissors should be able to cut through four layers of gauze)
- When blades no longer cut without an excessive amount of force, please return them to Sontec® for sharpening
- The more often a blade is sharpened, the longer it tends to last

#### Needle Holders

- Repair is necessary when needle holder no longer securely holds needle when locked on the second ratchet tooth, and needle turns easily by hand

### Please Note

- We are not responsible for typographical errors in this catalog
- Instruments pictured in this catalog may or may not be to size
- Variations and changes in instrument design are possible
- Pricing is subject to change without notice
- Delivery schedules may vary from original estimates
- Some items are for veterinary use

### Contact Info

Sontec Instruments, Inc.  
7248 South Tucson Way  
Centennial, Colorado 80112, USA  
Toll free: 800.821.7496  
Local: 303.790.9411  
service@sontecinstruments.com  
www.sontecinstruments.com

## Troubleshooting Guide

Problem	Cause	Solution
Rust	Worn chrome plating on brass instruments	Be aware of plating condition and remove from service when wear is visible.
	Cross-corrosion from carbon instruments to stainless steel	Keep carbon steel and stainless steel instruments separated during cleaning and sterilization.
	Low grade instruments may not have been passivated	Remove from service.
	Autoclave not operating properly	Clean and thoroughly flush water lines in sterilizer according to manufacturer's instructions. Only use distilled water, never tap water, to generate steam.
	Organic matter left on instrument after surgery	Remove all blood and tissue before drying. Use distilled water and a nylon brush to clean hard to reach areas.
Pitting	Prolonged exposure to corrosive chemicals and/or organic substances	Only use approved cleaning and sterilization solutions. Thoroughly rinse and dry instruments.
Orange / Brown Stains	Contaminated sterilizer, high alkaline detergent, cold disinfectants	Clean sterilizer. Use neutral pH solutions. Thoroughly clean, rinse, and dry instruments.
Bluish Black Stains	Mixing dissimilar metals during cleaning and sterilization	Separate carbon steel, aluminum, and stainless steel instruments.
Rainbow - colored Stains	Chromium oxide stain-result of excessive heat	Send in for polishing and hardness check.
Cracked Box Lock	Excessive force, sterilized in the closed position	Replace the instrument.
Cracked Jaw on Pin Cutter	Cutting pin at tip of jaws	Replace the instrument. Cut pin in center of jaws.



 Sontec Instruments®

KNIFE & BLADE Handles

**Knife Handle #3**

Fits surgical blades 10-15 / with calibrated scale

\* surgical blade not included

1100-740 5" (12.5 cm)



Round handle

1100-741 6" (15 cm)

1100-740



1100-741

Round knurl handle / double / 1 mm / 6 1/4"

1100-7411



1100-7411

**Wide Barrel Grip Knife Handle #3**

Round knurled / straight / 5" (12.7 cm)

117-577



117-577

**Universal Adjustable Angle Knife Handle #3**

Adjustable tip & lock / straight / 10 mm locking increments of 7 positions / 6 1/2" (16.5 cm)

117-578 vertical adjusting

117-5781 horizontal adjusting



117-578



117-5781

**Staley Round Knurled Knife Handle**

Aluminum / 6" (15.2 cm)

117-571



117-571

**Sontec Knife Handle #3XXL**

16" (40.6 cm)

1100-8681



**Beaver® Blade Chuck Handle #3K**

Fits Beaver® style blades

117-560 4" (10 cm)

T117-560 4" (10 cm) titanium

117-561 3" (7.5 cm)



117-560



T117-560

**Blake Blade Holder**

Fits size blades #10, 11, 12, 12D, 15, 15C

1100-7413



1100-7413

**Siegel Knife Handle**

Fits surgical blades 10-15 / round handle

117-588



117-588

**Gubish Surgical Pen Holder Set**

5 1/4" (13 cm)

117-593



chuck

117-593



 Sontec Instruments®

ENT SINUSCOPY

**Sontec Micro Alligator Forceps**

Delicate / lacrimal ducts / 4 mm x 0.9 mm jaw / 3 1/4" (8 cm) shaft

- 469-040 straight with lock
- 469-050 angled right with lock
- 469-048 angled left with lock
- 469-036 straight without lock



**Alligator Forceps Tubular Shaft**

Delicate, flexible, tubular shaft / jaw width is uniform / 10 mm length x 1 mm width

- 1271-010 3 1/2" (9 cm) shaft
- 1271-011 5 1/2" (14 cm) shaft
- 1271-012 6 1/2" (16.5 cm) shaft
- 1271-013 9" (23 cm) shaft

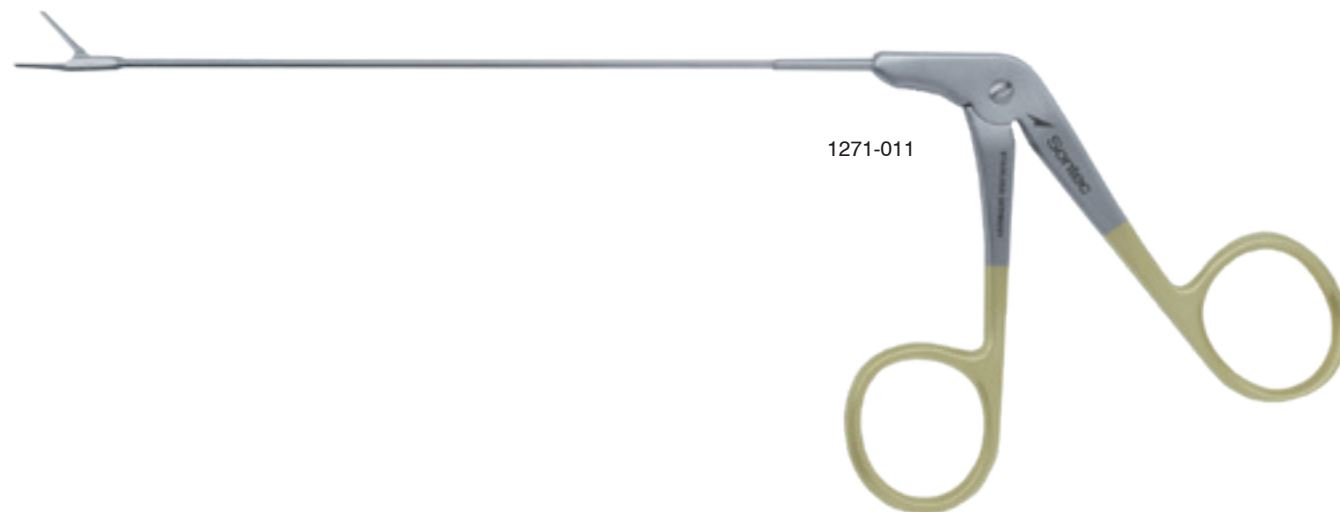

**Alligator Forceps**

With lock / delicate jaw / 3 1/2" (9 cm) delicate shaft

- 1100-328S short jaw



**Side Biting Alligator Forceps**

10 mm jaw

- 469-009 TC 2 1/4"
- 469-010 TCD 3 1/2"
- 469-012 TC 2 1/2"



**Micro House Alligator Forceps**

**Extremely delicate / 3 1/2" (8.9 cm) shaft**

469-041Q 3 mm x 0.6 mm jaw

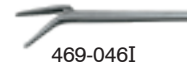

469-046I

**0.6 mm x 7 mm jaw / 3 1/4" (8 cm) shaft**

469-042Q angled up

469-046Q angled down



469-041I



469-042I

**Micro Sontec® Alligator Forceps**

**Extremely delicate / 3" (9 cm) shaft**

469-039 straight 4 mm x 0.9 mm jaw

469-041 straight 4 mm x 0.6 mm jaw

469-044 angled up 4 mm x 0.6 mm jaw

**Extremely delicate / smooth TC Dust / straight / 4 mm x 0.9 mm jaw / 3" (9 cm) shaft**

469-038



469-041



469-038

**Micro House Biopsy Alligator Forceps**

**3 1/2" (9 cm) shaft**

469-070	straight	1.2 mm x 0.9 mm oval cup
469-071	straight	1.0 mm x 0.6 mm oval cup
469-072	angled up	1.0 mm x 0.6 mm oval cup
469-074	angled down	1.0 mm x 0.6 mm oval cup
469-078	angled right	1.0 mm x 0.6 mm oval cup
469-076	angled left	1.0 mm x 0.6 mm oval cup

**3" (7.5 cm) shaft**

469-070B	straight	1.2 mm x 0.9 mm oval cup
----------	----------	--------------------------



**Arthroscopic Grasping & Biopsy Combo Rongeur Forceps**

**Tubular shaft / serrated bite**

1271-020	2.0 mm cup	4" (10 cm) shaft
1271-020R	2.0 mm cup	4" (10 cm) shaft
1271-016	2.7 mm cup	4" (10 cm) shaft
1271-018	3.4 mm cup	4" (10 cm) shaft
1271-021	2.0 mm cup	6" (15.5 cm) shaft
1271-021A	2.0 mm cup	6" (15.5 cm) shaft rear actuator hand

\* Available in 4.5 mm, please ask for details

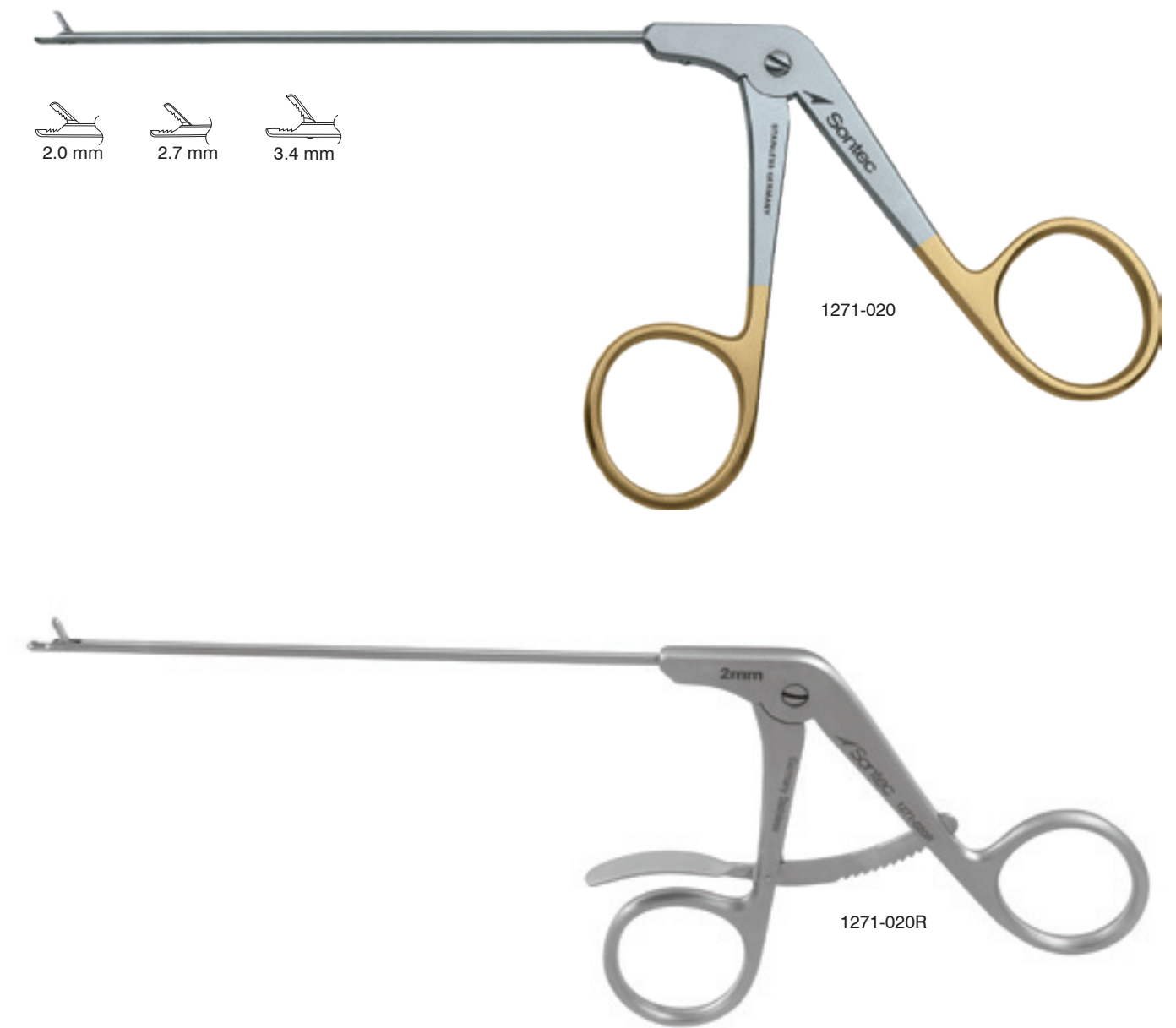

**Micro Biopsy Forceps with Flexible Tubular Shaft**

Tapered tubular shaft / 1mm round cup jaw

- 1271-0151 3 1/2" (9 cm)
- 1271-0152 5 1/2" (14 cm)
- 1271-0153 6 1/2" (16.5 cm)
- 1271-0154 9" (23 cm)



1271-0151

**Mini Arthroscopic Small Joints Rongeur Set**

Tubular 4" (10.2 cm) shaft / 2.0 mm jaws

- 1271-005 grasping forceps
- 1271-005A grasping forceps rear actuator handle 6"
- 1271-006 fine scissors
- 1271-007 basket punch
- 1271-008 round cup biopsy rear actuator handle
- 1271-009 round cup biopsy

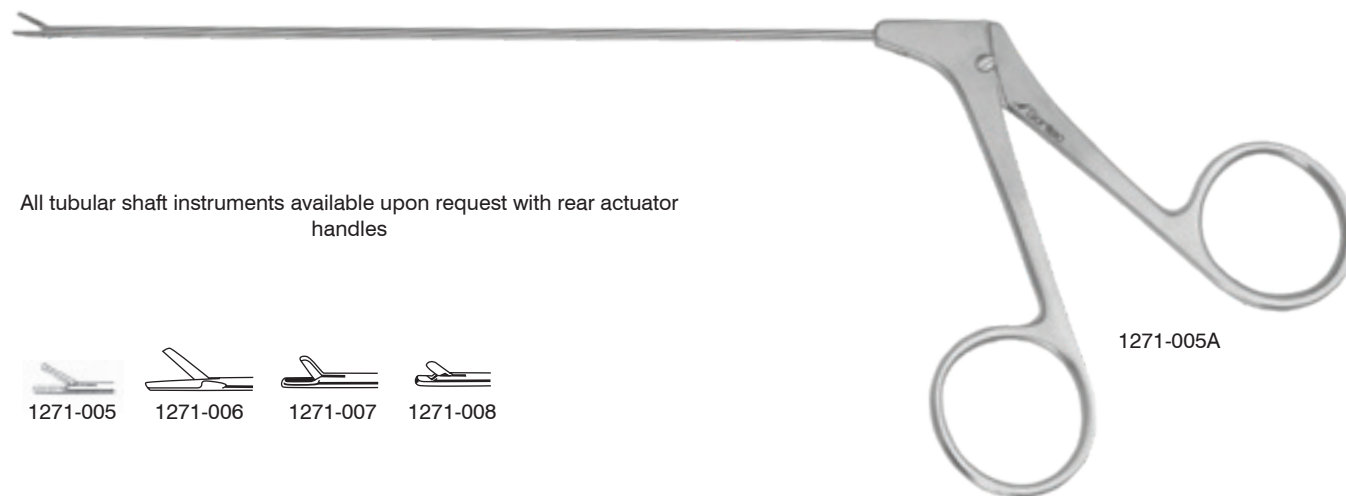

1271-005A

All tubular shaft instruments available upon request with rear actuator handles

- 1271-005
- 1271-006
- 1271-007
- 1271-008

**Frontal Sinus Giraffe Punch**

Double Action Cup / 50 degrees / 5 3/4" (14.6 cm) shaft

- 468-340 vertical 2 mm
- 468-342 horizontal 2 mm

Double Action Cup / 90 degrees / 5 3/4" (14.6 cm) shaft

- 468-343 horizontal 2 mm
- 468-344 vertical 2 mm



468-340



468-342



468-343



468-344

**Frontal Sinus Giraffe Forceps**

Double Action Cup / 45 degrees / 5 1/4" (13.5 cm) shaft

- 468-330 vertical 2 mm
- 468-331 horizontal 2 mm
- 468-332 vertical 3 mm
- 468-333 horizontal 3 mm

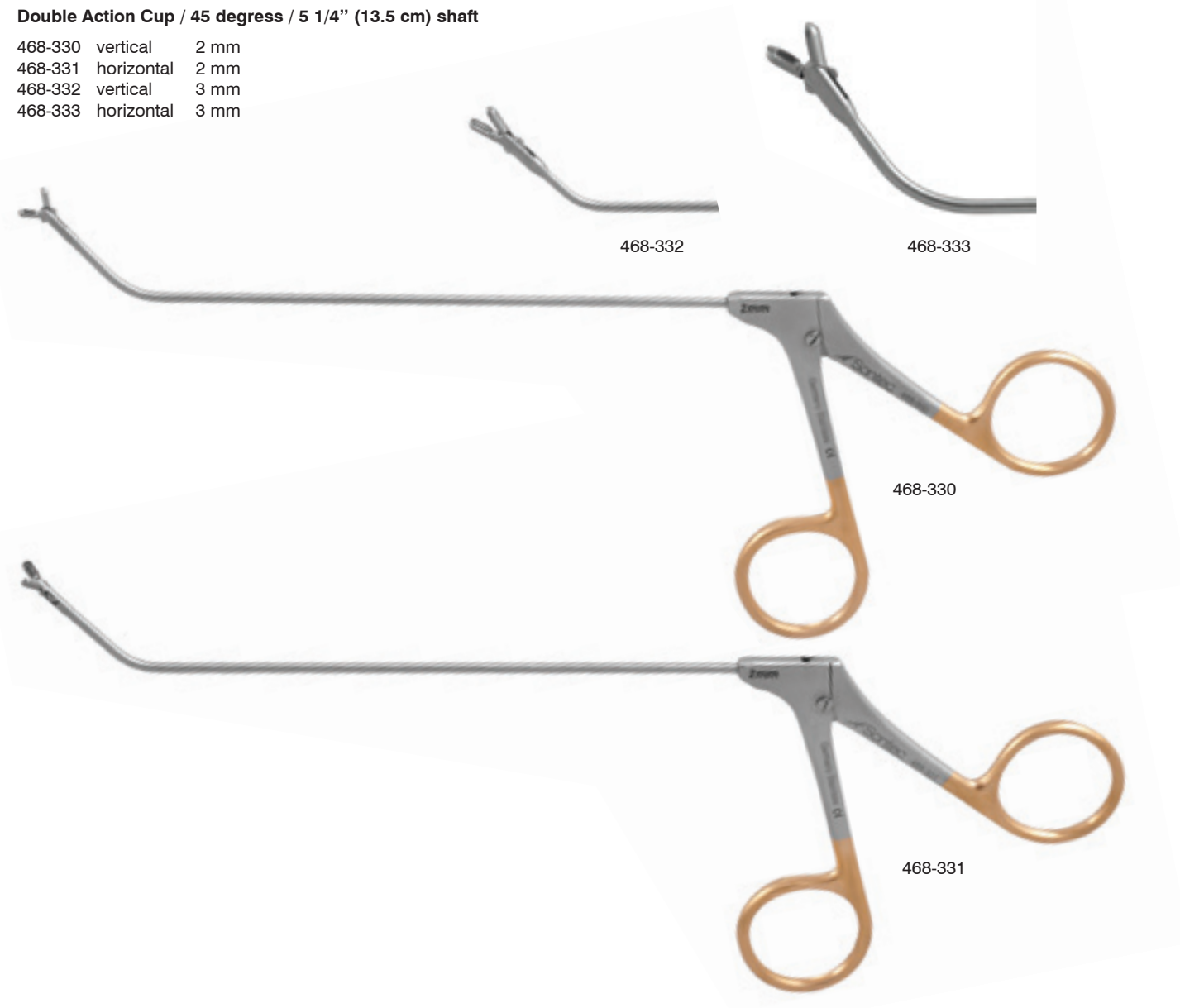

**Micro Biopsy Forceps with Flexible Shaft**

Flexible shaft / 2.2 round cup jaw / 6" (15.2 cm) flexible shaft

1271-0156



**Frontal Sinus Giraffe Forceps**

Double Action Cup / 90 degrees / 5 1/4" (13.5 cm) shaft

- 468-334 horizontal 2 mm
- 468-335 vertical 2 mm
- 468-336 horizontal 3 mm
- 468-337 vertical 3 mm
- 468-338 vertical 4 mm
- 468-339 horizontal 4 mm

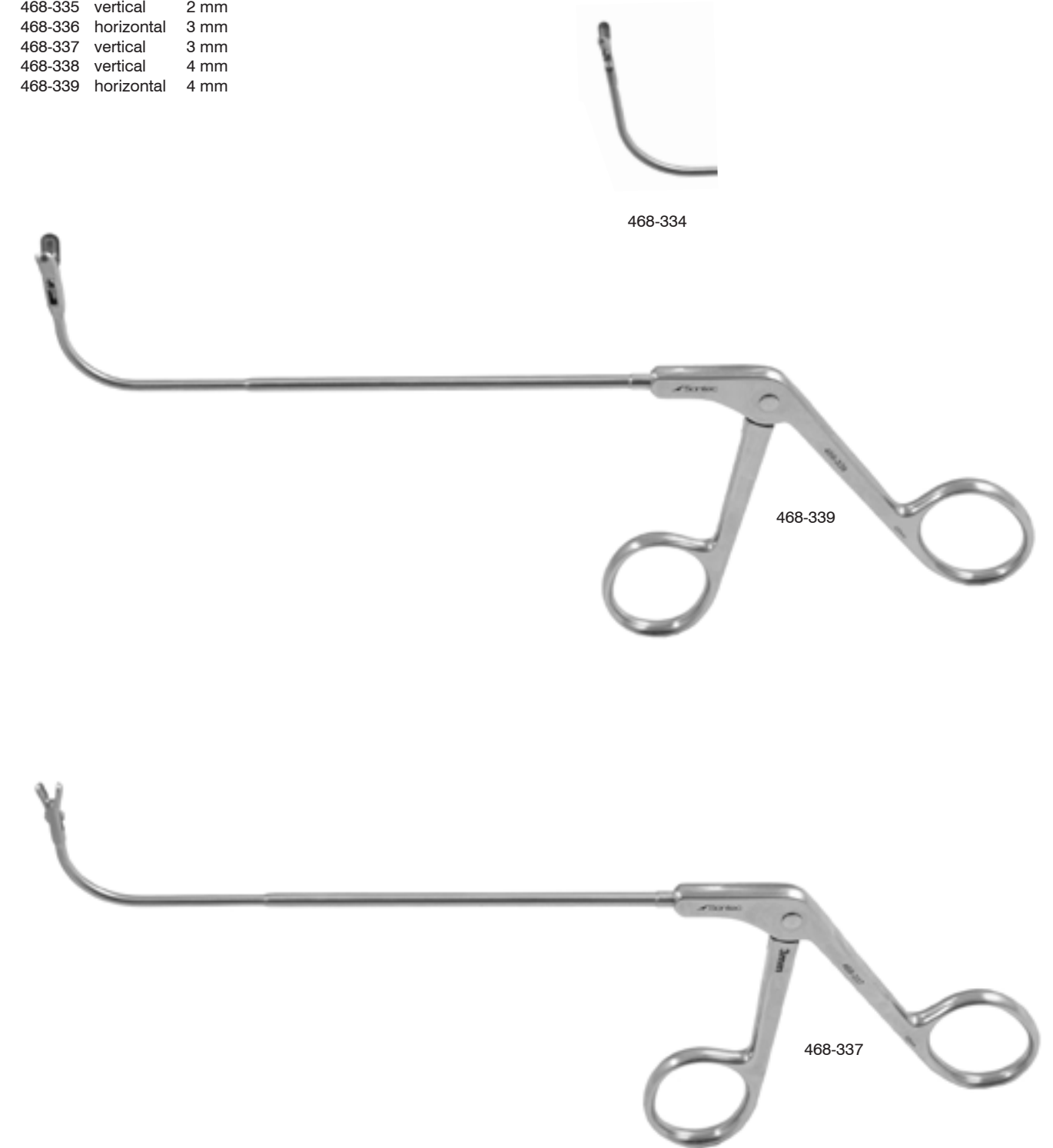

**Jurasz Laryngeal Forceps**

**Single articulating jaws / 9" (23 cm)**

- 502-271 lateral opening jaws
- 502-272 vertical opening jaws left
- 502-273 lateral opening jaws right
- 502-274 vertical opening jaws

**Double articulating jaws / 9" (23 cm)**

- 502-275 lateral opening
- 502-276 vertical opening



502-272



502-273



502-274

**Sontec Micro Biopsy Forceps**

**Round cup**

469-062	1.0 mm cup	3 1/4" (8 cm) shaft	
469-063	2.0 mm cup	3 1/4" (8 cm) shaft	
469-063A	2.0 mm cup	3 1/4" (8 cm) shaft	angled up
469-063M	2.5 mm cup	3 1/4" (8 cm) shaft	
469-063L	3.0 mm cup	3 1/4" (8 cm) shaft	
469-063X	4.0 mm cup	3 1/4" (8 cm) shaft	
469-081	1.0 mm cup	6" (15 cm) shaft	
469-082	2.0 mm cup	6" (15 cm) shaft	
469-080	2.5 mm cup	6" (15 cm) shaft	
469-083	3.0 mm cup	6" (15 cm) shaft	
469-084	4.0 mm cup	6" (15 cm) shaft	
469-085	5.0 mm cup	6" (15 cm) shaft	

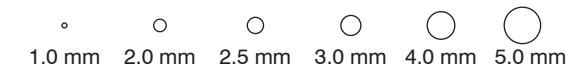

469-063M

**Fraenkel Laryngeal Forceps**

**Foreign body grasping forceps / double articulating jaws / vertical opening / 9" (23 cm)**

502-277



502-277

**Back Biter Ostrum Antrum Punch Rongeur**

**Straight / 5" (12.5 cm) shaft**

- 468-300 pediatric 1 mm x 4 mm bite
- 468-305 medium 1 1/2 mm x 8 mm bite



**Circular Cutting Antrum Punch Rongeur**

**Cuts a full 360 degrees without rotating the instrument / 7" (18 cm) shaft**

- 468-350 str 3.5mm
- 468-351 str 4.5mm
- 468-352 65° cvd up 3.5mm

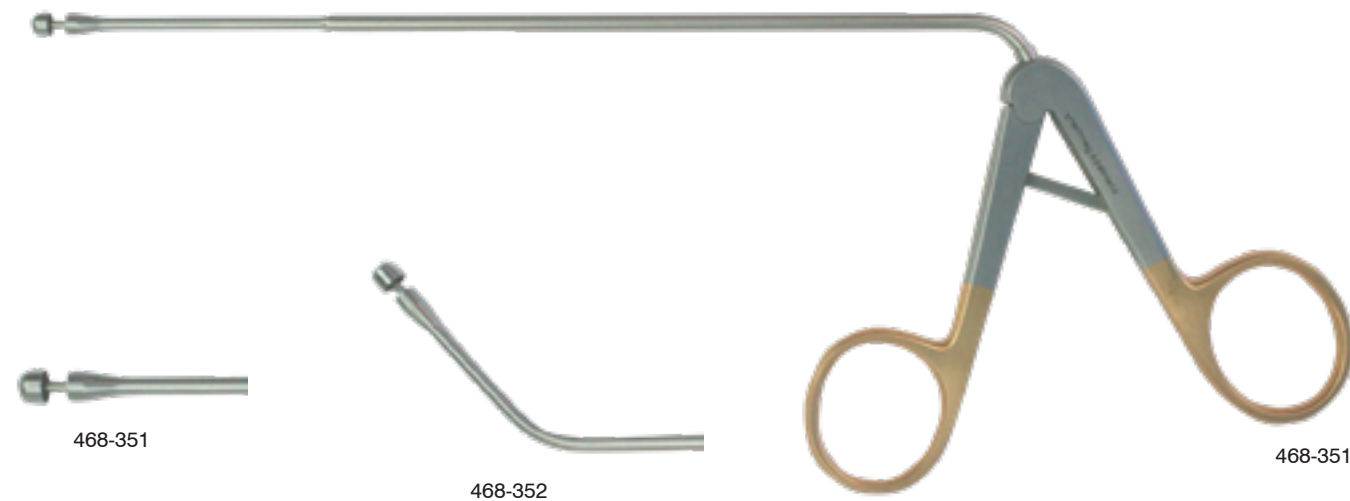

**Biopsy Forceps**

**4 mm cup / double action / vertical jaw open / straight / 180 mm working length**

468-370



**Circular Cutting Antrum Punch Rongeur**

**Cuts a full 360° without rotating the instrument / 6 1/4" working length / 3.5 mm tip**

- 468-346 straight
- 468-347 45° curved up
- 468-348 65° curved up

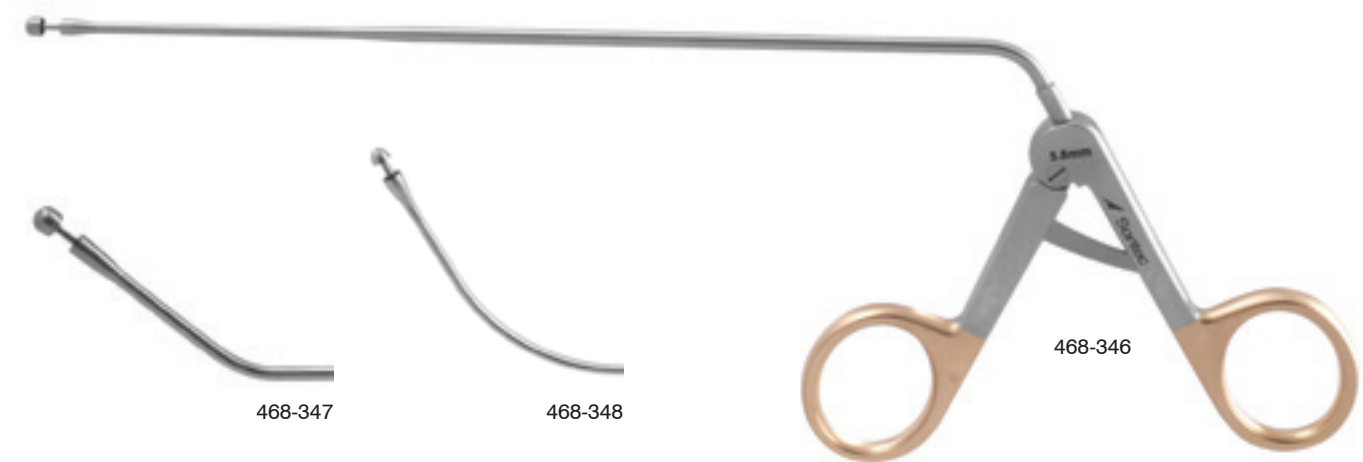

**Micro Antrum Punch Rongeur**

360° rotatable shaft / backward biting / curved shaft / 100 mm working length

468-298 1.5 mm x 4 mm bite



**Antrum Biopsy Forceps**

Double action / vertical jaw / straight / 140 mm working length

468-371 3 mm x 5 mm oval cup  
 468-372 2.2 mm x 3.8 oval cup  
 468-373 4 mm x 6 mm oval cup



**Back Biter Rotating Punch Rongeur**

360° rotatable / backward biting / 5 1/2" (14 cm) shaft

468-318 1.5 mm x 7 mm bite  
 468-320 2 mm x 7 mm bite  
 468-319 2.5 mm x 7 mm bite

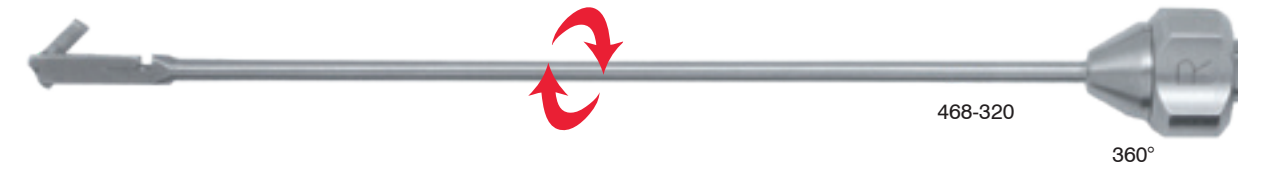
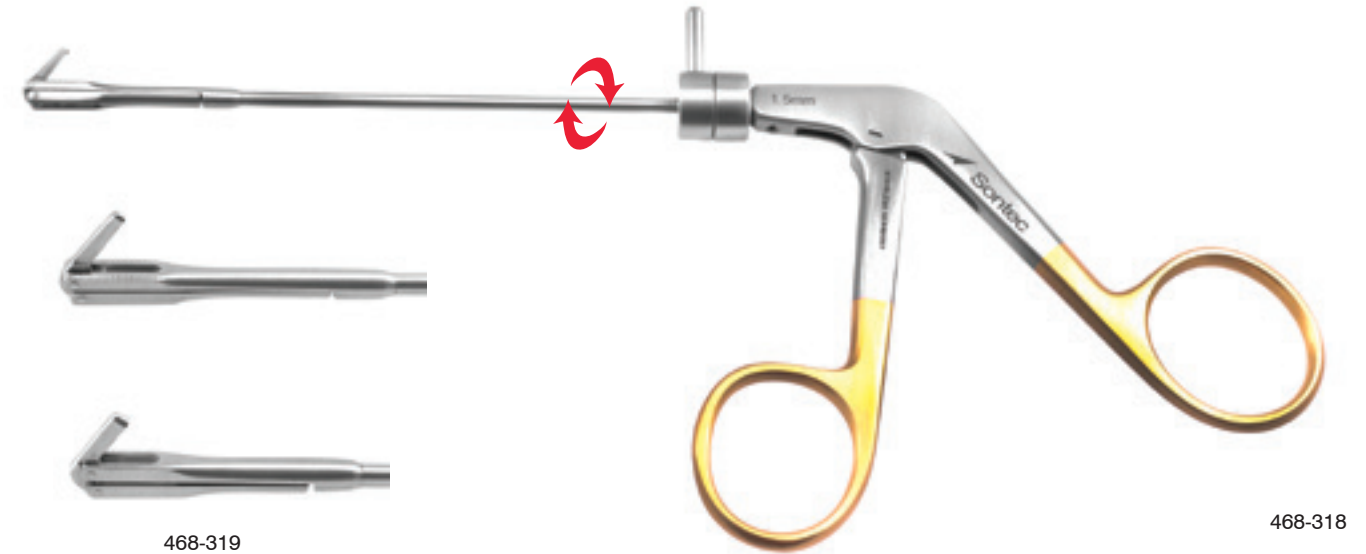

360° rotatable shaft / backward biting / with suction / 100 mm working length / 5 1/2" (14 cm) shaft

468-3185 1.5 mm x 6 mm bite



**Antrum Grasping Forceps**

90° to 120° backbiter jaw open / 10 cm working length

- 468-360 fixed shaft
- 468-362 360° rotatable shaft
- 468-361 fixed shaft downward bite jaw

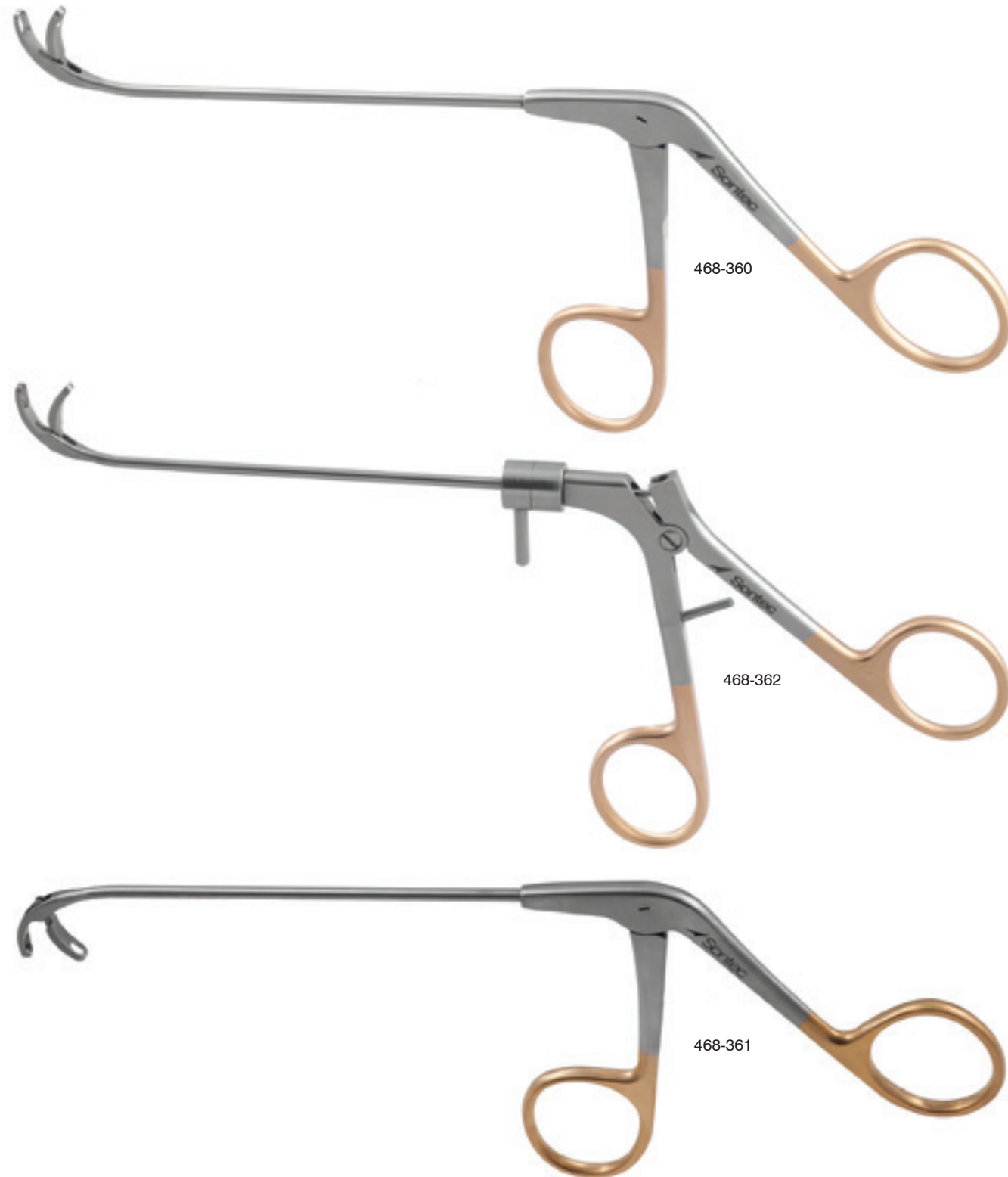

**Frontal Ostium Nasal Rongeur**

70° curved up / 5 1/2" (14 cm) shaft

- 468-010 2 mm x 2.5 mm jaw pediatric
- 468-011 3 mm x 3.5 mm jaw
- 468-012 5 mm x 5 mm jaw



**Back Biter Ostrum Antrum Punch Rongeur**

Back cut / 5 1/2" (14 cm)

- 468-315 1.5 mm x 7 mm
- 468-316 2.0 mm x 7 mm
- 468-317 2.5 mm x 7 mm



**McIlwraith Arthroscopic Scissors Rongeur**

Scissor action / serrated / 1 mm x 14 mm cup / 5" (12.5 cm) shaft  
1404-855



**McIlwraith Basket Cutter Rongeur**

5" (12.5 cm)  
1404-857 2.5 mm x 8 mm jaw  
1404-858 3.5 mm x 8 mm jaw



**Nasal Scissors**

Serrated / 5" working length  
468-090 straight  
468-092 left  
468-094 right



**Nasal Scissors**

13 mm blunt blades /  
6 1/4" (16 cm) shaft  
468-104





 Sontec Instruments®

Scissors

**Sontec® Scissors are simply unmatched in design, function, quality and variety. Sontec Scissors are offered in any model blade, shape or size in all of our model options listed below:**

**Classic Model**

- Combining extremely high quality with unmatched value
- Satin or high gloss finish

**Tungsten Carbide - TC inserts**

**Gold Rings**

- diamond-ground tungsten-carbide inserts
- extremely sharp
- Blade hardness greatly increases scissor life
- available with or without serrations

**Powercut blades® - PC gold**

**Gold Rings with Stripes on Shanks**

- sharpest cutting edge available
- serrated unless otherwise requested
- Finished in Sontec's Trademarked PC Gold design
- All the attributes of Sontec PC Black scissors

**Powercut blades® - PC black**

**Black Rings**

- All the attributes of Sontec PC Gold
- Beautifully ornamented in black chrome

**Tungsten Carbide / Power Cut - TC/PC:**

**Gold Ring / Black Ring**

- Serrated unless otherwise requested
- a combination of the best options
- HANDLE: one gold ring, one black ring
- This premier line encompasses TC long life, PC power, and Sontec Quality

**Ceramic Coated Scissors:**

**Black Ring**

- offered to protect your investment even further by putting the instrument into an extremely hard coating which adds more life to your Sontec Scissors
- Offered in either PC or TC/PC models



**Operating Classic, Tungsten Carbide, Power Cut Gold, Power Cut Black®, TC/PC Power Cut® Scissors**

**Blunt-blunt / straight / 5 1/2" (14 cm)**

- 1100-212 classic
- 1100-212L classic left
- 1100-260 TC
- 1200-212 PC gold
- 1200-712 PC black



blunt-blunt



sharp-blunt

**Blunt-blunt / curved / 5 1/2" (14 cm)**

- 1100-224 classic
- 1100-262 TC
- 1200-224 PC gold
- 1200-713 PC black



1200-229

**Sharp-blunt / straight / 5 1/2" (14 cm)**

- 1100-214 classic
- 1100-214L classic left
- 1100-265 TC
- 1200-214 PC gold
- 1200-229 TC/PC
- 1200-714 PC black



1100-214L

**Sharp-blunt / curved / 5 1/2" (14 cm)**

- 1100-226 classic
- 1100-264 TC
- 1200-226 PC gold
- 1200-715 PC black



1200-714

**Operating Classic, Tungsten Carbide, Power Cut Gold, Power Cut Black®, TC/PC Power Cut® Scissors**

**Sharp-sharp / straight / 5 1/2" (14 cm)**

- 1100-216 classic
- 1100-268 TC
- 1200-216 PC gold
- 1200-231 TC/PC
- 1200-716 PC black



blunt-blunt

sharp-blunt

**Sharp-sharp / curved / 5 1/2" (14 cm)**

- 1100-228 classic
- 1100-270 TC
- 1200-228 PC gold
- 1200-717 PC black



1100-268



1200-716

**Reynolds Tenotomy Classic, Power Cut Gold, Power Cut Black®, TC/PC Power Cut® Scissors**

**Classic / 5 3/4" (14.5 cm)**

- 2405-324S straight
- 2405-324 curved

**PC gold / 5 3/4" (14.5 cm)**

- 2400-324S straight
- 2400-324 curved

**PC black / 5 1/4" (13.3 cm)**

- 2400-823S straight
- 2400-823 curved

**PC black / 5 3/4" (14.5 cm)**

- 2400-824S straight
- 2400-824 curved

**TC/PC / 5 3/4" (14.5 cm)**

- 2405-824S straight
- 2405-824 curved

**Classic / 6 1/4" (16 cm)**

- 2405-326 straight
- 2405-327 curved

**PC gold / 6 1/4" (16 cm)**

- 2400-326 straight
- 2400-327 curved
- 1200-348 curved spread handle

**PC black / 6 1/4" (16 cm)**

- 2400-826 straight
- 2400-827 curved
- 2400-827S curved spread handle

**TC/PC / spread handle / 6 1/4" (16 cm)**

- 2405-826 straight
- 2405-827 curved



2405-324S



2400-327



2400-827S

**Freeman-Kaye Ergonomic Spread Handle Saberback Scissors**

Ergonomic / spread handle / double beveled blades / spatulated tip / curved / TC/PC

475-188 7 1/4" (18.5 cm)  
475-187 9" (23 cm)

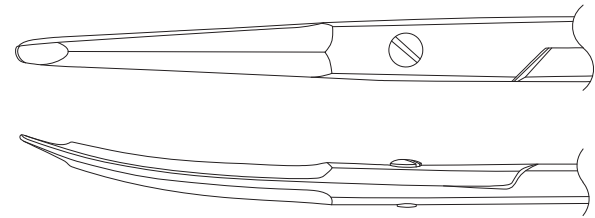

475-188

Ergonomic / spread handle / double beveled blades / flat tip / straight / TC/PC

475-185 7 1/4" (18.5 cm)  
475-186 9" (23 cm)



475-185



**Freeman-Kaye Ergonomic Spread Handle Saberback Scissors**

Ergonomic / spread handle / double beveled blades / flat tip / curved / PC black / delicate

475-182 7 3/4" (20 cm) fino  
475-184 9" (23 cm)

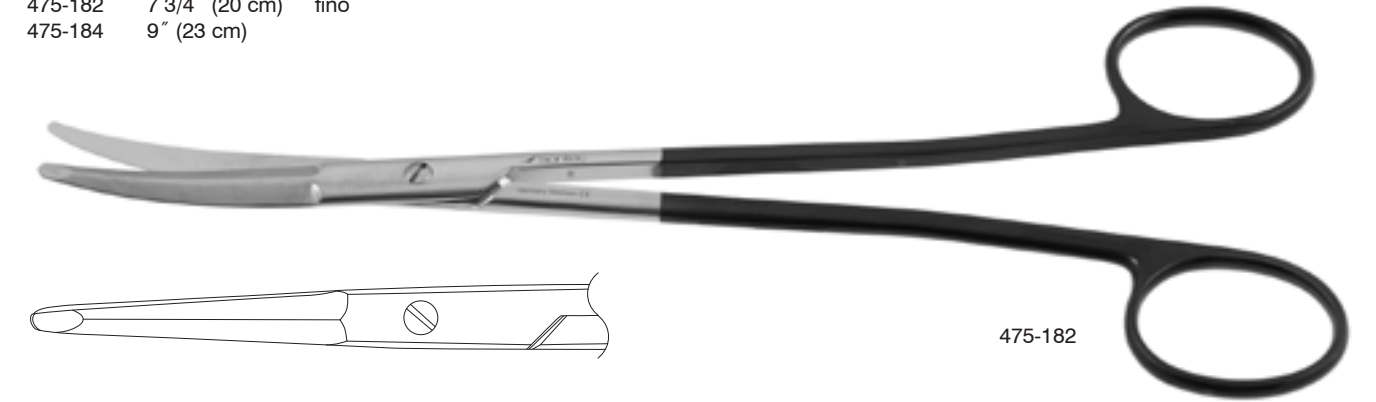

475-182

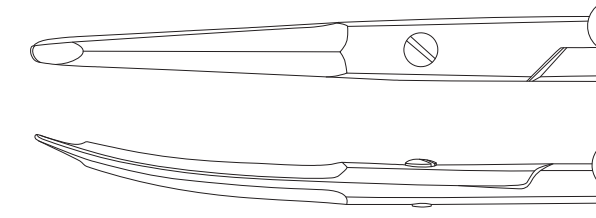

475-184

**Freeman-Kaye Ceramitec Ergonomic Spread Handle Saberback Scissors**

Ergonomic / spread handle / double beveled blades / spatulated tip / curved / TC/PC / black ceramic / gold handles

475-188B 7" (17.8 cm)



475-188B

**Wilkinson Rhytidectomy Scissors**

TC/PC / curved / angled shaft / 7 1/2" (19 cm)  
475-250



475-250

**Black Kaye Scissors**

Saberback / PC black / curved / 5 3/4" (14.5 cm)  
1200-851



1200-851

**Kahn-Fomon Scissors**

Saberback / PC gold / spread handle / curved / 5 1/2" (14 cm)  
1200-392



1200-392

**Gorney-Kahn Scissors**

Saberback spatulated tips / TC / 5 3/4" (14.5 cm)

475-203 straight  
475-204 curved

TC / 8" (20 cm)

475-207 straight  
475-208 curved



475-204

**Aufricht Saberback Power Cut Black® Scissors**

PC black / 5 3/4" (14.6 cm)

1200-848 straight  
1200-849 curved

PC gold / 6 3/4" (17 cm)

475-220 straight  
475-225 curved



1200-848

**Kahn Face-Lift Scissors**

**Saberback / PC gold / 5 3/4" (14.5 cm)**

- 475-174 straight
- 475-175 curved



475-174

**PC black / 5 3/4" (14.5 cm)**

- 1200-830 straight
- 1200-831 curved



curved

**PC gold / 7" (18 cm)**

- 475-190 straight
- 475-191 curved

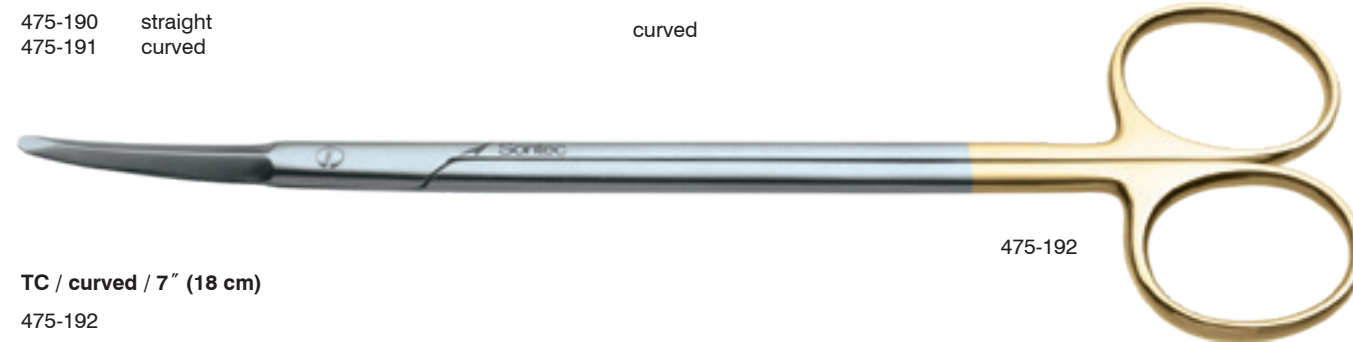

475-192

**TC / curved / 7" (18 cm)**

- 475-192

**TC/PC / 7" (18 cm)**

- 475-194 straight
- 475-195 curved

**PC two-tone silver / 7 1/2" (19 cm)**

- 475-196 straight
- 475-197 curved

**Trepsat Face-Lift Scissors**

**Black ceramitec / 6 3/4" (17 cm)**

- 1200-925 PC straight



**Plastic Surgery Scissors**

**Sharp/sharp / classic / 4 3/4" (12 cm)**

- 2400-045 straight
- 2400-047 curved

**Sharp/sharp / PC gold / 4 3/4" (12 cm)**

- 2400-053 straight
- 2400-055 curved

**Blunt/blunt / classic / 4 3/4" (12 cm)**

- 2400-049 straight
- 2400-051 curved

**Blunt/blunt / PC gold / 4 3/4" (12 cm)**

- 2400-057 straight
- 2400-059 curved

**Sharp/blunt / classic / 4 3/4" (12 cm)**

- 2400-043 straight
- 2400-044 curved

**Sharp/blunt / PC gold / 4 3/4" (12 cm)**

- 2400-061 straight
- 2400-063 curved



2400-053



sharp-sharp



blunt-blunt



sharp-blunt

**Littler Suture Carrying Scissors**

Fenestrated blade tips / curved / 4 3/4" (12 cm)  
475-164



**Giunta Tungsten Carbide Serrated Scissors**

TC / Angled up / bayonet  
475-148 straight blades 4 1/4" (11 cm)  
475-150 5" (12.5 cm)



**Biro Naevus Scissors**

Angled-up / sharp / 4" (10 cm)  
199-500  
199-501 PC gold  
199-501B PC Black

Angled-up / sharp / spread handle / 4" (10 cm)  
199-502 PC gold



**Swedish Gradle Scissors**

PC gold / ergonomic spread handle / sharp / 3 3/4" (9 cm)  
199-550



199-550

**Chadwick Scissors**

PC gold / sharp / curved / 4 3/4" (12 cm)  
1200-407



1200-407

open

side view

**Taylor Dura Scissors**

Beaded tip / PC Gold / 6 1/2" (16.5 cm)  
\*Can also be used as a bandage scissors  
1200-195

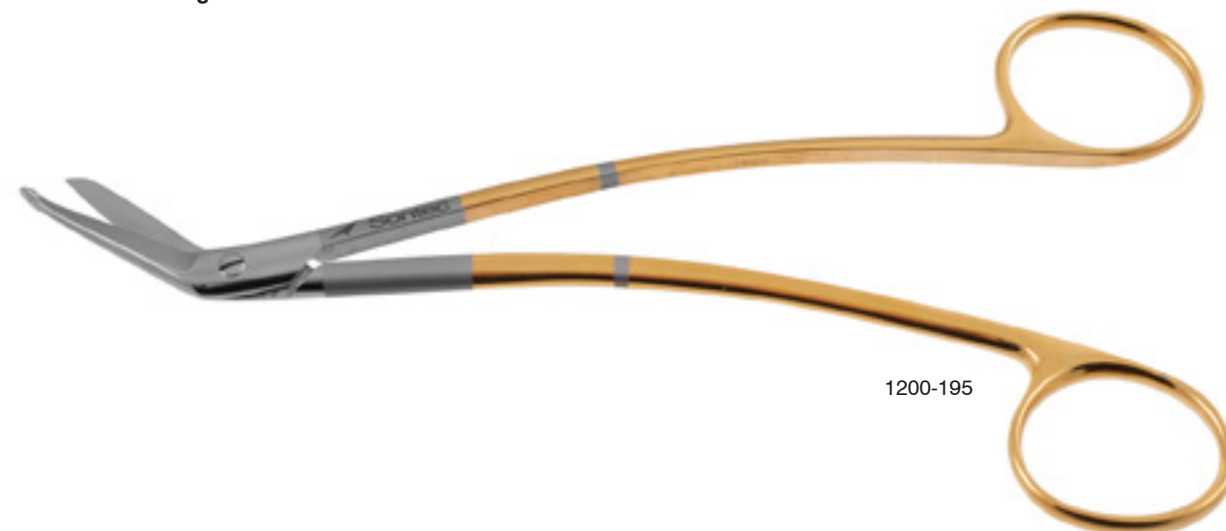

1200-195

**Jabaley Scissors**

PC black / 4 3/4" (11 cm)  
2400-753 straight  
2400-755 curved

Ergonomic spread handle / PC black / 5" (12.7 cm)

2400-756 curved  
2400-757 straight

Black ceramic with gold screw / ergonomic spread handle / PC / 5" (12.7 cm)

1200-940 curved



2400-756



1200-940

**Par Scissors**

TC / 4 1/2" (11.5 cm)  
112-580 straight  
112-585 curved

TC / 5 3/4" (14.5 cm)  
112-581 straight  
112-582 curved

PC gold / curved / 5 3/4" (14.5 cm)  
1200-402



1200-402

**Cooley Power Cut Gold® Scissors**

PC gold / 7 1/2" (19 cm)

- 2400-396 straight
- 2400-397 curved



2400-397

**Joseph Sharp Sharp Classic Power Cut Gold® Power Cut Black® Scissors**

PC Black / 5 1/2" (14 cm)

- 2400-728 straight
- 2400-729 curved



2400-728

PC Gold / 5 1/2" (14 cm)

- 2400-428 straight
- 2400-435 curved



2400-435

5 3/4" (14.5 cm)

- 110-312 straight
- 110-313 curved

**Joseph-Peck Saberback Classic Power Cut Gold® Power Cut Black® TC/PC Power Cut Scissors**

Saberback / curved / 4 1/2" (15 cm)

- 2400-438 PC Gold

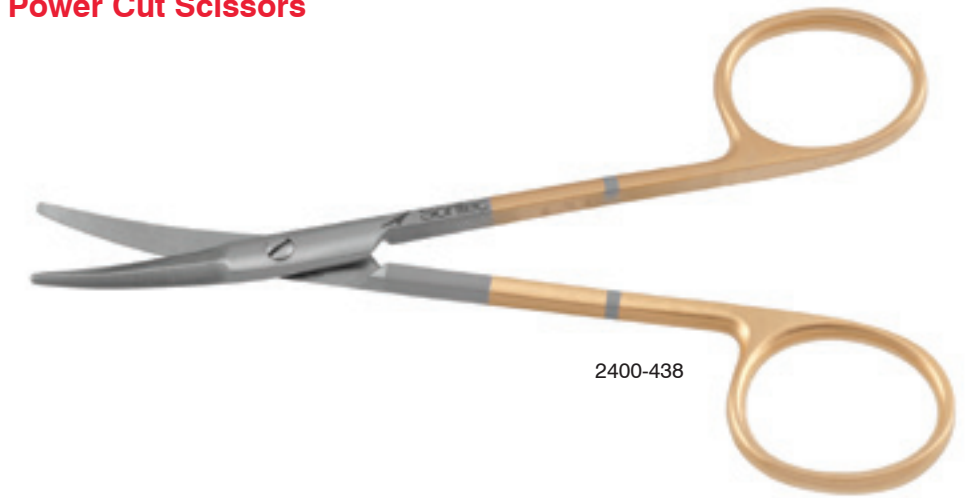

2400-438

Saberback / curved / 6" (15 cm)

- 2400-440 classic
- 2400-439 PC Gold
- 2400-442 TC/PC
- 2400-739 PC Black curved
- 2400-733 PC Black straight

Straight / 6" (15 cm)

- 2400-433 PC Gold

Ceramic coated / saberback / TC/PC curved blades / black with gold screw and gold shiny rings / 6" (15 cm)

- 1200-945



2400-442



1200-945

**Kelly Power Cut Gold® Power Cut Black® Fistula Scissors**

**PC Black / 6 1/4" (16 cm)**

- 508-636 straight
- 508-637 curved



508-637

**PC Gold / 6 1/4" (16 cm)**

- 508-638 straight
- 508-639 curved

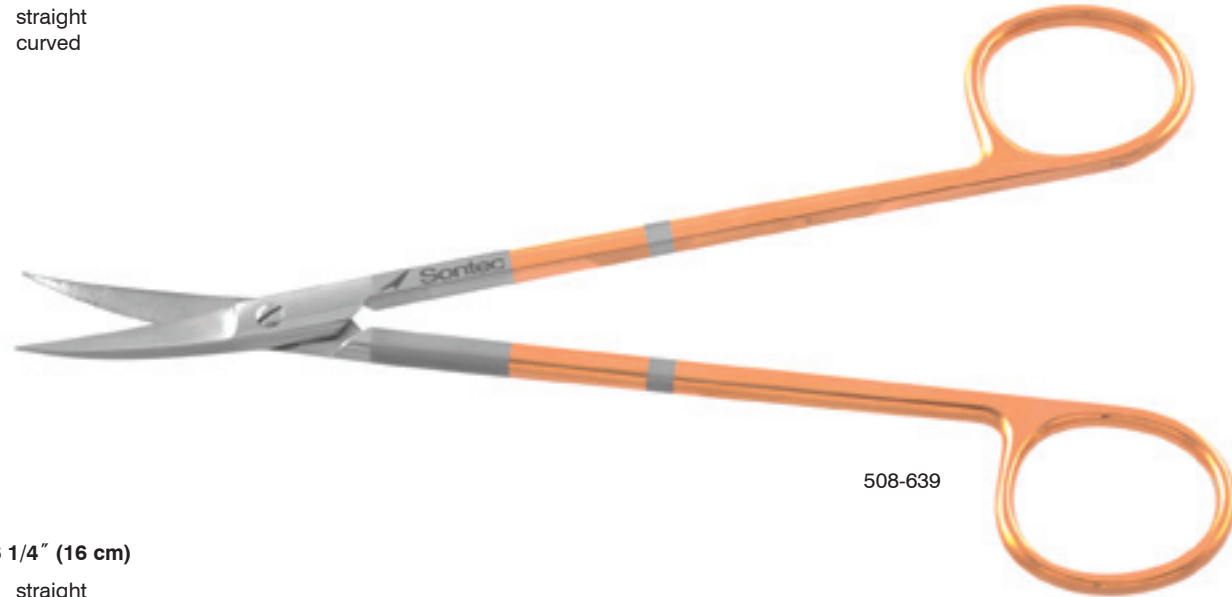

508-639

**Classic / 6 1/4" (16 cm)**

- 508-632 straight
- 508-633 curved



508-632

**Classic / serrated / 6 1/4" (16 cm)**

- 508-634 straight
- 508-635 curved

**Ragnell Undermining Power Cut Gold® Scissors**

**PC gold / spatulated tips / curved**

- 2400-374 4 1/2" (11.5 cm)
- 2400-375 5" (12.5 cm)
- 2400-3751 5" (12.5 cm) full curved
- 2400-376 5 1/2" (14 cm)
- 2400-377 6" (15 cm)
- 2400-379 7" (18 cm)
- 2400-381 8" (20 cm)
- 2400-383 9" (23 cm)
- 2400-383S 9" (23 cm) strong curved
- 2400-385 10 3/4" (26.5 cm)



strong curved  
2400-383S



2400-374



2400-375



2400-377

**Kaye Blepharoplasty Scissors**

Curved / spread handle / 4 3/4" (12 cm)

- 1200-076 PC Gold
- 1200-076B PC Black



**Brown Scissors**

PC gold / 5 3/4" (14.5 cm)

- 475-168 straight
- 475-170 curved



PC Black / 5 3/4" (14.5 cm)

- 475-168B straight
- 475-170B curved



**Kaye Blepharoplasty Scissors**

TC / 4 1/2" (11.5 cm)

- 112-602 straight
- 112-603 curved

Serrated / ribbon handle / 4 1/4" (10.8 cm)

- 1200-070 PC gold straight
- 1200-072 PC gold curved
- 13-6800 PC silver straight
- 13-6810 PC silver curved
- 13-6815 PC Black curved

Curved / spread handle / 4 3/4" (12 cm)

- 1200-076 PC Gold
- 1200-076B PC Black



**Fomon Saberback Scissors**

Semi-sharp outer edges / curved / 5 1/2" (14 cm)

- 475-140 classic
- 1200-400 PC Gold
- 1200-401 PC Black



1200-400

Semi-sharp outer edges / PC gold / curved / 4 3/4" (12 cm)

1200-399



1200-399



1200-401

**Sistrunk Scissors**

Curved / 5 1/2" (14 cm)

110-260

PC gold / curved

- 1200-410 5 1/2" (14 cm)
- 1200-411 6" (15 cm)



1200-411

PC black / straight / 6" (15 cm)

1200-840

**Castanares Scissors**

PC Gold / 6 3/4" (17.1 cm)

1200-445 straight



1200-445

**Castanares Scissors**

**Classic / 6" (15.2 cm)**

110-308

**TCPC / 6 1/2" (16.5 cm)**

1200-843 straight

**PC Black / 6" (15.2 cm)**

1200-845 straight

1200-846 curved



110-308



1200-845



1200-843

**Famous Saberback Scissors**

**PC gold / tenotomy tip / 6 1/2" (16.5 cm)**

1200-386 straight

1200-387 curved

**PC black / tenotomy tip / 6 1/2" (16.5 cm)**

1200-386B straight

1200-387B curved

**PC gold / tenotomy tip / 8" (20.5 cm)**

1200-388 straight

1200-389 curved



1200-387



1200-387B

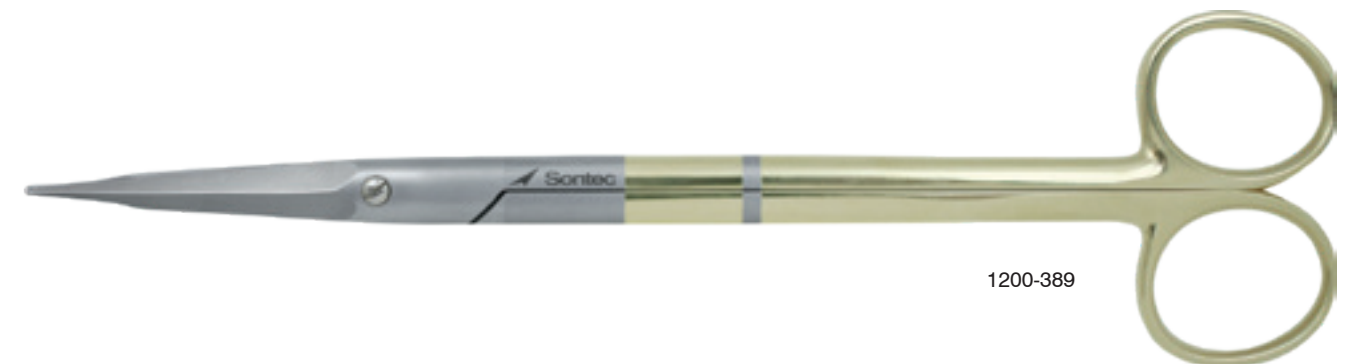

1200-389

**Sontec® Bipolar Metzenbaum Scissors**

For dissecting, cutting, and bipolar coagulation of tissue / one prong / classic blades

- 2700-5331 7"
- 2700-5341 8"
- 2700-5351 9"
- 2700-5371 11"

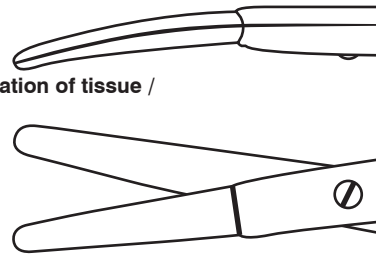

For dissecting, cutting, and bipolar coagulation of tissue / one prong / delicate blades

- 2700-5411 7"
- 2700-5431 8"
- 2700-5451 9"
- 2700-5471 11"

One prong cord / sold separately

- 2700-5251 3 meter cord
- 2700-5271 5 meter cord



130-141-300

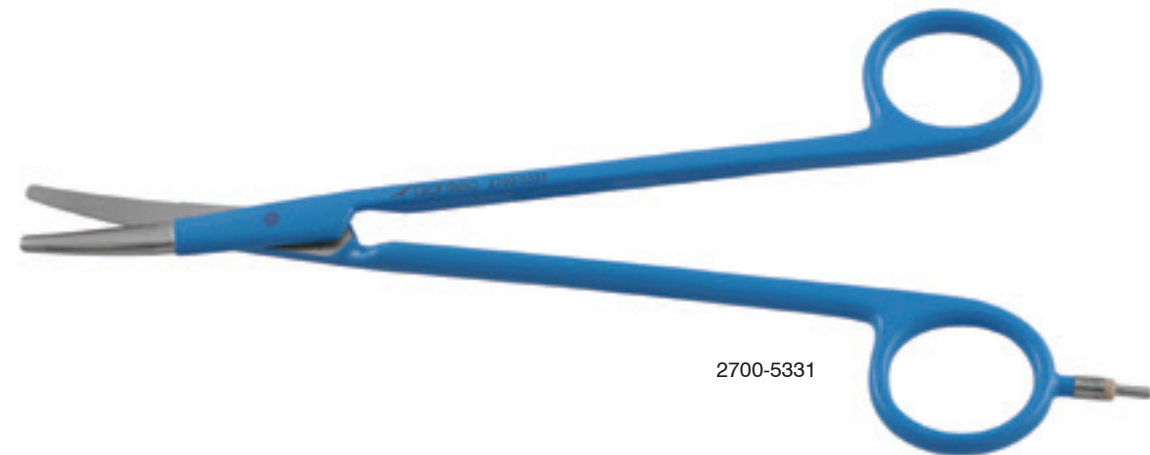

2700-5331

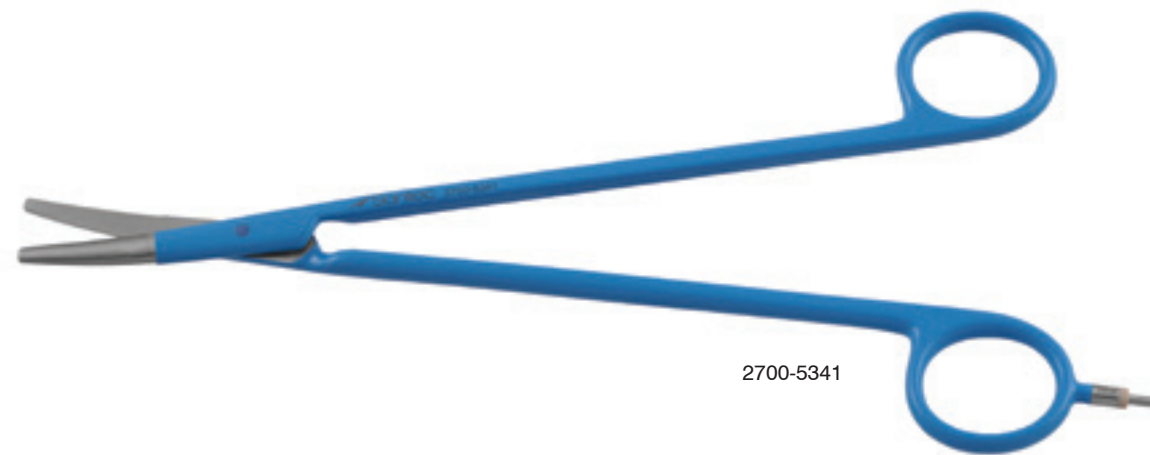

2700-5341

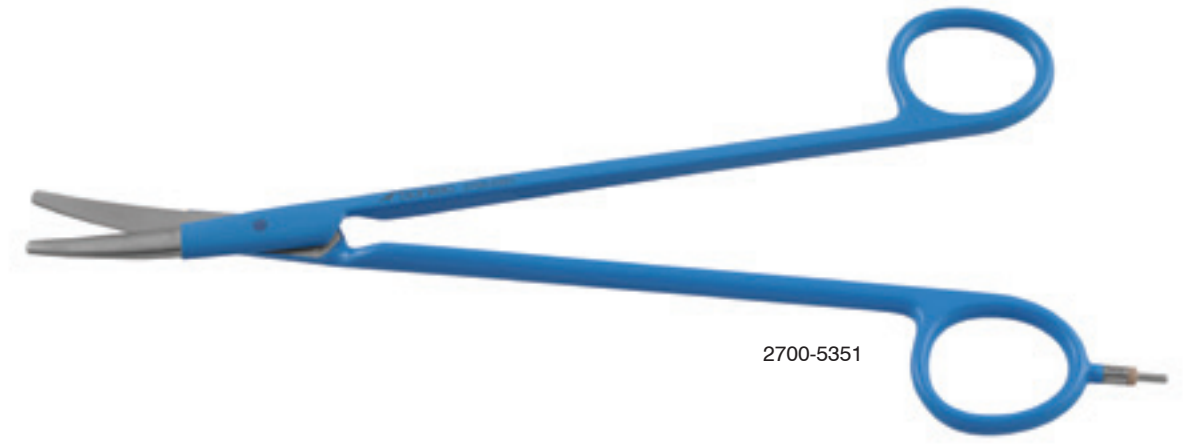

2700-5351

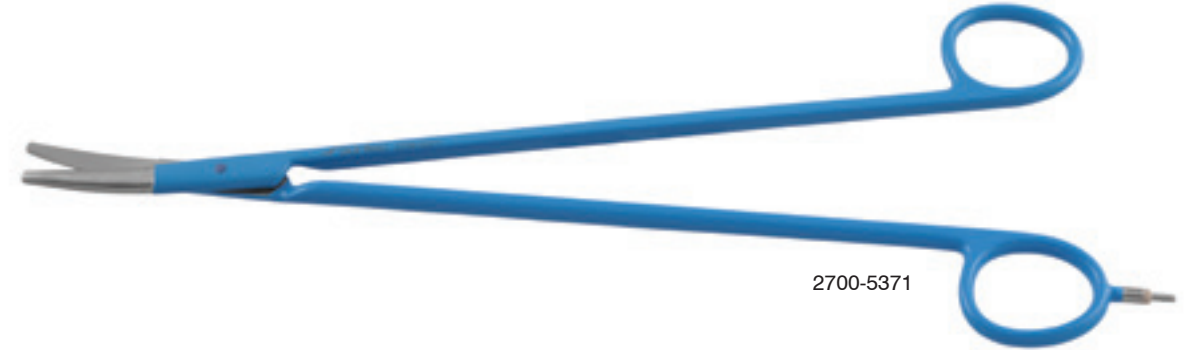

2700-5371

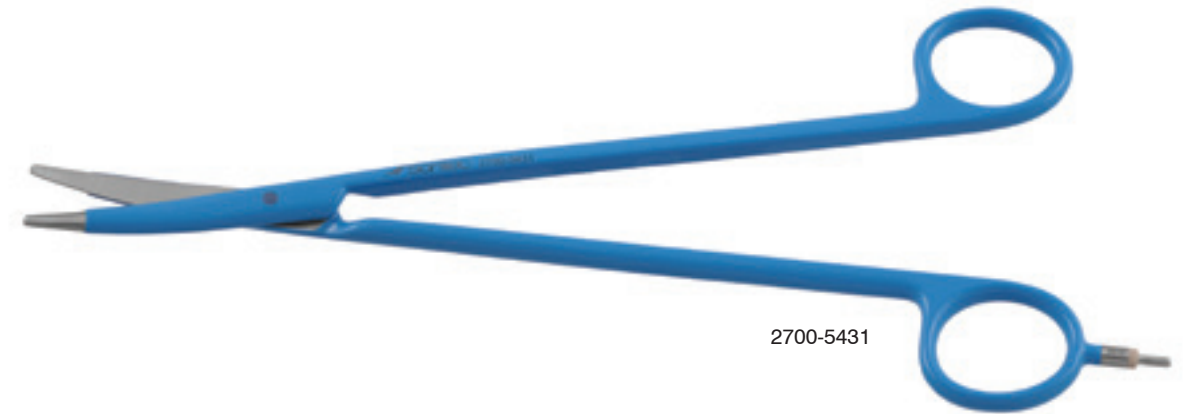

2700-5431

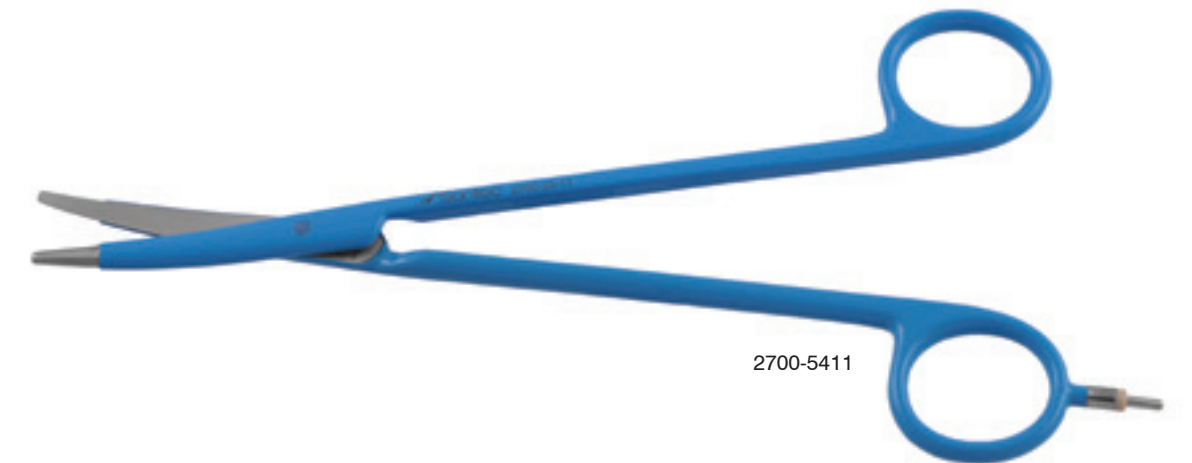

2700-5411

**Heymann Nasal Scissors**

PC gold / heavy / 7" (18 cm)  
475-302



475-302

**Knight Nasal Scissors**

Serrated / 7" (18 cm)  
475-300 classic  
475-304 PC black



475-304

**Knight Nasal Scissors**

Serrated / PC gold / 7" (18 cm)  
475-306 Right curved  
475-307 Left curved



475-306

**Gorney Turbinate Scissors**

PC gold / angled / 6 3/4" (17 cm)  
1200-420



1200-420

**Cottle-Dorsal Scissors**

TC / 6 1/2" (16.5 cm)  
475-295



475-295

PC black / serrated / 6 1/2" (16.5 cm)  
1200-808



1200-805

PC black / serrated  
1200-805 6 1/4" (15.9 cm)  
1200-810 6 1/4" (15.9 cm) heavy



1200-810

PC gold / serrated / heavy / 6 3/4" (17 cm)  
1200-310

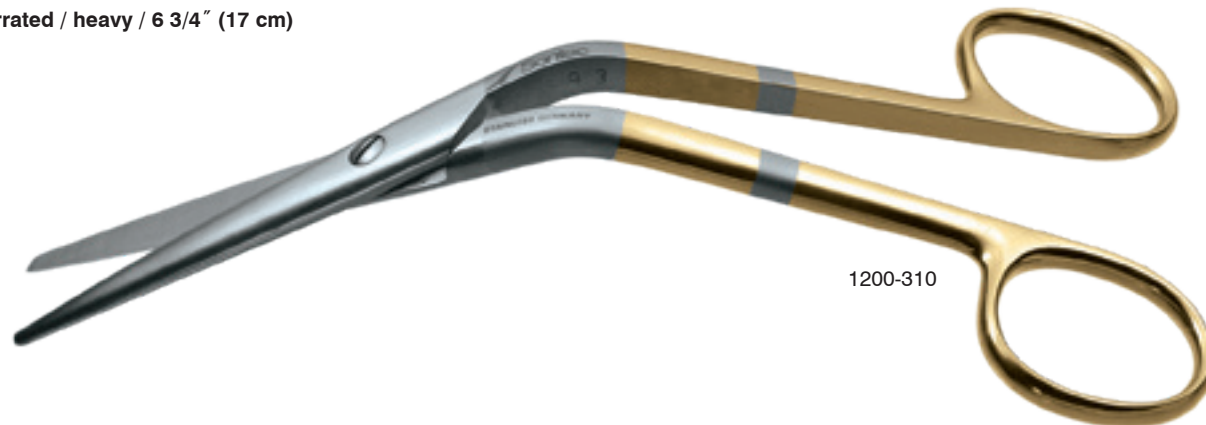

1200-310

**Cottle-Dorsal Scissors**

PC black / rounded Stille blades /  
serrated / blunt / 5 1/2" (14 cm)  
1200-806



1200-806

**Foman-Dorsal Scissors**

PC gold / serrated / 5 3/4" (14 cm)  
1200-300 beveled blades

PC black / serrated / 5 1/2" (14 cm)  
1200-800 beveled blades

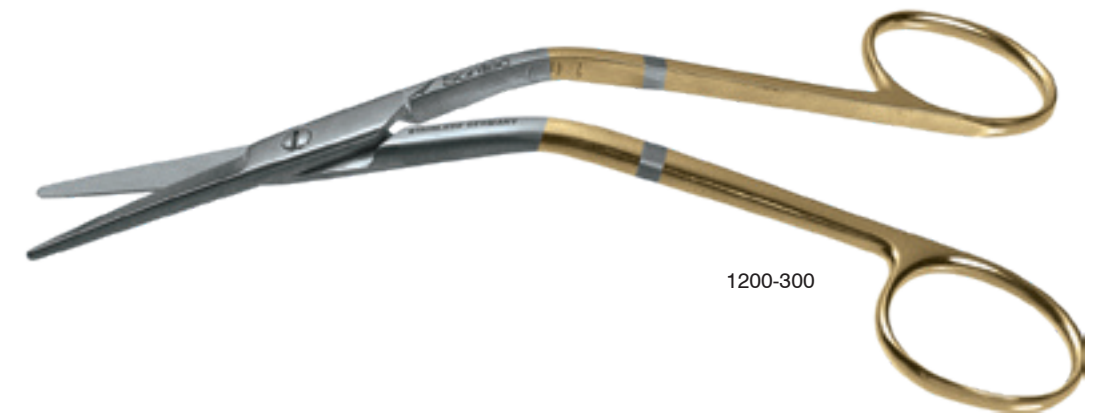

1200-300

**Foman-Dorsal Scissors**

PC black / 5 3/4" (14.6 cm)  
1200-812



**Heymann Nasal Scissors**

PC black / light / 7" (18 cm)  
475-301



**Gorney Septal Scissors**

Serrated blades / 7 3/4" (19.5 cm)  
475-310

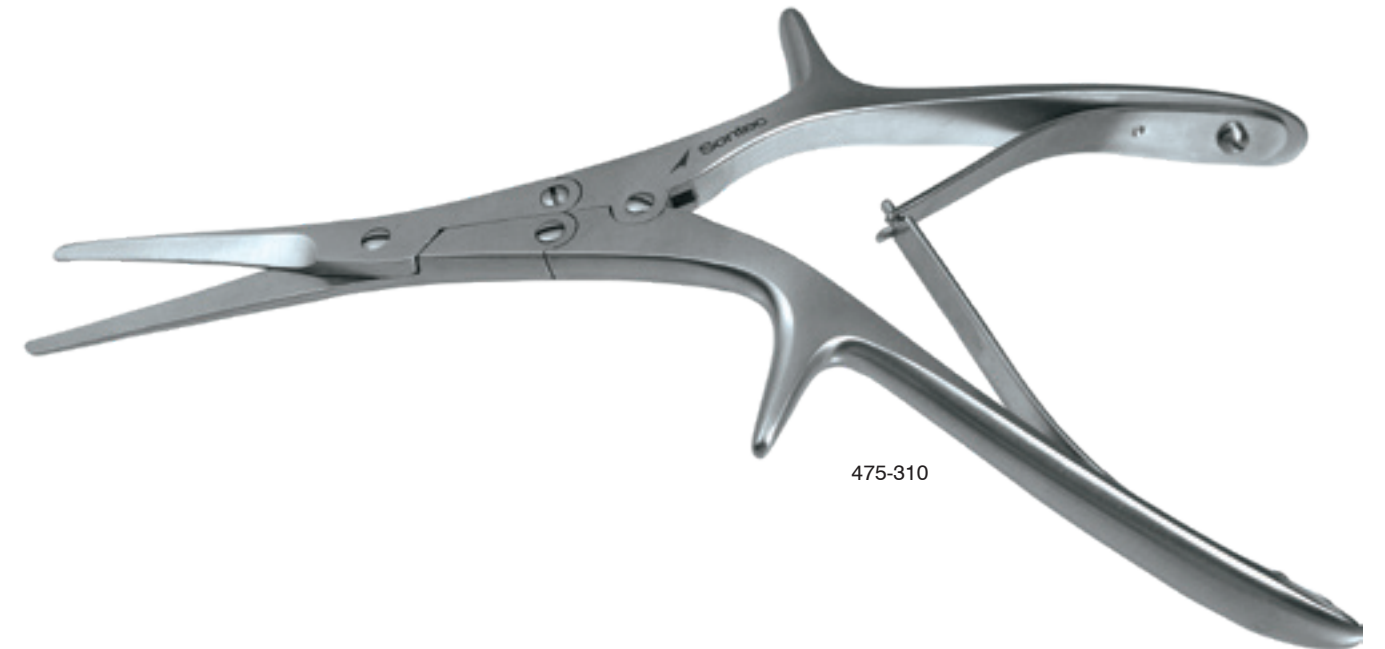

**Becker Septum Scissors**

Serrated blades / double action / 7" (18 cm)  
475-320

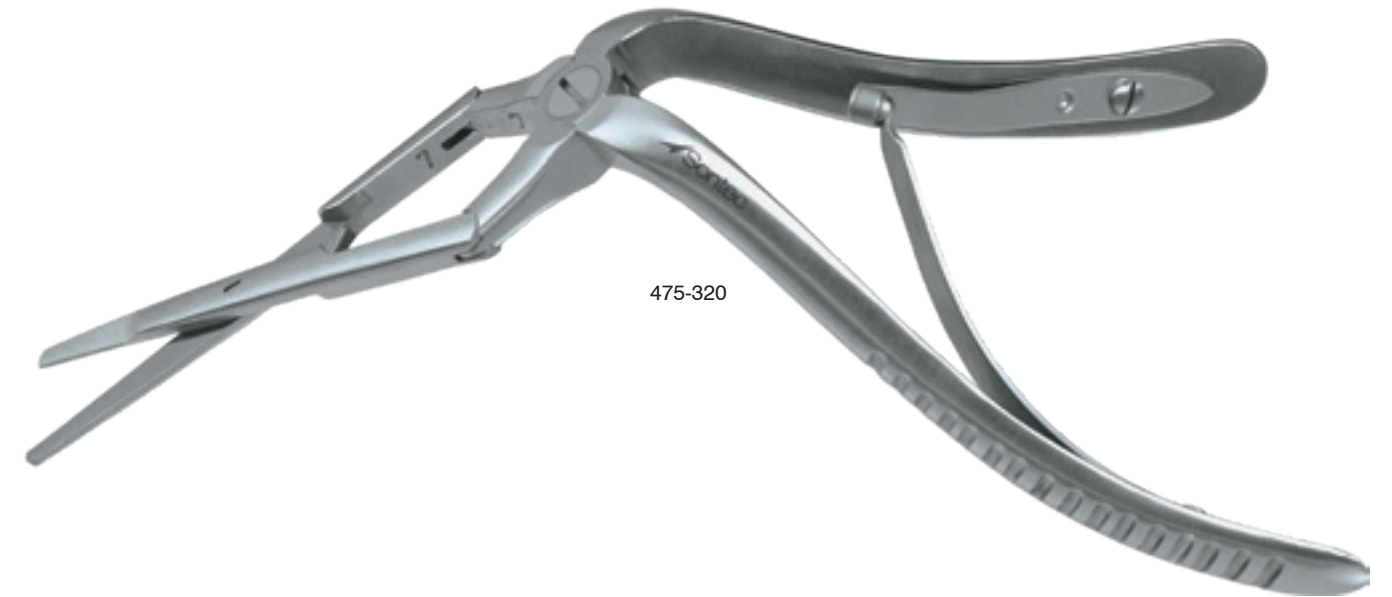

**Caplan Nasal Bone Scissors**

Serrated blades / 8 3/4" (22 cm)  
475-325



475-325

**Nasal Scissors**

13 mm blunt blades / 6 1/4" (16 cm) shaft  
468-104



468-104

**Nasal Scissors**

Serrated / 5" working length  
468-090 straight  
468-092 left  
468-094 right



468-090

468-092

**Sontec Nasal Scissors**

Double-action / angled to side / 8" (20 cm)  
475-330



475-330

**Mayo-Carroll Scissors**

Extra heavy design / TC / 9" (23 cm)

- 1100-276 straight
- 1100-282 curved



1100-282

**Double Action Micro Scissors**

Titanium/ stainless / round handle / 7 1/4" (18.5 cm)

- 2600-914 straight
- 2600-916 curved



2600-916

**Sontec Double Action Micro Scissors**

Double action / round handle / 7 1/4" (18.5 cm)

- 2400-545 straight
- 2400-547 curved



2400-545

**Sontec Heifetz Micro Scissors**

Double action / round handle / 6" (15 cm)

- 2400-542 straight
- 2400-544 curved

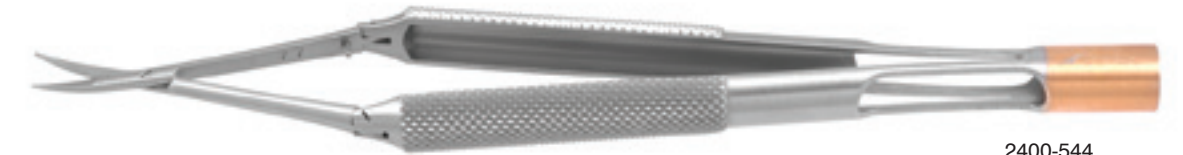

2400-544

**Mayo-Harrington Scissors**

Classic beveled blades / straight / 8" (20 cm)

- 2400-214 TC
- 2400-208 PC gold
- 2400-920 PC black



2400-211

Classic beveled blades / curved / 8" (20 cm)

- 2400-215 TC
- 2400-209 PC gold
- 2400-922 PC black

Classic beveled blades / straight / 9" (23 cm)

- 2400-216 TC
- 2400-210 PC gold
- 2400-924 PC black

Classic beveled blades / curved / 9" (23 cm)

- 2400-217 TC
- 2400-211 PC gold
- 2400-926 PC black



2400-214

Classic beveled blades / curved / 11" (30 cm)

- 2400-218 TC
- 2400-213 PC gold
- 2400-928 PC black

Classic beveled blades / curved / PC Gold / 12" (30.5 cm)

- 1200-259

Classic beveled blades / curved / TC / 16" (40.5 cm)

- 2400-212

**Jacobson Micro Scissors**

Round handle / sharp blades / 14 mm / 4 1/4" (10.75 cm)

- 2400-626 25°
- 2400-627 45°
- 2400-629 60°
- 2400-631 90°
- 2400-633 125° g-neck



14 mm tip

Round handle / sharp blades / 11 mm / 4 1/4" (10.75 cm)

- 2400-6261 25°
- 2400-6271 45°
- 2400-6291 60°
- 2400-6311 90°
- 2400-6331 125° g-neck



11 mm tip

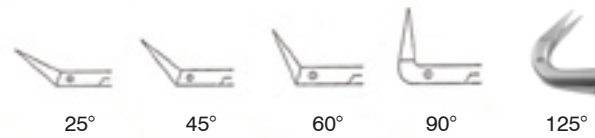

25°

45°

60°

90°

125°

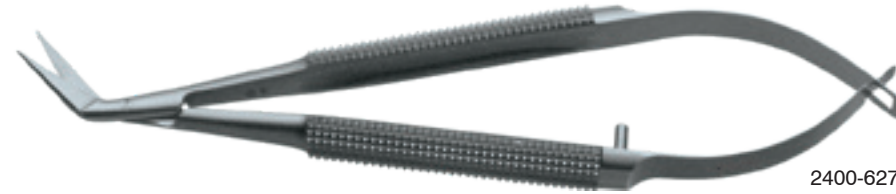

2400-627



2400-6261

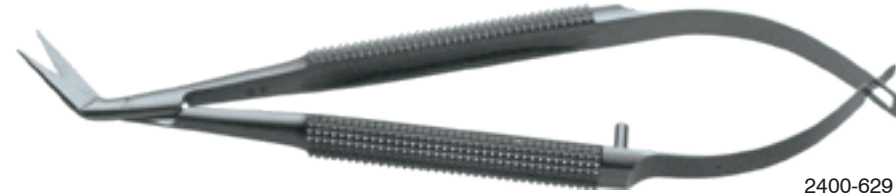

2400-629

**Westcott Stitch Scissors**

Sharp tips / classic blades / 4 1/2" (11.5 cm)

- 13-4400 curved
- 13-4402 straight



13-4400



13-4402

**Westcott Wide Handle Tenotomy Scissors**

Wide handle / curved / classic blades / 5 1/2" (14 cm)

- 13-3307 sharp
- 13-3306 blunt
- 13-3307S blunt serrated blades



13-3306



13-3307

**Westcott Tenotomy Scissors**

Blunt / 4 1/2" (11.5 cm)

- 13-3400 curved
- 13-3401 straight

Blunt / standard blade / heavier / curved / 5" (12.7 cm)

- 13-3402 curved



13-3400



13-3401



13-3402

MICRO SERRATIONS ON ANY SCISSOR WITH REASONABLE SIZE, PLEASE INQUIRE

**Titanium Westcott Tenotomy Scissors**

Blunt tip / fenestrated handle / 4 1/2" (11.5 cm)

- T13-3417 curved
- T13-3418 straight



T13-3417

**Stevens Tenotomy Classic PC Gold Scissors**

Pointed sharp tips / short blades / classic / 4 1/8" (10.5 cm)

- 13-8805 straight
- 13-8815 curved

Pointed sharp tips / long blades / classic / 4 1/2" (11.5 cm)

- 13-8820 straight
- 13-8825 curved



13-8825

Pointed sharp tips / long blades / PC Gold / 4 1/2" (11.5 cm)

- 13-8865 straight
- 13-8866 curved

**Stevens Tenotomy Ergonomic Spread Handle Power Cut Black® Scissors**

Blunt / long tip / PC black / ergonomic spread handle / curved / 4 1/2" (11.5 cm)

1200-708

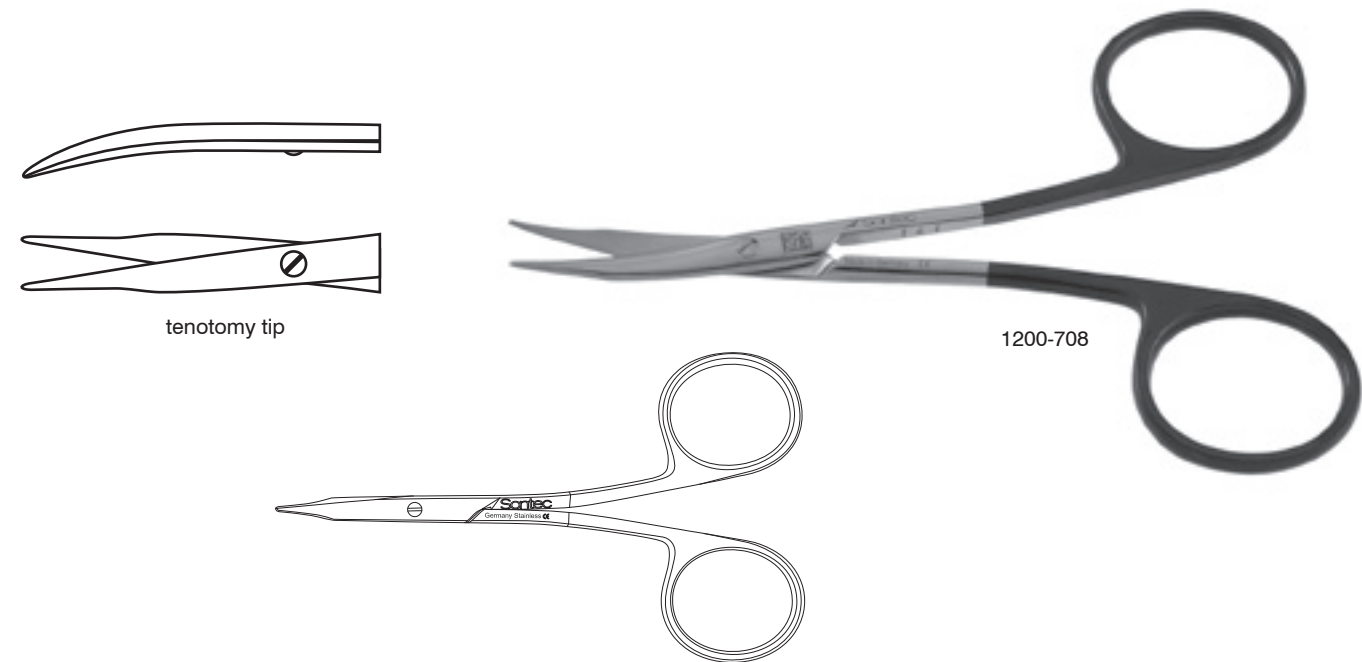

1200-708

tenotomy tip

**Stevens Tenotomy Ergonomic Spread Handle Tungsten Carbide Power Cut Black/Gold® Scissors**

Blunt / long tip / tungsten carbide / PC black/gold / ergonomic spread handle / curved / 4 1/2" (11.5 cm)

1200-497

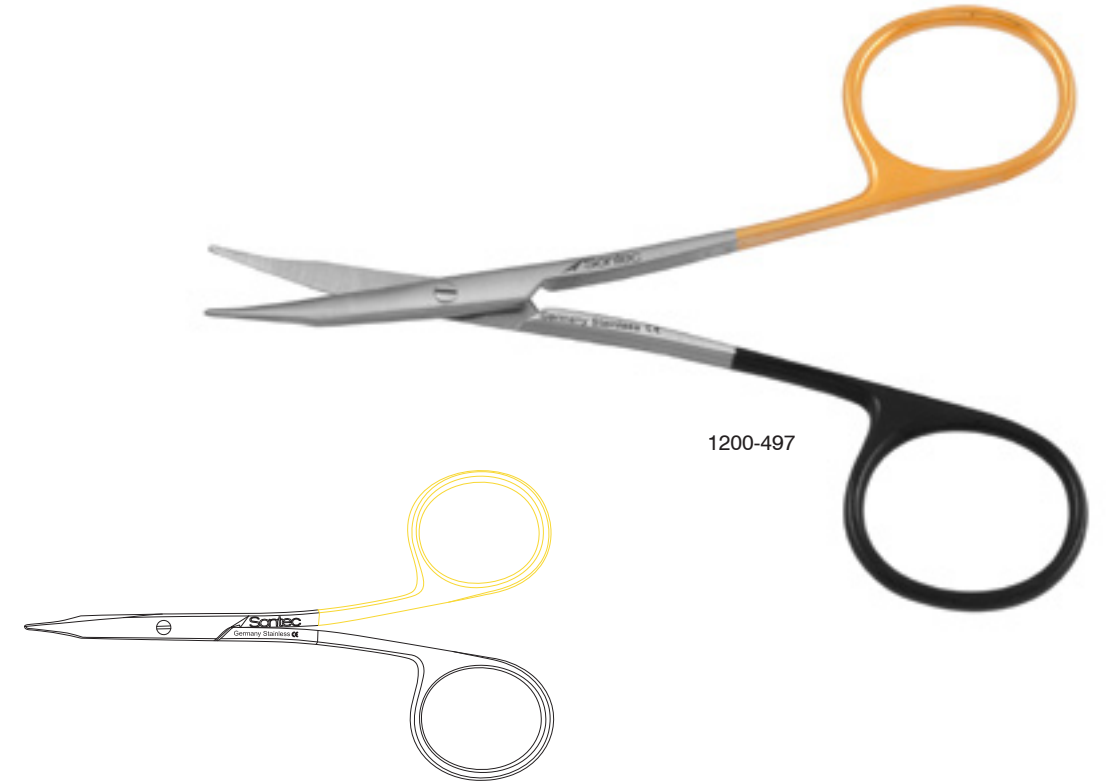

1200-497

**Stevens Tenotomy , Tungsten Carbide, Power Cut Gold, Power Cut Black®, Ceramic Coated Scissors**

Blunt / long blades / with TC/PC curved blades / ceramitec / with gold screw and gold shiny rings / spread handle / 4 1/2" (11 cm)

1200-937



1200-937

**Ceramitec Stevens Tenotomy Ergonomic Spread Handle Power Cut Black® Scissors**

Black with gold screw / blunt / long tip / PC Black / ergonomic spread handle / curved / 4 1/2" (11.5 cm)

1200-935



1200-935

**Stevens Siegert Tenotomy Scissors Double Beveled Blades**

Saberback / black ceramitec coated / with gold screw / blunt long blades / curved / 4 1/2" (11.5 cm)

1200-985 black ceramitec  
1200-986

Double beveled blades / TCPC / 4 1/2" (11.5 cm)

2400-365 straight  
2400-367 curved pointed tips



1200-985

1200-986

2400-367

**Stevens Tenotomy Classic, Tungsten Carbide, Power Cut Gold, Power Cut Black®, Ceramitec Scissors**

**Blunt / long blades / straight / 4 1/2" (11.5 cm)**

- 13-8813 classic
- 1200-062 PC gold
- 1200-704 PC black

**Blunt / long blades / curved / 4 1/2" (11.5 cm)**

- 13-8814 classic
- 1200-064 PC gold
- 1200-706 PC black
- 1200-499 TCPC



1200-064

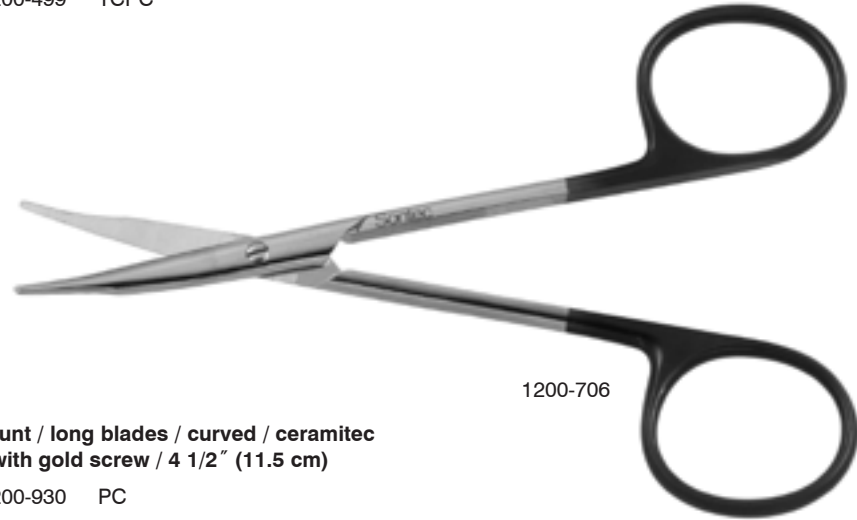

1200-706

**Blunt / long blades / curved / ceramitec / with gold screw / 4 1/2" (11.5 cm)**

- 1200-930 PC



1200-499

**Pointed sharp blades / long blades / 4 1/2" (11.5 cm)**

- 1200-490 TC/PC straight

**Pointed sharp blades / long blades / curved / 4 1/2" (11.5 cm)**

- 1200-491 TC/PC curved



1200-490

1200-491

MICRO SERRATIONS ON ANY SCISSOR WITH REASONABLE SIZE, PLEASE INQUIRE

**Strabismus Classic Tungsten Carbide Power Cut Gold® Power Cut Black® Scissors**

**Delicate / PC gold / 4 1/4" (11 cm)**

- 1200-021 straight
- 1200-023 curved

**Classic / 4 1/2" (11.5 cm)**

- 1100-344 straight
- 1100-346 curved

**PC gold / 4 1/2" (11.5 cm)**

- 1200-020 straight
- 1200-022 curved

**PC black / 4 1/2" (11.5 cm)**

- 1200-775 straight
- 1200-776 curved

**PC black / sharp/sharp tips / curved / 4 1/2" (11.5 cm)**

- 1200-776S

**TC / 4 1/2" (11.5 cm)**

- 2400-360 straight
- 2400-362 curved



1200-020



1200-776S

**Ribbon-Handle Classic Iris Scissors**

**Classic blades / 4" (10 cm)**

- 13-7600 straight
- 13-7610 curved

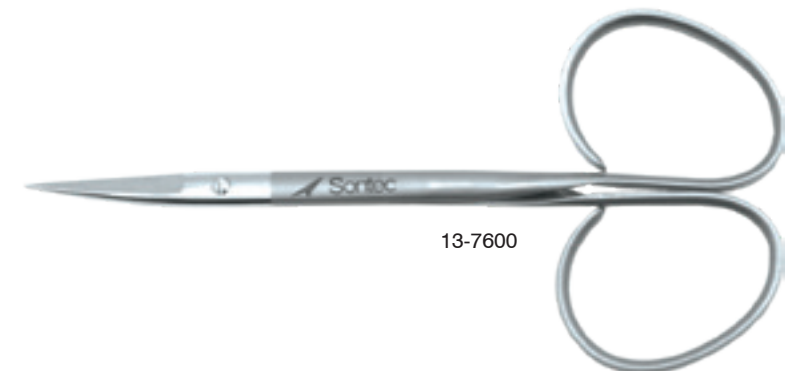

13-7600

**Iris Classic Tungsten Carbide Power Cut Gold®  
Power Cut Black® TC/PC Scissors**

**Delicate / mini model / 3 1/2" (9 cm)**

13-7500 straight  
13-7510 curved

**Ribbon handle / mini pattern / classic / 14 mm blades / 3 3/4" (9.5 cm)**

13-7720 straight  
13-7730 curved

**PC gold / sharp tips / 4" (10 cm)**

2400-010 straight  
2400-012 curved

**PC gold / blunt / 4" (10 cm)**

2400-015 straight  
2400-017 curved

**PC black / sharp tips / 4" (10 cm)**

2400-710 straight  
2400-712 curved

**Classic / 4 1/8" (10.2 cm)**

13-7528 straight  
13-7530 curved

**Classic / delicate / 4 1/8" (10.2 cm)**

13-7524 straight  
13-7526 curved

**PC gold / 4 1/8" (10.2 cm)**

13-7532 straight  
13-7533 curved

**PC gold / delicate / 4 1/8" (10.2 cm)**

13-7520 straight  
13-7522 curved



**Iris Scissors**

**Classic / 4 1/2" (11.5 cm)**

13-7700 straight  
13-7710 curved  
13-7620 curved sideways  
13-7715 angled sideways

**PC gold / 4 1/2" (11.5 cm)**

1200-025 angled sideways  
1200-026 straight  
1200-028 curved

**PC black / sharp tips / 4 1/2" (11.4 cm)**

2400-711 straight  
2400-713 curved

**PC black / blunt / 4" (10 cm)**

2400-715 straight  
2400-717 curved

**TC / 4 1/2" (11.5 cm)**

112-480 straight  
112-478 curved

**TC/PC / 4 1/2" (11.5 cm)**

1200-502 straight  
1200-503 curved

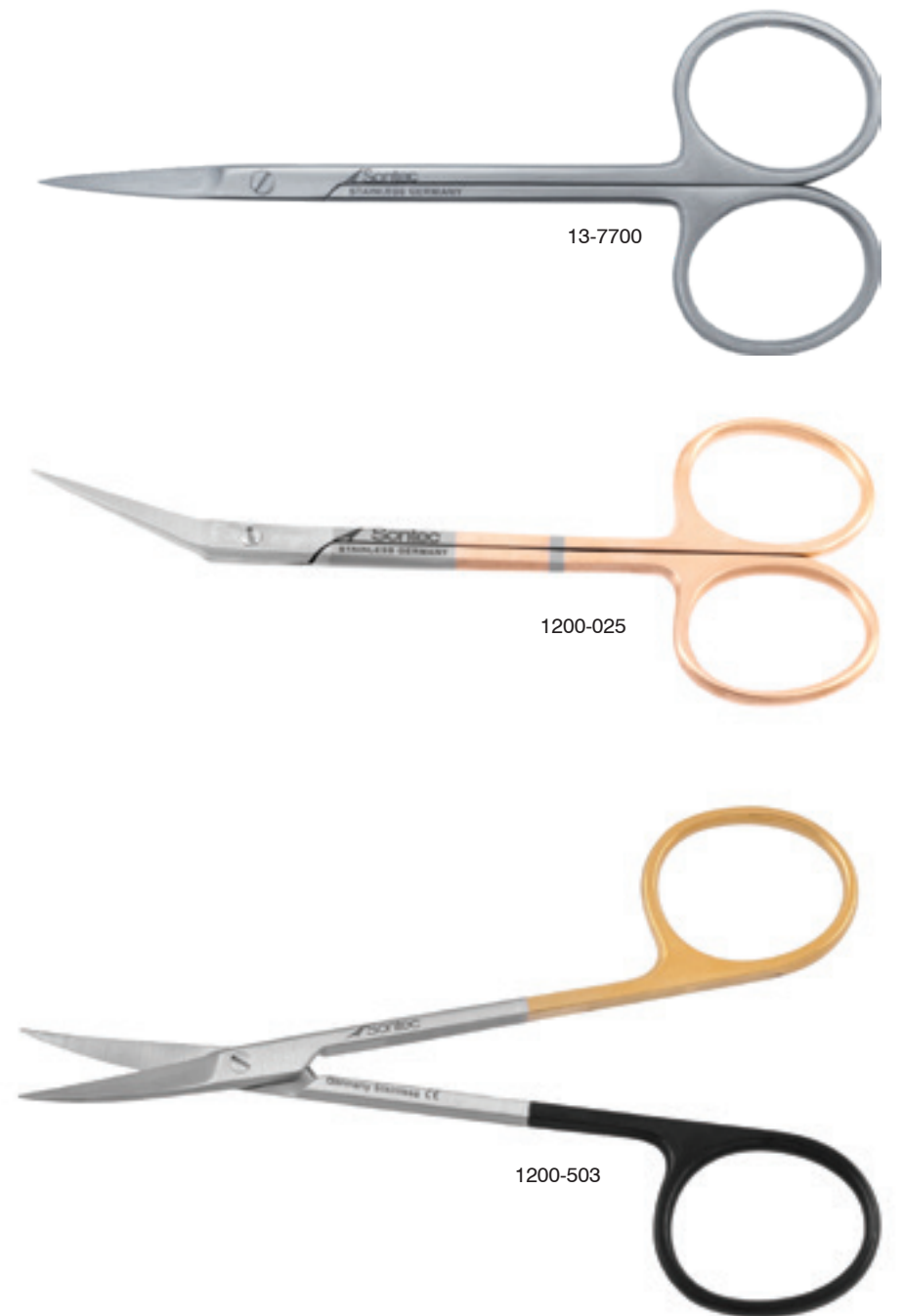

**Iris Stille Classic Large Cut Out Rings Scissors**

Curved / 4" (10.2 cm)  
13-7786



13-7786

**Iris Stille Classic Large Rings Scissors**

Large ring / Classic / 4" (10 cm)  
13-7740 straight  
13-7750 curved

Large ring / PC black / 4" (10 cm)  
1200-764 straight  
1200-766 curved

Large ring / PC gold / 4" (10 cm)  
1200-011 straight  
1200-011C curved



1200-766



1200-764

**Enucleation Scissors**

PC Gold / 5 1/4" (13 cm)  
13-9805 light curve  
13-9810 medium curve  
13-9820 full curve  
13-9822 full curve PC Black



13-9820



13-9822



light curve



medium curve



full curve

**Baby Stratte Scissors**

PC Gold / full s-curved / 5 1/2" (14 cm)  
508-616 metzenbaum tip  
508-618 tenotomy tip

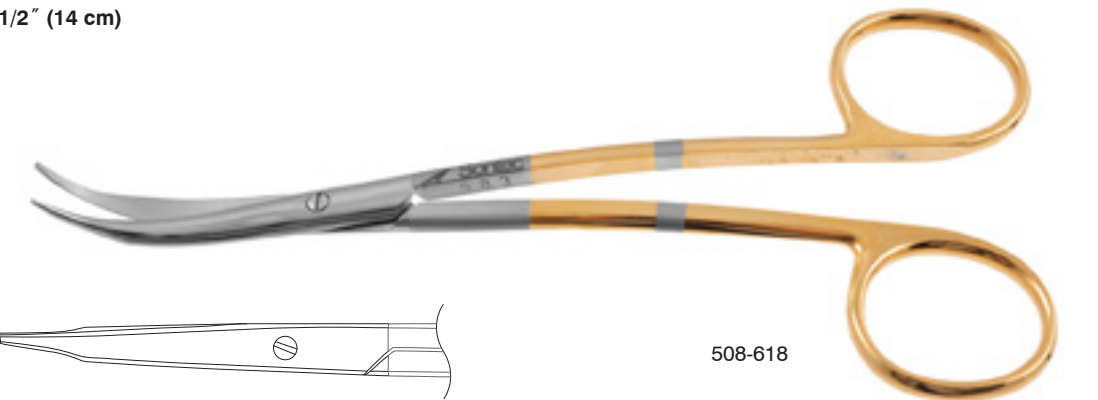

508-618

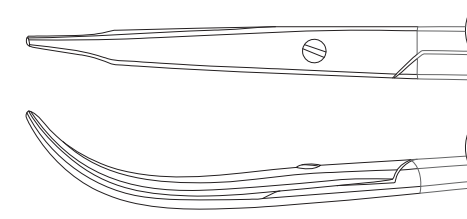



 Sontec Instruments®  
Needle Holders

**Gregory Needle Holder**

TC dust / straight / double action / round handle with lock / suggested suture size 7.0 and smaller

- 2300-048 7" (17.8 cm)
- 2300-0481 7" (17.8 cm) TC serrated
- 2600-730 7" (17.8 cm) titanium
- 2300-049 8 1/4" (21 cm)



2300-048



2300-0481



2600-730



2300-049

**Sontec Extra Micro Needle Holder**

Round handle / TC dust / extra delicate jaws / specially serrated grip on shanks / 6" (15 cm) / suggested suture size 8-0 and smaller

- 400-254 str w/lock
- 400-256 cvd w/lock
- 400-250 str w/o lock
- 400-252 cvd w/o lock



400-254

**Castroviejo Needle Holder**

Round handle / TC dust / with lock / suggested suture size 7-0 and smaller

- 2300-020 str 4 3/4" (12 cm)
- 2300-024 cvd 4 3/4" (12 cm)
- 2300-030 str 5 3/4" (14.5 cm)
- 2300-034 cvd 5 3/4" (14.5 cm)
- 2300-038 str 6" (15 cm)

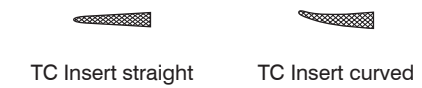

TC Insert straight

TC Insert curved



2300-030

Round handle / with out lock / TC dust

- 2300-022 str 4 3/4" (12 cm)
- 2300-026 cvd 4 3/4" (12 cm)
- 2300-032 str 5 3/4" (14.5 cm)
- 2300-036 cvd 5 3/4" (14.5 cm)



2300-042

Round handle / TC insert / with lock

- 2300-040 str 6" (15 cm)
- 2300-042 cvd 6" (15 cm)



2300-040S

Round handle / streamlined / TC serrated / with lock

- 2300-040S str 6" (15 cm)
- 2300-042S cvd 6" (15 cm)



2300-042S

**Jacobson Super Middle Weight Needle Holder Titanium**

Mid-weight / with lock / TC dust / 8 1/2" (21.6 cm) / suggested suture size 5-0 and smaller

2600-712	standard box lock	
2600-713	streamlined	
2600-704M	standard box lock	extended knurling



standard



streamlined

Streamlined needle holders feature a smooth (streamlined) box-lock that does not snag suture when tying.



2600-712



2600-713



2600-704M

**Jacobson Super Middle Weight Needle Holder**

Mid-weight / with lock / TC serrated / straight / 1.8 mm jaw / suggested suture size 5-0 and smaller

2300-135M	7 1/4"
2300-143M	8 1/4"
2300-151M	9 1/8"



Mid-weight / with lock / TC dust / straight / suggested suture size 5-0 and smaller

2300-134M



2300-143M



2300-134M

**Double-Action SS Needle Holder**

Stainless / TC dust / round handle / 7 1/4" (18.5 cm) / suggested suture size 5-0 and smaller

1103-888	straight	
1103-887	straight	universal lock
1103-888C	curved	
1103-887C	curved	universal lock

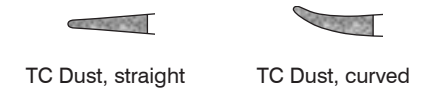

TC Dust, straight

TC Dust, curved



1103-887C

1103-887

**Barraquer Reverse Needle Holder**

TC dust / round handle / with lock / inverted spring / suggested suture size 5-0 and smaller

2300-047	4 3/4" (12.1 cm)
2300-046	7" (17.8 cm)



2300-047

**Glasser Micro Needle Holder**

TC dust / round handle / with lock / inverted spring / suggested suture size 5-0 and smaller/ 4 7/8" (12 cm)

- 2300-0496 straight
- 2300-0497 curved



2300-0496

TC dust / round handle / with lock / inverted spring / suggested suture size 5-0 and smaller/ 7" (17.8 cm)

- 2300-0498 straight
- 2300-0499 curved



2300-0499

**Castroviejo Needle Holder**

Delicate jaw / 5 1/2"

- 15-1800 straight w/o lock
- 15-1810 curved w/o lock
- 15-1820 straight w/ lock
- 15-1830 curved w/ lock



15-1830

Standard jaw / 5 1/2"

- 15-1860 straight w/ lock
- 15-1880 curved w/ lock
- 15-1861 straight w/o lock
- 15-1881 curved w/o lock



15-1861

Delicate jaw / titanium / 5 1/2"

- T15-1800 straight w/o lock
- T15-1810 curved w/o lock
- T15-1820 straight w/lock
- T15-1830 curved w/lock

Standard jaw / titanium / 5 1/2"

- T15-1860 straight w/lock
- T15-1880 curved w/lock
- T15-1861 straight w/o lock
- T15-1881 curved w/o lock

**Jacobson Micro Bayonet Needle Holder**

Round handle / with lock / 8 1/4" (21 cm)

- 400-228 TC insert str
- 400-229 TC insert cvd
- 400-230 TC dust str
- 400-231 TC dust cvd

Round handle / with lock / 9" (23 cm)

- 400-232 TC insert str
- 400-233 TC insert cvd
- 400-234 TC dust str
- 400-235 TC dust cvd

Round handle / TC dust / with lock / 9" (23 cm)

- 2300-258 micro tip str

Flat handle / with lock / TC dust / 8 1/2" (22 cm)

- 400-226 extra micro
- 400-227



2300-258



400-226



400-227



400-229

**McPherson Needle Holder**

**Very delicate jaw / suggested suture size 8.0 and smaller**

15-1310	straight	without lock	stainless	4"
15-1330	curved	without lock	stainless	4"
15-1300	straight	with lock	stainless	4"
15-1320	curved	with lock	stainless	4"
T15-1320	curved	with lock	titanium	4 1/8"
T15-1330	curved	without lock	titanium	4 1/8"
T15-1320R	curved	with lock	titanium	4 3/8"
T15-1330R	curved	without lock	titanium	4 3/8"

**Extra delicate jaw / fenestrated handle / with lock**

15-1300F	str	4 1/4"
15-1320F	cvd	4 1/4"



15-1300



15-1320



T15-1320R



T15-1330



T15-1330R



15-1320F

**Castroviejo Needle Holder**

**Flat handle / TC dust / 5 3/4" (14.5 cm) / suggested suture size 7-0 and smaller**

15-1916	str	w/o lock	
15-1917	cvd	w/o lock	
15-1912	str	w/lock	
15-1913	cvd	w/lock	
15-1914	str	w/lock	delicate
15-1915	cvd	w/lock	delicate

**Flat handle / TC dust / 5 3/4" (14.5 cm) / suggested suture size 7-0 and smaller / titanium**

T15-1916	str	w/o lock	
T15-1917	cvd	w/o lock	
T15-1912	str	w/lock	
T15-1913	cvd	w/lock	
T15-1914	str	w/lock	delicate
T15-1915	cvd	w/lock	delicate

**Flat handle / TC insert / 5 3/4" (14.5 cm) / suggested suture size 7-0 and smaller**

15-1900	str	w/ lock	
15-1910	cvd	w/ lock	
15-1901	str	w/o lock	
15-1911	cvd	w/o lock	



15-1912



15-1913



T15-1913



15-1900



15-1910



TC Smooth straight



TC Dust straight



TC Dust curved



TC Insert straight



TC Insert curved



TC Serrated

**Mathieu Heavy Needle Holder**

**Standard**

- 130-564 6 3/4" (17 cm) \*
- 130-565 8" (20 cm) \*

**Tungsten carbide serrated**

- 1100-094 6 3/4" (17 cm) \*
- 1100-098 8" (20 cm) \*
- 1100-096G 6 3/4" (17 cm) with finger grip

\* Also suitable as a wire twister

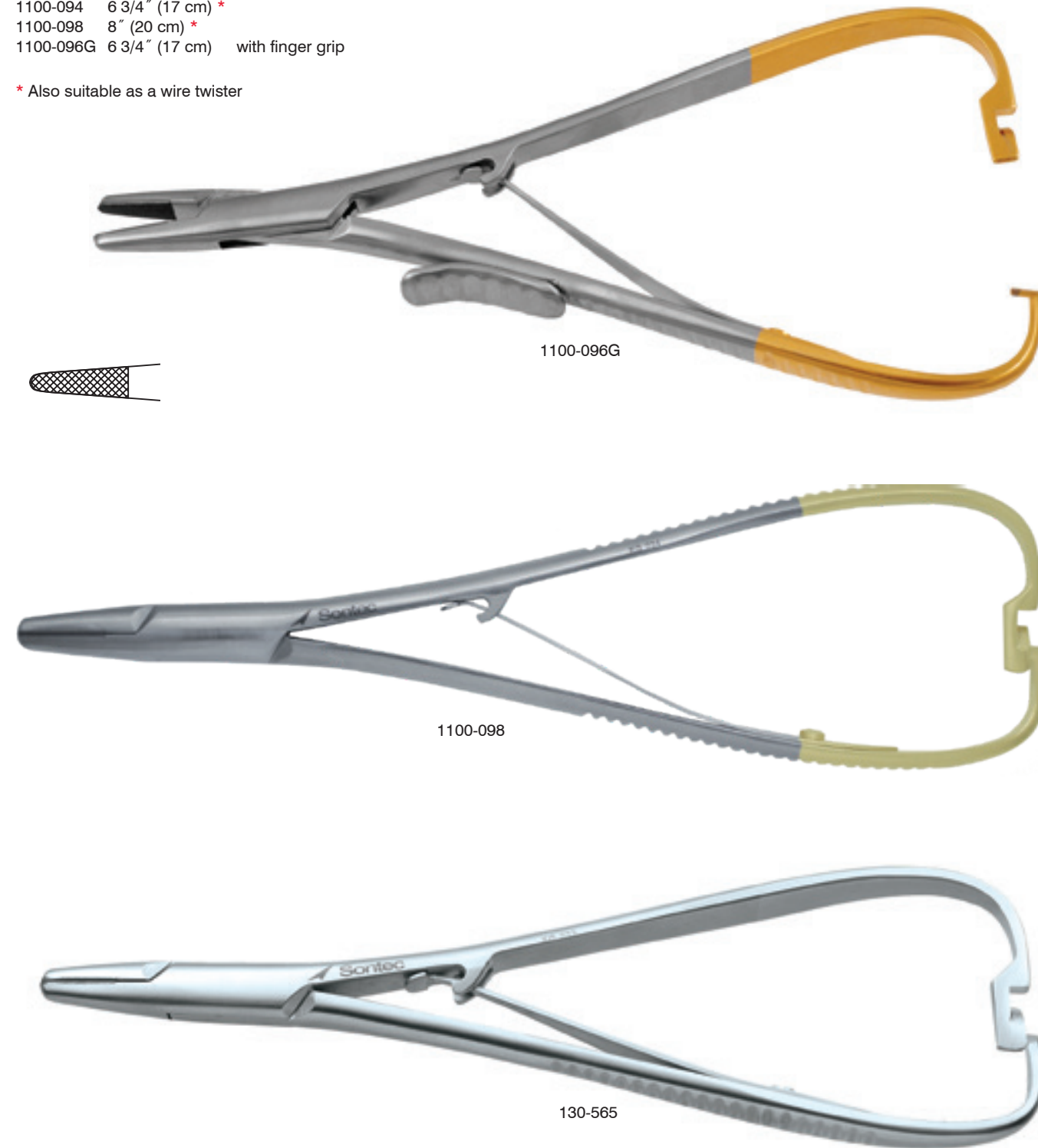

**Boynton Needle Holder**

**Delicate**

- 130-563 4 3/4" (12 cm) serrated without TC
- 132-450 4 3/4" (12 cm) TC serrated
- 132-452 6 1/4" (16 cm) TC serrated

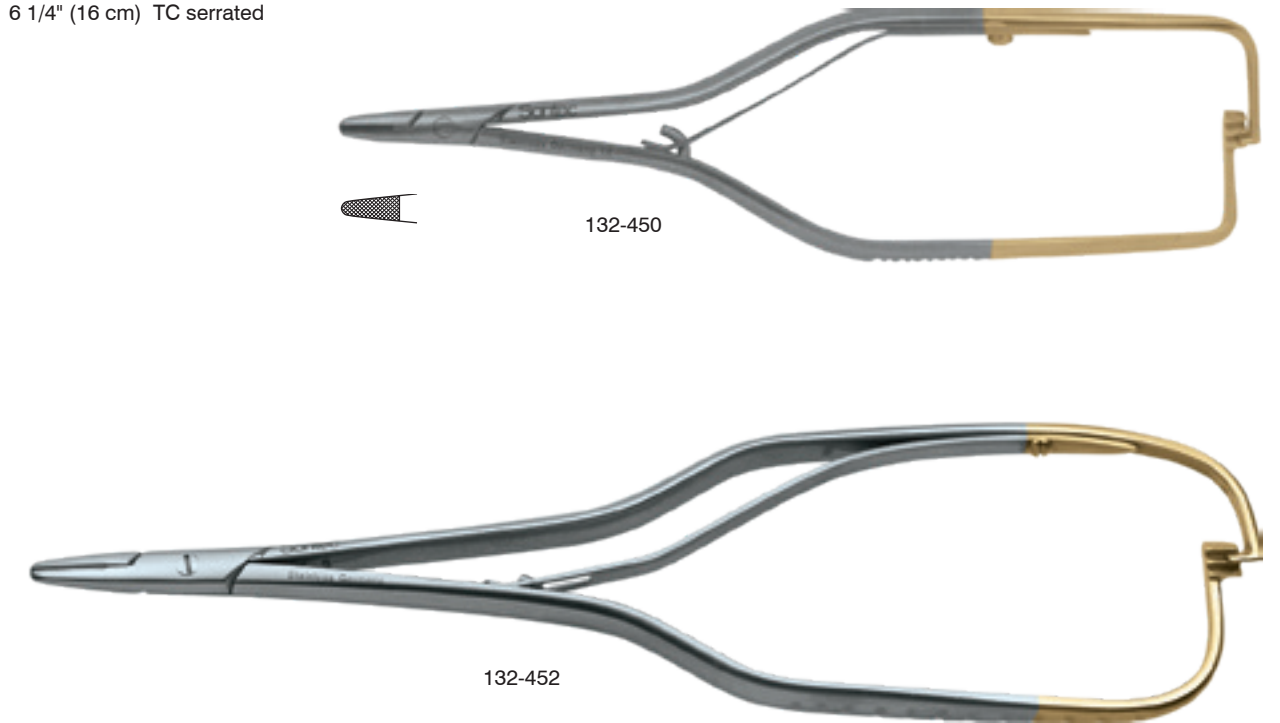

**Mathieu Needle Holder**

**Tungsten carbide / 6 1/2" (16.5 cm)**

- 1100-101 straight
- 1100-100 curved

**Tungsten carbide serrated**

- 1100-093 6 3/4" (17 cm) delicate
- 1100-091 8" (20.3 cm)
- 1100-090 9 1/2" (24 cm)



**Webster Needle Holder**

4 3/4" (12 cm)

- 1100-392 serrated w/out TC
- 2300-516 TC serrated
- 2300-518 TC smooth
- 2300-520 TC dust
- 2300-521 6" TC dust



**Webster Needle Holder Titanium**

TC Dust / 4 3/4" (12.1 cm)

2600-725



**Derf Needle Holder Titanium**

Mini / 4 1/4" (11 cm)

- 2600-714 TC dust
- 2600-716 TC serrated

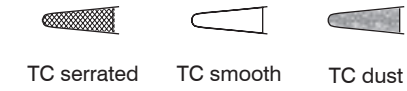

**Halsey Needle Holder**

5" (12.5 cm)

- 130-517 serrated without TC/standard
- 130-518 smooth without TC/standard
- 132-372 TC serrated
- 132-374 TC smooth
- 132-373 TC Dust

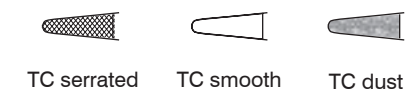

**Halsey Needle Holder Titanium**

5" (13 cm)

- 2600-720 TC Serrated
- 2600-722 TC Dust

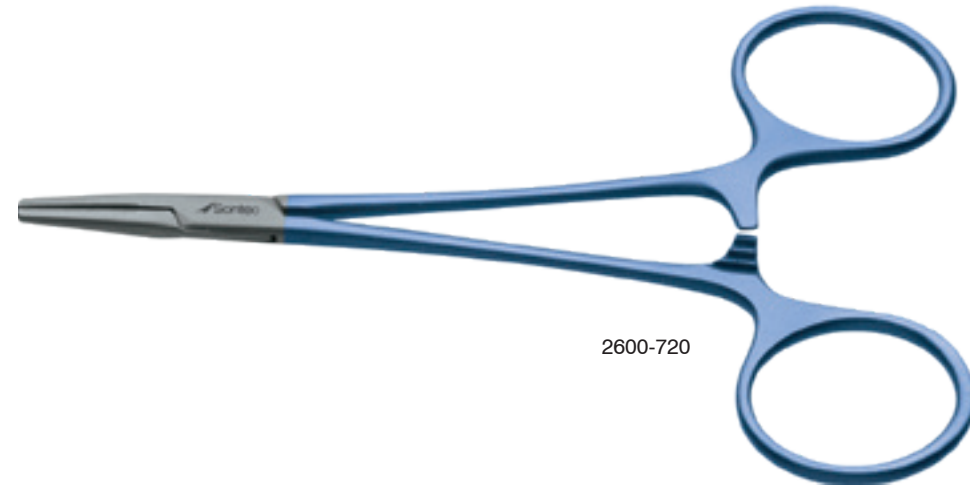

**Par Needle Holder**

TC serrated

- 132-367A 4 1/2" (11.5 cm)
- 132-367 5 1/4" (13 cm)



**Derf Needle Holder**

**Mini / 3 1/2" (9 cm)**

- 132-375 TC dust
- 132-376 TC serrated
- 132-376S TC smooth

**Mini / 4 1/4" (11 cm)**

- 132-632 TC serrated
- 132-634 smooth

**4 3/4" (12 cm)**

- 130-508
- 132-364 TC serrated
- 132-364L TC serrated left streamlined large rings
- 132-364S TC serrated
- 132-365 TC Dust

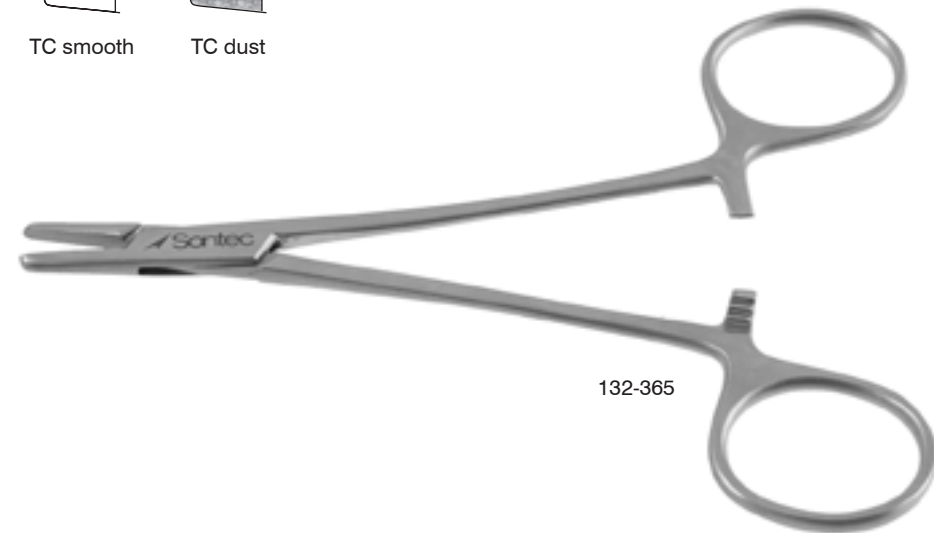
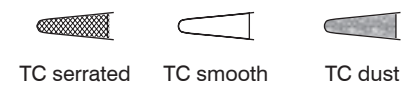

**Par Needle Holder Titanium**

**TC dust / 4 1/2" (11.4 cm)**

- 2600-728



**Neivert Needle Holder**

**TC serrated / offset rings / 5" (12.5 cm)**

- 132-380 single
- 132-380S double

**TC dust / 5" (12.5 cm)**

- 132-379 double
- 132-381 single

**TC smooth**

- 132-379S double
- 132-381S single

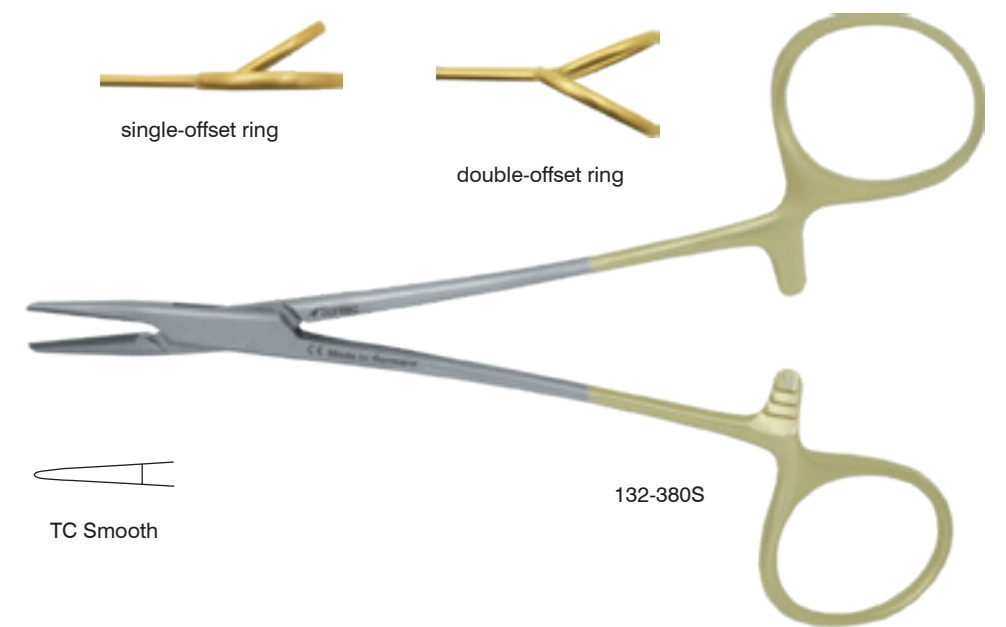
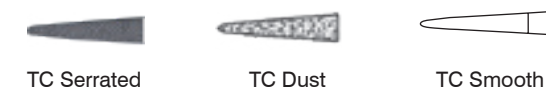
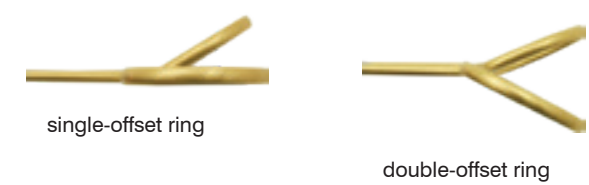

**Swedish Style Needle Holder**

**TC serrated / suggested suture size 5-0 and smaller**

- 2300-670 6" (15 cm)
- 2300-679 6" (15 cm) \*
- 2300-672 7" (18 cm)
- 2300-674 8" (20 cm)

**TC smooth / suggested suture size 5-0 and smaller**

- 2300-671 6" (15 cm)
- 2300-673 7" (18 cm)
- 2300-675 8" (20 cm)

\* Extra delicate

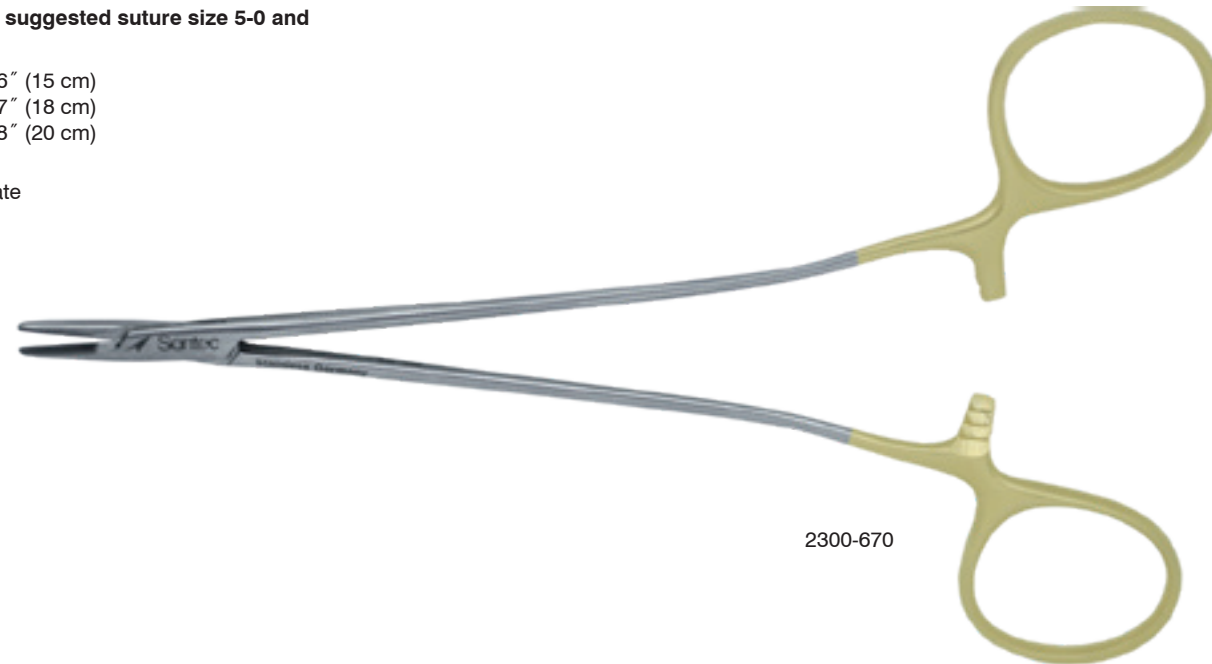

2300-670



TC Serrated      TC Serrated, extra delicate      TC Smooth

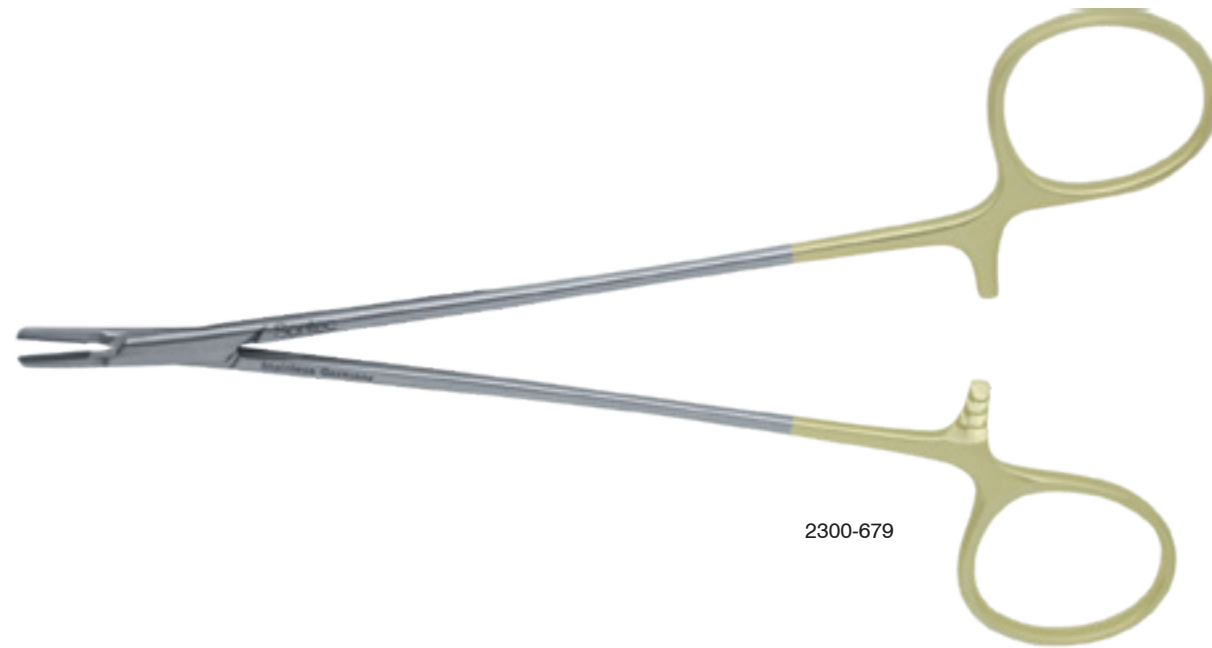

2300-679

**Ryder Delicate Needle Holder**

**1 mm jaw / TC serrated**

- |          |                |            |
|----------|----------------|------------|
| 2300-298 | 4 3/4" (12 cm) |            |
| 2300-300 | 5" (12.5 cm)   |            |
| 2300-301 | 5" (12.5 cm)   | 1.5 mm jaw |
| 1100-122 | 5" (12.5 cm)   | 2 mm jaw   |
| 2300-302 | 6" (15 cm)     |            |
| 2300-304 | 7" (18 cm)     |            |
| 2300-306 | 8" (20 cm)     |            |
| 2300-308 | 9" (23 cm)     |            |

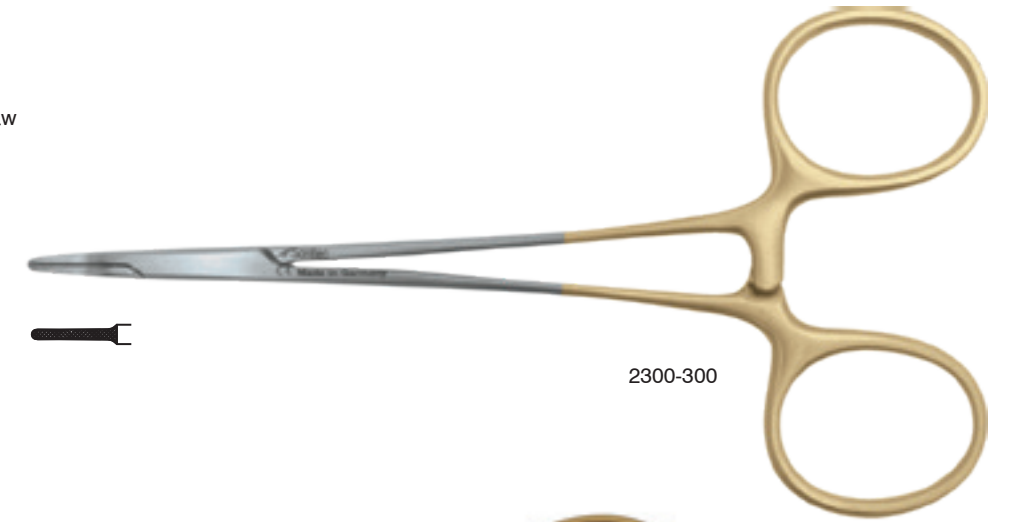

2300-300

**1 mm jaw / TC smooth**

- |           |                |
|-----------|----------------|
| 2300-298S | 4 3/4" (12 cm) |
| 2300-300S | 5" (12.5 cm)   |
| 2300-302S | 6" (15 cm)     |
| 2300-304S | 7" (18 cm)     |
| 2300-306S | 8" (20 cm)     |
| 2300-308S | 9" (23 cm)     |



2300-301

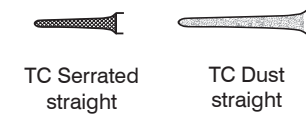

TC Serrated straight      TC Dust straight

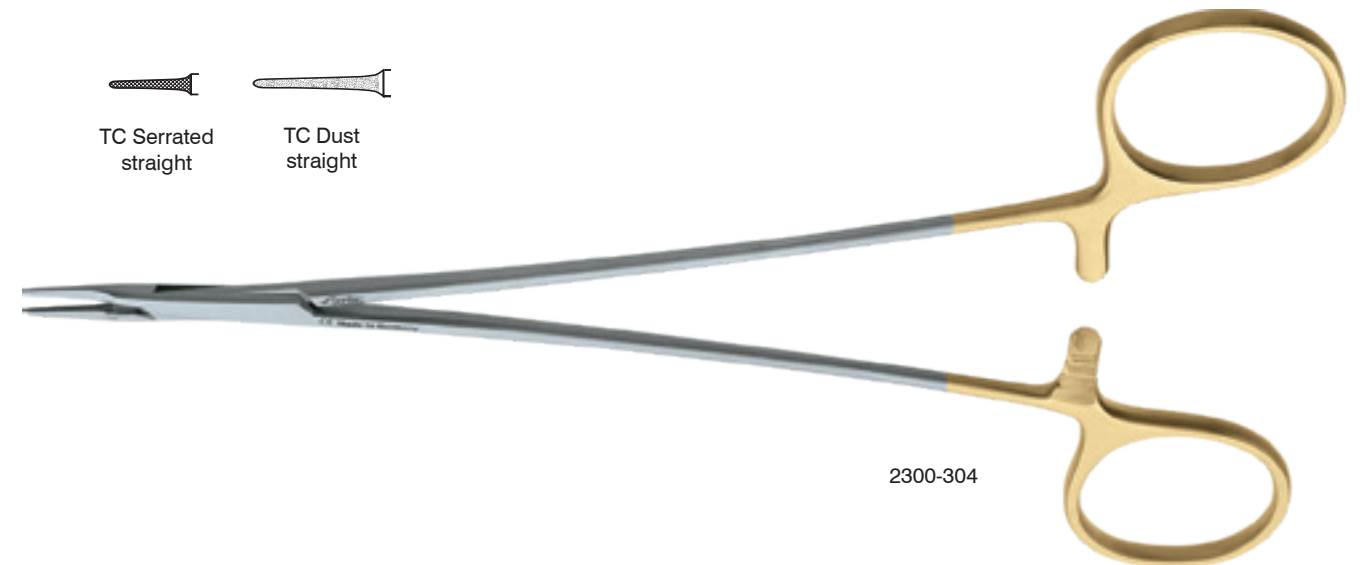

2300-304

**Microvascular Needle Holder**

TC dust / streamlined box lock / suggested suture size 5-0 and smaller

2300-350	str	5" (12.5 cm)
2300-352	cvd	5" (12.5 cm)
2300-354	str	5 3/4" (14.5 cm)
2300-356	cvd	5 3/4" (14.5 cm)
2300-358	str	6 1/4" (16 cm)
2300-360	cvd	6 1/4" (16 cm)
2300-362	str	7 1/4" (18.5 cm)
2300-366	str	7 1/4" (18.5 cm) *
2300-364	cvd	7 1/4" (18.5 cm)
2300-368	str	8 7/8" (22.8 cm)
2300-370	cvd	8 7/8" (22.8 cm)
2300-372	str	10" (25 cm)
2300-374	cvd	10" (25 cm)

\* Left handed

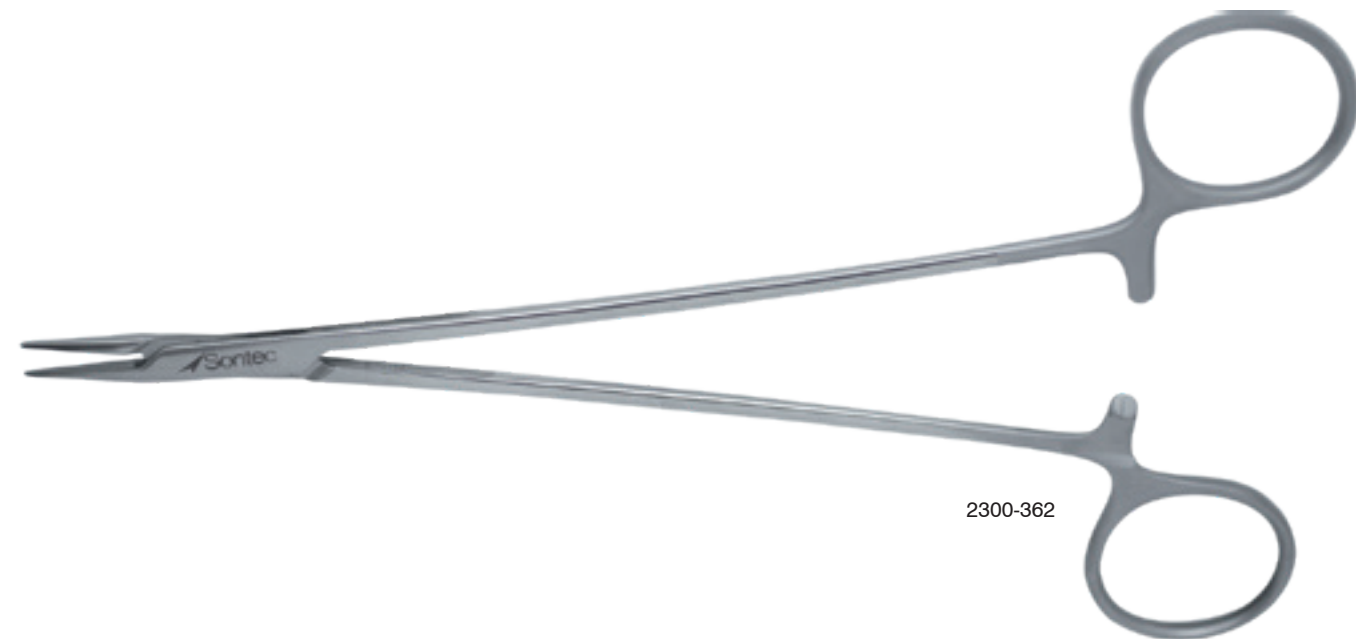
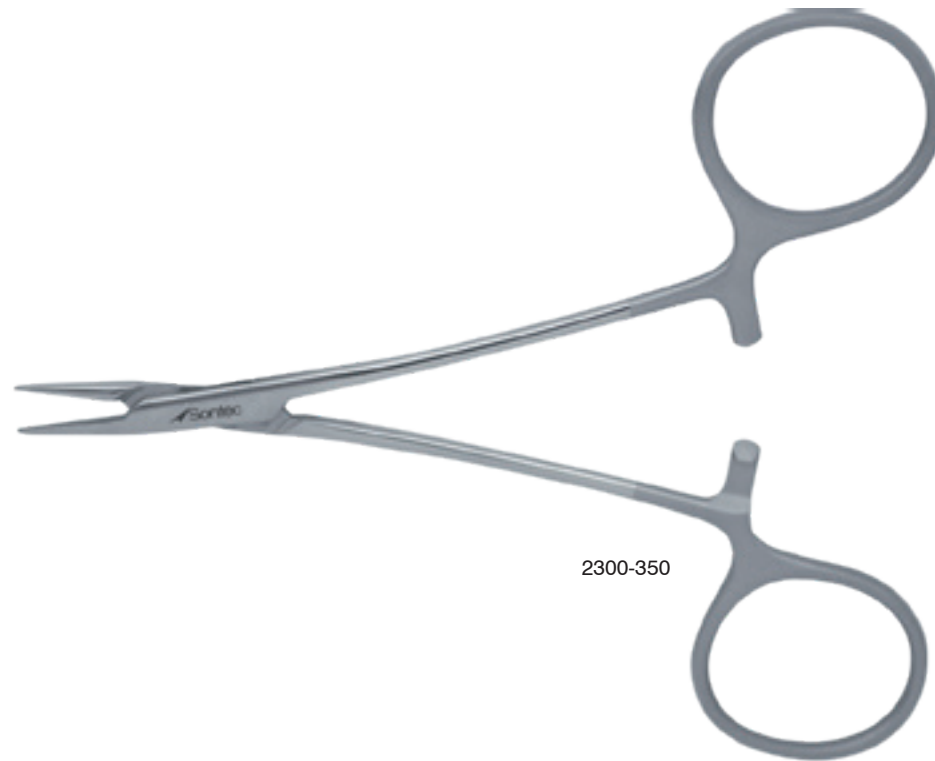
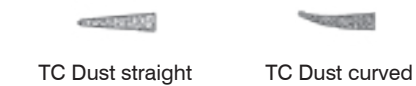

**Crile-Wood Needle Holder**

Serrated without TC

130-521	6" (15 cm)
130-523	7" (18 cm)
130-525	8" (20 cm)
130-526	9" (23 cm)

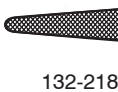

TC Serrated

132-388	str	6" (15 cm)
132-210	str	7" (18 cm)
132-223	cvd	7" (18 cm)
132-212	str	8" (20 cm)
132-225	cvd	8" (20 cm)
132-214	str	9" (23 cm)
132-224	cvd	9" (23 cm)
132-216	str	10" (25 cm)
132-218	str	12" (30 cm)



Streamlined box lock / TC serrated

2300-378	6" (15 cm)
2300-384S	7" (18 cm)
2300-388S	8" (20 cm)
2300-390S	9" (23 cm)
2300-394S	10" (25 cm)
2300-396S	12" (30 cm)

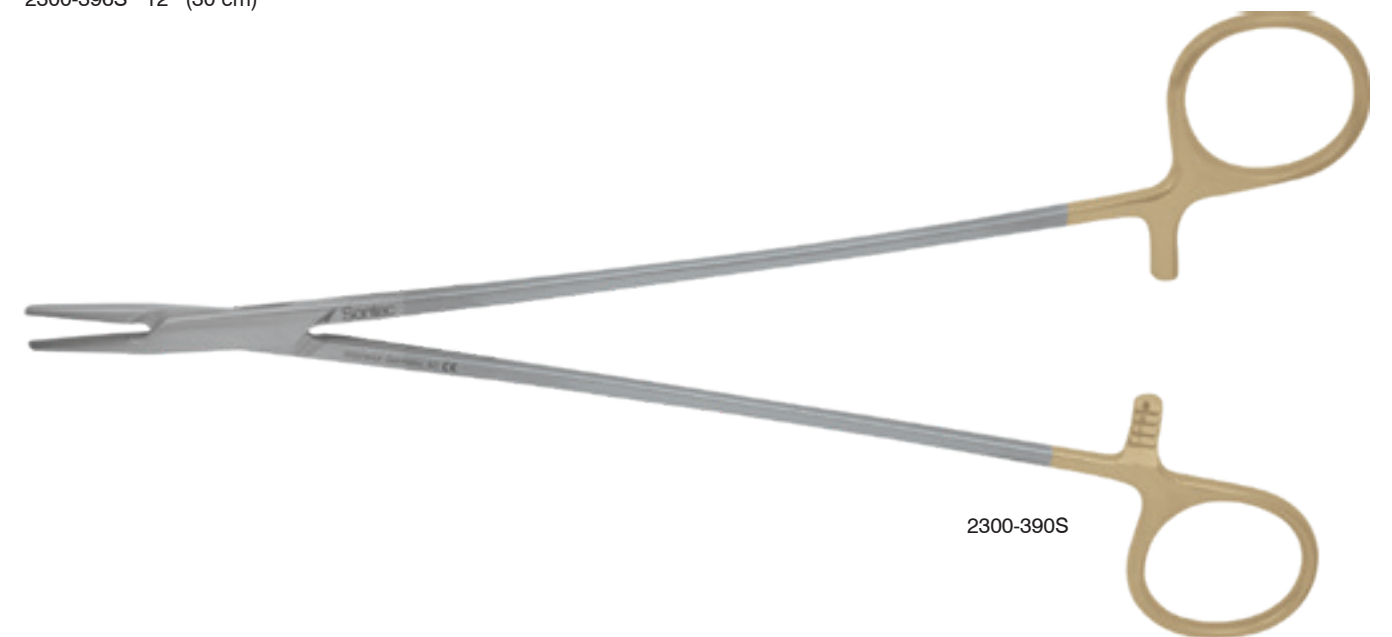

**Baumgartner Needle Holder**

Mini Mayo Hegar / tungsten carbide

- 132-110 5" (12.5 cm)
- 1100-112A 5 1/2" (14 cm)



132-110

**Collier Needle Holder**

Fenestrated tip / 5" (12.5 cm)

- 130-514



130-514

**Mayo-Hegar Needle Holder**

Serrated jaws without TC

- 130-527 6 1/4" (15 cm)
- 130-529 7 1/4" (18 cm)
- 130-531 8" (20 cm)



130-527



130-529



130-531

Tungsten carbide serrated jaws

- 2300-328 5 3/4" (14.6 cm)
- 132-115 6 1/4" (15 cm)
- 1100-114L 7 1/4" (18 cm)
- 132-118 7 1/4" (18 cm)
- 132-120 8" (20 cm)
- 132-122 9" (23 cm)
- 132-123 10" (25 cm)
- 132-125 12" (30 cm)
- 1100-853 14" (35 cm)
- 1100-851 16" (40 cm)
- 1100-854 18" (45 cm)



132-115



132-118



132-115

130-529

**Sontec-Olsen-Hegar Deluxe Needle Holder**

Tungsten carbide jaws / unique jaw design

- 1100-108D 6 3/4" (17 cm)
- 1100-110D 7 3/4" (19.5 cm)

\* Custom micro serrations oncutting blade available upon request



**Sontec Olsen-Hegar Needle Holder**

Unique jaw design / tungsten carbide

- 1100-106 5 1/2" (14 cm)
- 1100-106A 5 1/2" (14 cm) delicate
- 1100-108 6 1/2" (16.5 cm)

\* Custom micro serrations oncutting blade available upon request



**Olsen-Webster Needle Holder**

4 3/4" (12 cm)

1103-601	serrated w/out TC/standard	
132-362	TC serrated	
132-359	TC serrated	delicate
132-360	TC smooth	
1103-604	TC dust	delicate
132-361	TC dust	
132-362D	TC serrated *	
132-362S	TC offset ring	

\* Double offset ring  
 \* Custom micro serrations on cutting blade available upon request

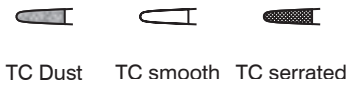

TC Dust TC smooth TC serrated

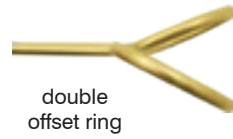

double offset ring

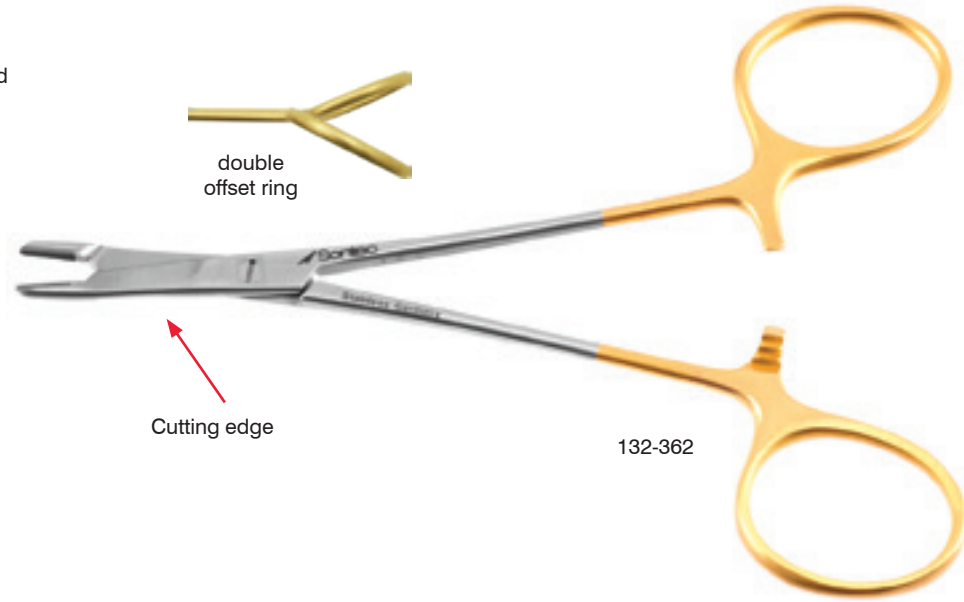

Cutting edge

132-362

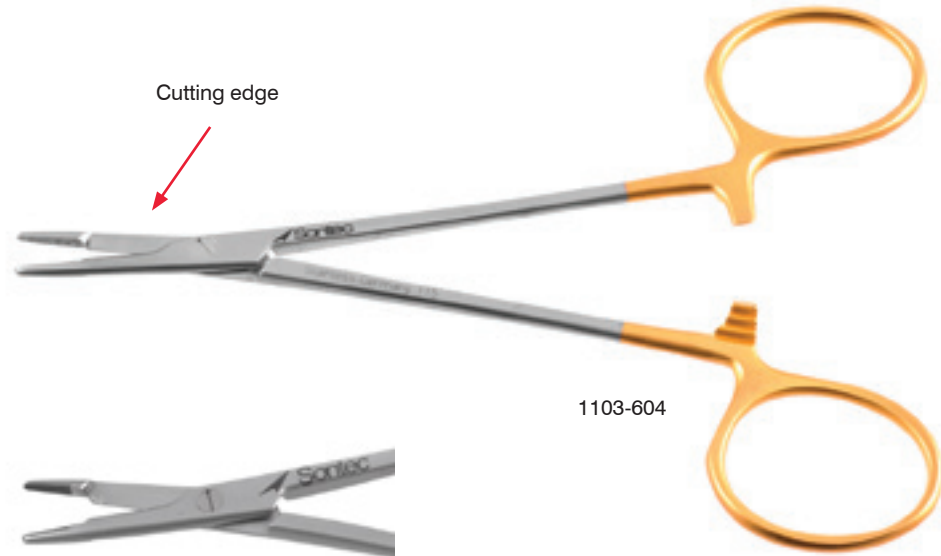

Cutting edge

1103-604



132-359

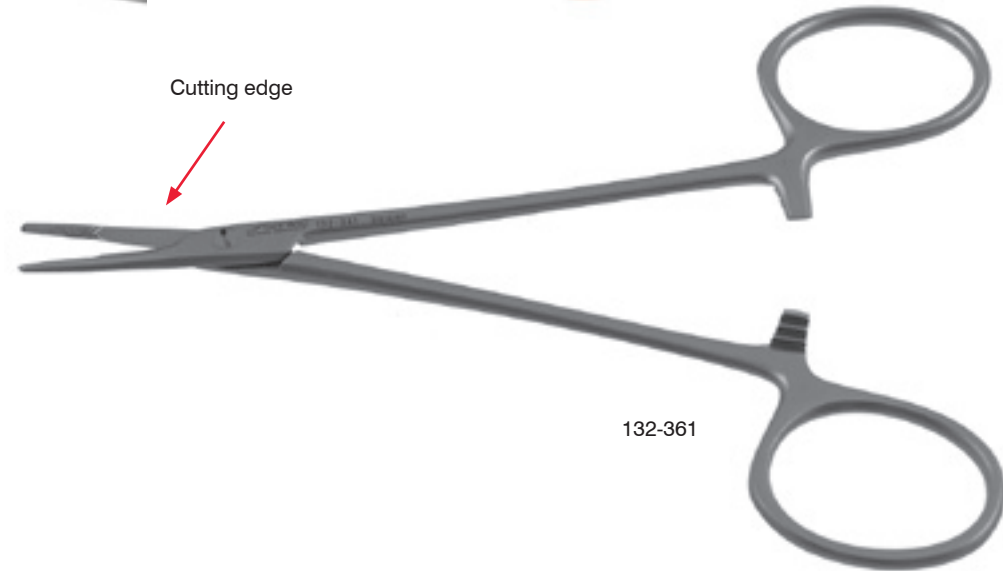

Cutting edge

132-361

**Foster-Gillies Needle Holder**

TC serrated

132-387	straight	3 7/8" (10 cm)
132-382	angled	4 3/4" (12 cm)
132-383	curved	5 3/4" (14.5 cm)
132-382L	angled	4 3/4" (12 cm) *
132-383L	curved	5 3/4" (14.5 cm) *

\* Left handed  
 \* Custom micro serrations on cutting blade available upon request



straight angled

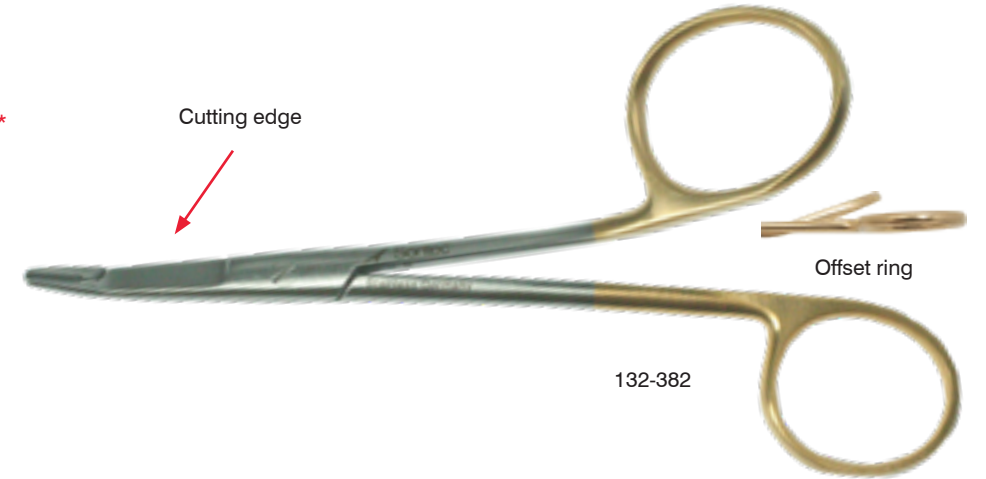

Cutting edge

Offset ring

132-382



Cutting edge

132-383



straight angled

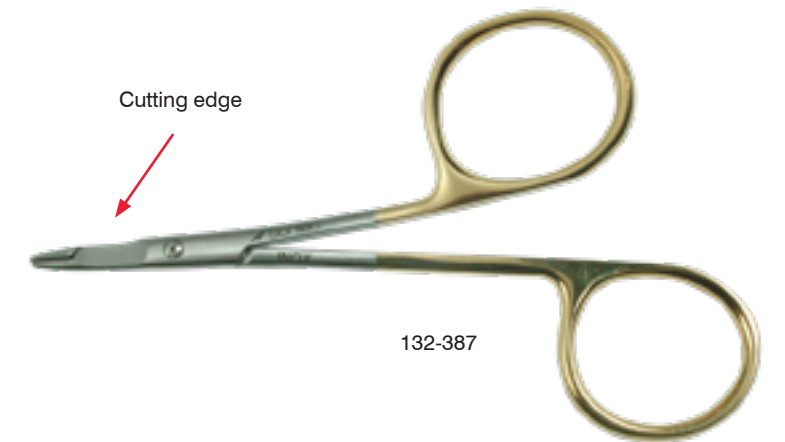

Cutting edge

132-387

**Gillies Needle Holder**

Curved / 6 1/8" (15.5 cm)

- 132-384C TC serrated
- 132-384D TC dust
- 132-384L left handed

\* Custom micro serrations on cutting blade available upon request

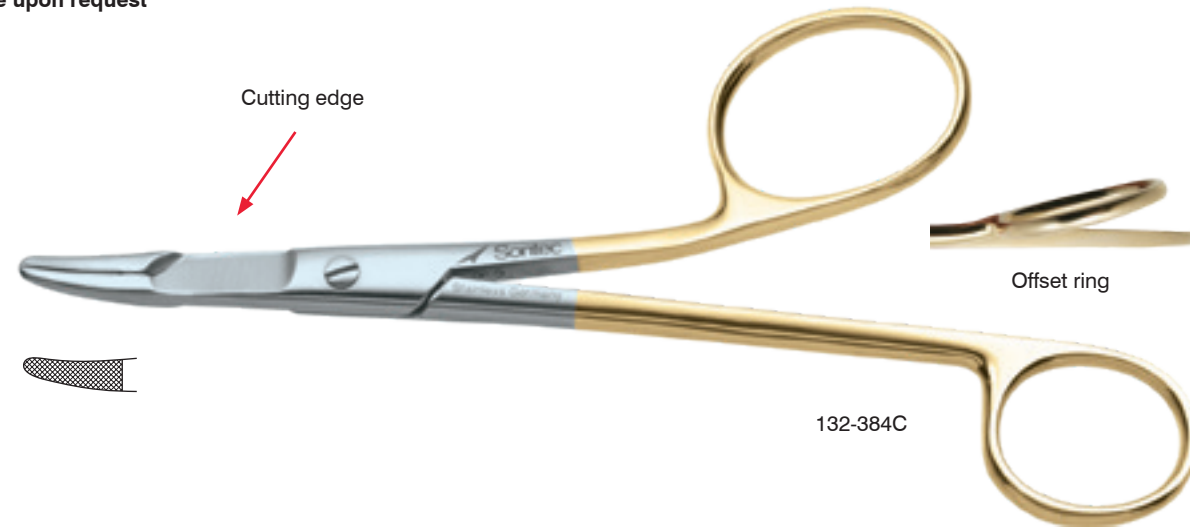

132-384C



132-384L

**Sternal Wire Twister Needle Holder**

Broad jaw / TC serrated / can be used as a wire twister / suggested suture size sternal needles and smaller

- 1103-154S 5 1/8" (13 cm)
- 1103-152 7" (18 cm)
- 1103-153 7 3/4" (19.5 cm)

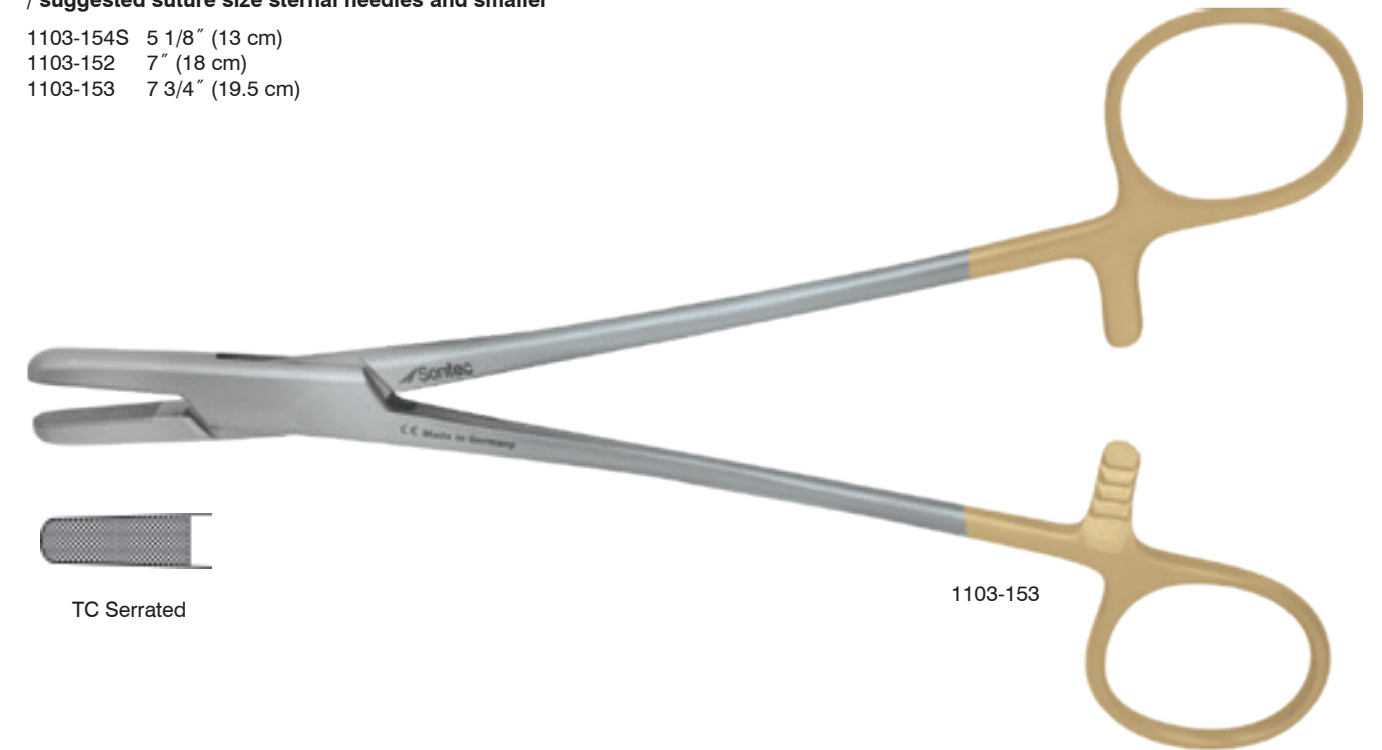

1103-153

**New Orleans Wire Twister Needle Holder**

TC serrated / suggested suture size 2-0 and smaller

- 2300-600 rounded 6" (15 cm)
- 2300-602 blunt 6" (15 cm)
- 2300-601 rounded 7" (18 cm)
- 2300-604 blunt 7" (18 cm)
- 2300-606 rounded 8" (20.5 cm)
- 2300-607 blunt 8" (20.5 cm)

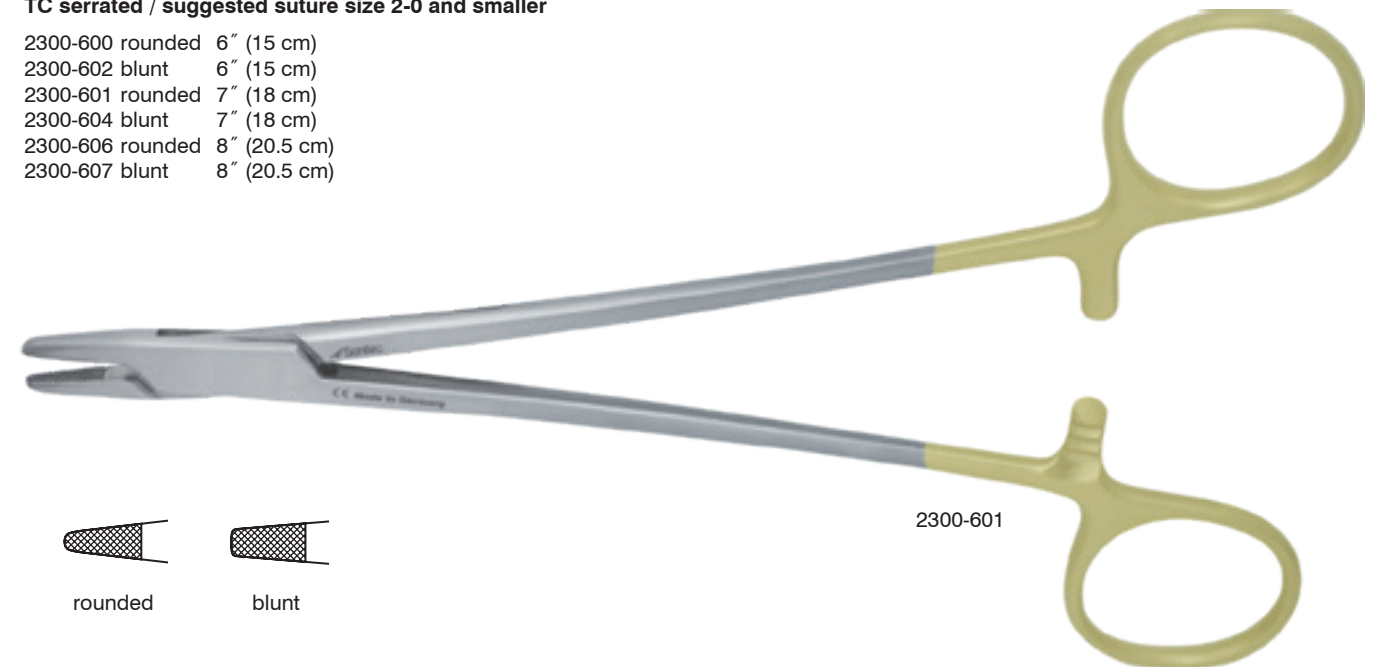

2300-601

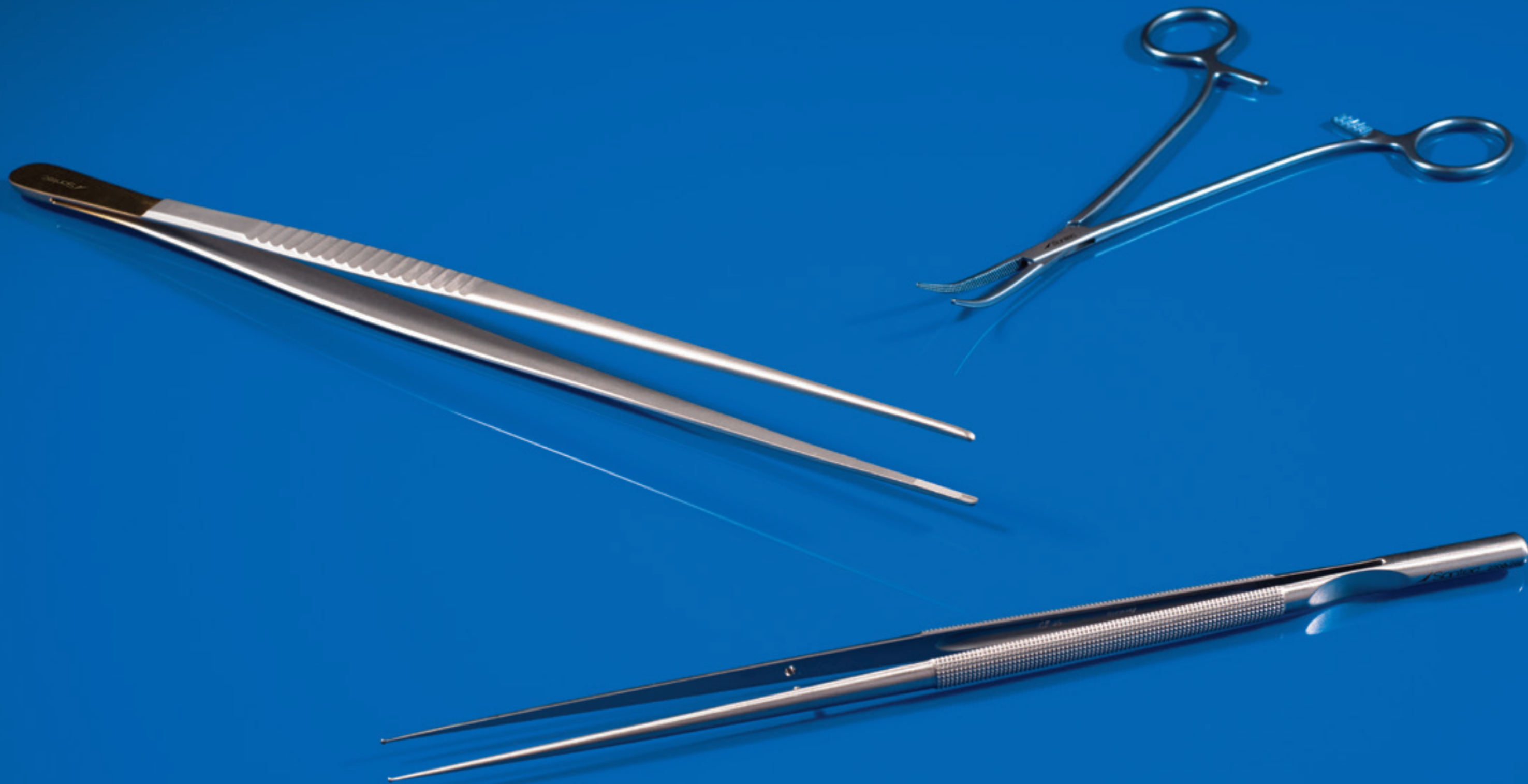

 Sontec Instruments®

Forceps

**Jewelers Classic Forceps**

**#1 / standard handle / extra delicate**

14-6810 stainless  
T14-6810 titanium



14-6810

**#2 / standard handle / delicate / stair**

14-6815  
14-6816 TCD  
T14-6816 titanium



14-6815

**#3 / standard handle / standard**

14-6830 stainless  
T14-6830 titanium



14-6830

**#3 / standard handle / standard / stainless / TCD**

14-6831

**#3C / standard handle / short**

14-6820 stainless  
T14-6820 titanium



T14-6820

**#3C / standard handle / standard / stainless / TCD**

14-6821

**#4 / standard handle / standard**

14-6840 stainless  
T14-6840 titanium



14-6840

**#5 / standard handle / extra delicate**

14-6850 stainless  
T14-6850 titanium



T14-6850

**#7 / standard handle / curved**

14-6870 stainless  
T14-6860 titanium



T14-6860

**Adson Tissue TC Serrated Platform Forceps**

**1 x 2 teeth / TC serrated platform / serrated handle / 4 3/4"**

140-305 1.0 mm  
140-304 1.3 mm  
140-303 1.8 mm

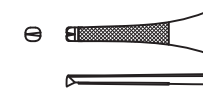

140-303



140-304

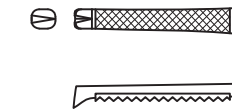

**1 x 2 teeth / TC serrated platform / serrated handle / 6"**

140-207 0.8 mm  
140-309 1.0 mm  
140-202 1.3 mm  
140-203 1.8 mm



140-309

**1 x 2 teeth / TC serrated platform / fenestrated handle / 4 3/4"**

140-305F 1.0 mm  
140-3042 1.3 mm  
140-3032 1.8 mm



140-305F

**2 x 3 teeth / TC serrated platform / serrated handle / 4 3/4"**

140-306 0.8 mm  
140-307 2.0 mm



140-307

**2 x 3 teeth / TC serrated platform / fenestrated handle / 4 3/4"**

140-304F 1.0 mm



140-304F

**Stille-Adson Dressing Forceps**

Serrated / 4 3/4" (12 cm)

136-659  
136-659D delicate

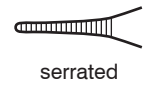

**Brown Forceps**

9x9 teeth / castroviejo handle / 4 1/4" (10.8 cm)

14-6560  
14-6562 with TC dust platform  
14-6564 with TC insert



**Adson Tissue Forceps Titanium**

TC dust / 1.0 mm tips / 4 3/4" (12 cm)

140-298T



**Adson Tissue Forceps Titanium**

1 x 2 / TC dust / tying platform / 4 3/4" (12 cm)

140-304T



**Brown-Adson Tissue Forceps**

Serrated handle / 7 x 7 teeth / 4 3/4" (12 cm)

136-688 fenestrated handle  
136-688S



3 x 4 teeth / TC platform / 4 3/4" (12 cm)

136-689 serrated handle  
1100-735F fenestrated handle

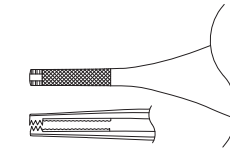

3 x 4 teeth / TC platform / electro black coated / 4 3/4" (12 cm)

136-6891 serrated handle



Russian fenestrated handle / 8 x 8 teeth / 4 3/4" (12 cm)

136-700



Serrated handle / 9 x 9 teeth / 4 3/4" (12 cm)

136-686  
136-686D delicate  
136-698 angled

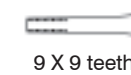

Serrated handle / TC platform / 9 x 9 teeth / 4 3/4" (12 cm)

136-689

Serrated handle / 9 x 9 teeth / 6" (15.5 cm)

136-687  
136-697 TC platform



**Adson Dressing Serrated Forceps**

Serrated tip / serrated handle / 4 3/4"

- 136-6621T 0.4 mm titanium
- 136-6601 0.5 mm
- 136-662 0.8 mm
- 136-662T 0.8 mm titanium
- 136-660 1.3 mm
- 136-660A 1.3 mm angled



Serrated tip / fenestrated handle / 4 3/4"

- 136-663 0.8 mm
- 136-661 1.3 mm

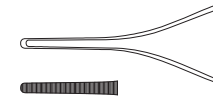

Serrated tip / serrated handle / 6"

- 140-198 1.3 mm

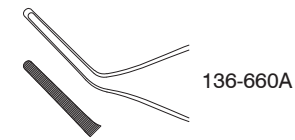

**Adson Dressing TC Serrated Platform Forceps**

TC Serrated platform / serrated handle / 4 3/4"

- 140-299 0.8 mm
- 140-301 1.3 mm

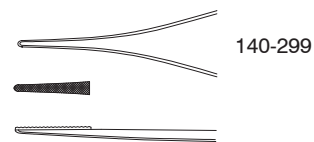

TC Serrated platform / serrated handle / 6"

- 140-201 1.3 mm

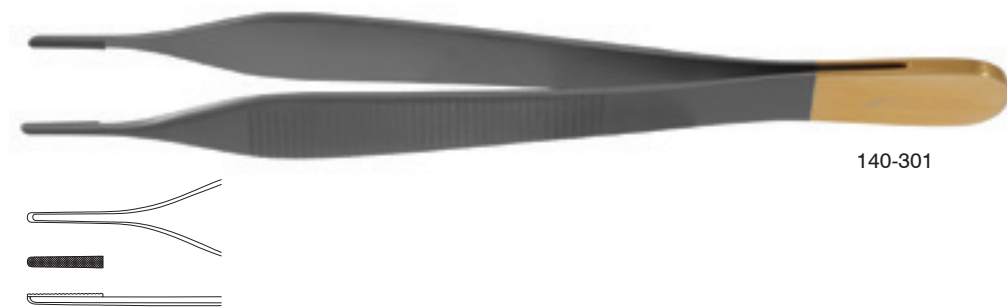

**Brown Adson Tissue Forceps Titanium**

1.8 mm tips / 7x7 teeth

- T136-688 4 3/4" (12 cm) fenestrated handle
- 136-688T 6" (15.2 cm)



1.8 mm tips / 9x9 teeth / 4 3/4" (12 cm)

- T136-686 4 3/4" (12 cm)



**Gorney-Adson Forceps**

1 x 2 teeth with platform / stop pin, 4 3/4" (12 cm)

- 136-6741

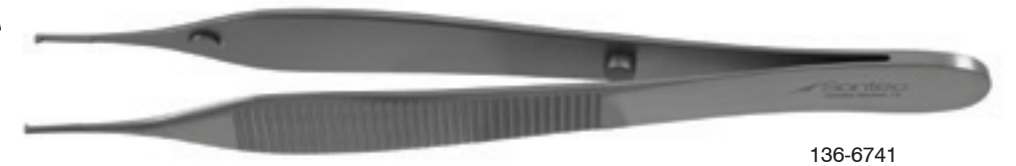

**Adson Dressing Cross-Serrated Forceps**

Cross-serrated tip / serrated handle / 4 3/4"

- 136-664D 0.8 mm
- 136-664 1.3 mm



Cross-serrated tip / 4 3/4"

- 136-665 1.3 mm



**Beasley-Babcock Tissue Forceps**

Serrated adson handle / 5 x 6 teeth / 5" (13 cm)

136-699



136-699

**Adson Tissue TC Dust Platform Forceps**

1 x 2 teeth / TC Dust platform / serrated handle / 4 3/4"

140-302D 0.8 mm  
140-302 1.0 mm

1 x 2 teeth / TC Dust platform / fenestrated handle / 4 3/4"

140-302F 0.8 mm  
140-303F 1.0 mm



140-303F

**Adson Tissue Smooth Platform Forceps**

1 x 2 teeth / smooth platform / serrated handle / 4 3/4"

136-668A 0.8 mm  
136-674D 1.0 mm  
136-674 1.3 mm

1 x 2 teeth / smooth platform / fenestrated handle / 4 3/4"

136-679 1.3 mm



136-674



136-679

**Iris Dressing Forceps**

Serrated / 0.5 mm tip / delicate / 4" (10 cm)

14-4300 straight  
14-4310 half curve  
14-4305 full curve

Serrated / 0.8 mm tip / standard / 4" (10 cm)

14-4340 straight  
14-4345 half curve  
14-4350 full curve

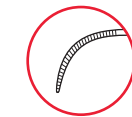
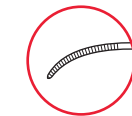
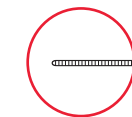

14-4300

**McIndoe Dressing and Tissue Forceps**

Fine serrations / 6" (15 cm)  
2200-750



2200-750

Cross serrations with 1x2 teeth / 6" (15 cm)  
2200-752



2200-752

**Gillies Forceps**

Fine serrations / 1 x 2 teeth / 6" (15 cm)  
2200-700



2200-700

**Erhardt Lid Clamp Forceps**

Oval  
14-9700



14-9700

**Graefe Fixation Forceps**

4.5 mm jaw / 4 1/2" (11.5 cm)  
14-5120 with lock  
14-5122 with lock curved  
14-5130 without lock



14-5120



14-5122



14-5130

**Green Fixation Forceps**

Atraumatic integrating teeth / 4" (10 cm)  
14-5200 5 mm jaw  
14-5205 5 mm jaw with lock  
14-5215 10 mm jaw with lock  
14-5220 10 mm jaw

Titanium / atraumatic integrating teeth / 4" (10 cm)  
T14-5220 10 mm jaw  
T14-5200 5 mm jaw



14-5215



14-5220



T14-5220

**Cottle Columella Clamp Forceps**

14 mm tip / with locking thumb screw / 4" (19 cm)  
14-9730



**Heath Chalazion Clamp Forceps**

Oval / 16 mm x 14 mm  
14-9740



**Lambert Chalazion Clamp Forceps**

Round / 8mm  
14-9750



**Hunt Chalazion Clamp Forceps**

Round / 12 mm  
14-9800



**Baird Chalazion Clamp Forceps**

Small oval / 11 x 8 mm I.D.  
14-9850 stainless steel  
T14-9850 titanium



**Sontec Eye Lid Forceps**

Serrated / 5" (12.5 cm)  
14-5240



**Desmarres Chalazion Clamp Forceps**

Lower solid blade / stainless  
14-9900 17 mm  
14-9901 21 mm  
14-9902 28 mm

Lower solid blade / laser finished  
14-9893 17 mm  
14-9894 21 mm  
14-9895 28 mm

Lower solid blade / blue electro coat  
14-9896 17 mm  
14-9897 21 mm  
14-9898 28 mm

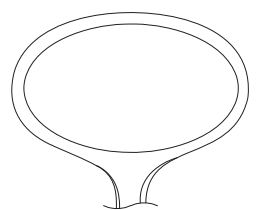
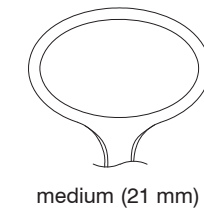

small (17 mm)

medium (21 mm)

large (28 mm)

**Desmarres Severin Chalazion Clamp Forceps**

Two open tips / both blades fenestrated  
14-9908 17 mm  
14-9907 21 mm  
14-9906 28 mm

Two open tips / both blades fenestrated  
T14-9908 17 mm  
T14-9907 21 mm  
T14-9906 28 mm



17 mm

21 mm

28 mm



**Putterman Clamp Forceps**

14-9400	stainless	slide lock
T14-9400	titanium	slide lock
14-9410	stainless	screw lock



**Francis Chalazion Clamp Forceps**

**Medium oval**  
14-9870



**Lordan Chalazion Clamp Forceps**

**Triangular**  
14-9910



**Snellen Entropium Clamp Forceps**

**18 x 35 mm jaw**  
14-9920 right  
14-9925 left

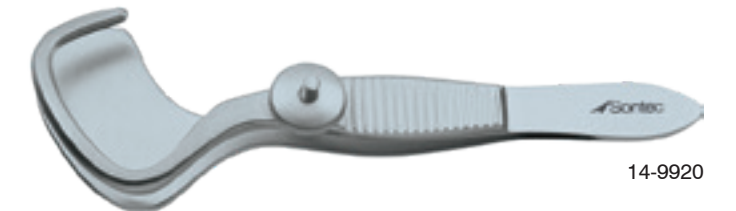

**Castroviejo Lip Graft Clamp Forceps**

**U-shaped / closed end**  
14-9725



**Jones Towel Clamp Forceps**

**Cross action / stainless**  
14-9990 2 1/4" (5.5 cm)  
14-9992 3 1/2" (7.5 cm)

**Cross action / titanium**  
T14-9990 2 1/2" (6 cm)



**Bonaccolto Suture Forceps**

Conjunctiva forceps / longitudinally serrated jaws / with cross serrations at tips / straight

14-6500 1.2 mm tip  
14-6510 1.7 mm tip



14-6510

Titanium / conjunctiva forceps / longitudinally serrated jaws / with cross serrations at tips / straight

T14-6500 1.2 mm tip  
T14-6510 1.7 mm tip



T14-6510

**Barraquer Cilia Forceps**

TC Dust / slightly angled

14-6303



14-6303

Titanium / TC dust / slightly angled

T14-6303



T14-6303

**Gradle Cilia Forceps**

Smooth square jaws

14-6400  
T14-6400 titanium

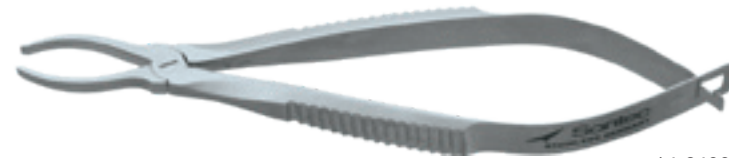

14-6400



T14-6400

**Cilia Forceps**

Smooth jaws / polished finish / serrated handle / narrow

14-6415



14-6415

**Ziegler Cilia Forceps**

TC Dust / straight

14-6450



14-6450

**Bergh Cilia Forceps**

5 mm wide jaws with horizontal serrations / 3 1/2" (9 cm)

14-6445



14-6445

**Beer Distichia Cilia Forceps**

5 mm wide jaws with TC Dust / 3 3/4" (9.5 cm)

1100-407



1100-407

**Swiss Cilia Forceps**

3mm platform tip / TC Dust

14-6310



14-6310

**Knapp Trachoma Forceps**

With rollers

14-9930



14-9930

**Kelman-McPherson 1x2 Tissue Forceps**

8 mm long / 0.3 mm / angled / 1 x 2 box teeth  
14-2630

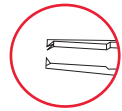

14-2630

**Stern-Castroviejo Suture 1x2 Tissue Forceps**

6 mm long / 1 x 2 box teeth / 0.5 mm / straight / handle with thumb catch lock  
14-2890

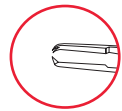

14-2890

**Manhattan 1x2 Tissue Forceps**

Tying platform / 1 x 2 box teeth / stainless

14-3050 0.7 mm  
14-3070 0.6 mm  
14-3060 0.3 mm

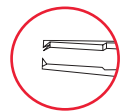

14-3070

Tying platform / 1 x 2 box teeth / titanium

T14-3050 0.7 mm  
T14-3070 0.6 mm  
T14-3060 0.3 mm

**Manhattan Severin 1x2 Tissue Forceps**

Tying platform / 1 x 2 angled teeth / stainless

14-3073 0.12 mm delicate  
14-3075 0.3 mm  
14-3071 0.5 mm  
14-3072 0.6 mm  
14-3077 0.7 mm  
14-3074 0.9 mm

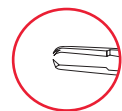

14-3077

Tying platform / 1 x 2 angled teeth / titanium

T14-3073 0.12 mm delicate  
T14-3075 0.3 mm  
T14-3071 0.5 mm  
T14-3072 0.6 mm  
T14-3077 0.7 mm  
T14-3074 0.9 mm

**Bracken 1x2 Fixation Forceps**

1 x 2 teeth / angled / 4 1/4" (10.5 cm)  
14-4800

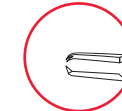

14-4800

**Lester Fixation 1x2 Tissue Forceps**

4" (10 cm)  
14-4600 1 x 2 teeth  
14-4620 2 x 3 teeth

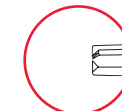

14-4620

**Girard 1x2 Fixation Forceps**

With sliding lock / 1 x 2 angled teeth

14-3240 0.3 mm  
14-3245 0.9 mm  
14-3246 0.5 mm

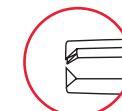

14-3240

With sliding lock / 0.5 mm / with tying platform / 1 x 2 angled teeth

14-3247 curved  
14-3248 straight



14-3245



14-3247

**Strabismus Forceps**

1x2 teeth / slide lock

14-3150 straight  
14-3152 right  
14-3154 left



14-3150



14-3152



14-3154

**Girard 1x2 Fixation Forceps**

With push lock / 1 x 2 box teeth

14-3260A 0.3 mm  
14-3260B 0.5 mm  
14-3260C 0.9 mm  
14-3260D 1.2 mm

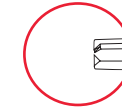

**Girard Corneoscleral Forceps**

Tying platform / 1 x 2 angled teeth / 0.12 mm / delicate

- 14-3200 right handed
- 14-3210 left handed



**Hyde Corneal Forceps**

Tying platform / 2 x 2 box teeth / 0.12 mm / delicate

- T14-2220
- 14-2220

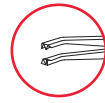

**Bishop-Harmon 1x2 Tissue Forceps Titanium**

1 x 2 box teeth / 3 1/2" (9 cm)

- T14-3803 0.3 mm
- T14-3805 0.5 mm
- T14-3810 0.8 mm
- T14-3800 0.12 mm



**Bishop-Harmon 1x2 Tissue Forceps**

1 x 2 teeth / 3 1/2" (9 cm)

- 14-3800 0.3 mm tip delicate
- 14-3805 0.5 mm tip
- 14-3810 0.8 mm tip



**Castroviejo Suture 1x2 Teeth Forceps**

With tying platform / 1 x 2 teeth / stainless

- 14-2800 0.12 mm tip
- 14-2805 0.2 mm tip
- 14-2810 0.3 mm tip
- 14-2860 0.3 mm tip angled tips on flat
- 14-2815 0.4 mm tip
- 14-2820 0.5 mm tip
- 14-2880 0.5 mm tip angled tips on flat
- 14-2830 0.9 mm tip
- 14-2840 1.5 mm tip



With tying platform / 1 x 2 teeth / titanium

- T14-2800 0.12 mm tip
- T14-2805 0.2 mm tip
- T14-2810 0.3 mm tip
- T14-2815 0.4 mm tip
- T14-2820 0.5 mm tip
- T14-2830 0.9 mm tip
- T14-2840 1.5 mm tip



**Troutman-Colibri Suture Forceps**

Tying platform / 1 x 2 box teeth / 0.12 mm / ergonomic handle

- 14-2955
- T14-2955



**Kelman & Hoffer Suture Tissue Forceps**

Angled / tying platform / 1 x 2 box teeth / 0.12 mm / ergonomic handle

- 14-2935

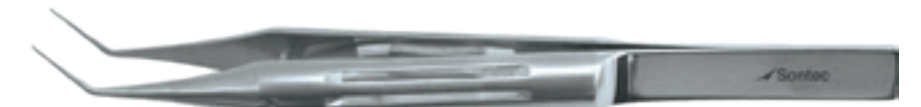

**Ergonomic-Handle Castroviejo Suture Forceps**

Straight / tying platform / 1 x 2 angled teeth / 0.12 mm / 4 1/2" (11.5 cm)

- 14-2905



**Ergonomic-Handle Bonn Suture Forceps**

Long tip / Tying platform / 1 x 2 box teeth / 0.12 mm / 4 1/2" (11.5 cm)

- 14-2920



Short tip / tying platform / 1 x 2 box teeth / 0.12 mm / 4 1/2" (11.5 cm)

- 14-2922



**Pierse Corneal 1x2 Forceps**

Very delicate / micro grooved tips

- 14-2100 straight
- 14-2110 curved



**Bonney Tissue Forceps**

**Serrated / 6 3/4" (17 cm)**

140-502 1 x 2 teeth TC serrated  
 136-578 2 x 3 teeth serrated

**1 x 2 / 7" (18 cm)**

136-580 serrated  
 140-500 TC serrated

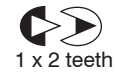

1 x 2 teeth



2 x 3 teeth



140-502



136-578



136-580

**Cushing Tying Forceps**

**Standard / straight tip / 7" (18 cm)**

2200-789 serrated  
 2200-790 1x2 teeth



2200-789

**TC insert platform / straight tip**

2200-383 7" (18 cm)



2200-383

**TC insert platform / 7" (18 cm)**

2200-387 angled tip  
 2200-389 straight tip 1x2 teeth

**TC insert platform / straight tip / serrated**

2200-394 8 1/4" (21 cm)  
 2200-396 10" (25 cm)



Straight



Angled

**Potts-Smith Dressing**

**Serrated**

136-730 7" (18 cm)  
 136-738 8" (20.3 cm)  
 136-735 8 1/4" (21 cm)  
 136-740 9 1/2" (24 cm)  
 136-746 12" (30 cm)



136-740

**Potts-Smith Tissue Forceps**

Serrated / 1 x 2 teeth

- 136-732 7" (18 cm)
- 136-737 8 1/4" (21 cm)
- 136-742 9 1/2" (24 cm)
- 136-748 12" (30 cm)



136-737

**Reul Coronary Artery Forceps**

TC serrated / 1 mm / 8" (20 cm)

2200-126



2200-126

**Skinner Tissue Forceps**

1 x 2 teeth / TC platform / 8" (20.5 cm)

- 140-517M micro
- 140-517 delicate
- 140-517G standard



1 x 2 teeth / TC platform / 9" (23 cm)

- 140-379 micro
- 140-378 delicate
- 140-376 standard

1 x 2 teeth / TC platform / 10" (25.5 cm)

- 140-519M micro
- 140-519 delicate
- 140-519G standard



140-376

**Lucae Ear Forceps**

Bayonet handle / serrated

- 467-310 4 1/2" (11.5 cm)
- 467-311 5 1/2" (14 cm)



467-310

**Brown-Cushing Bayonet Forceps**

9 x 9 teeth / 7 1/4" (18.25 cm)

136-798



136-798

**Gruenwald (Jansen) Ear Forceps**

Bayonet handle / serrated

- 467-315 6 1/2" (16.5 cm)
- 467-317 7 3/4" (19.5 cm)
- 467-318 8 1/2" (21.5 cm)



467-315



467-317



467-318

**Cushing Bayonet Forceps**

TC / serrated / 7 1/2" (19 cm)

140-220



140-220

**Electro Blue Coated Cushing Bayonet Tissue Forceps**

Monopolar use / TC serrated/insulated

140-220B 7 1/2"

140-222B 9"



140-220B

**Electro Blue Coated Skinner Tissue Forceps**

Monopolar use / TC serrated platform / 1 x 2 teeth / insulated / 9" (22.9 cm)

140-376B



140-376B

**Electro Blue Coated Potts-Smith Tissue Forceps**

Monopolar use / TC serrated platform / insulated / flat handle / 9 1/4" (23.5 cm)

2200-073B straight 2.5 mm tip 9 1/4" (23.5 cm)

2200-074B angled 2.5 mm tip 9 1/4" (23.5 cm)

2200-073C straight 1.5 mm tip 9" (22.9 cm) 1x2 teeth

2200-073D straight 2.5 mm tip 9 3/4" (24.8 cm)



2200-073B



2200-074B



2200-073C



2200-073D

**DeBakey Tissue Forceps**

**Flat handle / 6" (15 cm)**

- 2200-101 1.0 mm tip
- 2200-101A 1.5 mm tip
- 2200-105 2.0 mm tip
- 2200-105A 2.5 mm tip
- 2200-105B 2.8 mm tip

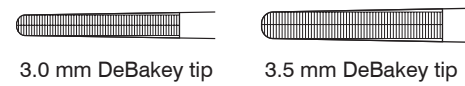
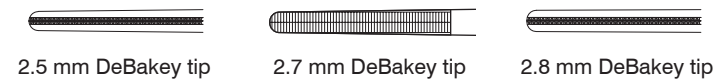

**Flat handle / 7 3/4" (19.5 cm)**

- 2200-102 1.0 mm tip
- 2200-102A 1.5 mm tip
- 2200-107 2.0 mm tip
- 2200-110 2.7 mm tip
- 2200-112 3.5 mm tip

**Flat handle / 9 1/2" (24 cm)**

- 2200-103 1.5 mm tip
- 2200-108 2.0 mm tip
- 2200-111 2.7 mm tip
- 2200-1133 3.0 mm tip
- 2200-113 3.5 mm tip

**Flat handle / 12" (30 cm)**

- 2200-104 1.5 mm tip
- 2200-109 2.0 mm tip
- 2200-1112 2.7 mm tip
- 2200-1132 3.5 mm tip

**With pin / flat handle / 7 3/4" (19.5 cm)**

- 2200-107P 2.0 mm tip
- 2200-110P 2.7 mm tip

**With pin / flat handle / 9 1/2" (24 cm)**

- 2200-108P 2.0 mm tip
- 2200-111P 2.7 mm tip

**With pin / flat handle / 12" (30 cm)**

- 2200-1112P 2.7 mm tip

\* other sizes available with pin upon request.



2200-105



2200-110P



2200-111P

**Barraquer Cilia Forceps**

**TC Dust / slightly angled**

14-6303

**Titanium / TC dust / slightly angled**

T14-6303



14-6303



T14-6303

**Iris 1x2 Tissue Forceps**

**1 x 2 teeth / 0.5 mm tip / extra delicate / 4" (10 cm)**

- 14-4400 straight
- 14-4410 half curve
- 14-4415 full curve

**1 x 2 teeth / 0.8 mm tip / standard / 4" (10 cm)**

- 14-4440 straight
- 14-4450 half curve
- 14-4455 full curve
- T14-4440 straight titanium

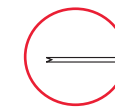

14-4440

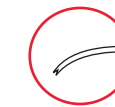

T14-4440

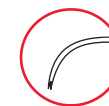

full curve



14-4410

**Bishop-Harmon Serrated Dressing Forceps**

**Serrated / 3 1/2" (9 cm)**

14-3860

**Cross-serrated / 0.5 mm tip / delicate / 3 1/2" (9 cm)**

14-3850



14-3850

**Castroviejo Suture 1x2 Teeth Forceps**

With tying platform / 1 x 2 teeth / stainless

- 14-2800 0.12 mm tip
- 14-2805 0.2 mm tip
- 14-2810 0.3 mm tip
- 14-2860 0.3 mm tip angled tips on flat
- 14-2815 0.4 mm tip
- 14-2820 0.5 mm tip
- 14-2880 0.5 mm tip angled tips on flat
- 14-2830 0.9 mm tip
- 14-2840 1.5 mm tip



14-2810

With tying platform / 1 x 2 teeth / titanium

- T14-2800 0.12 mm tip
- T14-2805 0.2 mm tip
- T14-2810 0.3 mm tip
- T14-2815 0.4 mm tip
- T14-2820 0.5 mm tip
- T14-2830 0.9 mm tip
- T14-2840 1.5 mm tip



T14-2810

**Cushing Bipolar Forceps**

Black insulated / non-stick / 1.5 mm tip / 7" (18 cm)

2700-995NS



**Tissue Bipolar Forceps**

Black insulated / non-stick / 2.0 mm tip / 6" (15 cm)

- 2700-862NS
- 2700-864NS with stop pin



2700-862NS



2700-864NS

**Jewelers Bipolar Forceps**

0.4 mm tip / 4" (10 cm)

- 2700-920 straight
- 2700-922 curved
- 2700-915 straight blue coat



2700-920



2700-915

Insulated / non-stick / straight / 4 1/4" (10.8 cm)

- 2700-924NS 0.5 mm



2700-924NS

**McPherson Bipolar Forceps**

Smooth tying platform / 0.4 mm tip / 3 1/2" (9 cm)

- 16-2700 straight
- 16-2710 angled



16-2700



16-2710

**Adson Bipolar Forceps**

1 mm tip / 4 3/4" (12 cm)

- 2700-905
- 2700-900 blue electro coat
- 2700-902 4mm angled tip blue electro coat



2700-900



2700-902

1 mm tip / fenestrated handle / 4 3/4" (12 cm)

- 2700-902F 4 mm angled tip blue electro coat
- 2700-906 pointed tips



2700-902F



2700-906

1 mm tip / fenestrated handle / non-stick / black coated / 4 3/4" (12 cm)

- 2700-908NS straight
- 2700-903NS angled



2700-908NS

**Cushing Bayonet Bipolar Forceps**

Stainless steel / 7 1/2" (19 cm)

- 2700-978 0.7 mm tip
- 2700-940 2.0 mm tip insulated



2700-978



2700-940

**Reusable Bipolar Cord**

12 feet in length

CORD-2000

CORDS NOT TO SCALE



cord 2000

**Disposable Bipolar Cord**

Sterile-12 ft long / nickle plated banana plugs / forceps plug compatible with all manufacture bipolar forceps and sweeps / packaged 50 per case/ box of 10

CORD-1000



cord 1000

**Glover-Debakey Bulldog Clamp**

Atraumatic Jaws / straight / spring loaded

- 2100-460 2" (5 cm)
- 2100-459 2 3/4" (7 cm)
- 2100-457 3 3/8" (8 cm)
- 2100-455 5" (12.5 cm)



Atraumatic jaws / curved / spring loaded

- 2100-462 2" (5 cm)
- 2100-461 2 3/4" (7 cm)
- 2100-458 3 1/8" (8 cm)
- 2100-456 4 5/8" (11 cm)

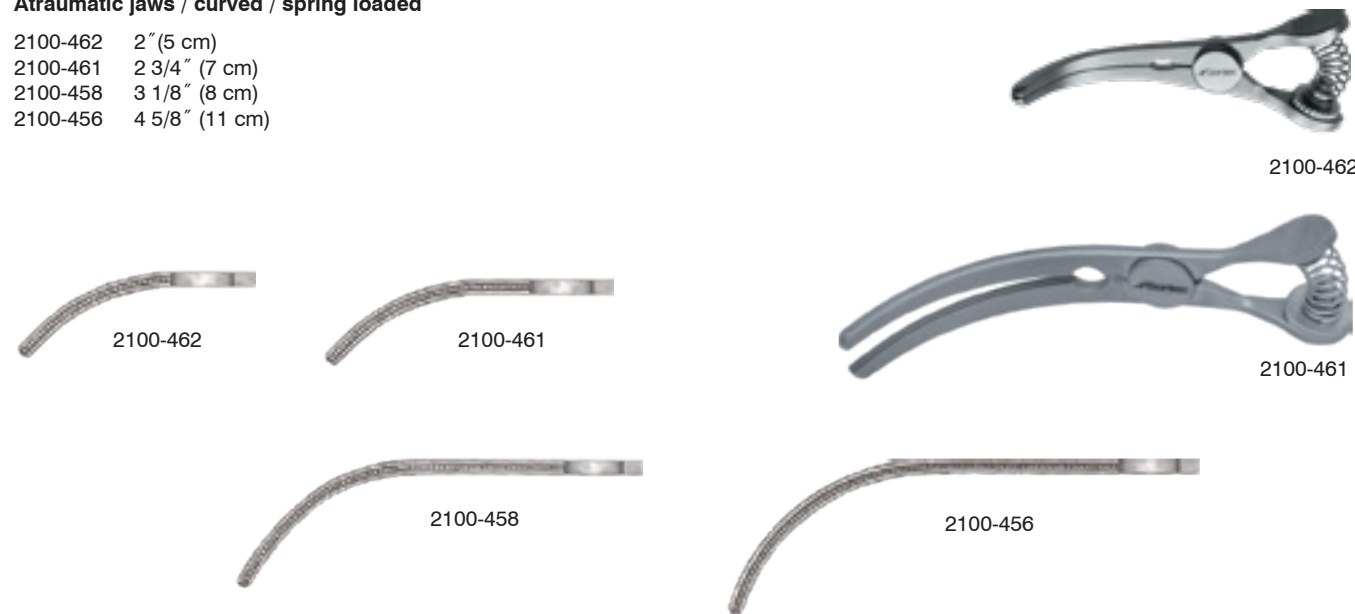

**Micro Sontec® Yasargil-Glover Carotid Artery Bulldog Clamp**

Atraumatic jaws / reverse 65° angle / 3" (7.5 cm) / spring loaded

2100-466



**Laparoscopic Bulldog Clamp**

**Straight**

- 2901-281-45 45 mm jaw
- 2901-281-60 60 mm jaw

**Curved**

- 2901-281-25 25 mm jaw overall length 2"
- 2901-281-40 40 mm jaw overall length 2 1/2"



**Cooley Bulldog Clamp**

**Atraumatic jaws / straight / cross-action**

- 2100-420 3 1/8" (8 cm)
- 2100-425 3 1/2" (9 cm)
- 2100-430 4 1/4" (10.75 cm)
- 2100-435 5" (12.5 cm)



2100-430

\* Can be used with Bulldog Clamp Applying Forceps (2100-399) below



2100-420



2100-425



2100-430



2100-435

**Atraumatic jaws / curved / cross-action**

- 2100-422 3" (7.5 cm)
- 2100-427 3 3/8" (8 cm)
- 2100-432 3 3/4" (9.5 cm)
- 2100-437 4 1/2" (11.5 cm)



2100-427



2100-422

2100-427

2100-432

2100-437

Bulldog Clamp Applying Forceps used in conjunction with bulldogs above

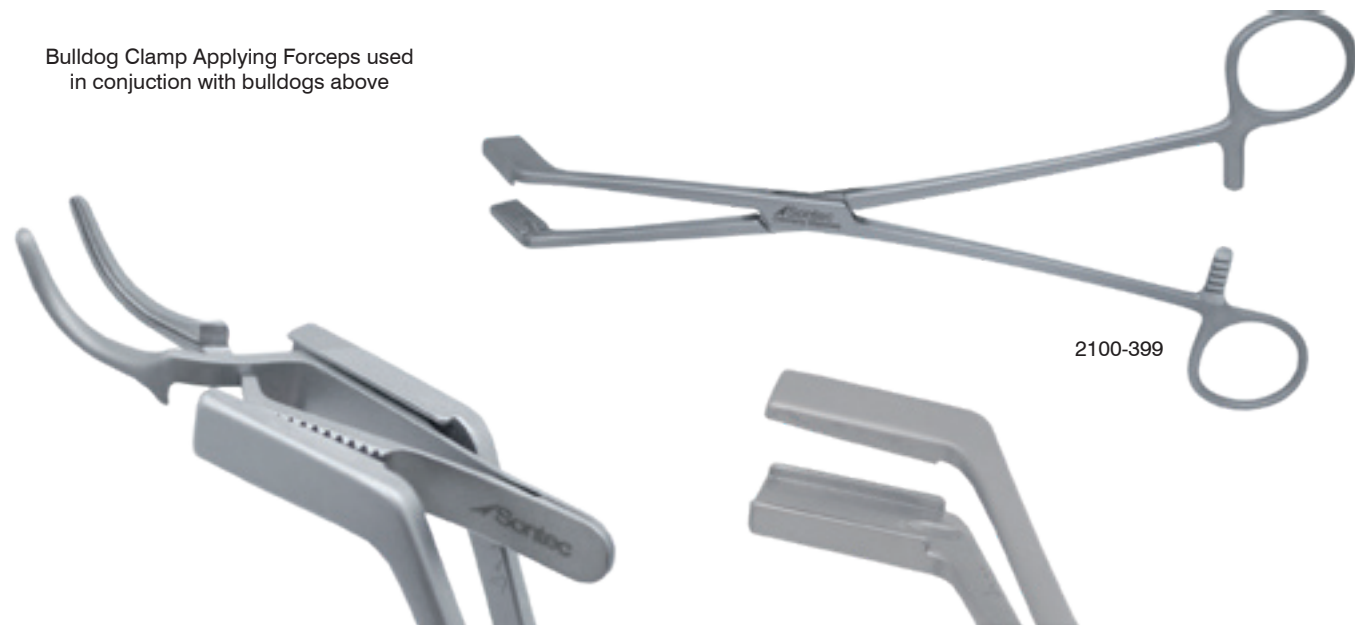

2100-399

**DeBakey Bulldog Clamp**

**Atraumatic Jaws / straight / cross-action**

- 2100-800 3 1/8" (8 cm)
- 2100-802 3 1/2" (9 cm)
- 2100-804 4 1/4" (10.75 cm)
- 2100-806 5" (12.5 cm)



2100-804

\* Can be used with Bulldog Clamp Applying Forceps (2100-399) below



2100-800



2100-802



2100-804



2100-806

**Atraumatic Jaws / curved / cross-action**

- 2100-810 3" (7.5 cm)
- 2100-812 3 1/8" (8 cm)
- 2100-814 3 3/4" (9.5 cm)
- 2100-816 4 1/2" (11.5 cm)



2100-812



2100-810

2100-812

2100-814

2100-816

Bulldog Clamp Applying Forceps used in conjunction with bulldogs above

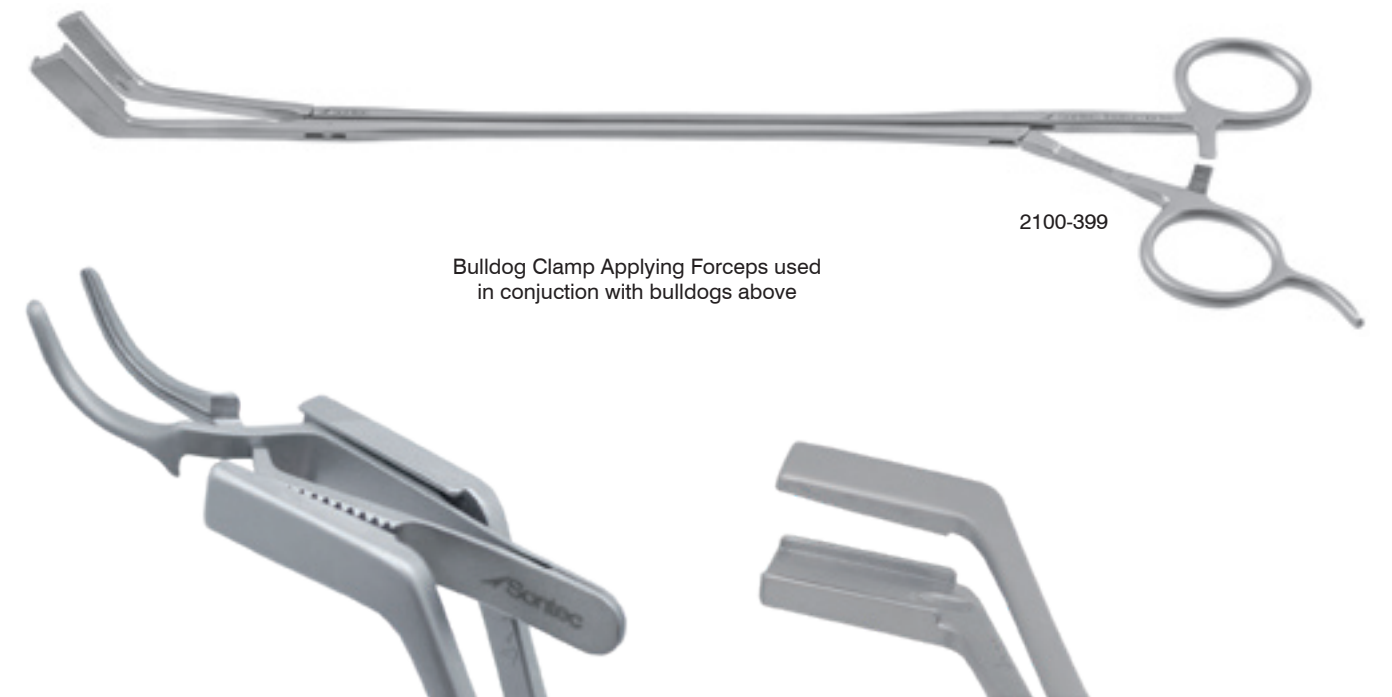

2100-399

**Dietrich Micro Bulldog Clamp**

Serrated jaw / straight / 2" (5 cm) / cross-action

- 2100-835 8 mm jaw length
- 2100-836 12 mm jaw length
- 2100-837 20 mm jaw length

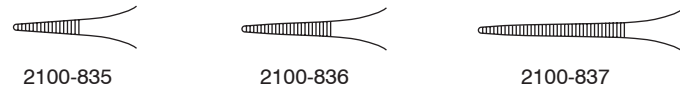

Serrated jaw / angled / 2" (5 cm) / cross-action

- 2100-838 8 mm jaw length
- 2100-839 12 mm jaw length
- 2100-840 20 mm jaw length

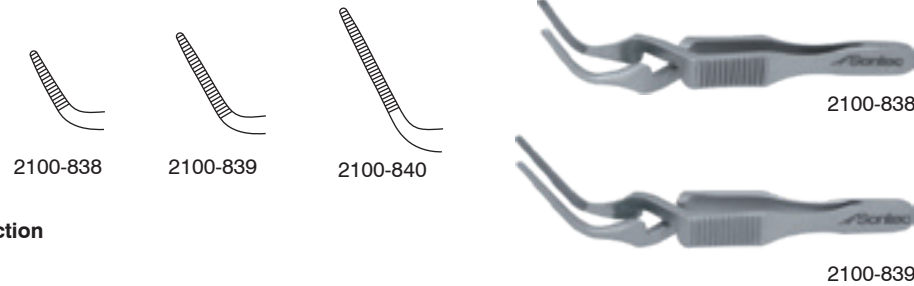

Serrated jaw / curved / 2" (5 cm) / cross-action

- 2100-841 20 mm jaw length

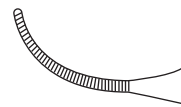

Smooth jaw / angled / 2" (5 cm) / cross-action

- 2100-842 13 mm jaw length
- 2100-843 18 mm jaw length

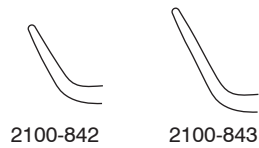

**Universal Microvascular Clamp**

For ordering:use order numbers listed below / also available in black / choose either A for Artery or V for Vein

	Clamp #1	Clamp #2	Clamp #3	Clamp #4	Clamp #5
<b>Length</b>	8 mm	11 mm	16 mm	24 mm	35 mm
<b>Pair of Clamps</b>					
<b>Vessel</b>	0.3-1.0 mm	0.6-1.5 mm	1.0-2.5 mm	1.5-3.3 mm	2.0-5.0 mm
<b>Designation</b>	B-1	B-2	B-3	HD-S	RD-S
<b>Order Number</b>	2100-B-1A 2100-B-1V	2100-B-2A 2100-B-2V	2100-B-3A 2100-B-3V	2100-HD-SA 2100-HD-SV	2100-RD-SA 2100-RD-SV

**Microvascular Clamp**

For ordering:use order numbers listed below / also available in black / choose either A for Artery or V for Vein

	Clamp #1	Clamp #2	Clamp #3	Clamp #4	Clamp #5
<b>Length</b>	8 mm	11 mm	16 mm	24 mm	35 mm
<b>Microvascular clamp pair on approximator bar</b>					
<b>Vessel</b>	0.3-1.0 mm	0.6-1.4 mm	1.0-2.25 mm	1.5-3.5 mm	2.0-5.0 mm
<b>Designation</b>	ABB-11	ABB-22	ABB-33	HD-D	RD-D
<b>Order Number</b>	2100-ABB-11A 2100-ABB-11V	2100-ABB-22A 2100-ABB-22V	2100-ABB-33A 2100-ABB-33V	2100-HD-DA 2100-HD-DV	2100-RD-DA 2100-RD-DV
<b>Microvascular clamp pair on approximator bar in frame</b>				<div style="border: 1px solid black; padding: 5px; width: fit-content; margin: auto;">                     All Microvascular Clamps are available in black. To order black clamps, please add a "B" after the order number                 </div>	
<b>Vessel</b>	0.4-1.0 mm	0.6-1.4mm	1.0-2.2 mm		
<b>Designation</b>	ABB-1	ABB-2	ABB-3		
<b>Order Number</b>	2100-ABB-1A 2100-ABB-1V	2100-ABB-2A 2100-ABB-2V	2100-ABB-3A 2100-ABB-3V		
<b>Microvascular clamp pair in wire frame</b>					
<b>Vessel</b>	0.3-1.0 mm	0.6-1.4 mm	1.0-2.2 mm		
<b>Designation</b>	DC-1	DC-2	DC-3		
<b>Order Number</b>	2100-DC-1A 2100-DC-1V	2100-DC-2A 2100-DC-2V	2100-DC-3A 2100-DC-3V		
<b>Microvascular clamp pair DC Angle</b>					
<b>Vessel</b>	0.3-1.0 mm	0.6-1.4 mm	1.0-2.2 mm		
<b>Designation</b>	DC-1	DC-2	DC-3		
<b>Order Number</b>	2100-DC-1A 2100-DC-1V	2100-DC-2A 2100-DC-2V	2100-DC-3A 2100-DC-3V		

**Micro Aneurysm Clamp Applier Forceps**

- 5 1/2" (14 cm)
- 2100-875



**Serrefine Bulldog Clamp**

1 1/2" (4 cm) / cross-action

- 14-9935 straight
- 14-9940 curved

2 1/2" (6.4 cm) / cross-action

- 115-585 straight
- 115-586 curved



**John Hopkins Bulldog Clamp**

**Straight / cross-action**

- 440-352 1 1/2"
- 440-354 2"
- 440-356 2 1/4"
- 440-358 2 1/2"
- 440-360 2 3/4"
- 440-362 3"
- 440-364 3 1/2"

**Curved / cross-action**

- 440-370 1 1/2"
- 440-372 2"
- 440-374 2 1/4"
- 440-376 2 1/2"
- 440-378 2 3/4"
- 440-380 3"
- 440-382 3 1/2"

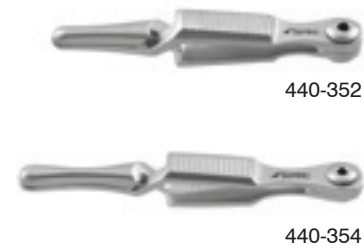

**Cooley and Debakey Neonatal Cardiovascular Clamp**

Especially developed for delicate cardiovascular and neonatal surgery / Ultra fine Cooley and Debakey jaws are atraumatic and provide a secure grip to even the most delicate vessels / 72 varieties available - choose a handle style (by letter) and tip style (by number) / 12 cm / 4 3/4" overall length

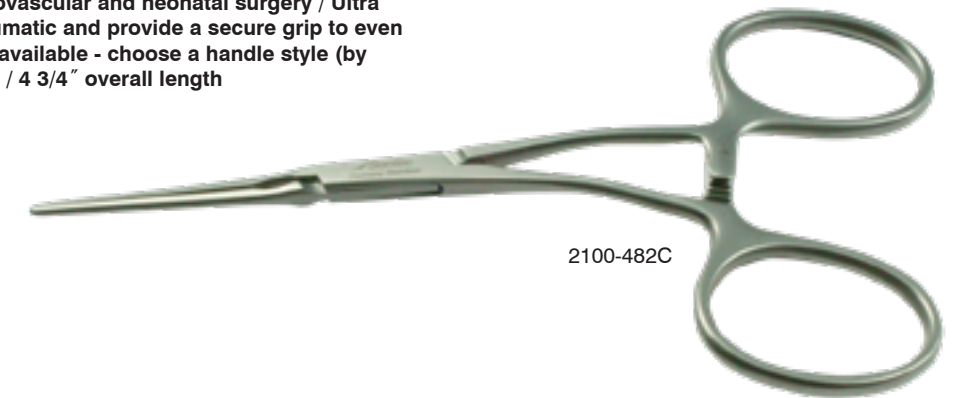

2100-482C

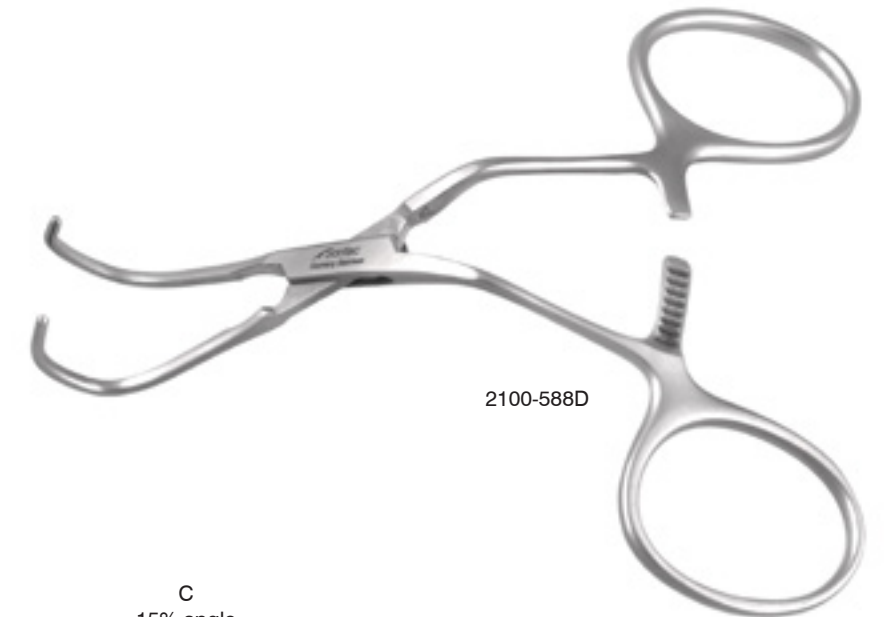

2100-588D

A  
straight

B  
curved

C  
15% angle

D  
45% angle



**Halstead Mosquito Forceps**

**Standard / 6 1/4" (15.5 cm)**

115-408 curved



**Standard / 8 1/4" (21 cm)**

115-400 straight  
115-402 curved  
115-404 right angled

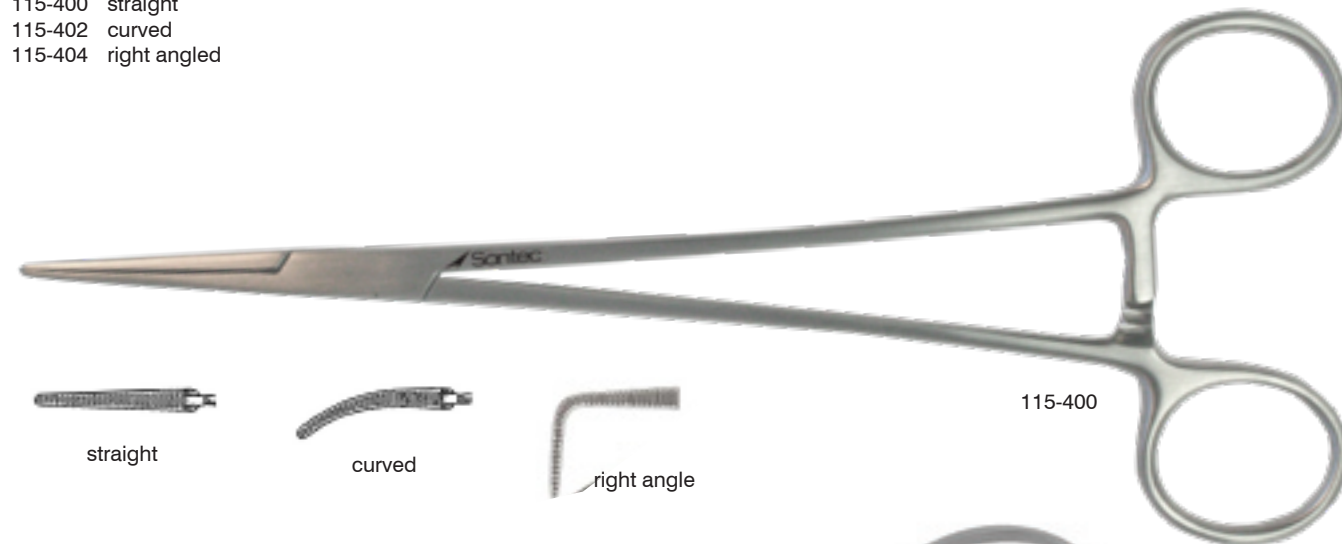

**Delicate / 5" (13 cm)**

115-410D straight  
115-412D curved

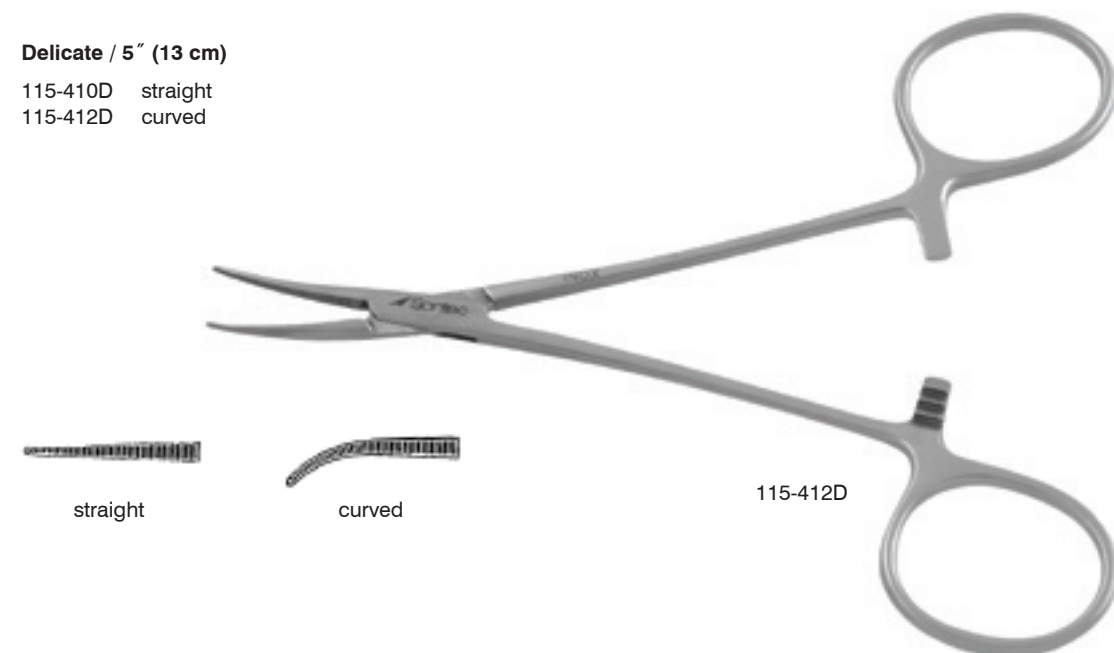

**Hartman Mosquito Forceps**

**Delicate / 3 1/2" (9 cm)**

115-426D straight  
115-428D curved



**Standard / 3 1/2" (9 cm)**

115-426 straight  
115-428 curved

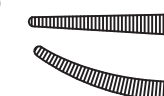

**Micro tip / 3 3/4" (9.5 cm)**

115-310 straight  
115-312 curved

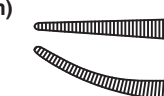

**Shank angled on flat / straight/ 3 1/2" (9cm)**

115-429



straight

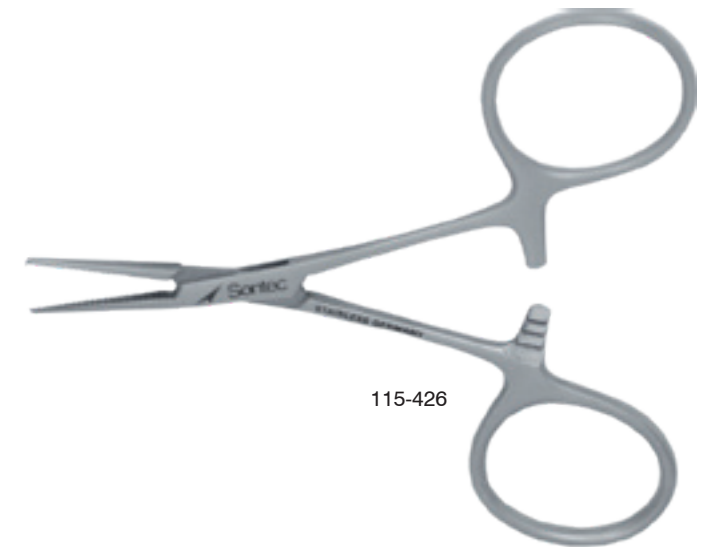

**Halstead Mosquito Forceps**

**Standard / 1 x 2 teeth / 5" (13 cm)**

115-422 straight  
115-424 curved



1 x 2 teeth  
straight



1 x 2 teeth  
curved

**Specially tapered jaws / straight / 1 x 2 micro teeth / 5" (13 cm)**

115-422M



**Kelly Forceps**

5 1/2" (14 cm)

- 115-446 straight
- 115-448 curved
- 115-448L curved left handed

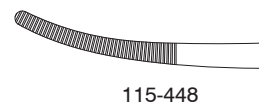

Blue electro coated / 5 1/2" (14 cm)

- 115-4461 straight
- 115-4481 curved

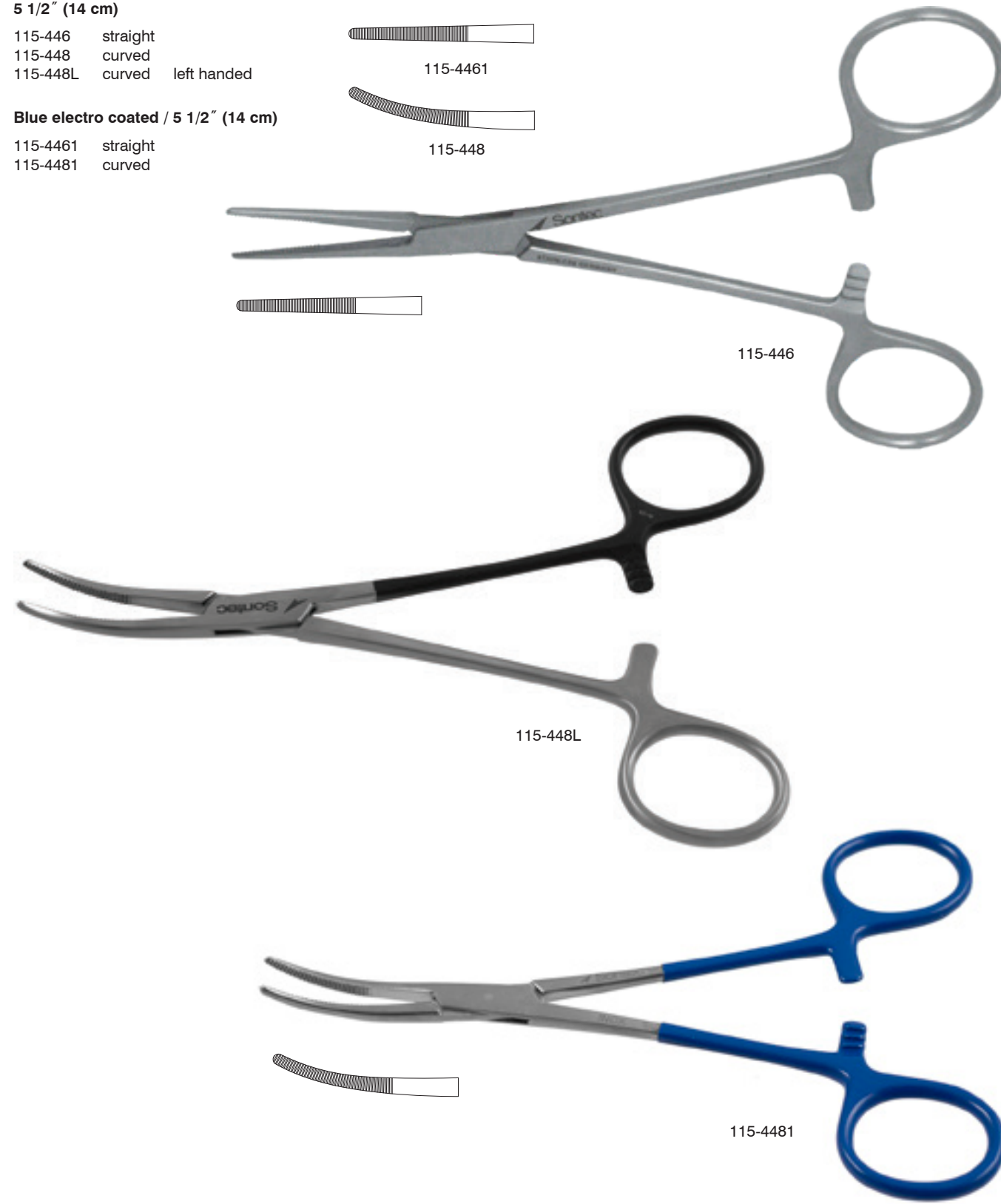

**Hartman Micro Tip Mosquito Forceps**

3 1/2" (8.9 cm)

- 115-310 straight
- 115-312 curved

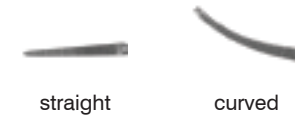

4 3/4" (12cm)

- 115-316 straight
- 115-318 curved

6" (15 cm)

- 115-320 straight
- 115-322 curved
- 115-407 curved petite point

6 1/4" (15.5 cm)

- 115-408 curved

7 1/8" (18 cm)

- 412-319 straight
- 412-321 curved

7 1/2" (19 cm)

- 2200-404 straight
- 2200-406 curved

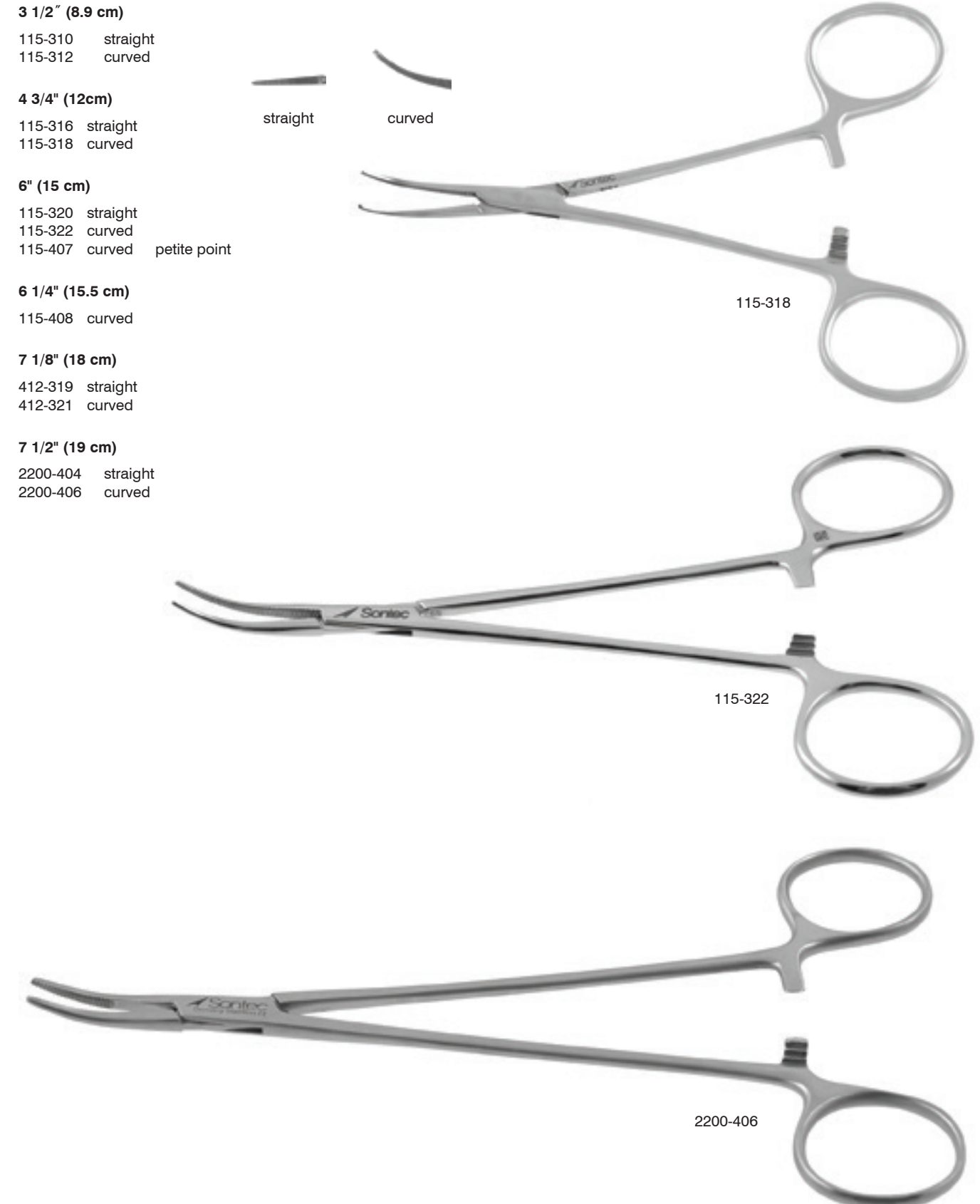

**Rochester-Ochsner Forceps**

**Serrated / 1 x 2 teeth / 6 1/4" (16 cm)**

- 115-520 straight
- 115-522 curved

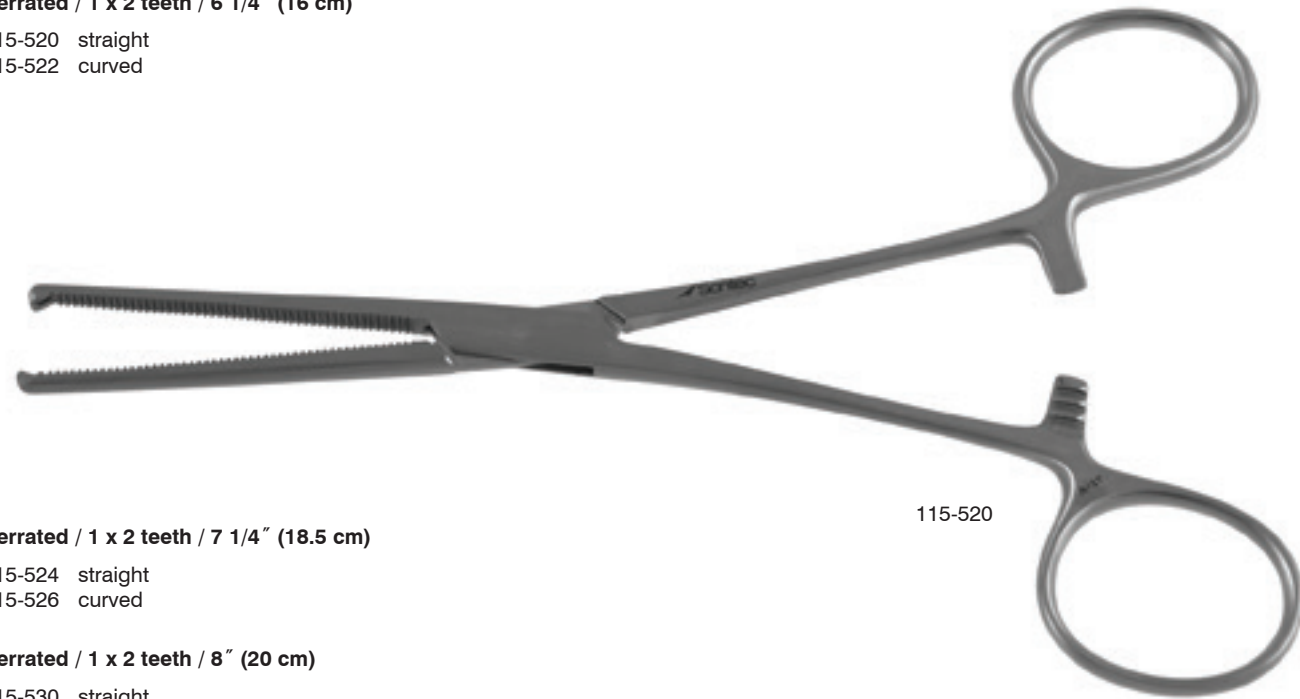

**Serrated / 1 x 2 teeth / 7 1/4" (18.5 cm)**

- 115-524 straight
- 115-526 curved

**Serrated / 1 x 2 teeth / 8" (20 cm)**

- 115-530 straight
- 115-532 curved

**Serrated / 1 x 2 teeth / 9" (23 cm)**

- 115-534 straight
- 115-536 curved

**Serrated / 1 x 2 teeth / 10" (25 cm)**

- 115-538 straight
- 115-540 curved

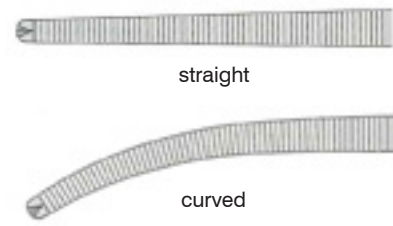

**Crile Forceps**

**5 1/2" (14 cm)**

- 115-432 straight
- 115-434 curved

**6 1/4" (16 cm)**

- 115-450 straight
- 115-452 curved

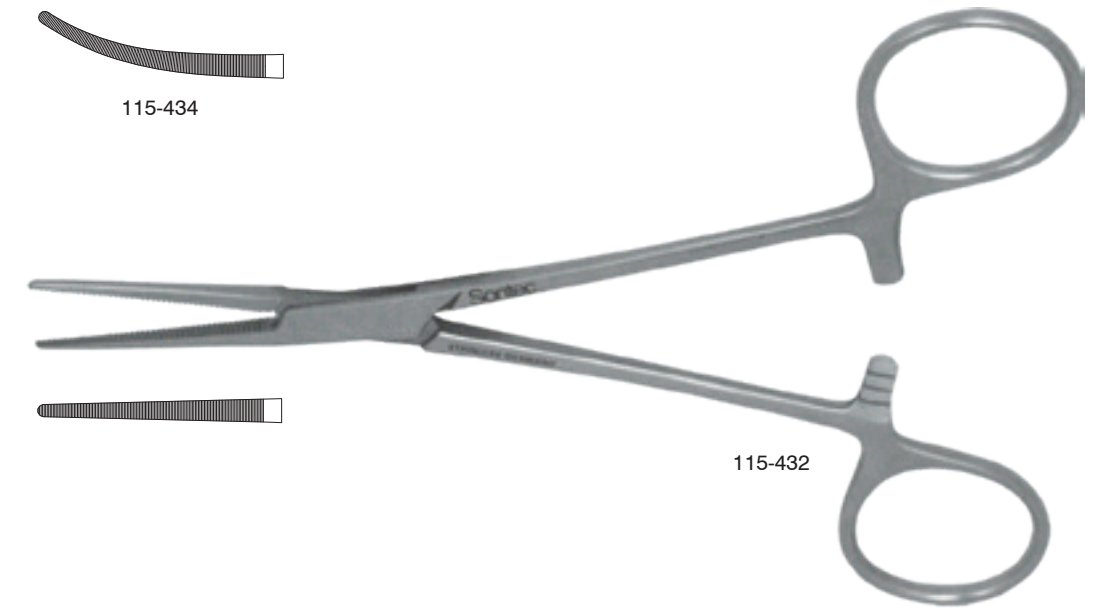
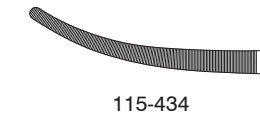

**Titanium / 6 1/4" (16 cm)**

- T115-452 curved
- T115-450 straight

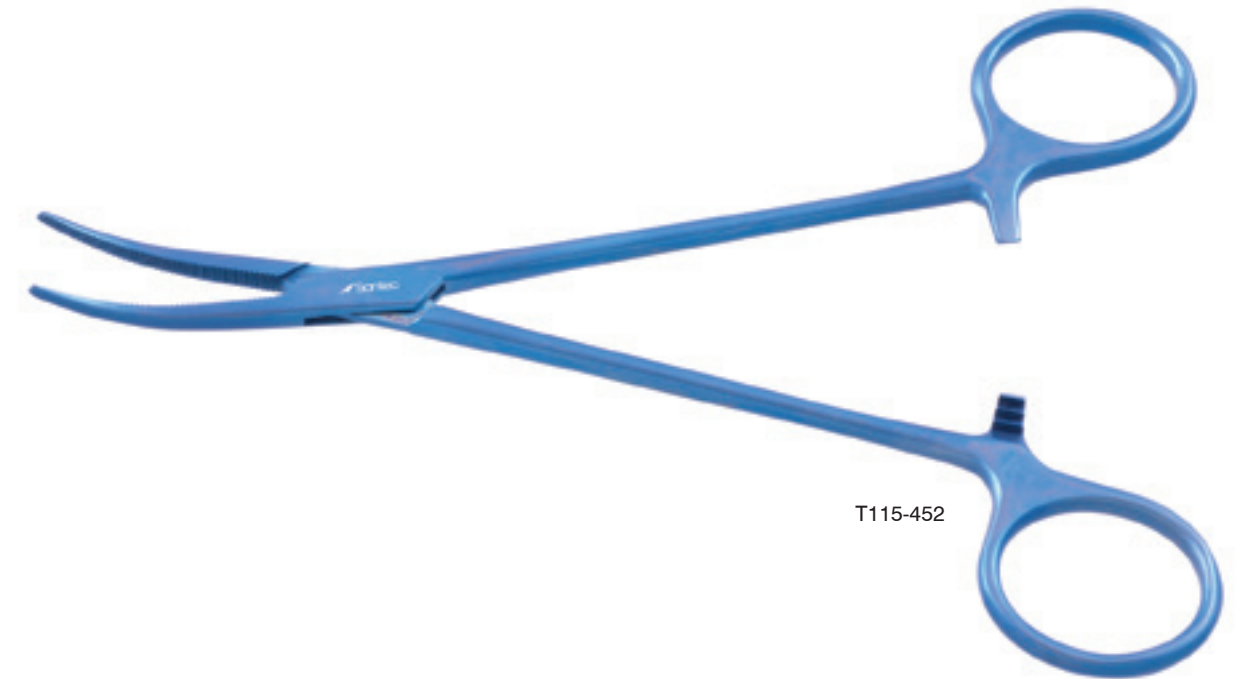

**Adson Forceps**

**5 1/4" (13.3 cm)**

2200-420 curved

**7 1/2" (19 cm)**

2200-422 straight jaw  
 2200-424 curved jaw  
 2200-426 full curved jaw

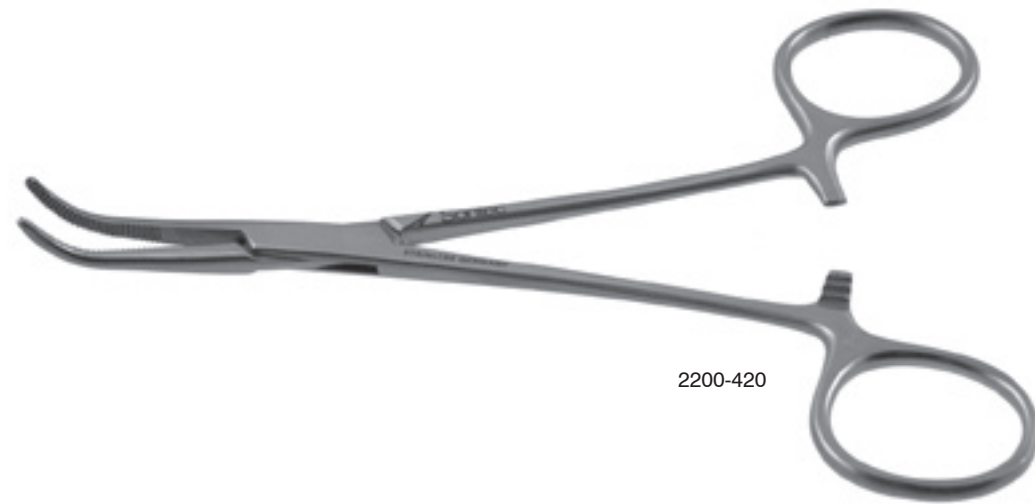

2200-420

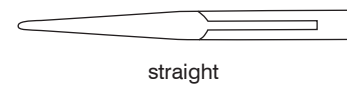

straight

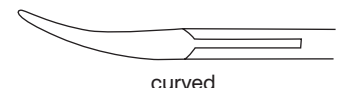

curved

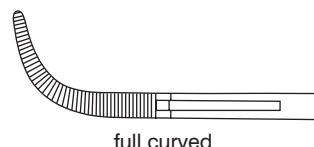

full curved



2200-426

**Schmidt Hemostatic Forceps**

**Serrated / 7 1/2" (19cm)**

485-634 slight curve  
 485-636 curved  
 485-646 slight curve closed ring  
 485-648 curved closed ring

**Serrated / 11" (28 cm)**

438-591 straight closed ring  
 438-592 slight curve closed ring

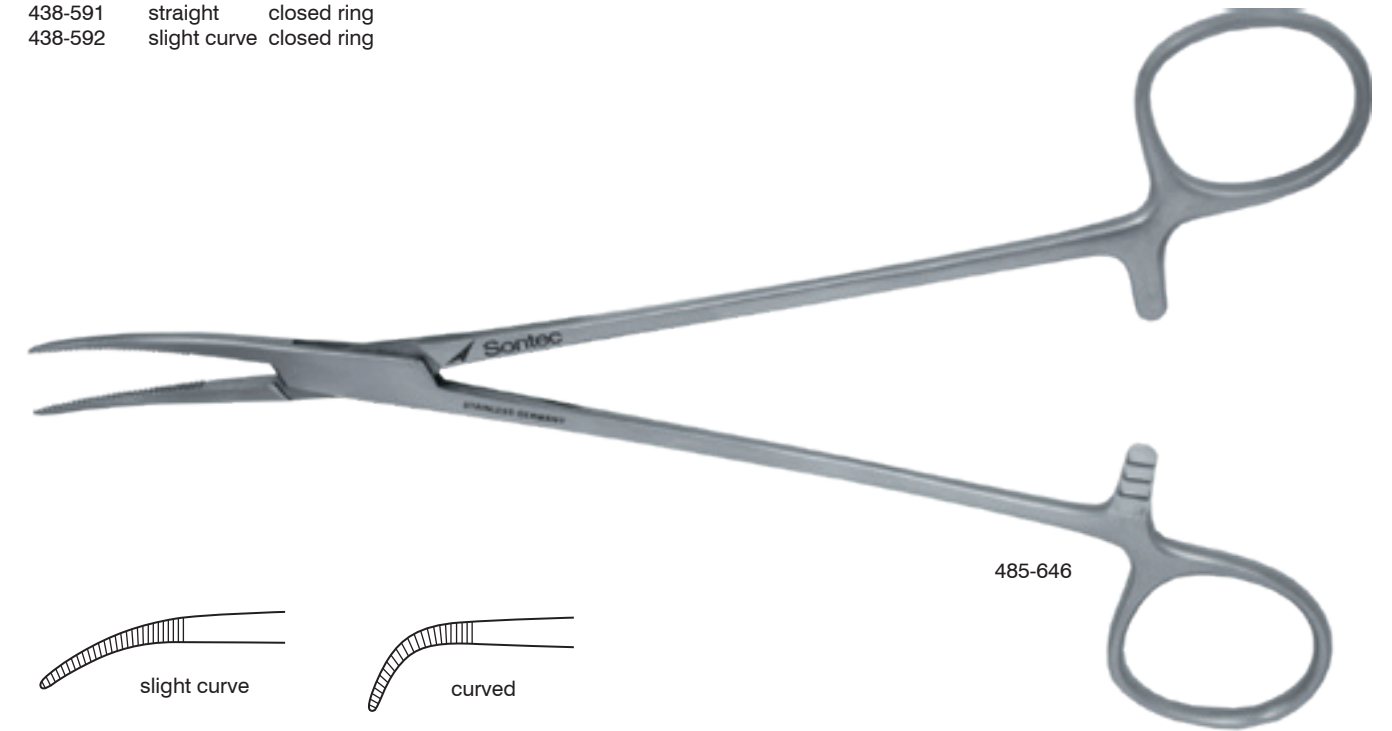

485-646

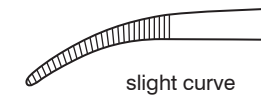

slight curve

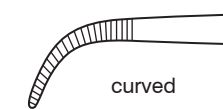

curved



438-592

**Lahey Vulsellum Forceps**

150-240 6"  
150-2408 8"



150-240

**Pitanguy Abdomen Marking Forceps**

11" (28 cm)  
475-840

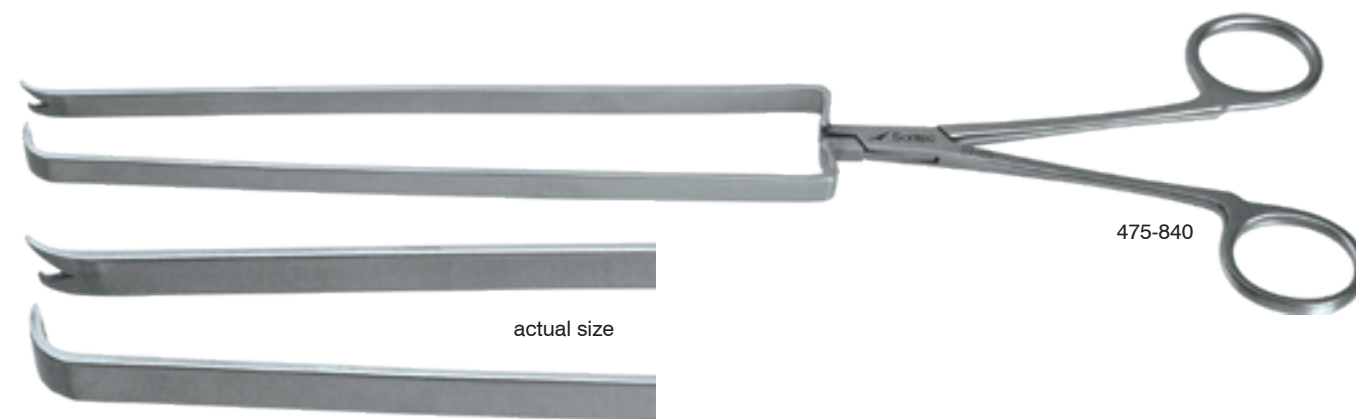

475-840

actual size

**D'assumpcoa Face Lift Marker**

6 1/4" (16 cm)  
215-028 with ratchet  
215-029 without ratchet

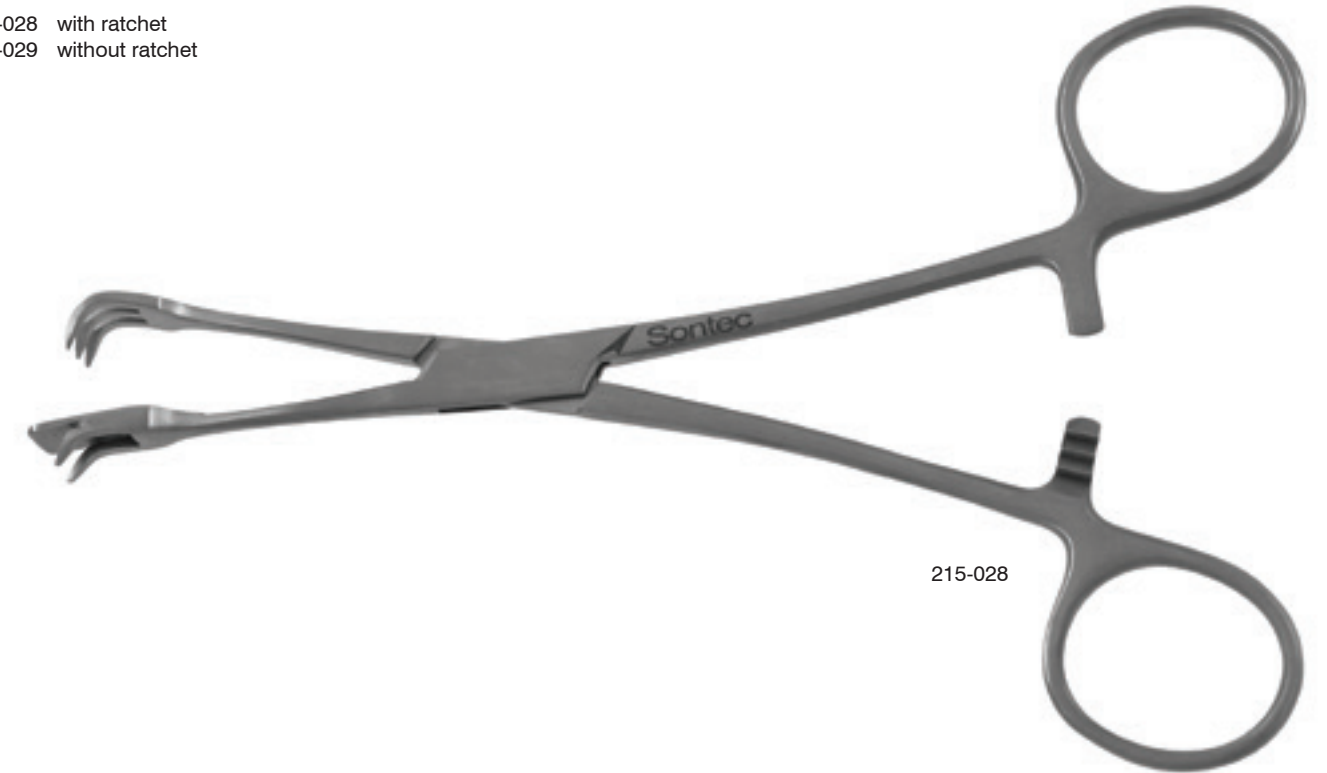

215-028

**Marten Face Lift Marker**

6 3/8" (16 cm)  
215-026 without ratchet  
215-027 with ratchet



215-027

**Pitanguy Marking Forceps**

6 1/2" (17 cm)  
475-846 serrated  
475-847 3 teeth



475-846



475-847

**Pitanguy Abdominal Marking Forceps**

12 1/2" (31.8 cm)  
475-849



475-849

**Tchalekian Mammary Marker Forceps**

11" (28 cm)  
475-842



475-842

**Pitanguy Rhytidoplasty Marking Forceps**

5 1/2" (14 cm)  
475-845



475-845

**Pitanguy Flap Grasping Forceps**

Integrating teeth / 5 1/2" (14 cm)

475-850



475-850

**Aiach-Gubisch Forceps**

6 1/4" (15.9 cm)

115-554



115-554

**Backhaus Towel Forceps**

- 117-500 3 1/2" (9 cm)
- 117-500L 3 1/2" (9 cm) left handed
- T117-500 3 1/2" (9 cm) titanium



117-500



117-500L

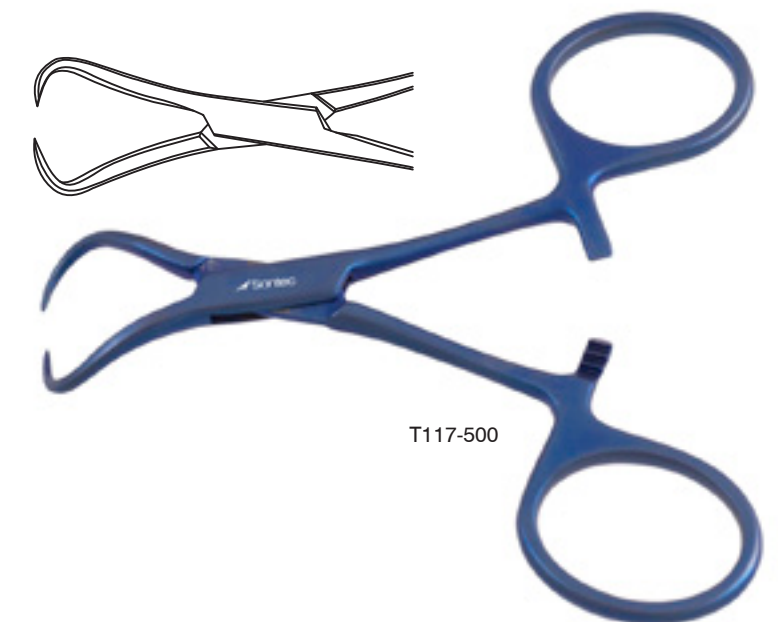

T117-500

**Backhaus Towel Forceps**

117-501 4 1/4" (10.8 cm)  
117-503 5 1/4" (13.5 cm)



117-501

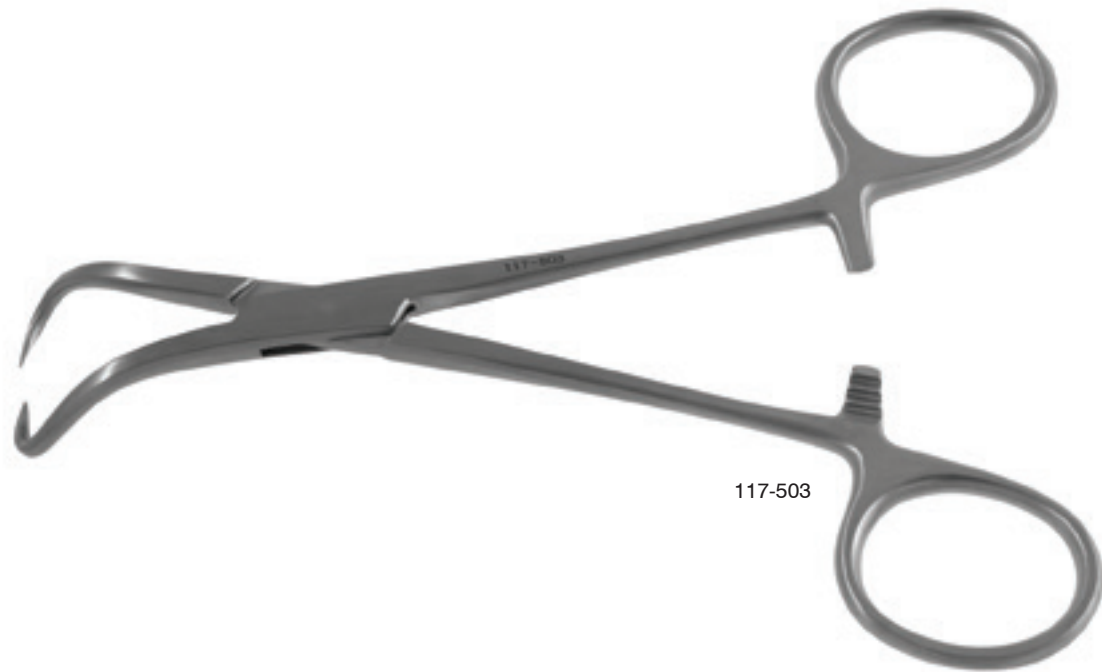

117-503

**Lorna-Edna Towel Forceps**

117-518 4" (10 cm)  
117-521 5 1/2" (14 cm)



117-518



117-521

**Tohoku Towel Forceps**

117-523 5 1/8" (13 cm)



117-523

**Peers Towel Forceps**

5 3/4" (14.6 cm)  
117-524

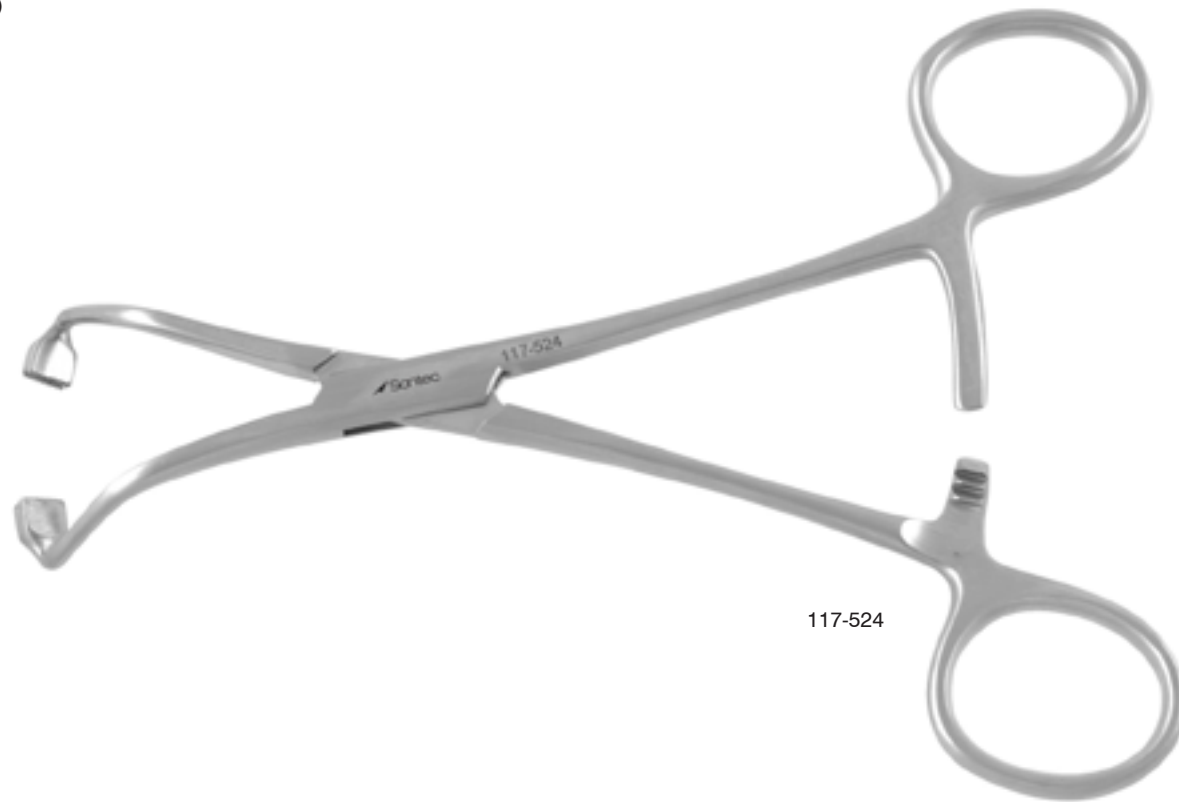

117-524

**Roeder Towel Forceps**

Beaded prongs / 5 1/4" (13.3 cm)  
117-506

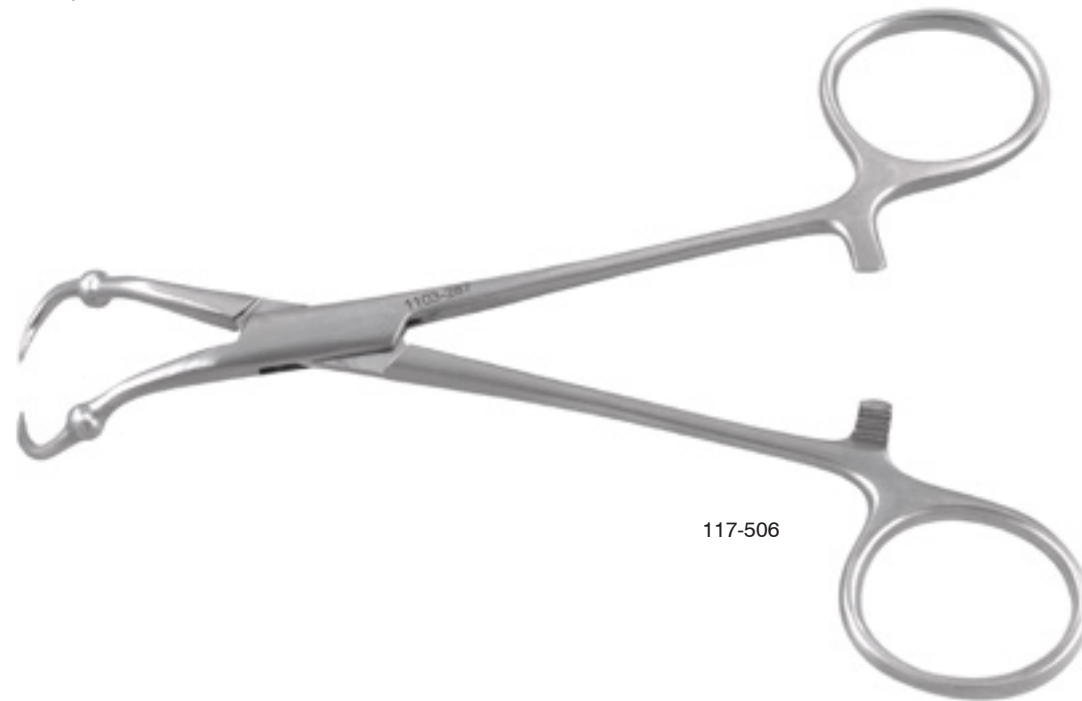

117-506

**Towel Clamp**

4 1/2" (11.4 cm)  
117-516 4 mm serrated disc  
117-517 8 mm serrated disc

Serrated / 5 1/4" (13.3 cm)  
1105-110 4 mm serrated disc

Serrated / 5 1/2" (14 cm)  
1105-112 8 mm serrated disc

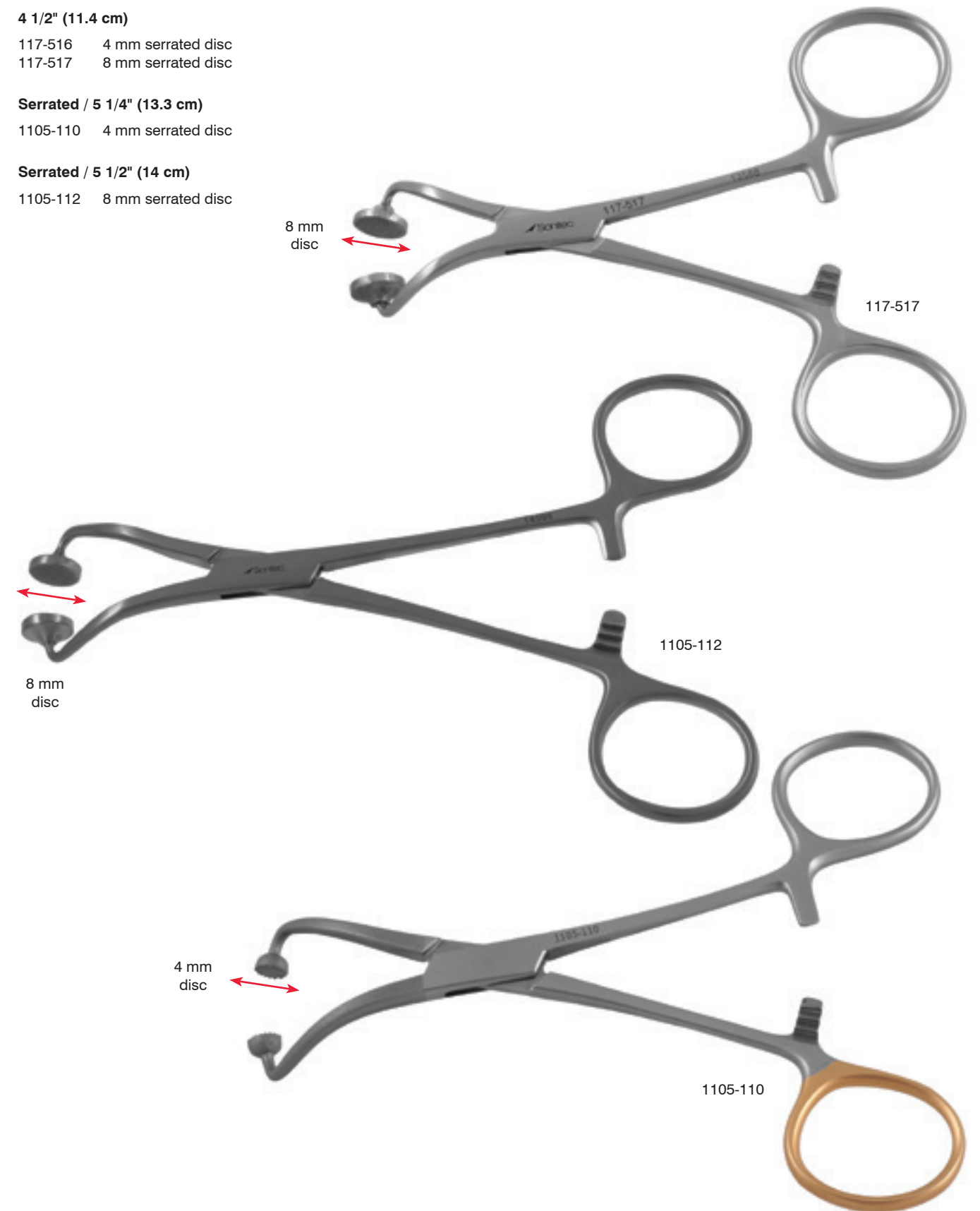

8 mm disc

117-517

8 mm disc

1105-112

4 mm disc

1105-110



 Sontec Instruments®

ENT CURETTES

**Meyerhoefer-Chalazion Curette**

5" (12.5 cm)

- 12-1285 0.5 mm
- 12-1290 1.0 mm
- 12-1300 1.5 mm
- 12-1310 1.75 mm
- 12-1320 2.0 mm
- 12-1355 2.5 mm
- 12-1360 3.0 mm
- 12-1365 3.5 mm
- 12-1367 4.0 mm
- 12-1368 4.5 mm

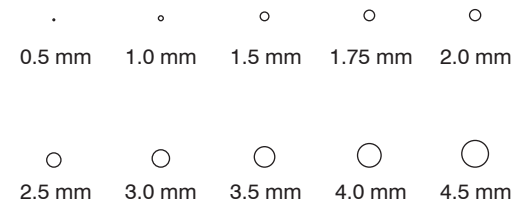

12-1368

**Shapleigh Ear Curette**

Serrated loop / 6" (15 cm)

- 467-430 small angled
- 467-431 small straight
- 467-432 large angled
- 467-433 large straight

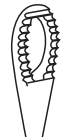

467-430



467-433

**Shapleigh Ear Curette**

Smooth loop / octagonal handle / 6" (15.2 cm)

- 467-434 small straight
- 467-4341 small angled
- 467-435 large straight
- 467-4351 large angled



467-434



467-4341



467-435

**Williger Curette**

Double-ended / 5 1/2" (14 cm) / str

- 467-4131 #0/1
- 467-4132 #00/0
- 467-4133 #1/2
- 467-4134 #3/4

Double-ended / 5 1/2" (14 cm) / each end angled 45°

- 467-4131A #0 / 1
- 467-4132A #00 / 0
- 467-4133A #1 / 2



66-0165

**Martini Bone Curette**

Double-ended / straight / 3mm/4mm / 5 1/2" (14 cm)

- 467-415



467-415

**Billeau Ear Loop/Curette**

6 1/2" (16.5 cm)

- 467-440XS extra small
- 467-440 small
- 467-438 medium
- 467-436 large

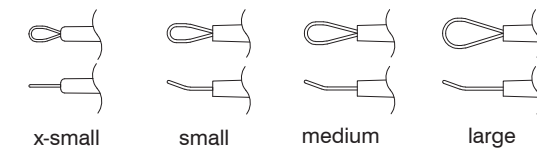

467-440

**House Curette**

**Double-ended / 5 3/4" (14.5 cm)**

199-133 both ends cvd 1.5 mm x 1.2 mm micro tip



**Double-ended / 6" (15 cm)**

199-132 one end angled, one end str 2.0 mm x 3.2 mm  
 199-129 both ends angled 2.0 mm x 3.5 mm  
 199-131 both ends str 2.0 mm x 3.5 mm



**Double-ended / 7" (18 cm)**

199-130 both ends angled 1.5 mm x 3.0 mm

**Double-ended / 9" (22.8 cm)**

199-136 both ends straight 2.0 mm x 3.5 mm



**Frontal Sinus Curette**

**7 1/2" (19 cm)**

320-769 straight  
 320-770 55°  
 320-771 90°



**Tholl Curette**

**Double ended / 1 round and 1 oval cups / 8 1/4" (21 cm)**

320-949



**Sontec® Excavator Curette**

**Single-ended / 5" (12.5 cm)**

199-300 1 mm  
 199-308 1 mm w/ hole  
 199-302 1.5 mm  
 199-310 1.5 mm w/ hole  
 199-304 2 mm  
 199-312 2 mm w/ hole  
 199-306 2.5 mm  
 199-314 2.5 mm w/ hole



**Double-ended / 5 1/2" (14 cm) / with hole**

199-320 1.5 mm / 2 mm  
 199-322 1.5 mm / 2.5 mm



**Buck Ear Round Handle Curette**

**Round Handle / str / blunt / 5 3/4" (14 cm)**

- 467-371 size 000
- 467-370 size 00
- 467-372 size 0
- 467-374 size 1
- 467-376 size 2
- 467-378 size 3



467-372

**Round Handle / str / sharp / 5 3/4" (14 cm)**

- 467-389 size 000
- 467-390 size 00
- 467-392 size 0
- 467-394 size 1
- 467-396 size 2
- 467-398 size 3

**Round Handle / angled / blunt / 5 3/4" (14 cm)**

- 467-379 size 000
- 467-380 size 00
- 467-382 size 0
- 467-384 size 1
- 467-386 size 2
- 467-388 size 3



467-380

**Round Handle / angled / sharp / 5 3/4" (14 cm)**

- 467-403 size 000
- 467-404 size 00
- 467-406 size 0
- 467-408 size 1
- 467-410 size 2
- 467-412 size 3

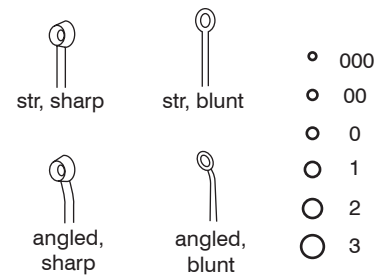

**Buck Ear Curette Hex Handle**

**Hex handle / str / blunt / 5 3/4" (14 cm)**

- 467-371S size 000
- 467-370S size 00
- 467-372S size 0
- 467-374S size 1
- 467-376S size 2
- 467-378S size 3



467-370S

**Hex handle / str / sharp / 5 3/4" (14 cm)**

- 467-389S size 000
- 467-390S size 00
- 467-392S size 0
- 467-394S size 1
- 467-396S size 2
- 467-398S size 3



467-398S

**Hex handle / angled / blunt / 5 3/4" (14 cm)**

- 467-379S size 000
- 467-380S size 00
- 467-382S size 0
- 467-384S size 1
- 467-386S size 2
- 467-388S size 3



467-386S

**Hex handle / angled / sharp / 5 3/4" (14 cm)**

- 467-403S size 000
- 467-404S size 00
- 467-406S size 0
- 467-408S size 1
- 467-410S size 2
- 467-412S size 3



467-406S

**Hex handle / straight / blunt / 6 1/2" (16.5 cm)**

- 467-372SL size 0
- 467-376SL size 2

**Hex handle / angled / blunt / 6 1/2" (16.5 cm)**

- 467-379SL size 000
- 467-380SL size 00
- 467-382SL size 0
- 467-384SL size 1
- 467-386SL size 2
- 467-388SL size 3



467-379SL

**Hex handle / angled / sharp / 6 1/2" (16.5 cm)**

- 467-410HL size 2



467-410HL

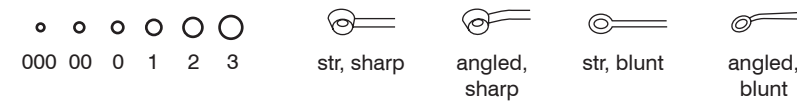



 Sontec Instruments®

GOUGES

**Brauer Rocking Nasal Chisel**

13 mm / 6 1/4" (15.9 cm)  
467-505

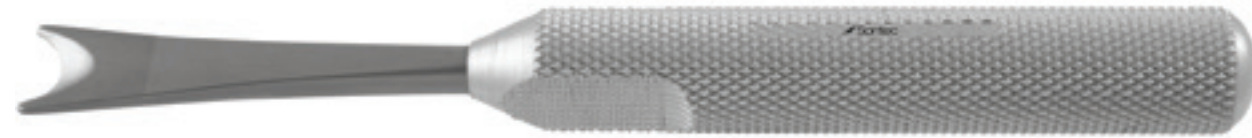

467-505

**Parkes Gouge**

6.5 mm / 7" (18 cm)  
330-051



330-051

**Killian-Claus Septum Gouge**

Bayonet / v-tip / 6 1/2" (16.5 cm)  
330-061



330-061

**Walter Meniscus Gouge**

7 1/2" (19.1 cm)  
330-070 3 mm  
330-072 5 mm  
330-074 12 mm

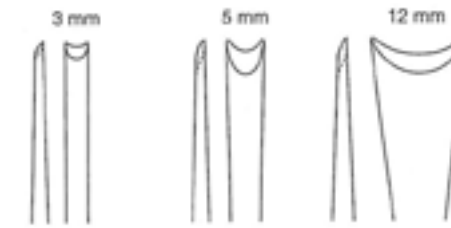

**Capener Lamina Cranked Gouge**

Bayonet / 9 1/2" (24 cm)  
330-054 6 mm  
330-058 11 mm  
330-056 13 mm



330-056

**Smith-Petersen Gouge**

**Straight / 8" (20.5 cm)**

- 330-630 6 mm (1/4") tip
- 330-631 9 mm (3/8") tip
- 330-632 13 mm (1/2") tip
- 330-633 16 mm (5/8") tip
- 330-634 19 mm (3/4") tip
- 330-635 25 mm (1") tip
- 330-636 32mm (1 1/4") tip



330-633

**Curved / 8" (20.5 cm)**

- 330-640 6 mm (1/4") tip
- 330-641 9 mm (3/8") tip
- 330-642 13 mm (1/2") tip
- 330-643 16 mm (5/8") tip
- 330-644 19 mm (3/4") tip
- 330-645 25 mm (1") tip
- 330-646 32mm (1 1/2")tip

**Cobb Type Spinal Gouge**

**11" (20.5 cm)**

- 330-650 straight
- 330-651 medium curve
- 330-652 strong curve
- 330-653 reverse curve



330-652

**Sontec Micro Gouge**

**5 1/2" (14 cm)**

- 475-803 3mm
- 475-804 4mm
- 475-805 5mm
- 475-806 6mm



475-803

**Mini Lexer Gouge**

**7" (18 cm)**

- 330-020 4 mm tip
- 330-021 6 mm tip
- 330-022 8 mm tip
- 330-023 10 mm tip
- 330-024 12 mm tip



330-024



330-023



**Lexer Gouge**

**8 3/4" (22.5 cm)**

- 330-030 7 mm tip
- 330-031 10 mm tip
- 330-032 15 mm tip
- 330-033 20 mm tip
- 330-034 25 mm tip
- 330-035 30 mm tip



330-033

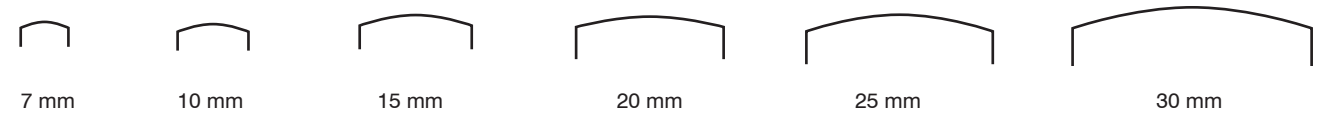

**Hibbs Gouge**

**Straight / 9 1/2" (24.1 cm)**

330-590	1/4"
330-591	3/8"
330-592	1/2"
330-593	5/8"
330-594	3/4"
330-595	7/8"
330-596	1"
330-597	1 1/8"
330-598	1 1/4"
330-599	1 1/2"



330-591

**Curved / 9 1/2" (24.1 cm)**

330-600	1/4"
330-601	3/8"
330-602	1/2"
330-603	5/8"
330-604	3/4"
330-605	7/8"
330-606	1"
330-607	1 1/8"
330-608	1 1/4"
330-609	1 1/2"

**Hibbs Chisel**

**Straight / 9 1/2" (24.1 cm)**

330-500	1/4"
330-511	3/8"
330-512	1/2"
330-513	5/8"
330-514	3/4"
330-515	7/8"
330-516	1"
330-517	1 1/8"
330-518	1 1/4"
330-519	1 1/2"



330-517

**Curved / 9 1/2" (24.1 cm)**

330-530	1/4"
330-531	3/8"
330-532	1/2"
330-533	5/8"
330-534	3/4"
330-535	7/8"
330-536	1"
330-537	1 1/8"
330-538	1 1/4"
330-539	1 1/2"

**Sontec Chisel**

**Curved / 7 1/4" (18.4 cm)**

330-460	7 mm
---------	------



330-460

**Straight / 7 1/4" (18.4 cm)**

330-462	6 mm
330-464	8 mm
330-466	10 mm
330-468	12 mm
330-470	16 mm
330-472	22 mm



330-464



330-466



330-468



330-470



330-472



 Sontec Instruments®

ENT Plastic OSTEOTOMES

**Neivert Anderson Guarded Osteotome**

With single guard / 8" (20 cm)

- 350-826 straight
- 350-826N straight narrow
- 350-824 curved right
- 350-824N curved right narrow
- 350-825 curved left
- 350-825N curved left narrow

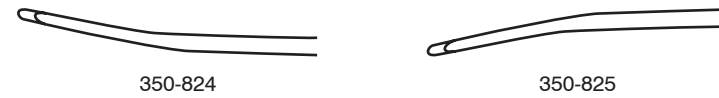

350-826



350-824N



350-825N

**Silver Guarded Osteotome**

With single guard / 7" (18 cm)

- 350-827 straight
- 350-829 curved right
- 350-828 curved left



350-828

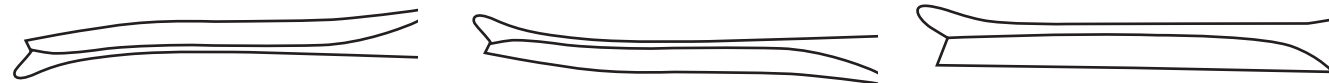

350-827

350-828

350-829

With single guards / 6 mm / 8" (20.3 cm)

- 475-794 straight
- 475-798 curved right
- 475-796 curved left

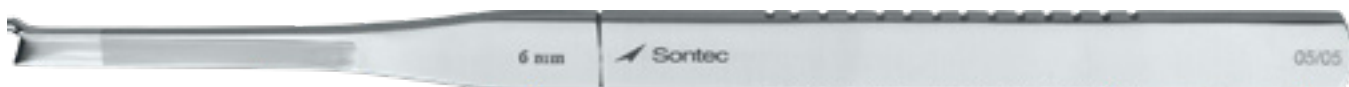

475-794



**Cinelli Guarded Osteotome**

With double guards / 6 1/4" (15.9 cm)

- 475-760 13/32" (10 mm)
- 475-762 15/32" (12 mm)
- 475-764 9/16" (14 mm)
- 475-766 5/8" (16 mm)



475-762

**Pitanguy U-Shaped Osteotome**

Semi-guarded / 8" (20 cm)

- 475-719 11/32" (9 mm)
- 475-722 15/32" (12 mm)
- 475-725 19/32" (15 mm)



475-719

**Brauer-Cottle Osteotome**

Graduated / cruciform / flat / 7 3/4" (19.7 cm)

- 475-734 5/32" (4 mm)
- 475-737 9/32" (7 mm)
- 475-739 11/32" (9 mm)
- 475-742 15/32" (12 mm)



475-737

**Rubin Rounded Corner Osteotome**

6 3/4" (17 cm)

- 475-750 13/32" (10 mm)
- 475-752 15/32" (12 mm)
- 475-754 9/16" (14 mm)
- 475-753 5/8" (16 mm)

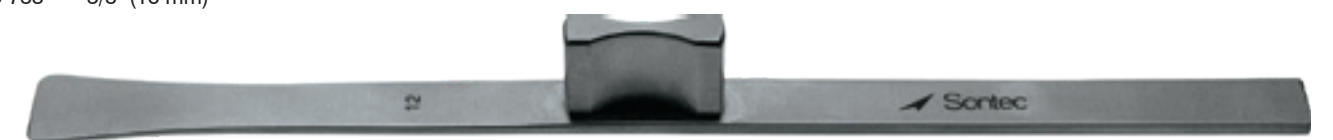

475-752

**Micro Plastic Surgery Osteotome**

With guide / with special guide pin / 7 1/4"

- 475-785G1 2.5 mm
- 475-785G2 3mm

No guards / straight / 8" (20 cm)

- 475-785A 2.5 mm
- 475-785B 3mm
- 475-785C 4mm
- 475-785D 6mm
- 475-785E 8mm
- 475-785F 10mm
- 475-785G 12mm
- 475-785H 14mm



**"V" Sontec® Osteotomes**

6" (15 cm)

- 478-768 (4 mm) upturned
- 478-770 (4 mm) downturned
- 478-772 (2 mm)
- 478-773 (3 mm)
- 478-774 (4 mm)
- 478-775 (5 mm)
- 478-776 (6 mm)
- 478-778 (8 mm)
- 478-780 (10 mm)
- 478-782 (12 mm)
- 478-785 (15mm)

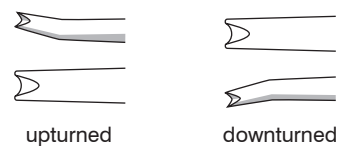

**Plastic Surgery Guarded Osteotome**

With single guard / straight / 8" (20.3 cm)

- 475-782 1/4" (6 mm)
- 475-783 5/16" (8 mm)
- 475-784 13/32" (10 mm)

With double guards / straight / 8" (20.3 cm)

- 475-775 13/32" (10 mm)
- 475-776 15/32" (12 mm)
- 475-777 9/16" (14 mm)
- 475-778 5/8" (16 mm)

With single guard / curved / 8" (20.3 cm)

- 475-768 5/16" (8 mm) right
- 475-769 5/16" (8 mm) left
- 475-770 13/32" (10 mm) right
- 475-771 13/32" (10 mm) left
- 475-772 15/32" (12 mm) right
- 475-773 15/32" (12 mm) left



With double guards / curved / 8" (20.3 cm)

- 475-779 13/32" (10 mm)
- 475-780 15/32" (12 mm)



**Alexander Osteotome**

Square serrated handle / straight / 7" (17.8 cm)

- 330-302 2 mm
- 330-303 3 mm
- 330-304 4 mm
- 330-305 5 mm
- 330-306 6 mm
- 330-308 8 mm
- 330-310 10 mm
- 330-312 12 mm
- 330-314 14 mm

**Plastic Surgery Osteotome**

Without guards / curved / 8" (20.3 cm)

- 475-790 5/16" (8 mm)
- 475-791 13/32" (10 mm)
- 475-792 15/32" (12 mm)



475-791

**Schrom Guarded Osteotome**

With guide / 3 mm / 7 3/4" (19.5 cm)

- 350-835ST straight
- 350-835LF curved for left side
- 350-835RT curved for right side

Black model / ceramic coated / with guide / 3 mm / 7 3/4" (19.5 cm)

- 350-835STB straight
- 350-835LFB curved for left side
- 350-835RTB curved for right side



350-835ST



350-835LF



350-835LFB



350-835RTB

**Alexander Osteotome**

Square serrated handle / straight / 7" (17.8 cm)

- 330-302 2 mm
- 330-303 3 mm
- 330-304 4 mm
- 330-305 5 mm
- 330-306 6 mm
- 330-308 8 mm
- 330-310 10 mm
- 330-312 12 mm
- 330-314 14 mm



330-302

**Cook Guarded Osteotome**

Right / upward / 6 1/2" (16.4 cm)

- 478-789 2 mm
- 478-788 3 mm
- 478-791 4 mm



478-788

Left / upward / 6 1/2" (16.4 cm)

- 478-790 2 mm
- 478-787 3 mm
- 478-792 4 mm

**Cakir Osteotome**

V-shaped blade / straight / 3 mm tip / 7" (18 cm)

- 475-787



475-787

**Famous Gubisch Nasal Osteotome**

Straight / delicate / 4 mm tip size / 7 3/4" (20 cm)

- 475-789



475-789

**Sontec® Pattern Plastic Osteotome**

7" (18 cm)

330-482	3/32" (2 mm)
330-483	1/8" (3 mm)
330-484	5/32" (4 mm)
330-485	6/32" (5 mm)
330-486	1/4" (6 mm)
330-487	9/32" (7 mm)
330-488	5/16" (8 mm)
330-489	11/32" (9 mm)
330-490	13/32" (10 mm)
330-491	7/16" (11 mm)
330-492	15/32" (12 mm)
330-495	19/32" (15 mm)



330-482

**Rees Osteotome**

Knurled aluminum handle / 7 3/4"

475-711	1/8" (3 mm)
475-712	5/32" (4 mm)



475-712

**Sontec Nasal Dorsum Osteotome**

With double guard blade / 6 7/8" (17 cm)

475-731	12mm
475-732	14mm



475-731



475-732

**Sontec Nasal Tip Cartilage Punch**

With handle / 4" (10 cm)

475-729	heart shaped
475-730	figure 8 shaped



475-729



475-730

**Sontec Osteotome**

Round Handle with disc end / 6 7/8" (17 cm)

475-743	2 mm
475-744	3 mm



475-743



475-744

**Sontec Intranasal Osteotome**

7" (18 cm)

475-745	4mm
475-746	7mm



475-745



475-746

**Sontec Type Lateral Osteotome**

With guard / 8" (20 cm)

- 475-747 curved left 4 mm
- 475-748 curved right 4 mm



**Cottle Gubisch Chisel**

Sloped chiseled tip and blade / 7" (18 cm)

- 475-800 5 mm
- 475-802 12 mm



**Blume Osteotome**

Curved / with guide / 7" (18 cm)

- 475-758 6 mm



**Obwegeser Ramus Osteotome**

Curved / 8 mm / 8 1/4" (21 cm)

- 475-749



**Epker Type Osteotome**

1.2 mm tip / 7" (18 cm)

- 330-320 straight 4 mm
- 330-322 straight 6 mm
- 330-324 straight 8 mm
- 330-326 slight curve 4 mm
- 330-330 slight curve 6 mm
- 330-336 full curve 6 mm
- 330-338 full curve 8 mm



**Walter Osteotome**

straight / 2 mm / 7 1/2"

- 475-810





 Sontec Instruments®

ENT Plastic ELEVATORS

**Woodson Elevator**

7 1/8" (18.1 cm)  
412-571



**Joseph Periosteal Elevator**

Curved / 6 3/4" (17 cm)

- 16-2207 3 mm
- 16-2208 3.5 mm
- 16-2209 4 mm
- 16-2210 5 mm
- 16-2200 6.5 mm



**Killian Elevator**

Double-ended / 7 1/4" (18.4 cm)  
412-536



**Masing Elevator / Dissector**

Double-ended / curved / octagonal handle / 7 7/8" (19.75 cm)  
412-575

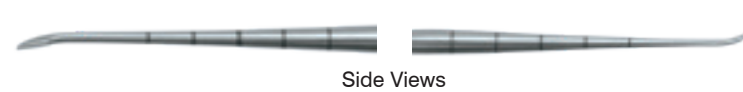

**Sontec-Masing Septal Dissector**

Double-ended / curved/curved / 8 1/4"  
467-535



**Sontec S.P.T. Elevator**

Round handle/ double-ended / curved / sharp / 8 1/4" (21 cm)  
412-583



**McKenty Elevator**

Semi-sharp / curved / 5 1/2" (14 cm)

- 412-5563 3 mm tip
- 412-556 4 mm tip
- 412-557 5 mm tip



Double-ended / curved / 8 1/2" (21.75 cm)

412-555



**Roger Elevator**

Double-ended / full curve / 7 1/4" (18.5 cm)  
412-558



**Mcdonald Elevator**

Double-ended / 7 1/2" (19 cm)  
412-585



**Freer Periosteal Elevator**

Double-ended / square handle / straight / 4.5 mm tip / sharp/blunt / 7 3/4"

1100-798S

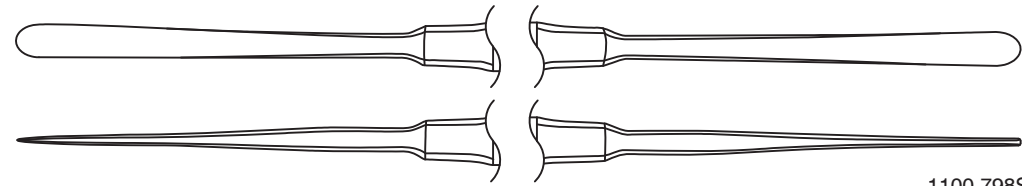

1100-798S

Double-ended / square handle / curved / 4.5 mm tip / sharp/blunt

1100-798 7 3/4"

1100-798G 8 1/2"

1100-798F 8 3/4"



1100-798

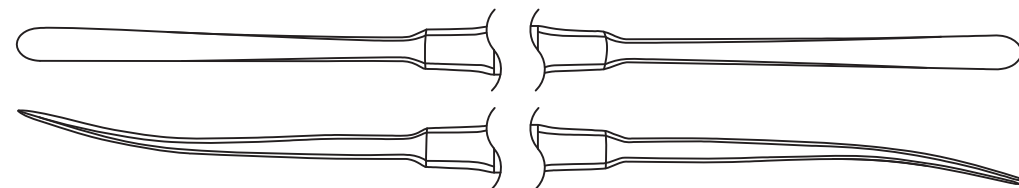

Double-ended / square handle / curved / 6.5 mm tip / sharp/blunt

1100-798A 7 3/4"

1100-798E 8 3/4"



1100-798A

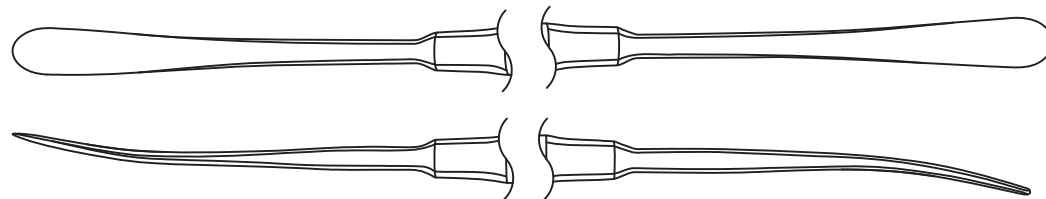

**Freer Periosteal Elevator**

Double-ended / round handle / curved / sharp/blunt / 7 1/2"

1100-798B 5 mm tip

1100-798C 6.7 mm tip



1100-798B

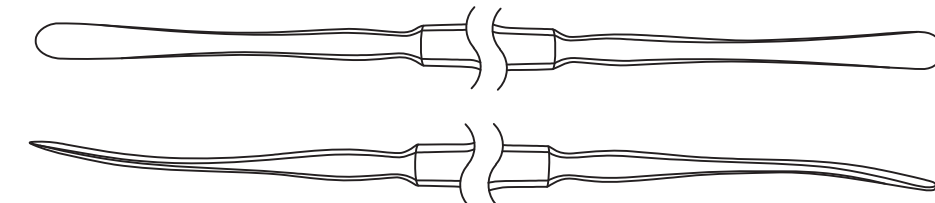

1100-798C

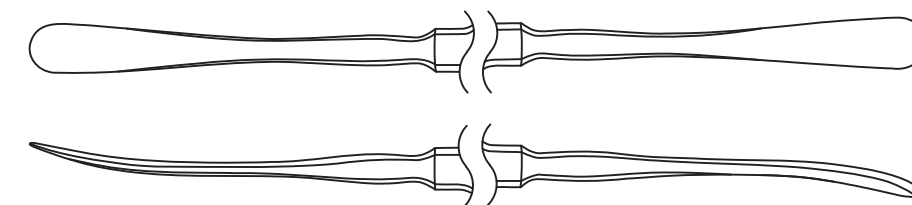

Double-ended / knurled round handle / curved / 4.5 mm tip / sharp/blunt / 6 3/4"

1100-798D



1100-798D

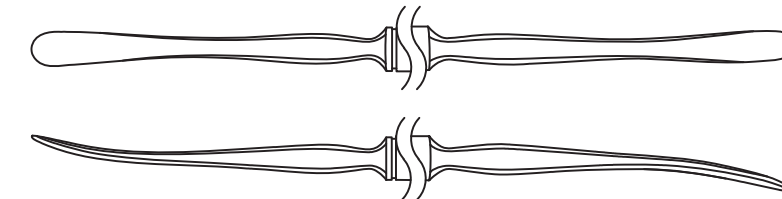

**Freer Elevator / Mucosa Knife Round Handle 4.5 mm**

Double-ended / 4.5 mm / 7 3/4" (19.5 cm)  
468-163



468-163

**Freer Elevator / Packer**

Double-ended / 4.5 mm / 7 3/4" (19.5 cm)  
468-165



468-165

**Joseph Massing Elevator**

Bayonet shaft / 8" (20 cm)  
335-105



335-105

Straight / 6 mm / 8" (20.3 cm)  
335-106



335-106

**Pennington Elevator**

Double-ended / 8 1/4" (21 cm)  
412-580



412-580

**House Ear Elevator**

1 mm tip / 6 1/4" (16 cm)  
468-140



468-140

**Cottle Elevator**

Slight curve / 9 mm tip  
/ 7 1/2" (19 cm)  
412-527



412-527

**Boies Nasal Fracture Elevator**

9 mm / wide tip blunt / 7 1/2" (19.1 cm)  
345-315



345-315

**Sontec® Cottle Elevator**

Double-ended / sharp & blunt /  
graduated / 8 1/4" (21 cm)  
1271-302



1271-302

**Sesamoid Cottle Elevator**

Strong curve / double-ended / 9" (23 cm)  
1271-310



1271-310

**CSU Cottle Elevator**

Double-ended / graduated /  
9" (23 cm)  
1271-300 blunt  
1271-301 sharp



1271-300

**Cottle Daniel Raspatory/Packer**

Double-ended / 8 1/2" (22 cm)  
1271-309



1271-309

**Daniel-Gubisch Raspatory/Rasp**

Double-ended / rasp-elevator / 8 1/2" (22 cm)  
1271-307



1271-307

**Sontec® Septum Elevator / Probe**

Double-ended / with ball tips / 7" (18 cm)  
468-150



468-150

**Barns Septum Elevator**

Double-ended / 7 3/4" (19.5 cm)  
467-532 60° disc end/60° 4.5 mm elevator end  
467-533 disc end/4.5 mm Freer end



467-532



467-533

**Maxillary Ostium Elevator / Probe**

Double-ended / with ball tips / 8 1/4" (21 cm)  
468-160



468-160

**Ostium Burnisher Elevator**

Ball #42 / 1.9 & 1.2mm diameters /  
double-ended / 6 1/2" (16 cm)  
1102-BR42



1102-BR42

**Cleft Palate Elevator**

Double-ended / with perpendicular  
blades / 6 1/4" (18 cm)  
478-395



**Cronin Cleft Palate Elevator / Dissector**

Rounded-blunt tip / 7" (18 cm)  
478-402 small  
478-405 medium  
478-400 large



478-402

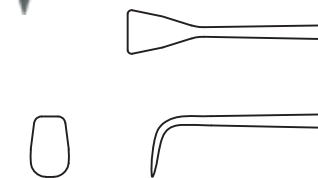

478-405

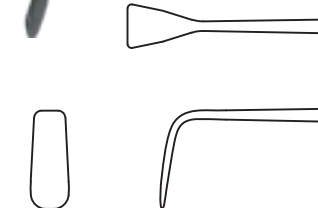

478-400

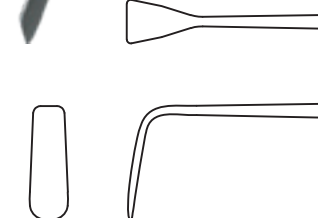

**Frontal Ostium Sound Elevator**

Double-ended w/ ball tips / 90 deg ang & cvd tips / 8 1/2" (21.5 cm)

468-161



468-161

**Lempert Elevator**

7 1/2" (19 cm)

412-519



412-519

**Sontec Forehead Lifter**

207-960	scalp	half curve	8 1/2" (21.5 cm)
207-961	scalp	quarter curve	9 3/4" (25 cm)
207-963	scalp	strong half curve	9 3/4" (25 cm)
207-966	orbital rim dissector	half curve	9 3/4" (25 cm)



207-960



207-961



207-963



207-966

**Endoscopic Forehead Lifter**

6 1/2" (16.5 cm) working length

- 207-950 set includes:  
 207-951 #1  
 207-952 #2  
 207-953 #3  
 207-954 #4  
 207-955 #5  
 207-956 #6  
 207-957 #7



207-951



207-952



207-953



207-954



207-955



207-956



207-957

**Forehead Lifting Elevator / Dissector**

Video endoscopic dissector / ergonomic lamb handle / 6 1/2" (16.5 cm) working length

- 207-921 #1 12 1/2" (30.5 cm)
- 207-922 #2 15 1/4" (39 cm)
- 207-923 #3 15 1/8" (38.8 cm)
- 207-924 #4 13" (33 cm)



207-921



207-922



207-923



207-924

**Zoellner Micro Ear Surgery Set**

Uniquely designed handle / 3 1/4" (8 cm)

Tip	Item #	Description
	68-1100	hook, 1.0 mm point, 90° angled down
	68-1102	hook, 1.0 mm point, 90° angled up
	68-1103	hook, 1.0 mm point, 60° angled down
	68-1104	hook, 1.0 mm point, 60° angled up
	68-1105	hook, 0.5 mm point, 45° angled down
	68-1106	hook, 0.5 mm point, 45° angled up
	68-1107	hook, 1.0 mm point, curved down
	68-1108	hook, 1.0 mm point, curved up
	68-1150	needle, straight, sharp point
	68-1120	round knife, 3.0 mm long, 45°, angled down
	68-1121	round knife, 3.0 mm long, 45°, angled up
	68-1131	elevator, 2.0 mm wide, curved down
	68-1132	elevator, 2.0 mm wide curved up
	68-1165	sickle knife, 5.0 mm, long, curved up
	68-1166	sickle knife, 5.0 mm, long curved down
	68-1170	spear-pointed needle, 5.0 mm long, curved to left
	68-1171	spear-pointed needle, 5.0 mm long, curved to right
	68-1180	raspatory, 2.0 mm wide, curved to left
	68-1181	raspatory, 2.0 mm wide, curved to right

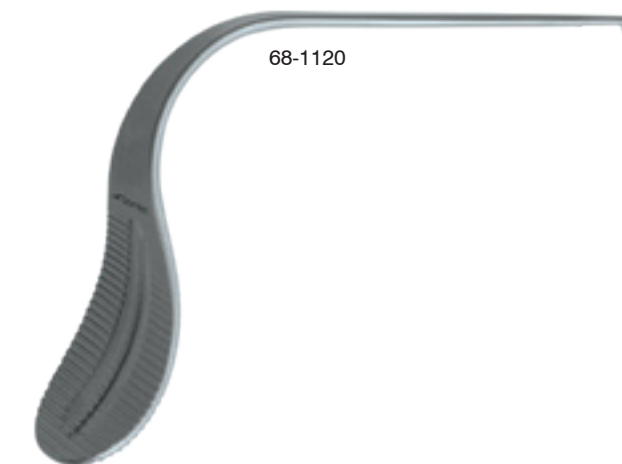

68-1120



68-1166

**Doyen Raspatory**

**Large 3.5 cm / 6 1/2" (16.5 cm)**

- 430-380 left
- 430-382 right
- 430-383 right delicate

**Small 2.5 cm / 6 1/2" (16.5 cm)**

- 430-384 left
- 430-386 right

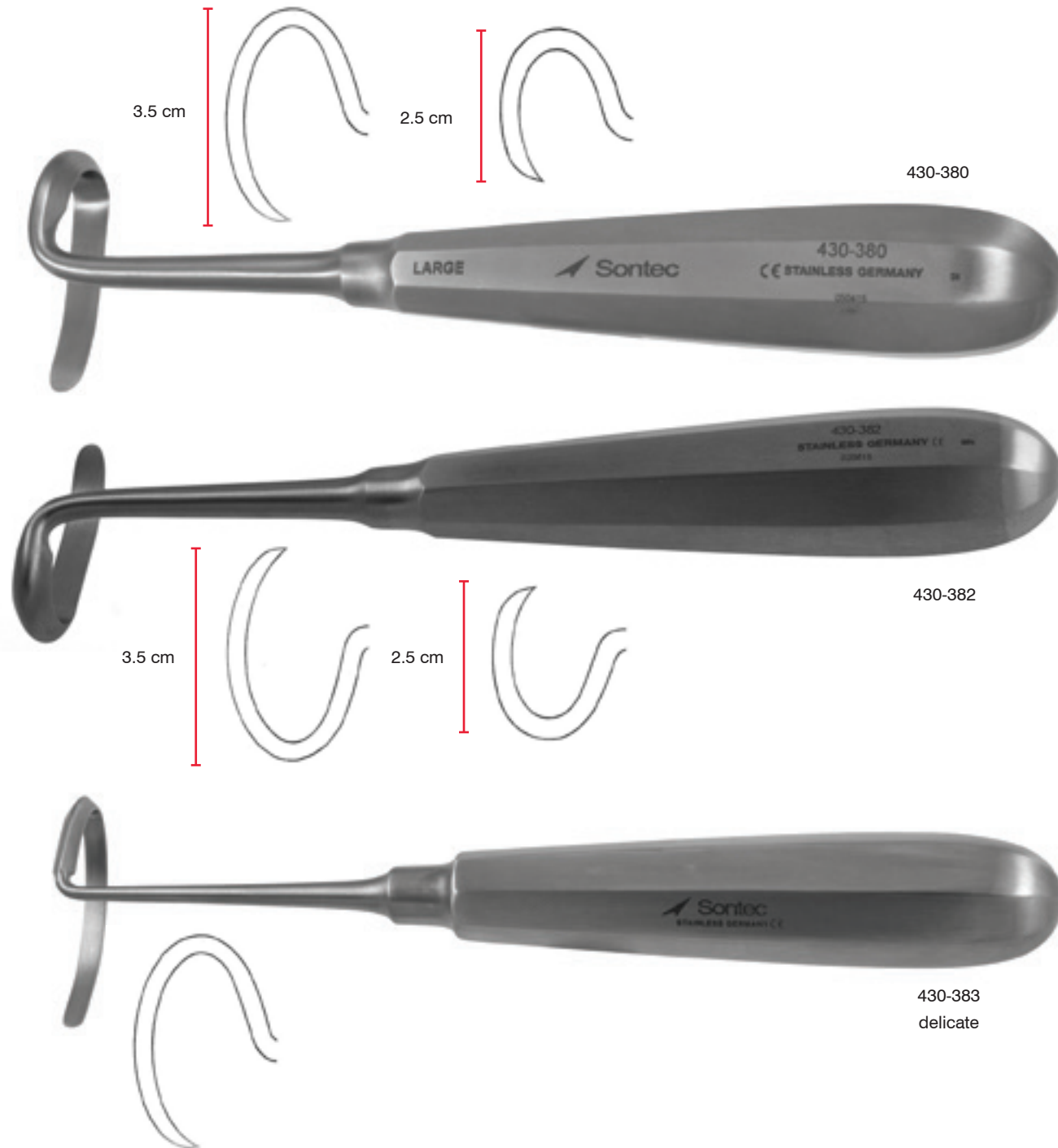

**Daniel Gubisch Rib Raspatory**

**6 3/4" (17.1 cm)**

- 430-378 right
- 430-379 left

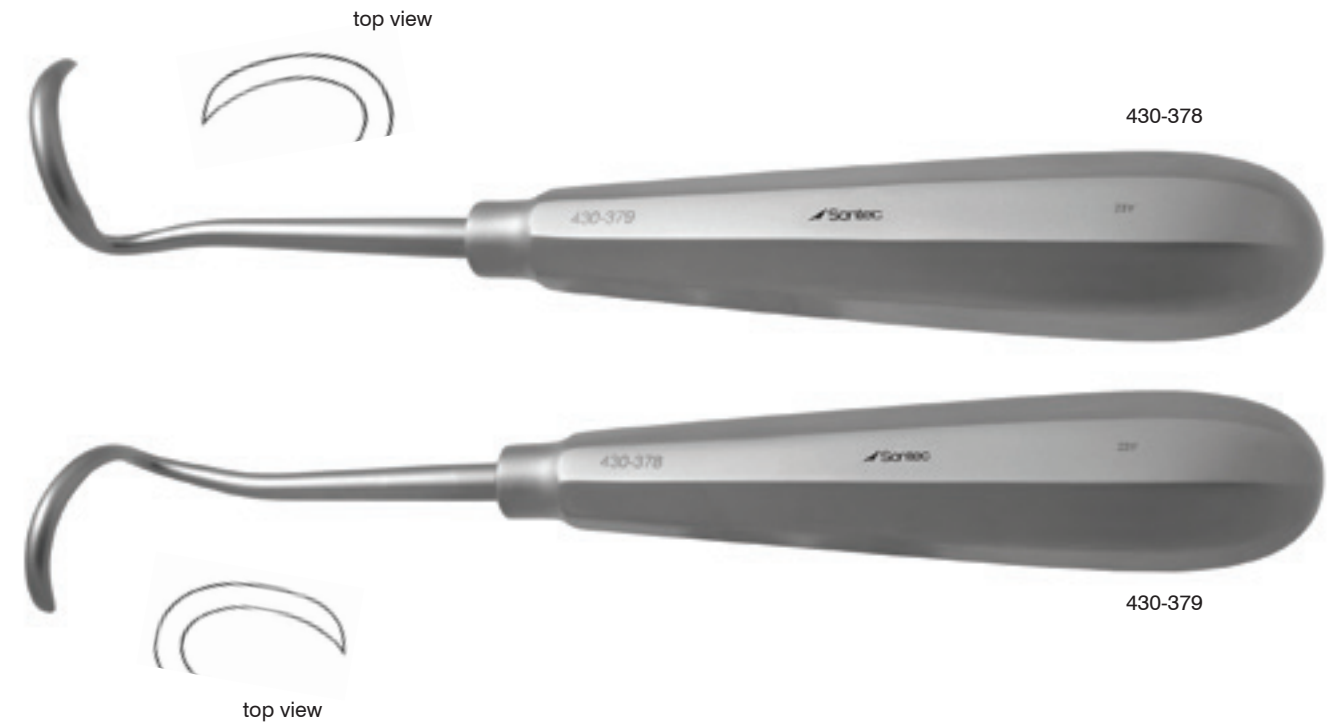

**Obwegeser Mandib Raspatory**

**6 3/4" (17.1 cm)**

- 430-375 right
- 430-376 left



**Sontec A O Type Elevator / Raspatory**

Phenolic handles / 7 1/2" (19 cm)

335-250	6 mm tip	str	flat edge
335-254	3 mm tip	slight curve	round edge
335-255	3 mm tip	slight curve	flat edge
335-260	6 mm tip	slight curve	flat edge
335-265	6 mm tip	slight curve	round edge

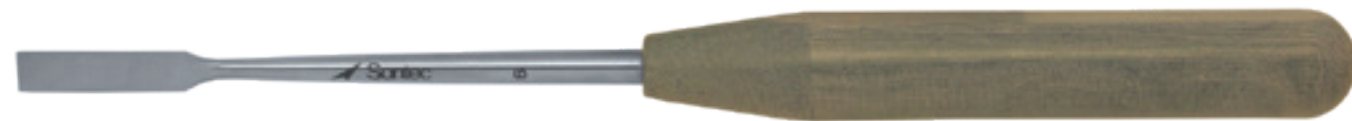

335-250



335-255



335-260

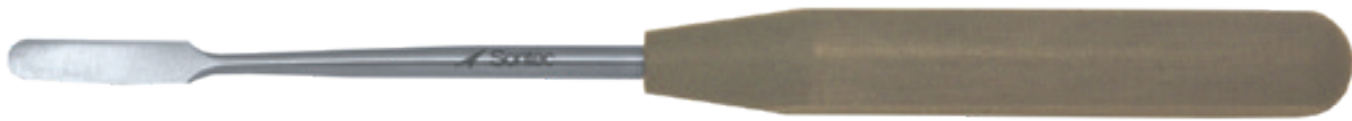

335-265

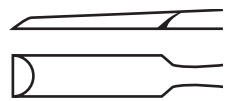

335-250



335-255



335-260



335-265

**Sontec A O Type Elevator / Raspatory**

Phenolic handles / 8" (20 cm)

335-270	13 mm tip	angled	flat edge
335-275	14 mm tip	str	round edge
335-280	14 mm tip	cvd	round edge
335-285	20 mm tip	str	round edge



335-270



335-275



335-280



335-285

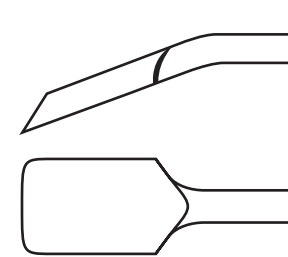

335-270

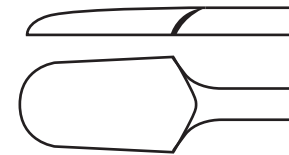

335-275

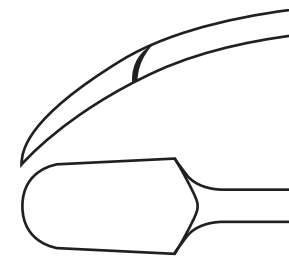

335-280

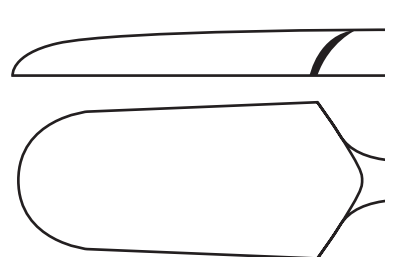

335-285



 Sontec Instruments®

ENT Plastic SUCTION ELEVATORS

**Pitanguy Raspatory Elevator With Suction**

7" (17 cm)

- 412-667A 2.5 mm
- 412-667B 3 mm
- 412-667D 3.5 mm
- 412-667C 4 mm



**Elevator With Suction**

7 1/4" (18.4 cm)

2700-320



**Daniel Endoscopic Forehead Elevator**

9 1/4" (23.5 cm)

478-370 slight curve with suction



**Pitanguy Elevator With Suction**

Blunt / 8" (20 cm)

475-855



**Haraldsson Elevator with Suction**

Distal tube connection swivels / 7 1/2" (19 cm)

478-360



**Gorney Elevator With Suction**

7 3/4" (20 cm)

478-375



**Gubisch Suction Elevator**

Straight

478-380 6"

478-382 8" bayonet





 Sontec Instruments®

ENT SPECULUMS

**Tieck-Halle Infant Nasal Speculum**

5 3/4" (14 cm)

16-2330 stainless  
16-2332 ebonized



16-2330

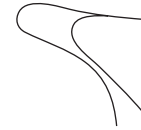

**Sonnenschein Nasal Speculum**

6" (15.2 cm)

465-320



465-320

**Killian Septum Speculum**

5 1/2" (14 cm)

465-309 2" thin low profile blades  
465-311 2 1/2" thin low profile blades  
465-313 3" thin low profile blades



465-321

**Killian Nasal Speculum**

Fixation screw / with universal fiber  
optic light guide / 5 1/4" (13.5 cm)

465-321 35mm  
465-322 50mm  
465-323 75mm



465-321



465-322



465-323

**Killian Nasal Speculum**

With universal fiber optic light guide / 85 mm / 5 1/2" (14 cm)

465-325



465-325

**Modified Cottle Speculum**

Tapered thin wide blades / 6" (15 cm)

16-2365 2" thin low profile blades



16-2365

**Cottle Speculum**

X-delicate / 5 1/2" (14 cm)

465-301 50 mm



465-301

**Cottle Septum Speculum**

Includes screw set / ebony finish / very thin blades / complete black / 5 3/4" (14 cm)

- 465-299 35 mm
- 465-300 50 mm
- 465-302 75 mm
- 465-304 100 mm



465-300

Includes screw set / ebony finish / narrow blades / 6" (15.2 cm)

- 16-2368 35 mm
- 16-2372 50 mm
- 16-2374 75 mm
- 16-2376 90 mm



16-2372

**Pashley Nasal Speculum Set**

12 mm gap / one long blade & one short blade / 5 1/2" (14 cm) / 68 mm x 8.5 mm blade / adult

- 1463-118 right
- 1463-120 left

12 mm gap / one long blade & one short blade / 5 1/2" (14 cm) / 65 mm x 6 mm blade / pediatric

- 1463-119 right
- 1463-117 left

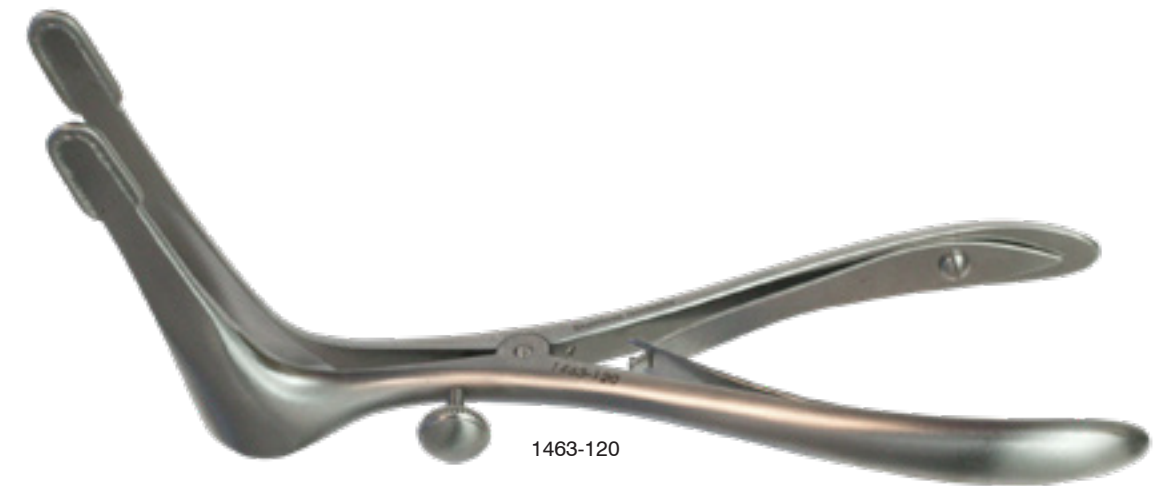

1463-120

### Hartmann Ear Specula

Set of three (3 mm, 4 mm, 5 mm)

465-225

Set of four (4 mm, 5 mm, 6 mm, 7 mm)

465-227

Also available individually

- 465-225-3 3mm
- 465-225-4 4mm
- 465-225-5 5mm
- 465-225-6 6mm
- 465-225-7 7mm



465-225

### Boucheron Ear Specula Chrome

Chrome / set of four

- 465-210 size 1-4
- 465-220 size 5-8

Also available individually

- 465-210-1 size 1
- 465-210-2 size 2
- 465-210-3 size 3
- 465-210-4 size 4
- 465-220-5 size 5
- 465-220-6 size 6
- 465-220-7 size 7
- 465-220-8 size 8

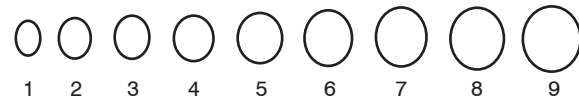

465-210

### Gruber Ear Specula

Oval / standard adult sizes / long pattern / chrome

- 465-241 size 1 4 mm x 5 mm
- 465-242 size 2 5 mm x 6 mm
- 465-243 size 3 6 mm x 7 mm
- 465-244 size 4 7 mm x 8 mm

Set of four

465-240 size 1-4

Oval / standard child sizes / long pattern / chrome

- 465-251 size 1 2 mm x 3 mm
- 465-252 size 2 3 mm x 4 mm
- 465-253 size 3 4 mm x 5 mm
- 465-254 size 4 5 mm x 6 mm

Set of four

465-250 size 1-4

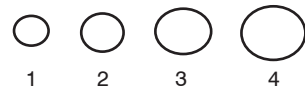

465-240

### Farrior Ear Specula

Oval / angled end / non-glare stainless

- 465-231 size 1 3 x 4 mm
- 465-232 size 2 4 x 5 mm
- 465-233 size 3 4.5 x 5.5 mm
- 465-234 size 4 5 x 6 mm
- 465-235 size 5 5.5 x 6.5 mm
- 465-236 size 6 6 x 7 mm
- 465-237 size 7 6.5 x 7.5 mm
- 465-238 size 8 7 x 8 mm
- 465-239 size 9 7.5 x 8.5 mm
- 465-2310 size 10 8.5 x 9.5 mm

Oval / angled end / black

- 465-231B size 1 3 x 4 mm
- 465-232B size 2 4 x 5 mm
- 465-233B size 3 4.5 x 5.5 mm
- 465-234B size 4 5 x 6 mm
- 465-235B size 5 5.5 x 6.5 mm
- 465-236B size 6 6 x 7 mm
- 465-237B size 7 6.5 x 7.5 mm
- 465-238B size 8 7 x 8 mm
- 465-239B size 9 7.5 x 8.5 mm

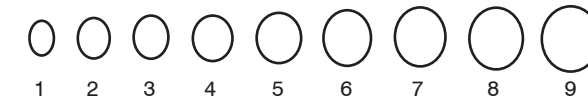

465-237

### Farrior Ear Specula

Round / black / partial opening

- 465-260 set of all 4 below
- 465-262 4 mm
- 465-264 5 mm
- 465-266 6 mm
- 465-268 7 mm

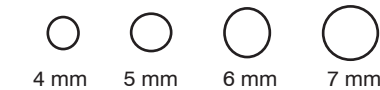

465-262

### Farrior Ear Specula

Round / black / full opening

- 465-270 set of all 4 below
- 465-272 4 mm
- 465-274 5 mm
- 465-276 6 mm
- 465-278 7 mm

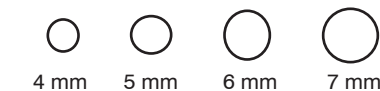

465-272

**Sewall Tongue Depressor**

13 x 67 mm / 6 1/2" (16.5 cm)

485-422 13 x 67 mm



485-422

**Bruenings Tongue Depressor**

7 1/2" (19 cm)

485-476 13 x 67 mm



485-476

**Doyen Tongue Depressor**

5" (12.7 cm)

485-479



485-479

**Wieder Tongue Depressor**

With a widely-flared depressing / surface for increased traction and visibility / 5 1/2" (14 cm)

- 485-590 small 30 mm wide
- 485-592 large 35 mm wide
- 485-592S large 35 mm wide with suction



485-592S

**Dingman Mouth Gag Set**

Adjustable upper retractor blades and cheek retractors / complete with three grooved tongue blades

485-500-SET frame and 3 tongue blades

Blades also sold individually

485-501 small 24mm x 52mm  
 485-502 medium 28mm x 55mm  
 485-503 large 30mm x 68mm



485-500-SET



485-501



485-501



485-502



485-503

**Mclvor Mouth Gag Set**

7 1/4" (18.5 cm)

485-580 set with frame and 3 blades

485-582 frame only

485-584 small blade size 1 blade 1 x 2 1/2"

485-586 medium blade size 2 blade 1 x 3 1/2"

485-588 large blade size 3 blade 1 x 4"



485-584

485-582

**Jennings Mouth Gag**

- 485-510 infant 3 1/2" spread
- 485-512 small 4 1/4" spread
- 485-514 medium 5" spread
- 485-516 large 6" spread



485-510



485-512



485-514



485-516

**Davis Mouth Gag Frame**

- 485-528 left side bite
- 485-530 right side bite
- 485-584 blade
- 485-594 blade

\*frames sold separately from blades



485-528



485-530



485-584



485-594



 Sontec Instruments®

ENT Plastic HOOKS

**Sontec Tissue Twist Hook**

5 1/2" (14 cm)  
199-372



199-372

**Frazier Skin Hook**

5" (12.5 cm)  
199-380 sharp  
199-382 blunt



199-380

**Hartman Ear Hook**

6 1/4" (15.9 cm)  
467-441



467-441

**Tyrell Skin Hook**

5" (12.5 cm)  
199-385 sharp  
199-387 blunt



199-385

**Gillies Skin Hook**

7" (18 cm)  
199-390 large  
199-391 small



199-391

**Gillies Skin Hook Titanium**

Small / sharp / 6 1/2" (16.5 cm)  
199-384T

Large / sharp / 6 1/4" (15.9 cm)  
199-3841T



199-384T

199-3841T

**Cottle Double Skin Hook**

Sharp / 5 1/2" (14 cm)  
199-394



199-394

**Cottle Skin Hook**

5 1/2" (14 cm)  
199-393A angled  
199-393B shallow curve  
199-393C deep curve



angled shallow curve deep curve

6 1/4" (15.9 cm)  
199-392 angled  
199-392A angled 180°



199-393C

199-392

199-392A

**Cottle Skin Hook Titanium**

Angled 180° / 17.5 cm / 7" (17.8 cm)  
199-392T



199-392T

**Cottle Skin Hook Titanium**

Angled 180° / 6 1/4" (15.9 cm)  
199-3921T



199-3921T

**Freer Double Skin Hook**

2.5 mm wide / 6" (15 cm)  
199-395 sharp  
199-396 blunt



199-395

**Sontec Freer Skin Hook Titanium**

Flat handle / 2 sharp prongs / 3 mm wide / 6" (15 cm)  
199-402T



199-402T

**Sontec Freer Double Skin Titanium**

Flat handle / 2 blunt prongs / 3 mm wide / 6" (15 cm)

199-401T



199-401T

**Sontec® Skin Hook**

Sharp / 2 mm prong / 4 3/4" (12 cm)

199-400



199-400

**Sontec® Skin Hook Titanium**

Ergonomic flat handle/ small / 5" (12.7 cm)

199-470T



199-470T

**O' Connor Skin Hook**

4 3/4" (11.5 cm)

199-406



199-406

**O' Connor Skin Hook Titanium**

1 sharp prong / 4 3/4" (11.5 cm)

199-406T



199-406T

**Guthrie Skin Hook**

Sharp / 5" (12.5 cm)

199-410 1.5 mm wide

199-411 2.5 mm wide large



199-410

**Guthrie Hook Titanium**

Flat handle / 2 sharp prongs / 5" (12.7 cm)

199-412T 3 mm

199-413T 3 mm

199-4131T 2 mm



199-412T



199-413T



199-4131T

**Seltzer Dermal Biopsy Hook**

Sharp / 4 1/2" (11.4 cm)

199-405



199-405

**Day Ear Hook**

6 3/4" (17 cm)

467-443 small

467-445 large



467-445

**Gross Ear Hook & Spoon**

5 1/4" (13 cm)

467-448



467-448

**Allport Muscle Hook**

6 3/4" (17 cm)

468-155



468-155

**Allport Mastoid Searcher**

With ball tip / 6 1/2" (16.5 cm)

468-156



468-156

**Pashley Hook**

Probe with round handle / 6 1/2" (16.5 cm)

1197-673 right angle hook  
1197-675 malleable hook



1197-673



1197-675

**Sontec Hook Probe Titanium**

90° angle / 1.8 mm x 9 mm / 8" (20.3 cm)

2700-506



2700-506

**Converse Skin Hook**

Single-ended / aluminum Handle / 6" (15 cm)

475-100 small  
475-101 medium  
475-102 large  
475-104 straight small  
475-103 straight large



475-100



475-101



475-102



475-103



475-104

**Kleinert-Kutz Skin Hook**

5" (12.5 cm)

475-136 small 3 mm diameter  
475-137 medium 5 mm diameter  
475-138 large 7 mm diameter



475-136



475-138

**Frazier Skin Hook**

5" (12.5 cm)

199-380 sharp  
199-382 blunt



199-380

**Adamson Double-ended Hook and Retractor**

7.5 mm x 5 mm retractor / 3 mm hook / 6 1/4" (15.9 cm)

205-700



205-700

**Joseph Skin Hook**

Two prong / sharp  
 199-485 6" (15 cm)  
 199-484 7" (18 cm)



**Joseph Skin Hook Titanium**

Round handle / 2 sharp prongs / 7 mm / 6 1/4" (15.9)  
 199-420T



**Meyerding Skin Hook**

6 1/4" (16 cm)  
 205-850



**Converse Nasal Tip Skin Hook**

Double-ended / 4" (10 cm)  
 475-540 sharp  
 475-542 blunt



**Converse Combo Sharp/Blunt Skin Hook**

Double-ended / sharp/blunt / 5 1/2" (14 cm)  
 475-539



**Sontec Alar Stabilizing Jig**

5" (12.5 cm)  
 475-543



**Freeman Skin Hook**

With finger loop / 4" (10 cm)  
 475-546 1 prong  
 475-547 2 prongs



**Humby Variable Skin Hook**

2 swivel hooks / 4 3/4" (12 cm)  
 475-550



**Modified Humby Skin Hook**

Sharp / 6" (15 cm) / 2 adjustable prongs / with handle  
 475-552



**Kilner Deluxe Skin Hook**

Small / 6" (15 cm)  
 199-375



**Mammoplasty & Mastectomy Hook**

7 1/2" (19 cm)  
 475-549



**Joseph Skin Hook**

Single prong ball tip / 6 1/4" (16 cm)

199-415



199-415

**Joseph Skin Hook**

Sharp / 1 prong / 6 1/4" (16 cm)

199-414



199-414

**Joseph Skin Hook**

Sharp / 2 prongs / 6 1/4" (16 cm)

- 199-416 2 mm
- 199-418 5 mm
- 199-420 7 mm
- 199-422 10 mm
- 199-430 12 mm
- 199-438 14 mm
- 199-446 16 mm
- 199-458 18 mm



199-422

**Joseph Blunt Ball Tips Skin Hook**

Ball tip / 2 prongs / 6 1/4" (16 cm)

- 199-426 10 mm
- 199-434 12 mm
- 199-442 14 mm
- 199-450 16 mm
- 199-462 18 mm



199-426



199-450

**Joseph Skin Hook Electro Blue**

Sharp / 2 prongs / blue electro coat / 6 1/4" (16 cm)

- 199-417 2 mm
- 199-4182 5 mm
- 199-419 7 mm
- 199-424 10 mm
- 199-432 12 mm
- 199-440 14 mm
- 199-448 16 mm
- 199-460 18 mm



199-419

**Joseph Blunt Ball Tips Skin Hook Electro Blue**

Ball tip / 2 prongs / blue electro coat / 6 1/4" (16 cm)

- 199-421 7 mm
- 199-428 10 mm
- 199-436 12 mm
- 199-444 14 mm
- 199-452 16 mm
- 199-464 18 mm



199-436

**Jackson Tracheal Hook**

5 1/2" (14 cm)

502-394



502-394

**Sontec Tracheal Hook Titanium**

Sharp / 90° angled / 4 mm 6 1/4" (15.9 cm)

502-393T



502-393T

**Rake Retractor**

6 1/2" (16.5 cm)

- 205-880 sharp 1 prong
- 205-884 blunt 1 prong
- 205-881 sharp 2 prongs
- 205-885 blunt 2 prongs
- 205-882 sharp 3 prongs
- 205-886 blunt 3 prongs

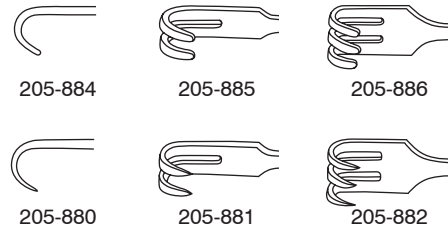

205-881

**Neivert Hook Retractor**

Double ended / 7 1/2" (19.1 cm)

199-397S



199-397S

**Cottle Neivert Hook Retractor**

Double ended / 8 1/2" (21.6 cm)

199-397



199-397S

**Neivert Retractor**

Rhinoplastic / double ended / 6 1/4" (16 cm)

199-398



199-398

**Mandible Bone Hook**

8" (20 cm)

320-937



320-937

**Sontec® Bone Hook**

9" (23 cm)

- 320-925 small
- 320-930 medium
- 320-935 large



320-930

**Kilner Skin Retractor Hook**

With finger ring / 2 prongs / 3 1/4" (8 cm)

220-160



220-160

**Finger Ring Retractor Hook**

Sharp / 2 prongs / 10 mm / 1 3/4" (4.4 cm)

220-143



220-143

**Millard Thumb Retractor Hook**

**Sharp**

- 220-145 1 prong
- 220-149 2 prongs 14 mm
- 220-150 2 prongs 18 mm



**Thumb Ring Skin Hook**

**Sharp / 2 prongs / 3 1/2" (9 cm)**

- 220-151 small
- 220-152 large



**Finger Ring Skin Hook**

**1 3/4" (4 cm)**

- 220-155 short hook
- 220-155L long hook



**Cottle Thumb Skin Hook**

**With finger ring / 2 prongs / 10 mm / 2" (5 cm)**

- 220-156

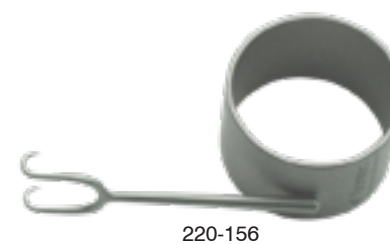

**Flexible Neck Hook Retractor**

**5" (13 cm)**

- 205-819 sharp 3 prongs

**6" (15 cm)**

- 205-820 sharp 1 prong
- 205-826 blunt 1 prong
- 205-822 sharp 2 prongs
- 205-828 blunt 2 prongs
- 205-824 sharp 3 prongs
- 205-830 blunt 3 prongs

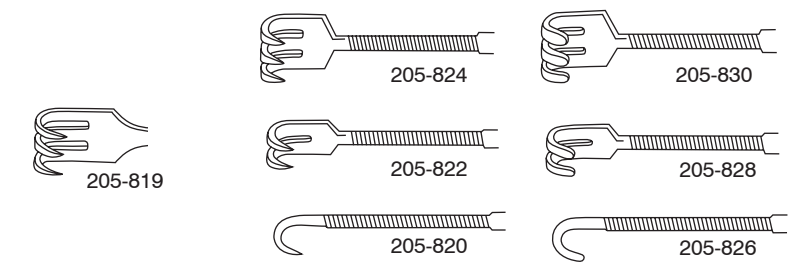

**Blair Hook Retractor**

**Four prongs / 5" (12.5 cm)**

- 205-847 sharp
- 205-848 blunt



**Knapp Rollet Hook Retractor**

**4 prongs / 5" (12.5 cm)**

- 205-844 sharp
- 205-846 blunt



**Anderson Bear Claw Hook Retractor**

**Sharp / 5" (12.5 cm)**

- 475-530 3 prongs
- 475-535 5 prongs



**Miller Skin Rake Retractor**

5" (12.5 cm)

- 199-480 9 prong sharp
- 199-481 9 prong blunt
- 199-482 6 prong sharp
- 199-483 6 prong blunt



199-481

**Paul Skin Rake Retractor**

Blunt / 5" (12.5 cm)

199-490



199-490

**Mini Rake Retractor**

6 1/4" (16 cm)

475-503



475-503

**Cottle Alar Retractor**

4 prong / 5 1/8" (13 cm)

205-865 8 mm

4 prong / delicate / long neck / 5 1/8" (13 cm)

205-864 7 mm



205-864



205-865

**Hook Retractor**

In-line prongs / four prongs / 7" (18 cm)

- 475-511 straight
- 475-510 narrow head
- 475-521 angled shaft

With shorter inner prongs / 7" (18 cm)

- 475-520 angled shaft 4 prong

Miniature model / with thumb ring / in-line prongs / four prongs

- 475-517 2 1/2" (6 cm)
- 475-518 4 1/2" (11.5 cm)



475-517

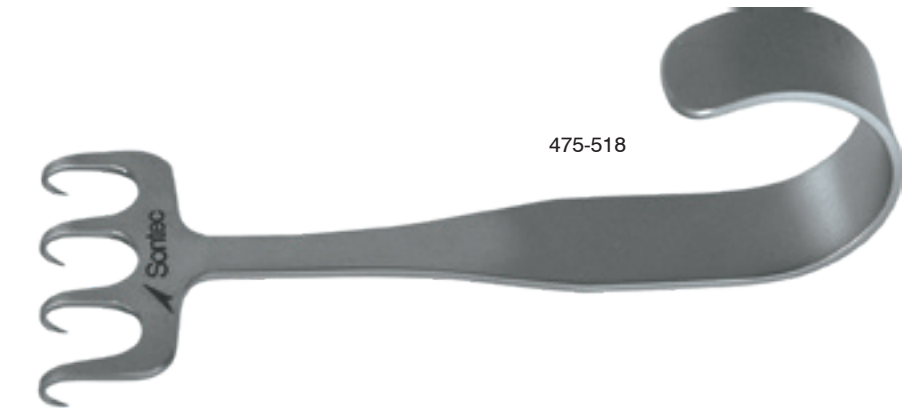

475-518



475-510



475-520

**Freeman Hook Retractor**

Seven Prongs / with shorter inner prongs / seven prongs / 7" (18 cm)

- 475-505
- 475-505A concave
- 475-505B convex



475-505A



475-505B

**Sontec-Yancoskie Coronal Lift Retractor**

6 off-set prongs / 8 1/2" (22 cm)

475-508



475-508

**Sontec Skin Retractor**

Round tapered edges / 6" (15.2 cm)

205-870



205-870



 Sontec Instruments®

ENT Plastic DISSECTORS

**Mammary & Calf Muscle Dissector**

14 3/4" (37.8 cm)  
475-940



475-940

**Golf Club Breast Dissector**

Angulated blade / rigid / 13" (33 cm)  
475-627



475-627

**MacCollum-Dingman Submammary Dissector**

12" (30 cm)  
475-635



475-635

**MacCollum-Dingman Breast Dissector**

16" (41 cm)  
475-630



475-630

**"J" Mammary Implant Dissector**

16" (40 cm)  
475-628



475-628

**Agris-Dingman Breast Dissector**

Graduated / 14 1/4" (36 cm)  
475-631L left  
475-632R right



475-631L

**Solz Breast Hook Dissector**

14 1/4" (36 cm)  
475-640L left  
475-640R right

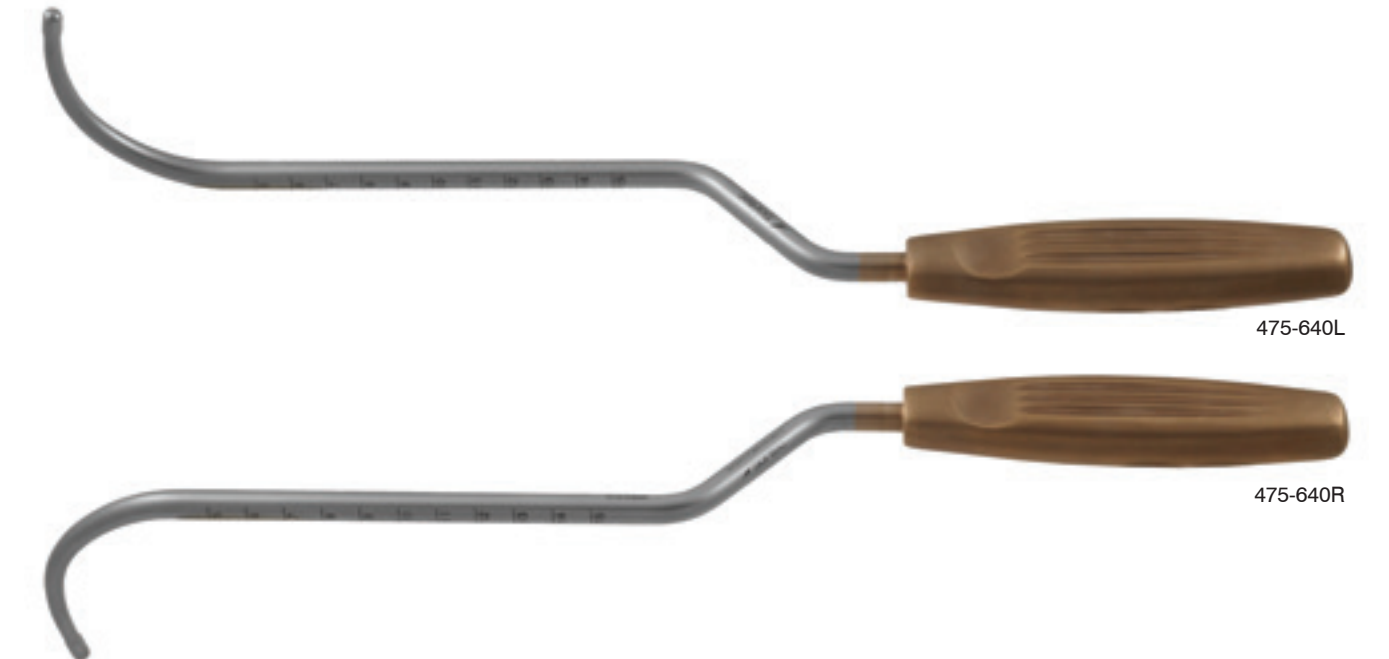

475-640L

475-640R

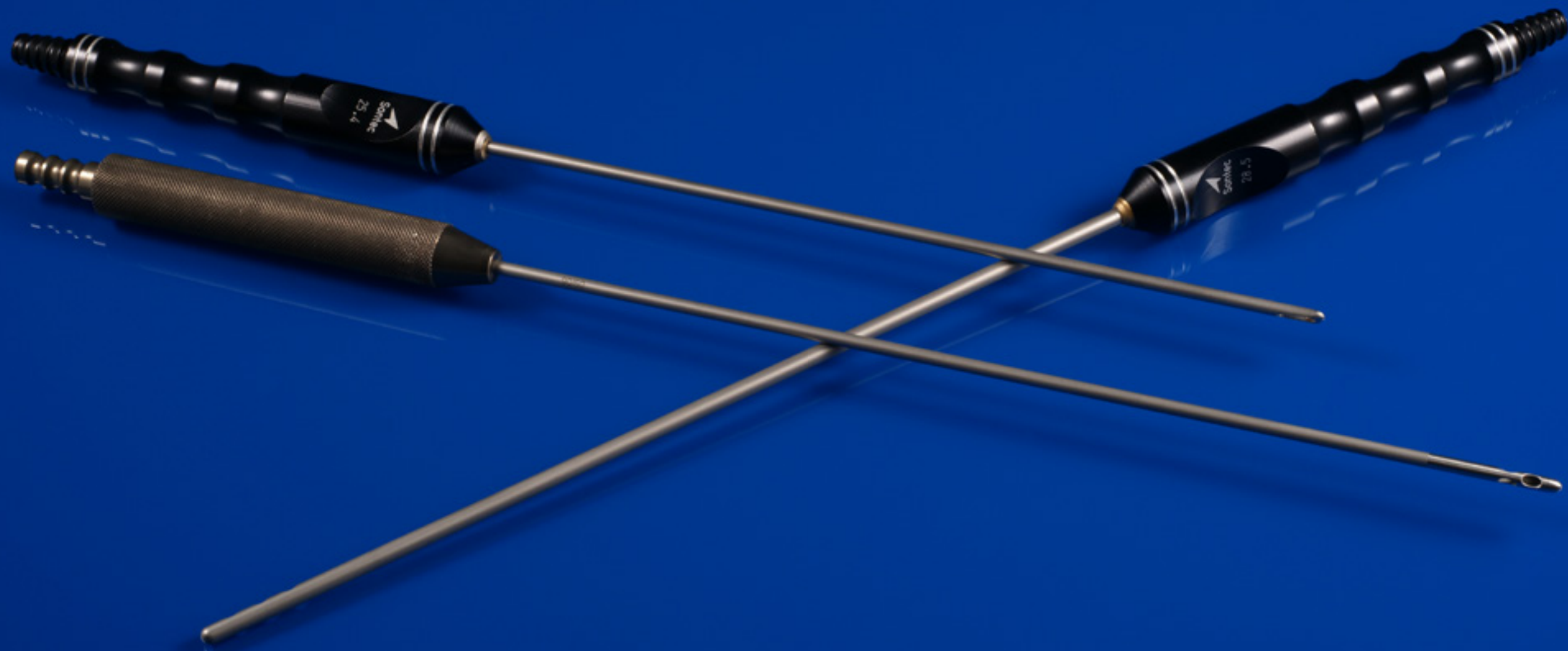

 Sontec Instruments®

Plastic Liposuction Cannulas

**Liposuction Cannula**

**Multi perforated tip / 15 3/4" (40 cm)**

Item#	
250x3 mm	201-330
250x4 mm	201-332
250x5 mm	201-334
280x4 mm	201-336
280x5 mm	201-338

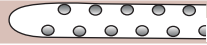

**Angled tip / 15 3/4" (40 cm)**

Item#	
150x3 mm	201-400
180x4 mm	201-402
250x4 mm	201-404
250x5 mm	201-406



**Spatulated tip / 15 3/4" (40 cm)**

Item#	
180x3 mm	201-350
180x4 mm	201-352
180x5 mm	201-354
220x3 mm	201-356
220x4 mm	201-358
250x4 mm	201-360
250x5 mm	201-362
280x4 mm	201-364
280x5 mm	201-366

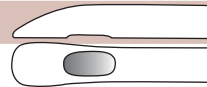

**Ring swiss point tip / 15 3/4" (40 cm)**

Item#	
220x3 mm	201-410
220x3.5 mm	201-412
250x3 mm	201-414
250x3.5 mm	201-416

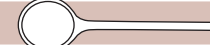

**Spiral tip / 15 3/4" (40 cm)**

Item#	
220x4 mm	201-380
220x5 mm	201-382
250x3 mm	201-384
250x4 mm	201-386
280x3 mm	201-388
280x4 mm	201-390



**Liposuction Cannula**

The following tips are available with these three handles. Please be specific when ordering.



"A" Handle



"B" Handle

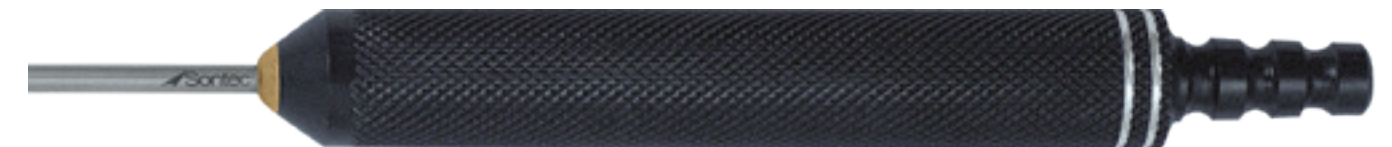

"C" Handle

**One hole / straight / 15 3/4" (40 cm)**

Item#	straight tip	curved tip
150x2 mm	201-002	n/a
150x3 mm	201-004	201-032
180x2 mm	201-006	n/a
180x3 mm	201-008	201-034
180x4 mm	201-010	n/a
220x3 mm	201-012	n/a
220x4 mm	201-014	201-036
220x5 mm	201-016	n/a
250x3 mm	201-018	n/a
250x4 mm	201-020	201-038
250x5 mm	201-022	201-040
280x3 mm	201-024	n/a
280x4 mm	201-026	n/a
280x5 mm	201-028	n/a
280x6 mm	201-030	n/a

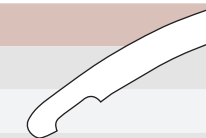

Liposuction Cannula

Tótem style / straight / 15 3/4" (40 cm)

Item#	1x2 holes	2x1 holes
220x3 mm	201-190	201-210
220x4 mm	201-192	201-212
250x3 mm	201-194	201-214
250x4 mm	201-196	201-216
250x5 mm	201-198	201-218
280x4 mm	201-200	201-220
280x5 mm	201-202	201-222

Tótem style / straight / 15 3/4" (40 cm)

Item#	Double- Model 1	Double- Model 2
250x4 mm	201-230	201-240
250x5 mm	201-232	201-242
280x4 mm	201-234	201-244
280x5 mm	201-236	201-246

Two hole/ straight / 15 3/4" (40 cm)

Item#	straight tip	curved tip
150x2 mm	201-050	n/a
150x3 mm	201-052	201-090
150x4 mm	201-054	201-092
180x2 mm	201-056	201-094
180x3 mm	201-060	201-096
180x4 mm	201-062	201-098
180x5 mm	201-064	n/a
220x3 mm	201-066	201-100
220x4 mm	201-068	201-102
220x5 mm	201-070	201-104
220x6 mm	201-072	n/a
250x3 mm	201-074	201-106
250x4 mm	201-076	201-108
250x5 mm	201-078	201-110
280x3 mm	201-080	n/a
280x4 mm	201-082	201-112
280x5 mm	201-084	201-114
280x6 mm	201-086	201-116



Liposuction Cannula

Three hole / Mercedes style / 15 3/4" (40 cm)

Item#	
150x2.5 mm	201-260
150x3 mm	201-262
150x4 mm	201-264
180x2.5 mm	201-266
180x3 mm	201-268
180x4 mm	201-270
180x5 mm	201-272
220x3 mm	201-274
220x4 mm	201-276
220x5 mm	201-278
250x3 mm	201-280
250x4 mm	201-282
250x5 mm	201-284
280x3 mm	201-286
280x4 mm	201-288
280x5 mm	201-290

Cobra style / 15 3/4" (40 cm)

Item#	
150x3 mm	201-162
180x2.5 mm	201-164
180x3 mm	201-166
180x4 mm	201-168
220x3 mm	201-170
220x4 mm	201-172
220x5 mm	201-174
250x2 mm	201-160
250x3 mm	201-176
250x4 mm	201-178
250x5 mm	201-180
280x3 mm	201-182
280x4 mm	201-184
280x5 mm	201-186



Three hole / straight tip / 15 3/4" (40 cm)

Item#	
150x2 mm	201-120
150x3 mm	201-122
150x4 mm	201-124
180x2 mm	201-126
180x3 mm	201-128
180x4 mm	201-130
180x5 mm	201-132
220x2 mm	201-134
220x3 mm	201-136
220x4 mm	201-138
220x5 mm	201-140
250x3 mm	201-142
250x4 mm	201-144
250x5 mm	201-146
280x3 mm	201-148
280x4 mm	201-150
280x5 mm	201-152
280x6 mm	201-154

Grated style tip / 15 3/4" (40 cm)

Item#	
180x3 mm	201-300
180x4 mm	201-302
220x3 mm	201-304
220x4 mm	201-306
250x3 mm	201-308
250x4 mm	201-310
250x5 mm	201-312
280x3 mm	201-314
280x4 mm	201-316



 Sontec Instruments®

ENT Plastic RETRACTORS

**Biggs Mammoplasty Retractor**

Narrow model

475-885L illuminated w/suction



**Fiber-Optic System**

For optimal visibility during surgery. Add illumination to your instruments. Including Retractors, Elevators, and Speculums. Sontec® can adapt a fiber-optic system to almost any instrument for better illumination of surgical sites. Please call Sontec® for more details.

**Biggs Mammoplasty Retractor**

Narrow model

475-885 standard

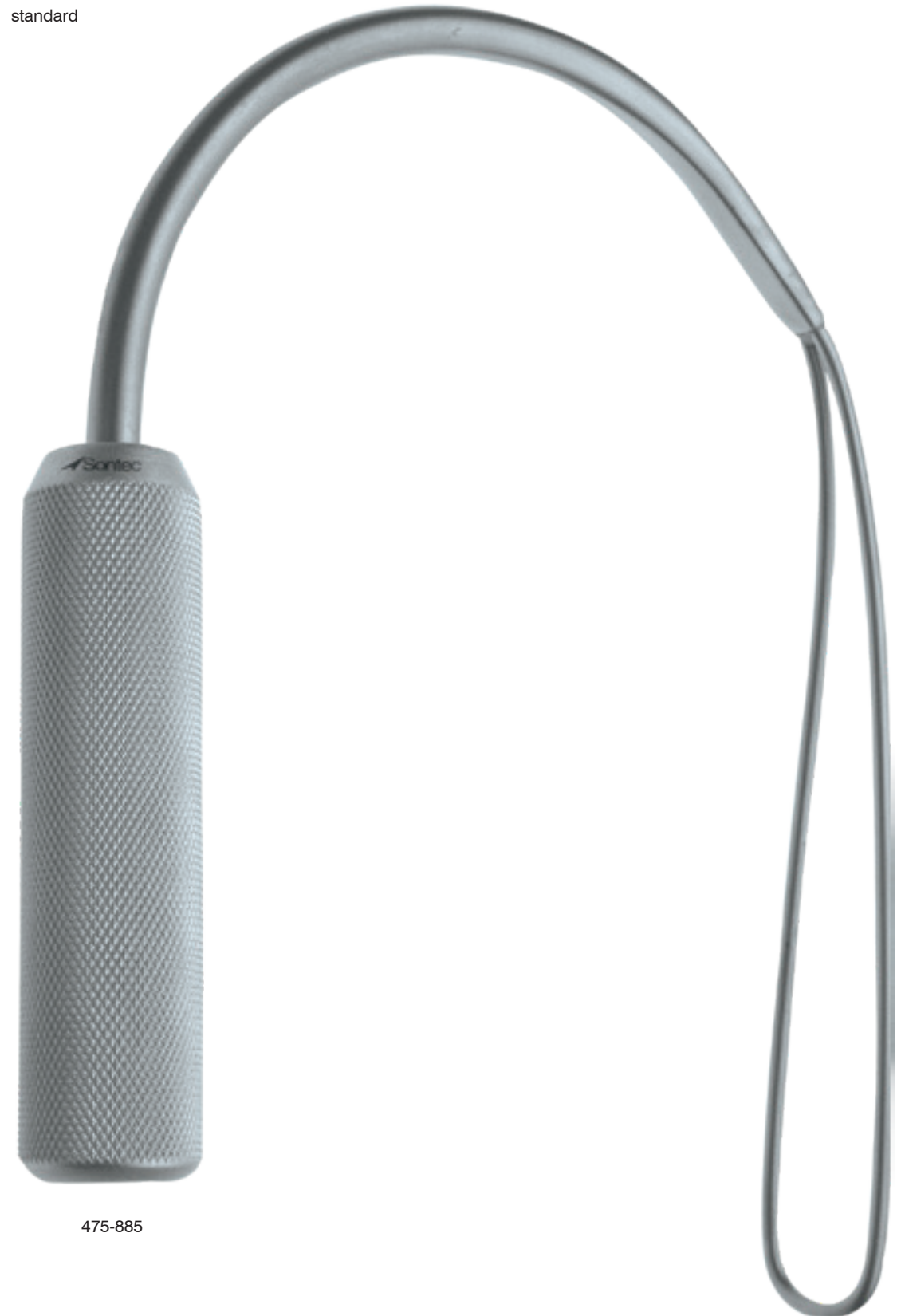

**Biggs Face Lift Retractor**

8" (20 cm) overall length

- 475-884 standard
- 475-884L illuminated



475-884

**Biggs Mammoplasty Retractor**

Standard model

- 475-886 standard
- 475-886L illuminated



475-886

**Ferreira Face Lift Retractor**

Blade 4 1/8" x 1" / 5" (12.5 cm) overall length

- 475-880
- 475-880L illuminated



475-880

**Aufricht Daniel Nasal Retractor**

4 1/4" (11 cm)

- 207-2929 50 x 10 mm



207-2929

**Maliniac Nasal Retractor**

2" blade

- 475-878 3 1/2" overall length
- 475-878L 4" overall length with fiber optic light guide



475-878



475-878L

**Ferreira Breast Augmentation Retractor**

With round smooth tip

With Light Guide	With Light Guide & Suction	Blades
475-926L	475-926LS	14 mm x 7 cm
475-927L	475-927LS	14 mm x 9 cm
475-928L	475-928LS	16 mm x 8 cm
475-929L	475-929LS	16 mm x 15 cm
475-931L	475-931LS	23 mm x 10 cm
475-932L	475-932LS	23 mm x 15 cm
475-933L	475-933LS	23 mm x 18 cm
475-934L	475-934LS	25 mm x 10 cm
475-935L	475-935LS	25 mm x 12 cm
475-936L	475-936LS	25 mm x 15 cm
475-937L	475-937LS	25 mm x 19 cm
475-938L	475-938LS </td <td>30 mm x 12 cm</td>	30 mm x 12 cm
475-939L	475-939LS	30 mm x 15 cm



475-931LS

**Breast Retractor**

Double-ended 12 1/2" (31 cm)

475-925 22 mm x 55 mm / 38 mm x 70 mm blades



475-925

**Ferreira Breast Augmentation Retractor**

25 mm x 190 mm blade / 6 1/2" (16.5 cm) overall length

475-930

475-930L illuminated



475-930

**Sontec Suction Wound Retractor**

With suction / illuminated / serrated straight edge /  
angled blade and lip

46933-00 90 mm x 24 mm

46933-02 90 mm x 30 mm

46933-04 115 mm x 24 mm

46933-06 150 mm x 36 mm

46933-08 190 mm x 30 mm



46933-00

**Sontec Suction Wound Retractor**

With suction / illuminated / smooth round edge

46934-00	80 mm x 16 mm
46934-01	100 mm x 24 mm
46934-02	120 mm x 25 mm
46934-03	120 mm x 30 mm
46934-04	150 mm x 25 mm
46934-05	150 mm x 30 mm
46934-06	170 mm x 40 mm



46934-06

**Pitanguy Abdominal Retractor**

Straight

475-922	small 90 mm
475-921	medium 170 mm
475-920	large 190 mm



475-922

**Pitanguy Abdominal Retractor**

**Curved**

- 475-923 right
- 475-924 left (reverse)



**Converse Hand Retractor**

**3 3/4" (9.5 cm) overall length**

	Length	Straight blade	Curved blade
205-907 #1	3 1/2"	20 mm x 8 mm	22 mm x 8 mm
205-908 #2	3 1/2"	30 mm x 12 mm	25 mm x 12 mm
205-909 #3	3 7/8"	38 mm x 12 mm	25 mm x 12 mm
205-910 #4	3 7/8"	47 mm x 12 mm	25 mm x 12 mm
205-912	set of four (one of each style)		

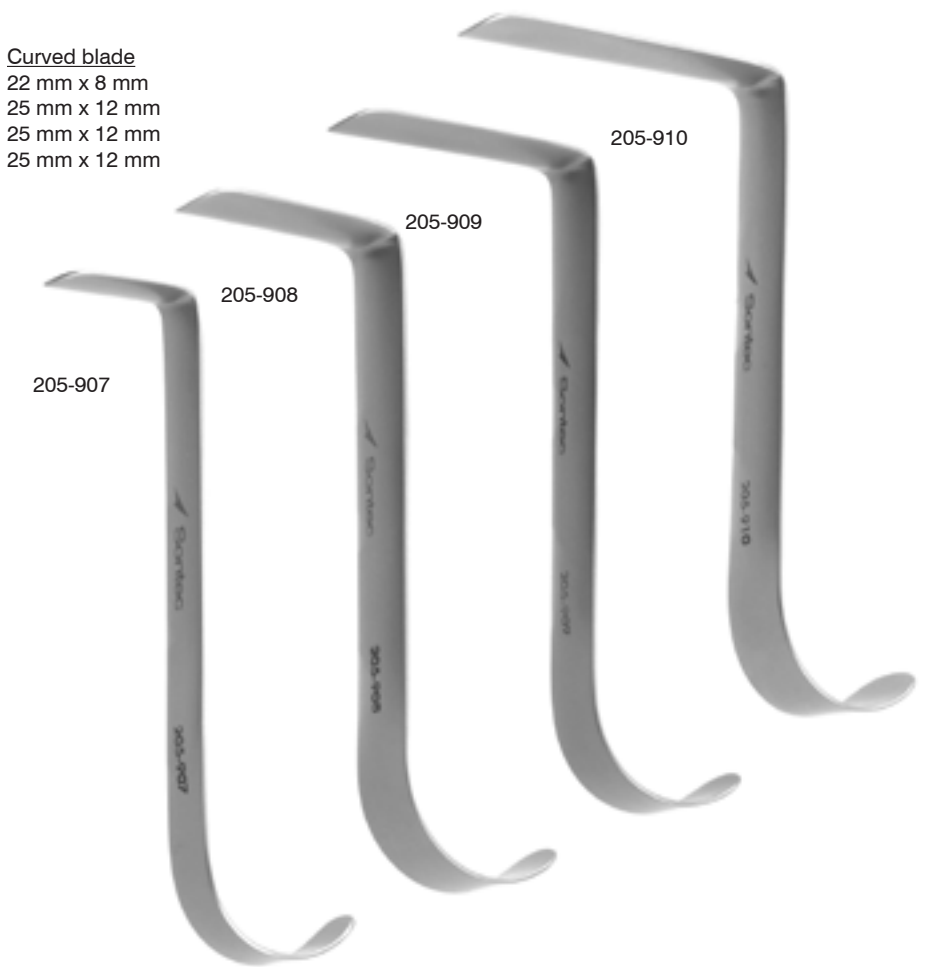

**Converse Hand Retractor**

**With fiber optic light guide / 5 1/4" (13cm) overall length**

205-907L	8x20mm
205-908L	12x30mm
205-909L	12x40mm
205-910L	12x50mm



**Kasdan Hand Retractor**

**Double-ended / 1/2" x 1/4" (13 mm x 6.5 mm) and 3/4" x 3/8" (19 mm x 9.5 mm) 6 1/4" (15.9 cm)**

10-4280



**Endoscopic Guidance Face Lift Retractor**

7 1/2" (19 cm)  
207-945



**Walter Forehead Retractor**

With fiber optic illumination and unit  
adaptor / 7" (18 cm)  
207-930



**Langenbeck Retractor**

With fiber optic light guide /  
medium blade / 10 1/4" (26cm)

207-289L



207-289L

**Freeman Flap Retractor**

1/2" wide

475-523

475-523C blue electro coat

1" wide

475-522

475-522C blue electro coat



475-523



475-522C

**Deaver Retractor**

- 207-420 1/4" x 7"
- 207-421 3/8" pediatric size
- 207-422 3/4" x 7"
- 207-422L 3/4" x 7" illuminated
- 207-423 7/8" x 8 1/2"
- 207-423A 5/8" x 8 1/2"
- 207-423L 7/8" x 8 1/2" illuminated
- 207-424 1" x 12"
- 207-424L 1" x 12" illuminated
- 207-425 1" x 13"
- 207-426 1" x 14"
- 207-427 1 1/2" x 12"
- 207-428 2" x 12"
- 207-429 3" x 12"
- 207-431 1" x 9"



**Deaver Retractor**

**Electro blue coated**

- 207-4221 3/4" x 7"
- 207-4231 5/8" x 8"
- 207-4232 3/4" x 8"
- 207-4234 1" x 8"
- 207-4242 1" x 12 1/2"
- 207-4271 1 1/2" x 12"
- 207-4281 2" x 12"

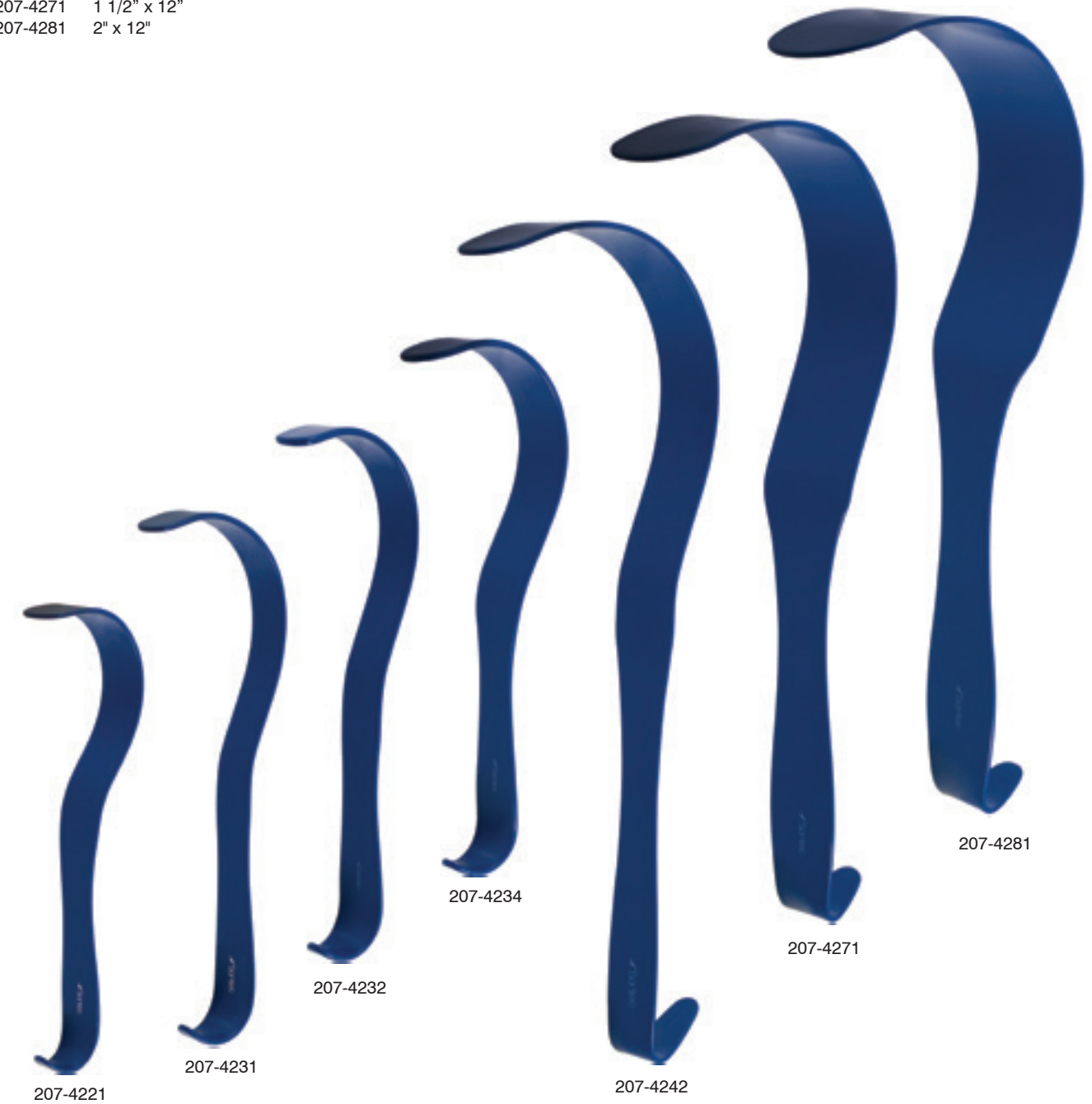

**Sontec S-Curve Retractor**

Sontec special model / hard/ flexible

207-417 3/4" tapered to 1/2" 8" (20cm)



**S-Curve Retractor**

Malleable

207-418 1/2" 8" (20 cm)  
 207-419-10 10 mm 7" (18 cm)  
 207-419-12 12.7 mm 7" (18 cm)



**Gruber Skin Hook**

With weight / 10 mm tip / 5" (12.7 cm)

199-383



**Tsur Open Rhinoplasty Retractor**

207-295

This retractor solves the problems of open rhinoplasty exposure by exposing the tip and dorsum of the nose simultaneously, enabling the surgeon to perform the operation with no assistance. The adjustable, flexible tension on the retracted skin and soft tissue prevents congestion and formation of edema to the retracted skin. The nasal prong adjusts and adapts to the shape of the nose, changing its position by using the sliding bar fixation screw. The tension on the retractor is easily adjusted by rubber bands, which enables flexible, adjustable elastic tension (not stiff like other retractors). - Padgett



**Gruber Skin Hook**

10 mm tip / with weight / 5" (12.7 cm)

199-383



**Walter Aufricht Nasal Retractor**

Double Ended / 5 1/4" (13.5 cm)

207-2924 4 mm  
207-2928 8 mm

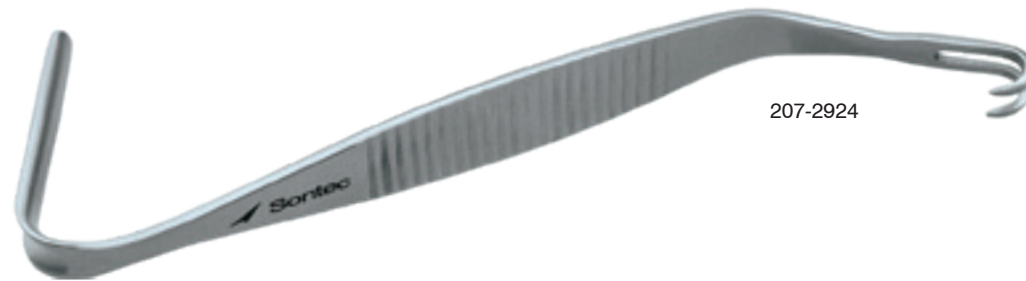

207-2924

**Walter Aufricht Nasal Retractor Titanium**

Double Ended / blunt / 8 mm / 5 1/4" (13.5 cm)

207-2928T



207-2928T

**Jackson Tracheal Retractor Titanium**

Double Ended / 2 sharp prongs / 6 3/4" (17.1 cm)

502-398T



502-398T

**Trousseau Tracheal Dilator Retractor**

5 1/4" (13.3 cm) shaft

502-380 medium adolescent  
502-382 pediatric small  
502-384 adult large



502-382

502-380

**Craig-Sheehan Retractor**

4 prong / 7 1/2" (19 cm)

215-100

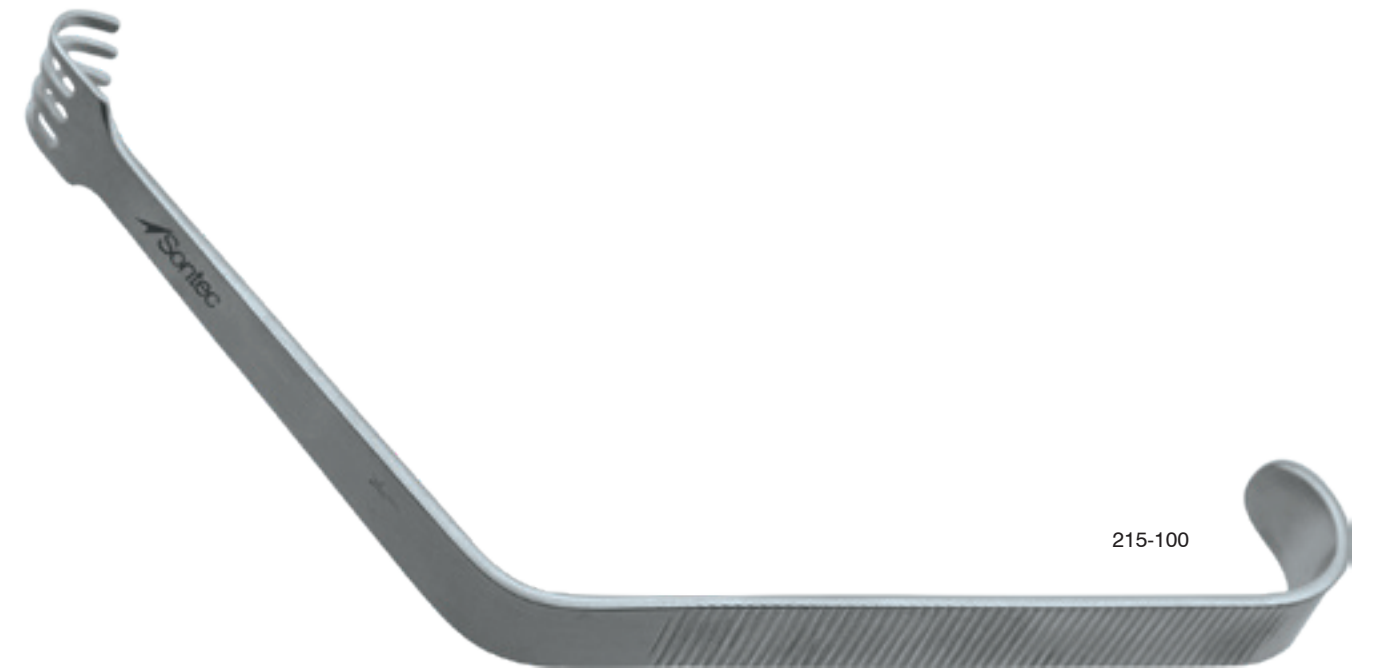

215-100

**LaRoe Tissue Spreader Retractor**

**Straight**

475-622 small 9" (23 cm)

**Curved**

475-623 small 9" (23 cm)  
475-625 large 10 1/4" (25.5 cm)

**Tapered**

475-624 medium 10 1/4" (25.5 cm)



**U.S. Army-Navy Retractor**

Set of 2 / 8 1/2" (21.5 cm)

1100-670



**U.S. Army-Navy Retractor**

Set of 2 / blue electro coated / 8 1/2" (21.5 cm)

1100-670B



**Aufricht Nasal Retractor**

6 1/2" (16.5 cm) overall length

207-292	solid blade		10 x 45 mm
207-292L	solid blade	illuminated	10 x 45 mm
207-2925	solid blade		10 x 35 mm
207-290	open blade		
207-290L	fenestrated open blade	illuminated	
207-293	solid blade	non-reflective finish	
207-293L	solid blade illuminated	non-reflective finish	10 x 45 mm



**Senn Retractor**

Double-ended / 6 1/4" (16 cm)

- 1100-668 sharp
- 1100-668B blunt
- 1100-668T sharp titanium



1100-668



1100-668T

**Senn Retractor**

Blue electro coated / Double-ended / 6 1/4" (16 cm)

- 1100-669 sharp
- 1100-669B blunt



1100-669



1100-669B

**Ragnell Retractor**

Double-ended / 6" (15 cm)

- 205-849



205-849

**Ragnell Retractor**

Blue coated / double-ended / 6" (15 cm)

- 205-849B



205-849B

**Richardson Retractor**

9 1/2" overall length / loop grip handle

- 207-338 1" x 3/4"
- 207-340 1" x 1 1/4"
- 207-342 1 1/2" x 1 1/2"
- 207-345 2" x 3/4"

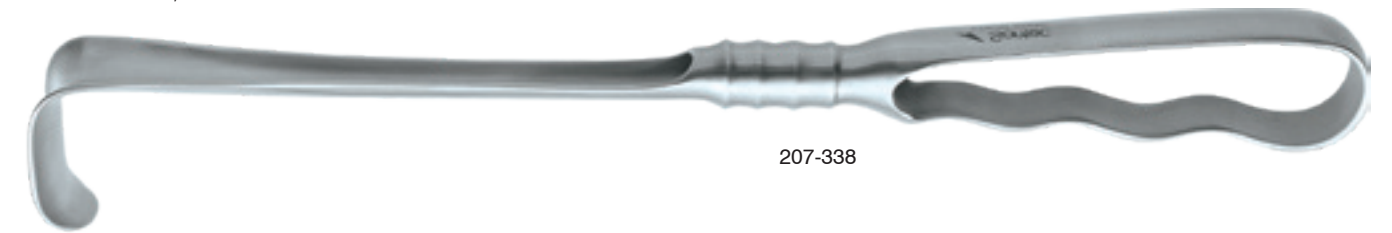

207-338

9 1/4" overall length / hollow grip handle

- 207-333 2" x 3/4"

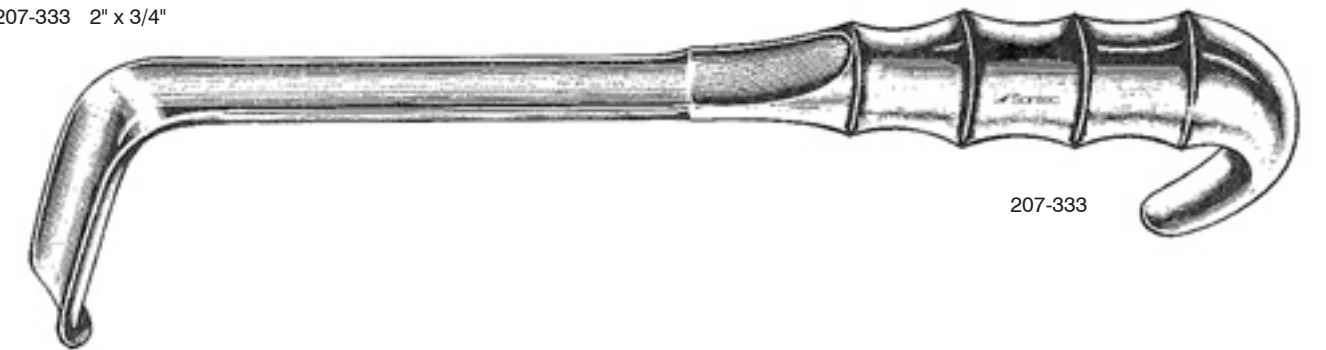

207-333

11" overall length / lamb grip handle

- 207-326 1" x 3/4"
- 207-328 1 1/4" x 1"
- 207-330 1 1/2" x 1 1/2"



207-326

**Malleable Ribbon Retractor**

**Malleable**

- 207-454 1/4" x 7"
- 207-455 3/8" x 7"
- 207-456 1/2" x 7"
- 207-460 5/8" x 7"
- 207-461 3/4" x 7"
- 207-462 1" x 7"
- 207-463 3/4" x 13"
- 207-464 1" x 13"
- 207-465 1 1/4" x 13"
- 207-466 1 1/2" x 13"
- 207-467 2" x 13"
- 207-468 2 1/2" x 13"
- 207-469 3" x 13"
- 207-470 3 1/2" x 13"
- 207-471 4" x 13"
- 207-472 5" x 13"
- 207-474 1 3/4" x 13"
- 207-473 2 3/4" x 13"



207-466

207-460



**Malleable Ribbon Retractor**

**Hollow Grip Handle**

- 207-482 3/4" wide blade
- 207-484 1" wide blade
- 207-486 1 1/4" wide blade
- 207-488 1 1/2" wide blade
- 207-490 2" wide blade



207-486



207-488

**Lead Hand Stabilizing Restrainer**

- 48-0339 pediatric 9 3/4" (25cm)
- 48-0340 adult 14 1/2" (37cm)



48-0339

**G Aufricht Nasal Retractor**

Solid tapered blade / 45 mm x 7 mm tapers to 6 mm at tip / 7" (17.8 cm)

207-2920

Solid tapered blade / 45 mm x 9 mm tapers to 7 mm at tip / 7 1/4" (18 cm)

207-2921

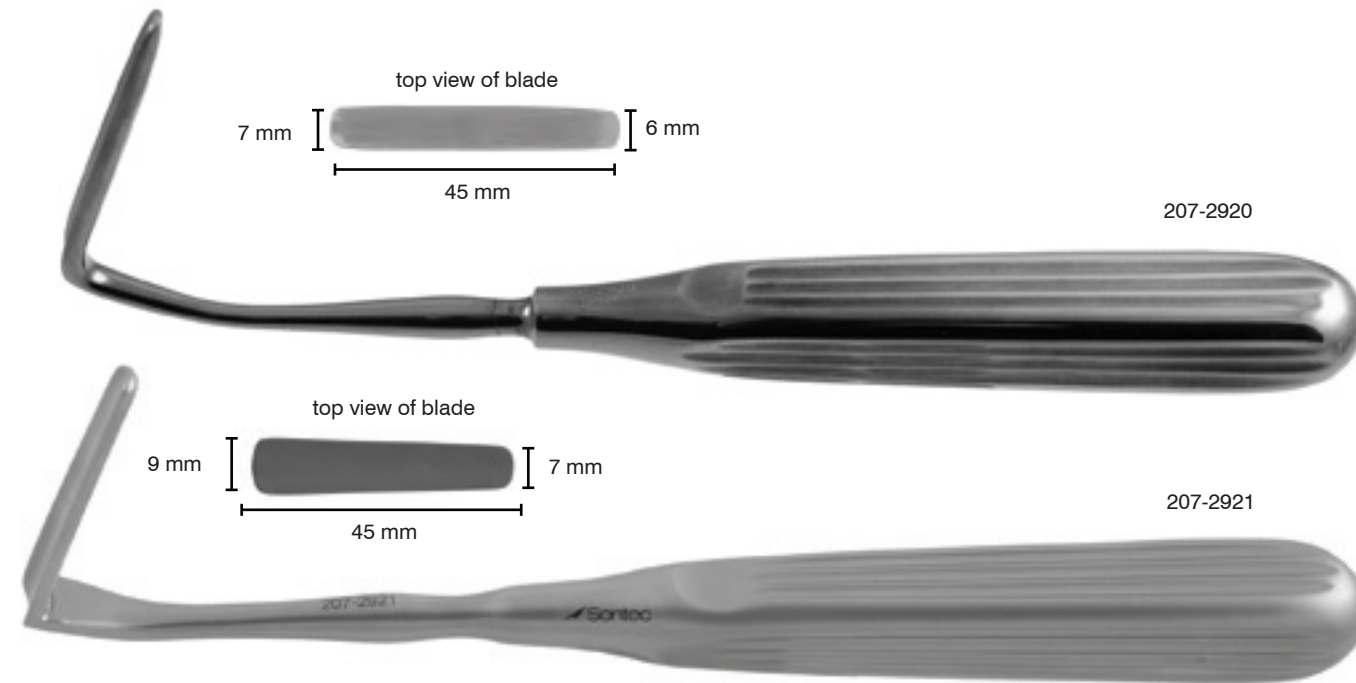

**Aufricht Nasal Retractor**

Solid tapered blade / 6 3/4" (17 cm)

207-2922 50 mm x 12 mm tapers to 6 mm at tip

207-2923 30 mm x 10 mm tapers to 6 mm at tip

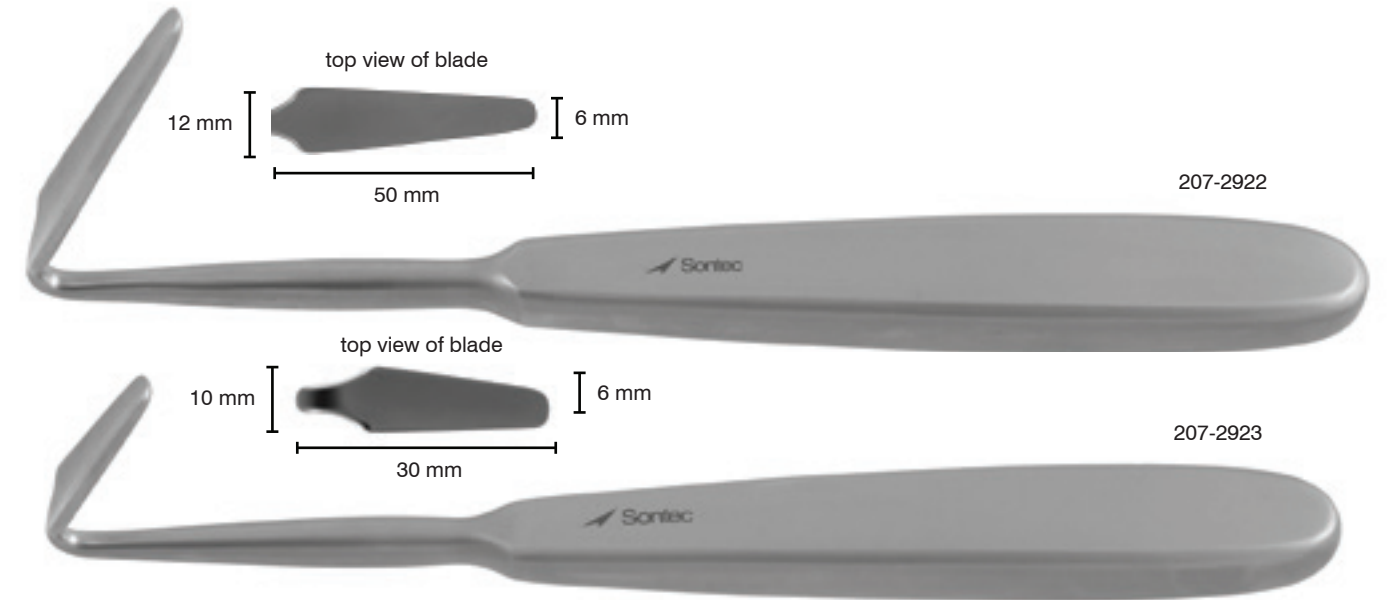

**Desmarres Lid Retractor**

**Stainless steel / 5 1/2" (14 cm)**

- 10-4192 6 mm
- 10-4194 8 mm
- 10-4196 9 mm
- 10-4198 10 mm
- 10-4200 11 mm
- 10-4201 11 mm electro-blue coated
- 10-4206 12 mm
- 10-4207 12 mm electro-blue coated
- 10-4210 13 mm
- 10-4213 13 mm electro-blue coated
- 10-4216 14 mm
- 10-4220 15 mm



10-4200



10-4223

- 10-4218 14 mm
- 10-4223 15 mm electro-blue coated
- 10-4226 16 mm
- 10-4227 16 mm electro-blue coated
- 10-4230 17 mm



10-4236

- 10-4233 17 mm electro-blue coated
- 10-4236 18 mm
- 10-4237 18 mm electro-blue coated
- 10-4240 19 mm



10-4192 10-4196 10-4198 10-4206 10-4216 10-4226

**Kawamoto Double-Ended Retractor**

**14 mm x 16 mm / 6" (15.2 cm)**

- 10-4269
- 10-4270 blue electro coating



10-4269



10-4270

**McGannon Retractor**

**Fenestrated blade / 5" (12.5 cm)**

- 205-800 2.5 mm



205-800

**Desmarres Lid Retractor Titanium**

**10 mm / 4 3/4" (12.1 cm)**

- T10-4198



T10-4198

**Double-ended / 10 mm & 12 mm / 5 7/8" (14.7 cm)**

- T10-4255 6 mm



T10-4255

**Desmarres Lid Retractor Autoclavable Plastic**

**Double ended / transparent yellow / autoclave safe / 5 1/2" (14 cm)**

- 10-4245 10 mm & 12 mm
- 10-4246 14 mm & 16 mm



10-4245



10-4246

**Gil-Vernet Desmarres Retractor**

**5 3/4" (14.5 cm)**

- 10-4211 size 1
- 10-4221 size 2
- 10-4231 size 3
- 10-4241 size 4



10-4211

10-4231



10-4221

10-4241



10-4241

**Chamberlain-Fries Retractor**

Aluminum handle / 7 1/2" (19 cm)  
475-882



475-882

**Lukens Thymus Retractor**

7" (18 cm)  
502-409



502-409

**Lukens Thymus Retractor**

Blue electro coated / 7" (18 cm)  
502-410



502-410

**Meyering Finger Retractor**

7" (18 cm)

- 205-856 style 1
- 205-857 style 2
- 205-858 style 3
- 205-859 style 4
- 205-860 style 5
- 205-861 style 6

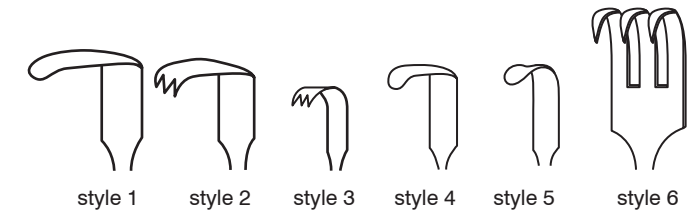

205-857



205-858



205-861

**Cottle Alar Retractor**

6 1/4" (16 cm)  
205-867



205-867

**Luer S-Shaped Retractor**

Double-ended / 10 x 5 mm & 14 x 9 mm  
/ 5 1/2" (14 cm)  
502-405



502-405

**Jackson Tracheal Retractor**

2 prong / blunt / 7" (18 cm)  
502-399



502-399

**Jackson Tracheal Retractor**

Blue electro coated / 2 prong / blunt / 7" (18 cm)  
502-400



502-400

**Perkins Retractor**

230-487 5 1/4" (13.5 cm) right  
230-488 5 1/2" (14 cm) left

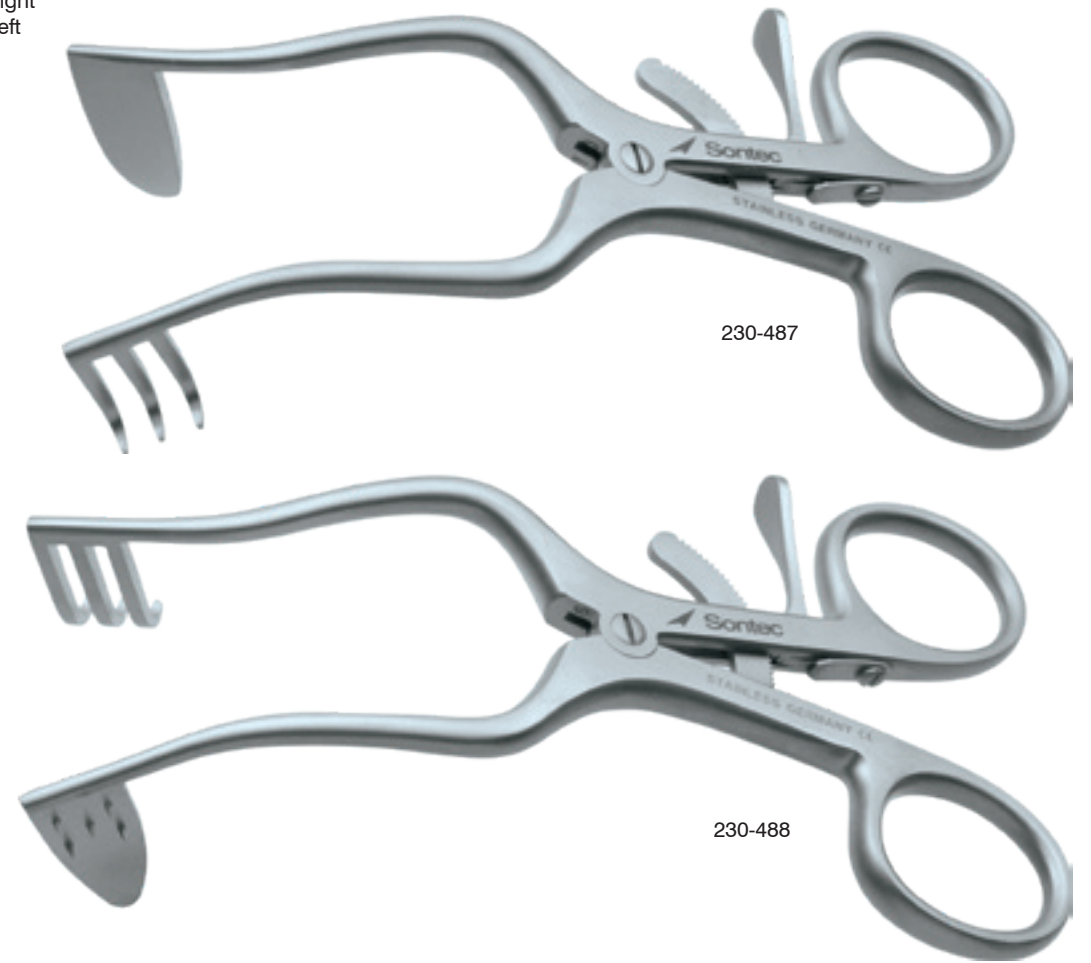

230-487

230-488

**Mayo-Sontec Retractor**

6 3/4" (16 cm)  
1100-634 2 1/4" blade

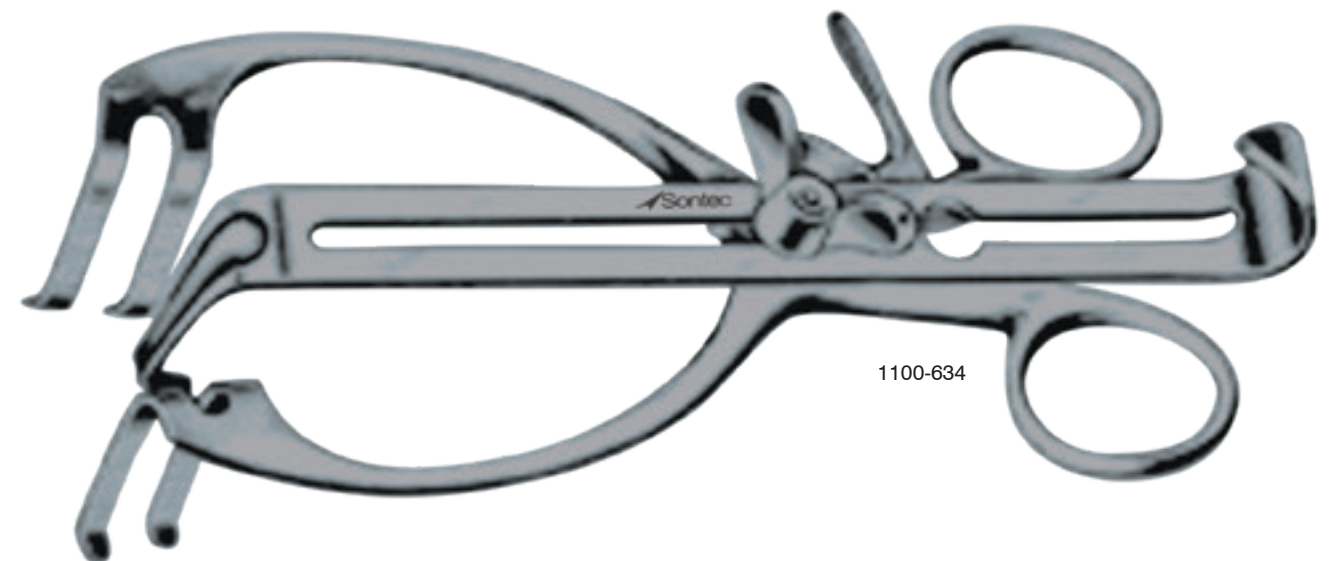

1100-634

**Plester Retractor Set**

**Blunt / 5 1/4" (13.3 cm)**

- 230-489R right
- 230-489L left



230-489L

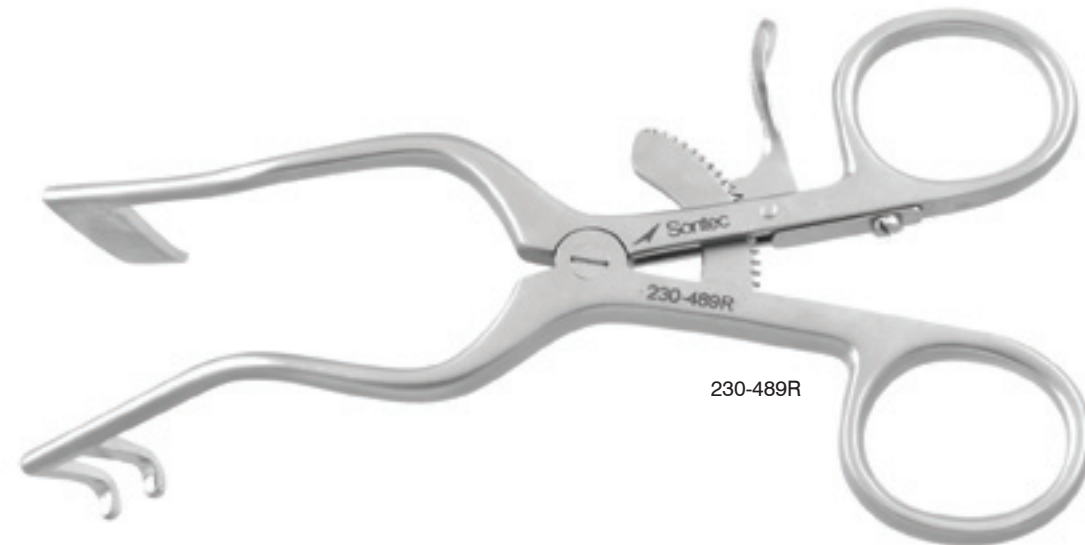

230-489R

**Jefferson Retractor**

**3x4 blunt 16 mm blades with curved arms / 5" (13 cm)**

230-495



230-495

**Plester Jansen Retractor**

**2x2 blunt 15 mm blades with curved arms / 4 3/8" (11 cm)**

230-4961

**3x3 blunt 20 mm blades with curved arms / 5 1/4" (13 cm)**

230-496



230-4961



230-496



 Sontec Instruments®

Plastic Endoscopic Face Lifting

**Ramirez Type Endoscopic Plastic Forehead Scissors**

Malleable / curved / vertical tip / 15 cm working length

2800-0001 periosteal  
2800-0002 corrugator

Malleable / curved / horizontal tip / 15 cm working length

2800-0006 periosteal  
2800-0007 corrugator



**Ramirez Type Endoscopic Plastic Forehead Procerus Punch**

Malleable / straight / vertical tip / 15 cm working length

2800-0003

Malleable / straight / horizontal tip / 15 cm working length

2800-0008



**Ramirez Type Endoscopic Plastic Forehead Corrugator Grasper**

Malleable / straight / vertical tip / 15 cm working length

2800-0004

Malleable / curved / horizontal tip / 15 cm working length

2800-0009



**Ramirez Type Endoscopic Plastic Facelift Needle Holder**

Malleable / straight / vertical tip / 15 cm working length

2800-0005

Malleable / straight / horizontal tip / 15 cm working length

2800-0010





 Sontec Instruments®

ENT RONGEURS

**Sontec Dynamic Punch Rongeur**

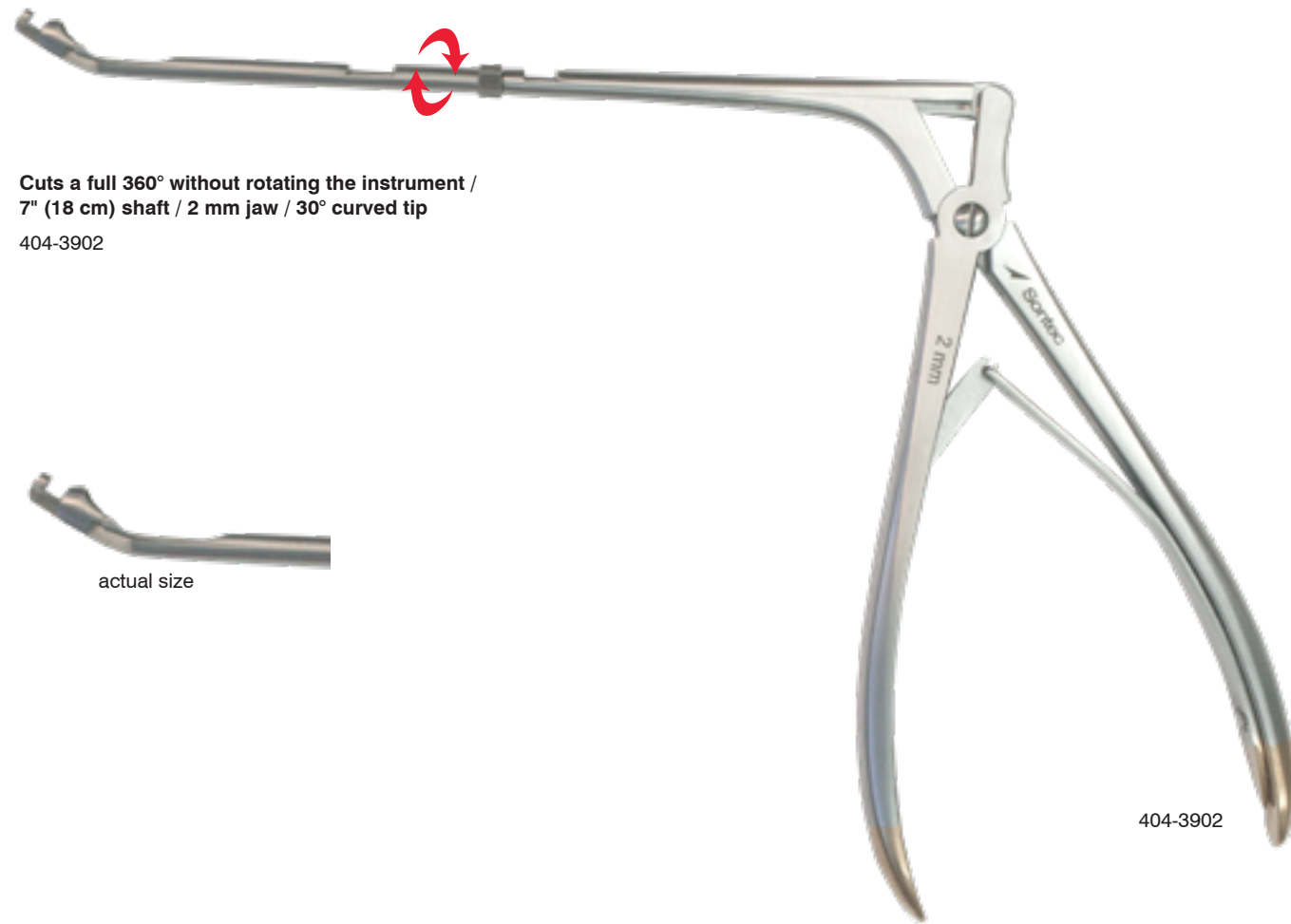

Cuts a full 360° without rotating the instrument /  
7" (18 cm) shaft / 2 mm jaw / 30° curved tip  
404-3902

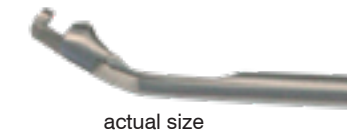

404-3902

**Hajek-Kofler Bone Punch Rongeur**

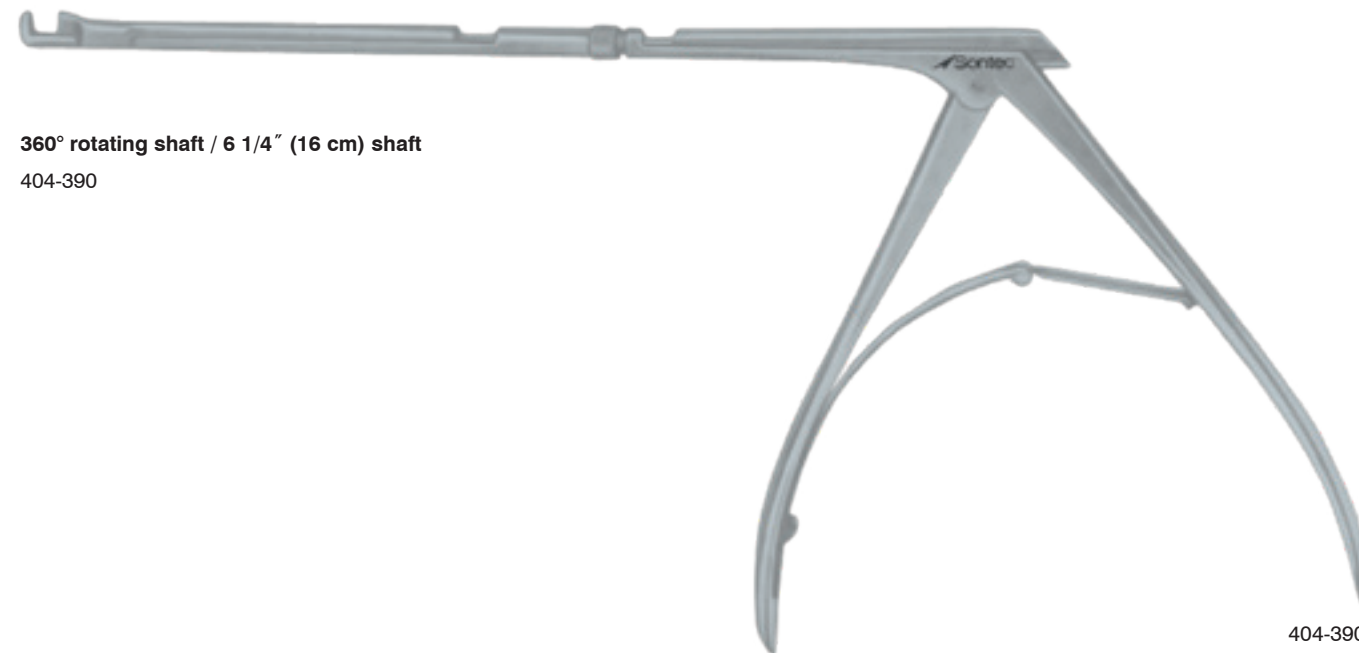

360° rotating shaft / 6 1/4" (16 cm) shaft  
404-390

404-390

**Frontal Ostium Nasal Rongeur**

70° curved up / 5 1/2" (14 cm) shaft  
468-010 2 mm x 2.5 mm jaw pediatric  
468-011 3 mm x 3.5 mm jaw  
468-012 5 mm x 5 mm jaw

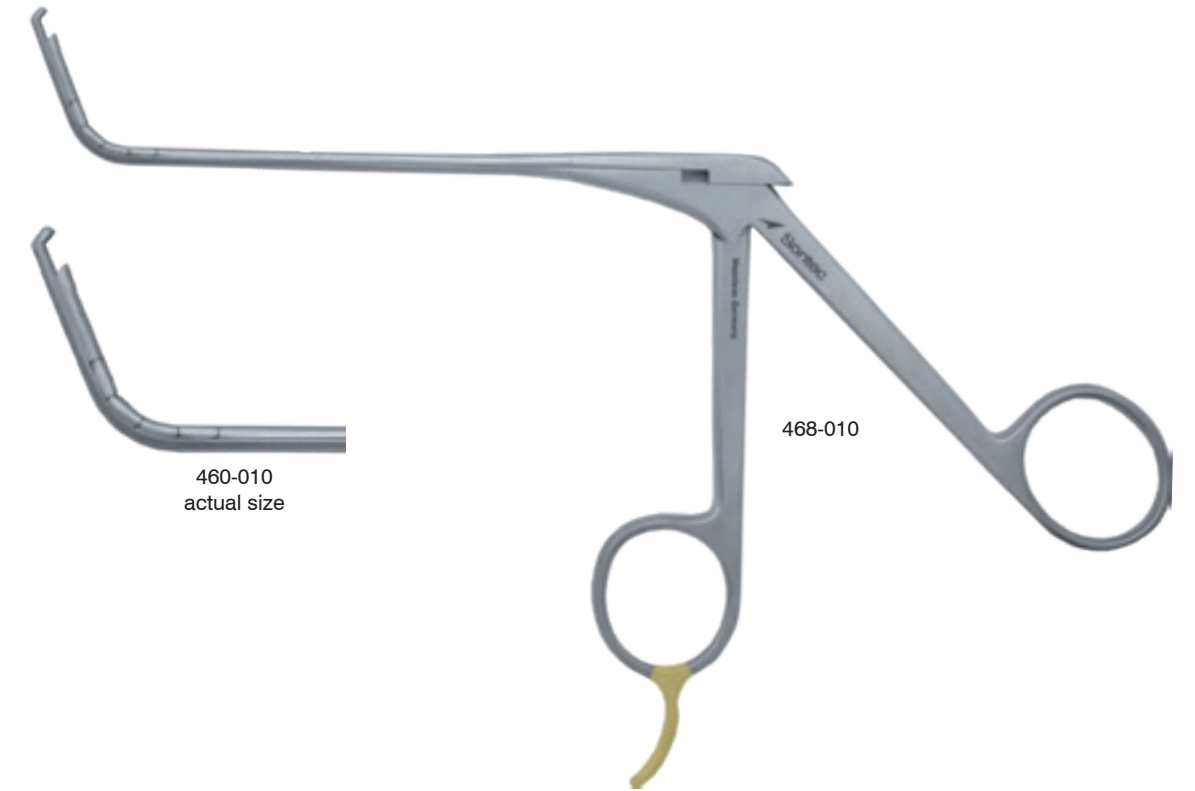

460-010  
actual size

468-010

**Lower Lateral Cartilage Morselizer**

7 1/2" (19.1 cm)  
468-515



468-515

**Weil Cut-Through Rongeur**

Fenestrated jaw / scissor action / straight / 4 1/2" (11.5 cm) shaft

- 468-649 2 mm x 5 mm jaw
- 468-650 2.5 mm x 5 mm jaw
- 468-651 3 mm x 5 mm jaw
- 468-660 3.6 mm x 8 mm jaw
- 468-670 4.8 mm x 14 mm jaw

Fenestrated jaw / scissor action / up-angled / 4 1/2" (11.5 cm) shaft

- 468-654 2.5 mm x 5.5 mm jaw
- 468-664 3.6 mm x 8 mm jaw
- 468-674 4.8 mm x 13 mm jaw

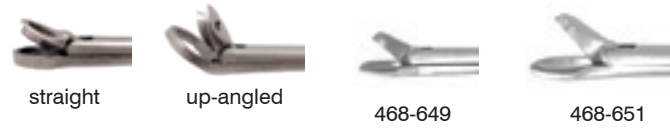

**Jansen-Middleton Septum Rongeur**

5 mm x 15 mm spoon-shaped cups / 7 1/2" (19 cm)

- 475-340
- 475-345 ergonomic handle

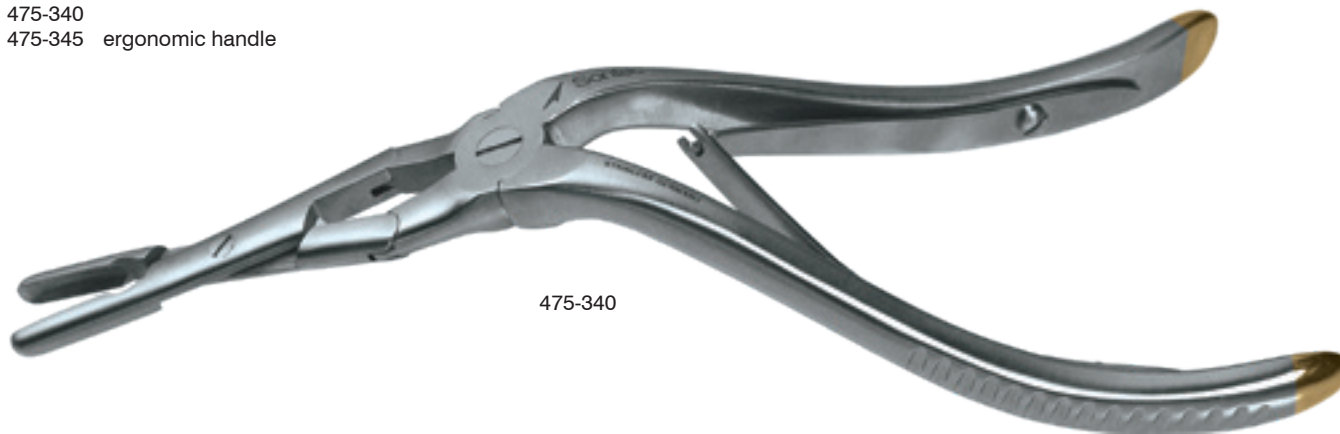

**Jansen-Middleton Septum Cut Through Rongeur Punch**

cut-through cups / ergonomic handle / 7 1/2" (19 cm)

- 475-350 4 mm x 19 mm
- 475-352 6 mm x 24 mm



**Sheen Fragment Retriever Forceps**



Low profile / 7" (18 cm)  
469-035

**Sontec Septal Platform Forceps**



7 1/4" (18.4 cm)  
467-332

**Classic Lempert Rongeur**

2.5 mm x 10 mm jaw

315-542	straight	6 1/4" (16 cm)
315-544	curved	6 1/4" (16 cm)
315-548	straight	7 1/2" (19 cm)
315-550	curved	7 1/2" (19 cm)

\* Additional Rongeurs available. Please call for styles, sizes & details



**Beyer Rongeur**

Double-action / curved / 7" (18 cm)

315-597	2.3 mm jaw
315-598	3.0 mm jaw
315-599	4.0 mm jaw

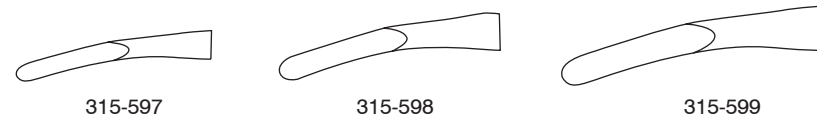
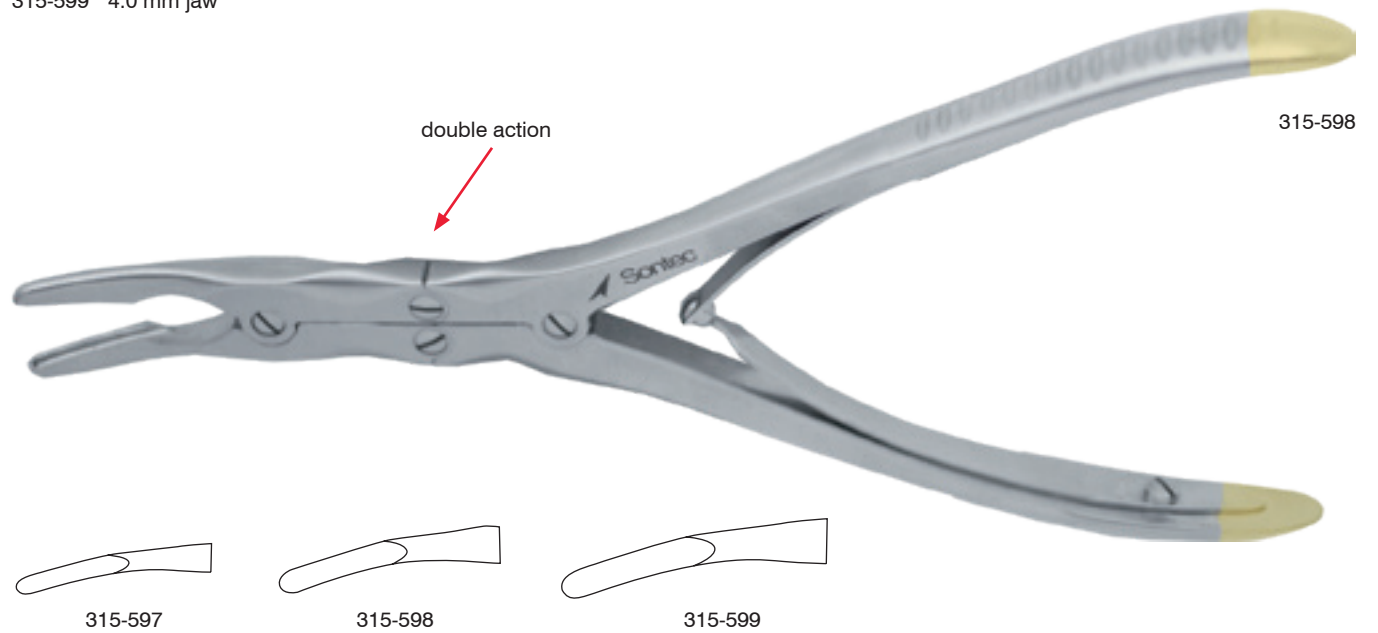

**Takahashi Rongeur**

**2.5 mm x 10 mm jaw cup / straight**

- 404-786 3 1/2" (9 cm) shaft
- 404-787 4 1/2" (11.5 cm) shaft
- 404-788 5 1/2" (14 cm) shaft

**3 mm x 10 mm jaw cup / 4 1/2" (11.5 cm) shaft**

- 404-788U up-angled
- 404-7871 straight

**3 mm x 8 mm oval jaw cup / straight**

- 404-7885 5 1/2" (14 cm) shaft

**3.5 mm x 10 mm jaw cup / straight**

- 404-7875 4" (10 cm) shaft



404-788U



404-7871



404-7875

**McIlwraith Cup Rongeur**

**Round cup / straight / 7" (18 cm) shaft**

- 1404-845A 2 mm cup
- 1404-845B 4 mm cup
- 1404-845D 6 mm cup

**Round cup / up-angled / 7" (18 cm) shaft**

- 1404-846A 2 mm cup
- 1404-846B 4 mm cup
- 1404-846D 6 mm cup



1404-846D



1404-845A



1404-845D

**Sheen Fragment Retriever Forceps**

**Low profile / 7" (18 cm)**

- 469-035

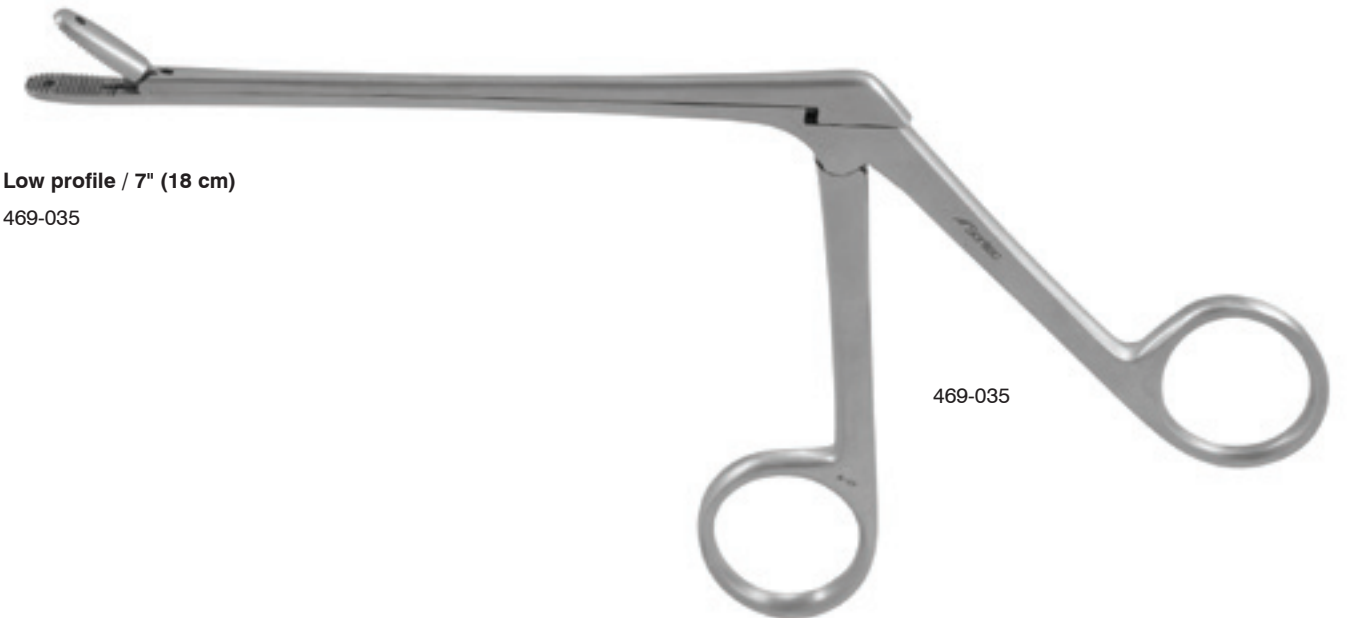

469-035



 Sontec Instruments®

ENT KNIVES

**McIlwraith Bistouri Knife**

**Button end blade**

1271-156C	curved	35 mm	6" (15 cm)
1271-156	straight	35 mm	6" (15 cm)
1271-155	curved	55 mm	7" (18 cm)
1271-154	straight	55 mm	7" (18 cm)



1271-156C



1271-156

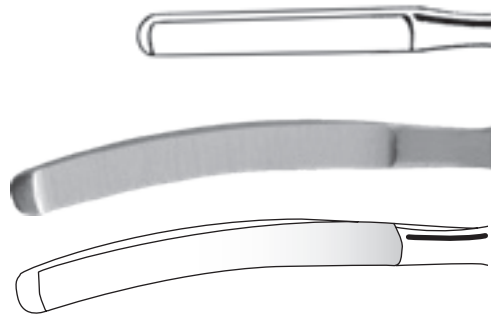

1271-155



1271-154

**Tendon Knife**

6" (17 cm) / double Sided / 21mm blade

1271-151	curved
----------	--------



1271-151

**Sexton-Gerzog Ear Knife**

6 3/4" (17.1 cm)

467-450	straight shaft
467-452	bayonet shaft
467-454	angle shaft



467-452

**Politzer Ear Knife**

7 1/4" (18 cm)

467-458	straight shaft
467-460	bayonet shaft
467-462	angled shaft



467-462



467-460

**Sickle Knife**

6 1/4" (16 cm)

467-461	straight	small blade 3 x 1mm
467-465	light curve	
467-467	straight	



467-461



467-465



467-467

**Fisher Tonsil Knife**

Serrated blade / 9" (22.9 cm)

485-675
---------



485-675

**Cottle Mucosa Knife**

6" (15 cm)

412-559
---------

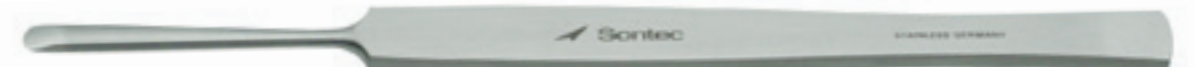

412-559

**Rosen Circular Blade Dissector**

6 1/4" (15.9 cm) / 45° angle tip

- 412-455 1.0 mm
- 412-456 1.4 mm
- 412-457 1.6 mm
- 412-458 2.0 mm
- 412-459 2.6 mm
- 412-460 2.8 mm
- 412-461 3.0 mm

6 1/4" (15.9 cm) / 90° angle tip

- 412-462A 1.5 mm
- 412-462B 2.0 mm
- 412-462C 2.5 mm
- 412-462D 3.0 mm



412-460

**Plester First Incision Knife**

6 1/4" (16 cm)

467-463



467-463

**Buck Myringotomy Knife**

6" (15 cm)

- 467-464
- 467-464A 90° angle



467-464

**Freer Mucosa Knife**

6 1/4" (16 cm)

345-405



345-405

**Jacobson Knife**

Micro blade / 6 1/2" (16.5 cm)

400-418



400-418

**Pashley Knife Set**

Curved blade / 6 3/4" (17 cm)

- 1467-456 straight
- 1467-460 angled right
- 1467-458 angled left



1467-458



side view



1467-460



side view



1467-456



side view

**Yasargil Arachnoid Knife**

7 1/4" (18.5 cm)

- 400-426 full curved
- 400-427 partial curved bayonet



400-426



400-427

**Yasargil Bayonet Arachnoid Knife Titanium**

7 1/4" (18.5 cm)

- 400-427T curved down
- 400-4271T curved up



400-427T



400-4271T

**Ballenger Swivel Knife**

7 1/4" (18.5 cm)

- 467-5303 straight 3 mm
- 467-5304 straight 4 mm
- 467-5305 straight 5 mm

8 3/4" (22 cm)

- 467-5313 bayonet 3 mm
- 467-5314 bayonet 4 mm
- 467-5315 bayonet 5 mm



swivel end

467-5304

**Ballenger Bayonet Swivel Knife**

3 mm / 7 1/4" (18.5 cm)

467-534T



467-534T

**Joseph Tendon Knife**

6 1/2" (16.5 cm)

- 345-400 single edge 60° angled



345-400

**Joseph Nasal Knife**

Button end / straight / 6" (15 cm)

345-402



345-402

**Blair Skin Graft Knife**

W/ thickness gauge

- 199-600 6" (15 cm)
- 199-602 4" (10 cm)

Blades

- 199-604 blades for 6" (15 cm)
- 199-606 blades for 4" (10 cm)



199-600



199-604

**Skin Holding Plate**

4, 5, 8, 10 cm

475-950

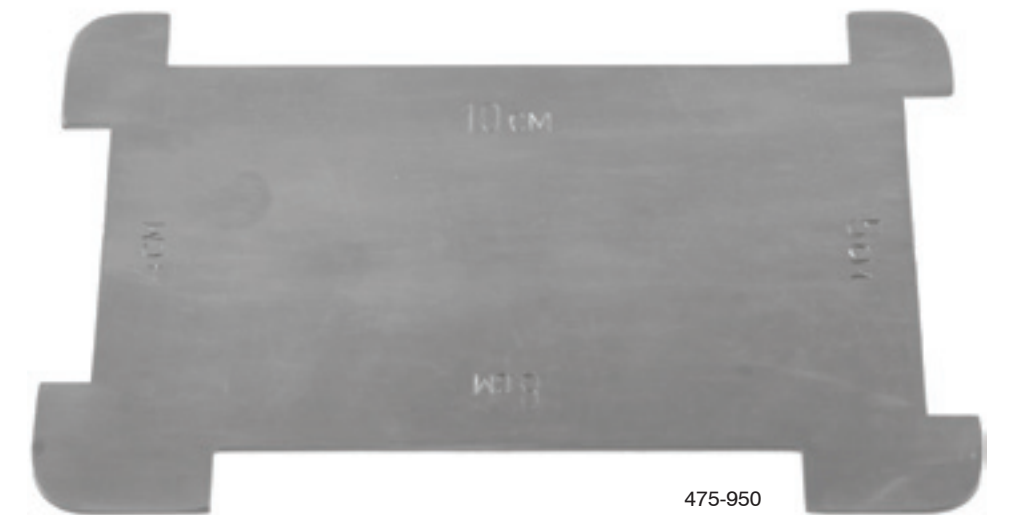

475-950



 Sontec Instruments®

CALIPERS & RULERS

**Castroviejo Caliper**

Scale to 20 mm / 3 1/2" (9 cm)

12-9200	straight	original with wider shanks
12-9300	straight	
T12-9300	straight	titanium
12-9300D	straight	deluxe
12-9305	angled 45°	
12-9310	curved	
12-9310D	curved	deluxe
12-9315	angled	
12-9316	straight	40 mm scale
12-9318	angled	40 mm scale

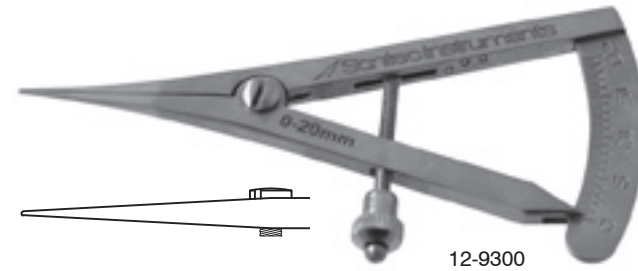

12-9300

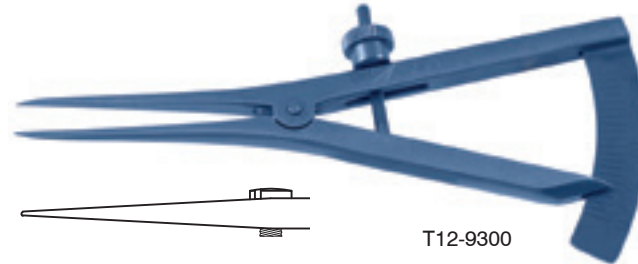

T12-9300



12-9200



12-9300D



12-9305



12-9310D

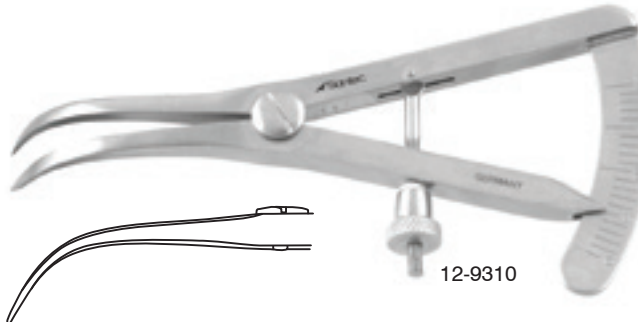

12-9310



12-9316

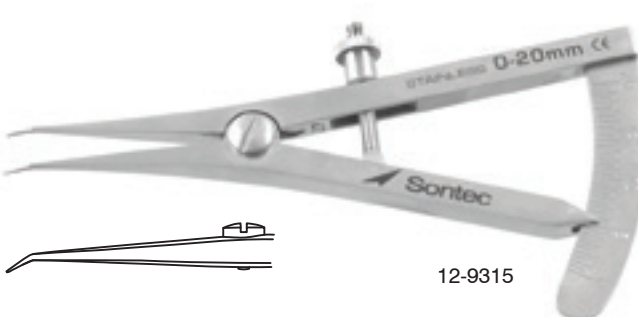

12-9315

**Finger Goniometer**

5 3/4" (14.5 cm)

350-915

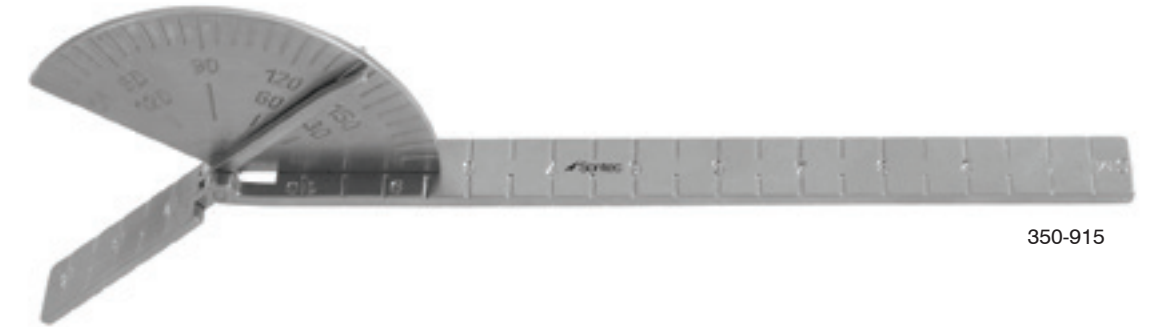

350-915

**Castroviejo Body Caliper**

0-200 mm gauge / 0-100 mm gauge

12-9330	100 mm
12-9335	200 mm



12-9330



12-9335

**Castroviejo Caliper**

40 mm / 7" (17.8 cm)

12-9320	straight
13-9325	angled



12-9320

**Jameson Caliper**

Scale to 3" (8 cm)  
12-9450

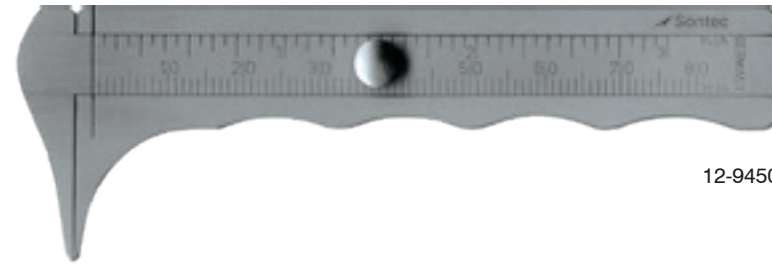

12-9450

**Thorpe Caliper**

Scale to 3" (8 cm) /  
angled / markings in  
0.5 mm increments  
12-9400



12-9400

**Orthopedic Vernier Caliper**

Stainless steel / 6" (15.5 cm)  
1103-170

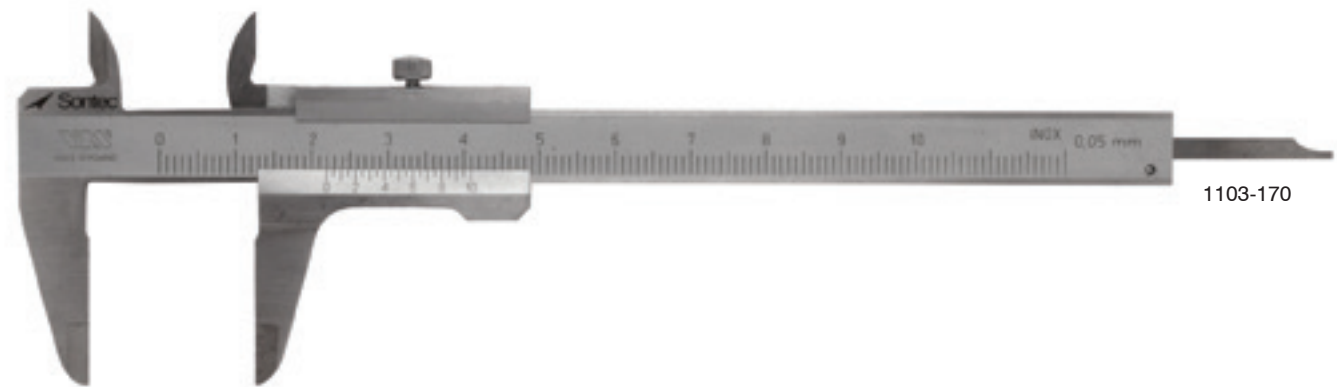

1103-170

**Braun Fixed Caliper**

8 cm / special sizes made to order  
12-9340



12-9340

**Stahl A/C Lens Gauge**

For verifying diameter of A/C  
lenses in 1.5 mm increments /  
Teflon coated stainless steel  
12-9630

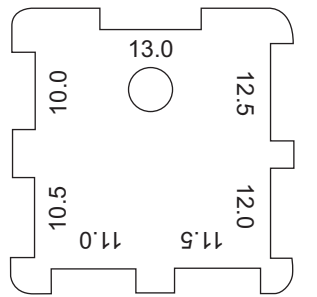

12-9600

**Stahl Caliper**

A/C caliper for  
measuring corneal  
diameter prior to A/C  
IOL / size markings  
on both sides  
12-9600



12-9630

**House Ear Caliper**

With rod mark / 6 1/4" (16 cm)  
1463-140 3.5mm  
1463-141 4mm  
1463-142 4.5mm  
1463-143 5mm

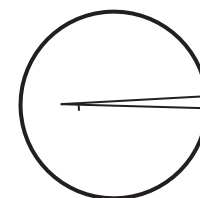

1463-142

**Schiotz Tonometer**

Autoclavable / original model  
18-8301 incline scale

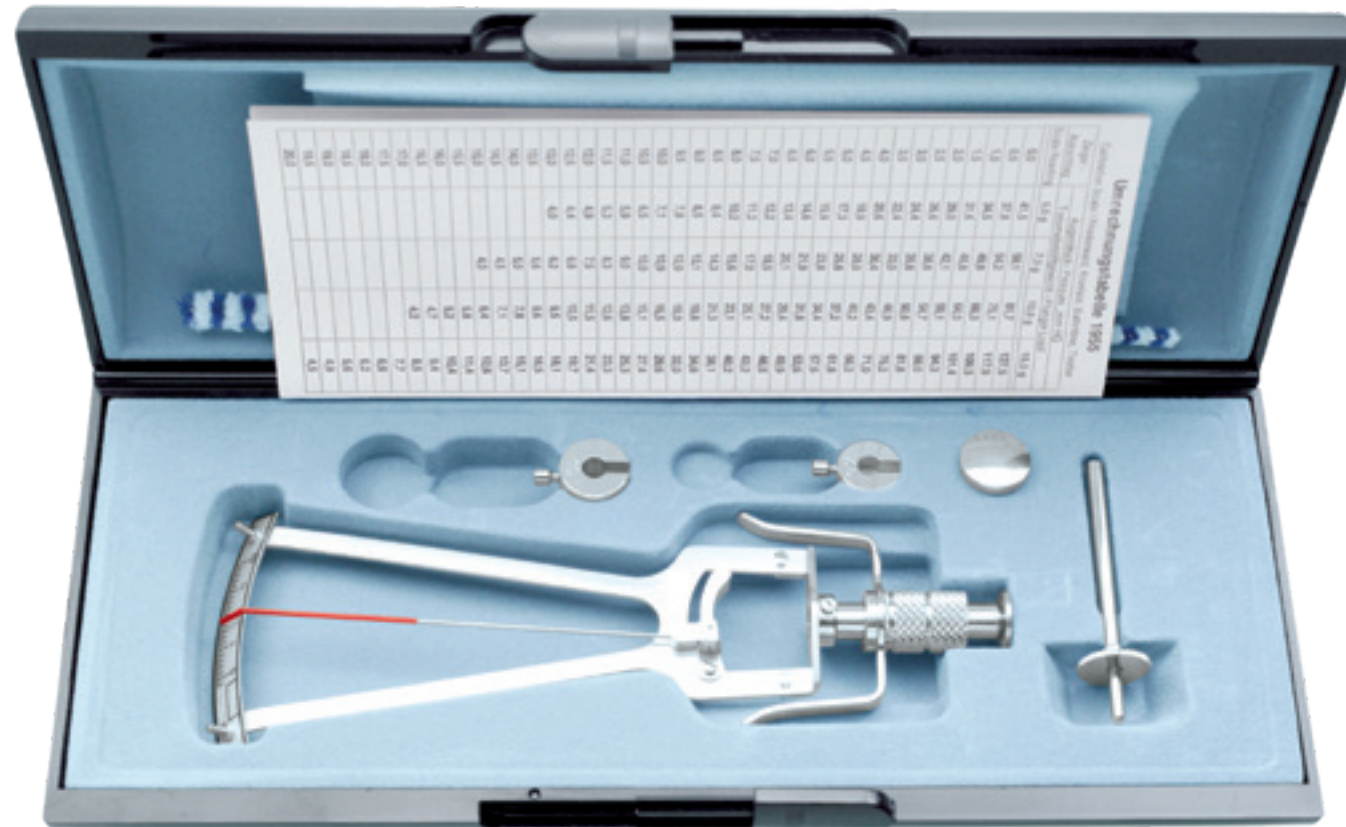

**Flexible Stainless Ruler**

6" (15 cm) / graduated in 1/32"  
fractions and millimeters  
12-9500

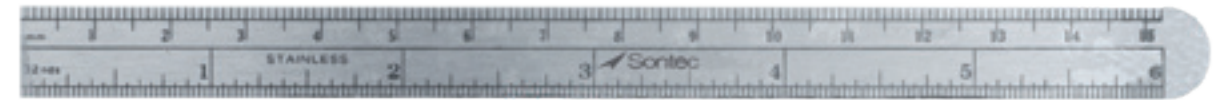

12-9500

**Punched Hole Gauge Ruler**

7" (18 cm) in length  
1106-190

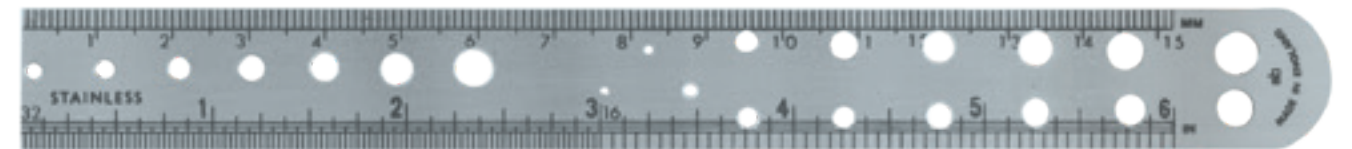

Back

1106-190



 Sontec Instruments®

RASPS

**Sontec®-Glabella Sculpting TC Insert Rasp**

TC / 7" (18 cm)  
345-246



345-246

**Webster Glabella Sculpting Rasp**

TC serrated tip / 4 mm x 8 mm / 8 1/4" (21 cm)  
345-246A



345-246A

**Foman TC Insert Rasp**

TC / double-ended / single-sided / 8 1/2" (21.5 cm)

- 345-289 9 / 10
- 345-287 7 / 8
- 345-285 5 / 6
- 345-283 3 / 4
- 345-282 2 / 3
- 345-281 1 / 2



345-282



345-289

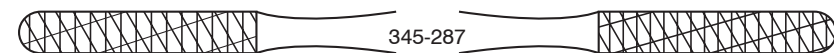

345-287

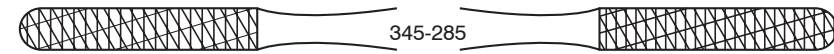

345-285

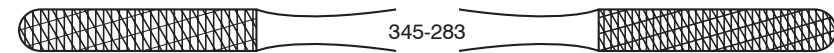

345-283

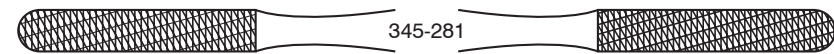

345-281

**Miller Rasp**

Concave / single ended / TC / 8" (20.25 cm)  
345-305



345-305

**Kistler Ear Cartilage Rasp**

Curved / 6 1/2" (16.5 cm)

- 475-618L left
- 475-618R right



475-618L



475-618R

**Rhinoplasty Rasp**

**Straight / 7 3/4" (20 cm)**

- 345-312 teeth down
- 345-314 teeth up



345-312



345-314

**Maltz Improved Double Ended Rasp**

**Single-sided / up & down rasping / 8 1/4" (21 cm)**

1103-235



1103-235

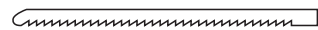

**McCollough Twist Fomon Raspatory**

**Double-Ended-Single-Ended / TC / 8 1/2" (21.6 cm)**

- 345-350 #2/3
- 345-352 #4/6



345-352

**Sontec Ear Rasp Set**

**Serrated / 6" (15.2 cm)**

- 475-596 curved left
- 475-598 curved right

**7 1/4" (18.5 cm)**

- 475-610 curved right
- 475-605 curved right serrated
- 475-600 curved left serrated
- 475-615 set of all three



475-596



475-598



475-610



475-605



475-600

**Foman Rasp**

Serrated / double ended / single sided / 8" (20.3 cm)

- 345-290 1 / 2
- 345-291 3 / 4
- 345-292 5 / 6
- 345-293 7 / 8
- 345-294 9 / 10



**Foman Rasp**

TC serrated / single ended / 9" (22.9 cm)



- 345-2951 #1
- 345-2952 #2
- 345-2953 #3
- 345-2954 #4
- 345-2955 #5
- 345-2956 #6
- 345-2957 #7
- 345-2958 #8
- 345-2959 #9
- 345-2950 #10

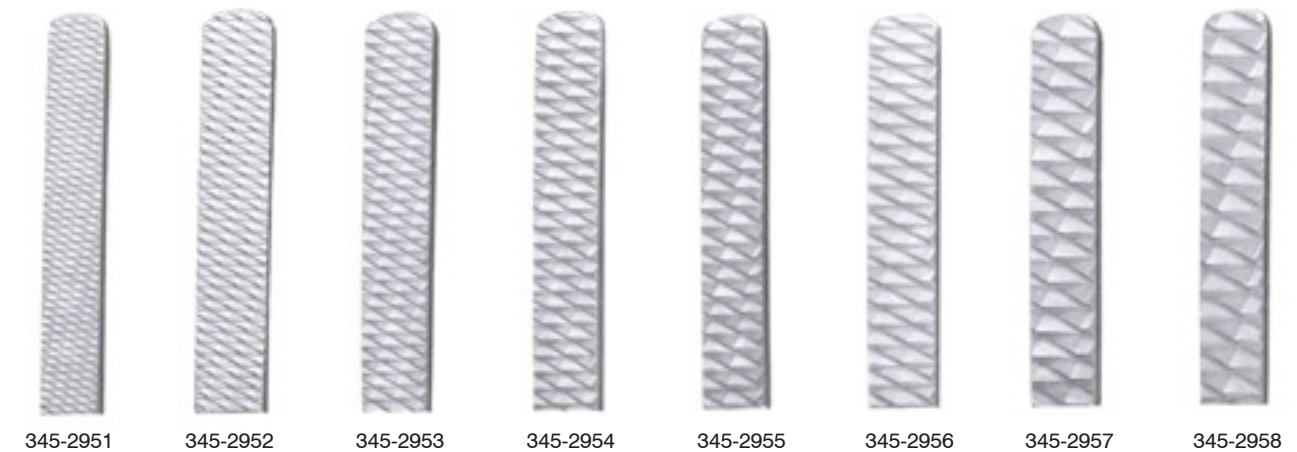

**Foman "R" Rasp**

Double ended / TC / 8 1/4" (21 cm)

345-279



**Polokoff Bone Rasp Double-Ended Single-Sided**

- 1103-241 5.5 mm / 6 mm 8"
- 1103-242 3 mm / 4 mm 7 1/2"



**Howard Bone Rasp Double-Ended Single-Side**

7 1/8"

- 1103-223 #12
- 1103-225 #12A
- 1103-226 #12CA



**Miller Bone Rasp Double-Ended Single-Sided Serrated**

7"

- 345-241 5 mm / 6 mm #33
- 345-242 3 mm / 4 mm #64
- 1103-233 6 mm / 7 mm #10



**Miller Bone Rasp Double-Ended Single-Sided**

7 1/2"

- 1103-229 6 mm / 7 mm #45



**Miller Rasp**

Concave / single ended / TC / 8" (20.25 cm)

- 345-305



**Sontec-Miller TC Insert Rasp**

Double-ended / TC / 7 1/8" (18.25 cm)

- 345-300 serrated
- 345-302 cross-serrated



**Miller Cross Serrated Rasp**

Double-ended / cross-serrated / up & down rasping / 7 1/8" (18.25 cm)

- 1103-232 4 mm & 4 mm wide
- 1100-490C 5 mm & 6 mm wide
- 1103-225C 5 mm & 7 mm wide
- 1100-491 6 mm & 7 mm wide



**Miller Parallel Serrated Rasp**

Double-ended / regular cut / down rasping  
/ 7 1/8" (18.25 cm)

- 1103-228 4 mm & 4 mm wide
- 1100-490 5 mm & 5 mm wide
- 1103-238 5 mm & 7 mm wide
- 1103-236 5 mm & 8 mm wide
- 1103-237 6 mm & 7 mm wide

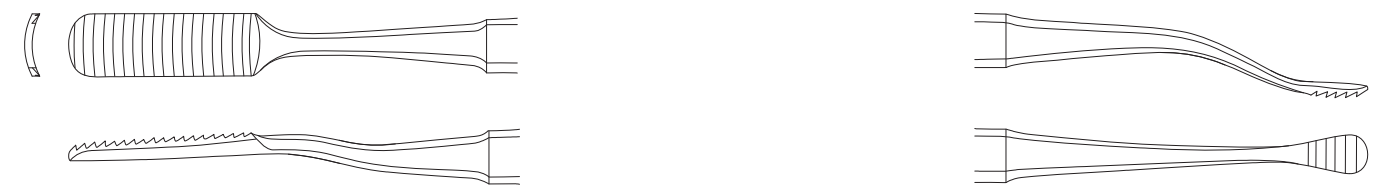

**Sontec Micro Rasp**

Single-ended / double-sided / 5 1/2" (14 cm)

- 345-265 straight 2.1 mm x 30 mm x 1 mm
- 345-264 curved 3.2 mm x 30 mm x 2.5 mm

Single-ended / single-sided / special order

- 345-266 5 1/2" (14 cm) 3 mm x 30 mm x 2.0 mm
- 345-267 7" (18 cm) 3 mm x 30 mm x 2.0 mm



**Nail Rasp**

Single-sided /  
6 3/4" (17 cm)

- 345-243



**Maltz Single-Ended Rasp**

Single-sided / 7" (18 cm)

- 345-310 reverse
- 345-311 forward cut



**Masing Rasp**

Single ended / straight  
/ TC / 7 3/4" (19.5 cm)

345-289R course  
345-338 fine



345-289R



345-338

**Sontec Diamond Surface Rasp**

7 3/8" (18 cm)

345-345 straight  
345-346 curved



345-345



345-346

**Sontec®-Glabella Sculpting TC Insert Rasp**

TC / 7" (18 cm)

345-246



345-246

**Webster Glabella Sculpting Rasp**

TC serrated tip / 4 mm x 8 mm / 8 1/4" (21 cm)

345-246A



345-246A

**Obwegeser Fenestrated Serrations Rasp**

Double-ended / flat, straight / infinity cut / 7 1/2" (19 cm)

345-320 fine grit  
345-322 medium grit



345-322

Double-ended / flat, curved / infinity cut / 7 1/2" (19 cm)

345-324 fine grit  
345-326 medium grit



345-326

Double-ended / concave / infinity cut / 7 1/2" (19 cm)

345-330 fine grit  
345-332 medium grit



345-332



 Sontec Instruments®

Plastic SPECIALTY

**Wright Fascia Needle**

With suture eye / sharp tip / 1 mm x 6 mm oval / 5 1/2" (14 cm)

10-4600



**Cottle-Walsham Forceps**

For septum straightening / straight / 9" (24.5 cm)

468-520



**Midface Dissecting Forceps**

Curved / 9" (22 cm)

438-630 7 mm

438-632 10 mm

438-634 17 mm

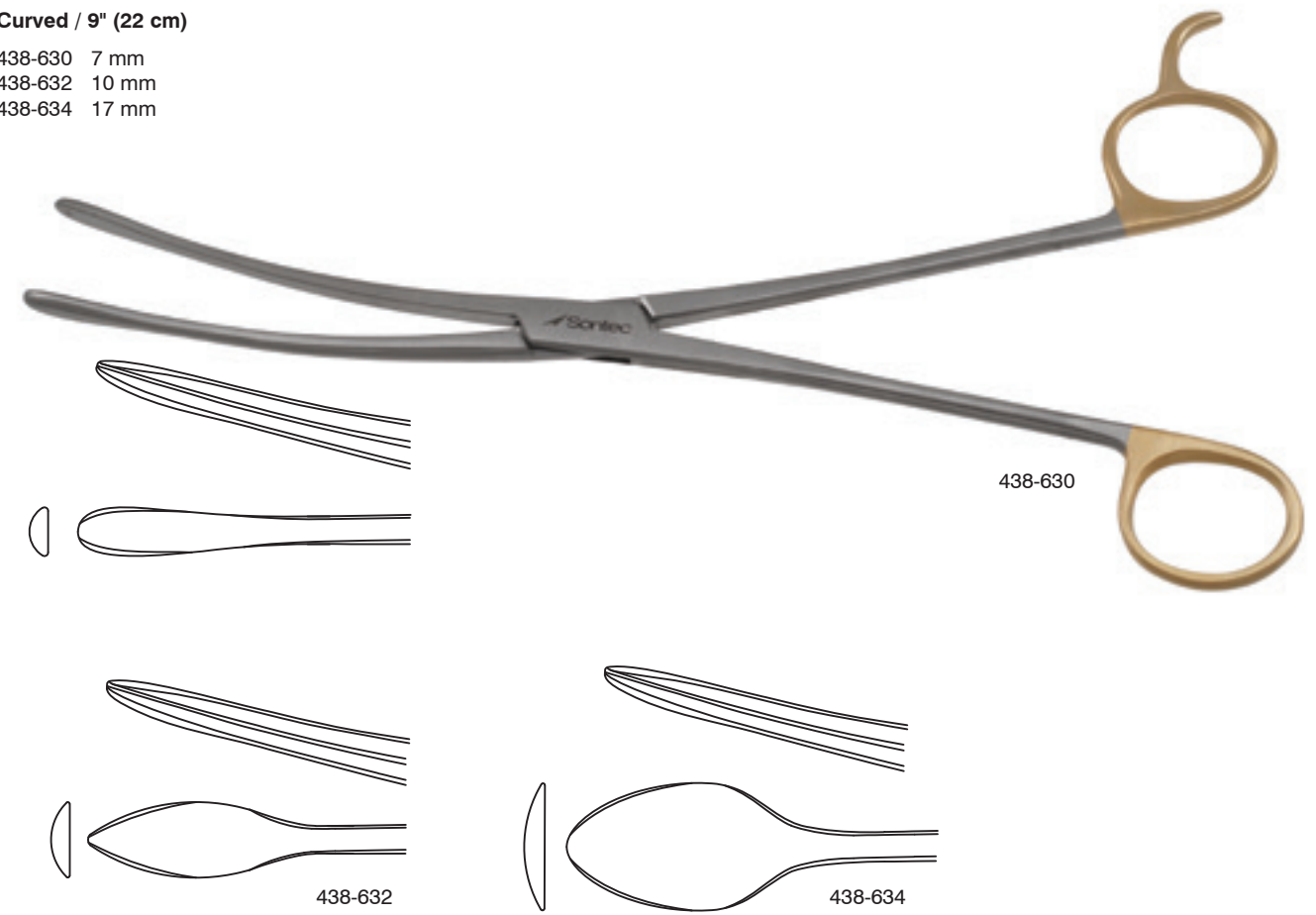

**Asch Septum Straightening Forceps**

Angled blades / 44 mm x 7 mm

468-522 9" (23 cm)

468-523 6 1/4" (16 cm)



**Tessier Bone Morselizing Forceps**

Concave/convex jaws / 8 3/4"  
468-521



468-521

**McCabe Facial Nerve Dissector**

Angle / smooth / 5 1/2"(14 cm)  
2200-437

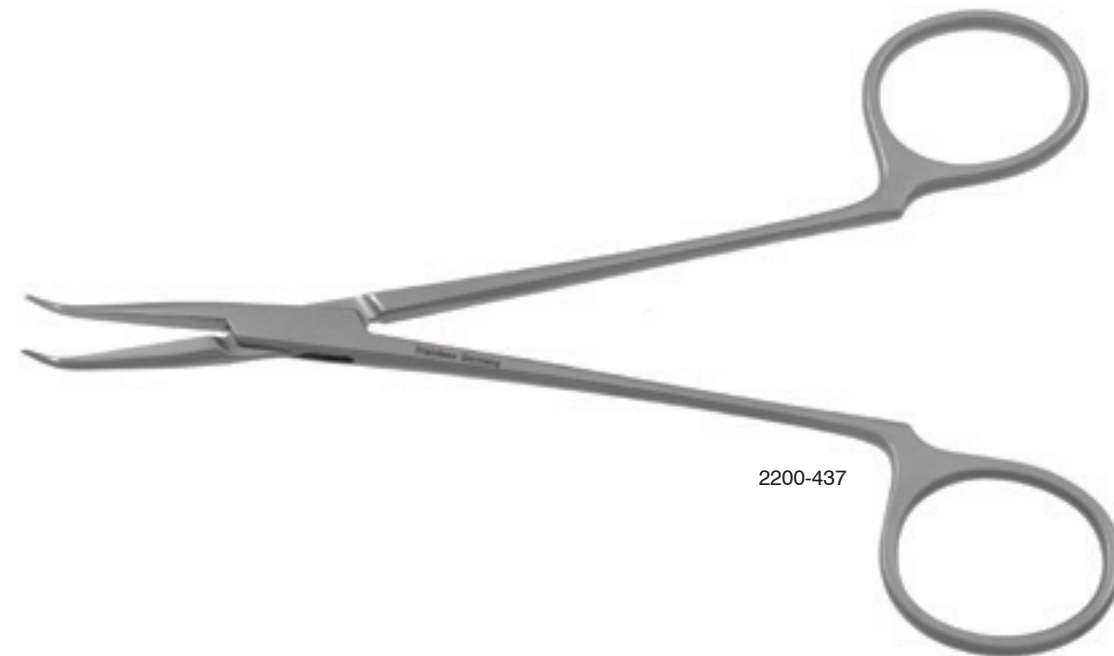

2200-437

**Rubin Septal Morselizer Forceps**

With jaw guard / 8"(20.5 cm)  
475-360

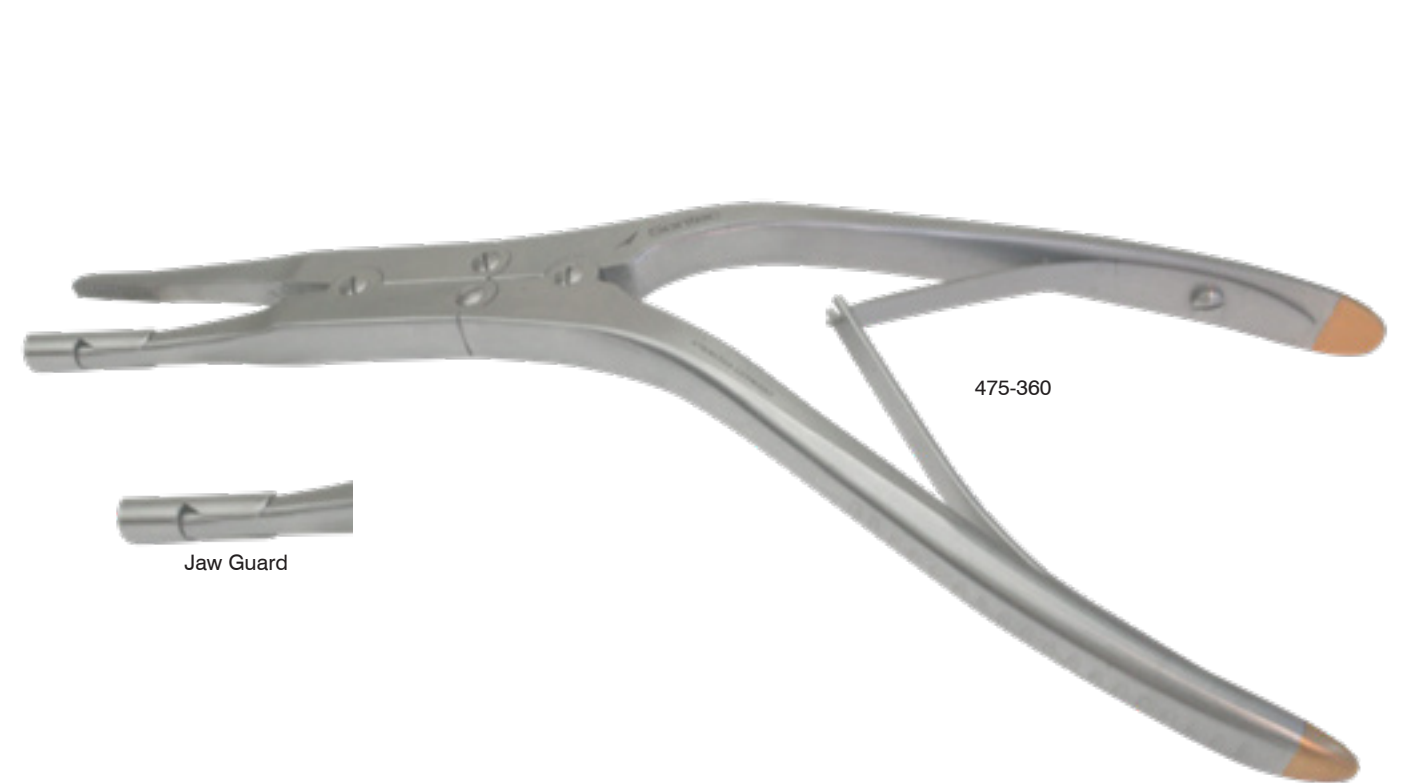

475-360

Jaw Guard

**Sontec® Universal Bottle Opener**

Easy to use / 7 1/2" (19 cm)  
1103-620



1103-620

**Freeman Areola Marker**

- 475-904 30 mm
- 475-899 34 mm
- 475-906 36 mm
- 475-900 38 mm
- 475-901 42 mm
- 475-902 45 mm
- 475-903 50 mm

- Sets
- 475-9071  
Includes sizes: 36 mm & 42 mm
  - 475-9072  
Includes sizes: 32 mm, 36 mm & 42 mm



**Sontec Areola Marker**

- 475-908 30 mm
- 475-909 34 mm
- 475-910 36 mm
- 475-911 38 mm
- 475-915 40 mm
- 475-912 42 mm
- 475-913 45 mm
- 475-914 50 mm



**Grossman Areola Marker**

- Aluminum / 4 sizes
- 475-895

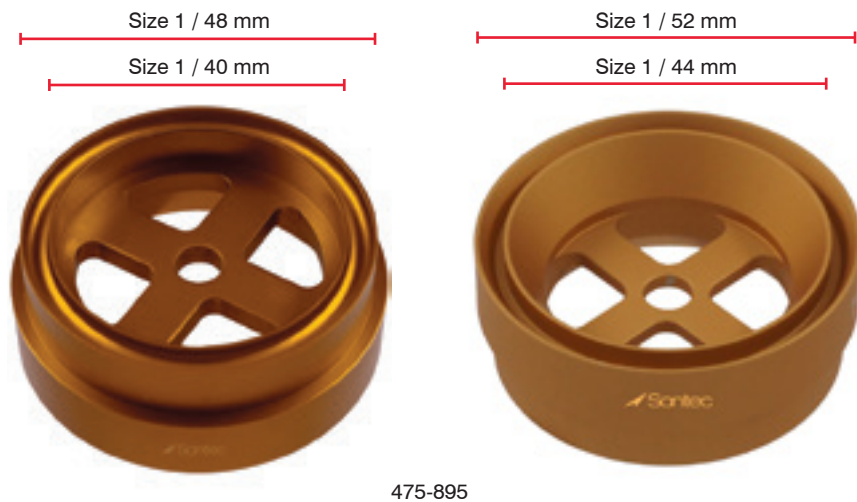

**Chang Quad Areola Marker**

- 38 mm & 42 mm
- 475-918



**Bone Grinder**

- 355-265



**Breast Reduction Marker**

475-916-SET  
 475-916S small  
 475-916M medium  
 475-916L large

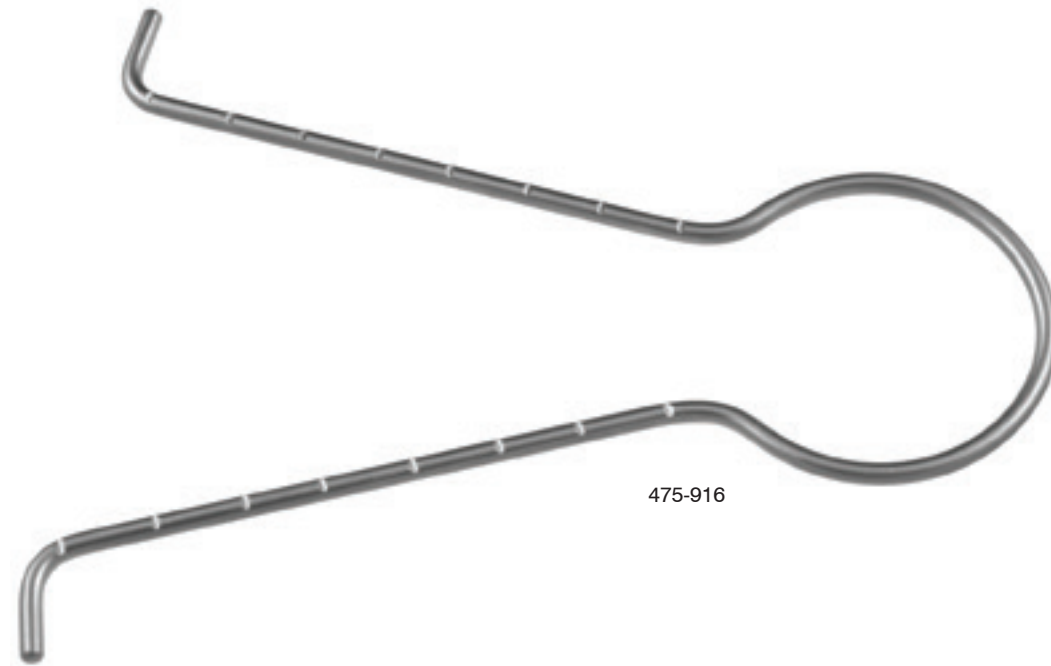

475-916

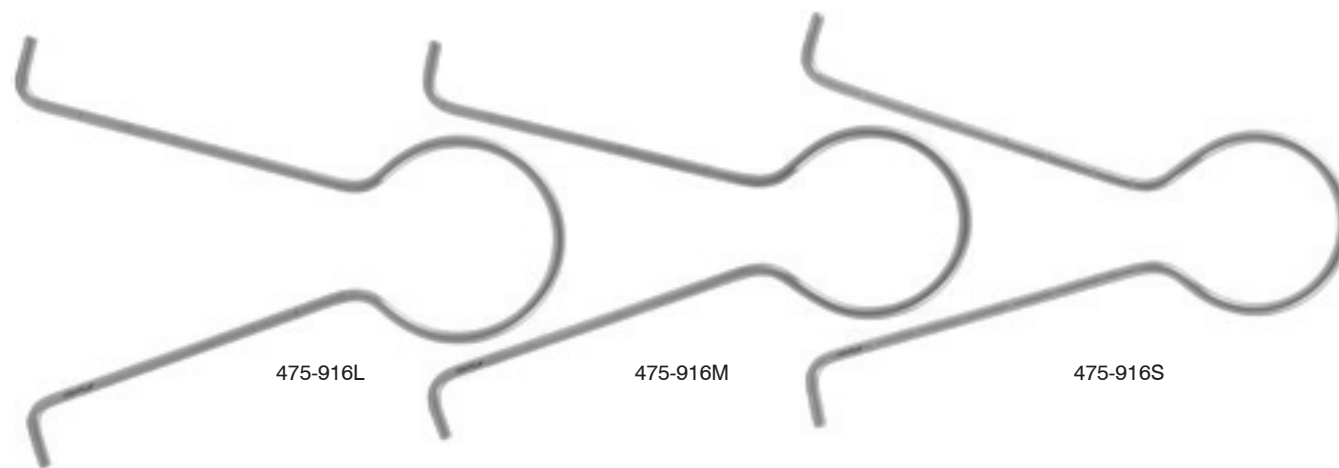

475-916L

475-916M

475-916S

**Lower Lateral Cartilage Morselizer**

7 1/2" (19.1 cm)  
 468-515



468-515

**Nasal Cartilage Punch Forceps**

6" (15 cm)  
 115-556



115-556

**Sontec Septal Platform Forceps**

7 1/4" (18.4 cm)  
467-332



**Sontec Septal Platform Forceps Titanium**

Serrated jaws / 11 mm x 21 mm / 7" (17.8 cm)  
469-033T



**Carroll Tendon Pulling Forceps**

4.5" shaft (11.4 cm) / serrated jaws  
350-805 curved down  
350-807 curved up

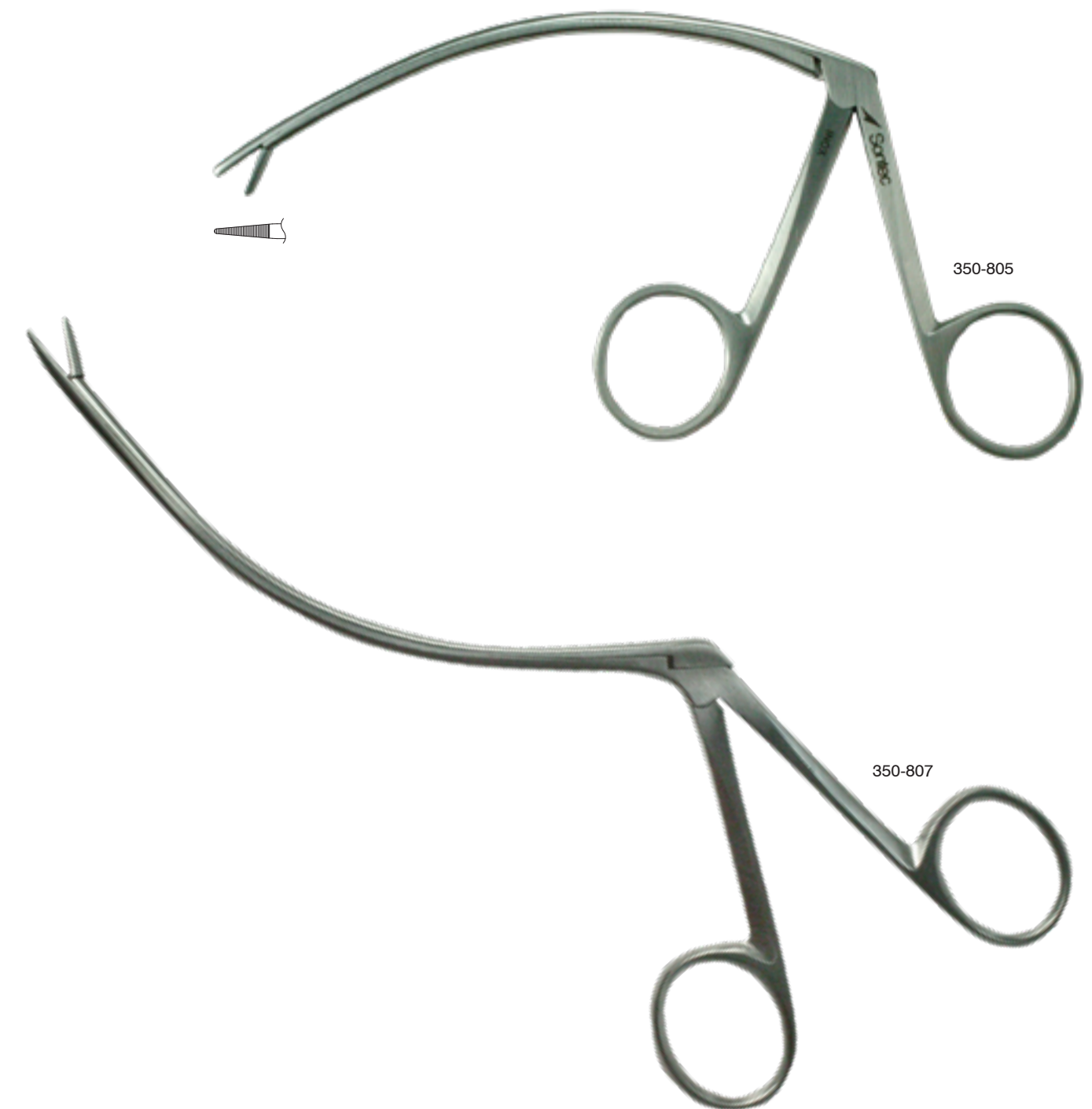

**Tendon Stripper**

4.5 mm / 9" (23 cm)  
350-790



350-790

**Sheehy Gelfoam Cartilage Press**

6 1/8" (15.6 cm)  
468-529 13 mm x 13 mm plate

7" (18 cm)  
468-531 11 mm x 14 mm plate  
468-541 22 mm x 30 mm plate

7 1/2" (19.1 cm)  
468-535 12 mm x 16 mm plate  
468-530 13 mm x 13 mm plate

8 1/4" (21 cm)  
468-540 13 mm x 20 mm plate



468-535

**Gubisch Cartilage Crusher**

350-851

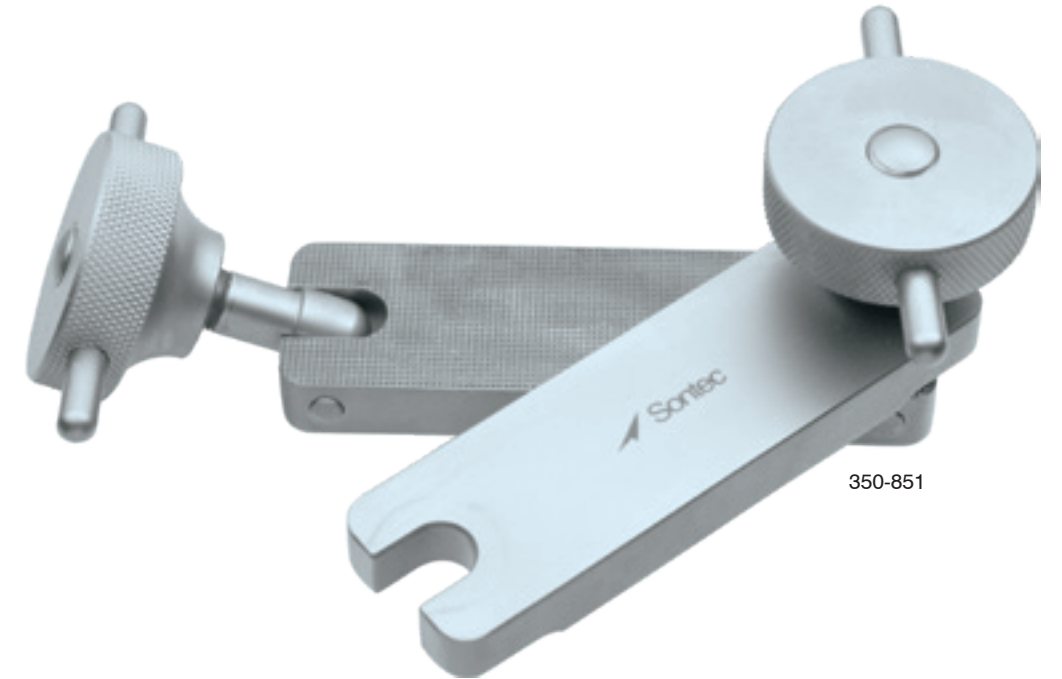

350-851

**Cartilage Cutting Block**

85mm x 55mm x 10mm / 4 set depths to create the perfect cut

350-8451    teflon  
350-8451S    stainless steel



350-8451



350-8451S

**Gruber Cartilage Teflon Cutting Block with Grid**

Black / 100 mm x 60 mm x 10 mm

350-8452



350-8452

**Gruber Cutting Block**

85 mm x 55 mm x 10 mm

350-8454    without grid    teflon  
350-8454T    with grid    titanium



350-8454



350-8454T

**Sheen Cartilage Cutting Grid**

Stainless steel / 70 mm x 40 mm x 2 mm

- 350-845 anodized black
- 350-846 bead blast finish

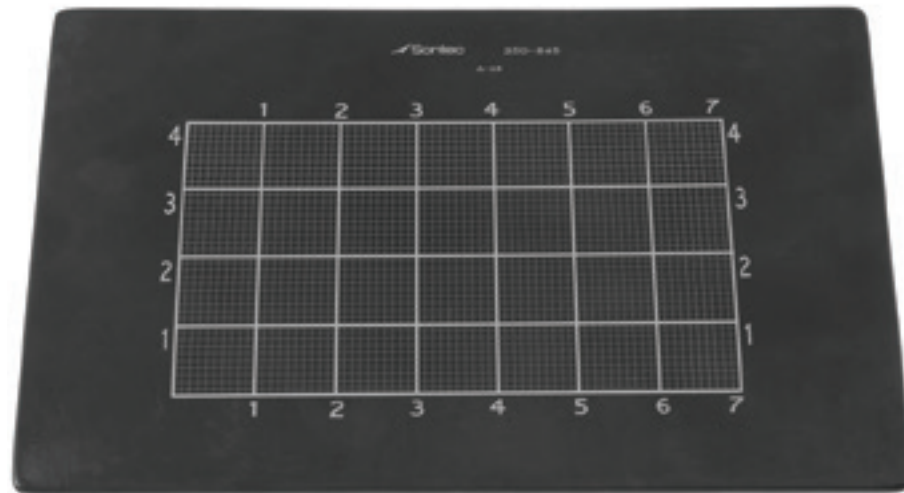

350-845

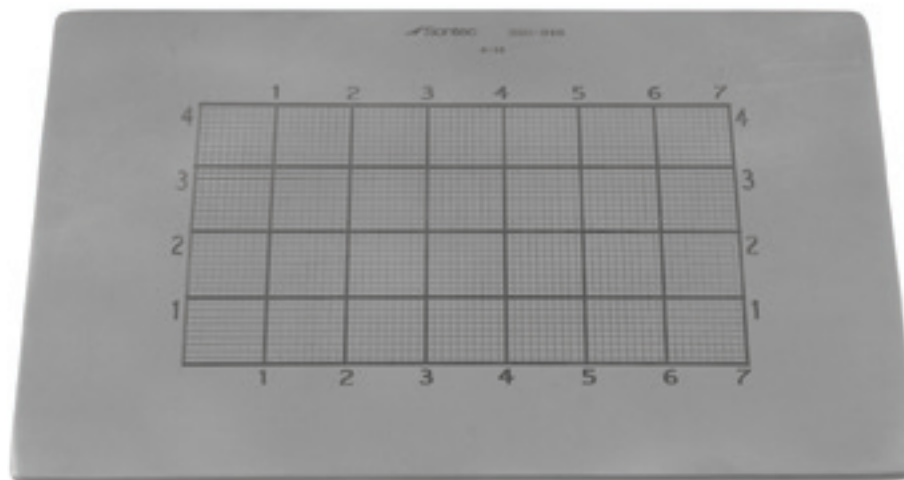

350-846

**Cartilage Cutting Block Titanium**

120mm x 120mm x 15mm

- 350-8453T



350-8453T

**Cottle Cartilage Crusher**

Original single serrated bed with tongs  
350-849

New / double-sided / dismantable /  
reversible / 1 smooth side 1 serrated side  
350-844

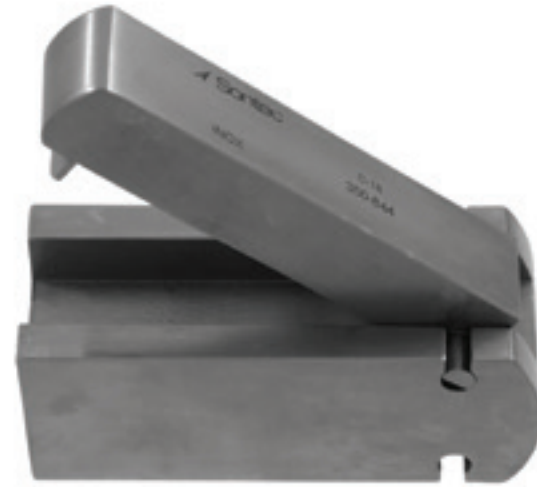

350-844 (side one)

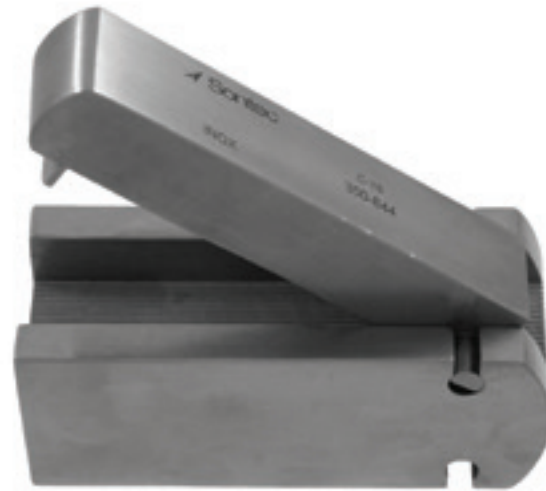

350-844 (side two)



350-849

**Cartilage Crusher**

Hand controlled crank / serrated bed  
350-850



350-850



open

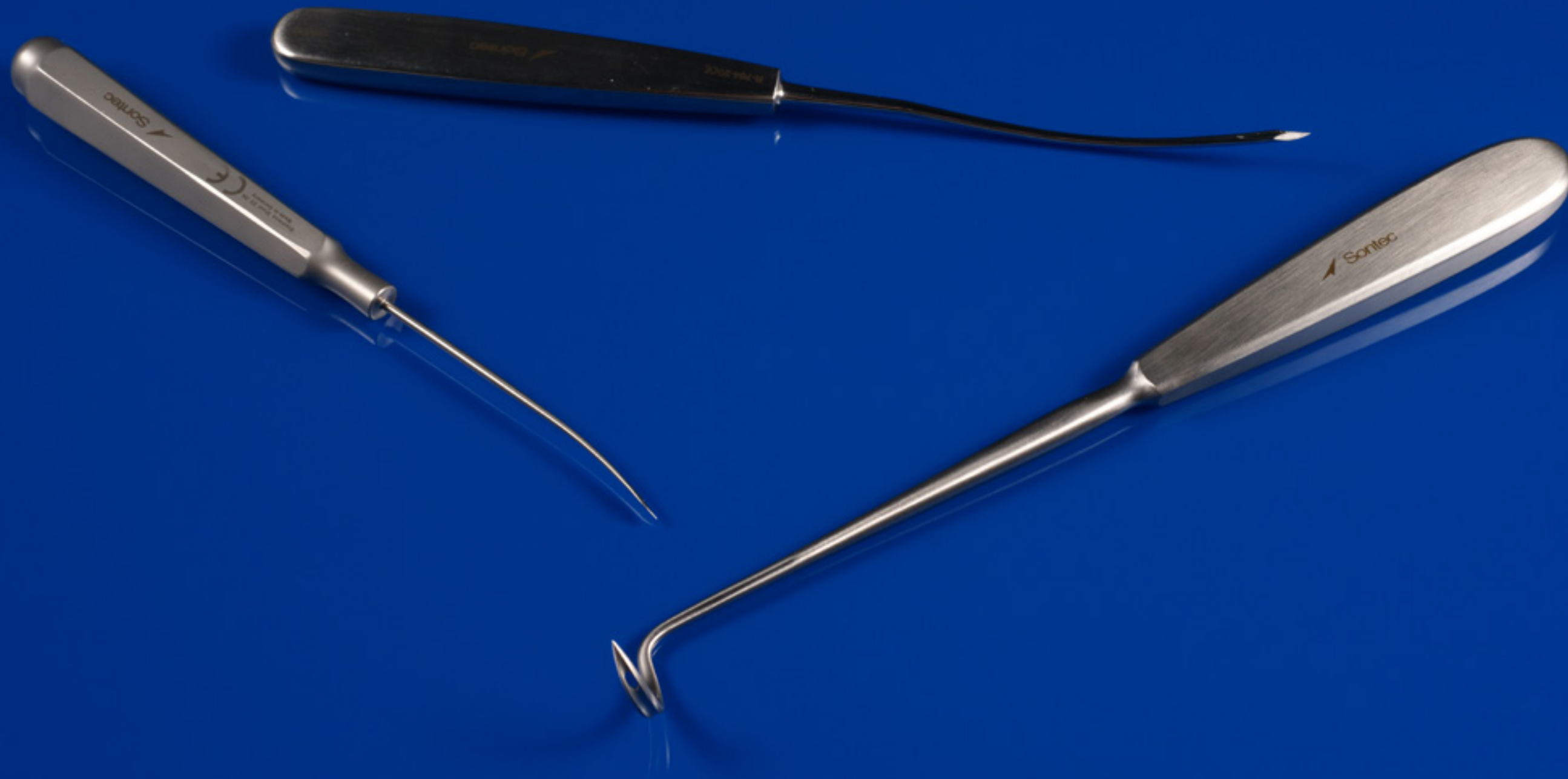

 Sontec Instruments®

Ligature Carriers

**Cassio Ligature Carrier**

Sharp / straight / 8" (20.5 cm)  
134-240

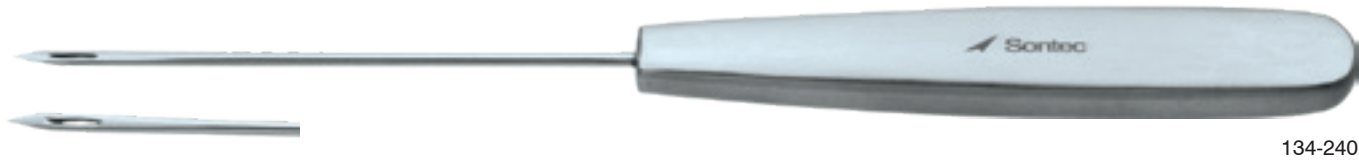

**Sontec Reverdin Blunt Needle/Ligature Carrier**

Blunt / curved / 8" (20.5 cm)  
134-242



**Reverdin Needle/Ligature Carrier**

Sharp / curved / 8" (20.5 cm)  
134-276



**Tendon Passer Ligature Carrier**

10.5" (26 mm) / 11" phenolic handle  
305-910



**Graft Passer Ligature Carrier**

**Curved**

1106-400	2 cm	extra small
1106-401	3 cm	small
1106-402	4.5 cm	large
1106-403	6 cm	extra large
1106-404	8cm	XX large

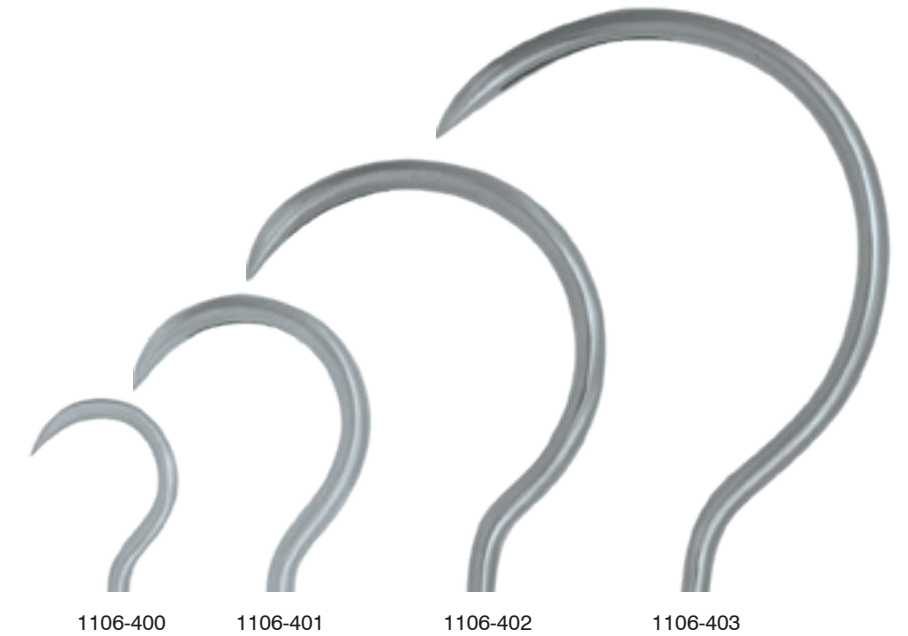

**Deschamps Ligature Carrier**

**Small / 25 mm / 8" (20 cm)**

- 134-277 sharp left
- 134-278 sharp right
- 134-280 blunt left
- 134-281 blunt right

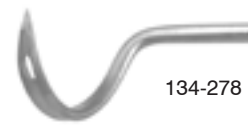

134-278

**Medium / 30 mm / 8" (20 cm)**

- 134-277M sharp left
- 134-278M sharp right
- 134-280M blunt left
- 134-281M blunt right

**Large / 35 mm / 9 1/2" (24 cm)**

- 134-282A sharp left
- 134-282B sharp right



134-277

**Schmieden-Dick Ligature Carrier**

**Malleable / 12 3/4" (32.5 cm)**

134-267



134-267

**Entner Ligature Carrier**

**Curved**

- 134-243 8.1/4" (21 cm)
- 134-245 6.1/2" (16.5 cm)



134-243

**Sanders Brown Ligature Carrier**

**10" (25 cm)**

134-248



134-248

**Eyebrow Lifting Ligature Carrier**

**11" (28 cm)**

134-268



134-268

**Facia Ligature Carrier**

**6" (15 cm)**

134-247



134-247



 Sontec Instruments®

SUCTION Selection

**Frazier Angled Suction**

Finger cut-off hole to control suction / angled / 7" (18 cm)

- 412-677 3 french
- 412-678 4 french
- 412-679 5 french
- 412-680 6 french
- 412-681 7 french
- 412-682 8 french
- 412-683 9 french
- 412-684 10 french
- 412-685 11 french
- 412-686 12 french
- 412-688 15 french

9" (23 cm)

- 412-705 10 french



Finger cut-off hole to control suction / angled / malleable / 7" (18 cm)

- 412-677M 3 french
- 412-678M 4 french
- 412-680M 6 french
- 412-681M 7 french
- 412-682M 8 french
- 412-683M 9 french
- 412-684M 10 french
- 412-685M 11 french
- 412-686M 12 french
- 412-688M 15 french

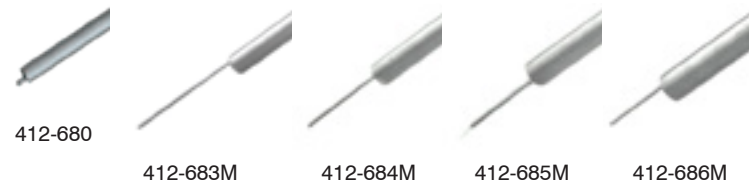

\* special order

Finger cut-off slot to control suction / angled / 7" (18 cm)

- 412-677L 3 french
- 412-678L 4 french
- 412-679L 5 french
- 412-680L 6 french
- 412-681L 7 french
- 412-682L 8 french
- 412-683L 9 french
- 412-684L 10 french
- 412-685L 11 french
- 412-686L 12 french



**Frazier Straight Suction**

Finger cut-off hole to control suction / straight / 7" (18 cm)

- 412-689 5 french
- 412-690 6 french
- 412-691 7 french
- 412-692 8 french
- 412-694 10 french
- 412-696 12 french

9" (23 cm)

- 412-700 6 french
- 412-701 7 french
- 412-702 8 french
- 412-704 10 french
- 412-706 12 french



**Frazier Insulated Suction**

Finger cut-off hole to control suction / angled / Insulated electro coated tube / 7" (18 cm)

- 412-677I 3 french
- 412-678I 4 french
- 412-679I 5 french
- 412-680I 6 french
- 412-681I 7 french
- 412-682I 8 french
- 412-683I 9 french
- 412-684I 10 french
- 412-685I 11 french
- 412-686I 12 french

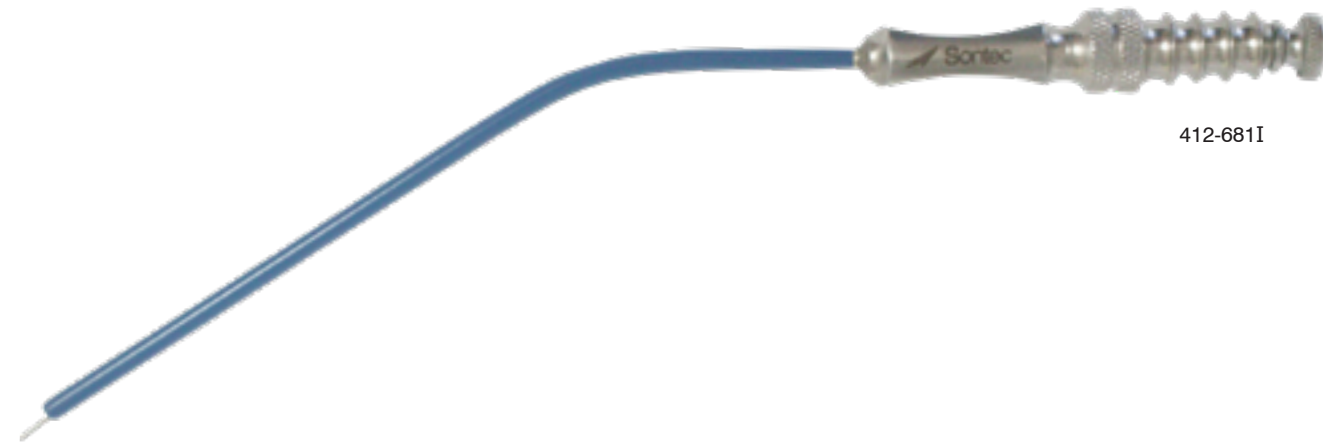

412-681I

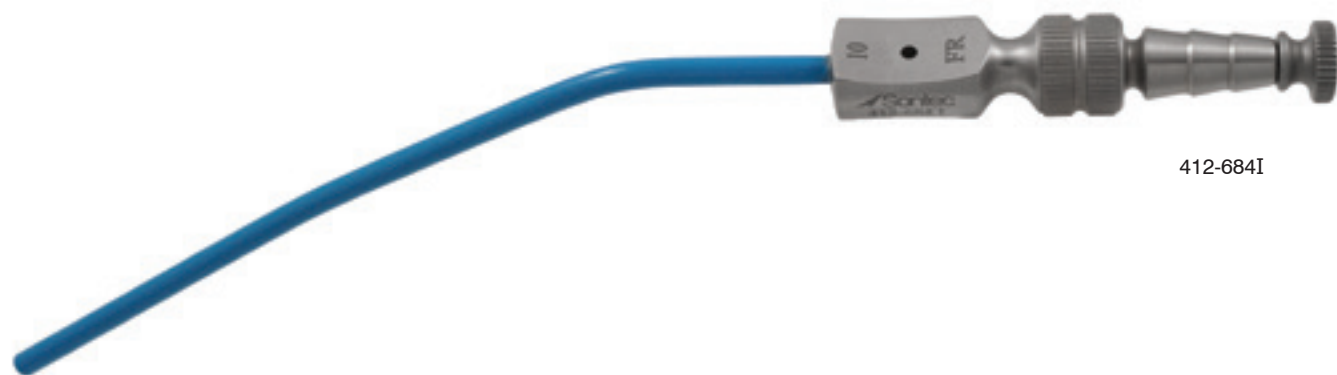

412-684I

**Fukushima Suction**

Tapered tube shaft / teardrop finger control / 7" (18 cm) working length

- 180-403 3 fr
- 180-404 4 fr
- 180-405 5 fr
- 180-406 6 fr
- 180-407 7 fr
- 180-408 8 fr
- 180-409 9 fr
- 180-410 10 fr
- 180-411 11 fr
- 180-412 12 fr

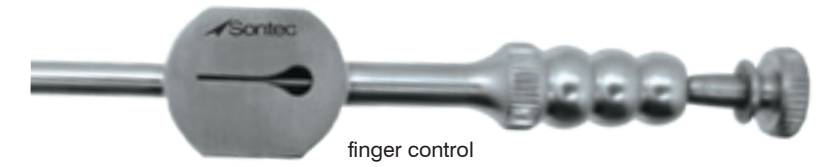

Tapered tube shaft / teardrop finger control / 8" (20.5 cm) working length

- 180-373 3 fr
- 180-374 4 fr
- 180-375 5 fr
- 180-376 6 fr
- 180-377 7 fr
- 180-378 8 fr
- 180-379 9 fr
- 180-380 10 fr
- 180-381 11 fr
- 180-382 12 fr

\* Also available in 6 1/2" sizes

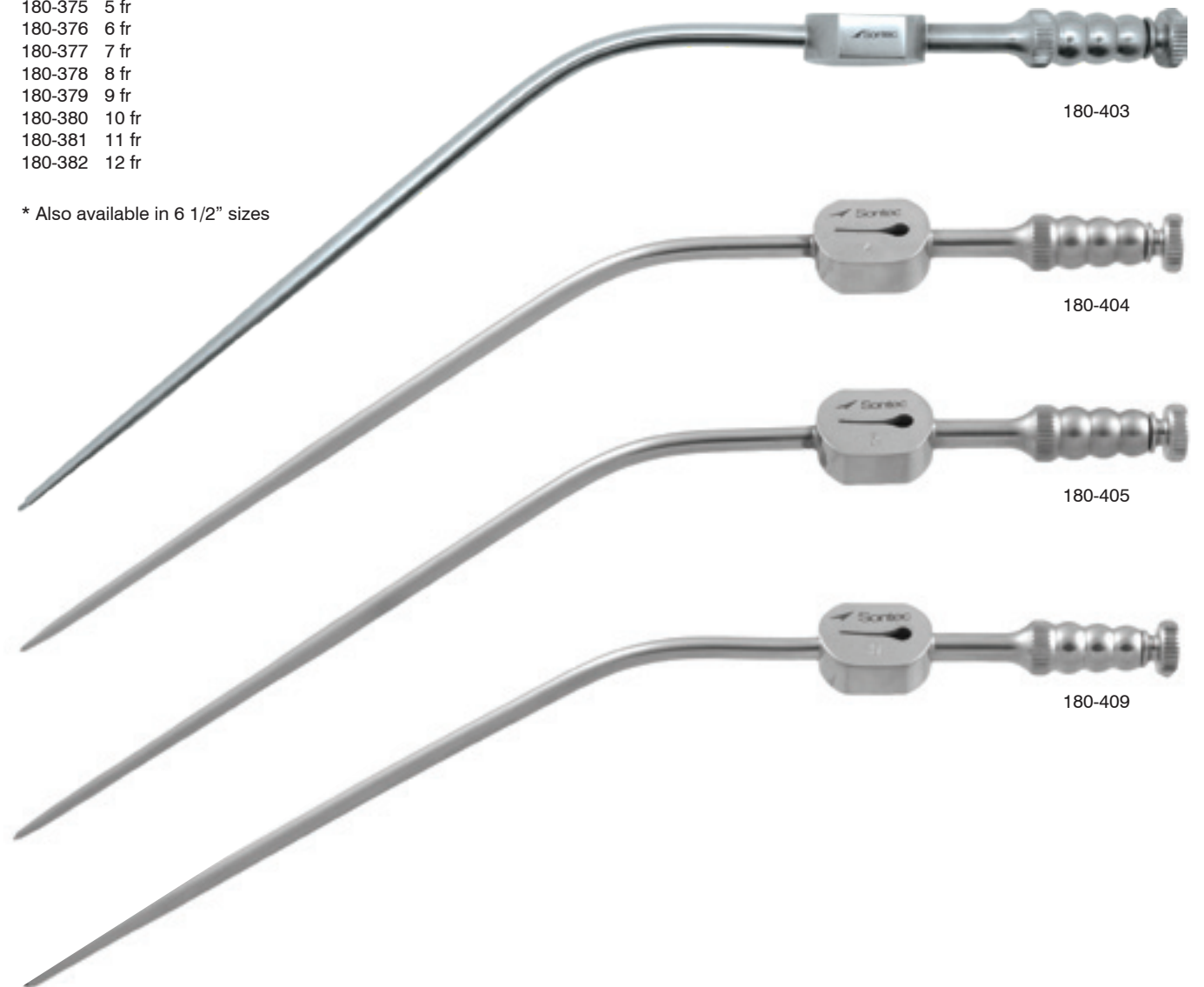

180-403

180-404

180-405

180-409

**Rhoton Micro Neuro Suction**

**Specially blunted atraumatic tips / 80 mm working length**

- 412-839 3 french
- 412-840 5 french
- 412-844 7 french
- 412-841 10 french



**100 mm working length**

- 412-845 3 french
- 412-848 5 french
- 412-846 7 french
- 412-847 10 french

**130 mm working length**

- 412-849 5 french
- 412-850 7 french
- 412-851 10 french
- 412-852 12 french

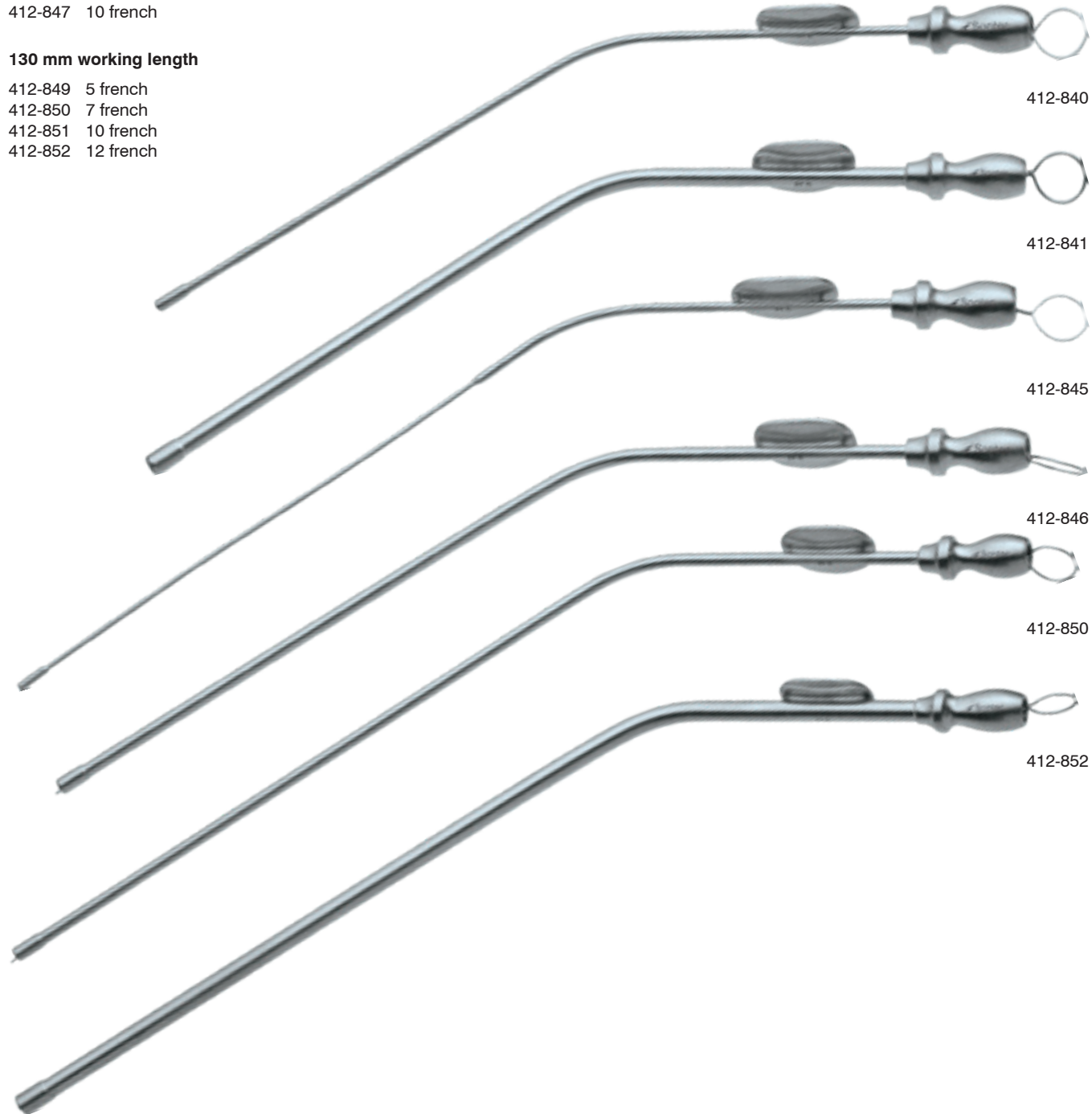

**Sontec Neuro Suction**

**tapered tubing for increased flow / short shaft / 3 hole finger control / 2 3/4" (7 cm)**

- 412-853 1.2mm tip
- 412-854 2mm tip
- 412-855 2.5mm tip

**Medium shaft / 3 hole finger control / 4" (10 cm)**

- 412-856 1.2mm tip
- 412-857 2mm tip
- 412-858 2.5mm tip

**Long shaft / 3 hole finger control / 5 1/2" (14 cm)**

- 412-859 1.2mm tip
- 412-860 2mm tip
- 412-861 2.5mm tip

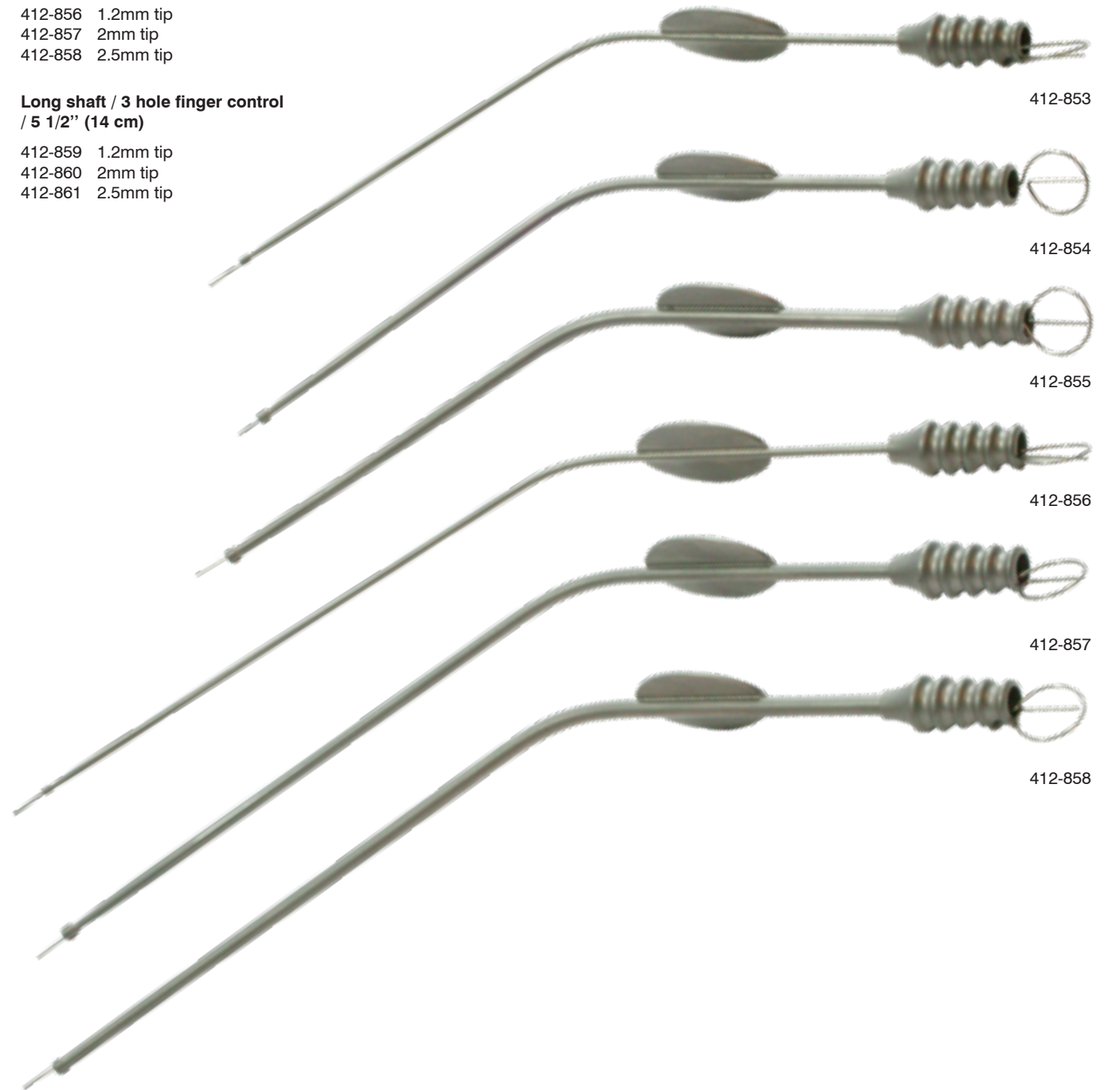

**Barnes Mini Suction Tube**

- 412-7081 1.5 mm tip
- 412-7082 1.7 mm tip
- 412-7083 2 mm tip
- 412-7084 3 mm tip



**Pashley-Frazier Suction**

Curved tip / 7" (18 cm)

- 1463-501 7 french curved right
- 1463-500 7 french curved left
- 1463-503 8 french curved right
- 1463-504 8 french curved left
- 1463-506 9 french curved right
- 1463-507 9 french curved left



**Modified Ferguson-Frazier Suction**

**Fenestrated oval tip**

- 412-685F 11 french angled
- 412-686H 12 french angled with hook lip

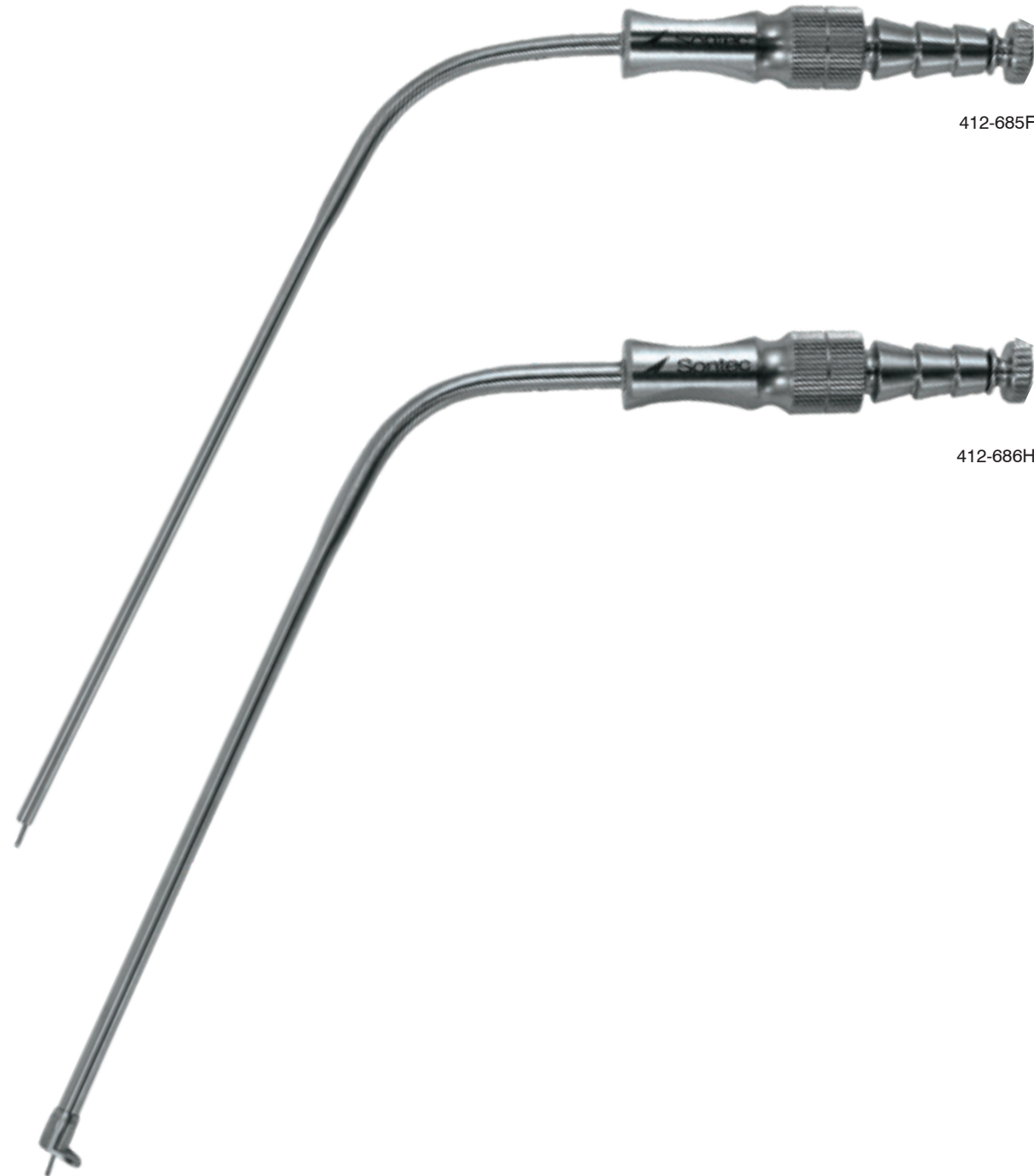

412-685F

412-686H

**Bayonet Suction Tube**

**Top finger control / 3 3/8" working length**

- 412-900 5 french
- 412-902 7 french
- 412-904 9 french

**Right finger control / 3 3/8" working length**

- 412-906 5 french
- 412-908 7 french
- 412-910 9 french



412-900

412-902

412-904

412-906

412-908

412-910

**Schmid Suction Tips**

6" (15 cm)

- 412-736-1
- 412-736-2
- 412-736-3
- 412-736-4

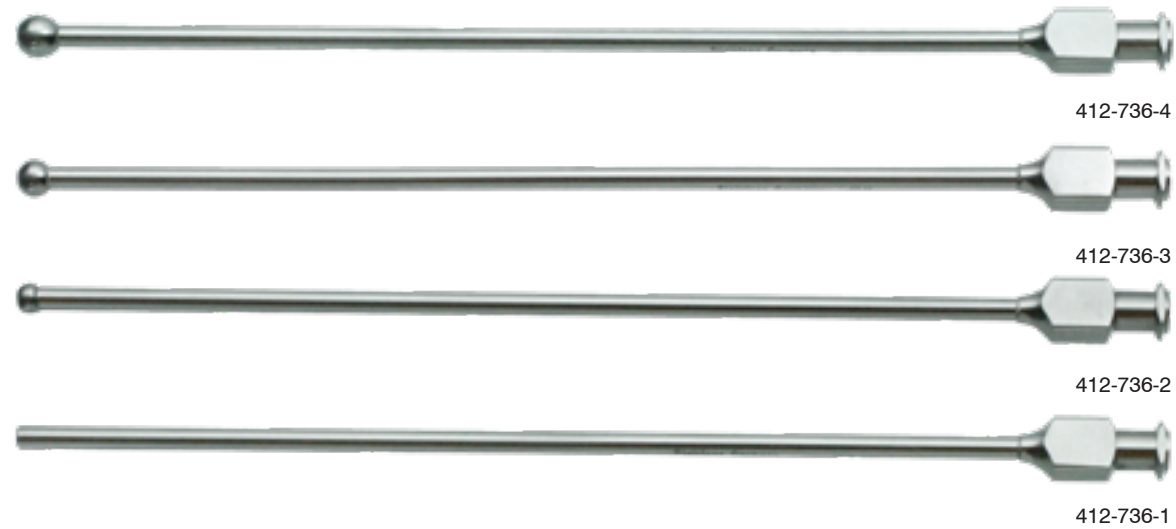

**Suction Irrigation Tube**

5 mm / with stylet / 8" (20 cm)

- 412-830 4 french x 8 french



**Buie Suction Tube**

With finger valve / 16" (40.5 cm)

- 508-523 15 french



**House Irrigator/Suction**

With thumb plate and cutoff (bypass hole) / 70mm working length / 4 1/2" (11.5 cm)

- 412-715A 2.5 french x 4 french
- 412-715C 4 french x 5 french

85mm working length / 5" (13 cm)

- 412-715 2 french x 2.5 french

95mm working length / 5 1/2" (14cm)

- 412-715B 2.5 french x 4 french
- 412-7151B 3 french x 4 french
- 412-715D 4 french x 5 french
- 412-716 5 french x 7 french
- 412-716A 6 french x 8 french
- 412-717 7 french x 10 french
- 412-718 8 french x 12 french
- 412-719 12 french x 14 french



**House-Baron Suction**

With multi port / 5" (12.5 cm)

- 412-728 5 french
- 412-728B 7 french

7" (18 cm)

- 412-729 5 french
- 412-729B 7 french

11" (28 cm)

- 412-727A 5 french
- 412-727B 7 french



**Andrews Pynchon Suction**

**Stainless / 9 1/2" (24 cm)**

- 180-432 3.0 mm
- 180-433 4.2 mm
- 180-436 5.0 mm standard

**Chrome handle / standard 5 mm / 9 1/2" (24 cm)**

180-439



**Anthony Suction**

**4 mm tip / 10" (25.5 cm)**

180-440



**Braun-Ralph Suction**

**5mm suction tube / 70° angle  
with 7 mm Ø 40 mm long fluted  
tip / 10" (25.5 cm)**

2700-309



**Yankauer Suction**

**Stainless Steel / 11 3/4" (30 cm)**

180-448



**With universal fiber optic light guide /  
stainless steel / 11 1/4" (28.5 cm)**

180-449 2mm



**Stainless steel / 16" (41 cm)**

180-451 2mm



**Heartline Ross Sump Sucker**

**Swivel head**

- 2700-390 adult 4.8mm x 7.5mm O.D. x 43mm length
- 2700-392 child 4.8mm x 6.5mm O.D. x 32.5mm length
- 2700-394 infant 3.2mm x 5mm O.D. x 22.5mm length



**Baby Poole Suction**

**Curved / 17 french / 8" (20.3 cm)**

180-420



**Poole Suction**

**8 3/4" (22 cm)**

- 180-424 cvd 23 french
- 180-422 str 30 french



**Adson Suction**

**Curved tip**

- 412-720 12 french 5" (12.5 cm)
- 412-724 12 french 8" (20 cm)



**Killian (Von Eicken) Suction**

**Curved / 6" (15 cm)**

- 412-815 4 mm end short curve
- 412-810 4 mm end full long curve
- 412-805 3 mm end short curve
- 412-800 3 mm end long curve

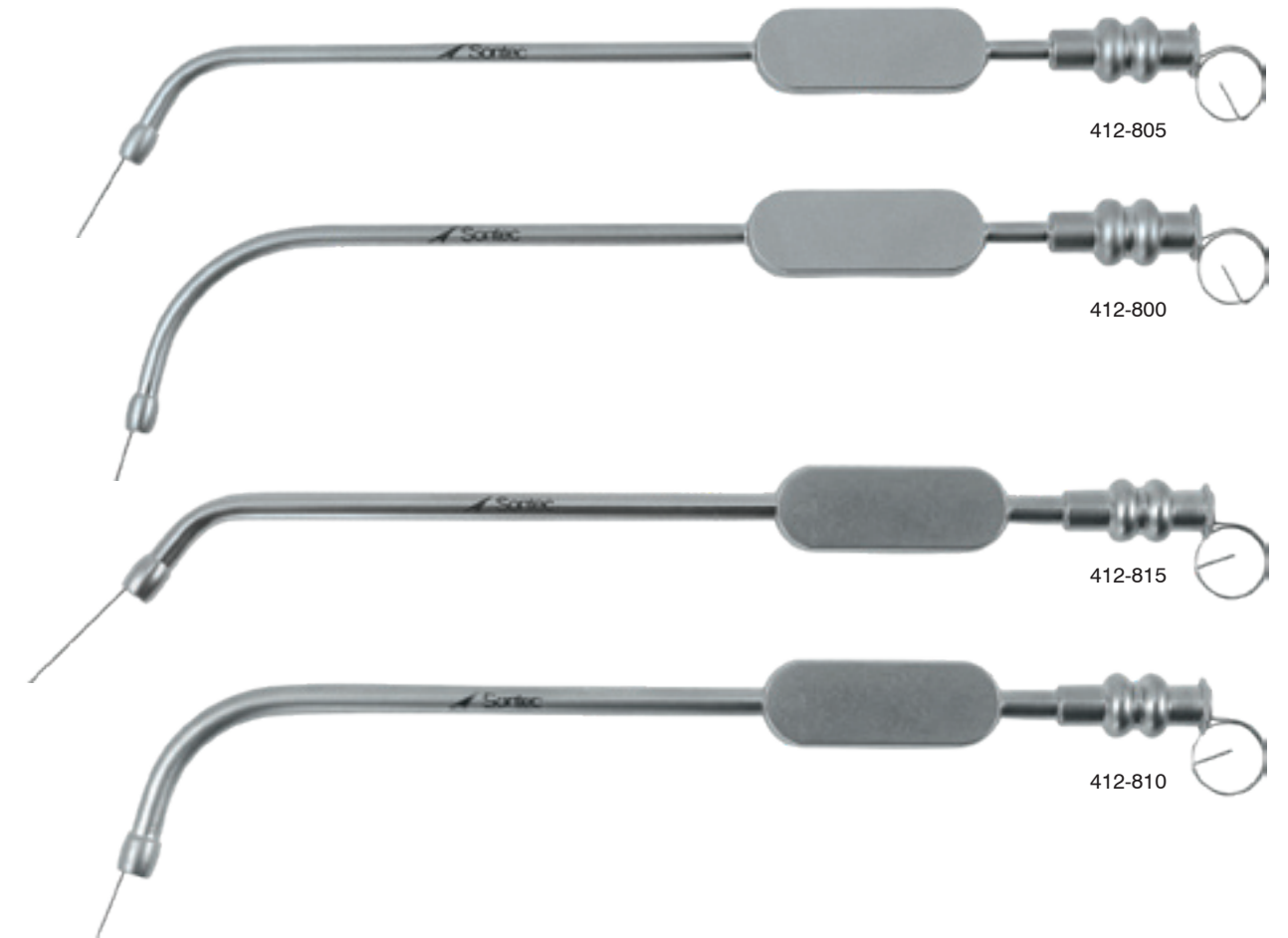

**Sontec Perfusion Cannula Suction**

**For pediatric Use**

- 412-740 style #1
- 412-741 style #2

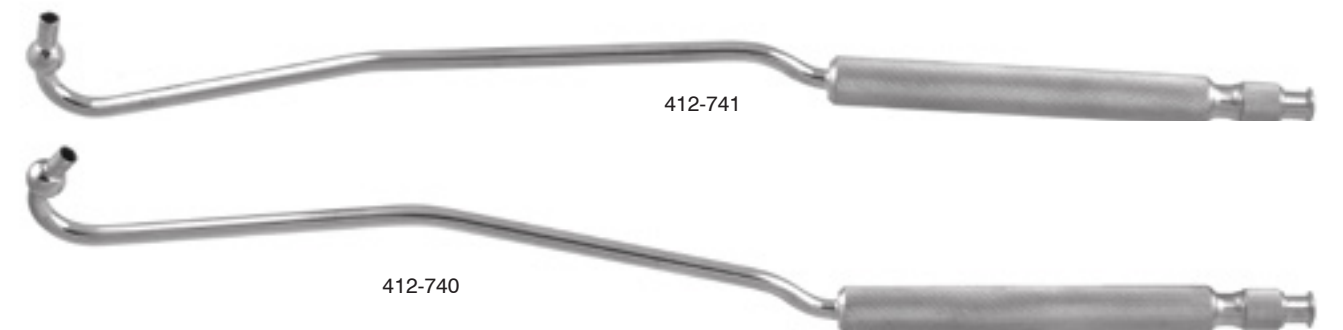

**Coupland Suction Set**

6 1/2" (16.5 cm)

412-672-SET

set includes:

- 412-673 tip #1 1.5 mm wide
- 412-674 tip #2 2.0 mm wide
- 412-675 tip #3 2.5 mm wide
- 412-676 tip #4 3.5 mm wide
- 412-672H handle



handle only

412-672H

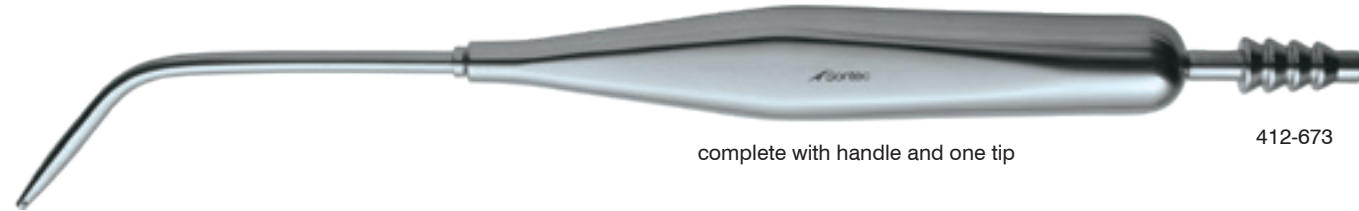

complete with handle and one tip

412-673



412-676



412-675



412-674



412-673

**Pashley Pipe Suction Tube Holding Device**

1463-461



1463-461



 Sontec Instruments®

ENT SAWS

**Joseph Bone Saw**

Single-sided / 7 1/2" (19 cm)

1100-466



1100-466

**Joseph Bayonet Bone Saw**

Single-ended / single-sided / 8" (20.5 cm)

345-255 right

345-256 left

345-257 set: including one right & one left



345-255



345-256

**Langenbeck Metacarpal Saw**

Blade length 4 1/4" (10 cm) / 9 1/4" (23.5 cm)

345-212



345-212

**Linderman Amputation Saw**

Blade length 20 cm / 8" (20.5 cm)

345-214



345-214

**Wellenschliff Nasal Saw**

Straight / 7 1/2" (19 cm)

345-248

345-249 round end



345-248



345-249



 Sontec Instruments®

Eye OCULAR PLASTIC

**Corneal Eye Shield**

Sterilize by ETO only / green is the normal stock color, to order other colors please specify when minimum quantity is 4 each

1100-409PG	pediatric	15.5 mm x 16.5 mm
1100-409SG	small	20.5 mm x 22.5 mm
1100-409MG	medium	24.5 mm x 22.5 mm
1100-409LG	large	24.5 mm x 26.5 mm

- \* Color order key: W=White / O=Orange / C=Clear
- \* Colors: clear, white, green, or orange
- \* Please be specific when ordering

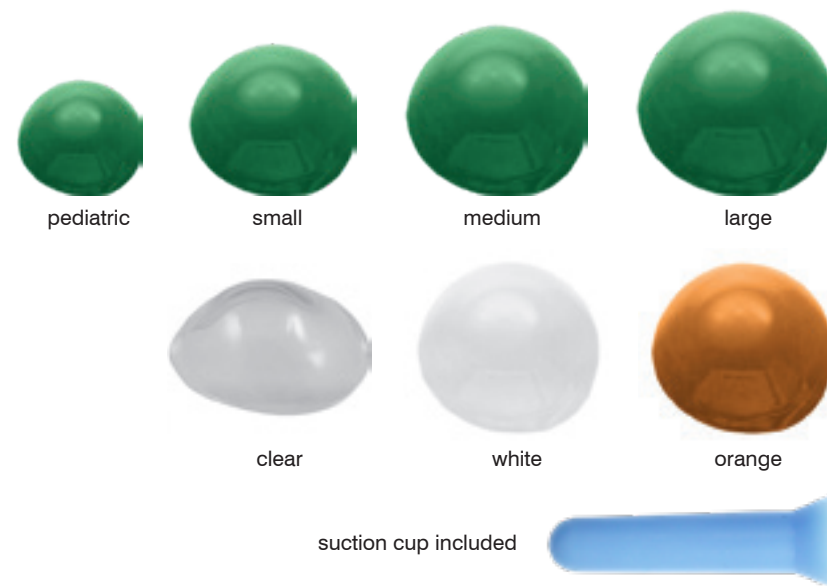

**Suction Cup Handle for Eye Shields**

18-8028 silicone blue



18-8028

**Corneal Eye Shields in Non-Reflective Laser Finish or Electro Blue Coating**

**Non-reflective laser finish stainless / 22 mm x 27 mm**

18-8026	can be used with suction cup 18-8028
18-8025	can be used with suction cup 18-8028 pair
18-8022	with handle
18-8020	with handle pair

**Electro blue coated / 22 mm x 27 mm**

18-8026B	without handle
18-8025B	without handle pair
18-8022B	with handle
18-8020B	with handle pair

**Titanium / 24 mm x 21 mm**

T18-8023	with handle
----------	-------------



18-8022



18-8026



18-8022B



T18-8023

**Freer Periosteal Elevator**

Double-ended / round handle / curved / 3.5 mm tip / sharp / 7 1/4"

1100-798H

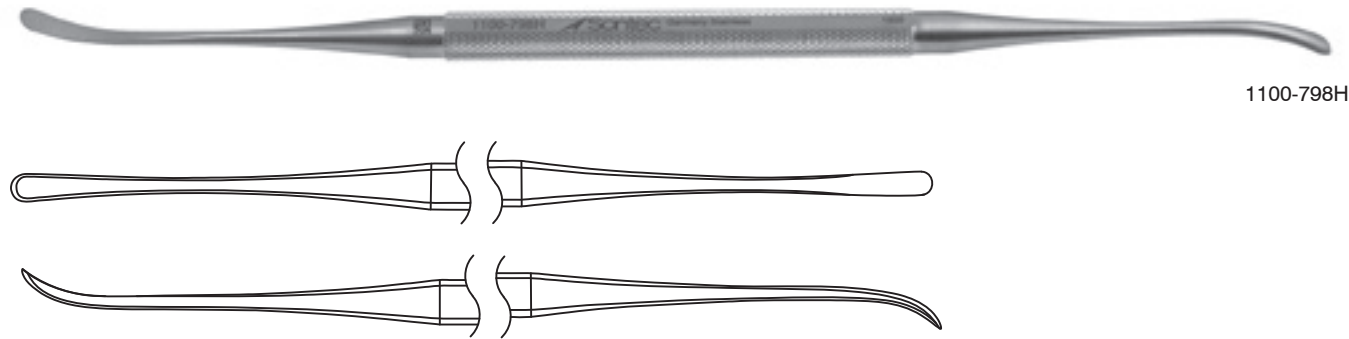

1100-798H

**Silicone Eye Implants**

Please specify size when ordering / not for medical use (vet only)

- 1100-411-10 10 mm
- 1100-411-11 11 mm
- 1100-411-12 12 mm
- 1100-411-13 13 mm
- 1100-411-14 14 mm
- 1100-411-15 15 mm
- 1100-411-16 16 mm
- 1100-411-17 17 mm
- 1100-411-18 18 mm
- 1100-411-19 19 mm
- 1100-411-20 20 mm
- 1100-411-21 21 mm
- 1100-411-22 22 mm
- 1100-411-23 23 mm
- 1100-412-24 24 mm
- 1100-412-26 26 mm
- 1100-412-28 28 mm
- 1100-412-30 30 mm
- 1100-412-33 33 mm
- 1100-412-36 36 mm
- 1100-412-38 38 mm
- 1100-412-40 40 mm
- 1100-412-43 43 mm
- 1100-412-45 45 mm
- 1100-412-47 47 mm

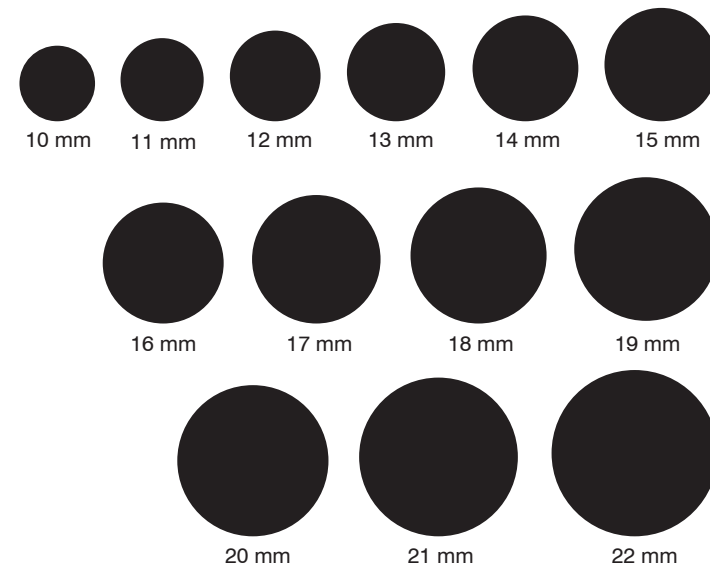

**Carter Sphere Introducer**

5" (12.5 cm)

17-1000

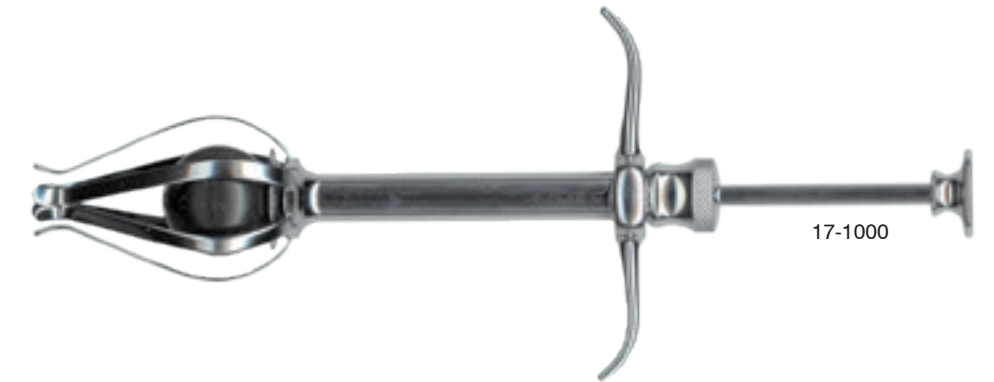

17-1000

**Bishop-Harmon Irrigation Bulb Cannula Set**

Adapter and blue silicone bulb / angled cannula

- 16-5300-SET complete (bulb, adapter, 19 gauge cannula)
- 16-5310 silicone bulb
- 16-5330 19 gauge cannula
- 16-5331 21 gauge cannula (separate purchase)
- 16-5340 bulb & adapter (separate purchase)
- 16-5320 SS adapter
- 16-5325 plastic adapter (bag of 5 each)
- 16-5321 plastic adapter (1 each)

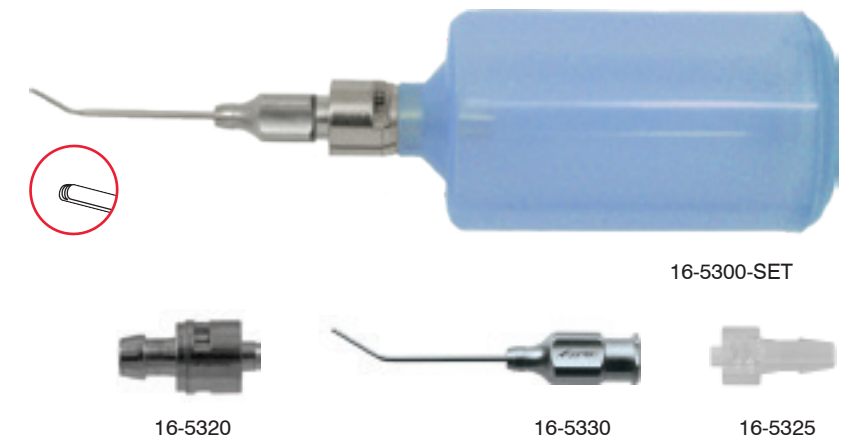

16-5300-SET

16-5320

16-5330

16-5325

**Lacrimal Cannula**

**Reinforced shaft / 23 gauge**

16-3300 straight  
16-3310 curved



16-3310

**Straight / 23 gauge / 25 mm length**

16-3290

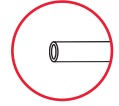

16-3290

**Severin Lacrimal Cannula**

**Curved**

1103-500 19 gauge  
1103-500A 20 gauge  
1103-500B 21 gauge  
1103-500C 22 gauge  
1103-500D 23 gauge  
1103-500E 24 gauge  
1103-500F 25 gauge  
1103-500G 26 gauge  
1103-500H 27 gauge  
1103-500J 30 gauge

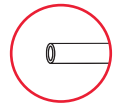

1103-500A

**Fasanella Lacrimal Cannula**

**Curved / 15 mm length / 23 gauge**

16-3350



16-3350

**Lacrimal Cannula**

**Side opening / straight / 28 mm length / 19 gauge**

16-3346

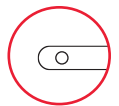

16-3346

**Shahinian Lacrimal Cannula**

**Smooth conical tip / straight / 0.3 mm side opening / 11 mm length / 23 gauge**

16-3314

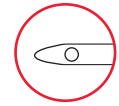

16-3314

**McIntyre Lacrimal Cannula**

**0.3 mm dual sideports / 23 gauge**

16-3320 straight  
16-3330 curved

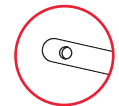

16-3330

**West Cannula**

**Side opening / curved / 25 mm length / 23 gauge**

16-3348

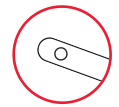

16-3348

**Air Injection Cannula**

**Angled / 5 mm tip**

16-3810 25 gauge  
16-3820 27 gauge  
16-3800 30 gauge



16-3820

**Angled / 7 mm tip**

16-3821 27 gauge  
16-3826 30 gauge



16-3821

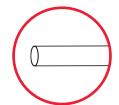
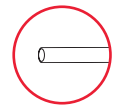

**Jaeger Lid Plate**

**Stainless**

10-4520 1/2 laser finish  
10-4521 broad laser finish mini 3 3/4" slight "S" curved  
10-4522 1/2 laser finish  
10-4525 blue electro coat  
10-4530 stainless steel  
10-4535 black laser finish

**Titanium**

10-4540

laser finish



10-4520



10-4521

laser finish



10-4522



10-4525



10-4530



10-4540

**Sewall Orbital Retractor**

**Double ended / 7mm curved / 3.5mm curved**

10-3890



10-3890

### Flieringa Scleral Fixation Ring

Set of 9 sizes, 14 mm - 22 mm

10-3100-SET

Also sold individually

- 10-3140 14 mm
- 10-3150 15 mm
- 10-3160 16 mm
- 10-3170 17 mm
- 10-3180 18 mm
- 10-3190 19 mm
- 10-3200 20 mm
- 10-3210 21 mm
- 10-3220 22 mm



10-3100-SET

### McNeill-Goldman Scleral Fixation Ring & Blepharostat

Stainless

- 10-3310 small 15 mm inside diameter
- 10-3312 medium 16 mm inside diameter
- 10-3314 large 17 mm inside diameter



10-3314

### Schepens Scleral Depressor

With thimble / black

- 10-3800 small #8
- 10-3810 medium #10
- 10-3820 large #12



10-3800

10-3820

### Scleral Depressor

Double-ended / with clip

- 10-3825
- T10-3825 titanium
- T10-3840 titanium handle

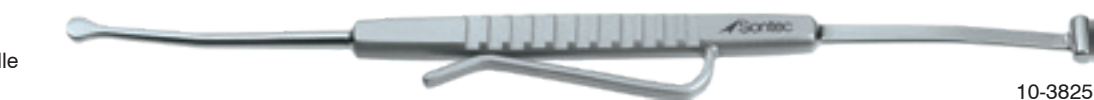

10-3825



T10-3825



T10-3840

### Desmarres Lid Retractor

Stainless steel / 5 1/2" (14 cm)

- 10-4192 6 mm
- 10-4194 8 mm
- 10-4196 9 mm
- 10-4198 10 mm
- 10-4200 11 mm
- 10-4201 11 mm electro-blue coated
- 10-4206 12 mm
- 10-4207 12 mm electro-blue coated
- 10-4210 13 mm
- 10-4213 13 mm electro-blue coated
- 10-4216 14 mm
- 10-4220 15 mm



10-4200



10-4223

- 10-4218 14 mm
- 10-4223 15 mm electro-blue coated
- 10-4226 16 mm
- 10-4227 16 mm electro-blue coated
- 10-4230 17 mm



10-4236

- 10-4233 17 mm electro-blue coated
- 10-4236 18 mm
- 10-4237 18 mm electro-blue coated
- 10-4240 19 mm

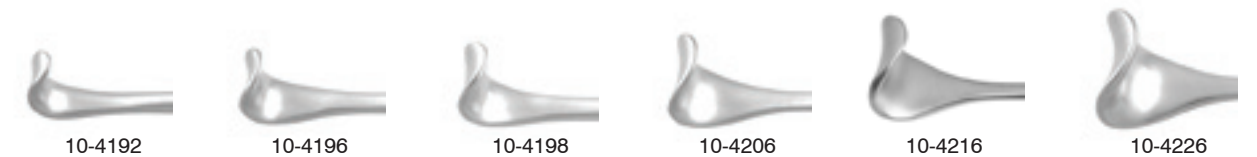

10-4192

10-4196

10-4198

10-4206

10-4216

10-4226

### Gil-Vernet Desmarres Retractor

5 3/4" (14.5 cm)

- 10-4211 size 1
- 10-4221 size 2
- 10-4231 size 3
- 10-4241 size 4



10-4211

10-4231



10-4221

10-4241



10-4241

**Eye Ribbone Retractor**

Malleable / 4 1/4" (11 cm)  
10-5400 stainless



10-5400

**Flexible Neck Hook Retractor**

5" (13 cm)  
205-819 sharp 3 prongs

6" (15 cm)  
205-820 sharp 1 prong  
205-826 blunt 1 prong  
205-822 sharp 2 prongs  
205-828 blunt 2 prongs  
205-824 sharp 3 prongs  
205-830 blunt 3 prongs

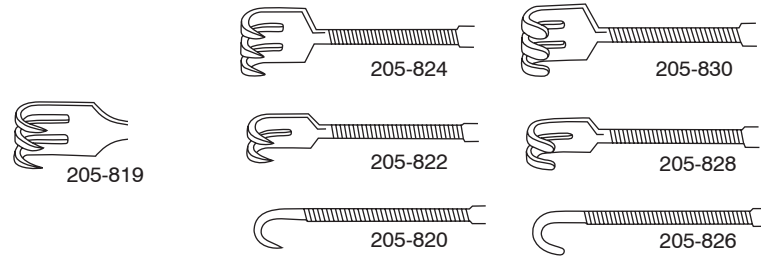

205-822



205-828

**Blair Hook Retractor**

Four prongs / 5" (12.5 cm)  
205-847 sharp  
205-848 blunt



205-848

**Knapp Rollet Hook Retractor**

4 prongs / 5" (12.5 cm)  
205-844 sharp  
205-846 blunt



205-844

**Miller Skin Rake Retractor**

5" (12.5 cm)  
199-480 9 prong sharp  
199-481 9 prong blunt  
199-482 6 prong sharp  
199-483 6 prong blunt



199-481

**Paul Skin Rake Retractor**

Blunt / 5" (12.5 cm)  
199-490



199-490

**Helveston Tissue Retractor**

2 mm wide / curved blade  
10-5480 stainless  
T10-5480 titanium



T10-5480

**Helveston Tissue Retractor**

Single ended / curved / flat handle / 5"  
10-5487 7 mm  
10-5489 9 mm  
10-5491 11 mm

Single ended / curved / flat handle / titanium / 5"  
T10-5487 4 x 7 mm  
T10-5489 4 x 9 mm  
T10-5491 4 x 11 mm



10-5487



10-5489



10-5491



T10-5487



T10-5489



T10-5491

**Algerbrush II Corneal Rust Ring Remover Burr**

**Battery powered**

- 11-4600 complete w/ 0.5 mm burr
- 11-4601 complete w/ 1 mm burr
- 11-4610 burr only 0.5 mm
- 11-4609 burr only 1 mm



11-4600

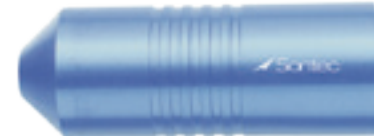

11-4610

**Algerbrush II Pterygium Burr**

**Battery powered**

- 11-4611 complete w/ 2.5mm Fine ball tip
- 11-4612 2.5 mm fine ball tip only
- 11-4613 complete w/ 3.5mm medium ball tip
- 11-4614 3.5 mm medium ball tip only
- 11-4615 complete w/ 4mm fine wheel
- 11-4616 4 mm fine wheel tip only
- 11-4617 complete w/ 5mm medium wheel
- 11-4618 5 mm wheel tip only



11-4611



11-4612



11-4614



11-4616



11-4618



**Meyerhoefer-Chalazion Curette**

**5" (12.5 cm)**

- 12-1285 0.5 mm
- 12-1290 1.0 mm
- 12-1300 1.5 mm
- 12-1310 1.75 mm
- 12-1320 2.0 mm
- 12-1355 2.5 mm
- 12-1360 3.0 mm
- 12-1365 3.5 mm
- 12-1367 4.0 mm
- 12-1368 4.5 mm



12-1368

**House Curette**

**Double-ended / 5 3/4" (14.5 cm)**

- 199-133 both ends cvd 1.5 mm x 1.2 mm micro tip



199-133

**Double-ended / 6" (15 cm)**

- 199-132 one end angled, one end str 2.0 mm x 3.2 mm
- 199-129 both ends angled 2.0 mm x 3.5 mm
- 199-131 both ends str 2.0 mm x 3.5 mm



199-129



199-131



199-132

**Double-ended / 7" (18 cm)**

- 199-130 both ends angled 1.5 mm x 3.0 mm

**Double-ended / 9" (22.8 cm)**

- 199-136 both ends straight 2.0 mm x 3.5 mm



199-130



199-136

**Davis Brain Spatula**

Malleable / 7" (18 cm)

- 412-770 1/4"
- 412-771 3/8"
- 412-772 1/2"
- 412-773 5/8"
- 412-774 3/4"
- 412-775 1"
- 412-776 1 1/4"
- 412-777 1 1/2"



412-770



412-771



412-772



412-773



412-774



412-775

**Davis Brain Black Silicon Spatula**

Silicone coated / malleable / 7" (18 cm)

- 412-766 small 6 mm & 10 mm
- 412-767 medium 9 mm & 15 mm
- 412-768 large 11 mm & 20 mm
- 412-769 x-large 14 mm & 25 mm



412-766



412-767



412-768



412-769

**Kerrison Punch (Occular-plasti) 90° Rongeur**

4" (10 cm) shaft

- 16-2100 1.0 mm wide up
- 16-2101 1.5 mm wide up
- 16-2102 2.0 mm wide up
- 16-2106 2.5 mm wide up
- 16-2103 3.0 mm wide up
- 16-2104 3.0 mm wide down
- 16-2105 4.0 mm wide down

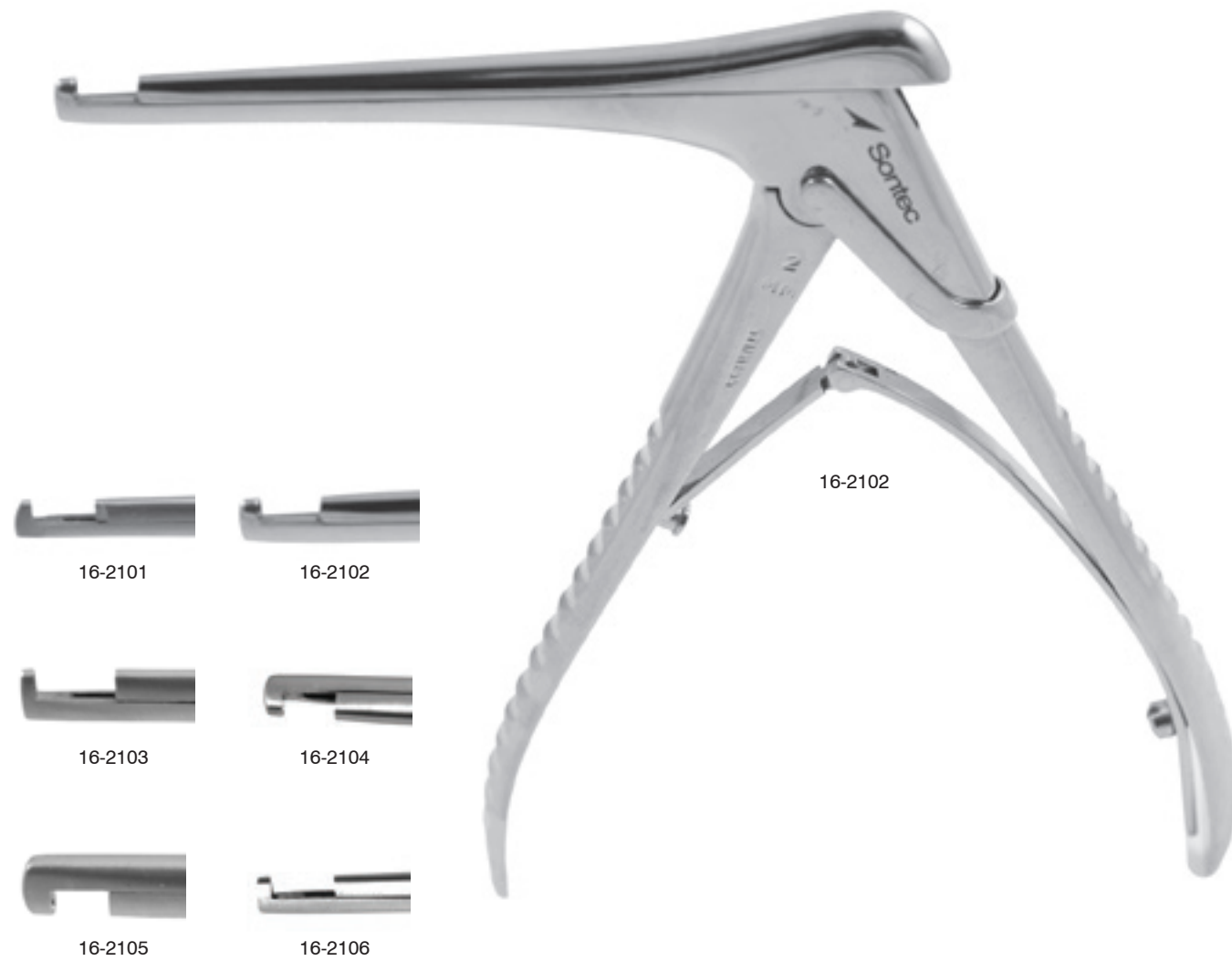

**Kerrison Punch (Occular-plasti) 40° Rongeur**

4" (10 cm) shaft

- 16-2096 1.0 mm wide
- 16-2097 1.5 mm wide
- 16-2098 2.0 mm wide
- 16-2099 3.0 mm wide

		Bite Width	
40° Up-Angle		1 mm	16-2096
		1.5 mm	16-2097
		2 mm	16-2098
		3 mm	16-2099

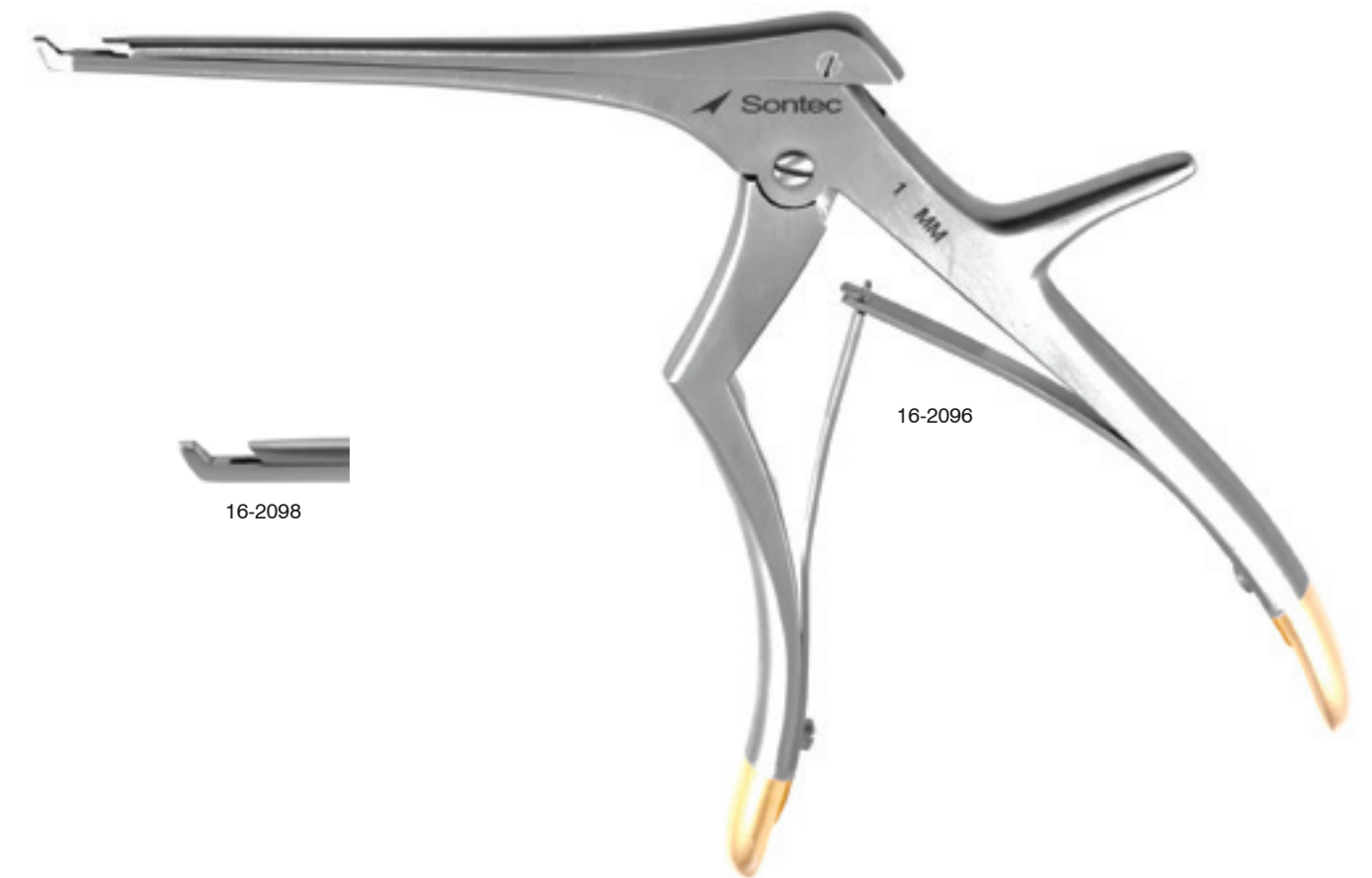

**Barraquer Wire Speculum**

**Standard**

10-1000	10 mm blades	
T10-1000	10 mm blades	titanium
10-1005	12 mm blades	
T10-1005	12 mm blades	titanium
10-1007	14 mm blades	
T10-1007	14 mm blades	titanium
10-1010	15 mm blades	
T10-1010	15 mm blades	titanium

**Closed wire / curved blades**

10-1000C	10 mm blade	15 mm spread small	
10-1000C-13	13 mm blade	10 mm spread	
T10-1000C	10 mm blade	15 mm spread small	titanium
10-1005C	12 mm blade	18 mm spread medium	
10-1010C	14 mm blade	18 mm spread large	
10-1010C-08	8 mm blade	16 mm spread	
T10-1010C	14 mm blade	18 mm spread large	titanium

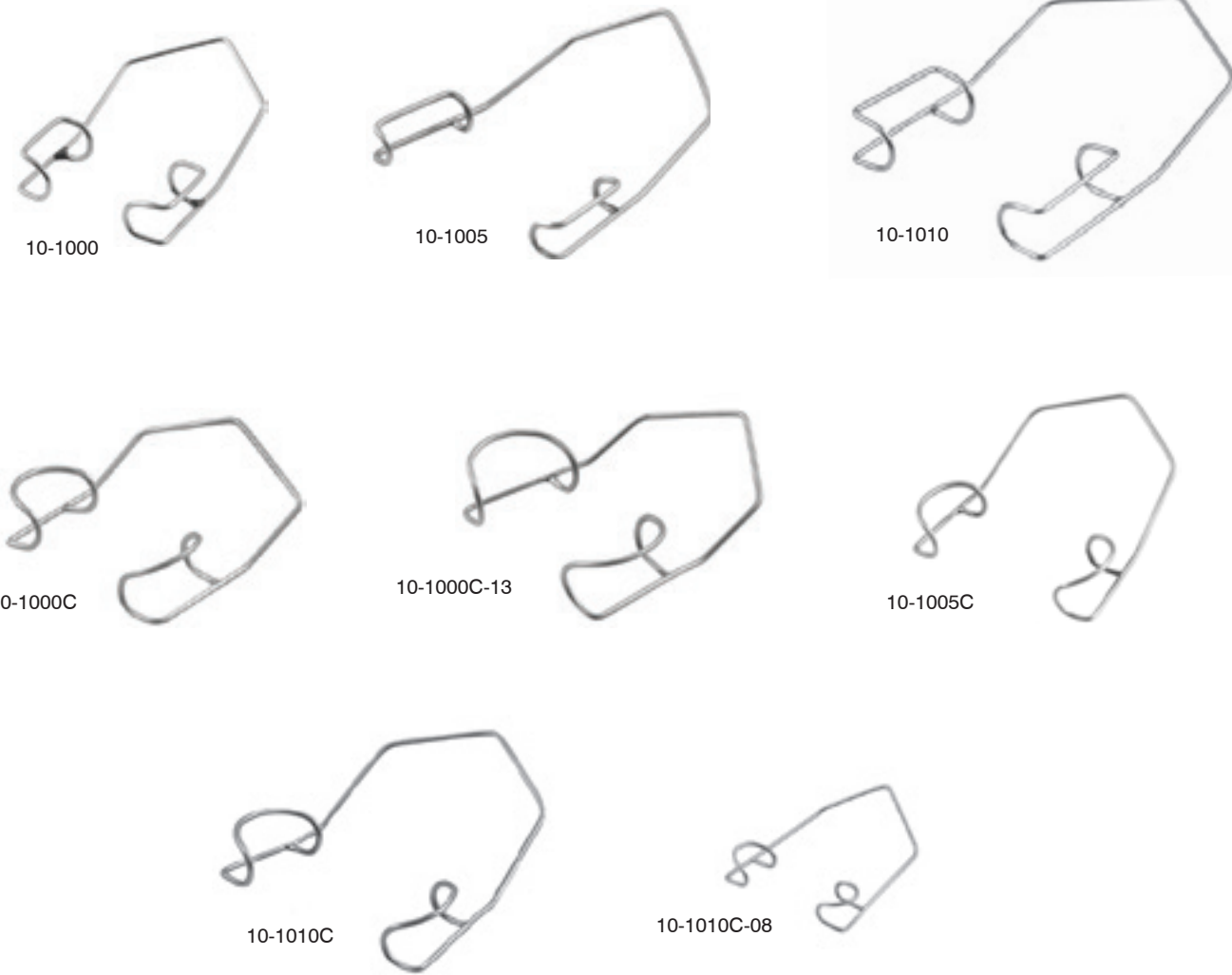

**Barraquer Wire Speculum Third Eye Lid**

**Closed blades**

T10-1013	10 mm blades	18 mm spread	left third eye lid	titanium
T10-1014	10 mm blades	18 mm spread	right third eye lid	titanium
10-1015	14 mm blades	18 mm spread	left third eye lid	
10-1016	14 mm blades	18 mm spread	right third eye lid	
T10-1015	14 mm blades	18 mm spread	left third eye lid	titanium
T10-1016	14 mm blades	18 mm spread	right third eye lid	titanium

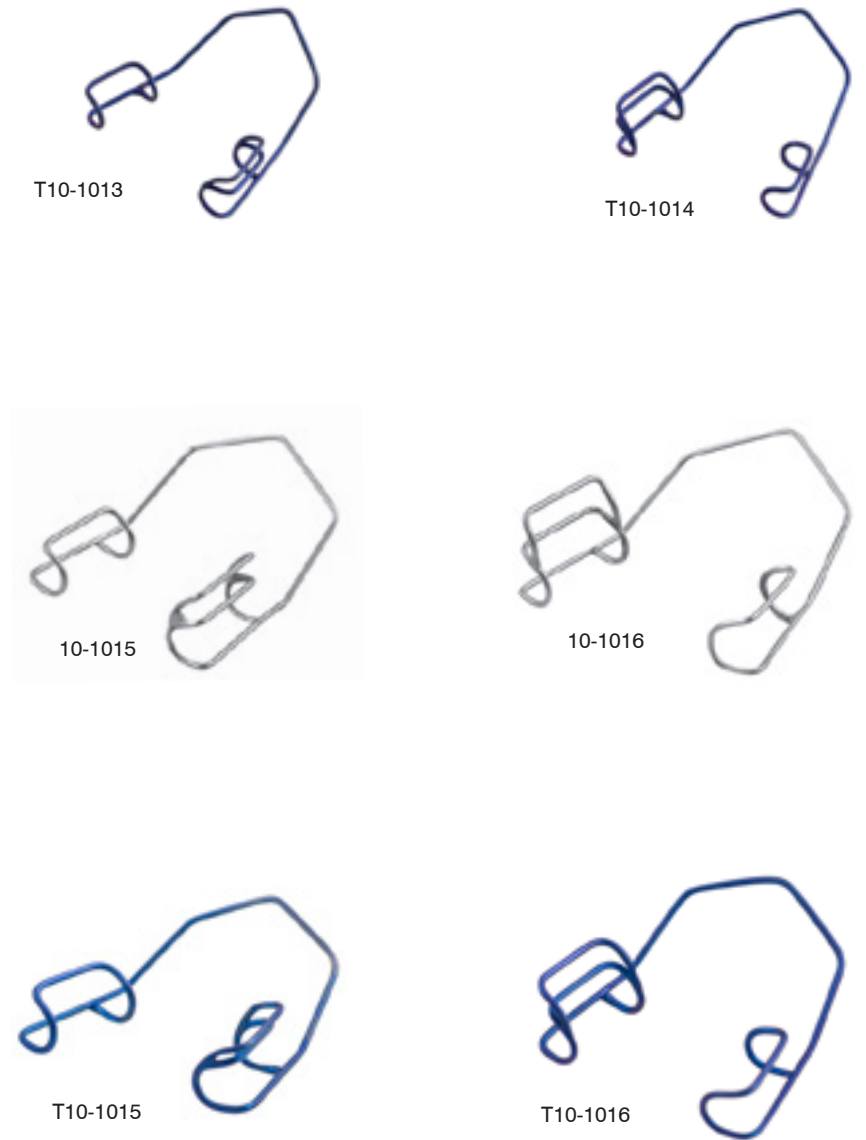

**Barraquer Wire Speculum**

**Solid blades**

10-1020	small	stainless
T10-1020	small	titanium
10-1030	large	stainless
T10-1030	large	titanium



10-1020



10-1030

**Kratz Aspirating Wire Speculum**

**V-shaped blades**

10-1043	open blades
10-1062	closed blades

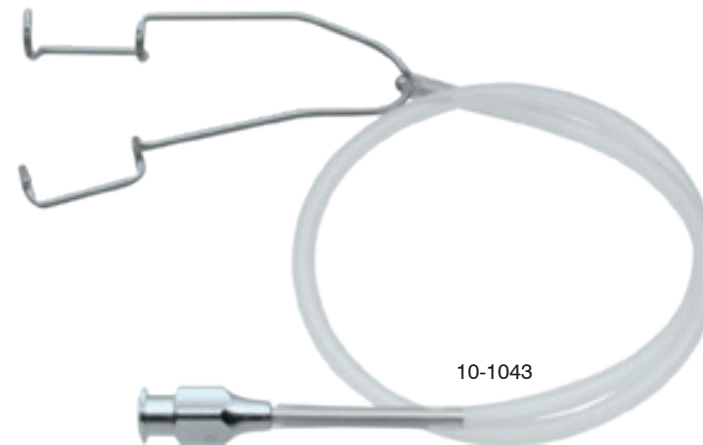

10-1043

**Kratz-Barraquer Wire Speculum**

**Open blades / stainless steel**

10-1054	4 mm blades
10-1053	8 mm blades
10-1055	10 mm blades
10-1050	15 mm blades

**Open blades / titanium**

T10-1054	4 mm blades
T10-1053	8 mm blades
T10-1056	10 mm blades
T10-1051	15 mm blades

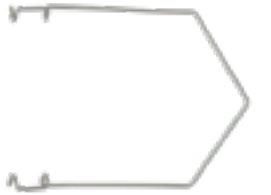

10-1054

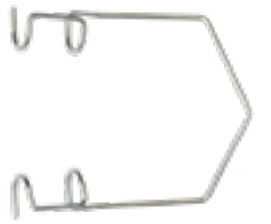

10-1053

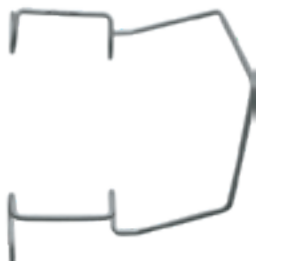

10-1055



T10-1051

**McKee Eye Speculum**

Malleable  
10-1150

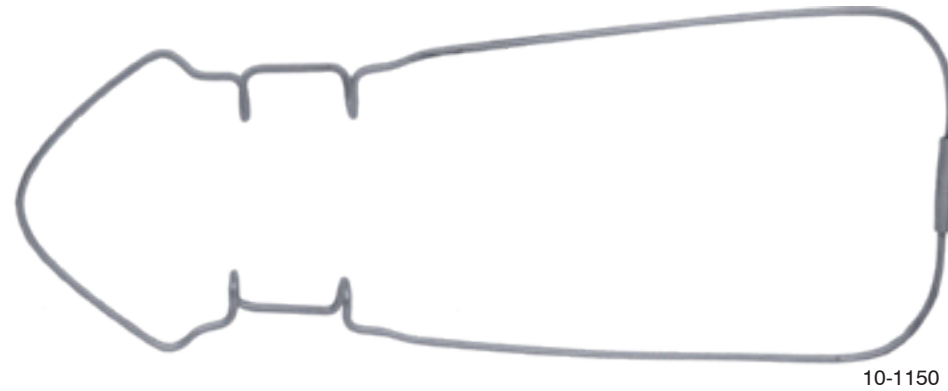

10-1150

**Barraquer Infant Wire Speculum**

Closed wire blades / gently curved springs / v-shaped  
10-1340 4 mm blades

**Closed wire blades**

10-1350 4 mm blades 30 mm total length  
10-1360 8 mm blades  
10-1360H 8 mm blades heavy

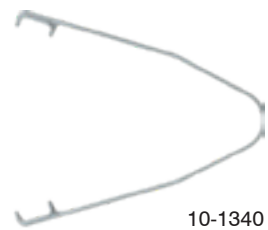

10-1340

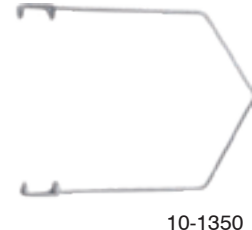

10-1350

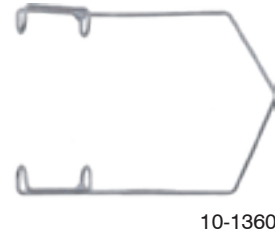

10-1360



10-1360H

**Sauer Lid Speculum**

**Solid blades**

10-1300 for infants  
10-1300S for premature infants  
T10-1320 adult  
T10-1300S premature infants titanium



10-1300



10-1300S



T10-1320



T10-1300S

**Murdoch Eye Speculum**

Locking screw / open blades  
10-1420 small  
10-1422 large



10-1422

**Cook Eye Speculum**

**Non-magnetic / locking screw / Solid blades**

10-1400 very small  
10-1401 small  
10-1402 medium  
10-1403 large

**Non-magnetic / locking screw / Double bar**

10-1404 small 11 mm  
10-1405 large 15 mm



10-1404



10-1405

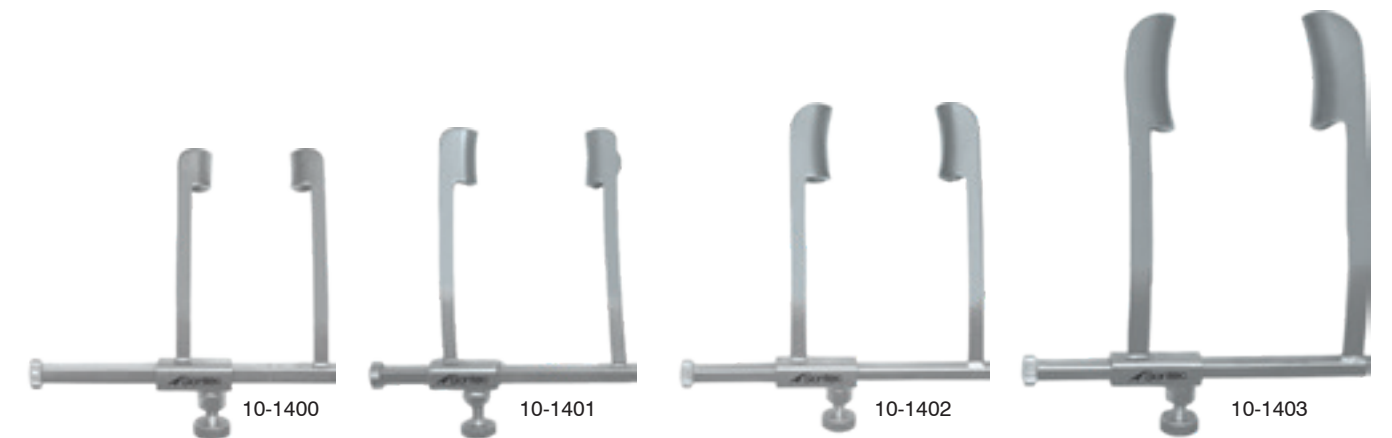

10-1400

10-1401

10-1402

10-1403

**Bowman Lacrimal Probe**

**Sterling silver / butterfly handle**

- 16-2520 set of six probes
- 16-2530 size 0000/000
- 16-2540 size 00/0
- 16-2541 size 0/1
- 16-2550 size 1/2
- 16-2551 size 2/3
- 16-2560 size 3/4
- 16-2561 size 4/5
- 16-2570 size 5/6
- 16-2571 size 6/7
- 16-2580 size 7/8

**Stainless steel / butterfly handle**

- 16-2530S size 0000/000
- 16-2540S size 00/0
- 16-2550S size 1/2
- 16-2560S size 3/4
- 16-2570S size 5/6



16-2580  
16-2570  
16-2560  
16-2550  
16-2540  
16-2530

**Bowman Lacrimal Probe**

**Stainless steel / round handle**

- 16-2578 set of six probes
- 16-2579 size 0000/000
- 16-2581 size 00/0
- 16-2582 size 0/1
- 16-2583 size 1/2
- 16-2584 size 2/3
- 16-2585 size 3/4
- 16-2586 size 4/5
- 16-2587 size 5/6
- 16-2588 size 6/7
- 16-2589 size 7/8



16-2579  
16-2581  
16-2583  
16-2585  
16-2587  
16-2589

**Catalano Lacrimal Intubation Set**

Includes 2 blunt 0.7 mm diameter probes attached to 30.5 cm long silicone tubing

16-2590



16-2590

**Jackson Lacrimal Intubation Set**

Includes 2 blunt 0.9 mm diameter probes attached to 30.5 cm long silicone tubing

16-2592



16-2592

**Crawford Lacrimal Intubation Set**

Includes 2 olive tip 0.6 mm diameter probes attached to 30.5 cm long silicone tubing

16-2594

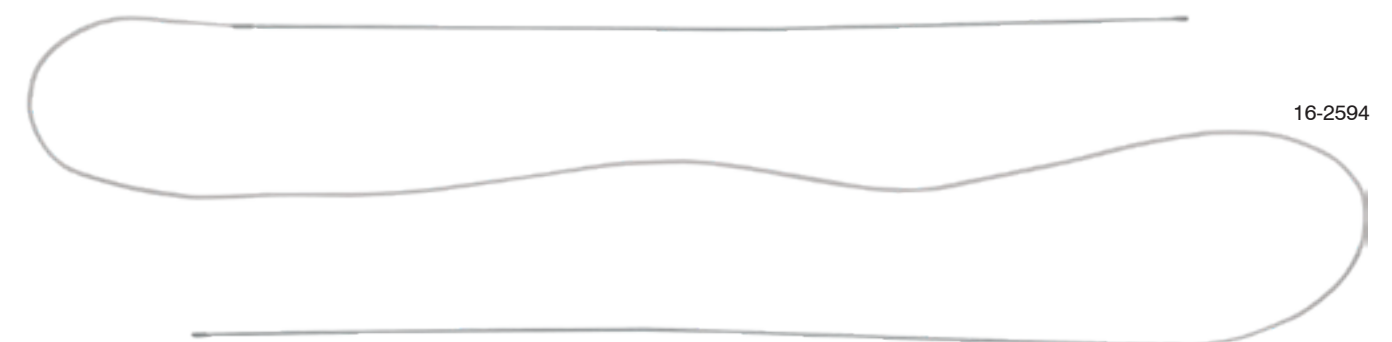

16-2594

**Bodian Lacrimal Probe Set**

Includes 2 curved blunt 1.0 mm diameter probes attached to 30.5 cm long silicone tubing

16-2596

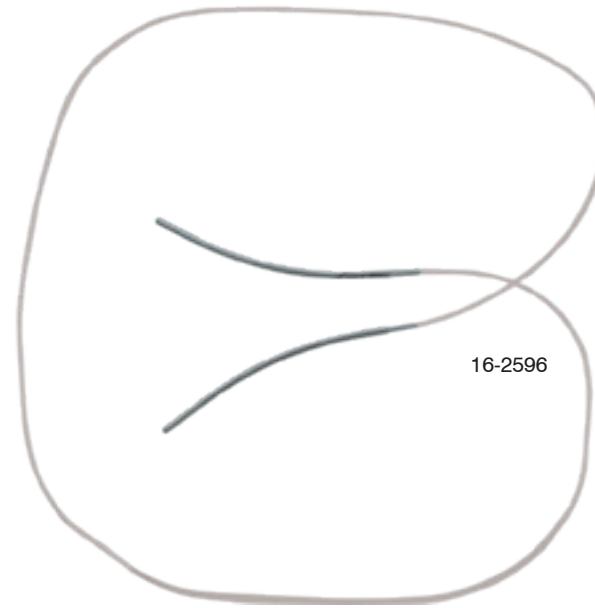

**Pigtail Lacrimal Probe Dilator**

15 mm tip w/holes

16-2600



16-2600

**Castroviejo Lacrimal Dilator**

Double-ended

16-2510



16-2510

**Infant Lacrimal Dilator**

Single-ended

16-2440



16-2440

**Wilder Lacrimal Dilator**

Single-ended

16-2460 fine, #1

16-2470 medium, #2

16-2480 heavy, #3



16-2460



16-2470



16-2480

**Muldoon Lacrimal Dilator**

Single-ended / graduated blunt tip

16-2500



16-2500

**Lockhart Mummery Fistula Probe**

With eye hole at tip / 6 1/2" (16.5 cm)

- 15-0230 #1 straight
- 15-0231 #2 45° curve
- 15-0232 #3 90° curve
- 15-0233 #4 hook



15-0230

15-0231

15-0232

15-0233

**Grooved Director Tongue Tie**

- 197-690 4 1/2" (11.5 cm)
- 197-691 5" (12.5 cm)
- 197-692 5 1/2" (14 cm)
- 197-693 6" (15 cm)
- 197-694 7" (17.8 cm)
- 197-695 8" (20 cm)

With probe point

- 197-700 4 1/2" (11.5 cm)
- 197-701 5" (12.5 cm)
- 197-702 5 1/2" (14 cm)
- 197-703 6" (15 cm)
- 197-704 7" (17.8 cm)
- 197-705 8" (20 cm)



197-701

**Larry Fistula Probe**

Grooved director / 6" (15 cm)

508-544



508-544

**St. Marks Fistula Probe**

Curved / 7" (18 cm)

508-541



508-541

**Buie Fistula Probe**

Sterling silver shaft / 5 3/8" (13.5 cm)

508-536

508-538 heavy



508-536

**Barr Fistula Probe**

11" (28 cm)

508-542 w/ eye at tip

508-543



508-543

**Barr Double Ended Probe**

Double-ended / 7" (18 cm)

508-547



508-547



 Sontec Instruments®

Orthopedic MALLETS

**Sontec Combo Nylon Mallet**

1" head diameter / removable heads / 7 3/8" (18.75 cm)

1100-462S deluxe mallet with one nylon head

**Sold separately**

1100-462SH stainless steel head for deluxe mallet

1100-463S nylon head for deluxe mallet



1100-462S



1100-462SH



1100-463S

**Collin Lucae Mallet**

Solid head / 210 grams / 30mm Ø / 8 1/4" (21 cm)

330-818



330-818

**Sontec Double Nylon Mallet**

Light-weight / 7 3/8" (18.7 cm) / 7 oz.

330-808



**Sontec Micro Mallet**

3/4" head diameter / 6 1/2" (16.5 cm)

330-817 stainless steel convex/flat combo 4 oz.

330-819 lead filled head no recoil 5.6 oz.



330-817



 Sontec Instruments®

Orthopedic SINGLE ACTION RONGEURS

**Mini Neuro Rongeur**

5 1/2" (14 cm)

- 1106-080 str 0.75 mm jaw
- 1106-082 cvd 0.75 mm jaw
- 1106-084 str 1.0 mm jaw
- 1106-086 cvd 1.0 mm jaw
- 1100-577S str 1.3 mm jaw
- 1100-577 cvd 1.3 mm jaw



1100-576

1.4 mm jaw / 6" (15 cm)

- 1100-574 str
- 1100-576 cvd

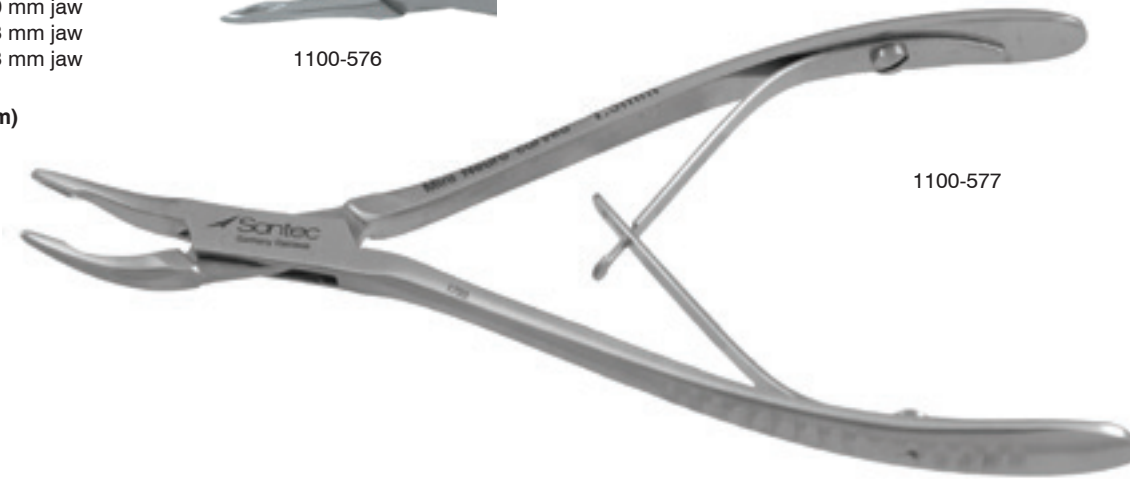

1100-577

**Mini Neuro Premier Rongeur**

0.5 mm tip / 5 1/2" (14 cm)

- 1106-091 str
- 1106-092 cvd



1106-091



1106-092

**Micro Friedman Ring Handle Rongeur**

5 1/2" (14 cm)

- 1106-076 1.3 mm straight
- 1106-077 1.3 mm curved
- 1106-078 1.3 mm full curved
- 1106-079 2.0 mm curved
- 1106-0791 2.0 mm full curved



1106-077



1106-078



1106-079



1106-0791

**Kleinert-Kutz Rongeur**

2 mm x 6 mm jaw / 5 1/4" (13 cm)

- 315-581 slight curve
- 315-580 full curve



315-581



315-581



315-580

**Micro Friedman Rongeur**

1.5 mm x 5 mm jaw / 5 1/2" (14 cm)

- 315-505S str
- 315-505C 30° angle
- 315-505 90° angle

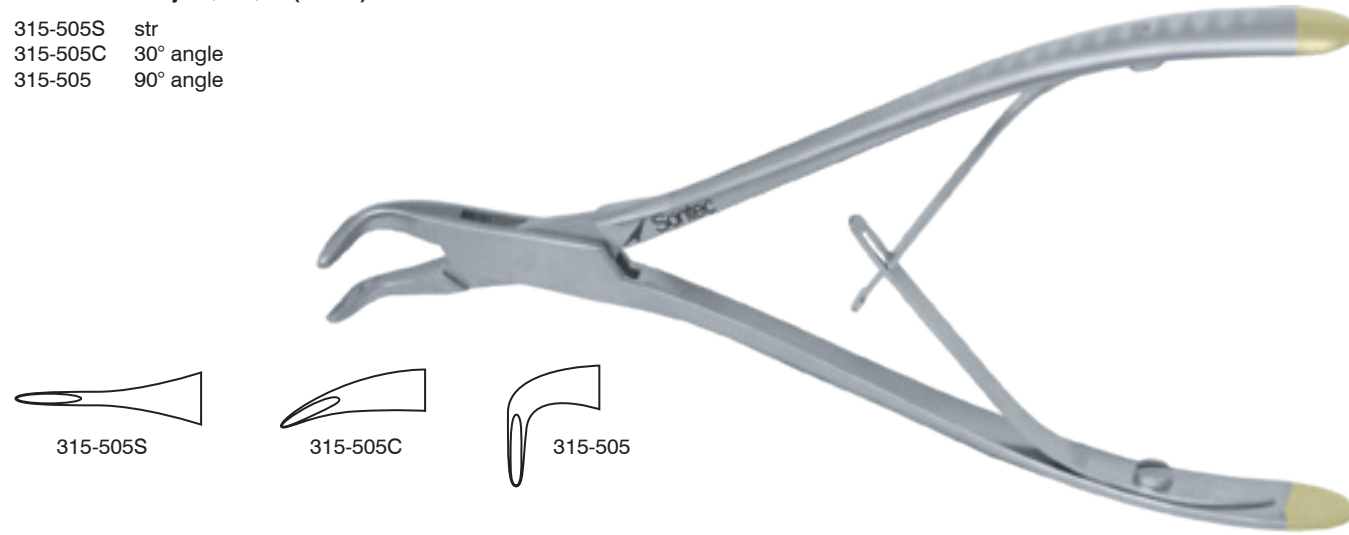

315-505

**Mini Friedman Rongeur**

2 mm x 8 mm jaw / 5 1/2" (14 cm)

- 1106-070 str
- 1106-075 cvd



1106-075

**Shearer Chickenbill Rongeur**

Curved / 3 mm x 12 mm jaw

- 315-511 5 1/2" (14 cm)
- 315-513 6 1/2" (16.5 cm)
- 315-515 7" (18 cm)



315-511

**Hakansson Rongeur**

2.5 mm x 12 mm jaw / curved / 6 1/4" (16cm)

- 1103-230



1103-230

**Stellbrink Rongeur**

2 mm x 8 mm jaw / 6 1/2" (16.5 cm)

- 315-566 slight curve
- 315-567 full curve

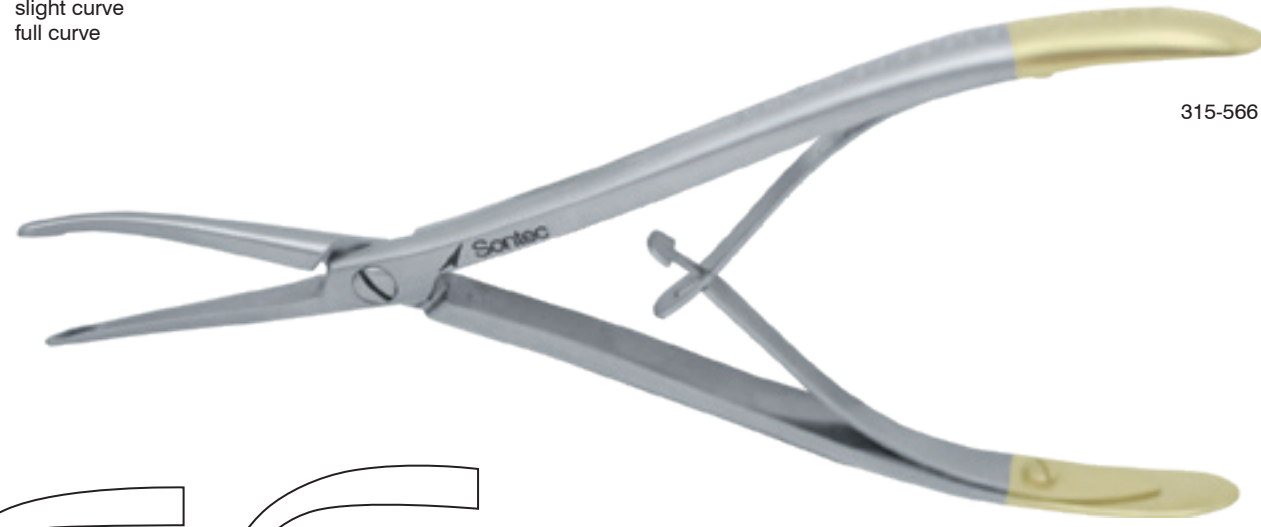

315-566

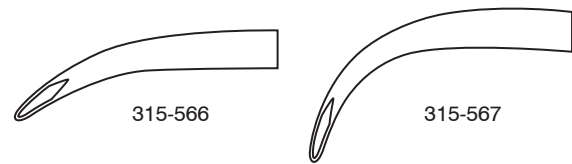

315-566

315-567



315-567

**Classic Lempert Rongeur**

2.5 mm x 10 mm jaw

- 315-542 straight 6 1/4" (16 cm)
- 315-544 curved 6 1/4" (16 cm)
- 315-548 straight 7 1/2" (19 cm)
- 315-550 curved 7 1/2" (19 cm)

\* Additional Rongeurs available. Please call for styles, sizes & details



315-544



straight

curved

**Sontec Lempert Rongeur**

2.5 mm jaw / 6 1/2" (16.6 cm)

- 1100-542 straight
- 1100-544 curved

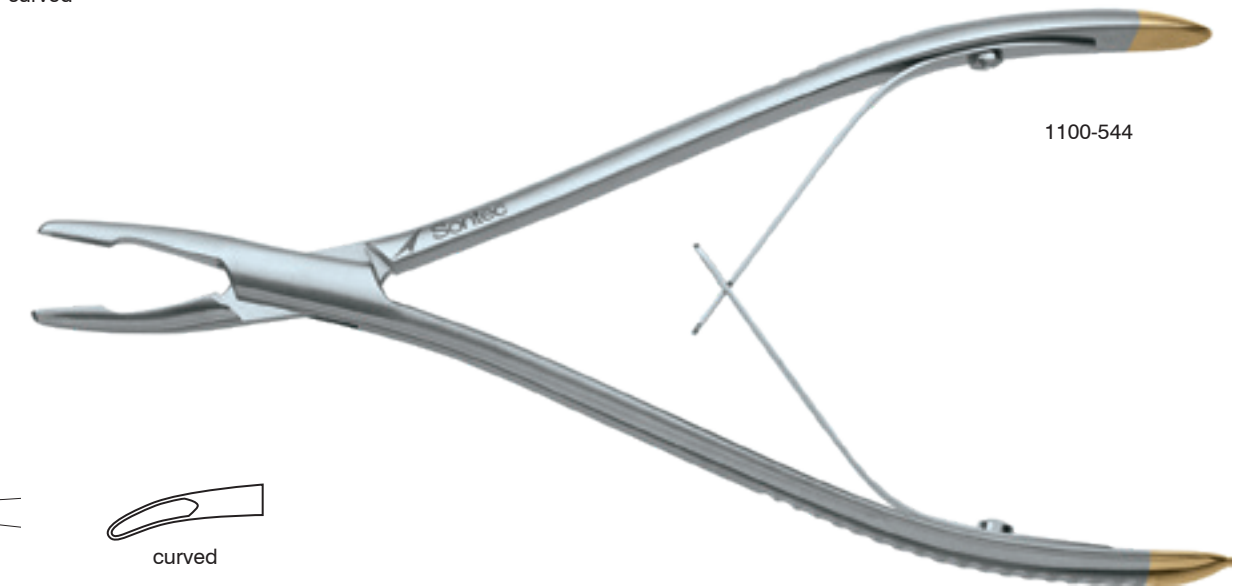

1100-544



straight

curved

**Jeurs Lempert Neuro Rongeur**

Curved to side / 2.5 mm jaw / 7 1/2" (19 cm)

1100-578



1100-578

**Levesque Neuro Rongeur**

Curved to side / low profile / extra delicate / 1.3 mm jaw / 7 1/2" (19 cm)

1100-578A



1100-578A

1100-578A

**Cicherelli Rongeur**

3 mm x 12 mm jaw / full curve / 6 1/2" (16.5 cm)

315-559



315-559

**Cleveland Rongeur**

Curved

315-526 5 1/2" (14 cm)

315-527 6 3/4" (17cm)



315-527

**Defourmentel Rongeur**

Straight / 7" (18 cm)

315-524

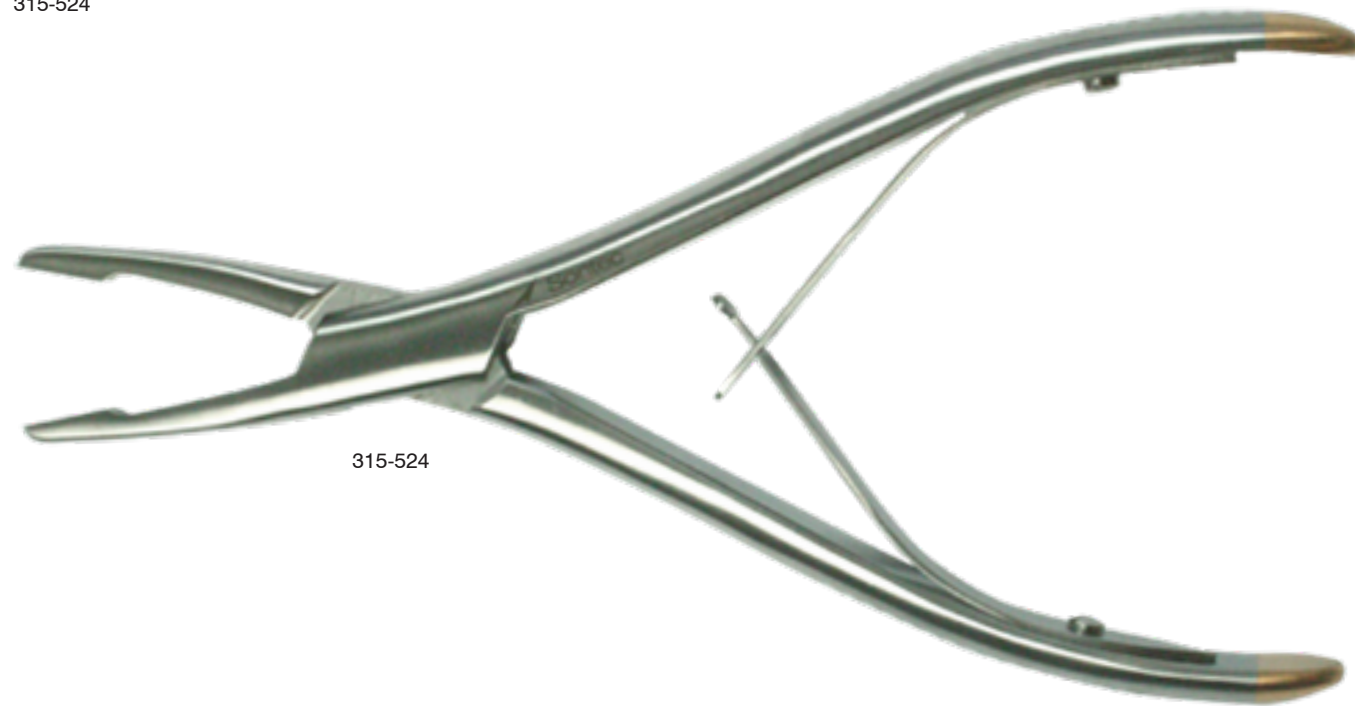

315-524

**Bacon Duckbill Rongeur**

Single-action / curved to side / 4.5 mm x 14 mm jaw / 8" (20 cm)

315-569



315-569



**Hartman Rongeur**

4.5 mm x 12 mm jaw / 5 3/4" (14.5 cm)

- 315-530 str
- 315-532 half curve
- 315-534 full curve

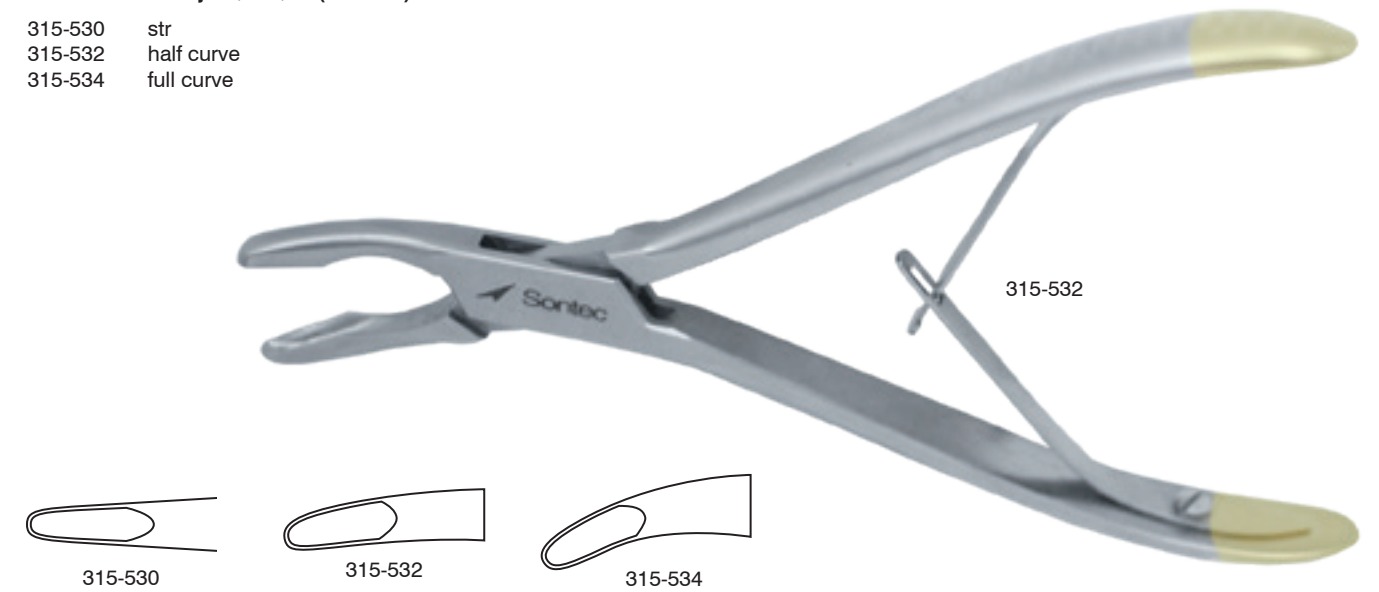

**Cushing Rongeur**

6 mm x 14 mm jaw / 8" (20.5 cm)

- 315-574 straight
- 315-576 curved

Serrated jaw / 6 mm x 14 mm jaw / 8" (20.5 cm)

- 315-572 straight
- 315-573 curved

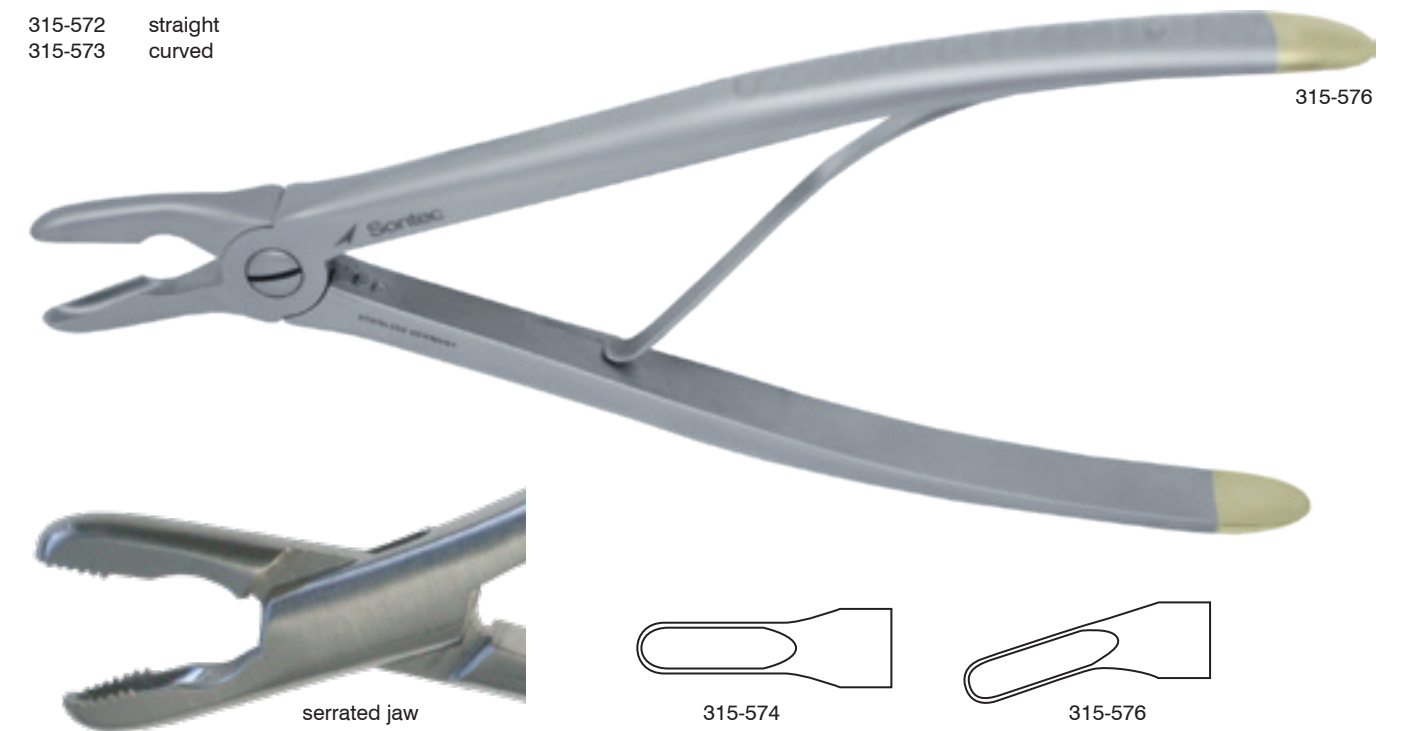

serrated jaw

315-574

315-576

**SONTEC MINIMAL INVASIVE SURGICAL INSTRUMENTATION**  
FINEST QUALITY IN THE INDUSTRY / AGGRESSIVE PRICING



1. Hook Scissors 4.5 mm / 1271-470
2. Kerrison Endoscopic / 404 6062SE
3. Weldon Jr. 2.7 mm / 1273-171
4. Cannula with Stopcock 3.2 mm / SC99-0315
5. Biopsy Grasper with Ratchet / 1271-020H
6. MIS Micro 20 Gauge Scissors / 13-6600
7. Micro Scissors Large Gauge / 13-6710
8. Micro Neuro Bayonet Scissors / 2800-016

**DID YOU KNOW?**  
Sontec specializes in MIS instruments including but not limited to: Laparoscopic, Thoracoscopic, Microdissection, Endoscopic Neuro/Brain Surgery, Arthroscopy, Vitrectomy and Intraocular instrumentation designed for the future of surgery.

**Sontec Instruments®**

Colorado / USA / 800.821.7498

A TRADITION OF FINE SURGICAL INSTRUMENTS

www.Sontecinstruments.com

9. MIS Scissors 15' Axial / 2800-930
10. MIS Cannula Trocar / 2000-117
11. Atraumatic Forceps 3 mm / 2901-201
12. Axial Handle with Spring and Ratchet / 2901-076
13. Atraumatic Forceps 5 mm / 2901-245S
14. Axial Ring Handle / 2901-070
15. Dissecting Forceps without Ratchet / 2100-903

**BALANCING INSTRUMENTATION**  
FINEST QUALITY IN THE INDUSTRY / AGGRESSIVE PRICING



1. Micro 1x2 Tying Forceps / 14-2830
2. Dual Purpose Delicate Tissue Forceps / 2200-079
3. NEW Micro Fracture Pick / 1271-317
4. Micro Level Osteotome / 200-792M
5. NEW MIS 300° Micro Grasper / 2900-013
6. NEW Ortol Grasp Retractor Right / 1100-6280
7. NEW Ortol Grasp Retractor Left / 1100-6282
8. Equine Eye Speculum / 10-1704
9. Eye Speculum / 10-1702
10. NEW Ceramic Matzenbaum Scissors / 1200-9192
11. NEW Ceramic Micro Tips Scissors / 1200-907
12. Deluxe Extra Large Needle Holder / 1100-1100
13. Deluxe Micro Needle Holder / 132-982

**Small Animal  
Equine  
Minimal Invasive Surgery  
Arthroscopy  
Ophthalmology  
Joint Surgery  
and on and on...**

**Sontec Instruments®**

Colorado / USA / 800.821.7498

A TRADITION OF FINE SURGICAL INSTRUMENTS

www.Sontecinstruments.com



# SONTEC INSTRUMENTATION OF EXPERTS

FINEST QUALITY IN THE INDUSTRY / AGGRESSIVE PRICING

1. Martez Dissector - 11-3420
2. Lasic Flap Spatula - 12-2860
3. Kelly Membrane Punch 1.0 mm - 11-9270
4. 0.12 Collet with Angled Teeth - 14-2820
5. Fine Stitch Scissors - 13-4500
6. Marshall 0.3 mm Forceps - T14-3000
7. Serrine Clamp - 14-9240
8. Desmarres Lid Retractor - 10-4200
9. Maslet Capsulohexis Forceps - 14-5364
10. Rizzoli Iris Retractor and Lens Expresor 2 mm - 12-4800
11. Castroviejo TC Needle Holder - 15-1910
12. Bishop Heimon Forceps 0.5 mm - T14-3805
13. Silicone Eye Sphere
14. Pomon Enucleation Scissors - 508-822
15. Micro Interocular Biopsy Forceps - 14-7751
16. 7° Ceramic TCP/PC Madsenbaum Scissors - 1200-915
17. Full Curved Iris Forceps 1 x 2.0 mm - 14-455
18. Singer Capsule Squee/Pelsher - T12-2900
19. Gemard Fixation 1 x 2 Forceps 0.5 mm - 14-5200E
20. Cook Speculum Medium - 10-1402
21. Grade Scissors - 190-550
22. Serrin Clamp Medium - 14-9907
23. Eye Shield Plastic - 1100-429M
24. Suction Cup (for above lens) - 18-8028
25. Tissue Forceps Bipolar Nonstick - 2700-864MS



**Sontec Instruments**

A TRADITION OF FINE SURGICAL INSTRUMENTS

[www.SontecInstruments.com](http://www.SontecInstruments.com)

Colorado / USA / 800.621.7486



# SONTEC EXPERTS OF INSTRUMENTATION

FINEST QUALITY IN THE INDUSTRY / AGGRESSIVE PRICING

1. Verges Phaco Chopper - 12-1407
2. Stevens Ergonomical Scissors - 1200-708
3. Castroviejo Coltri - 14-2200
4. Pigal Probe with Hook - 16-2800
5. Easy Change Phaco I/A Cannula System - 16-3100
6. 0.5 mm 90° Phaco Tip - 16-3103D
7. Plastic Eye Shield - 1100-429L
8. Thopce Caliper - 12-8400
9. Eye Shield Set - 18-8028
10. Serrine - 14-9905
11. Castroviejo Retractor - 10-1701C
12. Trautman Scissors - 13-1510
13. Silicone Eye Spheres
14. Gill Weasas Scissors - 13-5415
15. Barnauer Speculum - T10-1010
16. Kaye Scissors - 1200-072
17. Tennant Forceps - 14-9570
18. Micro Alligator - 469-040
19. Sheppard Lens Forceps - T14-6940
20. Wilder Lens Loop - 12-4402
21. 20 Gauge Vitrectomy Scissors - 13-9900
22. Grife Fixation Forceps - 14-5122
23. Patch Spatula with Spoon - 12-4850
24. Reeh Strich Scissors - 13-9025
25. Jewett's Bipolar Nonstick - 2700-824
26. Ana Needles Holder - 15-3830
27. Jable Forceps - T14-9500



**Sontec Instruments**

A TRADITION OF FINE SURGICAL INSTRUMENTS

[www.SontecInstruments.com](http://www.SontecInstruments.com)

Colorado / USA / 800.621.7486



# PLASTILOGICAL INSTRUMENTATION

FINEST QUALITY IN THE INDUSTRY / AGGRESSIVE PRICING

- 1. Cottle Crusher 350-849
- 2. Gillies 132-394C
- 3. Davis 412-767
- 4. Sontec Stron 1100-479M
- 5. Lacramal Probe 16-2510
- 6. Westcott 13-3306
- 7. Desmarres 10-4220
- 8. Kahn Face Lift Scissors 475-175



- 9. Eye Shield 1100-409M
- 10. Eye Shield Pair 18-8020
- 11. 2 mm 40° Kernsch 404-491
- 12. Desmarres Electro Blue 14-9608
- 13. Bipolar Suction Forceps 2700-817
- 14. Joseph 16-2210
- 15. 0.5 Castroviejo 14-2820
- 16. Cottle 6 mm 330-849C

- 17. Puttmann 714-9400
- 18. Jewellers 14-6940
- 19. Mini Neuro 1106-086
- 20. Silicon Eye Spheres 1100-411-23
- 21. Joseph Hook Electro Blue 199-432
- 22. Stevens 1200-497
- 23. Sphare Introducer 17-1000
- 24. Castroviejo 15-1910

**Sontec Instruments®**

A TRADITION OF FINE SURGICAL INSTRUMENTS

Colorado / USA / 800.821.7486

www.SontecInstruments.com



# NECESSARY SELECTIONS

FINEST QUALITY IN THE INDUSTRY / AGGRESSIVE PRICING



- 1. Westcott with wide grip - 13-3301
- 2. 0.5 Bishop Harmon - T14-3805
- 3. Ceramic Stevens - 1200-690
- 4. Jewellers #4 - 2200-0014
- 5. Barraquer - T10-1000
- 6. Barraquer - T10-1005
- 7. Colibri 0.12 fluted handle - 14-5395
- 8. Castroviejo speculum - 10-1700C
- 9. Dert TC - 132-354
- 10. 2.5 mm Burr - 11-4612
- 11. Easy Change Handle - 16-3100
- 12. 0.5 Blinkherst - 16-3107B
- 13. Strabismus Power Cut - 1200-023
- 14. Manhattan 0.3 - T14-3060

**Sontec Instruments®**

A TRADITION OF FINE SURGICAL INSTRUMENTS

Colorado / USA / 800.821.7486

www.SontecInstruments.com

# TAKAHASHI RONGEURS

FINEST QUALITY IN THE INDUSTRY / AGGRESSIVE PRICING



1. Straight - 404-767 / 2.5 mm x 10 mm jaw cup / 4 1/2" (11.5 cm) shaft
2. Straight - 404-768 / 2.5 mm x 10 mm jaw cup / 5 1/2" (14 cm) shaft
3. Straight - 404-7675 / 3.5 mm x 10 mm jaw cup / 4" (10 cm) shaft
4. Straight - 404-7671 / 2.5 mm x 10 mm jaw cup / 5 1/2" (14 cm) shaft
5. Up-angled - 404-768U / 3 mm x 10 mm jaw cup / 4 1/2" (11.5 cm) shaft

Select from a variety of jaw sizes, angles and shaft lengths. Peapods offer the perfect jaw design for tight small and hard to navigate joint areas!

**Sontec Instruments®**

A TRADITION OF FINE SURGICAL INSTRUMENTS

Colorado / USA / 800.621.7486

www.Sontecinstruments.com

# NEUROSURGICAL INNOVATION

BY THE LEADER IN INSTRUMENTATION / FINEST QUALITY IN THE INDUSTRY / AGGRESSIVE PRICING



1. Decker Rongeur 469-067
2. Sontec Tapered S-Retractor 207-417
3. Micro Axial Bayonet Scissors 2900-022
4. 3 mm Tumor Grasping Forceps 400-075
5. Jacob Bayonet Needle Holder TC Round Handle Curved Jaws 400-229
6. Bayonet Foreminotomy Kerison 404-468
7. Micro Axial New Large Gauge Handle Needle Holder 2900-004
8. Suction Monopolar Silver Non-Slick 2700-554NS

9. Neuro Jacobson Scissors 2400-6900
10. Dissector 412-550T
11. Axial Curette 320-886D
12. Dissecting Suction Elevator 478-360
13. Dissecting Suction Elevator 2700-310
14. Brain Spatula 2 mm 412-779
15. Elevator with Suction 478-375
16. Dissector Curette 412-547T
17. Dissector Wax Packer 412-549

**Sontec Instruments®**

A TRADITION OF FINE SURGICAL INSTRUMENTS

Colorado / USA / 800.621.7486

www.Sontecinstruments.com



# CeramiTec

FINEST QUALITY IN THE INDUSTRY / AGGRESSIVE PRICING

Sontec's CeramiTec line of unique instrumentation is identified at first glance by its bold jet black surface with bright gold lettering for easy recognition and recording. CeramiTec is designed to reduce friction which prolongs the sharpness of a scissors' blades. Please visit [SontecInstruments.com](http://SontecInstruments.com) to view all CeramiTec products. You may also request a printed catalog.



- 1. Bandage Scissors / 1200-660
- 2. Metzenbaum / 1200-615 3. Freeman / 1200-670
- 4. Dissector 45° / 413-003 5. Micro Hook / 413-010
- 6. 5 mm Hook 90° / 413-017 7. 7 mm Probe 45° / 413-018
- 8. Curved Dissecting Spatula / 413-004 9. Baby Metzenbaum / 1200-622
- 10. Iris Scissors / 1200-650 11. Metzenbaum 5 3/4" / 1200-611 12. Stevens 4 1/2" / 1200-630
- 13. Jaboulay / 1200-640 14. Baby Metzenbaum Spread Handle / 1200-609 15. Stevens 4 1/4" / 1200-628
- 16. Westcott / 13-3004B 17. Stevens Spread Handle / 1200-605 18. Jacobson / 2400-603B

## Sontec Instruments®

A TRADITION OF FINE SURGICAL INSTRUMENTS

Colorado / USA / 800.821.7496

[www.SontecInstruments.com](http://www.SontecInstruments.com)



# SONTEC ELECTRIFIED BIPOLAR

FINEST QUALITY IN THE INDUSTRY / AGGRESSIVE PRICING

Creating non-stick ceramic & silver electro cauterly instrumentation



**CERAMIC**  
Inlayed blades provide an incredible smooth cut.



**FORCEPS**  
all shown are available in a variety of lengths, tip sizes and angles. Choose wide or classic grip.



- 1. Bayonet Wide Grip Forceps - 2700-852NS
- 2. Bayonet Wide Grip with Suction - 2700-817
- 3. Bayonet Wide Grip Forceps - 2700-807NS
- 4. Bipolar Non-Stick Frazer Suction - 2700-552NS
- 5. Adson 5-Hole Forceps - 2700-608NS 6. Metzenbaum Scissors 2700-5331
- 7. Cushing Trause Forceps - 2700-804NS 8. Cushing Forceps 2700-605NS
- 9. Metzenbaum Scissors 2700-5071 10. Jensen Bayonet Classic Grip Forceps 2700-691NS
- 11. Metzenbaum Scissors 2700-5431 12. Bayonet Wide Grip Forceps 2700-644NS

## Sontec Instruments®

A TRADITION OF FINE SURGICAL INSTRUMENTS

Colorado / USA / 800.821.7496

[www.SontecInstruments.com](http://www.SontecInstruments.com)

**EUROPEAN PLUG**  
connections available upon special order

HERCULES  
AND THE  
POWER OF  
THE GREEK  
GOD'S CAN  
BE IN YOUR  
HANDS



1. Wire Cutter  
9" - 355-189 / 11" - 355-191
2. TC Blades Replacement Set  
9" - 355-190 / 11" - 355-192
3. Rubber Jaws Replacement Set  
9" - 355-193 / 11" - 355-193

**Sontec Instruments**

A TRADITION OF FINE SURGICAL INSTRUMENTS

  
AUTHORIZED DEALER  
OF LIGHTS & LOUPES

Colorado / USA / 800.821.7496

www.SontecInstruments.com



# UNIVERSAL KLICK KERRISON SET

FINEST QUALITY IN THE INDUSTRY / AGGRESSIVE PRICING

- 360° 8-point rotation
- Built in ejector pin on all shaft designs

1. 5 mm 40° 404-6085
2. 3 mm 40° 404-6083
3. 2 mm 90° 404-6072
4. 1 mm 40° 404-6081
5. Endoscopic Shaft 2.5 mm 40° 404-60825E
6. Beatty Foamotomy
7. Beatty Foamotomy  
Curved Down 2 mm 40° 404-6082C
8. Beatty Foamotomy  
Curved Up 2 mm 40° 404-6082
9. Universal Klick Kerrison Handle 404-606
10. Endoscopic Shaft 3 mm 40° 12 1/2" 404-6088E
11. Endoscopic Shaft 3 mm 40° 404-6083EB
12. Bayonet Shaft 3 mm 40° 16" 404-6083B



**Sontec Instruments**

A TRADITION OF FINE SURGICAL INSTRUMENTS

Colorado / USA / 800.821.7496

www.SontecInstruments.com

# ELITE WIRELESS LED HEADLIGHT

FINEST QUALITY IN THE INDUSTRY / AGGRESSIVE PRICING



Wrap around rear cranial support on headband for added comfort. Removable if needed



Easy change battery fixture holds one battery while the backup is charging

Rheostat control  
0-30,000 Lux  
at 16"/40 cm  
working distance

100-5500

Removable / sterilizable  
lever to safely adjust  
beam direction

Battery indicator /  
Low battery indicator

Rheostat for spot  
variability 20-110 mm  
at 16"/40 cm working  
distance

Ideal color  
temperature  
at 4,500° K

Sold with 2 batteries, each with  
4 hours of power at 100% output  
and a lightweight carrying case

Designed to remove shadows  
in complex surgical operations

- Cardiovascular
- Orthopedic
- Spinal
- Abdominal

**Sontec Instruments®**

# UNIVERSAL KERRISON SET

FINEST QUALITY IN THE INDUSTRY / AGGRESSIVE PRICING



404-608-SET Set

Classic Standard Set includes:

404-6081	1 mm 40° 8" shaft
404-6082	2 mm 40° 8" shaft
404-6083	3 mm 40° 8" shaft
404-6084	4 mm 40° 8" shaft
404-6085	5 mm 40° 8" shaft
404-6086	2 universal handles

18-3564 tray only

To configure you own personalized set,  
refer to "Kerrison Section" > "Kerrison  
Universal Rotating 360° Rongeur" for  
all possible options

\*different size shafts available up request

**Sontec Instruments®**

Product update: **HEINE® LoupeLight 2**

With HEINE HR or HRP Binocular Loupes for a perfect view.

The combination of light and loupe delivers the ultimate in performance as high quality illumination with LED<sup>HQ</sup> maximises the image quality of the loupe.

For a perfect view and a precise diagnosis, the LoupeLight 2 is now 25% brighter than its predecessor model, with a homogeneous edge-to-edge illumination of typ. 55,000 lux.

For intensive use, the LoupeLight 2 now features a replaceable connecting cord which connects the device to the mPack mini – the new and compact power source for the LoupeLight 2 (product description see overleaf).

**NEW!**  
 ✓ Now 25% brighter due to improved LED technology  
 ✓ Replaceable connecting cord



Replaceable connecting cord with high-quality splashproof threaded connector for heavy duty use.

Now even 25% brighter

**LED<sup>HQ</sup>**  
 LED NOW IN HEINE QUALITY.



HR 2.5x High Resolution Binocular Loupes. Achromatic optics for crisp, bright images.

Product update: **HEINE® MicroLight 2**

Ultralight, universal headlight.

For those who need a compact, lightweight illumination solution without magnification, we offer the MicroLight 2. Featuring LED<sup>HQ</sup> illumination for homogeneous illumination with true and natural colour rendering for every examination situation. Two mounting options offer individuality and easy handling. Illumination without compromises, in a lightweight design.



HEINE MicroLight 2 on S-FRAME



HEINE MicroLight 2 on Lightweight Headband

See overleaf for ordering information.



**HEINE® mPack mini** – The compact and light power source for LoupeLight 2 and MicroLight 2.

The new, high performance power source HEINE mPack mini for LoupeLight 2 and MicroLight 2 offers freedom from cables that tie the users to desk, wall or static power sources. With a weight of just 95g and dimensions of 44 x 23 x 101 mm, this mobile power source is now approximately approx. 70% smaller and lighter than its predecessor.

The pouch, which is included in the delivery, can be attached to the belt. The mPack mini can also be charged whilst in the pouch. Thanks to the LI-ion battery technology the power source has an operating time of typ. 9 hours, in continuous operation at maximum power typ. 4 hours. The mPack mini is flexible in charging due to its USB connector. Charge it via laptop, desktop or USB charger.

**NEW!**  
 ✓ 70% smaller and lighter  
 ✓ Operating time typ. 9 hours  
 ✓ Charging time typ. 4 hours



USB charging option



Size comparison of HEINE mPack LL/mPack mini

LoupeLight 2 Sets with HR Binocular Loupes	
HR 2.5x optics with i-View on S-FRAME, LoupeLight 2, detachable yellow filter, mPack mini, mPack mini Belt Clip, E4-USB plug-in transformer, protective lenses, 2 sterilisable levers, retaining cord, cleaning fluid, cleaning cloth, carrying case	
340mm working distance	C-008.32.450
420mm working distance	C-008.32.451
520mm working distance	C-008.32.452
MicroLight 2 Sets	
MicroLight 2 on S-FRAME with mPack mini, mPack mini Belt Clip, E4-USB plug-in transformer, retaining cord and cleaning fluid in case	J-008.31.276
MicroLight 2 on Lightweight Headband with mPack mini, mPack mini Belt Clip, E4-USB plug-in transformer, case	J-008.31.277
Single Devices	
LoupeLight 2 for HR/HRP Loupes with i-View loupe mount	C-008.32.226
mPack mini with LI-ion rechargeable battery and E4-USB plug-in transformer	X-007.99.650
mPack mini with LI-ion rechargeable battery, without E4-USB plug-in transformer	X-007.99.649
Connecting cord SC1 (1.6m) for LoupeLight 2 or MicroLight 2/mPack mini	C-000.32.240

For further ordering information please contact your HEINE distributor **Sontec Instruments**

**Sontec Instruments**  
 7248 S. Tucson Way  
 Centennial, CO 80112  
 USA Headquarters  
 Heine USA



AUTHORIZED DEALER

**HEINE Optotechnik GmbH & Co. KG**, Kientalstr. 7, 82211 Herrsching, Germany  
 Tel. +49 (0) 8152/38-0, Fax +49 (0) 8152/38-202, E-Mail: info@heine.com, www.heine.com



A-090300218 • 04/17  
 We reserve the right to change specifications without notice.  
 © 2018 HEINE Optotechnik GmbH & Co. KG. All rights reserved.

## Index

T10-1000	422	10-1055	425	10-4241	303, 413
T10-1000C	422	T10-1056	425	10-4245	303
T10-1005	422	10-1062	424	10-4246	303
T10-1010	422	10-1150	426	10-4269	302
T10-3825	412	10-1300	426	10-4270	302
T10-5480	415	10-1300S	426	10-4520	411
T10-5487	415	T10-1320	426	10-4521	411
T10-5489	415	10-1340	426	10-4522	411
T10-5491	415	10-1350	426	10-4525	411
T13-3417	74	10-1360	426	10-4530	411
T13-3418	74	10-1360H	426	10-4535	411
T14-2220	134	10-1400	427	10-4540	411
T14-2800	134, 144	10-1401	427	10-4600	356
T14-2810	134, 144	10-1402	427	10-5400	414
T14-2830	134, 144	10-1403	427	10-5480	415
T14-2840	134, 144	10-1404	427	10-5487	415
T14-6805	116	10-1405	427	10-5489	415
T14-6820	116	10-1420	427	10-5491	415
T14-6830	116	10-1422	427	11-4560	416
T14-6840	116	10-3100-SET	412	11-4600	416
T14-6850	116	10-3140	412	11-4601	416
T14-6860	116	10-3150	412	11-4609	416
T14-9400	128, 129	10-3160	412	11-4610	416
T14-9990	129	10-3170	412	11-4611	416
T15-1800	90	10-3180	412	11-4612	416
T15-1810	90	10-3190	412	11-4613	416
T15-1820	90	10-3200	412	11-4614	416
T15-1830	90	10-3210	412	11-4615	416
T15-1860	90	10-3220	412	11-4616	416
T15-1861	90	10-3310	412	11-4617	416
T15-1880	90	10-3312	412	11-4618	416
T15-1881	90	10-3314	412	12-1285	176, 416
T15-1912	93	10-3800	412	12-1290	176, 416
T15-1913	93	10-3810	412	12-1300	176, 416
T15-1914	93	10-3820	412	12-1310	176, 416
T15-1915	93	10-3825	412	12-1320	176, 416
T15-1916	93	T10-3840	412	12-1355	176, 416
T15-1917	93	10-3890	411	12-1360	176, 416
T115-452	161	10-4192	302, 413	12-1365	176, 416
T136-688	121	10-4194	302, 413	12-1367	176, 416
10-1000	422	10-4196	302, 413	12-1368	176, 416
10-1000C	422	10-4198	302, 413	12-9200	334
10-1000C-13	422	10-4200	302, 413	12-9300	334
10-1005	422	10-4201	302, 413	12-9300D	334
10-1005C	422	10-4206	302, 413	12-9305	334
10-1007	422	10-4207	302, 413	12-9310	334
10-1010	422	10-4210	302, 413	12-9310D	334
10-1010C	422	10-4211	303, 413	12-9315	334
10-1010C-08	422	10-4213	302, 413	12-9316	334
10-1015	423	10-4216	302, 413	12-9318	334
10-1016	423	10-4218	302, 413	12-9320	335
10-1020	424	10-4220	302, 413	12-9330	335
T10-1020	424	10-4221	303, 413	12-9335	335
10-1030	424	10-4223	302, 413	12-9340	337
T10-1030	424	10-4226	302, 413	12-9400	336
10-1043	424	10-4227	302	12-9450	336
10-1050	425	10-4230	302, 413	12-9500	339
T10-1051	425	10-4231	303, 413	12-9600	337
10-1053	425	10-4233	302, 413	12-9630	337
T10-1053	425	10-4236	302, 413	13-3306	73
10-1054	425	10-4237	302	13-3307	73
T10-1054	425	10-4240	302, 413	13-3307S	73

13-3400	73	14-3060	132	14-6810	116
13-3401	73	T14-3060	132	14-6815	116
13-3402	73	14-3070	132	14-6816	116
13-4400	72	T14-3070	132	14-6820	116
13-4402	72	14-3071	132	14-6821	116
13-6800	55	14-3072	132	14-6830	116
13-6810	55	14-3073	132	14-6831	116
13-6815	55	14-3074	132	14-6840	116
13-7500	80	14-3075	132	14-6850	116
13-7510	80	14-3077	132	14-6870	116
13-7520	80	14-3150	133	14-9400	128
13-7522	80	14-3152	133	14-9410	128
13-7524	80	14-3154	133	14-9700	125
13-7526	80	14-3200	134	14-9725	129
13-7528	80	14-3210	134	14-9730	126
13-7530	80	14-3240	133	14-9740	126
13-7532	80	14-3245	133	14-9750	126
13-7533	80	14-3246	133	14-9800	126
13-7600	79	14-3247	133	14-9850	126
13-7610	79	14-3248	133	14-9870	129
13-7620	81	14-3260A	133	14-9893	127
13-7700	81	14-3260B	133	14-9894	127
13-7710	81	14-3260C	133	14-9895	127
13-7715	81	14-3260D	133	14-9900	127
13-7720	80	14-3800	134	14-9901	127
13-7730	80	T14-3803	134	14-9902	127
13-7740	82	14-3805	134	14-9906	127
13-7750	82	T14-3805	134	14-9907	127
13-7786	82	14-3810	134	14-9908	127
13-8805	74	T14-3810	134	14-9910	129
13-8813	78	14-3850	143	14-9920	129
13-8814	78	14-3860	143	14-9925	129
13-8815	74	14-4300	123	14-9930	131
13-8820	74	14-4305	123	14-9935	154
13-8825	74	14-4310	123	14-9940	154
13-8865	74	14-4340	123	14-9990	129
13-8866	74	14-4345	123	14-9992	129
13-9325	335	14-4350	123	15-0230	432
13-9805	83	14-4400	143	15-0231	432
13-9810	83	14-4410	143	15-0232	432
13-9820	83	14-4415	143	15-0233	432
13-9822	83	14-4440	143	15-1300	92
14-2100	135	14-4450	143	15-1300F	92
14-2110	135	14-4455	143	15-1310	92
14-2220	134	14-4600	133	15-1320	92
14-2630	132	14-4620	133	15-1320F	92
14-2800	134, 144	14-4800	133	15-1330	92
14-2805	134, 144	14-5120	125	15-1800	90
T14-2805	134, 144	14-5122	125	15-1810	90
14-2810	134, 144	14-5130	125	15-1820	90
14-2815	134, 144	14-5200	125	15-1830	90
T14-2815	134, 144	14-5205	125	15-1860	90
14-2820	134, 144	14-5215	125	15-1861	90
T14-2820	134, 144	14-5220	125	15-1880	90
14-2830	134, 144	14-5240	127	15-1881	90
14-2840	134, 144	14-6303	130, 143	15-1900	93
14-2860	134, 144	14-6310	131	15-1901	93
14-2880	134, 144	14-6400	130	15-1910	93
14-2890	132	14-6415	130	15-1911	93
14-2905	135	14-6445	131	15-1912	93
14-2920	135	14-6450	131	15-1913	93
14-2922	135	14-6500	130	15-1914	93
14-2935	135	14-6510	130	15-1915	93
14-2955	135	14-6560	118	15-1916	93
14-3050	132	14-6562	118	15-1917	93
T14-3050	132	14-6564	118	16-2096	421

16-2097	421	16-3348	410	115-450	161
16-2098	421	16-3350	410	115-452	161
16-2099	421	16-3800	410	115-520	160
16-2100	420	16-3810	410	115-522	160
16-2101	420	16-3820	410	115-524	160
16-2102	420	16-3821	410	115-526	160
16-2103	420	16-3826	410	115-530	160
16-2104	420	16-5300-SET	409	115-532	160
16-2105	420	16-5310	409	115-534	160
16-2106	420	16-5320	409	115-536	160
16-2207	204	16-5321	409	115-538	160
16-2208	204	16-5325	409	115-540	160
16-2209	204	16-5330	409	115-554	168
16-2210	204	16-5331	409	115-556	363
16-2330	226	16-5340	409	115-585	154
16-2332	226	17-1000	409	115-586	154
16-2365	228	18-8020	407	115-4461	158
16-2368	229	18-8020B	407	115-4481	158
16-2372	229	18-8022	407	117-500	169
16-2374	229	18-8022B	407	117-500L	169
16-2376	229	18-8025	407	117-501	170
16-2440	431	18-8025B	407	117-503	170
16-2460	431	18-8026	407	117-506	172
16-2470	431	18-8026B	407	117-516	173
16-2480	431	18-8028	407	117-517	173
16-2500	431	18-8301	338	117-518	171
16-2510	431	18 mm . 302		117-521	171
16-2520	428	48-0339	299	117-523	171
16-2530	428	48-0340	299	117-524	172
16-2530S	428	110-260	57	117-560	11
16-2540	428	110-308	58	117-561	11
16-2540S	428	110-312	50	117-571	11
16-2541	428	110-313	50	117-577	10
16-2550	428	112-478	81	117-578	10
16-2550S	428	112-480	81	117-588	11
16-2551	428	112-580	49	117-593	11
16-2560	428	112-581	49	117-5781	10
16-2560S	428	112-582	49	130-508	100
16-2561	428	112-585	49	130-514	106
16-2570	428	112-602	55	130-517	97
16-2570S	428	112-603	55	130-518	97
16-2571	428	115-310	157, 159	130-521	105
16-2578	428	115-312	157, 159	130-523	105
16-2579	428	115-316	159	130-525	105
16-2580	428	115-318	159	130-526	105
16-2581	428	115-320	159	130-527	107
16-2582	428	115-322	159	130-529	107
16-2583	428	115-400	156	130-531	107
16-2584	428	115-402	156	130-563	95
16-2585	428	115-404	156	130-564	94
16-2586	428	115-407	159	130-565	94
16-2587	428	115-408	156, 159	132-110	106
16-2588	428	115-410D	156	132-115	107
16-2589	428	115-412D	156	132-118	107
16-2590	429	115-422	157	132-120	107
16-2592	429	115-422M	157	132-122	107
16-2594	429	115-424	157	132-123	107
16-2596	430	115-426	157	132-125	107
16-2600	431	115-426D	157	132-210	105
16-3290	410	115-428	157	132-212	105
16-3300	410	115-428D	157	132-214	105
16-3310	410	115-429	157	132-216	105
16-3314	410	115-432	161	132-218	105
16-3320	410	115-434	161	132-223	105
16-3330	410	115-446	158	132-224	105
16-3346	410	115-448L	158	132-225	105

132-359	110	136-664D	121	140-519G	138
132-360	110	136-665	121	140-519M	138
132-361	110	136-668A	123	140-3032	117
132-362	110	136-674	123	140-3042	117
132-362D	110	136-674D	123	150-240	164
132-362S	110	136-679	123	150-2408	164
132-364	100	136-686	119	180-373	385
132-364L	100	136-686D	119	180-374	385
132-364S	100	136-687	119	180-375	385
132-365	100	136-688	119	180-376	385
132-367	99	136-688S	119	180-377	385
132-367A	99	136-688T	121	180-378	385
132-372	97	136-689	119	180-379	385
132-373	97	136-697	119	180-380	385
132-374	97	136-698	119	180-381	385
132-375	100	136-699	122	180-382	385
132-376	100	136-700	119	180-403	385
132-376S	100	136-730	137	180-404	385
132-379	101	136-732	138	180-405	385
132-379S	101	136-735	137	180-406	385
132-380	101	136-737	138	180-407	385
132-380S	101	136-738	137	180-408	385
132-381	101	136-740	137	180-409	385
132-381S	101	136-742	138	180-410	385
132-382	111	136-746	137	180-411	385
132-382L	111	136-748	138	180-412	385
132-383	111	136-798	139	180-420	396
132-383L	111	136-6601	120	180-422	396
132-384C	112	136-6621T	120	180-424	396
132-384D	112	136-6741	121	180-432	394
132-384L	112	136-6891	119	180-433	394
132-387	111	140-198	120	180-436	394
132-388	105	140-201	120	180-439	394
132-450	95	140-202	117	180-440	394
132-632	100	140-203	117	180-448	395
132-634	100	140-207	117	180-449	395
134-240	376	140-220	140	180-451	395
134-242	376	140-220B	140	197-690	432
134-243	378	140-222B	140	197-691	432
134-245	378	140-297	121	197-692	432
134-247	379	140-298T	118	197-693	432
134-248	379	140-299	120	197-694	432
134-267	378	140-301	120	197-695	432
134-268	379	140-302	122	197-700	432
134-276	376	140-302D	122	197-701	432
134-277	378	140-302F	122	197-702	432
134-277M	378	140-303	117	197-703	432
134-278	378	140-303F	122	197-704	432
134-278M	378	140-304	117	197-705	432
134-280	378	140-304F	117	199-129	178, 417
134-280M	378	140-304T	118	199-130	178, 417
134-281	378	140-305	117	199-131	178, 417
134-281M	378	140-305F	117	199-132	178, 417
134-282A	378	140-306	117	199-133	178, 417
134-282B	378	140-307	117	199-136	178, 417
136-578	136	140-309	117	199-300	179
136-580	136	140-376	138	199-302	179
136-659	118	140-376B	141	199-304	179
136-659D	118	140-378	138	199-306	179
136-660	120	140-379	138	199-308	179
136-660A	120	140-500	136	199-310	179
136-661	120	140-502	136	199-312	179
136-662	120	140-517	138	199-314	179
136-662T	120	140-517G	138	199-320	179
136-663	120	140-517M	138	199-322	179
136-664	121	140-519	138	199-372	240

199-375	247	199-490	254, 415	201-120	267
199-380	240, 245	199-500	47	201-122	267
199-382	240, 245	199-501	47	201-124	267
199-383	290, 291	199-501B	47	201-126	267
199-384T	240	199-502	47	201-128	267
199-385	240	199-550	48	201-130	267
199-387	240	199-600	331	201-132	267
199-390	240	199-602	331	201-134	267
199-391	240	199-604	331	201-136	267
199-392	241	199-606	331	201-138	267
199-392T	241	199-3841T	240	201-140	267
199-393A	241	199-3921T	241	201-142	267
199-393B	241	199-4131T	243	201-144	267
199-393C	241	199-4182	249	201-146	267
199-394	240	201-002	265	201-148	267
199-395	241	201-004	265	201-150	267
199-396	241	201-006	265	201-152	267
199-397	250	201-008	265	201-154	267
199-397S	250	201-010	265	201-160	267
199-398	250	201-012	265	201-162	267
199-400	242	201-014	265	201-164	267
199-401T	242	201-016	265	201-166	267
199-402T	241	201-018	265	201-168	267
199-405	243	201-020	265	201-170	267
199-406	242	201-022	265	201-172	267
199-406T	242	201-024	265	201-174	267
199-410	242	201-026	265	201-176	267
199-411	242	201-028	265	201-178	267
199-412T	243	201-030	265	201-180	267
199-413T	243	201-032	265	201-182	267
199-414	248	201-034	265	201-184	267
199-415	248	201-036	265	201-186	267
199-416	248	201-038	265	201-190	266
199-417	249	201-040	265	201-192	266
199-418	248	201-050	266	201-194	266
199-419	249	201-052	266	201-196	266
199-420	248	201-054	266	201-198	266
199-420T	246	201-056	266	201-200	266
199-421	249	201-060	266	201-202	266
199-422	248	201-062	266	201-210	266
199-424	249	201-064	266	201-212	266
199-426	248	201-066	266	201-214	266
199-428	249	201-068	266	201-216	266
199-430	248	201-070	266	201-218	266
199-432	249	201-072	266	201-220	266
199-434	248	201-074	266	201-222	266
199-436	249	201-076	266	201-230	266
199-438	248	201-078	266	201-232	266
199-440	249	201-080	266	201-234	266
199-442	248	201-082	266	201-236	266
199-444	249	201-084	266	201-240	266
199-446	248	201-086	266	201-242	266
199-448	249	201-090	266	201-244	266
199-450	248	201-092	266	201-246	266
199-452	249	201-094	266	201-260	267
199-458	248	201-096	266	201-262	267
199-460	249	201-098	266	201-264	267
199-462	248	201-100	266	201-266	267
199-464	249	201-102	266	201-268	267
199-470T	242	201-104	266	201-270	267
199-480	254, 415	201-106	266	201-272	267
199-481	254, 415	201-108	266	201-274	267
199-482	254, 415	201-110	266	201-276	267
199-483	254, 415	201-112	266	201-278	267
199-484	246	201-114	266	201-280	267
199-485	246	201-116	266	201-282	267

201-284	267	205-870	257	207-472	298
201-286	267	205-880	250	207-473	298
201-288	267	205-881	250	207-474	298
201-290	267	205-882	250	207-482	298
201-300	267	205-884	250	207-484	298
201-302	267	205-885	250	207-486	298
201-304	267	205-886	250	207-488	298
201-306	267	205-907	283	207-490	298
201-308	267	205-907L	283	207-921	214
201-310	267	205-908	283	207-922	214
201-312	267	205-908L	283	207-923	214
201-314	267	205-909	283	207-924	214
201-316	267	205-909L	283	207-930	285
201-330	264	205-910	283	207-945	284
201-332	264	205-910L	283	207-950	213
201-334	264	205-912	283	207-951	213
201-336	264	207-289L	286	207-952	213
201-338	264	207-290	295	207-953	213
201-350	264	207-290L	295	207-954	213
201-352	264	207-292	295	207-955	213
201-354	264	207-292L	295	207-956	213
201-356	264	207-293	295	207-957	213
201-358	264	207-293L	295	207-960	212
201-360	264	207-295	291	207-961	212
201-362	264	207-326	297	207-963	212
201-364	264	207-328	297	207-966	212
201-366	264	207-330	297	207-2920	300
201-380	264	207-333	297	207-2921	300
201-382	264	207-338	297	207-2922	301
201-384	264	207-340	297	207-2923	301
201-386	264	207-342	297	207-2924	292
201-388	264	207-345	297	207-2925	295
201-390	264	207-417	290	207-2928	292
201-400	264	207-418	290	207-2928T	292
201-402	264	207-419-10	290	207-2929	274
201-404	264	207-419-12	290	207-4221	289
201-406	264	207-420	288	207-4231	289
201-410	264	207-421	288	207-4232	289
201-412	264	207-422	288	207-4234	289
201-414	264	207-422L	288	207-4242	289
201-416	264	207-423	288	207-4271	289
205-700	245	207-423A	288	207-4281	289
205-800	302	207-423L	288	215-026	165
205-819	253, 414	207-424	288	215-027	165
205-820	253, 414	207-424L	288	215-028	165
205-822	253, 414	207-425	288	215-029	165
205-824	253, 414	207-426	288	215-100	293
205-826	253, 414	207-427	288	220-143	251
205-828	253, 414	207-428	288	220-145	252
205-830	253, 414	207-429	288	220-149	252
205-844	253, 414	207-431	288	220-150	252
205-846	253, 414	207-454	298	220-151	252
205-847	253, 414	207-455	298	220-152	252
205-848	253, 414	207-456	298	220-155	252
205-849	296	207-460	298	220-155L	252
205-849B	296	207-461	298	220-156	252
205-850	246	207-462	298	220-160	251
205-856	305	207-463	298	230-487	307
205-857	305	207-464	298	230-488	307
205-858	305	207-465	298	230-489L	308
205-859	305	207-466	298	230-489R	308
205-860	305	207-467	298	230-495	309
205-861	305	207-468	298	230-496	309
205-864	254	207-469	298	230-4961	309
205-865	254	207-470	298	305-910	377
205-867	306	207-471	298	315-505	442

315-505C	442	330-324	201	330-632	186
315-505S	442	330-326	201	330-633	186
315-511	443	330-330	201	330-634	186
315-513	443	330-336	201	330-635	186
315-515	443	330-338	201	330-636	186
315-524	448	330-460	189	330-640	186
315-526	447	330-462	189	330-641	186
315-527	447	330-464	189	330-642	186
315-530	449	330-466	189	330-643	186
315-532	449	330-468	189	330-644	186
315-534	449	330-470	189	330-645	186
315-542	321, 445	330-472	189	330-646	186
315-544	321, 445	330-482	198	330-650	186
315-548	321, 445	330-483	198	330-651	186
315-550	321, 445	330-484	198	330-652	186
315-559	447	330-485	198	330-653	186
315-566	444	330-486	198	330-808	437
315-567	444	330-487	198	330-817	437
315-569	448	330-488	198	330-818	436
315-572	449	330-489	198	330-819	437
315-573	449	330-490	198	335-105	208
315-574	449	330-491	198	335-106	208
315-576	449	330-492	198	335-250	218
315-580	441	330-495	198	335-254	218
315-581	441	330-500	188	335-255	218
315-597	321	330-511	188	335-260	218
315-598	321	330-512	188	335-265	218
315-599	321	330-513	188	335-270	219
320-769	179	330-514	188	335-275	219
320-770	179	330-515	188	335-280	219
320-771	179	330-516	188	335-285	219
320-925	251	330-517	188	345-212	403
320-930	251	330-518	188	345-241	348
320-935	251	330-519	188	345-242	348
320-937	251	330-530	188	345-243	351
320-949	179	330-531	188	345-246	342, 353
330-020	187	330-532	188	345-246A	342, 353
330-021	187	330-533	188	345-248	403
330-022	187	330-534	188	345-249	403
330-023	187	330-535	188	345-255	402
330-024	187	330-536	188	345-256	402
330-030	187	330-537	188	345-257	402
330-031	187	330-538	188	345-264	351
330-032	187	330-539	188	345-265	351
330-033	187	330-590	188	345-266	351
330-034	187	330-591	188	345-267	351
330-035	187	330-592	188	345-279	347
330-051	184	330-593	188	345-281	342
330-054	185	330-594	188	345-282	342
330-056	185	330-595	188	345-283	342
330-058	185	330-596	188	345-285	342
330-061	184	330-597	188	345-287	342
330-070	185	330-598	188	345-289	342
330-072	185	330-599	188	345-289R	343, 348
330-074	185	330-600	188	345-290	346
330-302	195, 197	330-601	188	345-291	346
330-303	195, 197	330-602	188	345-292	346
330-304	195, 197	330-603	188	345-293	346
330-305	195, 197	330-604	188	345-294	346
330-306	195, 197	330-605	188	345-300	348
330-308	195, 197	330-606	188	345-302	348
330-310	195, 197	330-607	188	345-305	343, 348
330-312	195, 197	330-608	188	345-310	351
330-314	195, 197	330-609	188	345-311	351
330-320	201	330-630	186	345-312	344
330-322	201	330-631	186	345-314	344

345-315	209	400-256	87	412-681L	382
345-320	353	400-418	328	412-681M	382
345-322	353	400-426	329	412-682	382, 384
345-324	353	400-427	329	412-682L	384
345-326	353	400-427T	329	412-682L	382
345-330	353	400-4271T	329	412-682M	382
345-332	353	404-390	316	412-683	382, 384
345-338	352	404-786	322	412-683I	384
345-345	352	404-787	322	412-683L	382
345-346	352	404-788	322	412-683M	382
345-350	344	404-788U	322	412-684	382, 384
345-352	344	404-3902	316	412-684I	384
345-400	330	404-7871	322	412-684L	382
345-402	330	404-7875	322	412-684M	382
345-405	328	404-7885	322	412-685	382, 384
345-2950	346	412-319	159	412-685F	390
345-2951	346	412-321	159	412-685I	384
345-2952	346	412-455	328	412-685L	382
345-2953	346	412-456	328	412-685M	382
345-2954	346	412-457	328	412-686	382, 384
345-2955	346	412-458	328	412-686H	390
345-2956	346	412-459	328	412-686I	384
345-2957	346	412-460	328	412-686L	382
345-2958	346	412-461	328	412-686M	382
345-2959	346	412-462A	328	412-688	382
350-790	366	412-462B	328	412-688M	382
350-805	365	412-462C	328	412-689	382, 383, 384
350-807	365	412-462D	328	412-690	383
350-824	192	412-519	212	412-691	383
350-825	192	412-527	209	412-692	383
350-826	192	412-555	205	412-694	383
350-827	192	412-556	205	412-696	383
350-828	192	412-557	205	412-700	383
350-829	192	412-558	205	412-701	383
350-835LF	196	412-559	327	412-702	383
350-835LFB	196	412-571	204	412-704	383
350-835RT	196	412-575	204	412-705	382
350-835RTB	196	412-580	208	412-706	383
350-835ST	196	412-583	205	412-715	393
350-835STB	196	412-585	205	412-715A	393
350-844	372	412-667A	222	412-715B	393
350-845	370	412-667B	222	412-715C	393
350-846	370	412-667C	222	412-715D	393
350-849	372	412-667D	222	412-716	393
350-850	373	412-672H	398	412-716A	393
350-851	367	412-672-SET	398	412-717	393
350-8451	368	412-673	398	412-718	393
350-8451S	368	412-674	398	412-719	393
350-8452	368	412-675	398	412-724	396
350-8453T	371	412-676	398	412-727A	393
350-8454	369	412-677I	384	412-727B	393
350-8454T	369	412-677L	382	412-728	393
355-265	361	412-677M	382	412-728B	393
400-226	91	412-678	382	412-729	393
400-227	91	412-678I	384	412-729B	393
400-228	91	412-678L	382	412-736-1	392
400-229	91	412-678M	382	412-736-2	392
400-230	91	412-679	382, 384	412-736-3	392
400-231	91	412-679I	384	412-736-4	392
400-232	91	412-679L	382	412-740	397
400-233	91	412-680	382, 384	412-741	397
400-234	91	412-680I	384	412-766	419
400-235	91	412-680L	382	412-767	419
400-250	87	412-680M	382	412-768	419
400-252	87	412-681	382, 384	412-769	419
400-254	87	412-681I	384	412-770	418

412-771	418	440-370	154	465-309	226
412-772	418	440-372	154	465-311	226
412-773	418	440-374	154	465-313	226
412-774	418	440-376	154	465-320	226
412-775	418	440-378	154	465-321	227
412-776	418	440-380	154	465-322	227
412-777	418	440-382	154	465-323	227
412-800	397	465-210	230	465-325	228
412-805	397	465-210-1	230	465-2310	231
412-810	397	465-210-2	230	467-310	139
412-815	397	465-210-3	230	467-311	139
412-830	392	465-210-4	230	467-315	139
412-839	386	465-220	230	467-317	139
412-840	386	465-220-5	230	467-318	139
412-841	386	465-220-6	230	467-332	320, 364
412-844	386	465-220-7	230	467-370	180
412-845	386	465-220-8	230	467-370S	181
412-846	386	465-225	230	467-371	180
412-847	386	465-225-3	230	467-371S	181
412-848	386	465-225-4	230	467-372	180
412-849	386	465-225-5	230	467-372S	181
412-850	386	465-225-6	230	467-372SL	181
412-851	386	465-225-7	230	467-374	180
412-852	386	465-227	230	467-374S	181
412-853	387	465-231	231	467-376	180
412-854	387	465-231B	231	467-376S	181
412-855	387	465-232	231	467-376SL	181
412-856	387	465-232B	231	467-378	180
412-857	387	465-233	231	467-378S	181
412-858	387	465-233B	231	467-379	180
412-859	387	465-234	231	467-379S	181
412-860	387	465-234B	231	467-379SL	181
412-861	387	465-235	231	467-380	180
412-900	391	465-235B	231	467-380S	181
412-902	391	465-236	231	467-380SL	181
412-904	391	465-236B	231	467-382	180
412-906	391	465-237	231	467-382S	181
412-908	391	465-237B	231	467-382SL	181
412-910	391	465-238	231	467-384	180
412-5563	205	465-238B	231	467-384S	181
412-7081	388	465-239	231	467-384SL	181
412-7082	388	465-239B	231	467-386	180
412-7083	388	465-240	230	467-386S	181
412-7084	388	465-241	230	467-386SL	181
412-7151B	393	465-242	230	467-388	180
430-375	217	465-243	230	467-388S	181
430-376	217	465-244	230	467-388SL	181
430-378	217	465-250	230	467-389	180
430-379	217	465-251	230	467-389S	181
430-380	216	465-252	230	467-390	180
430-382	216	465-253	230	467-390S	181
430-383	216	465-254	230	467-392	180
430-384	216	465-260	231	467-392S	181
430-386	216	465-262	231	467-394	180
438-591	163	465-264	231	467-394S	181
438-592	163	465-266	231	467-396	180
438-630	357	465-268	231	467-396S	181
438-632	357	465-270	231	467-398	180
438-634	357	465-272	231	467-398S	181
440-352	154	465-274	231	467-403	180
440-354	154	465-276	231	467-403S	181
440-356	154	465-278	231	467-404	180
440-358	154	465-299	229	467-404S	181
440-360	154	465-300	229	467-406	180
440-362	154	465-302	229	467-406S	181
440-364	154	465-304	229	467-408	180

467-408S	181	468-165	208	469-044	17
467-410	180	468-300	26	469-046Q	16
467-410HL	181	468-305	26	469-048	14
467-410S	181	468-315	31	469-050	14
467-412	180	468-316	31	469-062	25
467-412S	181	468-317	31	469-063	25
467-415	177	468-318	29	469-063A	25
467-430	176	468-319	29	469-063L	25
467-431	176	468-320	29	469-063M	25
467-432	176	468-330	22	469-063X	25
467-433	176	468-331	22	469-070	18
467-434	176	468-332	22	469-070B	18
467-435	176	468-333	22	469-071	18
467-436	177	468-334	23	469-072	18
467-438	177	468-335	23	469-074	18
467-440	177	468-336	23	469-076	18
467-440XS	177	468-337	23	469-078	18
467-441	240	468-338	23	469-080	25
467-443	243	468-339	23	469-081	25
467-445	243	468-340	21	469-082	25
467-448	243	468-342	21	469-083	25
467-450	326	468-343	21	469-084	25
467-452	326	468-344	21	475-100	245
467-454	326	468-346	27	475-101	245
467-460	327	468-347	27	475-102	245
467-461	327	468-348	27	475-103	245
467-462	327	468-350	26	475-104	245
467-463	328	468-351	26	475-136	245
467-464	328	468-352	26	475-137	245
467-464A	328	468-360	30	475-138	245
467-465	327	468-361	30	475-140	56
467-467	327	468-362	30	475-148	46
467-505	184	468-370	27, 28	475-150	46
467-532	210	468-371	28	475-164	46
467-533	210	468-372	28	475-168	54
467-534T	330	468-373	28	475-168B	54
467-535	204	468-515	317, 363	475-170	54
467-4131	177	468-520	356	475-170B	54
467-4131A	177	468-521	358	475-174	44
467-4132	177	468-522	357	475-175	44
467-4132A	177	468-523	357	475-184	41
467-4133	177	468-529	366	475-185	40
467-4133A	177	468-530	366	475-186	40
467-4134	177	468-531	366	475-187	40
467-4341	176	468-535	366	475-188	40
467-4351	176	468-540	366	475-188B	41
467-5303	330	468-541	366	475-190	44
467-5304	330	468-649	318	475-191	44
467-5305	330	468-650	318	475-194	44
467-5313	330	468-651	318	475-195	44
467-5314	330	468-654	318	475-203	43
467-5315	330	468-660	318	475-204	43
468-010	31, 317	468-664	318	475-207	43
468-011	31, 317	468-670	318	475-208	43
468-012	31, 317	468-674	318	475-220	43
468-090	33, 69	468-3185	29	475-225	43
468-092	33, 69	469-010	15	475-250	42
468-094	33, 69	469-033T	364	475-295	64
468-104	33, 68	469-035	320, 323	475-300	62
468-140	208	469-036	14	475-301	62, 66
468-150	210	469-038	17	475-302	62
468-155	244	469-039	17	475-304	62
468-156	244	469-040	14	475-306	63
468-160	210	469-041	17	475-307	63
468-161	212	469-041Q	16	475-310	67
468-163	208	469-042Q	16	475-320	67

475-325	68	475-745	199	475-882	304
475-330	69	475-746	199	475-884	272
475-340	318	475-747	200	475-884L	272
475-345	318	475-748	200	475-885	271
475-350	319	475-749	200	475-885L	270
475-352	319	475-750	193	475-886	273
475-360	359	475-752	193	475-886L	273
475-503	254	475-753	193	475-895	360
475-505	256	475-754	193	475-899	360
475-505A	256	475-758	200	475-900	360
475-505B	256	475-760	193	475-901	360
475-508	257	475-762	193	475-902	360
475-510	255	475-764	193	475-903	360
475-511	255	475-766	193	475-904	360
475-517	255	475-768	195	475-906	360
475-518	255	475-769	195	475-908	360
475-520	255	475-770	195	475-909	360
475-521	255	475-771	195	475-910	360
475-522	287	475-772	195	475-911	360
475-522C	287	475-773	195	475-912	360
475-523	287	475-775	195	475-913	360
475-523C	287	475-776	195	475-914	360
475-530	253	475-777	195	475-915	360
475-535	253	475-778	195	475-916L	362
475-539	246	475-779	195	475-916M	362
475-540	246	475-780	195	475-916S	362
475-542	246	475-782	195	475-916-SET	362
475-543	247	475-783	195	475-918	361
475-546	247	475-784	195	475-920	281
475-547	247	475-785A	194	475-921	281
475-549	247	475-785B	194	475-922	281
475-550	247	475-785C	194	475-923	282
475-552	247	475-785D	194	475-924	282
475-596	345	475-785E	194	475-925	277
475-598	345	475-785F	194	475-930	278
475-600	345	475-785G	194	475-930L	278
475-605	345	475-785G1	194	475-940	260
475-610	345	475-785G2	194	475-950	331
475-615	345	475-785H	194	475-9071	360
475-618L	343	475-787	197	475-9072	360
475-618R	343	475-789	197	478-360	223
475-622	294	475-790	196	478-370	223
475-623	294	475-791	196	478-375	223
475-624	294	475-792	196	478-380	223
475-625	294	475-794	192	478-382	223
475-627	260	475-796	192	478-395	211
475-628	261	475-798	192	478-400	211
475-630	260	475-800	200	478-402	211
475-631L	261	475-802	200	478-405	211
475-632R	261	475-803	186	478-768	194
475-635	260	475-804	186	478-770	194
475-640L	261	475-805	186	478-772	194
475-640R	261	475-806	186	478-773	194
475-711	198	475-810	201	478-774	194
475-712	198	475-840	164	478-775	194
475-719	193	475-842	167	478-776	194
475-722	193	475-845	167	478-778	194
475-725	193	475-846	166	478-780	194
475-729	199	475-847	166	478-782	194
475-730	199	475-849	166	478-785	194
475-731	198	475-850	168	478-787	197
475-732	198	475-855	223	478-788	197
475-734	193	475-878	275	478-789	197
475-737	193	475-878L	275	478-790	197
475-739	193	475-880	274	478-791	197
475-742	193	475-880L	274	478-792	197

485-422	232	1100-106A	109	1100-544	445
485-476	232	1100-108	109	1100-574	440
485-479	233	1100-108D	108	1100-576	440
485-500-SET	234	1100-110D	108	1100-577	440
485-501	234	1100-112A	106	1100-577S	440
485-502	234	1100-114L	107	1100-578	446
485-503	234	1100-122	103	1100-578A	446
485-510	236	1100-168	158	1100-634	307
485-512	236	1100-212	37	1100-668	296
485-514	236	1100-212L	37	1100-668B	296
485-516	236	1100-214	37	1100-668T	296
485-528	237	1100-214L	37	1100-669	296
485-530	237	1100-216	38	1100-669B	296
485-580	235	1100-224	37	1100-670	294
485-582	235	1100-226	37	1100-670B	294
485-584	235, 237	1100-228	38	1100-735F	119
485-586	235	1100-260	37	1100-740	10
485-588	235	1100-262	37	1100-741	10
485-590	233	1100-264	37	1100-798	206
485-592	233	1100-265	37	1100-798A	206
485-592S	233	1100-268	38	1100-798B	207
485-594	237	1100-270	38	1100-798C	207
485-634	163	1100-276	70	1100-798D	207
485-636	163	1100-282	70	1100-798E	206
485-646	163	1100-328S	15	1100-798F	206
485-648	163	1100-344	79	1100-798G	206
485-675	327	1100-346	79	1100-798H	408
502-271	24	1100-392	96	1100-798S	206
502-272	24	1100-407	131	1100-851	107
502-273	24	1100-409LG	406	1100-853	107
502-274	24	1100-409MG	406	1100-854	107
502-276	24	1100-409PG	406	1100-7411	10
502-277	25	1100-409SG	406	1100-7413	11
502-380	293	1100-411-10	408	1102-BR42	211
502-382	293	1100-411-11	408	1103-152	113
502-384	293	1100-411-12	408	1103-153	113
502-393T	249	1100-411-13	408	1103-154S	113
502-394	249	1100-411-14	408	1103-170	336
502-398T	292	1100-411-15	408	1103-223	347
502-399	306	1100-411-16	408	1103-225	347
502-400	306	1100-411-17	408	1103-225C	349
502-405	306	1100-411-18	408	1103-226	347
502-409	304	1100-411-19	408	1103-228	350
502-410	304	1100-411-20	408	1103-229	348
508-523	392	1100-411-21	408	1103-230	443
508-536	433	1100-411-22	408	1103-232	349
508-538	433	1100-411-23	408	1103-233	348
508-541	433	1100-412-24	408	1103-235	344
508-542	433	1100-412-26	408	1103-236	350
508-543	433	1100-412-28	408	1103-237	350
508-544	433	1100-412-30	408	1103-238	350
508-547	433	1100-412-33	408	1103-241	347
508-636	52	1100-412-36	408	1103-242	347
508-637	52	1100-412-38	408	1103-500	410
508-638	52	1100-412-40	408	1103-500A	410
508-639	52	1100-412-43	408	1103-500B	410
1100-090	95	1100-412-45	408	1103-500C	410
1100-091	95	1100-412-47	408	1103-500D	410
1100-093	95	1100-462S	436	1103-500E	410
1100-094	94	1100-462SH	436	1103-500F	410
1100-096G	94	1100-463S	436	1103-500G	410
1100-098	94	1100-466	402, 403	1103-500H	410
1100-100	95	1100-490	350	1103-500J	410
1100-101	95	1100-490C	349	1103-601	110
1100-105A	108	1100-491	349	1103-604	110
1100-106	109	1100-542	445	1103-620	359

1103-887	89	1200-407	48	1271-152C	326
1103-887C	89	1200-410	57	1271-153	20
1103-888	89	1200-411	57	1271-0154	20, 326
1103-888C	89	1200-420	63	1271-155	326
1105-110	173	1200-445	57	1271-156	22, 326
1105-112	173	1200-490	78	1271-156C	326
1106-070	442	1200-491	78	1271-300	209
1106-075	442	1200-497	75	1271-301	209
1106-076	441	1200-499	78	1271-302	209
1106-077	441	1200-502	81	1271-307	210
1106-078	441	1200-503	81	1271-309	210
1106-079	441	1200-704	78	1271-310	209
1106-080	440	1200-706	78	1404-845A	323
1106-082	440	1200-708	74	1404-845B	323
1106-084	440	1200-712	37	1404-845D	323
1106-086	440	1200-713	37	1404-846A	323
1106-091	440	1200-714	37	1404-846B	323
1106-092	440	1200-715	37	1404-846D	323
1106-190	339	1200-716	38	1404-855	32
1106-400	377	1200-717	38	1404-857	32
1106-401	377	1200-764	82	1404-858	32
1106-402	377	1200-766	82	1463-117	229
1106-403	377	1200-775	79	1463-118	229
1106-404	377	1200-776	79	1463-119	229
1106-0791	441	1200-776S	79	1463-120	229
1197-673	244	1200-800	65	1463-140	337
1197-675	244	1200-805	64	1463-141	337
1200-011	82	1200-806	65	1463-142	337
1200-011C	82	1200-808	64	1463-143	337
1200-020	79	1200-810	64	1463-461	399
1200-021	79	1200-812	66	1463-500	389
1200-022	79	1200-830	44	1463-501	389
1200-023	79	1200-831	44	1463-503	389
1200-025	81	1200-840	57	1463-504	389
1200-026	81	1200-843	58	1463-506	389
1200-028	81	1200-845	58	1463-507	389
1200-062	78	1200-846	58	1467-456	329
1200-064	78	1200-848	43	1467-458	329
1200-070	55	1200-849	43	1467-460	329
1200-072	55	1200-851	42	2100-420	150
1200-076	54, 55	1200-925	44	2100-422	150
1200-076B	54, 55	1200-930	78	2100-425	150
1200-195	48	1200-935	76	2100-427	150
1200-212	37	1200-937	75	2100-430	150
1200-214	37	1200-940	49	2100-432	150
1200-216	38	1200-945	51	2100-435	150
1200-224	37	1200-985	77	2100-437	150
1200-226	37	1200-986	77	2100-455	148
1200-228	38	1271-005	20	2100-456	148
1200-229	37	1271-005A	20	2100-457	148
1200-231	38	1271-006	20	2100-458	148
1200-259	71	1271-007	20	2100-459	148
1200-300	65	1271-008	20	2100-460	148
1200-310	64	1271-009	20	2100-461	148
1200-348	39	1271-010	14	2100-462	148
1200-386	59	1271-011	14	2100-466	149
1200-386B	59	1271-012	14	2100-800	151
1200-387	59	1271-013	14	2100-802	151
1200-387B	59	1271-016	19	2100-804	151
1200-388	59	1271-018	19	2100-806	151
1200-389	59	1271-020	19	2100-810	151
1200-392	43	1271-020R	19	2100-812	151
1200-399	56	1271-021	19	2100-814	151
1200-400	56	1271-021A	19	2100-816	151
1200-401	56	1271-0151	20, 326	2100-835	152
1200-402	49	1271-152	20	2100-836	152

2100-837	152	2300-047	89	2400-044	45
2100-838	152	2300-048	86	2400-045	45
2100-839	152	2300-049	86	2400-047	45
2100-840	152	2300-134M	89	2400-049	45
2100-841	152	2300-135M	89	2400-051	45
2100-842	152	2300-143M	89	2400-053	45
2100-843	152	2300-151M	89	2400-055	45
2100-875	153	2300-258	91	2400-057	45
2200-073B	141	2300-298	103	2400-059	45
2200-073C	141	2300-298S	103	2400-061	45
2200-073D	141	2300-300	103	2400-063	45
2200-074B	141	2300-300S	103	2400-208	71
2200-101	142	2300-301	103	2400-209	71
2200-101A	142	2300-302	103	2400-210	71
2200-102	142	2300-302S	103	2400-210B	71
2200-102A	142	2300-304	103	2400-211	71
2200-103	142	2300-304S	103	2400-211B	71
2200-104	142	2300-306	103	2400-212	71
2200-105	142	2300-306S	103	2400-213	71
2200-105A	142	2300-308	103	2400-214	71
2200-105B	142	2300-308S	103	2400-215	71
2200-107	142	2300-328	107	2400-216	71
2200-107P	142	2300-350	104	2400-217	71
2200-108	142	2300-352	104	2400-218	71
2200-108P	142	2300-354	104	2400-324	39
2200-109	142	2300-356	104	2400-324S	39
2200-110	142	2300-358	104	2400-326	39
2200-110P	142	2300-360	104	2400-327	39
2200-111	142	2300-362	104	2400-360	79
2200-111P	142	2300-364	104	2400-362	79
2200-112	142	2300-366	104	2400-365	77
2200-113	142	2300-368	104	2400-367	77
2200-126	138	2300-370	104	2400-374	53
2200-383	137	2300-372	104	2400-375	53
2200-387	137	2300-374	104	2400-376	53
2200-389	137	2300-378	105	2400-377	53
2200-394	137	2300-384S	105	2400-379	53
2200-396	137	2300-388S	105	2400-381	53
2200-420	162	2300-390S	105	2400-383	53
2200-422	162	2300-394S	105	2400-383S	53
2200-424	162	2300-396S	105	2400-385	53
2200-426	162	2300-481	86	2400-396	50
2200-437	358	2300-0496	90	2400-397	50
2200-700	124	2300-0497	90	2400-428	50
2200-750	124	2300-0498	90	2400-433	51
2200-752	124	2300-499	90	2400-435	50
2200-789	137	2300-516	96	2400-438	51
2200-790	137	2300-518	96	2400-439	51
2200-1112	142	2300-520	96	2400-440	51
2200-1112P	142	2300-521	96	2400-442	51
2200-1132	142	2300-600	113	2400-542	71
2200-1133	142	2300-601	113	2400-544	71
2300-020	87	2300-602	113	2400-545	70
2300-022	87	2300-604	113	2400-547	70
2300-024	87	2300-670	102	2400-626	72
2300-026	87	2300-671	102	2400-627	72
2300-030	87	2300-672	102	2400-629	72
2300-032	87	2300-673	102	2400-631	72
2300-034	87	2300-674	102	2400-633	72
2300-036	87	2300-675	102	2400-710	80
2300-038	87	2300-679	102	2400-711	81
2300-040	87	2400-010	80	2400-712	80
2300-040S	87	2400-012	80	2400-713	81
2300-042	87	2400-015	80	2400-715	81
2300-042S	87	2400-017	80	2400-717	81
2300-046	89	2400-043	45	2400-728	50

2400-729	50
2400-733	51
2400-739	51
2400-753	49
2400-755	49
2400-756	49
2400-757	49
2400-823	39
2400-823S	39
2400-824	39
2400-824S	39
2400-826	39
2400-827	39
2400-827S	39
2400-920	71
2400-922	71
2400-924	71
2400-926	71
2400-928	71
2400-3751	53
2400-6261	72
2400-6271	72
2400-6291	72
2400-6311	72
2400-6331	72
2405-324	39
2405-324S	39
2405-326	39
2405-327	39
2405-824	39
2405-824S	39
2405-826	39
2405-827	39
2600-704M	88
2600-712	88
2600-713	88
2600-714	97
2600-716	97
2600-720	98
2600-722	98
2600-725	96
2600-728	101
2600-730	86
2600-914	70
2600-916	70
2700-309	394
2700-320	222
2700-390	396
2700-392	396
2700-394	396
2700-862NS	144
2700-864NS	144
2700-900	146
2700-902	146
2700-902F	146
2700-903NS	146
2700-905	146
2700-906	146
2700-908NS	146
2700-915	145
2700-920	145
2700-922	145
2700-924NS	145
2700-940	147
2700-978	147
2700-995NS	144
2700-5251	60
2700-5271	60
2700-5331	60
2700-5341	60
2700-5351	60
2700-5371	60
2700-5411	60
2700-5431	60
2700-5451	60
2700-5471	60
2800-0001	312
2800-0002	312
2800-0003	312
2800-0004	313
2800-0005	313
2800-0006	312
2800-0007	312
2800-0008	312
2800-0009	313
2800-0010	313
2901-281-25	149
2901-281-40	149
2901-281-45	149
2901-281-60	149
46933-00	279
46933-02	279
46933-04	279
46933-06	279
46933-08	279
46934-00	280
46934-01	280
46934-02	280
46934-03	280
46934-04	280
46934-05	280
46934-06	280

**A**

Adamson Double-ended Hook and Retractor	245
Adson Bipolar Forceps	146
Adson Dressing Cross-Serrated Forceps	121
Adson Dressing Serrated Forceps	120
Adson Dressing TC Serrated Platform Forceps	120
Adson Forceps	162
Adson Suction	396
Adson Tissue Forceps Titanium	118
Adson Tissue Smooth Platform Forceps	123
Adson Tissue TC Dust Platform Forceps	122
Adson Tissue TC Serrated Platform Forceps	117
Agris-Dingman Breast Dissector	261
Aiach-Gubisch Forceps	168
Air Injection Cannula	410
Alexander Osteotome	195, 197
Algerbrush II Corneal Rust Ring Remover Burr	416
Algerbrush II Pterygium Burr	416
Alligator Forceps	15
Alligator Forceps Tubular Shaft	14
Allport Mastoid Searcher	244
Allport Muscle Hook	244
Anderson Bear Claw Hook Retractor	253

Andrews Pynchon Suction	394
Anthony Suction	394
Antrum Biopsy Forceps	28
Antrum Grasping Forceps	30
Areola Marker	
Chang Quad Areola Marker	361
Arthroscopic Grasping & Biopsy Combo Rongeur Forceps	19
Asch Septum Straightening Forceps	357
Aufricht Nasal Retractor	295, 301
Aufricht Saberback Power Cut Black® Scissors	43

**B**

Baby Poole Suction	396
Baby Stratte Scissors	83
Back Biter Ostrum Antrum Punch Rongeur	26, 31
Back Biter Rotating Punch Rongeur	29
Backhaus Towel Forceps	169, 170
Bacon Duckbill Rongeur	448
Baird Chalazion Clamp Forceps	126
Ballenger Bayonet Swivel Knife	330
Ballenger Swivel Knife	330
Barnes Mini Suction Tube	388
Barraquer Cilia Forceps	130, 143
Barraquer Infant Wire Speculum	426
Barraquer Reverse Needle Holder	89
Barraquer Wire Speculum	422, 424
Barraquer Wire Speculum Third Eye Lid	423
Barr Double Ended Probe	433
Barr Fistula Probe	433
Baumgartner Needle Holder	106
Bayonet Suction Tube	391
Beasley-Babcock Tissue Forceps	122
Beaver Blade Chuck Handle #3K	11
Becker Septum Scissors	67
Beer Distichia Cilia Forceps	131
Bergh Cilia Forceps	131
Beyer Rongeur	321
Biggs Face Lift Retractor	272
Biggs Mammoplasty Retractor	270, 271, 273
Billeau Ear Loop/Curette	177
Biopsy Forceps	27
Bipolar Cord	
Reusable Bipolar Cord	147
Biro Naevus Scissors	47
Bishop-Harmon 1x2 Tissue Forceps	134
Bishop-Harmon 1x2 Tissue Forceps Titanium	134
Bishop-Harmon Irrigation Bulb Cannula Set	409
Bishop-Harmon Serrated Dressing Forceps	143
Black Kaye Scissors	42
Blade Holder	
Blake Blade Holder	11
Blair Hook Retractor	253, 414
Blair Skin Graft Knife	331
Blake Blade Holder	11
Blume Osteotome	200
Bodian Lacrimal Probe Set	430
Boies Nasal Fracture Elevator	209
Bonaccolto Suture Forceps	130
Bone Grinder	361

Bone Grinder	361
Bonney Tissue Forceps	136
Bottle Opener	359
Boucheron Ear Specula Chrome	230
Bowman Lacrimal Probe	428
Boynnton Needle Holder	95
Bracken 1x2 Fixation Forceps	133
Brauer-Cottle Osteotome	193
Brauer Rocking Nasal Chisel	184
Braun Fixed Caliper	337
Braun-Ralph Suction	394
Breast Reduction Marker	362
Breast Retractor	277
Brown-Adson Tissue Forceps	119
Brown Adson Tissue Forceps Titanium	121
Brown-Cushing Bayonet Forceps	139
Brown Forceps	118
Brown Scissors	54
Bruenings Tongue Depressor	232
Buck Ear Curette Hex Handle	181
Buck Ear Round Handle Curette	180
Buck Myringotomy Knife	328
Buie Fistula Probe	433
Buie Suction Tube	392
Burr	
Algerbrush II Corneal Rust Ring Remover Burr	416
Algerbrush II Pterygium Burr	416

**C**

Cakir Osteotome	197
Caliper	
Braun Fixed Caliper	337
Castroviejo Caliper	334, 335
House Ear Caliper	337
Jameson Caliper	336
Orthopedic Vernier Caliper	336
Stahl Caliper	337
Thorpe Caliper	336
Cannula	
Air Injection Cannula	410
Fasanella Lacrimal Cannula	410
Lacrimal Cannula	410
Liposuction Cannula	264, 265, 266, 267
McIntyre Lacrimal Cannula	410
Severin Lacrimal Cannula	410
Shahinian Lacrimal Cannula	410
West Cannula	410
Capener Lamina Cranked Gouge	185
Carrier	
Eyebrow Lifting Ligature Carrier	379
Facia Ligature Carrier	379
Sanders Brown Ligature Carrier	379
Carroll Tendon Pulling Forceps	365
Cartilage Crusher	373
Cottle Cartilage Crusher	372
Gubisch Cartilage Crusher	367
Cartilage Cutting Block	368
Cartilage Cutting BlockTitanium	371
Cassio Ligature Carrier	376
Castroviejo Body Caliper	335
Castroviejo Caliper	334, 335
Castroviejo Lacrimal Dilator	431
Castroviejo Lip Graft Clamp Forceps	129

Castroviejo Needle Holder	87, 90, 93
Castroviejo Suture 1x2 Teeth Forceps	134, 144
Catalano Lacrimal Intubation Set	429
Ceramic Coated Scissors	75
Ceramitec Scissors	78
Ceramitec Stevens Tenotomy Ergonomic Spread Handle Power Cut Black® Scissors	76
Chadwick Scissors	48
Chamberlain-Fries Retractor	304
Chang Quad Areola Marker	361
Chisel	
Brauer Rocking Nasal Chisel	184
Cottle Gubisch Chisel	200
Hibbs Chisel	188
Sontec Chisel	189
Chuck Handle	
Beaver Blade Chuck Handle #3K	11
Cicherelli Rongeur	447
Cilia Forceps	130
Cinelli Guarded Osteotome	193
Circular Cutting Antrum Punch Rongeur	26, 27
Clamp	129
Castroviejo Lip Graft Clamp Forceps	129
Cooley Bulldog Clamp	150
DeBaKey Bulldog Clamp	151
Dietrich Micro Bulldog Clamp	152
Glover-DebaKey Bulldog Clamp	148
John Hopkins Bulldog Clamp	154
Laparoscopic Bulldog Clamp	149
Micro Sontec® Yasargil-Glover Carotid Artery Bulldog Clamp	149
Microvascular Clamp	153
Putterman Clamp Forceps	128
Serrefine Bulldog Clamp	154
Towel Clamp	173
Universal Microvascular Clamp	152
Classic Lempert Rongeur	321, 445
Cleft Palate Elevator	211
Cleveland Rongeur	447
Cobb Type Spinal Gouge	186
Collier Needle Holder	106
Collin Lucae Mallet	436
Converse Combo Sharp/Blunt Skin Hook	246
Converse Hand Retractor	283
Converse Nasal Tip Skin Hook	246
Converse Skin Hook	245
Cook Eye Speculum	427
Cook Guarded Osteotome	197
Cooley and DebaKey Neonatal Cardiovascular Clamp	155
Cooley Bulldog Clamp	150
Cooley Power Cut Gold Scissors	50
Cord	
Disposable Bipolar Cord	147
CORD-1001	147
CORD-2000	147
Corneal Eye Shield	406
Cottle Alar Retractor	254, 306
Cottle Cartilage Crusher	372
Cottle Columella Clamp Forceps	126
Cottle Daniel Raspatory/Packer	210
Cottle-Dorsal Scissors	64, 65
Cottle Double Skin Hook	240

Cottle Elevator	209
Cottle Gubisch Chisel	200
Cottle Mucosa Knife	327
Cottle Neivert Hook Retractor	250
Cottle Septum Speculum	229
Cottle Skin Hook	241
Cottle Skin Hook Titanium	241
Cottle Speculum	228
Cottle Thumb Skin Hook	252
Cottle-Walsham Forceps	356
Coupland Suction Set	398
Craig-Sheehan Retractor	293
Crawford Lacrimal Intubation Set	429
Crile Forceps	161
Crile-Wood Needle Holder	105
Cronin Cleft Palate Elevator / Dissector	211
CSU Cottle Elevator	209
Curette	
Billeau Ear Loop/Curette	177
Buck Ear Curette Hex Handle	181
Buck Ear Round Handle Curette	180
Frontal Sinus Curette	179
House Curette	178, 417
Martini Bone Curette	177
Meyerhoefer-Chalazion Curette	176, 416
Shapleigh Ear Curette	176
Sontec® Excavator Curette	179
Tholl Curette	179
Williger Curette	177
Cushing Bayonet Bipolar Forceps	147
Cushing Bayonet Forceps	140
Cushing Bipolar Forceps	144
Cushing Rongeur	449
Cushing Tying Forceps	137
Cutting Block	
Cartilage Cutting Block	368
Cartilage Cutting BlockTitanium	371
Gruber CartilageTeflon Cutting Block with Grid	368
Cutting Blocks	
Gruber Cutting Block	369
Cuttings Grids	
Sheen Cartilage Cutting Grid	370

**D**

Daniel Endoscopic Forehead Elevator	223
Daniel-Gubisch Raspatory/Rasp	210
Daniel Gubisch Rib Raspatory	217
D'assumpcoa Face Lift Marker	165
Davis Brain Black Silicon Spatula	419
Davis Brain Spatula	418
Davis Mouth Gag Frame	237
Day Ear Hook	243
Deaver Retractor	288, 289
DeBaKey Bulldog Clamp	151
DeBaKey Tissue Forceps	142
Defourmental Rongeur	448
Depressor	
Bruenings Tongue Depressor	232
Doyen Tongue Depressor	233
Schepens Scleral Depressor	412
Scleral Depressor	412
Sewall Tongue Depressor	232
Derf Needle Holder	100

Derf Needle Holder Titanium . . . . .	97
Deschamps Ligature Carrier . . . . .	378
Desmarres Chalazion Clamp Forceps . . . . .	127
Desmarres Lid Retractor . . . . .	302, 413
Desmarres Lid Retractor Autoclavable Plastic . . . . .	303
Desmarres Lid Retractor Titanium . . . . .	303
Desmarres Severin Chalazion Clamp Forceps . . . . .	127
Dietrich Micro Bulldog Clamp . . . . .	152
Dilator . . . . .	293
Castroviejo Lacrimal Dilator . . . . .	431
Infant Lacrimal Dilator . . . . .	431
Muldoon Lacrimal Dilator . . . . .	431
Pigtail Lacrimal Probe Dilator . . . . .	431
Wilder Lacrimal Dilator . . . . .	431
Dingman Mouth Gag Set . . . . .	234
Disposable Bipolar Cord . . . . .	147
Dissector	
Agris-Dingman Breast Dissector . . . . .	261
Cronin Cleft Palate Elevator / Dissector . . . . .	211
Forehead Lifting Elevator / Dissector . . . . .	214
Golf Club Breast Dissector . . . . .	260
"J" Mammary Implant Dissector . . . . .	261
MacCollum-Dingman Breast Dissector . . . . .	260
MacCollum-Dingman Submammary Dissector . . . . .	260
Mammary & Calf Muscle Dissector . . . . .	260
Masing Elevator / Dissector . . . . .	204
McCabe Facial Nerve Dissector . . . . .	358
Rosen Circular Blade Dissector . . . . .	328
Solz Breast Hook Dissector . . . . .	261
Sontec-Masing Septal Dissector . . . . .	204
Double Action Micro Scissors . . . . .	70
Double-Action SS Needle Holder . . . . .	89
Doyen Raspatory . . . . .	216
Doyen Tongue Depressor . . . . .	233
<b>E</b>	
Electro Blue Coated Cushing Bayonet Tissue Forceps . . . . .	140
Electro Blue Coated Potts-Smith Tissue Forceps . . . . .	141
Electro Blue Coated Skinner Tissue Forceps . . . . .	141
Elevator	
Boies Nasal Fracture Elevator . . . . .	209
Cleft Palate Elevator . . . . .	211
Cottle Elevator . . . . .	209
Cronin Cleft Palate Elevator / Dissector . . . . .	211
CSU Cottle Elevator . . . . .	209
Daniel Endoscopic Forehead Elevator . . . . .	223
Elevator With Suction . . . . .	222
Forehead Lifting Elevator / Dissector . . . . .	214
Freer Elevator / Mucosa Knife Round Handle 4.5 mm . . . . .	208
Freer Elevator / Packer . . . . .	208
Freer Periosteal Elevator . . . . .	206, 207, 408
Frontal Ostium Sound Elevator . . . . .	212
Gubisch Suction Elevator . . . . .	223
House Ear Elevator . . . . .	208
Joseph Masing Elevator . . . . .	208
Joseph Periosteal Elevator . . . . .	204
Killian Elevator . . . . .	204
Lempert Raspatory Elevator . . . . .	212
Masing Elevator / Dissector . . . . .	204
Maxillary Ostium Elevator / Probe . . . . .	210
McDonald Elevator . . . . .	205
McKenty Elevator . . . . .	205
Ostium Burnisher Elevator . . . . .	211
Pennington Elevator . . . . .	208
Roger Elevator . . . . .	205
Sesamoid Cottle Elevator . . . . .	209
Sontec® Septum Elevator / Probe . . . . .	210
Sontec A O Type Elevator / Raspatory . . . . .	218, 219
Sontec Cottle Elevator . . . . .	209
Sontec S.P.T. Elevator . . . . .	205
Woodson Elevator . . . . .	204
Elevator With Suction . . . . .	222
Endoscopic Forehead Lifter . . . . .	213
Endoscopic Guidance Face Lift Retractor . . . . .	284
Entner Ligature Carrier . . . . .	378
Enucleation Scissors . . . . .	83
Epker Type Osteotome . . . . .	201
Ergonomic-Handle Bonn Suture Forceps . . . . .	135
Ergonomic-Handle Castroviejo Suture Forceps . . . . .	135
Erhardt Lid Clamp Forceps . . . . .	125
Eyebow Lifting Ligature Carrier . . . . .	379
Eye Ribbone Retractor . . . . .	414
<b>F</b>	
Facia Ligature Carrier . . . . .	379
Fanous Gubisch Nasal Osteotome . . . . .	197
Fanous Saberback Scissors . . . . .	59
Farrior Ear Specula . . . . .	231
Fasanella Lacrimal Cannula . . . . .	410
Ferreira Breast Augmentation Retractor . . . . .	276, 278
Ferreira Face Lift Retractor . . . . .	274
Finger Goniometer . . . . .	335
Finger Ring Retractor Hook . . . . .	251
Finger Ring Skin Hook . . . . .	252
Fisher Tonsil Knife . . . . .	327
Flexible Neck Hook Retractor . . . . .	253, 414
Flieringa Scleral Fixation Ring . . . . .	412
Foman-Dorsal Scissors . . . . .	65, 66
Foman Rasp . . . . .	346
Foman "R" Rasp . . . . .	347
Foman TC Insert Rasp . . . . .	342
Fomon Saberback Scissors . . . . .	56
Forcep	
Side Biting Alligator . . . . .	15
Forceps	
Adson Bipolar Forceps . . . . .	146
Adson Dressing Cross-Serrated Forceps . . . . .	121
Adson Dressing Serrated Forceps . . . . .	120
Adson Dressing TC Serrated Platform Forceps . . . . .	120
Adson Forceps . . . . .	162
Adson Tissue Forceps Titanium . . . . .	118
Adson Tissue Smooth Platform Forceps . . . . .	123
Adson Tissue TC Serrated Platform Forceps . . . . .	117
Aiach-Gubisch Forceps . . . . .	168

Alligator Forceps . . . . .	15
Alligator Forceps Tubular Shaft . . . . .	14
Antrum Biopsy Forceps . . . . .	28
Antrum Grasping Forceps . . . . .	30
Arthroscopic Grasping & Biopsy Combo Rongeur Forceps . . . . .	19
Asch Septum Straightening Forceps . . . . .	357
Backhaus Towel Forceps . . . . .	169, 170
Baird Chalazion Clamp Forceps . . . . .	126
Barraquer Cilia Forceps . . . . .	130, 143
Beasley-Babcock Tissue Forceps . . . . .	122
Beer Distichia Cilia Forceps . . . . .	131
Bergh Cilia Forceps . . . . .	131
Biopsy Forceps . . . . .	27
Bishop-Harmon 1x2 Tissue Forceps . . . . .	134
Bishop-Harmon 1x2 Tissue Forceps Titanium . . . . .	134
Bishop-Harmon Serrated Dressing Forceps . . . . .	143
Bonaccolto Suture Forceps . . . . .	130
Bonney Tissue Forceps . . . . .	136
Bracken 1x2 Fixation Forceps . . . . .	133
Brown-Adson Tissue Forceps . . . . .	119
Brown Adson Tissue Forceps Titanium . . . . .	121
Brown-Cushing Bayonet Forceps . . . . .	139
Brown Forceps . . . . .	118
Carroll Tendon Pulling Forceps . . . . .	365
Castroviejo Lip Graft Clamp Forceps . . . . .	129
Castroviejo Suture 1x2 Teeth Forceps . . . . .	134, 144
Cilia Forceps . . . . .	130
Cottle Columella Clamp Forceps . . . . .	126
Cottle-Walsham Forceps . . . . .	356
Crile Forceps . . . . .	161
Cushing Bayonet Bipolar Forceps . . . . .	147
Cushing Bayonet Forceps . . . . .	140
Cushing Bipolar Forceps . . . . .	144
Cushing Tying Forceps . . . . .	137
DeBaKey Tissue Forceps . . . . .	142
Desmarres Chalazion Clamp Forceps . . . . .	127
Desmarres Severin Chalazion Clamp Forceps . . . . .	127
Electro Blue Coated Cushing Bayonet Tissue Forceps . . . . .	140
Electro Blue Coated Potts-Smith Tissue Forceps . . . . .	141
Electro Blue Coated Skinner Tissue Forceps . . . . .	141
Ergonomic-Handle Bonn Suture Forceps . . . . .	135
Ergonomic-Handle Castroviejo Suture Forceps . . . . .	135
Erhardt Lid Clamp Forceps . . . . .	125
Fraenkel Laryngeal Forceps . . . . .	25
Francis Chalazion Clamp Forceps . . . . .	129
Frontal Sinus Giraffe Forceps . . . . .	22, 23
Gillies Forceps . . . . .	124
Girard 1x2 Fixation Forceps . . . . .	133
Girard Corneoscleral Forceps . . . . .	134
Gorney-Adson Forceps . . . . .	121
Gradle Cilia Forceps . . . . .	130
Graefe Fixation Forceps . . . . .	125
Green Fixation Forceps . . . . .	125
Gruenwald (Jansen) Ear Forceps . . . . .	139
Halstead Mosquito Forceps . . . . .	

156, 157	
Hartman Micro Tip Mosquito Forceps . . . . .	159
Hartman Mosquito Forceps . . . . .	157
Heath Chalazion Clamp Forceps . . . . .	126
Hunt Chalazion Clamp Forceps . . . . .	126
Iris 1x2 Tissue Forceps . . . . .	143
Iris Dressing Forceps . . . . .	123
Jewelers Bipolar Forceps . . . . .	145
Jewelers Classic Forceps . . . . .	116
Jones Towel Clamp Forceps . . . . .	129
Jurasz Laryngeal Forceps . . . . .	24
Kelly Forceps . . . . .	158
Kelman & Hoffer Suture Tissue Forceps . . . . .	135
Kelman-McPherson 1x2 Tissue Forceps . . . . .	132
Knapp Trachoma Forceps . . . . .	131
Lahey Vulsellum Forceps . . . . .	164
Lambert Chalazion Clamp Forceps . . . . .	126
Lester Fixation 1x2 Tissue Forceps . . . . .	133
Lordan Chalazion Clamp Forceps . . . . .	129
Lorna-Edna Towel Forceps . . . . .	171
Lucae Ear Forceps . . . . .	139
Manhattan 1x2 Tissue Forceps . . . . .	132
Manhattan Severin 1x2 Tissue Forceps . . . . .	132
McIndoe Dressing and Tissue Forceps . . . . .	124
McPherson Bipolar Forceps . . . . .	145
Micro Aneurysm Clamp Applier Forceps . . . . .	153
Micro Biopsy Forceps with Flexible Tubular Shaft . . . . .	20
Micro House Alligator Forceps . . . . .	16
Micro House Biopsy Alligator Forceps . . . . .	18
Micro Sontec Alligator Forceps . . . . .	17
Midface Dissecting Forceps . . . . .	357
Nasal Cartilage Punch Forceps . . . . .	363
Pierse Corneal 1x2 Forceps . . . . .	135
Pitanguy Abdomen Marking Forceps . . . . .	164
Pitanguy Abdominal Marking Forceps . . . . .	166
Pitanguy Flap Grasping Forceps . . . . .	168
Pitanguy Marking Forceps . . . . .	166
Pitanguy Rhytidoplasty Marking Forceps . . . . .	167
Potts-Smith Dressing Forceps . . . . .	137
Potts-Smith Tissue Forceps . . . . .	138
Putterman Clamp Forceps . . . . .	128
Reul Coronary Artery Forceps . . . . .	138
Rochester-Ochsner Forceps . . . . .	160
Roeder Towel Forceps . . . . .	172
Rubin Septal Morselizer Forceps . . . . .	359
Schnidt Hemostatic Forceps . . . . .	163
Sheen Fragment Retriever Forceps . . . . .	320, 323
Side Biting Alligator Forceps . . . . .	15
Skinner Tissue Forceps . . . . .	138
Snellen Entropium Clamp Forceps . . . . .	129
Sontec Eye Lid Forceps . . . . .	127
Sontec Micro Alligator Forceps . . . . .	14
Sontec Micro Biopsy Forceps . . . . .	25
Sontec Septal Platform Forceps . . . . .	320, 364
Sontec Septal Platform Forceps Titanium . . . . .	364
Stern-Castroviejo Suture 1x2 Tissue Forceps . . . . .	132
Stille-Adson Dressing Forceps . . . . .	118
Strabismus Forceps . . . . .	133

Swiss Cilia Forceps . . . . .	131
Tchalekian Mammary Marker Forceps . . . . .	167
Tessier Bone Morselizing Forceps . . . . .	358
Tissue Bipolar Forceps . . . . .	144
Tohoku Towel Forceps . . . . .	171
Troutman-Colibri Suture Forceps . . . . .	135
Ziegler Cilia Forceps . . . . .	131
Forehead Lifting Elevator / Dissector . . . . .	214
Foster-Gillies Needle Holder . . . . .	111
Fraenkel Laryngeal Forceps . . . . .	25
Frame	
Davis Mouth Gag Frame . . . . .	237
Francis Chalazion Clamp Forceps . . . . .	129
Frazier Angled Suction . . . . .	382
Frazier Insulated Suction . . . . .	384
Frazier Skin Hook . . . . .	240, 245
Frazier Straight Suction . . . . .	383
Freeman Areola Marker . . . . .	360
Freeman Flap Retractor . . . . .	287
Freeman Hook Retractor . . . . .	256
Freeman-Kaye Ceramitec Ergonomic Spread Handle Saberback Scissors . . . . .	41
Freeman-Kaye Ergonomic Spread Handle Saberback Scissors . . . . .	40, 41
Freeman Skin Hook . . . . .	247
Freer Double Skin Hook . . . . .	241
Freer Elevator / Mucosa Knife Round Handle 4.5 mm . . . . .	208
Freer Elevator / Packer . . . . .	208
Freer Mucosa Knife . . . . .	328
Freer Periosteal Elevator . . . . .	206, 207, 408
Frontal Ostium Nasal Rongeur . . . . .	31, 317
Frontal Ostium Sound Elevator . . . . .	212
Frontal Sinus Curette . . . . .	179
Frontal Sinus Giraffe Forceps . . . . .	22, 23
Frontal Sinus Giraffe Punch . . . . .	21
Fukushima Suction . . . . .	385
<b>G</b>	
Gag	
Jennings Mouth Gag . . . . .	236
G Aufricht Nasal Retractor . . . . .	300
Gauge	
Stahl A/C Lens Gauge . . . . .	337
Gillies Forceps . . . . .	124
Gillies Needle Holder . . . . .	112
Gillies Skin Hook . . . . .	240
Gillies Skin Hook Titanium . . . . .	240
Gil-Vernet Desmarres Retractor . . . . .	303, 413
Girard 1x2 Fixation Forceps . . . . .	133
Girard Corneoscleral Forceps . . . . .	134
Giunta Tungsten Carbide Serrated Scissors . . . . .	46
Glasser Micro Needle Holder . . . . .	90
Glover-DebaKey Bulldog Clamp . . . . .	148
Golf Club Breast Dissector . . . . .	260
Goniometer	
Finger Goniometer . . . . .	335
Gorney-Adson Forceps . . . . .	121
Gorney Elevator With Suction . . . . .	223
Gorney-Kahn Scissors . . . . .	43
Gorney Septal Scissors . . . . .	67
Gorney Turbinate Scissors . . . . .	63
Gouge	
Capener Lamina Cranked Gouge . . . . .	185
Cobb Type Spinal Gouge . . . . .	186

Hibbs Gouge . . . . .	188
Killian-Claus Septum Gouge . . . . .	184
Lexer Gouge . . . . .	187
Mini Lexer Gouge . . . . .	187
Parkes Gouge . . . . .	184
Sontec Micro Gouge . . . . .	186
Walter Meniscus Gouge . . . . .	185
Gradle Cilia Forceps . . . . .	130
Graefe Fixation Forceps . . . . .	125
Graft Passer Ligature Carrier . . . . .	377
Grasper	
Ramirez Type Endoscopic Plastic Forehead Corrugator Grasper . . . . .	313
Green Fixation Forceps . . . . .	125
Gregory Needle Holder . . . . .	86
Grooved Director Tongue Tie . . . . .	432
Gross Ear Hook & Spoon . . . . .	243
Grossman Areola Marker . . . . .	360
Gruber Cartilage/Teflon Cutting Block with Grid . . . . .	368
Gruber Cutting Block . . . . .	369
Gruber Ear Specula . . . . .	230
Gruber Skin Hook . . . . .	290, 291
Gruenwald (Jansen) Ear Forceps . . . . .	139
Gubisch Cartilage Crusher . . . . .	367
Gubisch Suction Elevator . . . . .	223
Gubish Surgical Pen Holder Set . . . . .	11
Guthrie Hook Titanium . . . . .	243
Guthrie Skin Hook . . . . .	242
<b>H</b>	
Hajak-Kofler Bone Punch Rongeur . . . . .	316
Hakansson Rongeur . . . . .	443
Halsey Needle Holder . . . . .	97
Halsey Needle Holder Titanium . . . . .	98
Halstead Mosquito Forceps . . . . .	156, 157
Handle	
Sontec Knife Handle #3XXL . . . . .	11
Staley Round Knurled Knife Handle . . . . .	11
Suction Cup Handle for Eye Shields . . . . .	407
Universal Adjustable Angle Knife Handle #3 . . . . .	10
Wide Barrel Grip Knife Handle #3 . . . . .	10
Haraldsson Elevator with Suction . . . . .	223
Hartman Ear Hook . . . . .	240
Hartman Micro Tip Mosquito Forceps . . . . .	159
Hartman Mosquito Forceps . . . . .	157
Hartmann Ear Specula . . . . .	230
Hartman Rongeur . . . . .	449
Heartline Ross Sump Sucker . . . . .	396
Heath Chalazion Clamp Forceps . . . . .	126
Helveston Tissue Retractor . . . . .	415
Heymann Nasal Scissors . . . . .	62, 66
Hibbs Chisel . . . . .	188
Hibbs Gouge . . . . .	188
Holding Device	
Pashley Pipe Suction Tube Holding Device . . . . .	399
Hook	
Adamson Double-ended Hook and Retractor . . . . .	245
Allport Mastoid Searcher . . . . .	244
Allport Muscle Hook . . . . .	244
Converse Combo Sharp/Blunt Skin Hook . . . . .	246
Converse Nasal Tip Skin Hook . . . . .	246

Converse Skin Hook . . . . . 245  
 Cottle Double Skin Hook . . . . . 240  
 Cottle Skin Hook . . . . . 241  
 Cottle Skin Hook Titanium . . . . . 241  
 Cottle Thumb Skin Hook . . . . . 252  
 Day Ear Hook . . . . . 243  
 Finger Ring Retractor Hook . . . . . 251  
 Finger Ring Skin Hook . . . . . 252  
 Frazier Skin Hook . . . . .  
     240, 245  
 Freeman Skin Hook . . . . . 247  
 Freer Double Skin Hook . . . . . 241  
 Gillies Skin Hook . . . . . 240  
 Gillies Skin Hook Titanium . . . . . 240  
 Gross Ear Hook & Spoon . . . . . 243  
 Gruber Skin Hook . . . . .  
     290, 291  
 Guthrie Hook Titanium . . . . . 243  
 Guthrie Skin Hook . . . . . 242  
 Hartman Ear Hook . . . . . 240  
 Humby Variable Skin Hook . . . . . 247  
 Jackson Tracheal Hook . . . . . 249  
 Joseph Blunt Ball Tips Skin Hook . . . . . 248  
 Joseph Blunt Ball Tips Skin Hook Electro  
     Blue . . . . . 249  
 Joseph Skin Hook . . . . .  
     246, 248  
 Joseph Skin Hook Electro Blue . . . . . 249  
 Kilner Deluxe Skin Hook . . . . . 247  
 Kilner Skin Retractor Hook . . . . . 251  
 Kleinert-Kutz Skin Hook . . . . . 245  
 Mammoplasty & Mastectomy Hook . . . . . 247  
 Mandible Bone Hook . . . . . 251  
 Meyerding Skin Hook . . . . . 246  
 Millard Thumb Retractor Hook . . . . . 252  
 Modified Humby Skin Hook . . . . . 247  
 O' Connor Skin Hook . . . . . 242  
 O' Connor Skin Hook Titanium . . . . . 242  
 Pashley Hook . . . . . 244  
 Seltzer Dermal Biopsy Hook . . . . . 243  
 Sontec® Skin Hook . . . . . 242  
 Sontec® Skin Hook Titanium . . . . . 242  
 Sontec Bone Hook . . . . . 251  
 Sontec Freer Double Skin Titanium . . . . . 242  
 Sontec Freer Skin Hook Titanium . . . . . 241  
 Sontec Tissue Twist Hook . . . . . 240  
 Sontec Tracheal Hook Titanium . . . . . 249  
 Thumb Ring Skin Hook . . . . . 252  
 Tyrell Skin Hook . . . . . 240  
 Hook Retractor . . . . . 255  
 House-Baron Suction . . . . . 393  
 House Curette . . . . . 178, 417  
 House Ear Caliper . . . . . 337  
 House Ear Elevator . . . . . 208  
 House Irrigator/Suction . . . . . 393  
 Howard Bone Rasp Double-Ended Single-  
     Side . . . . . 347  
 Humby Variable Skin Hook . . . . . 247  
 Hunt Chalazion Clamp Forceps . . . . . 126  
 Hyde Corneal Forceps . . . . . 134

**I**

Infant Lacrimal Dilator . . . . . 431  
 Iris 1x2 Tissue Forceps . . . . . 143  
 Iris Classic Tungsten Carbide Power Cut  
     Gold Power Cut Black TC/PC  
     Scissors . . . . . 80

Iris Dressing Forceps . . . . . 123  
 Iris Stille Classic Large Cut Out Rings  
     Scissors . . . . . 82  
 Iris Stille Classic Large Rings Scissors . . . . . 82  
 Irrigator  
     House Irrigator/Suction . . . . . 393

**J**

Jabaley Scissors . . . . . 49  
 Jackson Lacrimal Intubation Set . . . . . 429  
 Jackson Tracheal Hook . . . . . 249  
 Jackson Tracheal Retractor . . . . . 306  
 Jackson Tracheal Retractor Titanium . . . . . 292  
 Jacobson Knife . . . . . 328  
 Jacobson Micro Bayonet Needle Holder . . . . . 91  
 Jacobson Micro Scissors . . . . . 72  
 Jacobson Super Middle Weight Needle  
     Holder . . . . . 89  
 Jacobson Super Middle Weight Needle  
     Holder Titanium . . . . . 88  
 Jaeger Lid Plate . . . . . 411  
 Jameson Caliper . . . . . 336  
 Jansen-Middleton Septum Cut Through  
     Rongeur Punch . . . . . 319  
 Jansen-Middleton Septum Rongeur . . . . . 318  
 Jefferson Retractor . . . . . 309  
 Jennings Mouth Gag . . . . . 236  
 Jeurs Lempert Neuro Rongeur . . . . . 446  
 Jewelers Bipolar Forceps . . . . . 145  
 Jewelers Classic Forceps . . . . . 116  
 Jig  
     Sontec Alar Stabilizing Jig . . . . . 247  
 "J" Mammary Implant Dissector . . . . . 261  
 John Hopkins Bulldog Clamp . . . . . 154  
 Jones Towel Clamp Forceps . . . . . 129  
 Joseph Bayonet Bone Saw . . . . . 402  
 Joseph Blunt Ball Tips Skin Hook . . . . . 248  
 Joseph Blunt Ball Tips Skin Hook Electro  
     Blue . . . . . 249  
 Joseph Bone Saw . . . . . 402  
 Joseph Massing Elevator . . . . . 208  
 Joseph Nasal Knife . . . . . 330  
 Joseph-Peck Saberback Classic Power Cut  
     Gold Power Cut Black TC/PC Power  
     Cut Scissors . . . . . 51  
 Joseph Periosteal Elevator . . . . . 204  
 Joseph Sharp Sharp Classic Power Cut Gold  
     Power Cut Black Scissors . . . . . 50  
 Joseph Skin Hook . . . . . 246, 248  
 Joseph Skin Hook Electro Blue . . . . . 249  
 Joseph Skin Hook Titanium . . . . . 246  
 Joseph Tendon Knife . . . . . 330  
 Jurasz Laryngeal Forceps . . . . . 24

**K**

Kahn Face-Lift Scissors . . . . . 44  
 Kahn-Fomon Scissors . . . . . 43  
 Kasdan Hand Retractor . . . . . 283  
 Kawamoto Double-Ended Retractor . . . . . 302  
 Kaye Blepharoplasty Scissors . . . . . 54, 55  
 Kelly Forceps . . . . . 158  
 Kelly Power Cut Gold Power Cut Black  
     Fistula Scissors . . . . . 52  
 Kelman & Hoffer Suture Tissue Forceps . . . . . 135

Kelman-McPherson 1x2 Tissue Forceps . . . . . 132  
 Kerrison Punch (Occular-plasti) 40° Rongeur  
     . . . . . 421  
 Kerrison Punch (Occular-plasti) 90° Rongeur  
     . . . . . 420  
 Killian-Claus Septum Gouge . . . . . 184  
 Killian Elevator . . . . . 204  
 Killian Nasal Speculum . . . . . 227, 228  
 Killian Septum Speculum . . . . . 226  
 Killian (Von Eicken) Suction . . . . . 397  
 Kilner Deluxe Skin Hook . . . . . 247  
 Kilner Skin Retractor Hook . . . . . 251  
 Kistler Ear Cartilage Rasp . . . . . 343  
 Kleinert-Kutz Rongeur . . . . . 441  
 Kleinert-Kutz Skin Hook . . . . . 245  
 Knapp Rollet Hook Retractor . . . . . 253, 414  
 Knapp Trachoma Forceps . . . . . 131  
 Knife  
     Ballenger Bayonet Swivel Knife . . . . . 330  
     Ballenger Swivel Knife . . . . . 330  
     Blair Skin Graft Knife . . . . . 331  
     Buck Myringotomy Knife . . . . . 328  
     Cottle Mucosa Knife . . . . . 327  
     Fisher Tonsil Knife . . . . . 327  
     Freer Elevator / Mucosa Knife Round  
         Handle 4.5 mm . . . . . 208  
     Jacobson Knife . . . . . 328  
     Joseph Nasal Knife . . . . . 330  
     Pashley Knife Set . . . . . 329  
     Plester First Incision Knife . . . . . 328  
     Poltzer Ear Knife . . . . . 327  
     Sexton-Gerzog Ear Knife . . . . . 326  
     Tendon Knife . . . . . 326  
     Yasargil Arachnoid Knife . . . . . 329  
     Yasargil Bayonet Arachnoid Knife Titanium  
         . . . . . 329  
 Knife Handle  
     Knife Handle #3 . . . . . 10  
     Siegel Knife Handle . . . . . 11  
 Knife Handle #3 . . . . . 10  
 Knight Nasal Scissors . . . . . 62  
 Knives  
     Sickle Knife . . . . . 327  
 Kratz Aspirating Wire Speculum . . . . . 424  
 Kratz-Barraquer Wire Speculum . . . . . 425

**L**

Lacrimal Cannula . . . . . 410  
 Lahey Vulsellum Forceps . . . . . 164  
 Lambert Chalazion Clamp Forceps . . . . . 126  
 Langenbeck Metacarpal Saw . . . . . 403  
 Langenbeck Retractor . . . . . 286  
 Laparoscopic Bulldog Clamp . . . . . 149  
 LaRoe Tissue Spreader Retractor . . . . . 294  
 Larry Fistula Probe . . . . . 433  
 Lead Hand Stabilizing Restrainer . . . . . 299  
 Lempert Raspatory Elevator . . . . . 212  
 Lester Fixation 1x2 Tissue Forceps . . . . . 133  
 Levesque Neuro Rongeur . . . . . 446  
 Lexer Gouge . . . . . 187  
 Lifter  
     Endoscopic Forehead Lifter . . . . . 213  
     Sontec Forehead Lifter . . . . . 212  
 Ligature Carrier  
     Cassio Ligature Carrier . . . . . 376  
     Deschamps Ligature Carrier . . . . . 378

Entner Ligature Carrier . . . . . 378  
 Graft Passer Ligature Carrier . . . . . 377  
 Reverdin Needle/Ligature Carrier . . . . . 376  
 Schmieden-Dick Ligature Carrier . . . . . 378  
 Sontec Reverdin Blunt Needle/Ligature  
     Carrier . . . . . 376  
     Tendon Passer Ligature Carrier . . . . . 377  
 Linderman Amputation Saw . . . . . 403  
 Liposuction Cannula . . . . . 264, 265, 266, 267  
 Littler Suture Carrying Scissors . . . . . 46  
 Lockhart Mummying Fistula Probe . . . . . 432  
 Loop  
     Billeau Ear Loop/Curette . . . . . 177  
 Lordan Chalazion Clamp Forceps . . . . . 129  
 Lorna-Edna Towel Forceps . . . . . 171  
 Lower Lateral Cartilage Morselizer . . . . . 317, 363  
 Lucae Ear Forceps . . . . . 139  
 Luer S-Shaped Retractor . . . . . 306  
 Lukens Thymus Retractor . . . . . 304

**M**

MacCollum-Dingman Breast Dissector . . . . . 260  
 MacCollum-Dingman Submammary  
     Dissector . . . . . 260  
 Maltz Improved Double Ended Rasp . . . . . 344  
 Maliniac Nasal Retractor . . . . . 275  
 Malleable Ribbon Retractor . . . . . 298  
 Mallet  
     Collin Lucae Mallet . . . . . 436  
     Sontec Combo Nylon Mallet . . . . . 436  
     Sontec Double Nylon Mallet . . . . . 437  
     Sontec Micro Mallet . . . . . 437  
 Maltz Single-Ended Rasp . . . . . 351  
 Mammoplasty & Mastectomy Hook . . . . . 247  
 Mammary & Calf Muscle Dissector . . . . . 260  
 Mandible Bone Hook . . . . . 251  
 Manhattan 1x2 Tissue Forceps . . . . . 132  
 Manhattan Severin 1x2 Tissue Forceps . . . . . 132  
 Marker  
     Breast Reduction Marker . . . . . 362  
     D'assumpcoa Face Lift Marker . . . . . 165  
     Grossman Areola Marker . . . . . 360  
     Marten Face Lift Marker . . . . . 165  
     Sontec Areola Marker . . . . . 360  
 Marten Face Lift Marker . . . . . 165  
 Martini Bone Curette . . . . . 177  
 Masing Elevator / Dissector . . . . . 204  
 Masing Rasp . . . . . 352  
 Mathieu Heavy Needle Holder . . . . . 94  
 Mathieu Needle Holder . . . . . 95  
 Maxillary Ostium Elevator / Probe . . . . . 210  
 Mayo-Carroll Scissors . . . . . 70  
 Mayo-Harrington Scissors . . . . . 71  
 Mayo-Hegar Needle Holder . . . . . 107  
 Mayo-Sontec Retractor . . . . . 307  
 McCabe Facial Nerve Dissector . . . . . 358  
 McCollough Twist Fomon Raspatory . . . . . 344  
 McDonald Elevator . . . . . 205  
 McGannon Retractor . . . . . 302  
 Mcllwraith Arthroscopic Scissors Rongeur . . . . . 32  
 Mcllwraith Basket Cutter Rongeur . . . . . 32  
 Mcllwraith Cup Rongeur . . . . . 323  
 McIndoe Dressing and Tissue Forceps . . . . . 124  
 McIntyre Lacrimal Cannula . . . . . 410  
 Mclvor Mouth Gag Set . . . . . 235

McKee Eye Speculum . . . . . 426  
 McKenty Elevator . . . . . 205  
 McNeill-Goldman Scleral Fixation Ring &  
     Blepharostat . . . . . 412  
 McPherson Bipolar Forceps . . . . . 145  
 McPherson Needle Holder . . . . . 92  
 Meyerding Finger Retractor . . . . . 305  
 Meyerding Skin Hook . . . . . 246  
 Meyerhoefer-Chalazion Curette . . . . . 176, 416  
 Micro Aneurysm Clamp Applier Forceps . . . . . 153  
 Micro Antrum Punch Rongeur . . . . . 28  
 Micro Biopsy Forceps with Flexible Tubular  
     Shaft . . . . . 20  
 Micro Friedman Ring Handle Rongeur . . . . . 441  
 Micro Friedman Rongeur . . . . . 442  
 Micro House Alligator Forceps . . . . . 16  
 Micro House Biopsy Alligator Forceps . . . . . 18  
 Micro Plastic Surgery Osteotome . . . . . 194  
 Micro Sontec® Yasargil-Glover Carotid Artery  
     Bulldog Clamp . . . . . 149  
 Micro Sontec Alligator Forceps . . . . . 17  
 Microvascular Clamp . . . . . 153  
 Microvascular Needle Holder . . . . . 104  
 Midface Dissecting Forceps . . . . . 357  
 Millard Thumb Retractor Hook . . . . . 252  
 Miller Bone Rasp Double-Ended Single-  
     Sided . . . . . 348  
 Miller Bone Rasp Double-Ended Single-  
     Sided Serrated . . . . . 348  
 Miller Cross Serrated Rasp . . . . . 349  
 Miller Parallel Serrated Rasp . . . . . 350  
 Miller Rasp . . . . . 343, 348  
 Miller Skin Rake Retractor . . . . . 254, 415  
 Mini Arthroscopic Small Joints Rongeur Set.  
     20 . . . . .  
 Mini Friedman Rongeur . . . . . 442  
 Mini Lexer Gouge . . . . . 187  
 Mini Neuro Premier Rongeur . . . . . 440  
 Mini Neuro Rongeur . . . . . 440  
 Mini Rake Retractor . . . . . 254  
 Modified Cottle Speculum . . . . . 228  
 Modified Ferguson-Frazier Suction . . . . . 390  
 Modified Humby Skin Hook . . . . . 247  
 Morselizer  
     Lower Lateral Cartilage Morselizer . . . . .  
         317, 363  
 Muldoon Lacrimal Dilator . . . . . 431  
 Murdoch Eye Speculum . . . . . 427

**N**

Nail Rasp . . . . . 351  
 Nasal Cartilage Punch Forceps . . . . . 363  
 Nasal Scissors . . . . . 33, 68, 69  
 Needle  
     Reverdin Needle/Ligature Carrier . . . . . 376  
     Sontec Reverdin Blunt Needle/Ligature  
         Carrier . . . . . 376  
     Wright Fascia Needle . . . . . 356  
 Needle Holder  
     Barraquer Reverse Needle Holder . . . . . 89  
     Baumgartner Needle Holder . . . . . 106  
     Boynton Needle Holder . . . . . 95  
     Castroviejo Needle Holder . . . . . 87,  
         93  
     Collier Needle Holder . . . . . 106  
     Crile-Wood Needle Holder . . . . . 105

Derf Needle Holder . . . . . 100  
 Derf Needle Holder Titanium . . . . . 97  
 Double-Action SS Needle Holder . . . . . 89  
 Foster-Gillies Needle Holder . . . . . 111  
 Gillies Needle Holder . . . . . 112  
 Glasser Micro Needle Holder . . . . . 90  
 Gregory Needle Holder . . . . . 86  
 Halsey Needle Holder . . . . . 97  
 Halsey Needle Holder Titanium . . . . . 98  
 Jacobson Micro Bayonet Needle Holder  
     . . . . . 91  
 Jacobson Super Middle Weight Needle  
     Holder . . . . . 89  
 Jacobson Super Middle Weight Needle  
     Holder Titanium . . . . . 88  
 Mathieu Heavy Needle Holder . . . . . 94  
 Mathieu Needle Holder . . . . . 95  
 Mayo-Hegar Needle Holder . . . . . 107  
 McPherson Needle Holder . . . . . 92  
 Microvascular Needle Holder . . . . . 104  
 Neivert Needle Holder . . . . . 101  
 New Orleans Wire Twister Needle Holder  
     . . . . . 113  
 Olsen-Webster Needle Holder . . . . . 110  
 Par Needle Holder . . . . . 99  
 Par Needle Holder Titanium . . . . . 101  
 Ramirez Type Endoscopic Plastic Facelift  
     Needle Holder . . . . . 313  
 Ryder Delicate Needle Holder . . . . . 103  
 Sontec Extra Micro Needle Holder . . . . . 87  
 Sontec-Olsen-Hegar Deluxe Needle Holder  
     . . . . . 108  
 Sontec Olsen-Hegar Needle Holder . . . . . 109  
 Sternal Wire Twister Needle Holder . . . . . 113  
 Swedish Style Needle Holder . . . . . 102  
 Webster Needle Holder . . . . . 96  
 Webster Needle Holder Titanium . . . . . 96  
 Neivert Anderson Guarded Osteotome . . . . . 192  
 Neivert Hook Retractor . . . . . 250  
 Neivert Needle Holder . . . . . 101  
 Neivert Retractor . . . . . 250  
 New Orleans Wire Twister Needle Holder . . . . .  
     113

**O**

O' Connor Skin Hook . . . . . 242  
 O' Connor Skin Hook Titanium . . . . . 242  
 Obwegeser Fenestrated Serrations Rasp . . . . .  
     353  
 Obwegeser Mandib Raspatory . . . . . 217  
 Obwegeser Ramus Osteotome . . . . . 200  
 Olsen-Webster Needle Holder . . . . . 110  
 Operating Classic, Tungsten Carbide, Power  
     Cut Gold, Power Cut Black, TC/PC  
     Power Cut Scissors . . . . . 37, 38  
 Orthopedic Vernier Caliper . . . . . 336  
 Osteotome  
     Alexander Osteotome . . . . .  
         195, 197  
     Blume Osteotome . . . . . 200  
     Brauer-Cottle Osteotome . . . . . 193  
     Cakir Osteotome . . . . . 197  
     Cinelli Guarded Osteotome . . . . . 193  
     Cook Guarded Osteotome . . . . . 197  
     Epkor Type Osteotome . . . . . 201  
     Fanous Gubisch Nasal Osteotome . . . . . 197  
     Neivert Anderson Guarded Osteotome

192  
 Obwegeser Ramus Osteotome . . . . . 200  
 Pitanguy U-Shaped Osteotome . . . . . 193  
 Plastic Surgery Guarded Osteotome . . . . . 195  
 Plastic Surgery Osteotome . . . . . 196  
 Rees Osteotome . . . . . 198  
 Rubin Nasal Osteotome . . . . . 193  
 Schrom Guarded Osteotome . . . . . 196  
 Silver Guarded Osteotome . . . . . 192  
 Sontec Intranasal Osteotome . . . . . 199  
 Sontec Nasal Dorsum Osteotome . . . . . 198  
 Sontec Osteotome . . . . . 199  
 Sontec Pattern Plastic Osteotome . . . . . 198  
 Sontec Type Lateral Osteotome . . . . . 200  
 Walter Osteotome . . . . . 201  
 Osteotomes  
 Micro Plastic Surgery Osteotome . . . . . 194  
 "V" Sontec® Osteotomes . . . . . 194  
 Ostium Burnisher Elevator . . . . . 211

**P**

Packer  
 Cottle Daniel Raspatory/Packer . . . . . 210  
 Freer Elevator / Packer . . . . . 208  
 Parkes Gouge . . . . . 184  
 Par Needle Holder . . . . . 99  
 Par Needle Holder Titanium . . . . . 101  
 Par Scissors . . . . . 49  
 Pashley-Frazier Suction . . . . . 389  
 Pashley Hook . . . . . 244  
 Pashley Knife Set . . . . . 329  
 Pashley Nasal Speculum Set . . . . . 229  
 Pashley Pipe Suction Tube Holding Device . . . . . 399  
 Paul Skin Rake Retractor . . . . . 254, 415  
 Peers Towel Forceps . . . . . 172  
 Pennington Elevator . . . . . 208  
 Perkins Retractor . . . . . 307  
 Pierser Corneal 1x2 Forceps . . . . . 135  
 Pigtail Lacrimal Probe Dilator . . . . . 431  
 Pitanguy Abdomen Marking Forceps . . . . . 164  
 Pitanguy Abdominal Marking Forceps . . . . . 166  
 Pitanguy Abdominal Retractor . . . . . 281, 282  
 Pitanguy Elevator With Suction . . . . . 223  
 Pitanguy Flap Grasping Forceps . . . . . 168  
 Pitanguy Marking Forceps . . . . . 166  
 Pitanguy Raspatory Elevator With Suction . . . . . 222  
 Pitanguy Rhytidoplasty Marking Forceps . . . . . 167  
 Pitanguy U-Shaped Osteotome . . . . . 193  
 Plastic Surgery Guarded Osteotome . . . . . 195  
 Plastic Surgery Osteotome . . . . . 196  
 Plastic Surgery Scissors . . . . . 45  
 Plester First Incision Knife . . . . . 328  
 Plester Jansen Retractor . . . . . 309  
 Plester Retractor Set . . . . . 308  
 Politzer Ear Knife . . . . . 327  
 Polokoff Bone Rasp Double-Ended Single-Sided . . . . . 347  
 Poole Suction . . . . . 396  
 Potts-Smith Dressing Forceps . . . . . 137  
 Potts-Smith Tissue Forceps . . . . . 138  
 Power Cut Black® . . . . . 75, 78  
 Power Cut Gold . . . . . 75, 78  
 Press

Sheehy Gelfoam Cartilage Press . . . . . 366  
 Probe  
 Barr Double Ended Probe . . . . . 433  
 Barr Fistula Probe . . . . . 433  
 Bowman Lacrimal Probe . . . . . 428  
 Buie Fistula Probe . . . . . 433  
 Larry Fistula Probe . . . . . 433  
 Lockhart Mummery Fistula Probe . . . . . 432  
 Maxillary Ostium Elevator / Probe . . . . . 210  
 Sontec® Septum Elevator / Probe . . . . . 210  
 Sontec Hook Probe Titanium . . . . . 244  
 St. Marks Fistula Probe . . . . . 433  
 Punch  
 Frontal Sinus Giraffe Punch . . . . . 21  
 Ramirez Type Endoscopic Plastic Forehead Procerus Punch . . . . . 312  
 Sontec Nasal Tip Cartilage Punch . . . . . 199  
 Punched Hole Gauge Ruler . . . . . 339  
 Putterman Clamp Forceps . . . . . 128

**R**

Ragnell Retractor . . . . . 296  
 Ragnell Undermining Power Cut Gold Scissors . . . . . 53  
 Rake Retractor . . . . . 250  
 Ramirez Type Endoscopic Plastic Facelift Needle Holder . . . . . 313  
 Ramirez Type Endoscopic Plastic Forehead Corrugator Grasper . . . . . 313  
 Ramirez Type Endoscopic Plastic Forehead Procerus Punch . . . . . 312  
 Ramirez Type Endoscopic Plastic Forehead Scissors . . . . . 312  
 Rasp  
 Daniel-Gubisch Raspatory/Rasp . . . . . 210  
 Foman Rasp . . . . . 346  
 Foman "R" Rasp . . . . . 347  
 Foman TC Insert Rasp . . . . . 342  
 Howard Bone Rasp Double-Ended Single-Sided . . . . . 347  
 Kistler Ear Cartilage Rasp . . . . . 343  
 Maltz Improved Double Ended Rasp . . . . . 344  
 Maltz Single-Ended Rasp . . . . . 351  
 Masing Rasp . . . . . 352  
 Miller Bone Rasp Double-Ended Single-Sided . . . . . 348  
 Miller Bone Rasp Double-Ended Single-Sided Serrated . . . . . 348  
 Miller Cross Serrated Rasp . . . . . 349  
 Miller Parallel Serrated Rasp . . . . . 350  
 Miller Rasp . . . . . 343, 348  
 Nail Rasp . . . . . 351  
 Obwegeser Fenestrated Serrations Rasp . . . . . 353  
 Polokoff Bone Rasp Double-Ended Single-Sided . . . . . 347  
 Rhinoplasty Rasp . . . . . 344  
 Sontec Diamond Surface Rasp . . . . . 352  
 Sontec-Glabella Sculpting TC Insert Rasp . . . . . 342, 353  
 Sontec Micro Rasp . . . . . 351  
 Sontec-Miller TC Insert Rasp . . . . . 348  
 Webster Glabella Sculpting Rasp . . . . . 342, 353  
 Raspatory  
 Cottle Daniel Raspatory/Packer . . . . . 210

Daniel-Gubisch Raspatory/Rasp . . . . . 210  
 Daniel Gubisch Rib Raspatory . . . . . 217  
 Doyen Raspatory . . . . . 216  
 Lempert Raspatory Elevator . . . . . 212  
 McCollough Twist Fomon Raspatory . . . . . 344  
 Obwegeser Mandib Raspatory . . . . . 217  
 Sontec A O Type Elevator / Raspatory . . . . . 218, 219  
 Rees Osteotome . . . . . 198  
 Retractor  
 Adamson Double-ended Hook and Retractor . . . . . 245  
 Anderson Bear Claw Hook Retractor . . . . . 253  
 Aufricht Nasal Retractor . . . . . 295, 301  
 Biggs Face Lift Retractor . . . . . 272  
 Biggs Mammoplasty Retractor . . . . . 270, 271, 273  
 Breast Retractor . . . . . 277  
 Converse Hand Retractor . . . . . 283  
 Cottle Alar Retractor . . . . . 254, 306  
 Cottle Neivert Hook Retractor . . . . . 250  
 Craig-Sheehan Retractor . . . . . 293  
 Deaver Retractor . . . . . 288, 289  
 Desmarres Lid Retractor . . . . . 302, 413  
 Desmarres Lid Retractor Autoclavable Plastic . . . . . 303  
 Desmarres Lid Retractor Titanium . . . . . 303  
 Endoscopic Guidance Face Lift Retractor . . . . . 284  
 Eye Ribbone Retractor . . . . . 414  
 Ferreira Breast Augmentation Retractor . . . . . 276, 278  
 Ferreira Face Lift Retractor . . . . . 274  
 Flexible Neck Hook Retractor . . . . . 253, 414  
 Freeman Flap Retractor . . . . . 287  
 Freeman Hook Retractor . . . . . 256  
 G Aufricht Nasal Retractor . . . . . 300  
 Gil-Vernet Desmarres Retractor . . . . . 303, 413  
 Helveston Tissue Retractor . . . . . 415  
 Hook Retractor . . . . . 255  
 Jackson Tracheal Retractor . . . . . 306  
 Jackson Tracheal Retractor Titanium . . . . . 292  
 Jefferson Retractor . . . . . 309  
 Kasdan Hand Retractor . . . . . 283  
 Kawamoto Double-Ended Retractor . . . . . 302  
 Knapp Rollet Hook Retractor . . . . . 253, 414  
 Langenbeck Retractor . . . . . 286  
 LaRoe Tissue Spreader Retractor . . . . . 294  
 Luer S-Shaped Retractor . . . . . 306  
 Lukens Thymus Retractor . . . . . 304  
 Maliniac Nasal Retractor . . . . . 275  
 Malleable Ribbon Retractor . . . . . 298  
 Mayo-Sontec Retractor . . . . . 307  
 McGannon Retractor . . . . . 302  
 Meyerding Finger Retractor . . . . . 305  
 Miller Skin Rake Retractor . . . . . 254, 415  
 Mini Rake Retractor . . . . . 254  
 Neivert Hook Retractor . . . . . 250  
 Neivert Retractor . . . . . 250  
 Paul Skin Rake Retractor . . . . . 254, 415

Perkins Retractor . . . . . 307  
 Pitanguy Abdominal Retractor . . . . . 281, 282  
 Plester Jansen Retractor . . . . . 309  
 Ragnell Retractor . . . . . 296  
 Rake Retractor . . . . . 250  
 Richardson Retractor . . . . . 297  
 S-Curve Retractor . . . . . 290  
 Senn Retractor . . . . . 296  
 Sewall Orbital Retractor . . . . . 411  
 Sontec Skin Retractor . . . . . 257  
 Sontec Suction Wound Retractor . . . . . 279, 280  
 Sontec-Yancoskie Coronal Lift Retractor . . . . . 257  
 Trousseau Tracheal Dilator Retractor . . . . . 293  
 Walter Aufricht Nasal Retractor . . . . . 292  
 Walter Aufricht Nasal Retractor Titanium . . . . . 292  
 Walter Forehead Retractor . . . . . 285  
 Blair Hook Retractor . . . . . 253, 414  
 U.S. Army-Navy Retractor . . . . . 294  
 Retractor, Senn . . . . . 296  
 Reul Coronary Artery Forceps . . . . . 138  
 Reusable Bipolar Cord . . . . . 147  
 Reverdin Needle/Ligature Carrier . . . . . 376  
 Reynolds Tenotomy Classic, Power Cut Gold, Power Cut Black, TC/PC Power Cut Scissors . . . . . 39  
 Rhinoplasty Rasp . . . . . 344  
 Rhoton Micro Neuro Suction . . . . . 386  
 Ribbon-Handle Classic Iris Scissors . . . . . 79  
 Richardson Retractor . . . . . 297  
 Rochester-Ochsner Forceps . . . . . 160  
 Roeder Towel Forceps . . . . . 172  
 Roger Elevator . . . . . 205  
 Rongeur  
 Back Biter Ostrum Antrum Punch Rongeur . . . . . 26, 31  
 Back Biter Rotating Punch Rongeur . . . . . 29  
 Bacon Duckbill Rongeur . . . . . 448  
 Beyer Rongeur . . . . . 321  
 Cicherelli Rongeur . . . . . 447  
 Circular Cutting Antrum Punch Rongeur . . . . . 26, 27  
 Classic Lempert Rongeur . . . . . 321, 445  
 Cleveland Rongeur . . . . . 447  
 Cushing Rongeur . . . . . 449  
 Defourmental Rongeur . . . . . 448  
 Frontal Ostium Nasal Rongeur . . . . . 31, 317  
 Hajek-Kofler Bone Punch Rongeur . . . . . 316  
 Hakansson Rongeur . . . . . 443  
 Hartman Rongeur . . . . . 449  
 Jansen-Middleton Septum Cut Through Rongeur Punch . . . . . 319  
 Jansen-Middleton Septum Rongeur . . . . . 318  
 Jeurs Lempert Neuro Rongeur . . . . . 446  
 Kerrison Punch (Occular-plasti) 40° Rongeur . . . . . 421  
 Kerrison Punch (Occular-plasti) 90° Rongeur . . . . . 420  
 Kleinert-Kutz Rongeur . . . . . 441  
 Levesque Neuro Rongeur . . . . . 446  
 Mcllwraith Arthroscopic Scissors Rongeur . . . . . 32  
 Mcllwraith Basket Cutter Rongeur . . . . . 32

Mcllwraith Cup Rongeur . . . . . 323  
 Micro Antrum Punch Rongeur . . . . . 28  
 Micro Friedman Ring Handle Rongeur . . . . . 441  
 Micro Friedman Rongeur . . . . . 442  
 Mini Arthroscopic Small Joints Rongeur Set . . . . . 20  
 Mini Friedman Rongeur . . . . . 442  
 Mini Neuro Premier Rongeur . . . . . 440  
 Mini Neuro Rongeur . . . . . 440  
 Shearer Chickenbill Rongeur . . . . . 443  
 Sontec Dynamic Punch Rongeur . . . . . 316  
 Sontec Lempert Rongeur . . . . . 445  
 Stellbrink Rongeur . . . . . 444  
 Takahashi Rongeur . . . . . 322  
 Weil Cut-Through Rongeur . . . . . 318  
 Rosen Circular Blade Dissector . . . . . 328  
 Rubin Nasal Osteotome . . . . . 193  
 Rubin Septal Morselizer Forceps . . . . . 359  
 Ruler  
 Punched Hole Gauge Ruler . . . . . 339  
 Ryder Delicate Needle Holder . . . . . 103

**S**

Sanders Brown Ligature Carrier . . . . . 379  
 Sauer Lid Speculum . . . . . 426  
 Saw  
 Joseph Bayonet Bone Saw . . . . . 402  
 Joseph Bone Saw . . . . . 402  
 Langenbeck Metacarpal Saw . . . . . 403  
 Linderman Amputation Saw . . . . . 403  
 Wellenschliff Nasal Saw . . . . . 403  
 Schepens Scleral Depressor . . . . . 412  
 Schiotz Tonometer . . . . . 338  
 Schmid Suction Tips . . . . . 392  
 Schmieden-Dick Ligature Carrier . . . . . 378  
 Schmidt Hemostatic Forceps . . . . . 163  
 Schrom Guarded Osteotome . . . . . 196  
 Scissors  
 Aufricht Saberback Power Cut Black® Scissors . . . . . 43  
 Baby Stratte Scissors . . . . . 83  
 Becker Septum Scissors . . . . . 67  
 Biro Naevus Scissors . . . . . 47  
 Black Kaye Scissors . . . . . 42  
 Brown Scissors . . . . . 54  
 Ceramitec Stevens Tenotomy Ergonomic Spread Handle Power Cut Black® Scissors . . . . . 76  
 Chadwick Scissors . . . . . 48  
 Cooley Power Cut Gold Scissors . . . . . 50  
 Cottle-Dorsal Scissors . . . . . 64, 65  
 Double Action Micro Scissors . . . . . 70  
 Eucleation Scissors . . . . . 83  
 Fanous Saberback Scissors . . . . . 59  
 Foman-Dorsal Scissors . . . . . 65, 66  
 Fomon Saberback Scissors . . . . . 56  
 Freeman-Kaye Ceramitec Ergonomic Spread Handle Saberback Scissors . . . . . 41  
 Freeman-Kaye Ergonomic Spread Handle Saberback Scissors . . . . . 40, 41  
 Giunta Tungsten Carbide Serrated Scissors . . . . . 46  
 Gorney-Kahn Scissors . . . . . 43

Gorney Septal Scissors . . . . . 67  
 Gorney Turbinate Scissors . . . . . 63  
 Heymann Nasal Scissors . . . . . 62, 66  
 Iris Classic Tungsten Carbide Power Cut Gold Power Cut Black TC/PC Scissors . . . . . 80  
 Iris Stille Classic Large Rings Scissors . . . . . 82  
 Jabaley Scissors . . . . . 49  
 Jacobson Micro Scissors . . . . . 72  
 Joseph-Peck Saberback Classic Power Cut Gold Power Cut Black TC/PC Power Cut Scissors . . . . . 51  
 Joseph Sharp Sharp Classic Power Cut Gold Power Cut Black Scissors . . . . . 50  
 Kahn Face-Lift Scissors . . . . . 44  
 Kahn-Fomon Scissors . . . . . 43  
 Kaye Blepharoplasty Scissors . . . . . 54, 55  
 Kelly Power Cut Gold Power Cut Black Fistula Scissors . . . . . 52  
 Knight Nasal Scissors . . . . . 62  
 Littler Suture Carrying Scissors . . . . . 46  
 Mayo-Carroll Scissors . . . . . 70  
 Mayo-Harrington Scissors . . . . . 71  
 Nasal Scissors . . . . . 33, 68, 69  
 Operating Classic, Tungsten Carbide, Power Cut Gold, Power Cut Black, TC/PC Power Cut Scissors . . . . . 37, 38  
 Par Scissors . . . . . 49  
 Plastic Surgery Scissors . . . . . 45  
 Ragnell Undermining Power Cut Gold Scissors . . . . . 53  
 Ramirez Type Endoscopic Plastic Forehead Scissors . . . . . 312  
 Reynolds Tenotomy Classic, Power Cut Gold, Power Cut Black, TC/PC Power Cut Scissors . . . . . 39  
 Ribbon-Handle Classic Iris Scissors . . . . . 79  
 Sistrunk Scissors . . . . . 57  
 Sontec Bipolar Metzenbaum Scissors . . . . . 60  
 Sontec Double Action Micro Scissors . . . . . 70  
 Sontec Heifetz Micro Scissors . . . . . 71  
 Sontec Nasal Scissors . . . . . 69  
 Stevens Siegert Tenotomy Scissors Double Beveled Blades . . . . . 77  
 Stevens Tenotomy Classic PC Gold Scissors . . . . . 74  
 Stevens Tenotomy Classic, Tungsten Carbide, Power Cut Gold, Power Cut Black®, Ceramitec Scissors . . . . . 78  
 Stevens Tenotomy Ergonomic Spread Handle Power Cut Black Scissors . . . . . 74  
 Stevens Tenotomy Ergonomic Spread Handle Tungsten Carbide Power Cut Black/Gold Scissors . . . . . 75  
 Stevens Tenotomy , Tungsten Carbide, Power Cut Gold, Power Cut Black®, Ceramic Coated Scissors . . . . . 75  
 Strabismus Classic Tungsten Carbide Power Cut Gold Power Cut Black Scissors . . . . . 79  
 Swedish Gradle Scissors . . . . . 48  
 Taylor Dura Scissors . . . . . 48  
 Titanium Westcott Tenotomy Scissors . . . . . 74  
 Trepsat Face-Lift Scissors . . . . . 44

Westcott Stitch Scissors . . . . .	72
Westcott Tenotomy Scissors . . . . .	73
Westcott Wide Handle Tenotomy Scissors . . . . .	73
Wilkinson Rhytidectomy Scissors . . . . .	42
Scissors	
Iris Stille Classic Large Cut Out Rings Scissors . . . . .	82
Scleral Depressor . . . . .	412
S-Curve Retractor . . . . .	290
Seltzer Dermal Biopsy Hook . . . . .	243
Serrefine Bulldog Clamp . . . . .	154
Sesamoid Cottle Elevator . . . . .	209
Set	
Bishop-Harmon Irrigation Bulb Cannula Set . . . . .	409
Bodian Lacrimal Probe Set . . . . .	430
Catalano Lacrimal Intubation Set . . . . .	429
Couppland Suction Set . . . . .	398
Crawford Lacrimal Intubation Set . . . . .	429
Gubish Surgical Pen Holder Set . . . . .	11
Jackson Lacrimal Intubation Set . . . . .	429
Mini Arthroscopic Small Joints Rongeur Set . . . . .	20
Pashley Nasal Speculum Set . . . . .	229
Plester Retractor Set . . . . .	308
Sontec Ear Rasp Set . . . . .	345
Zoellner Micro Ear Surgery Set . . . . .	215
Severin Lacrimal Cannula . . . . .	410
Sewall Orbital Retractor . . . . .	411
Sewall Tongue Depressor . . . . .	232
Sexton-Gerzog Ear Knife . . . . .	326
Shahinian Lacrimal Cannula . . . . .	410
Shapleigh Ear Curette . . . . .	176
Shearer Chickenbill Rongeur . . . . .	443
Sheehy Gelfoam Cartilage Press . . . . .	366
Sheen Cartilage Cutting Grid . . . . .	370
Sheen Fragment Retriever Forceps . . . . .	320, 323
Sickle Knife . . . . .	327
Side Biting Alligator . . . . .	15
Side Biting Alligator Forceps . . . . .	15
Siegel Knife Handle . . . . .	11
Silicone Eye Implants . . . . .	408
Silver Guarded Osteotome . . . . .	192
Sistrunk Scissors . . . . .	57
Skinner Tissue Forceps . . . . .	138
Smith-Petersen Gouge . . . . .	186
Snellen Entropium Clamp Forceps . . . . .	129
Solz Breast Hook Dissector . . . . .	261
Sonnenschein Nasal Speculum . . . . .	226
Sontec® Excavator Curette . . . . .	179
Sontec® Skin Hook . . . . .	242
Sontec® Skin Hook Titanium . . . . .	242
Sontec Alar Stabilizing Jig . . . . .	247
Sontec A O Type Elevator / Raspatory . . . . .	218, 219
Sontec Areola Marker . . . . .	360
Sontec Bipolar Metzenbaum Scissors . . . . .	60
Sontec Bone Hook . . . . .	251
Sontec Chisel . . . . .	189
Sontec Combo Nylon Mallet . . . . .	436
Sontec Cottle Elevator . . . . .	209
Sontec Diamond Surface Rasp . . . . .	352
Sontec Double Action Micro Scissors . . . . .	70
Sontec Double Nylon Mallet . . . . .	437
Sontec Dynamic Punch Rongeur . . . . .	316
Sontec Ear Rasp Set . . . . .	345
Sontec Excavator Curette . . . . .	179
Sontec Extra Micro Needle Holder . . . . .	87
Sontec Eye Lid Forceps . . . . .	127
Sontec Forehead Lifter . . . . .	212
Sontec Freer Double Skin Titanium . . . . .	242
Sontec Freer Skin Hook Titanium . . . . .	241
Sontec-Glabella Sculpting Rasp . . . . .	342, 353
Sontec-Glabella Sculpting TC Insert Rasp . . . . .	342, 353
Sontec Heifetz Micro Scissors . . . . .	71
Sontec Hook Probe Titanium . . . . .	244
Sontec Intranasal Osteotome . . . . .	199
Sontec Knife Handle #3XXL . . . . .	11
Sontec Lempert Rongeur . . . . .	445
Sontec-Masing Septal Dissector . . . . .	204
Sontec Micro Alligator Forceps . . . . .	14
Sontec Micro Biopsy Forceps . . . . .	25
Sontec Micro Gouge . . . . .	186
Sontec Micro Mallet . . . . .	437
Sontec Micro Rasp . . . . .	351
Sontec-Miller TC Insert Rasp . . . . .	348
Sontec Nasal Dorsum Osteotome . . . . .	198
Sontec Nasal Scissors . . . . .	69
Sontec Nasal Tip Cartilage Punch . . . . .	199
Sontec Neuro Suction . . . . .	387
Sontec-Olsen-Hegar Deluxe Needle Holder . . . . .	108
Sontec Olsen-Hegar Needle Holder . . . . .	109
Sontec Osteotome . . . . .	199
Sontec Pattern Plastic Osteotome . . . . .	198
Sontec Perfusion Cannula Suction . . . . .	397
Sontec Reverdin Blunt Needle/Ligature Carrier . . . . .	376
Sontec Septal Platform Forceps . . . . .	320, 364
Sontec Septal Platform Forceps Titanium . . . . .	364
Sontec Septum Elevator / Probe . . . . .	210
Sontec Skin Retractor . . . . .	257
Sontec S.P.T. Elevator . . . . .	205
Sontec Suction Wound Retractor . . . . .	279, 280
Sontec Tissue Twist Hook . . . . .	240
Sontec Tracheal Hook Titanium . . . . .	249
Sontec Type Lateral Osteotome . . . . .	200
Sontec Universal Bottle Opener . . . . .	359
Sontec-Yancoskie Coronal Lift Retractor . . . . .	257
Spatula	
Davis Brain Black Silicon Spatula . . . . .	419
Davis Brain Spatula . . . . .	418
Specula	
Boucheron Ear Specula Chrome . . . . .	230
Farrior Ear Specula . . . . .	231
Gruber Ear Specula . . . . .	230
Hartmann Ear Specula . . . . .	230
Speculum	
Barraquer Infant Wire Speculum . . . . .	426
Barraquer Wire Speculum . . . . .	422, 424
Barraquer Wire Speculum Third Eye Lid . . . . .	423
Cook Eye Speculum . . . . .	427
Cottle Septum Speculum . . . . .	229
Cottle Speculum . . . . .	228
Killian Nasal Speculum . . . . .	227, 228
Killian Septum Speculum . . . . .	226
Kratz Aspirating Wire Speculum . . . . .	424
Kratz-Barraquer Wire Speculum . . . . .	425

McKee Eye Speculum . . . . .	426
Modified Cottle Speculum . . . . .	228
Murdoch Eye Speculum . . . . .	427
Sauer Lid Speculum . . . . .	426
Sonnenschein Nasal Speculum . . . . .	226
Tieck-Halle Infant Nasal Speculum . . . . .	226
Spoon	
Gross Ear Hook & Spoon . . . . .	243
Stabilizing Restrainer	
Lead Hand Stabilizing Restrainer . . . . .	299
Stahl A/C Lens Gauge . . . . .	337
Stahl Caliper . . . . .	337
Staley Round Knurled Knife Handle . . . . .	11
Stellbrink Rongeur . . . . .	444
Sternal Wire Twister Needle Holder . . . . .	113
Stern-Castroviejo Suture 1x2 Tissue Forceps . . . . .	132
Stevens Siegert Tenotomy Scissors Double Beveled Blades . . . . .	77
Stevens Tenotomy . . . . .	75
Stevens Tenotomy Classic . . . . .	78
Stevens Tenotomy Classic PC Gold Scissors . . . . .	74
Stevens Tenotomy Ergonomic Spread	
Handle Power Cut Black Scissors . . . . .	74
Stevens Tenotomy Ergonomic Spread	
Handle Tungsten Carbide Power Cut Black/Gold Scissors . . . . .	75
Stille-Adson Dressing Forceps . . . . .	118
St. Marks Fistula Probe . . . . .	433
Strabismus Classic Tungsten Carbide Power Cut Gold Power Cut Black Scissors . . . . .	79
Strabismus Forceps . . . . .	133
Stripper	
Tendon Stripper . . . . .	366
Suction	
Adson Suction . . . . .	396
Andrews Pynchon Suction . . . . .	394
Anthony Suction . . . . .	394
Baby Poole Suction . . . . .	396
Braun-Ralph Suction . . . . .	394
Frazier Angled Suction . . . . .	382
Frazier Insulated Suction . . . . .	384
Frazier Straight Suction . . . . .	383
Fukushima Suction . . . . .	385
Gorney Elevator With Suction . . . . .	223
Haraldsson Elevator with Suction . . . . .	223
House-Baron Suction . . . . .	393
House Irrigator/Suction . . . . .	393
Killian (Von Eicken) Suction . . . . .	397
Modified Ferguson-Frazier Suction . . . . .	390
Pashley-Frazier Suction . . . . .	389
Pitanguy Elevator With Suction . . . . .	223
Pitanguy Raspatory Elevator With Suction . . . . .	222
Poole Suction . . . . .	396
Rhoton Micro Neuro Suction . . . . .	386
Schmid Suction Tips . . . . .	392
Sontec Neuro Suction . . . . .	387
Sontec Perfusion Cannula Suction . . . . .	397
Yankauer Suction . . . . .	395
Suction Cup Handle for Eye Shields . . . . .	407
Suction Tube	
Barnes Mini Suction Tube . . . . .	388
Bayonet Suction Tube . . . . .	391
Buie Suction Tube . . . . .	392
Sump Sucker	

Heartline Ross Sump Sucker . . . . .	396
Swedish Gradle Scissors . . . . .	48
Swedish Style Needle Holder . . . . .	102
Swiss Cilia Forceps . . . . .	131
<b>T</b>	
T10-1010C . . . . .	422
T10-1013 . . . . .	423
T10-1014 . . . . .	423
T10-1015 . . . . .	423
T10-1016 . . . . .	423
T10-1300S . . . . .	426
T10-4198 . . . . .	303
T10-4255 . . . . .	303
T12-9300 . . . . .	334
T14-2955 . . . . .	135
T14-3071 . . . . .	132
T14-3072 . . . . .	132
T14-3073 . . . . .	132
T14-3074 . . . . .	132
T14-3075 . . . . .	132
T14-3077 . . . . .	132
T14-3800 . . . . .	134
T14-4440 . . . . .	143
T14-5200 . . . . .	125
T14-5220 . . . . .	125
T14-6303 . . . . .	130, 143
T14-6400 . . . . .	130
T14-6500 . . . . .	130
T14-6510 . . . . .	130
T14-6816 . . . . .	116
T14-9850 . . . . .	126
T14-9906 . . . . .	127
T14-9907 . . . . .	127
T14-9908 . . . . .	127
T15-1320 . . . . .	92
T15-1320R . . . . .	92
T15-1330 . . . . .	92
T15-1330R . . . . .	92
T18-8023 . . . . .	407
T115-450 . . . . .	161
T117-500 . . . . .	169
T117-560 . . . . .	11
T136-686 . . . . .	121
Takahashi Rongeur . . . . .	322
Taylor Dura Scissors . . . . .	48
Tchalekian Mammary Marker Forceps . . . . .	167
Tendon Knife . . . . .	326
Tendon Passer Ligature Carrier . . . . .	377
Tendon Stripper . . . . .	366
Tessier Bone Morselizing Forceps . . . . .	358
Tholl Curette . . . . .	179
Thorpe Caliper . . . . .	336
Thumb Ring Skin Hook . . . . .	252
Tieck-Halle Infant Nasal Speculum . . . . .	226
Tissue Bipolar Forceps . . . . .	144
Titanium Westcott Tenotomy Scissors . . . . .	74
Tohoku Towel Forceps . . . . .	171
Tongue Tie	
Grooved Director Tongue Tie . . . . .	432
Tonometer	
Schiotz Tonometer . . . . .	338
Towel Clamp . . . . .	173
Trepsat Face-Lift Scissors . . . . .	44
Trousseau Tracheal Dilator Retractor . . . . .	293

Troutman-Colibri Suture Forceps . . . . .	135
Tungsten Carbide . . . . .	75, 78
Tyrell Skin Hook . . . . .	240

**U**

Universal Adjustable Angle Knife Handle #3. 10 . . . . .	
Universal Microvascular Clamp . . . . .	152
U.S. Army-Navy Retractor . . . . .	294

**V**

“V” Sontec® Osteotomes . . . . .	194
----------------------------------	-----

**W**

Walter Aufricht Nasal Retractor . . . . .	292
Walter Aufricht Nasal Retractor Titanium . . . . .	292
Walter Forehead Retractor . . . . .	285
Walter Meniscus Gouge . . . . .	185
Walter Osteotome . . . . .	201
Webster Glabella Sculpting Rasp . . . . .	342, 353
Webster Needle Holder . . . . .	96
Webster Needle Holder Titanium . . . . .	96
Weil Cut-Through Rongeur . . . . .	318
Wellenschliff Nasal Saw . . . . .	403
West Cannula . . . . .	410
Westcott Stitch Scissors . . . . .	72
Westcott Tenotomy Scissors . . . . .	73
Westcott Wide Handle Tenotomy Scissors . . . . .	73
Wide Barrel Grip Knife Handle #3 . . . . .	10
Wieder Tongue Depressor . . . . .	233
Wilder Lacrimal Dilator . . . . .	431
Wilkinson Rhytidectomy Scissors . . . . .	42
Williger Curette . . . . .	177
Wire Twister	
New Orleans Wire Twister Needle Holder . . . . .	113
Sternal Wire Twister Needle Holder . . . . .	113
Woodson Elevator . . . . .	204
Wright Fascia Needle . . . . .	356

**Y**

Yankauer Suction . . . . .	395
Yasargil Arachnoid Knife . . . . .	329
Yasargil Bayonet Arachnoid Knife Titanium . . . . .	329

**Z**

Ziegler Cilia Forceps . . . . .	131
Zoellner Micro Ear Surgery Set . . . . .	215





**In Business for Over 50 Years**

Bringing the Highest Quality Surgical  
Instrumentation to the World since 1970



**Sontec Instruments®**

A TRADITION OF FINE SURGICAL INSTRUMENTS

Sontec Instruments, Inc.  
7248 South Tucson Way  
Centennial, Colorado 80112 USA  
Toll-free / 800.821.7496  
Local / 303.790.9411  
Fax / 303.792.2606

[SontecInstruments.com](http://SontecInstruments.com)