



# Sontec Instruments®

A TRADITION OF FINE SURGICAL INSTRUMENTS

VETERINARY

Dear Customer,

Sontec Instruments, Inc. is a family owned & operated medical company, providing personalized service featuring the finest in surgical instrumentation for over half a century.

Our surgical instruments encompass the entire human anatomy including specialty products specific to small and large animal surgery.

Owner of Sontec Instruments, Dennis Russell Scanlan III and his sons, Johann, Stefan and Angus Scanlan bring with them a lifetime of experience creating the highest quality products made by the world's leading manufacturing facilities featuring, cutting edge robotic technology, handmade workmanship combined with an understanding how to make exactly what our valued customers have come to expect.

Dennis R. Scanlan, III President & CEO and his wife Caron C. Scanlan thank you, for the opportunity to present our specialty Veterinary catalog.

Sincerely,



Dennis Russell Scanlan III

## Table of Contents

STORAGE CASES & CLEANING .....	9
KNIFE & BLADE Handles .....	23
ENT KNIVES .....	27
CALIPERS & RULERS .....	37
Abdominal RETRACTORS .....	43
Cardiovascular RETRACTORS .....	51
Cardiovascular CLAMPS .....	63
Eye RETRACTORS .....	83
Eye SPECIALTY .....	93
Eye FORCEPS .....	105
Eye ENT SCISSORS .....	115
Veterinary Small & Equine Large Animal Specialty .....	129
Dental 157	
FORCEPS Flat Handle .....	183
FORCEPS Ring Handle .....	205
Neuro HOOKS .....	231
Rhoton Jacobson Curette & Dissector Hook Set .....	237
ENT Plastic SUCTION ELEVATORS .....	245
SUCTION Selection .....	249
BANDAGE & SUTURE SCISSORS .....	263
MAYO SCISSORS .....	277
METZENBAUM SCISSORS .....	285
ENT Plastic SCISSORS .....	293
NEEDLE HOLDERS Ring Handle .....	311
NEEDLE HOLDERS Spring Handle - Eye, Cardio & Micro .....	323
NEEDLE HOLDERS with Scissors .....	333
ARTHROSCOPIC .....	343
Bone & NAIL CUTTING Forceps .....	371
ENT SAWS .....	375
Ligature Carriers .....	379
RASPS 385	
Orthopedic RETRACTORS .....	397
Orthopedic BONE HOLDING CLAMPS .....	419
Orthopedic BONE REDUCTION CLAMPS .....	429
Orthopedic CURETTES .....	439
ENT CURETTES .....	445
Orthopedic SINGLE ACTION RONGEURS .....	455
Orthopedic DOUBLE ACTION RONGEURS .....	467
Kerrison RONGEURS .....	471
Pistol Grip RONGEURS .....	477
ALLIGATOR BIOPSY FORCEPS .....	495
Orthopedic DRILLS, DRILL GUIDES & CHUCKS .....	503
Orthopedic ELEVATORS .....	509
ELEVATORS .....	517
Orthopedic MALLETS .....	525
Orthopedic OSTEOTOMES .....	531
Orthopedic PIN-PULLERS, DRIVERS & BENDERS .....	541
Orthopedic PLATE BENDERS & BENDING IRONS .....	551
Orthopedic SCREWDRIVERS .....	555
Orthopedic WIRE PASSERS .....	561
Orthopedic WIRE PIN CUTTERS .....	565
Orthopedic WIRE TWISTERS .....	579
Orthopedic CARTILAGE CLAMPS .....	587
Laparoscopy .....	593
Surgical SETS .....	619
Index 654	

## Important Information

### Guarantee & Repairs Policy

Sontec® surgical instruments are guaranteed to be free of defects in materials and workmanship. Any Sontec® instrument that is defective will be repaired or replaced at our discretion. Instruments not properly cared for, used for unintended purposes, or beyond their designed capacity will not be covered under this guarantee. Our liability under this guarantee is limited to the repair or replacement of the defective merchandise.

Sontec® has its own repair department where most mechanically functional instruments can be returned to like-new condition.

Sontec® performs a variety of repairs, such as replacing worn TC jaws or sharpening scissors. In addition, we complete a comprehensive evaluation of your instruments to determine if further service is required.

For repair service, please send the following directly to the address below:

- Instruments clean, sterilized, securely wrapped and carefully packaged.
- Purchase and/or repair order
- A note with contact and shipping information
- Sending multiple items eliminates \$50 minimum charge

### Return Policy

The return of new, unused instruments in their original packaging is accepted within 30 days of purchase with an authorized "Return Merchandise Authorization". Please contact Sontec directly by phone or email with your invoice or proof of purchase in order to obtain your RMA slip and instructions. Restocking fee applies and credit will not be issued for shipping charges or handling fees. Proper credit is not guaranteed without an RMA. Custom, Special Order or Modified items are non-returnable.

Sontec Instruments, Inc.  
Toll free: 800.821.7496  
Local: 303.790.9411  
returns@sontecinstruments.com

### Remember

Sontec® offers other catalogs for a variety of surgical instrumentation, including:

- Alligator, Grasping, & Biopsy Forceps
- Avian & Exotic
- Bandage Scissors
- Cardiovascular & Thoracoscopic
- Caspar & Cloward Retractor Systems
- Colon & Rectal
- Cranial Cruciate Ligament Lateral Suture

#### System

- Equine (Arthroscopic)
- Eye
- Neurology & Orthopedic
- Orthopedic & Arthroscopic
- Urology
- Veterinary Dental
- Veterinary Eye
- General Veterinary Instrumentation

Also, if you do not find what you are looking for, please contact us.

### Instrument Care

Designed and crafted to exacting specifications, surgical instruments will perform for a number of years, provided they are maintained correctly and used for their intended purpose. A strict maintenance schedule will help reduce the need for premature replacements, thus cutting costs. For proper safeguarding of surgical instruments, please read and share the following information.

- Never substitute sterilization for cleanliness
- Wash brand new instruments prior to the first sterilization
- Remove saline solution, bleach, blood and tissue from instruments quickly and thoroughly
- Always use distilled water for cleaning instruments
- Never use saline solution for cleaning instruments
- Prevent cross-corrosion by separating corroded instruments from other instruments
- Never autoclave econo-grade stainless with superior-grade stainless.
- Always autoclave instruments with box lock open to alleviate pressure at the joint and to prevent fracture
- Lubricate joint and box lock after cleaning with an anti-microbial, water soluble lubricant
- Protect the tips of delicate instruments with protective covers (see page a.)
- Never use an instrument for anything other than its intended use

### Additional Safeguarding Guidelines

#### Scissors and Other Blades

- Perform routine inspections for sharpness, as a blade becomes duller with each stroke (all operating and Mayo scissors should be able to cut through four layers of gauze)
- When blades no longer cut without an excessive amount of force, please return them to Sontec® for sharpening
- The more often a blade is sharpened, the longer it tends to last

#### Needle Holders

- Repair is necessary when needle holder no longer securely holds needle when locked on the second ratchet tooth, and needle turns easily by hand

### Please Note

- We are not responsible for typographical errors in this catalog
- Instruments pictured in this catalog may or may not be to size
- Variations and changes in instrument design are possible
- Pricing is subject to change without notice
- Delivery schedules may vary from original estimates
- Some items are for veterinary use

### Contact Info

Sontec Instruments, Inc.  
7248 South Tucson Way  
Centennial, Colorado 80112, USA  
Toll free: 800.821.7496  
Local: 303.790.9411  
service@sontecinstruments.com  
www.sontecinstruments.com

## Troubleshooting Guide

Problem	Cause	Solution
Rust	Worn chrome plating on brass instruments	Be aware of plating condition and remove from service when wear is visible.
	Cross-corrosion from carbon instruments to stainless steel	Keep carbon steel and stainless steel instruments separated during cleaning and sterilization.
	Low grade instruments may not have been passivated	Remove from service.
	Autoclave not operating properly	Clean and thoroughly flush water lines in sterilizer according to manufacturer's instructions. Only use distilled water, never tap water, to generate steam.
	Organic matter left on instrument after surgery	Remove all blood and tissue before drying. Use distilled water and a nylon brush to clean hard to reach areas.
Pitting	Prolonged exposure to corrosive chemicals and/or organic substances	Only use approved cleaning and sterilization solutions. Thoroughly rinse and dry instruments.
Orange / Brown Stains	Contaminated sterilizer, high alkaline detergent, cold disinfectants	Clean sterilizer. Use neutral pH solutions. Thoroughly clean, rinse, and dry instruments.
Bluish Black Stains	Mixing dissimilar metals during cleaning and sterilization	Separate carbon steel, aluminum, and stainless steel instruments.
Rainbow - colored Stains	Chromium oxide stain-result of excessive heat	Send in for polishing and hardness check.
Cracked Box Lock	Excessive force, sterilized in the closed position	Replace the instrument.
Cracked Jaw on Pin Cutter	Cutting pin at tip of jaws	Replace the instrument. Cut pin in center of jaws.

Conversion Table

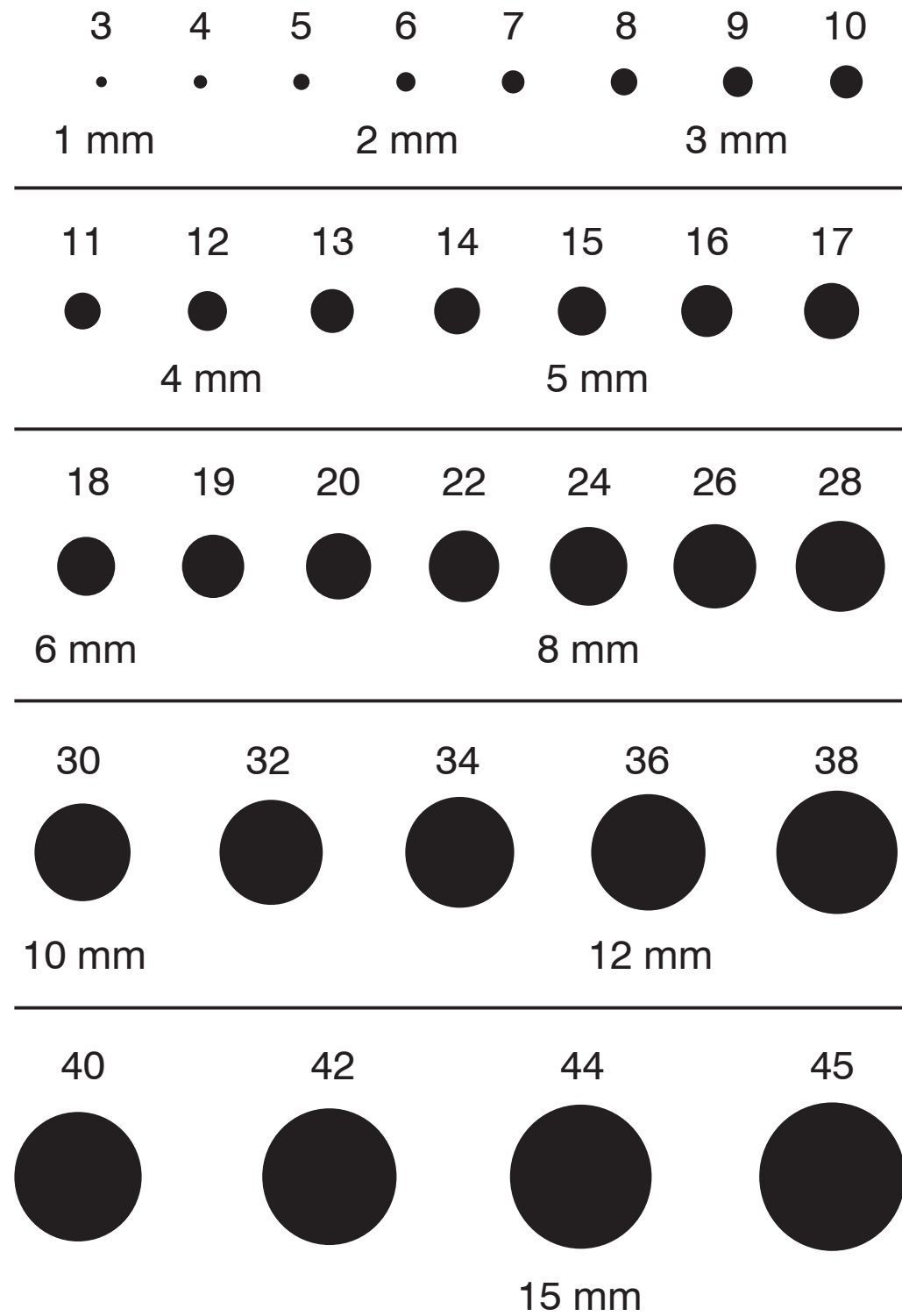

Conversion Table

Multiply	By	To Obtain
Millimeters	0.1	Centimeters
Millimeters	0.03937	Inches
Centimeters	0.3937	Inches
Centimeters	0.01	Meters
Centimeters	10	Millimeters
Inches	2.540	Centimeters
$1/8'' = 3.175$ millimeters		
$1/4'' = 6.350$ millimeters		
$3/8'' = 9.525$ millimeters		
$1/2'' = 12.70$ millimeters		
$1'' = 25.40$ millimeters		

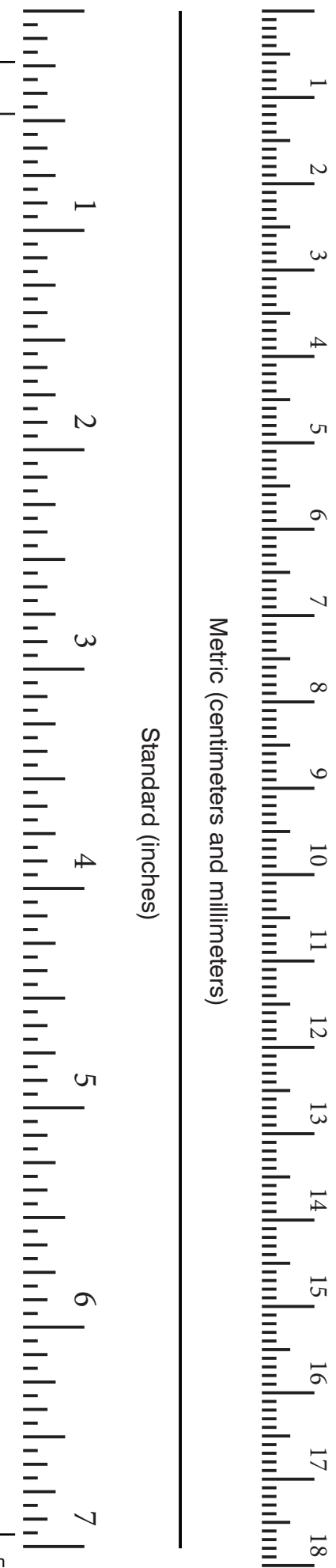

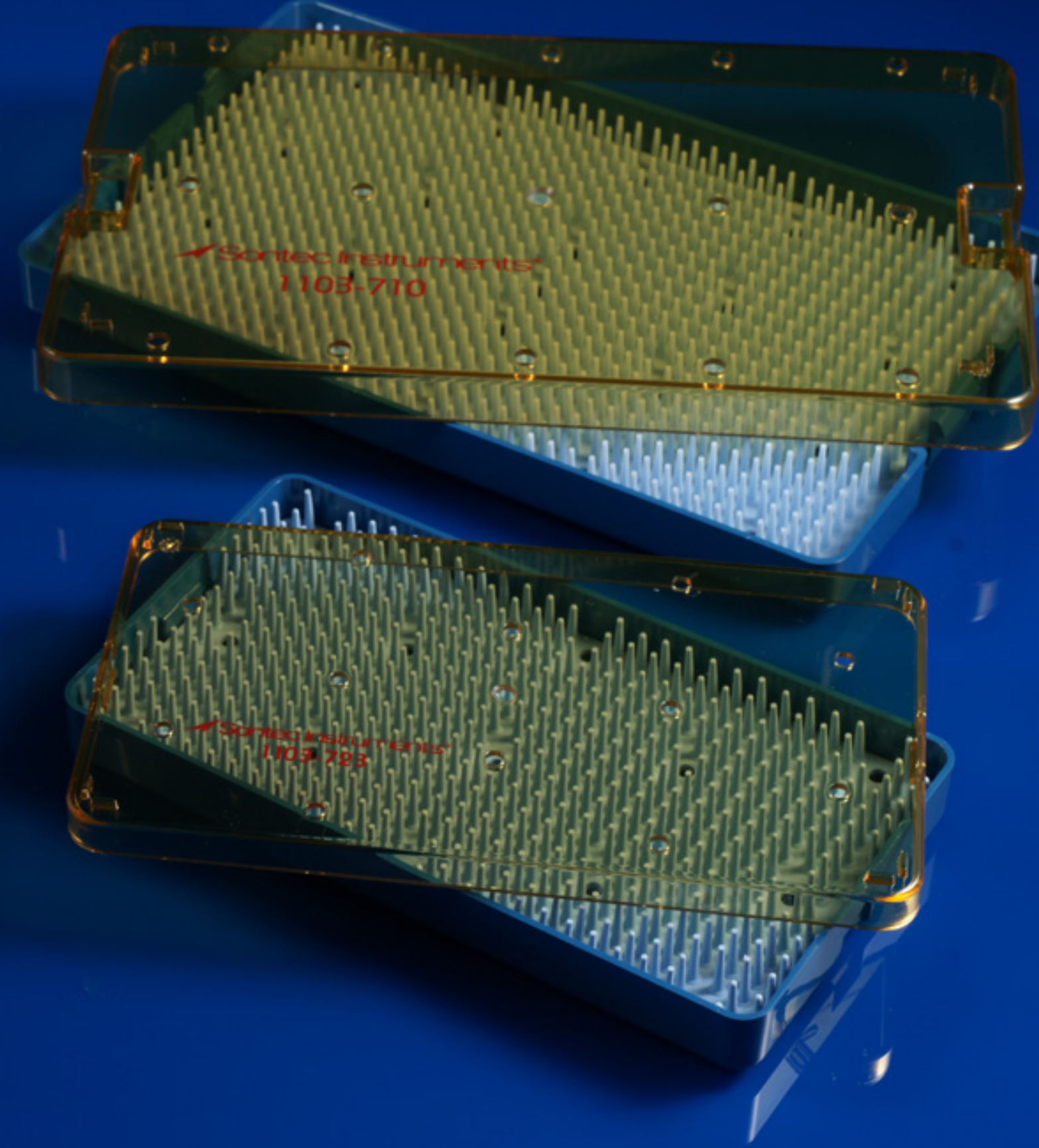
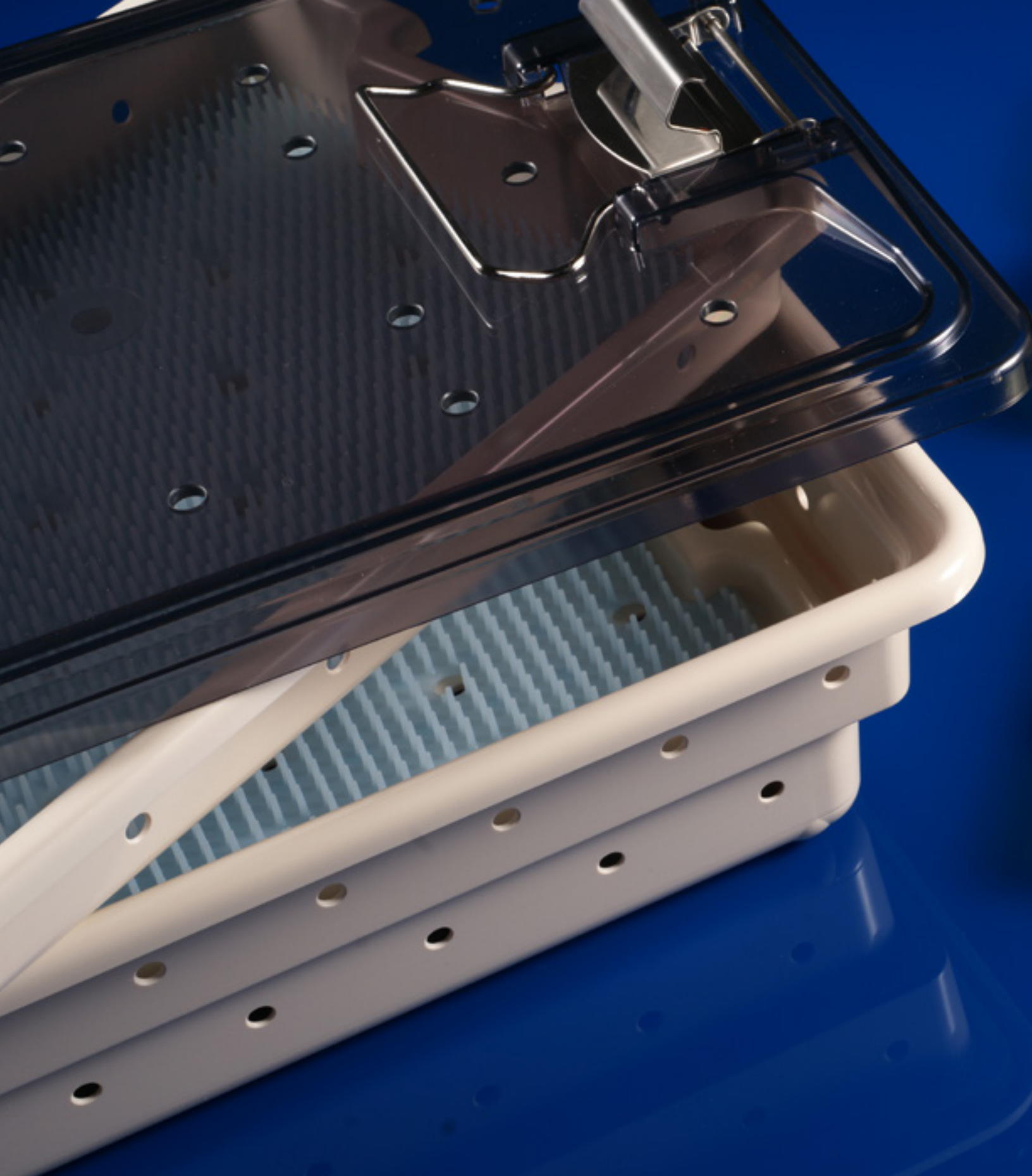

 Sontec Instruments®  
STORAGE CASES & CLEANING

**Thermoplastic Instrument Trays**

With silicone mat and metal clasps / autoclavable

- 1103-717 double decker 11" x 7" x 1 1/2"
- 1103-717D single deep 11" x 7" x 1 1/2"
- 1103-712 single shallow 11" x 7" x 3/4"

\* Other sizes available upon request, requires special order. Check your measurements.

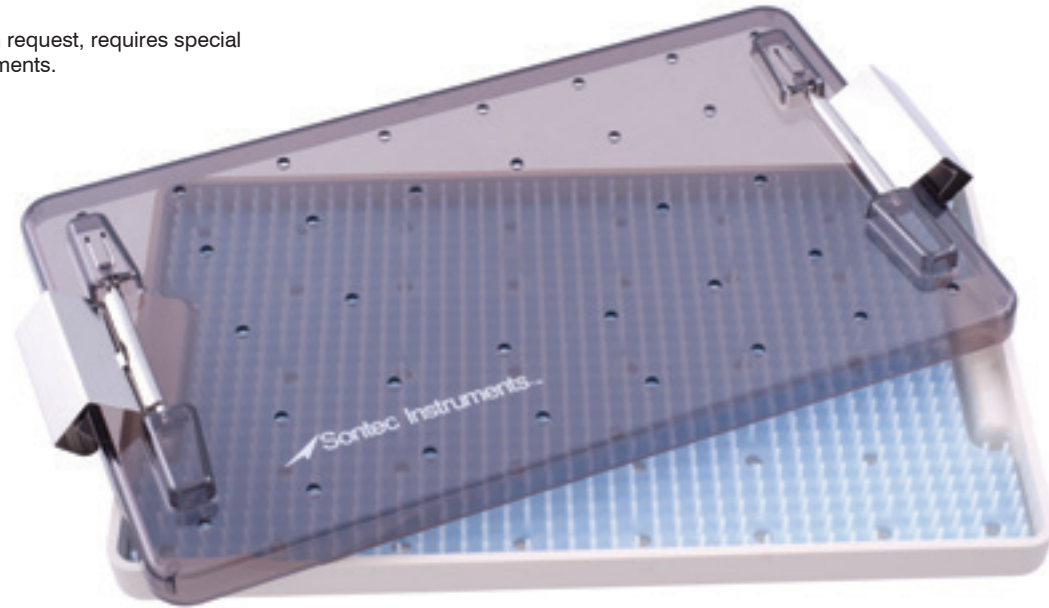

1103-712

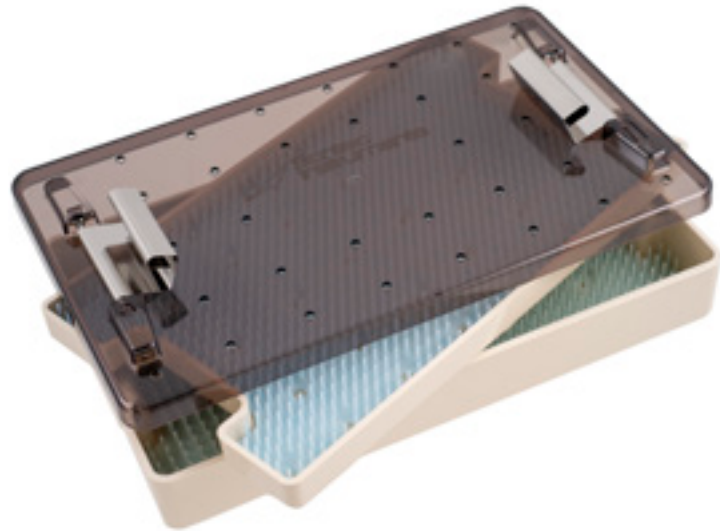

1103-717

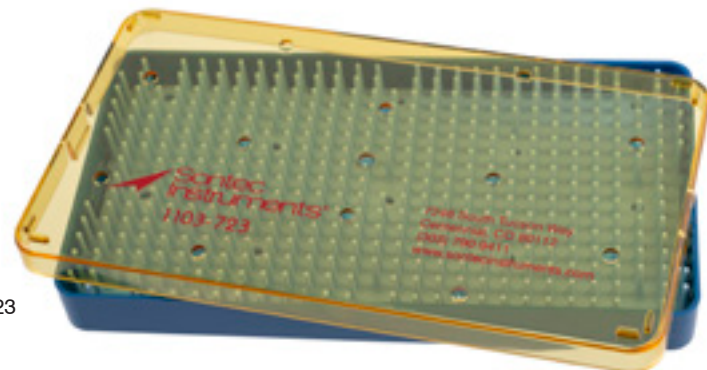

1103-723

**Sontec Slim Thermoplastic Instrument Tray**

- 18-3209 tray 10.3" x 18.3" x 2.33"
- 18-3270 tray 18.3" x 8.35" x 2"

\* "Check Your Measurements", These items are FINAL SALE



18-3209



18-3270

**Catheter Trays & Dome Lid Covers**

Heavy duty / seamless / for catheter trays / strap handles / easy to handle

ST83 8 3/4" x 3 1/4" x 1 1/2" Tray  
ST83-2 Lid Cover: fits tray ST83

ST17-0-0 17 1/4" x 4 1/2" x 2" Tray  
ST17-0-2 Lid Cover: fits tray ST170

ST95-2 8 7/8" x 5" x 2" Tray  
ST95-3 8 7/8" x 5" x 3" Tray  
ST95-2D-2 Lid Cover: fits trays ST952 & ST953

\* "Check Your Measurements"  
These items are FINAL SALE



**Stainless Steel Instrument Trays, Lid Covers & Perforated Nesting Sterilization Instrument Trays**

Used for hot or cold sterilization / for Sterilization Trays / recessed strap handles / easy to handle / easy to store / safe to transport

STE2-0124 solid 20 3/4" x 12 3/4" x 4" Tray  
STP2-0122 perforated 20 3/4" x 12 3/4" x 2 1/2" Tray  
STE2-0126 solid 20 3/4" x 12 3/4" x 6" Tray  
STP2-0124 perforated 20 3/4" x 12 3/4" x 4" Tray  
ST20-00-2 Lid Cover: fits trays STE20124, STP20122, STE20126, STP20124  
STE1-2104 solid 12 3/4" x 10 3/8" x 4" Tray  
STP1-2102 perforated 12 3/4" x 10 3/8" x 2 1/2" Tray  
STP1-2104 perforated 12 3/4" x 10 3/8" x 4" Tray  
ST13-11-2 Lid Cover: fits trays STE1-2104, STP1-2102, STP1-2104



**Sponge Bowl**

Flat bottom / straight sides /  
extra stable

- ST10-7 64 oz. 7 9/16" x 3"
- ST14-8 48 oz. 7 1/8" x 2 3/4"
- ST10-6 36 oz. 6 1/4" x 2 3/4"
- ST10-0 30 oz. 5 9/16" x 2 9/16"
- ST75 20 oz. 5" x 2 3/8"
- ST52 14 oz. 4 1/4" x 2"

\* "Check Your Measurements",  
These items are FINAL SALE



**Sontec Instrument Fabric Barrier Wrap 2Ply**

- 103-115 18 x 18"
- 103-117 24 x 24"
- 103-119 30 x 30"



**Sontec Forceps Holder**

**Side lock / pin**

- 125-634 2 1/2" x 6" (15.2 cm)
- 125-635 2 1/2" x 8" (20.3 cm)
- 125-636 2 1/2" x 10" (25.4 cm)
- 125-637 2 1/2" x 12" (30.5 cm)
- 125-638 2 1/2" x 16" (40.6 cm)
- 125-639 2 1/2" x 18" (45.7 cm)

**Open U**

- 125-661 2 1/2" x 6" (15.2 cm)
- 125-662 2 1/2" x 8" (20.3 cm)
- 125-663 2 1/2" x 10" (25.4 cm)
- 125-664 2 1/2" x 12" (30.5 cm)

**Center lock / hook**

- 125-666 2 1/2" x 6" (15.2 cm)
- 125-667 2 1/2" x 8" (20.3 cm)
- 125-668 2 1/2" x 10" (25.4 cm)
- 125-669 2 1/2" x 12" (30.5 cm)
- 125-670 2 1/2" x 16" (40.6 cm)
- 125-671 2 1/2" x 18" (45.7 cm)

**Side lock / wide / hook**

- 125-640 2 1/2" x 8" (20.5 cm)
- 125-642 2 1/2" x 10" (25.5 cm)
- 125-644 2 1/2" x 12" (30.5 cm)
- 125-646 2 1/2" x 16" (41 cm)

**Side lock**

- 125-655 5" x 8" (20.3 cm)
- 125-656 5" x 10" (25.4 cm)
- 125-657 5" x 12" (30.5 cm)
- 125-658 5" x 16" (40.6 cm)
- 125-659 5" x 18" (45.7 cm)

**Closed U**

- 125-673 2 1/2" x 6" (15.2 cm)
- 125-674 2 1/2" x 8" (20.3 cm)
- 125-675 2 1/2" x 10" (25.4 cm)
- 125-676 2 1/2" x 12" (30.5 cm)

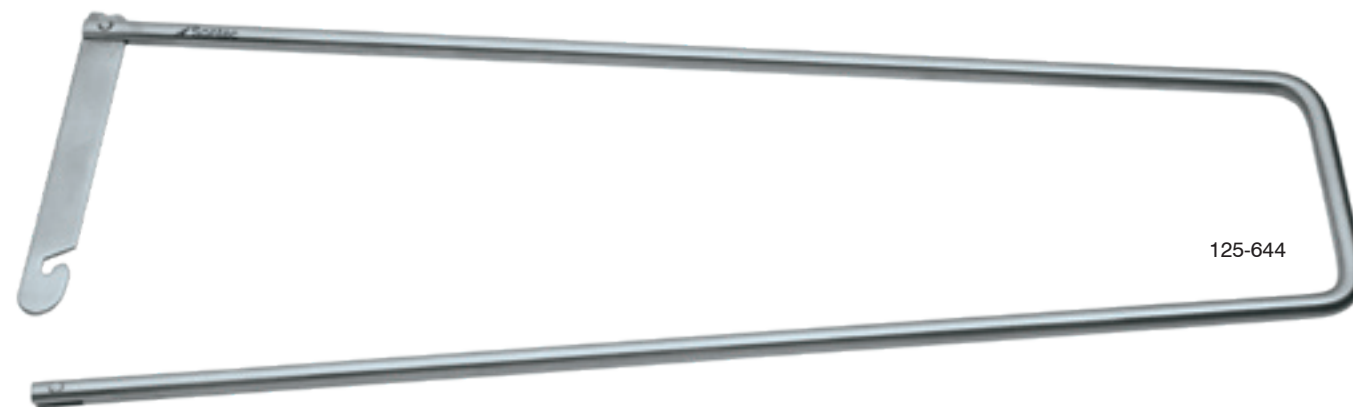

**Stringer Forceps Holder**

**With loop end**

- 127-227 6"
- 127-228 8"
- 127-226 10"
- 127-229 12"



**Bunt Forceps Holder Ring**

**With loop end**

- 1100-788

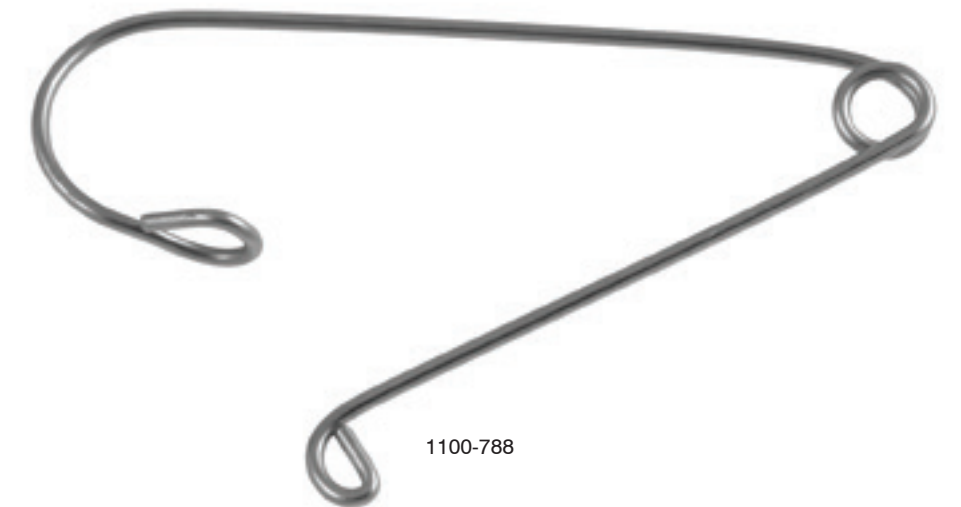

**Needle Boat / Spiral Rack**

**For holding needles**

- 1103-730

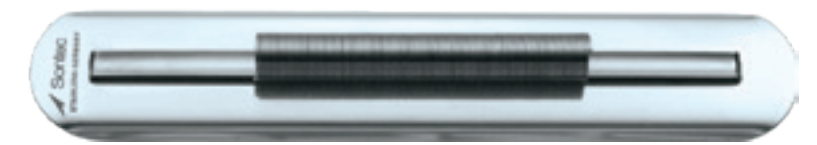

**Tip Cover**

For surgical instrument tip protection / economical & long-lasting / prevents damaging tips and edges / steam-permeable / autoclavable / conveniently color coded / soft vinyl construction, no latex / for a wide variety of instruments, including: scissors, forceps, curettes, drills, and retractors

\* See colors online  
 \* Larger sizes available. Please call for details.  
 \* Individual styles, packaged 100 per bag

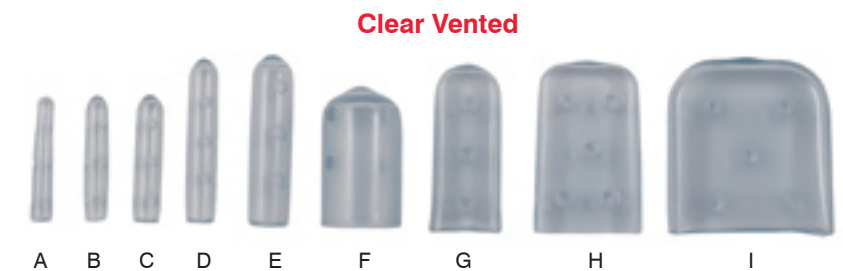
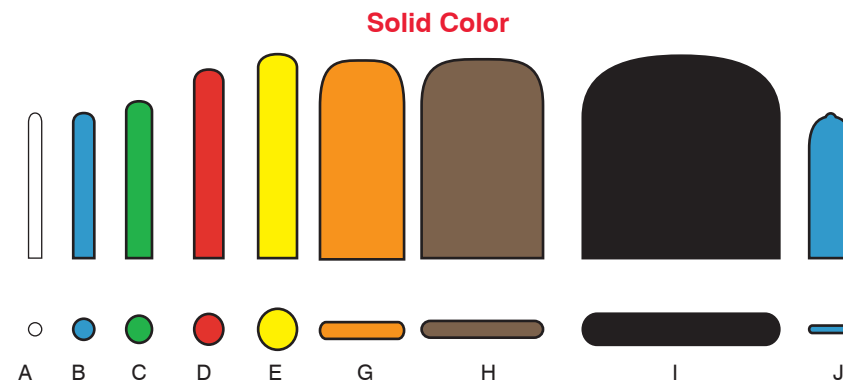

**Individual styles, packaged 100 per bag**

	Color	Solid #	Tinted #
A	White	105-730	105-782
B	Blue	105-732	105-783
C	Green	105-734	105-784
D	Red	105-736	105-785
E	Yellow	105-738	105-786
G	Orange	105-742	105-787
H	Brown	105-744	105-789
I	Black	105-746	105-790
J	Blue	105-764	N/A

**Individual styles, packaged 100 per bag**

	Size	Item #
A	1.6 mm x 19 mm	105-791
B	2 mm x 19 mm	105-792
C	2.8 mm x 19 mm	105-793
D	3 mm x 25 mm x 25 mm	105-794
E	3.2 mm x 25.4 mm	105-7951
F	5 mm x 25 mm	105-796
G	10 mm x 19 mm	105-797
H	2 mm x 9 mm x 25 mm	105-798
I	2 mm x 16 mm x 25 mm	105-799
	Assorted Sizes	105-791A

**Available Assortments**

	Solid #	Tinted #	Clear Vented	Description
Large Assorted	105-748	105-780		Bag of 100, Equal parts A - J
Small Assorted	105-750	105-781		Bag of 100, Equal parts A - E, G, J
Large Assorted			105-791A	Bag of 100 All sizes A - I

**Sontec® Sheet Tape**

For surgical instrument identification / color-codes instruments with pre-cut strips / each 8 1/2" x 11" sheet contains: 44 strips, 2" long x 1/4" wide / 220 strips, 1" long x 1/4" wide (total: 264 strips, 374" of tape)

\* See colors online  
 \* PLEASE NOTE: Sontec® Sheet Tape is not recommended for use with cold sterilization fluids.  
 \* Size and color of tapes may vary slightly from actual products



	105-610 White		105-581 Plum		105-640 Fuchsia
	105-612 Kelly Green		105-540 Blue/Green		105-642 Medical Blue
	105-614 Red		105-541 Blue/Red		105-644 Emerald Green
	105-616 Yellow		105-542 Yellow/Blue		105-646 Violet
	105-618 Orange		105-543 Yellow/Green		105-660 Fuchsia
	105-620 Gray		105-544 Yellow/Red		105-662 Medical Blue
	105-622 Lavender		105-686 Purple/Black		105-664 Emerald Green
	105-624 Beige		105-688 Orange/Black		105-666 Violet
	105-626 Light Blue		105-690 Blue/Black		105-590 Smiley Face, Yellow/Black
	105-628 Lime Green		105-692 Rubine/Black		105-600 Red Hearts on White
	105-630 Pink		105-694 Yellow/Black		105-602 White Hearts on Red
	105-632 Plum		105-696 Green/Black		105-670 Fuchsia*
	105-570 Royal Blue		105-720 Lime Green		105-672 Medical Blue*
	105-571 Kelly Green		105-722 Gray		105-674 Emerald Green*
	105-572 Red		105-723 Beige		105-676 Violet*
	105-573 Yellow		105-724 Light Blue	* Each color sheet contains numbers 0 - 8	
	105-574 Orange		105-725 Pink		105-550 Red/White/Blue
	105-575 Brown		105-726 Plum		105-551 Red/White/Black
	105-576 Black		105-727 Lavender		105-552 Red/Yellow/Black
	105-577 Lavender		105-650 Fuchsia		105-553 Red/Black/Green
	105-578 Light Blue		105-652 Medical Blue	Above Styles: 3/8" wide, 245" total tape	
	105-579 Lime Green		105-654 Emerald Green		
	105-580 Pink		105-656 Violet		







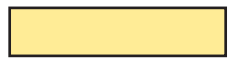

**Medi-Mark™ Tape**

Surgical instrument color coding system / fast and efficient identification system / available in 9 solid colors / one spool codes an average of 230 instruments / clinically proven safe in conventional, flash and gas sterilization / bonds to itself / lasts many months

\* PLEASE NOTE: Medi-Mark™ Tape is not recommended for use with cold sterilization fluids.  
\* See colors online

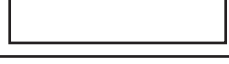
**Application of Medi-Mark™ Tape**

1. Instrument and hands must be clean and dry.
2. Cut Medi-Mark™ Tape with scissors. DO NOT STRETCH!
3. Overlap Medi-Mark™ Tape once.
4. Replace Medi-Mark™ Tape when color changes, before it becomes brittle.
5. Avoid placing Medi-Mark™ Tape on the shank of scissors.

	105-700 Green
	105-702 Yellow
	105-704 Blue
	105-706 Red
	105-708 Brown
	105-710 White
	105-712 Orange
	105-714 Black
	105-716 Purple

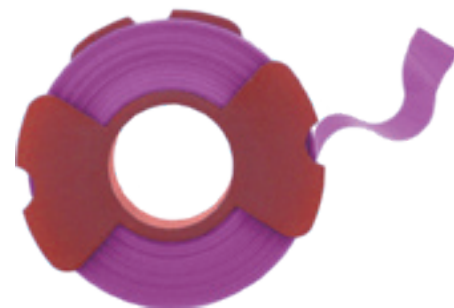
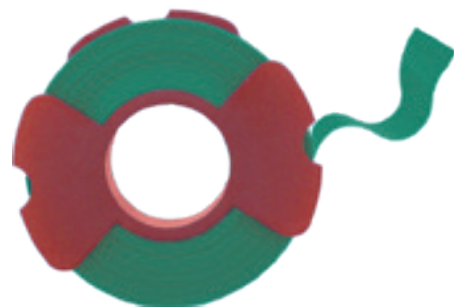

**Whisk 'R Brush™**

For general purpose cleaning / two bristle lengths & a sure-grip handle / available sterile & non-sterile / convenient & economical / simple to use on various shapes and surfaces / for a wide variety of instruments, including: burrs, drill points, rasps, and rongeurs / easily removes bone fragments and soft tissue

- 9B-010 12 sterile brushes
- 9B-025 25 non-sterile brushes
- 9B-020 100 non-sterile brushes





 Sontec Instruments®

KNIFE & BLADE Handles

**Knife Handle #3**

Fits surgical blades 10-15 / with calibrated scale

\* surgical blade not included

1100-740 5" (12.5 cm)



Round handle

1100-741 6" (15 cm)

1100-740



1100-741

Round knurl handle / double / 1 mm / 6 1/4"

1100-7411



1100-7411

**Wide Barrel Grip Knife Handle #3**

Round knurled / straight / 5" (12.7 cm)

117-577



117-577

**Universal Adjustable Angle Knife Handle #3**

Adjustable tip & lock / straight / 10 mm locking increments of 7 positions / 6 1/2" (16.5 cm)

117-578 vertical adjusting

117-5781 horizontal adjusting



117-578



117-5781

**Knife Handle #3L**

Fits surgical blades 10-15

1100-866 8 1/2" (21.5 cm)

1100-868 12" (30 cm)

117-582 8 3/8" (20 cm) angled

1100-866



117-582



**Staley Round Knurled Knife Handle**

Aluminum / 6" (15.2 cm)

117-571



117-571

**Sontec Knife Handle #3XXL**

16" (40.6 cm)

1100-8681



**Knife Handle #3KL**

Round handle / 6" (15.2 mm)

117-564



**Beaver® Blade Chuck Handle #3K**

Fits Beaver® style blades

117-560 4" (10 cm)

T117-560 4" (10 cm) titanium

117-561 3" (7.5 cm)

117-560



T117-560



**Beaver® Blade Chuck Handle**

Fits Beaver® style blades

117-559



117-559



 Sontec Instruments®

ENT KNIVES

**Nasal/Tendon Knife**

5 1/2" (14 cm)

1271-165 single edge 30 mm blade str

6 1/2" (16.5 cm)

1271-175 single classic edge 23 mm blade str  
 1271-180 single lance edge 23 mm blade str  
 1271-152 double lance edge 24 mm blade str  
 1271-181 single retrograde edge 36 mm blade cvd



1271-165

1271-175

1271-180

1271-152

1271-181

**McIlwraith Tendon Knife**

6 1/2" (16.5 cm)

1271-160 single edge 40 mm blade  
 1271-153 double edge 45 mm blade



1271-160

1271-153

**Tendon Knife**

Single side / 30 mm blade / sharp point / 6" (15.2 cm)

1271-163



1271-163

**Joseph Nasal/Tendon Knife**

6" (17 cm)

1271-152C curved  
 1271-152B blunt  
 1271-152D round tip



1271-152C

1271-152B

1271-152D

**McIlwraith Bistouri Knife**

**Button end blade**

1271-156C	curved	35 mm	6" (15 cm)
1271-156	straight	35 mm	6" (15 cm)
1271-155	curved	55 mm	7" (18 cm)
1271-154	straight	55 mm	7" (18 cm)



1271-156C



1271-156

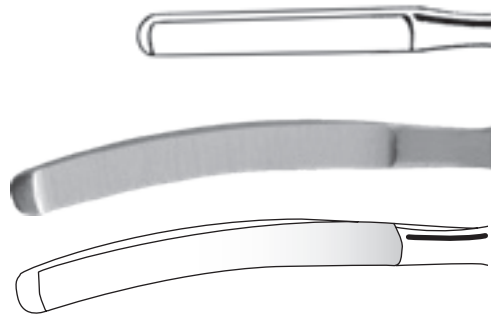

1271-155



1271-154

**Tendon Knife**

**6" (17 cm) / double Sided / 21mm blade**

1271-151	curved
----------	--------



1271-151

**Sexton-Gerzog Ear Knife**

**6 3/4" (17.1 cm)**

467-450	straight shaft
467-452	bayonet shaft
467-454	angle shaft



467-452

**Politzer Ear Knife**

**7 1/4" (18 cm)**

467-458	straight shaft
467-460	bayonet shaft
467-462	angled shaft



467-462



467-460

**Sickle Knife**

**6 1/4" (16 cm)**

467-461	straight	small blade 3 x 1mm
467-465	light curve	
467-467	straight	



467-461



467-465



467-467

**Fisher Tonsil Knife**

**Serrated blade / 9" (22.9 cm)**

485-675
---------



485-675

**Cottle Mucosa Knife**

**6" (15 cm)**

412-559
---------



412-559

**Rosen Circular Blade Dissector**

6 1/4" (15.9 cm) / 45° angle tip

- 412-455 1.0 mm
- 412-456 1.4 mm
- 412-457 1.6 mm
- 412-458 2.0 mm
- 412-459 2.6 mm
- 412-460 2.8 mm
- 412-461 3.0 mm

6 1/4" (15.9 cm) / 90° angle tip

- 412-462A 1.5 mm
- 412-462B 2.0 mm
- 412-462C 2.5 mm
- 412-462D 3.0 mm



412-460

**Plester First Incision Knife**

6 1/4" (16 cm)

467-463



467-463

**Buck Myringotomy Knife**

6" (15 cm)

- 467-464
- 467-464A 90° angle



467-464

**Freer Mucosa Knife**

6 1/4" (16 cm)

345-405



345-405

**Jacobson Knife**

Micro blade / 6 1/2" (16.5 cm)

400-418



400-418

**Pashley Knife Set**

Curved blade / 6 3/4" (17 cm)

- 1467-456 straight
- 1467-460 angled right
- 1467-458 angled left



side view

1467-458



side view

1467-460



side view

1467-456

**Yasargil Arachnoid Knife**

7 1/4" (18.5 cm)

- 400-426 full curved
- 400-427 partial curved bayonet



400-426



400-427

**Yasargil Bayonet Arachnoid Knife Titanium**

7 1/4" (18.5 cm)

- 400-427T curved down
- 400-4271T curved up



400-427T



400-4271T

**Ballenger Swivel Knife**

7 1/4" (18.5 cm)

- 467-5303 straight 3 mm
- 467-5304 straight 4 mm
- 467-5305 straight 5 mm

8 3/4" (22 cm)

- 467-5313 bayonet 3 mm
- 467-5314 bayonet 4 mm
- 467-5315 bayonet 5 mm



swivel end

467-5304

**Ballenger Bayonet Swivel Knife**

3 mm / 7 1/4" (18.5 cm)

467-534T



467-534T

**Joseph Tendon Knife**

6 1/2" (16.5 cm)

- 345-400 single edge 60° angled



345-400

**Joseph Nasal Knife**

Button end / straight / 6" (15 cm)

345-402



345-402

**Blair Skin Graft Knife**

W/ thickness gauge

- 199-600 6" (15 cm)
- 199-602 4" (10 cm)

Blades

- 199-604 blades for 6" (15 cm)
- 199-606 blades for 4" (10 cm)

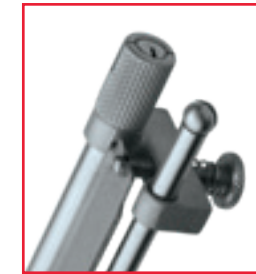

199-600



199-604

**Skin Holding Plate**

4, 5, 8, 10 cm

475-950

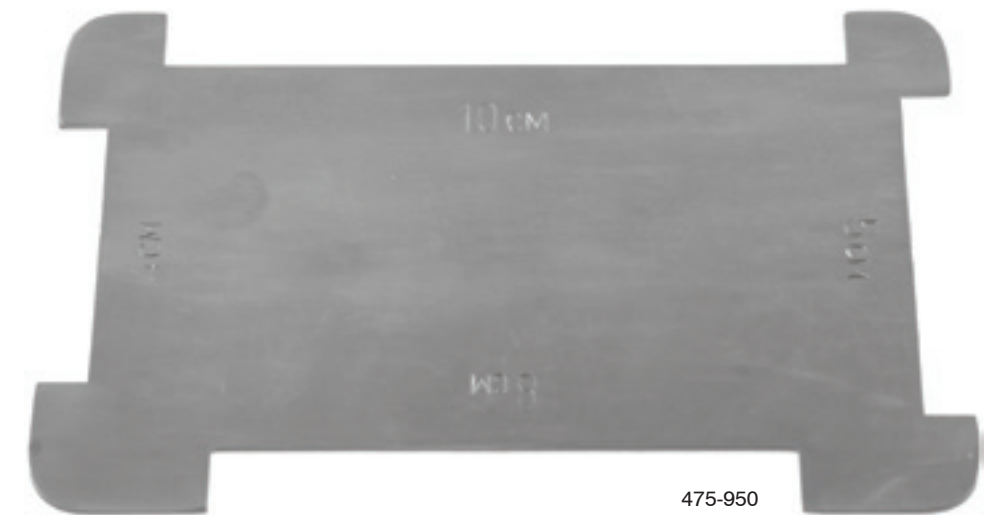

475-950



 Sontec Instruments®

CALIPERS & RULERS

**Castroviejo Caliper**

Scale to 20 mm / 3 1/2" (9 cm)

12-9300	str	
T12-9300	straight	titanium
12-9305	angled 45°	
12-9310	cvd	
12-9315	angled	
12-9316	straight	40 mm scale
12-9318	angled	40 mm scale

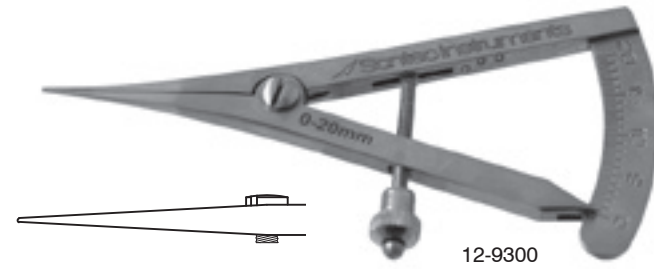

12-9300

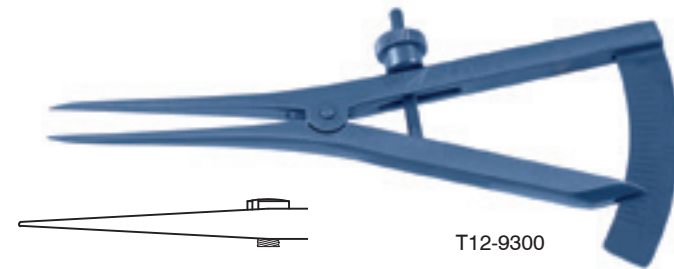

T12-9300



12-9305

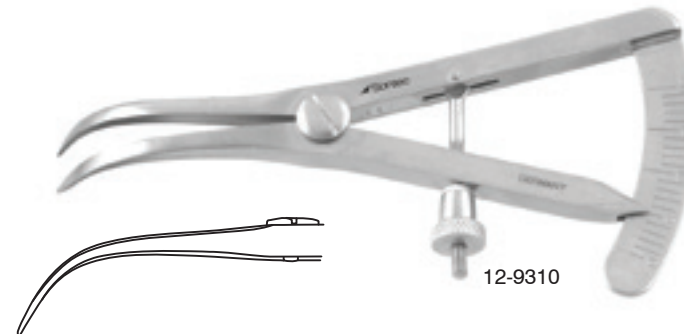

12-9310

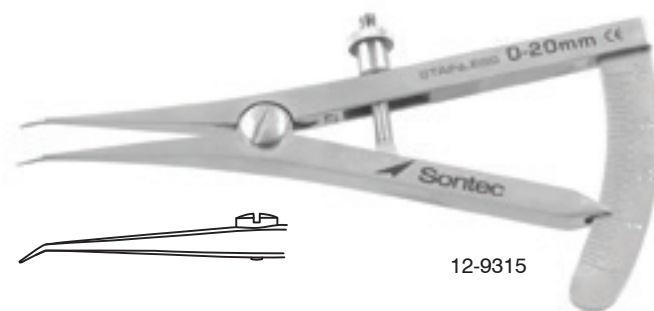

12-9315

**Jameson Caliper**

Scale to 3" (8 cm)

12-9450



12-9450

**Thorpe Caliper**

Scale to 3" (8 cm) /  
angled / markings in  
0.5 mm increments

12-9400



12-9400

**Orthopedic Vernier Caliper**

Stainless steel / 6" (15.5 cm)  
1103-170

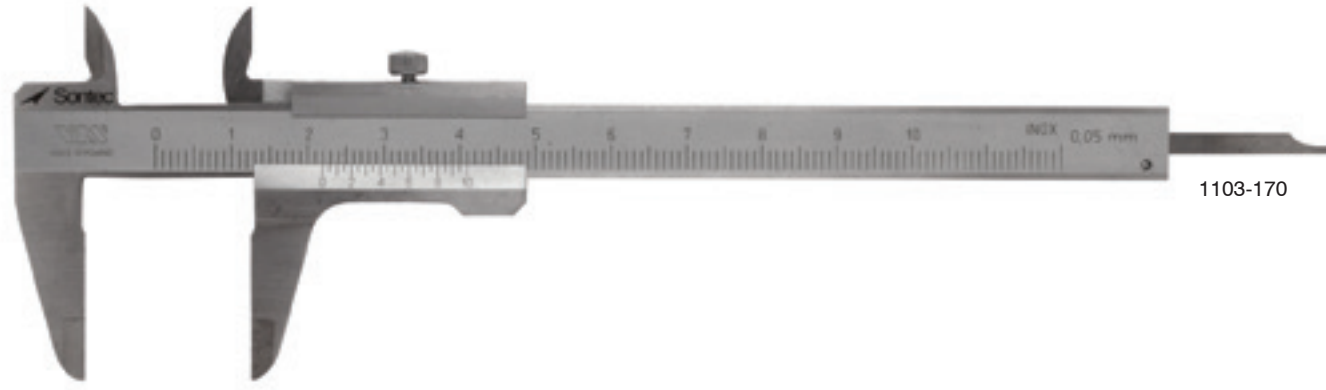

1103-170

**Punched Hole Gauge Ruler**

7" (18 cm) in length  
1106-190

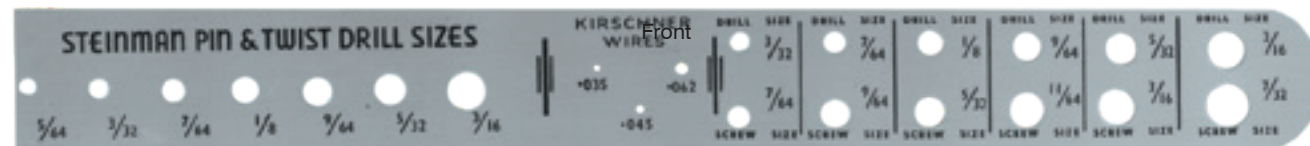
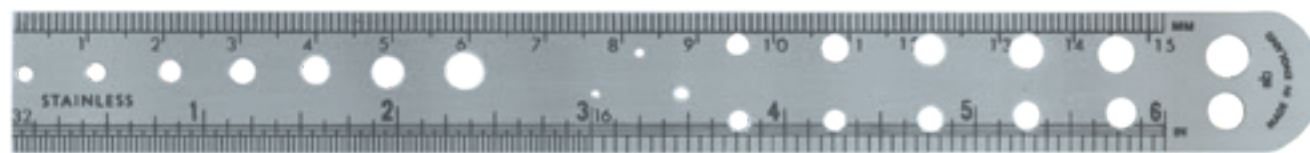

Back

1106-190

**Schiotz Tonometer**

Autoclavable / original model  
18-8301 incline scale

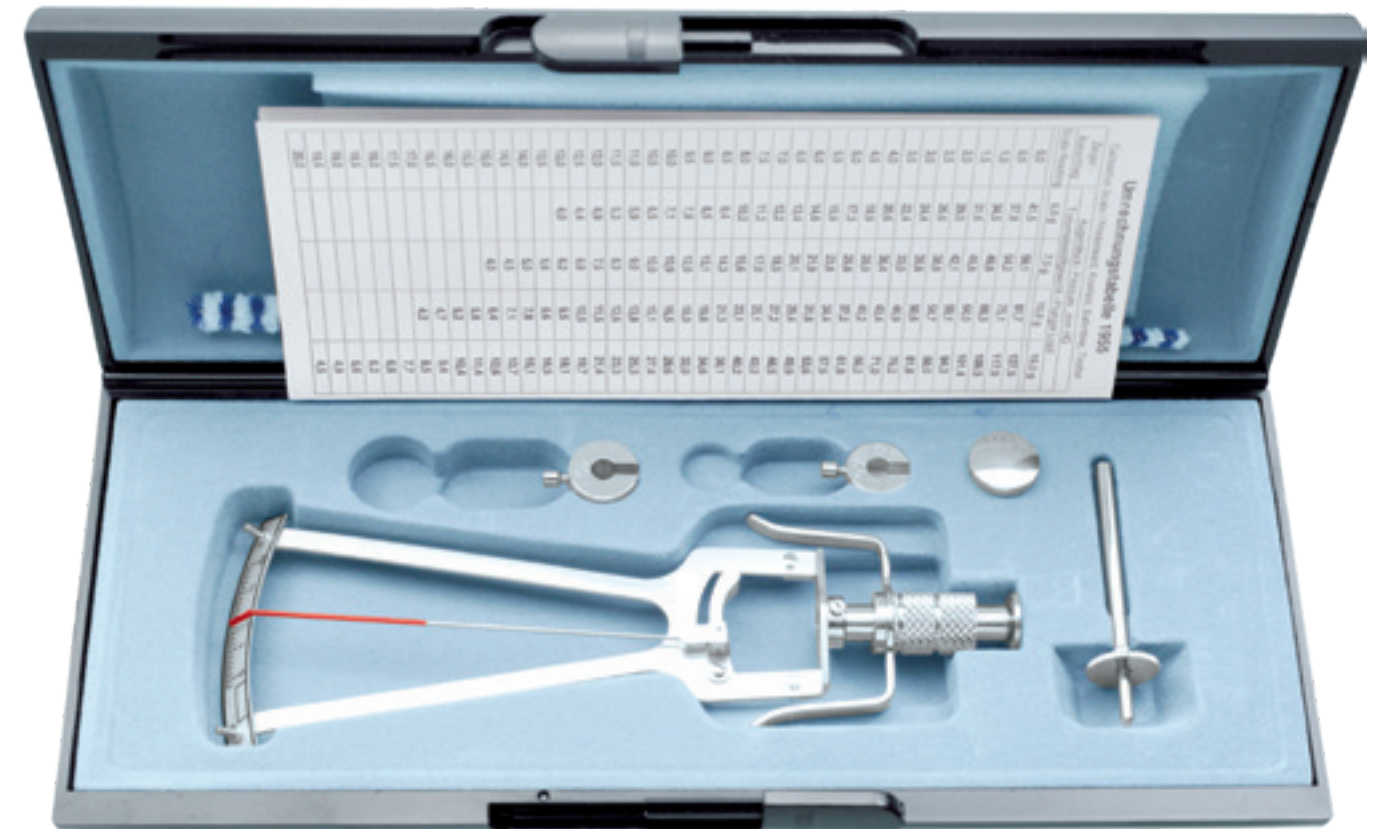



 Sontec Instruments®

Abdominal RETRACTORS

**CSU Pediatric Balfour Retractor**

**Fenestrated side blades / double bar**

1100-611-SET 4" (10 cm) spread  
 1100-611B-SET 7" (18 cm) spread

\* Modifications possible please call for details

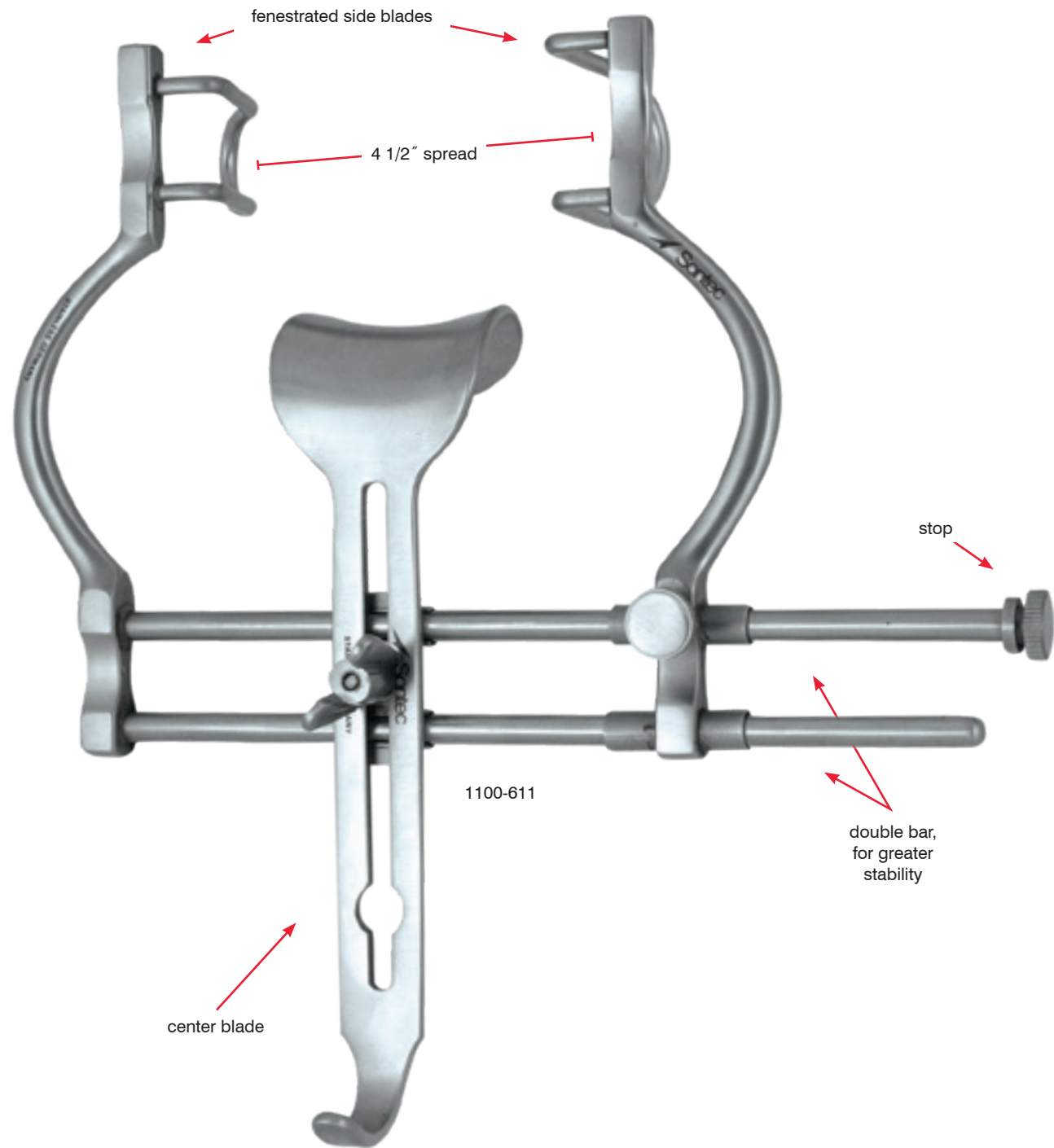

**CSU Pediatric Balfour Retractor**

**Fenestrated side blades / single bar**

1100-612 3 1/2" (9 cm) spread  
 1100-613 6" (15 cm) spread

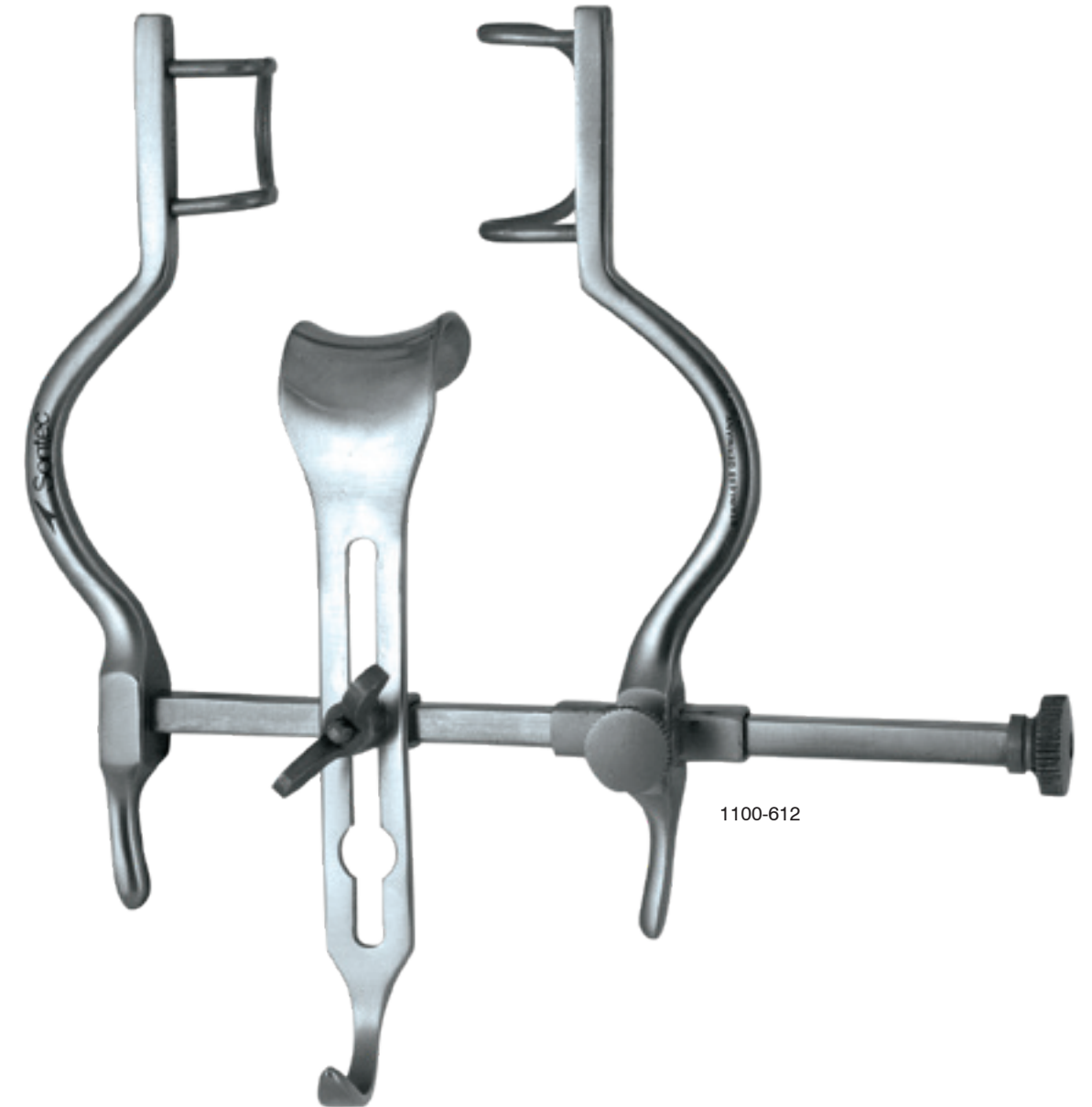

**CSU Pediatric Balfour Retractor**

Fenestrated side blades, 4.5 cm x 4.5 cm / double bar

1100-611C-SET 7" (18 cm) spread

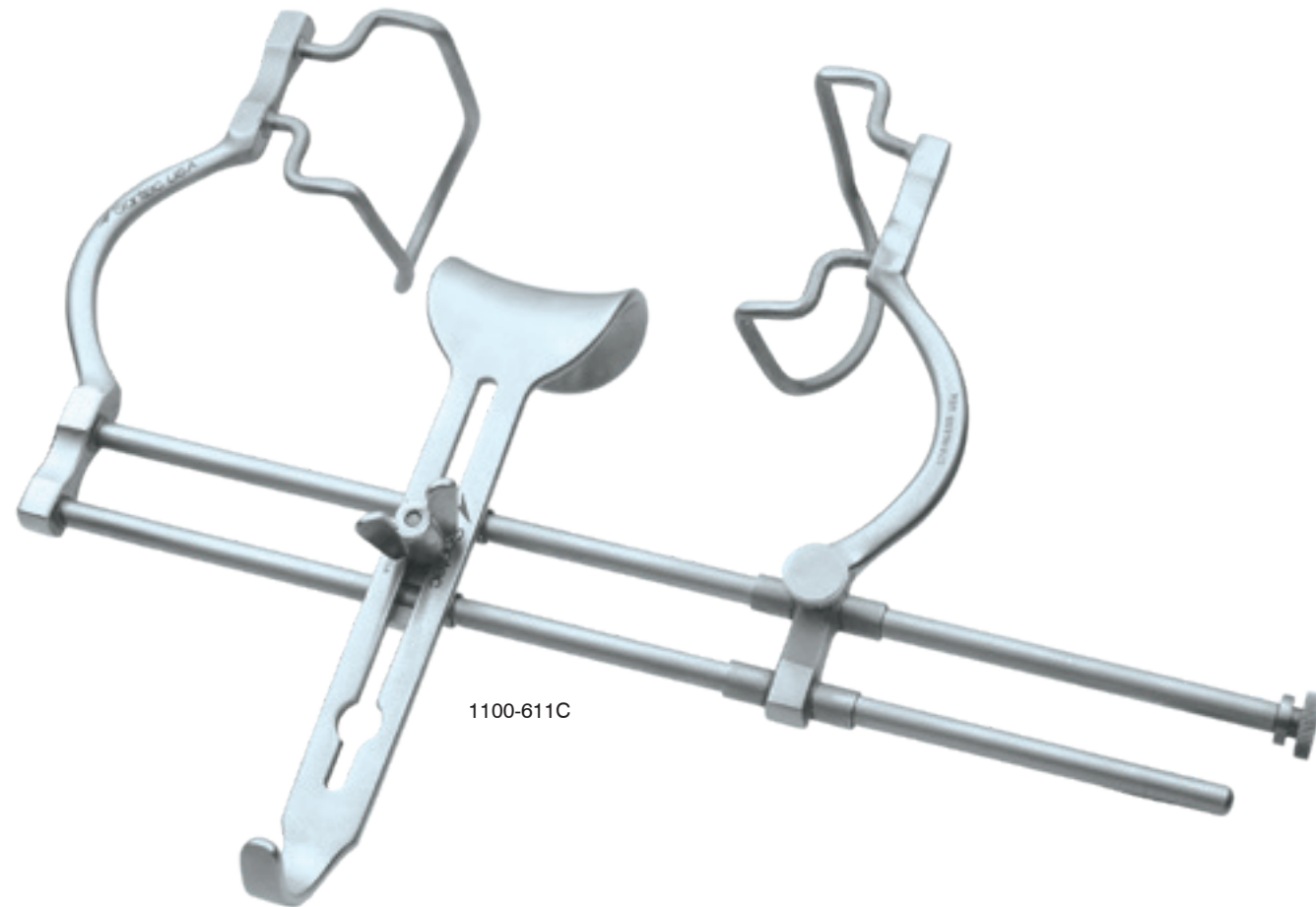

**CSU Adolescent Balfour Retractor**

Single bar / fenestrated / side blades

1100-610-SET 7 1/2" (19 cm) spread

\* Modifications possible please, different center blades available, call for details

a	b	c	d
2 in 50 mm	1 in 25 mm	7.5 in 190 mm	5.5 in 140 mm

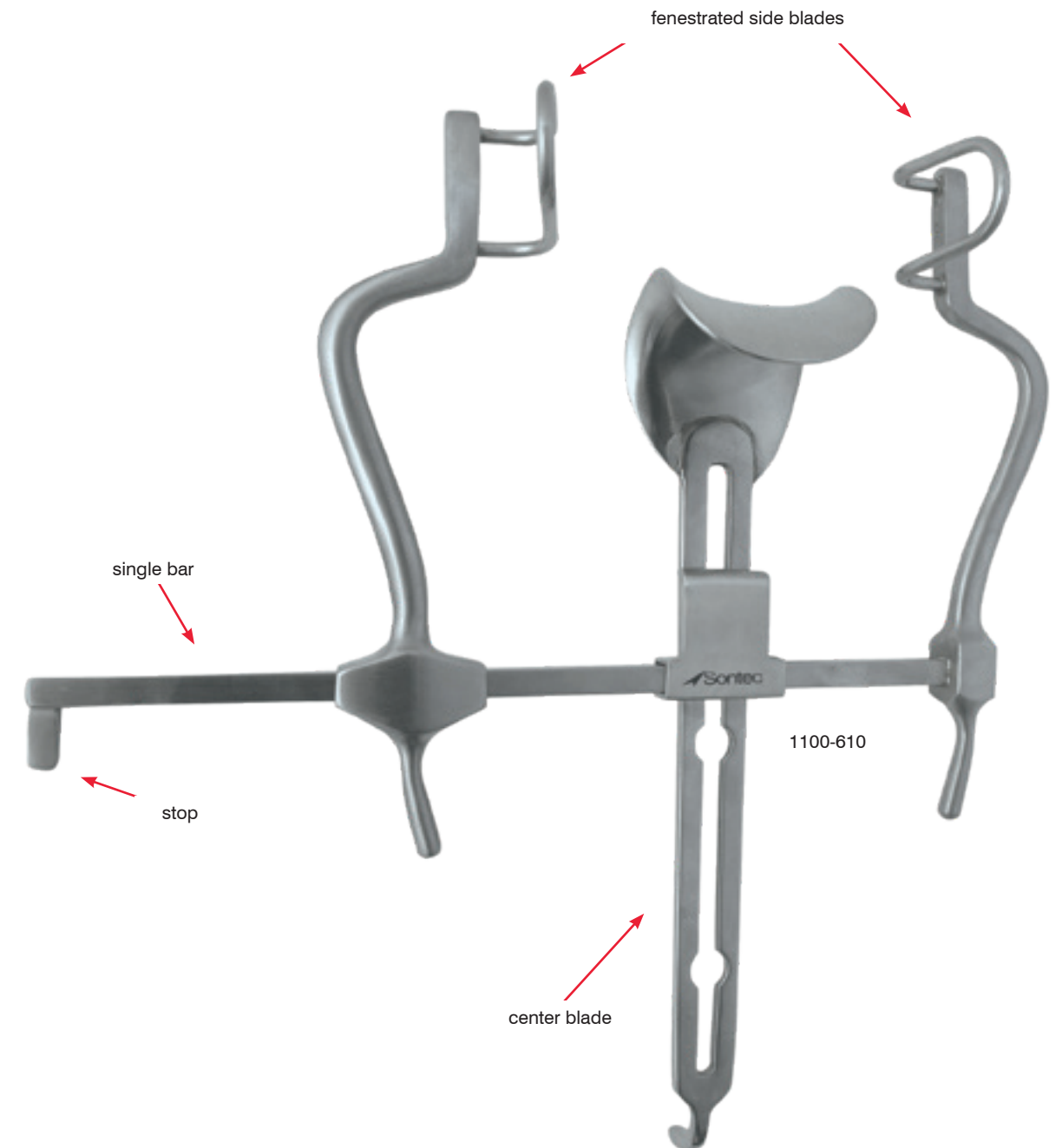
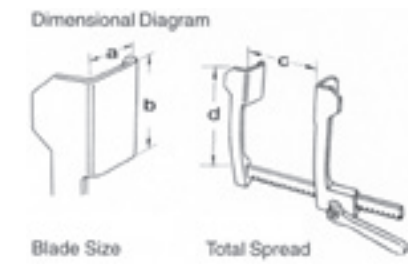

**Deluxe Balfour Retractor**

Double bar / interchangeable, fenestrated / side blades / ratchet locking frame

- 1100-627-SET 8 1/2" (22 cm) spread
- 1100-614-SET 10 1/2" (26 cm) spread
- 1100-609-SET 14" (36 cm) spread

**Available Side Blades**

- 9-5201 2 1/2" long
- 9-5203 3 1/2" long

\* Different center blades available, call for details

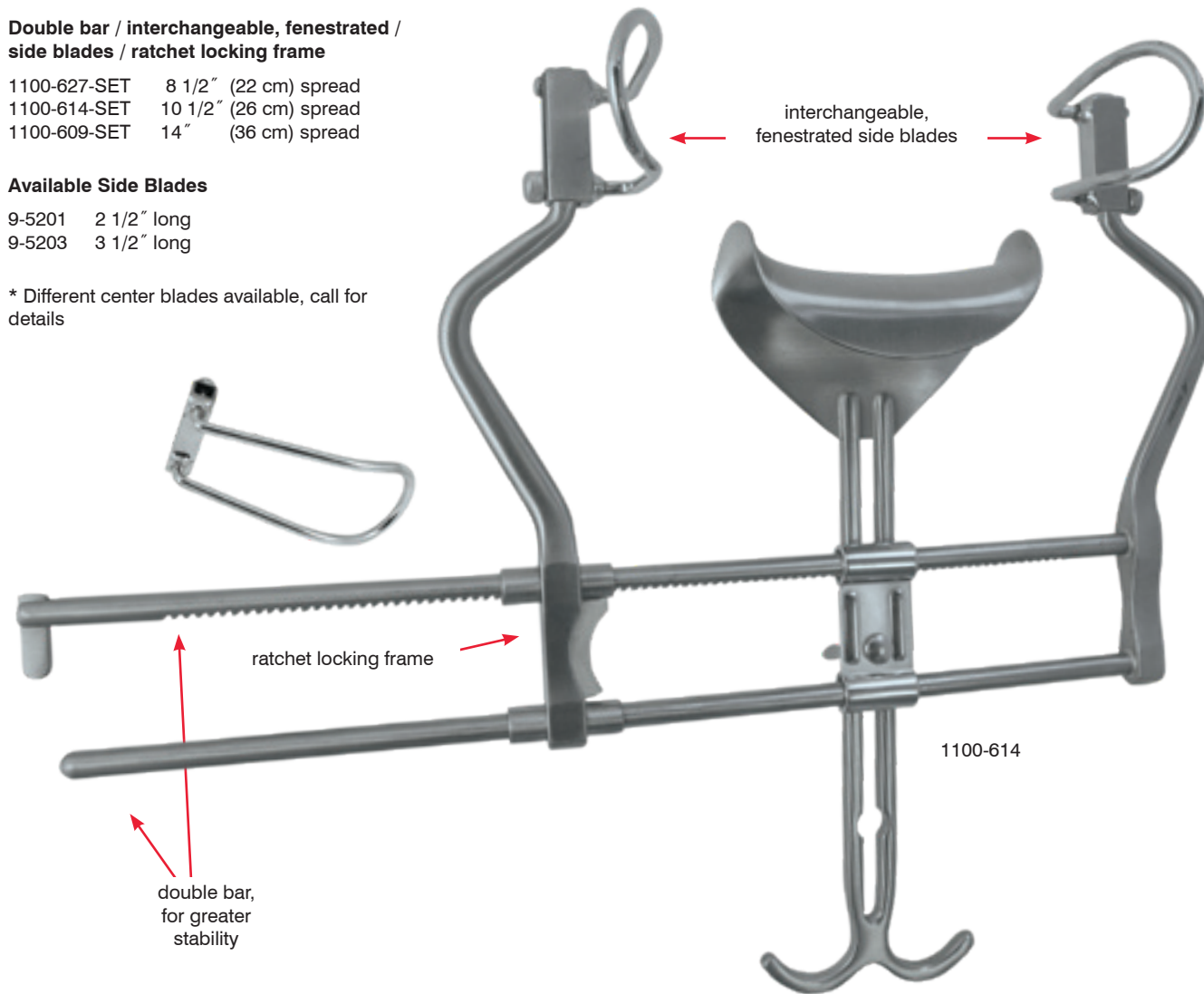

**Balfour Malleable Blade**

With protected edge / fits all Balfour Retractors

- 9-12019-BH 1 1/2" x 6"
- 9-12015-BH 2" x 6"



**Balfour Retractor**

Double bar / fenestrated / side blades

- 1100-606-SET 7" (18 cm) spread
- 1100-607-SET 9" (23 cm) spread
- 1100-6071-SET 10 1/2" (26 cm) spread

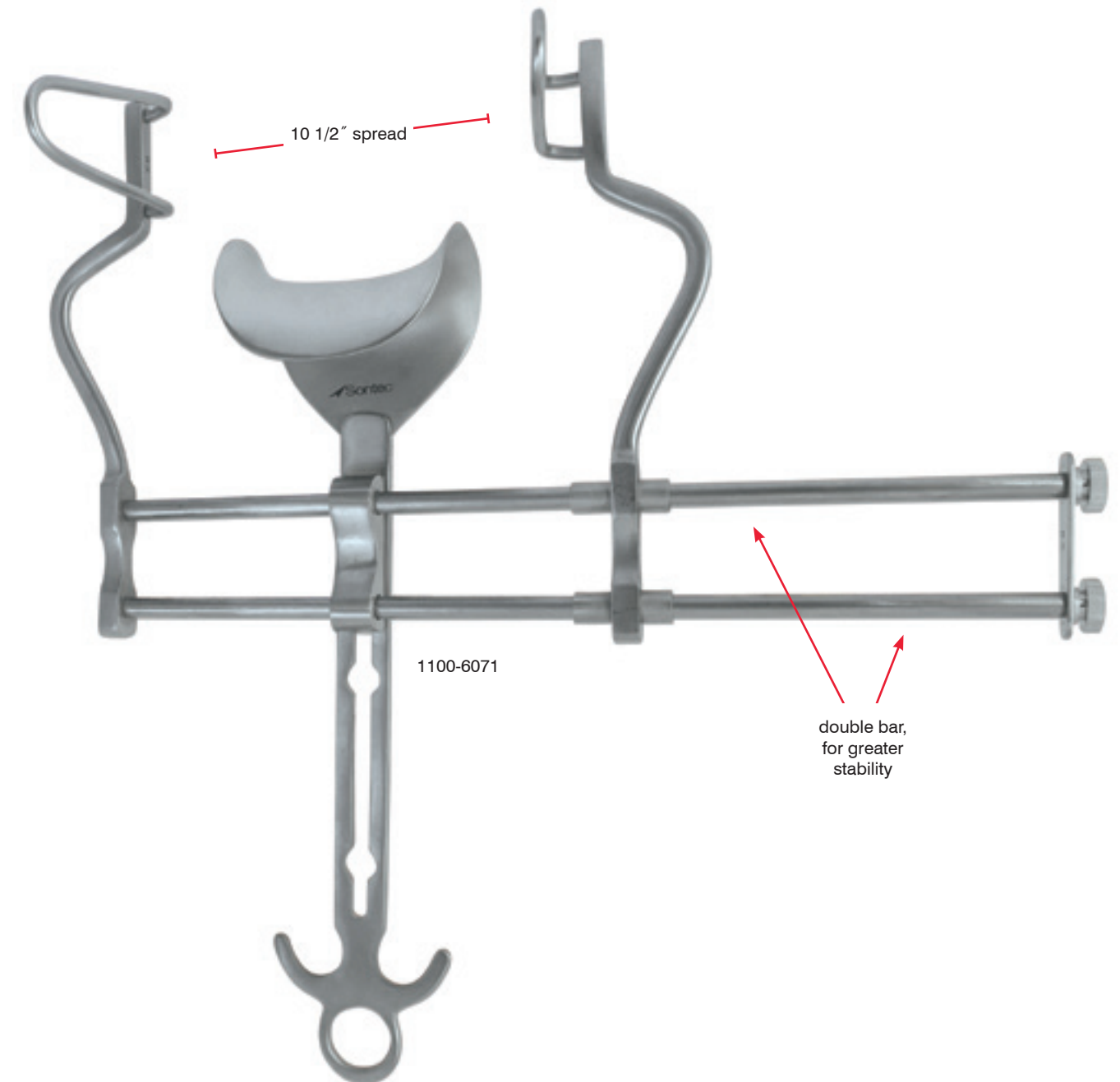



 Sontec Instruments®

Cardiovascular RETRACTORS

**Finochietto-Baby-Haight Rib Spreader Retractor**

Stainless steel

2500-131 child size

a	b	c	d
28 mm	30 mm	100 mm	75 mm

2500-131L child size extended rack

a	b	c	d
28 mm	30 mm	100 mm	165 mm

Dimensional Diagram

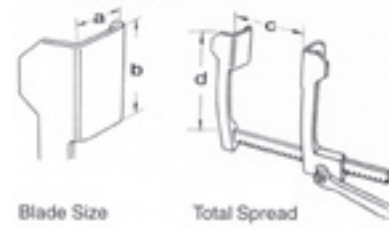

2500-131

**Baby Finochietto Retractor**

3 1/4" (8 cm) spread

1101-554 3/4" x 3/4" blades



1101-554

**Mini Finochietto Retractor**

2 1/2" (6.5 cm) spread

1101-523 7 mm blades



1101-523

**Finochietto Retractor**

**Small / 1 3/4" x 1 3/4" blades**

1101-524 6" (15 cm) spread

**Medium / 1 3/4" x 2 1/2" blades**

1101-526 8" (20 cm) spread

1101-528 10" (25 cm) spread

1101-530 12" (30 cm) spread

**Large / 2 3/4" x 2 1/2" blades**

1101-532 8" (20 cm) spread

1101-534 10" (25 cm) spread

**Large / 2 3/4" x 2" blades / curved arms**

1101-536 12" (30 cm) spread



1101-526

**Shanghai Neonatal Finochietto Retractor**

**Swivel blades**

2500-206 mini neonatal size curved arms

2500-207 neonatal size curved arms

2500-208 neonatal size

Item	a	b	c	d
2500-206	5 mm	13 mm	25 mm	40 mm
2500-207	10 mm	30 mm	70 mm	70 mm
2500-208	10 mm	30 mm	70 mm	70 mm

Dimensional Diagram

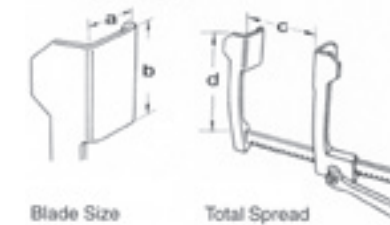

Shanghai Finochietto Retractor, swivel blades



2500-206

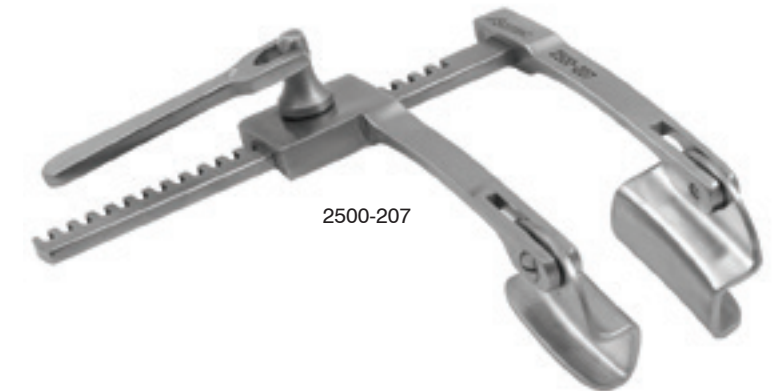

2500-207



2500-208

**Finochietto Rib Spreader Retractor**

Infant / 3" (7.96 cm)

2500-096

a	b	c	d
20 mm	20 mm	70 mm	58 mm



2500-096

**Baby Farabeuf Retractor**

Double-ended / set of 2

207-268 4 1/4"

207-269 4 1/2"



**Farabeuf Retractor**

Double-ended / set of 2

207-275



207-275

**Roux Retractor**

Double-ended / 7"

207-261-SET includes: small, medium & large

207-263 small (21 mm x 29 mm)

207-265 medium (26 mm x 37 mm)

207-267 large (31 mm x 45 mm)



**Alm Retractor**

1/8" deep prongs / 2  
3/4" (7 cm) spread / 2  
3/4" (7 cm) in length

230-380

1/2" deep prongs / 3"  
(7.5 cm) spread / 4"  
(10 cm) in length

230-385



**Sontec Cross-Action Retractor**

Self-retaining / 4" (10 cm)

230-390 sharp  
230-392 blunt



**Stevenson Self-Retaining Retractor**

3 x 3 prongs / 3 1/2" (9 cm)

10-5500



**Strong Weitlaner Retractor**

3 1/2" (9 cm)

2500-336 4 x 4 prongs

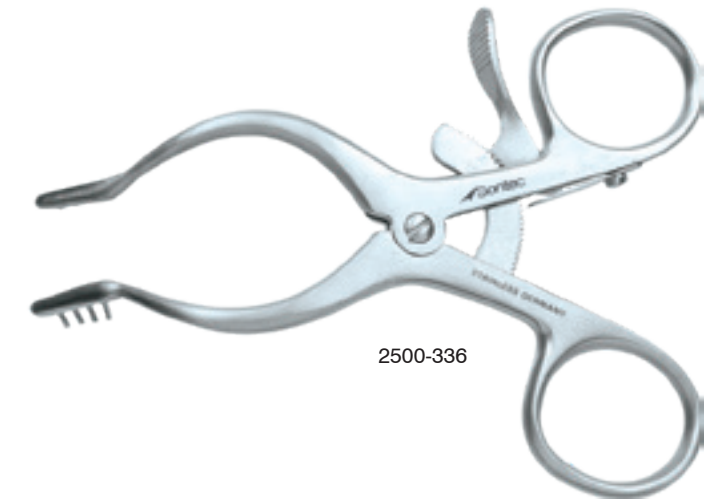

**Micro Weitlaner-Henley Retractor**

4 3/4" (12 cm) / with locking third arm / #2 blade

230-511 2 x 2 prongs

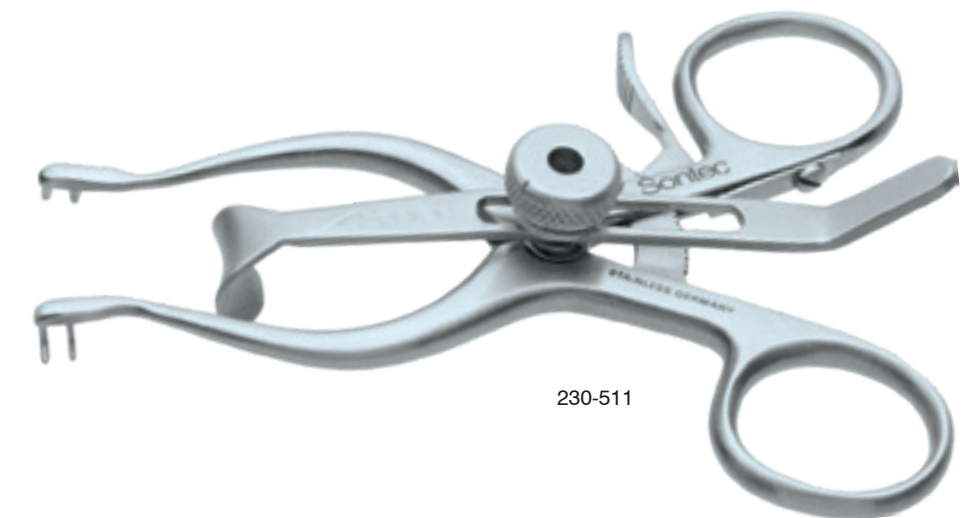

**Parsonnet Epicardial Retractor**

**3 x 3 sharp prongs**

- 2500-340 small
- 2500-345 medium
- 2500-349 large



2500-340



2500-345



2500-349

**Titanium I.M.A. Epicardial Retractor**

- 47 mm
- 2500-347T

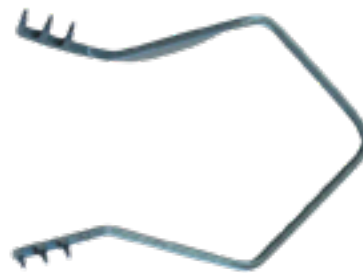

2500-347T

**Finochietto Retractor**

**6 1/2" (16.5 cm) spread**

- 1101-500 3/4" x 1" blades
- 1101-502 1 1/8" x 1 1/4" blades
- 1101-504 1 1/16" x 1 3/4" blades
- 1101-506 1 7/8" x 1 3/4" blades

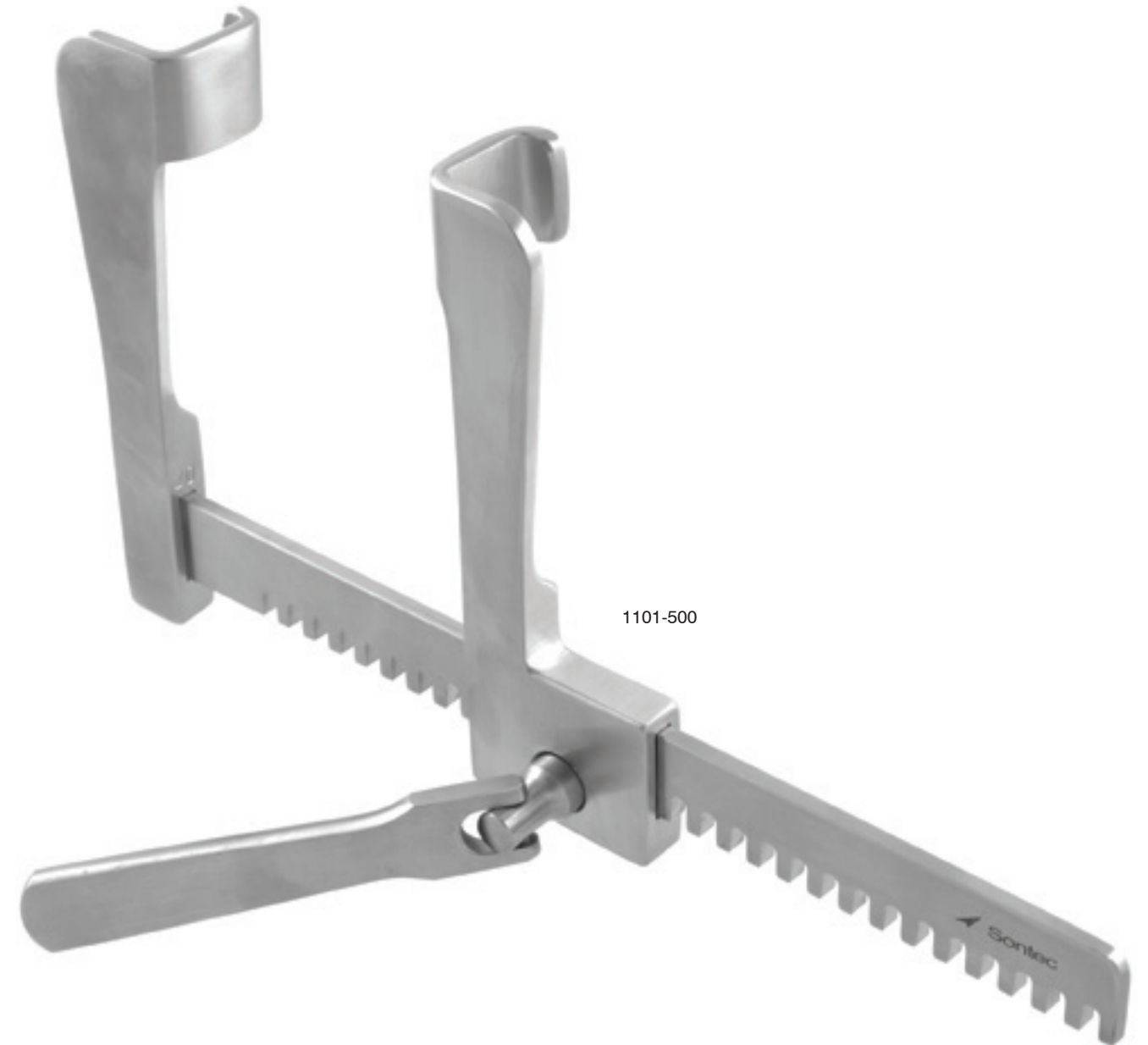

1101-500



 Sontec Instruments®

Cardiovascular CLAMPS

**Atraumatic Pediatric Vascular Clamp**

Very delicate v-jaws / 6" (15 cm)

- 2100-008 65° double angle
- 2100-010 35° double angle

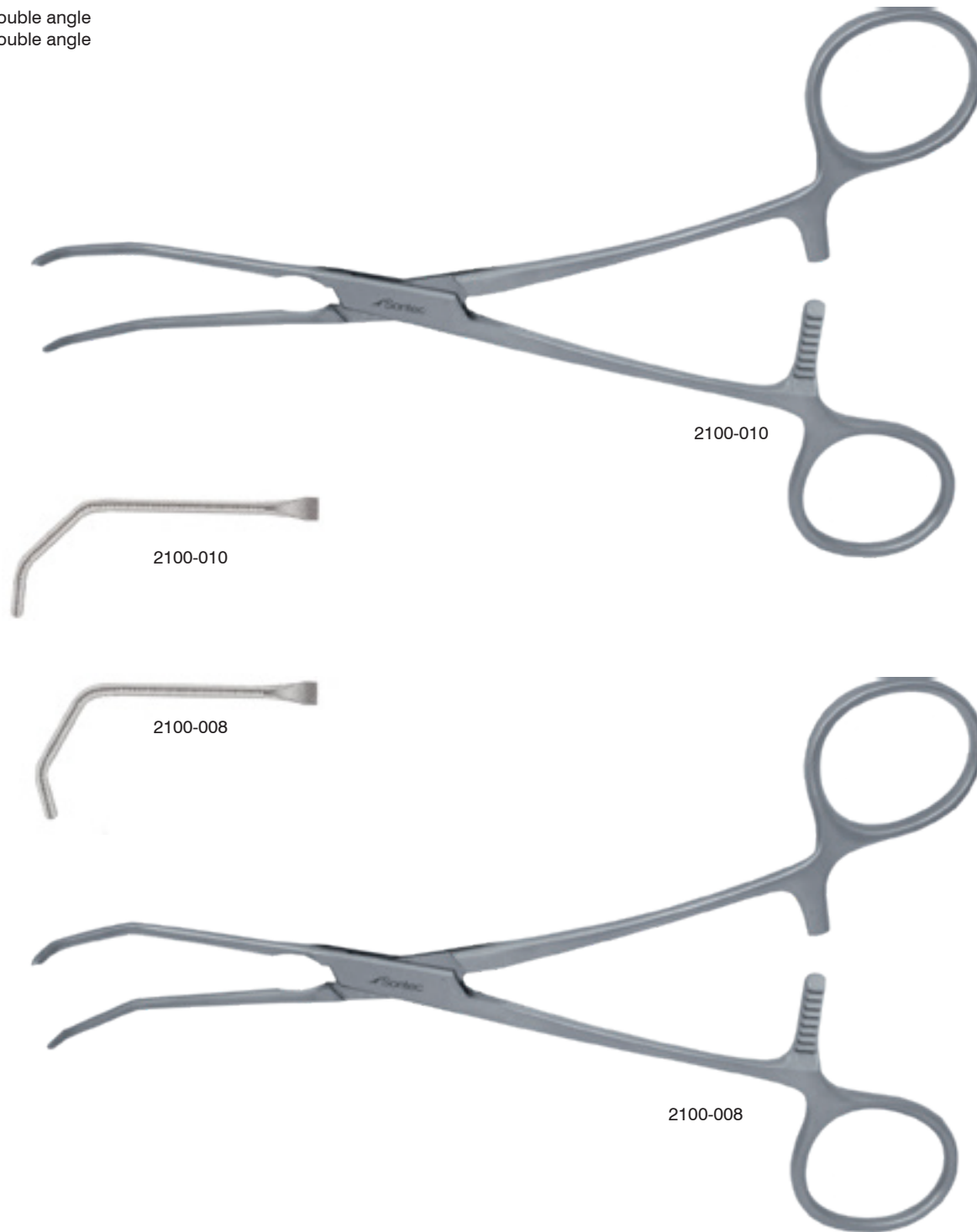

**Atraumatic Pediatric Vascular Clamp**

Very Delicate V-jaws

- 2100-015 straight 5 1/4" (13.3 cm)
- 2100-017 20° angle 5 1/4" (13.3 cm)
- 2100-019 30° angle 5 1/8" (12.7 cm)
- 2100-021 60° angle 5" (12.5 cm)
- 2100-023 slight curve 5 1/4" (13.3 cm)
- 2100-025 double angle 4 3/4" (12.1 cm)
- 2100-027 double angle 4 3/4" (12.1 cm)
- 2100-029 strong curve 5 1/8" (12.7 cm)
- 2100-031 full curve 5" (12.5 cm)

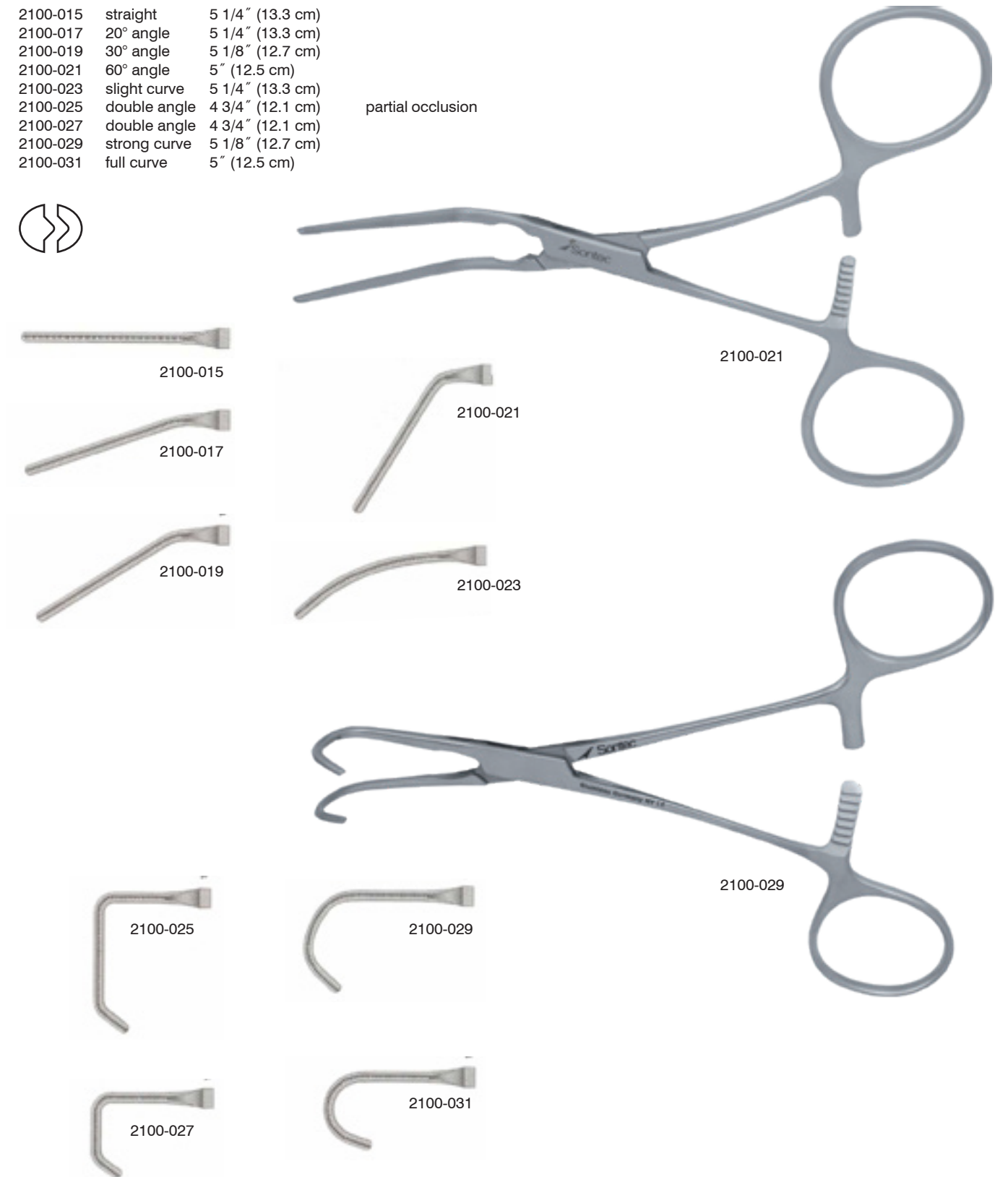

**Atraumatic Pediatric Vascular Clamp**

**Very Delicate V-jaws**

2100-035	straight	5 3/4" (14.6 cm)	
2100-037	20° angle	5 3/4" (14.6 cm)	
2100-039	30° angle	5 1/2" (14 cm)	
2100-041	60° angle	5 1/8" (12.7 cm)	
2100-043	slight curve	5 1/2" (14 cm)	
2100-045	double angle	5 1/8" (12.7 cm)	
2100-047	double angle	5 1/8" (12.7 cm)	partial occlusion
2100-049	strong curve	5 1/4" (13.3 cm)	full
2100-051	full curve	5 1/2" (14 cm)	strong

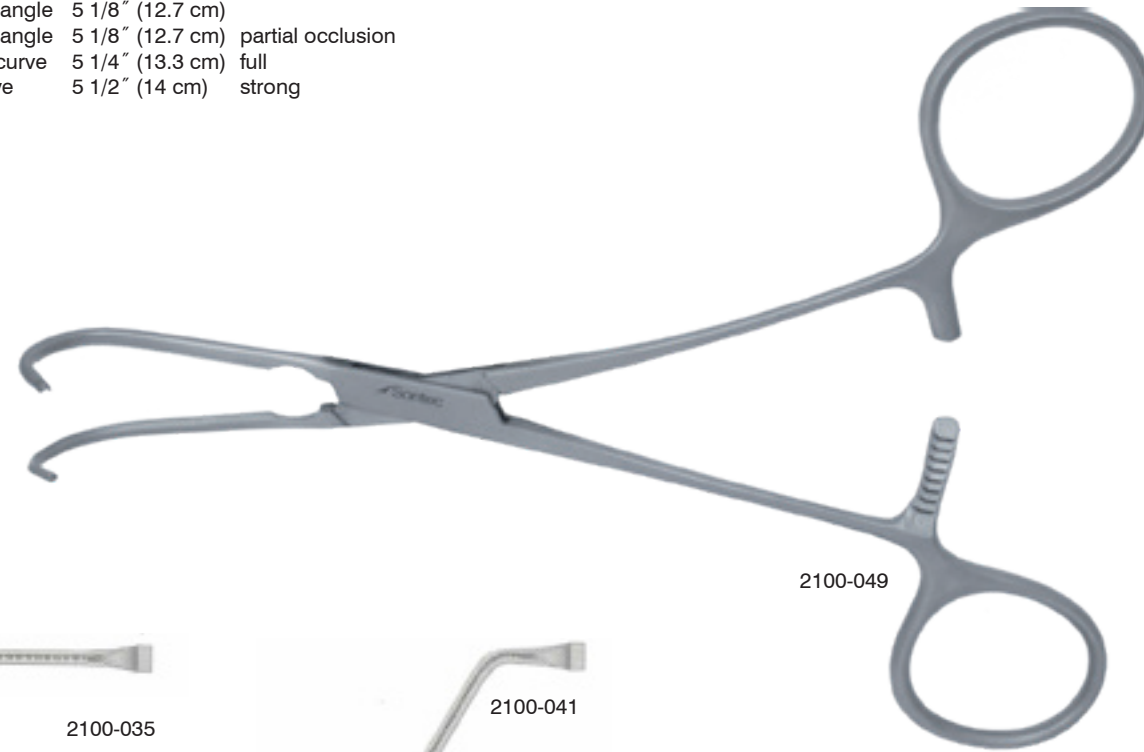

2100-049

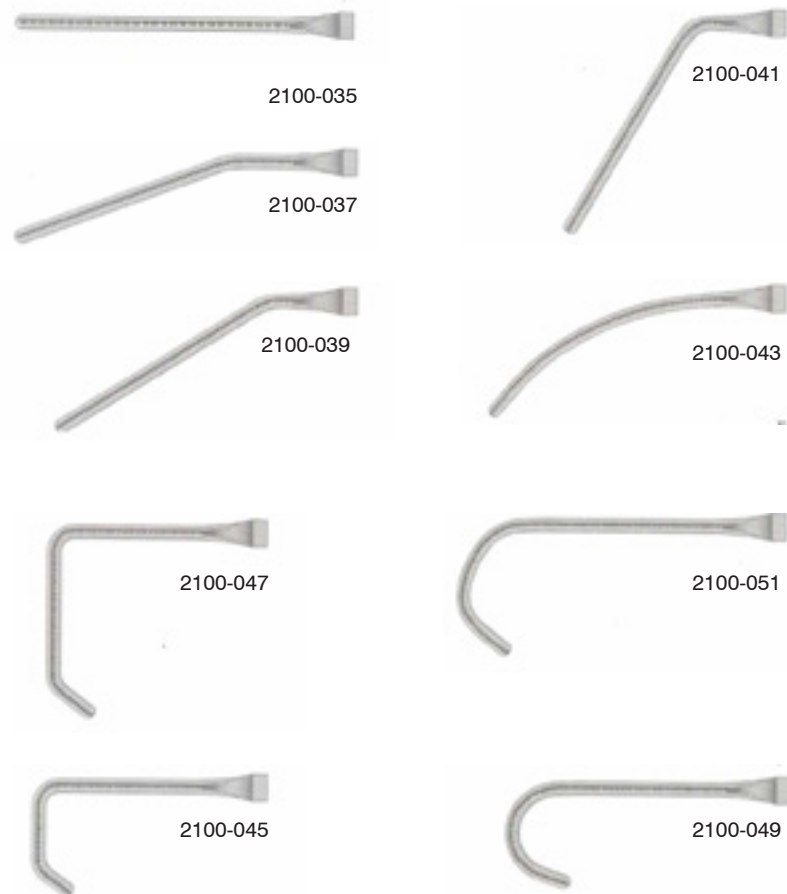

**Cooley Anastomosis Clamp**

**Atraumatic jaws / double angle**

2100-132	50°	7" (18 cm)
2100-130	60°	7" (18 cm)
2100-138	70°	7" (18 cm)
2100-134	80°	6 3/4" (17 cm)
2100-136	85°	6 3/4" (17 cm)

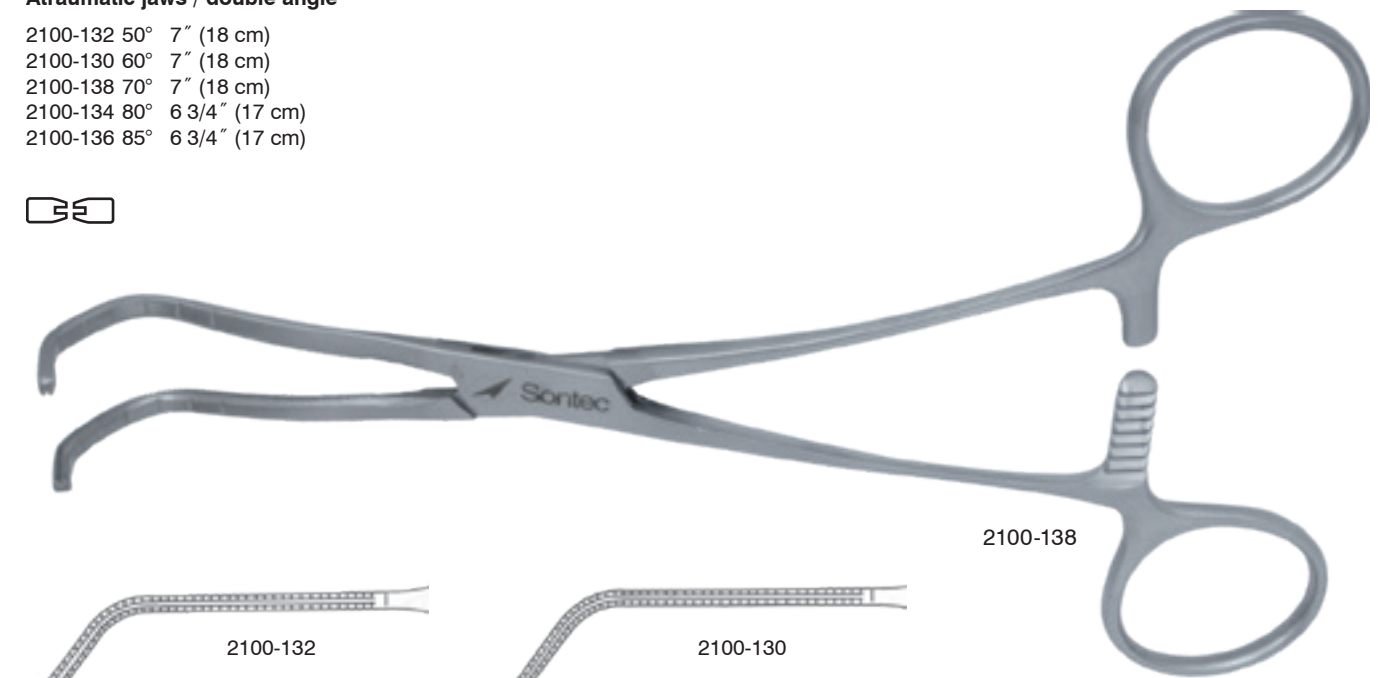

2100-138

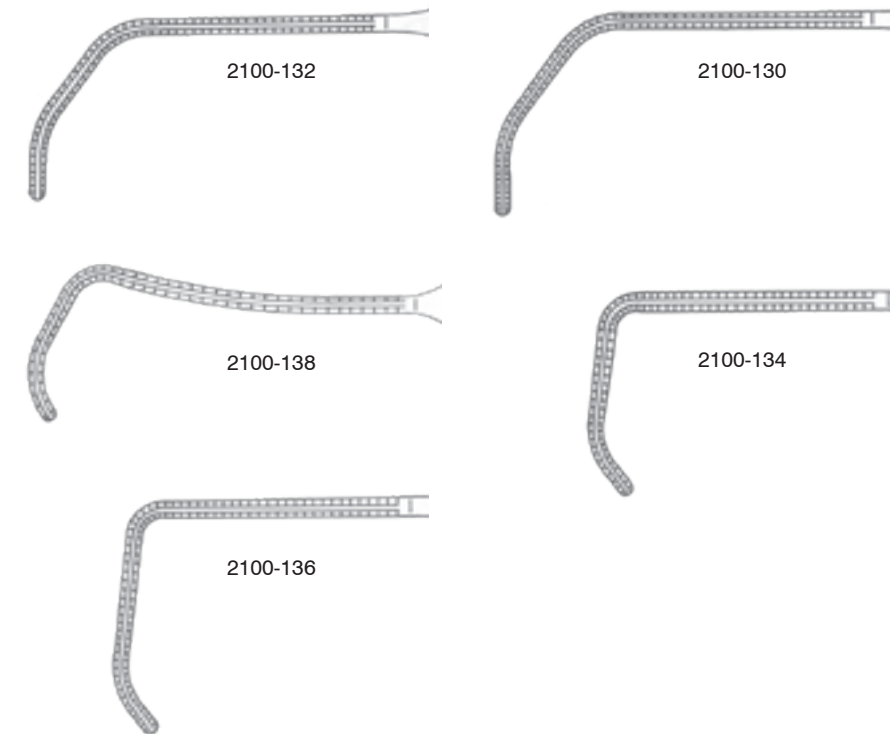

**Cooley Multi-Purpose Clamp**

**Atraumatic jaws / 60° angle**

- 2100-220 9 3/4" (24 cm)
- 2100-230 8" (20 cm)
- 2100-232 9 1/4" (23.5 cm)
- 2100-234 12 1/4" (31 cm)



2100-232

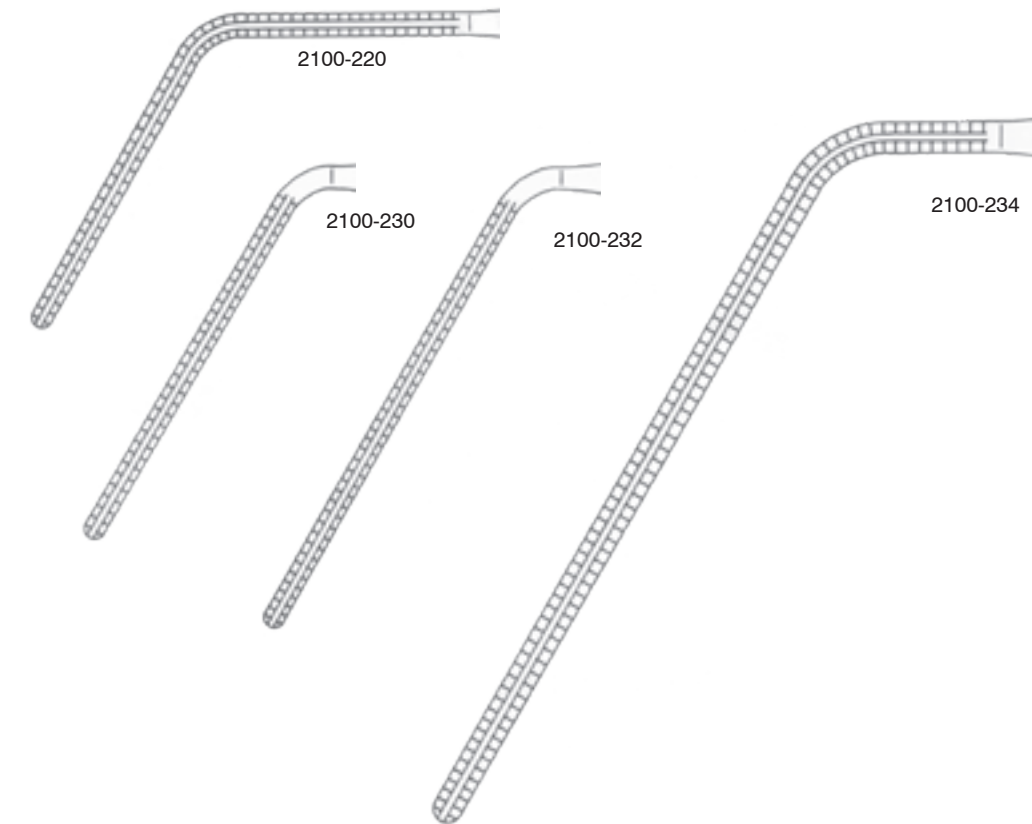

2100-220

2100-230

2100-232

2100-234



**Glover-Cooley Bulldog Clamp**

**Atraumatic Jaws / straight / spring loaded**

- 2100-400 3 1/8" (8 cm)
- 2100-405 3 1/2" (9 cm)
- 2100-410 4 1/4" (10.75 cm)
- 2100-415 4 3/4" (12 cm)



2100-405



2100-400



2100-405



2100-410



2100-415

**Atraumatic Jaws / curved / spring loaded**

- 2100-402 3" (7.5 cm)
- 2100-407 3 1/8" (8 cm)
- 2100-412 3 3/4" (9.5 cm)
- 2100-417 4 1/2" (11.5 cm)



2100-412



2100-402



2100-407



2100-412



2100-417

**Mini Glover (Weldon) Bulldog Clamp**

**\* Also know as Jacobson / serrated jaws / 1 1/8" (3 cm) / spring loaded**

- 2100-450 straight jaw
- 2100-452 curved jaw
- 2100-453 angled jaw
- 2100-454 125° reverse jaw



2100-450



2100-450



2100-452



2100-453



2100-454



2100-452

**Weldon Bulldog Vein Clamp Titanium**

**Straight**

- 2600-092 9mm jaw x 30mm length
- 2600-0922 13mm jaw x 35mm length
- 2600-0924 14mm jaw x 40mm length



2600-0922

**Slight curved**

- 2600-094 9mm jaw x 30mm length
- 2600-0942 13mm jaw x 35mm length
- 2600-0944 14mm jaw x 40mm length
- 2600-0946 22mm jaw x 45mm length



2600-0944

**Curved**

- 2600-093 9mm jaw x 30mm length
- 2600-0932 13mm jaw x 35mm length
- 2600-0934 14mm jaw x 40mm length
- 2600-0936 21mm jaw x 45mm length



2600-0934

**Weldon Bulldog Artery Clamp Titanium**

**Straight**

- 2600-0921 9mm jaw x 30mm length
- 2600-0923 13mm jaw x 35mm length
- 2600-0925 14mm jaw x 40mm length



2600-0923

**Slight curved**

- 2600-0941 9mm jaw x 30mm length
- 2600-0943 13mm jaw x 35mm length
- 2600-0945 14mm jaw x 40mm length
- 2600-0947 22mm jaw x 45mm length



2600-0945

**Curved**

- 2600-0931 9 mm jaw x 30 mm length
- 2600-0933 13mm jaw x 35mm length
- 2600-0935 14mm jaw x 40mm length
- 2600-0937 21mm jaw x 45mm length



2600-0935

**Micro Sontec® Vena Clava Satinsky-Glover Bulldog Clamp**

**Atraumatic Jaws / double angle / 2 1/2" (6.5 cm) / spring loaded**

2100-464



2100-464

**DeBakey Bulldog Clamp**

**Atraumatic Jaws / straight / cross-action**

- 2100-800 3 1/8" (8 cm)
- 2100-802 3 1/2" (9 cm)
- 2100-804 4 1/4" (10.75 cm)
- 2100-806 5" (12.5 cm)



2100-806

\* Can be used with Bulldog Clamp Applying Forceps (2100-399) below



2100-800



2100-802



2100-804



2100-806

**Atraumatic Jaws / curved / cross-action**

- 2100-810 3" (7.5 cm)
- 2100-812 3 1/8" (8 cm)
- 2100-814 3 3/4" (9.5 cm)
- 2100-816 4 1/2" (11.5 cm)



2100-816



2100-810



2100-812



2100-814



2100-816

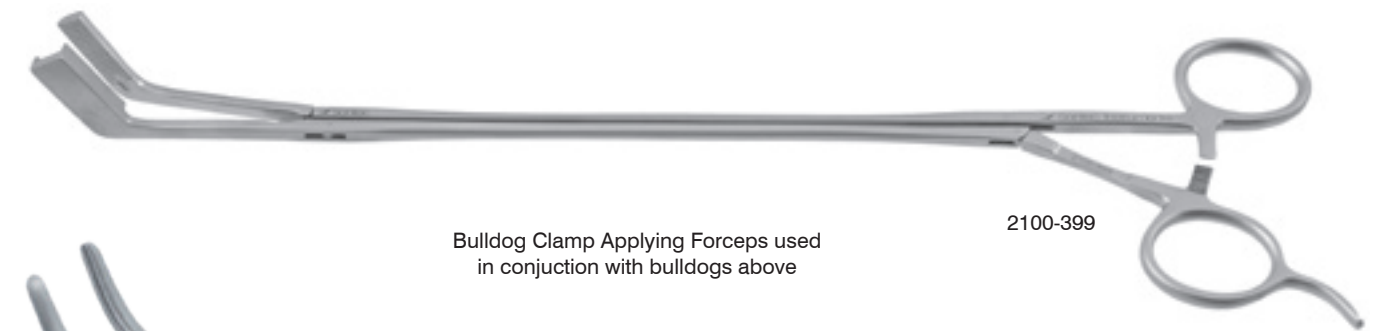

Bulldog Clamp Applying Forceps used in conjunction with bulldogs above

2100-399

**Dietrich Micro Bulldog Clamp**

Serrated jaw / straight / 2" (5 cm) / cross-action

- 2100-835 8 mm jaw length
- 2100-836 12 mm jaw length
- 2100-837 20 mm jaw length

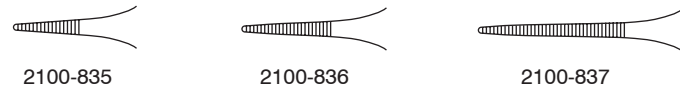

Serrated jaw / angled / 2" (5 cm) / cross-action

- 2100-838 8 mm jaw length
- 2100-839 12 mm jaw length
- 2100-840 20 mm jaw length

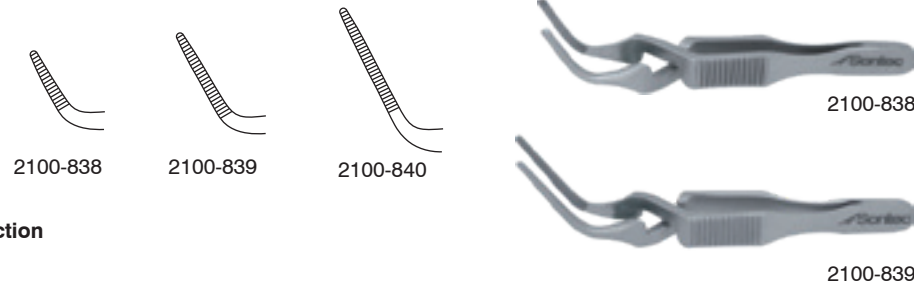

Serrated jaw / curved / 2" (5 cm) / cross-action

- 2100-841 20 mm jaw length

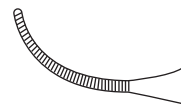

Smooth jaw / angled / 2" (5 cm) / cross-action

- 2100-842 13 mm jaw length
- 2100-843 18 mm jaw length

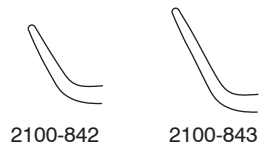

**Universal Microvascular Clamp**

For ordering:use order numbers listed below / also available in black / choose either A for Artery or V for Vein

	Clamp #1	Clamp #2	Clamp #3	Clamp #4	Clamp #5
<b>Length</b>	8 mm	11 mm	16 mm	24 mm	35 mm
<b>Pair of Clamps</b>					
<b>Vessel</b>	0.3-1.0 mm	0.6-1.5 mm	1.0-2.5 mm	1.5-3.3 mm	2.0-5.0 mm
<b>Designation</b>	B-1	B-2	B-3	HD-S	RD-S
<b>Order Number</b>	2100-B-1A 2100-B-1V	2100-B-2A 2100-B-2V	2100-B-3A 2100-B-3V	2100-HD-SA 2100-HD-SV	2100-RD-SA 2100-RD-SV

**Microvascular Clamp**

For ordering:use order numbers listed below / also available in black / choose either A for Artery or V for Vein

	Clamp #1	Clamp #2	Clamp #3	Clamp #4	Clamp #5
<b>Length</b>	8 mm	11 mm	16 mm	24 mm	35 mm
<b>Microvascular clamp pair on approximator bar</b>					
<b>Vessel</b>	0.3-1.0 mm	0.6-1.4 mm	1.0-2.25 mm	1.5-3.5 mm	2.0-5.0 mm
<b>Designation</b>	ABB-11	ABB-22	ABB-33	HD-D	RD-D
<b>Order Number</b>	2100-ABB-11A 2100-ABB-11V	2100-ABB-22A 2100-ABB-22V	2100-ABB-33A 2100-ABB-33V	2100-HD-DA 2100-HD-DV	2100-RD-DA 2100-RD-DV
<b>Microvascular clamp pair on approximator bar in frame</b>				<div style="border: 1px solid black; padding: 5px; width: fit-content; margin: auto;">                     All Microvascular Clamps are available in black. To order black clamps, please add a "B" after the order number                 </div>	
<b>Vessel</b>	0.4-1.0 mm	0.6-1.4mm	1.0-2.2 mm		
<b>Designation</b>	ABB-1	ABB-2	ABB-3		
<b>Order Number</b>	2100-ABB-1A 2100-ABB-1V	2100-ABB-2A 2100-ABB-2V	2100-ABB-3A 2100-ABB-3V		
<b>Microvascular clamp pair in wire frame</b>					
<b>Vessel</b>	0.3-1.0 mm	0.6-1.4 mm	1.0-2.2 mm		
<b>Designation</b>	DC-1	DC-2	DC-3		
<b>Order Number</b>	2100-DC-1A 2100-DC-1V	2100-DC-2A 2100-DC-2V	2100-DC-3A 2100-DC-3V		
<b>Microvascular clamp pair DC Angle</b>					
<b>Vessel</b>	0.3-1.0 mm	0.6-1.4 mm	1.0-2.2 mm		
<b>Designation</b>	DC-1	DC-2	DC-3		
<b>Order Number</b>	2100-DC-1A 2100-DC-1V	2100-DC-2A 2100-DC-2V	2100-DC-3A 2100-DC-3V		

**Micro Aneurysm Clamp Applier Forceps**

- 5 1/2" (14 cm)
- 2100-875



**Serrefine Bulldog Clamp**

1 1/2" (4 cm) / cross-action

- 14-9935 straight
- 14-9940 curved

2 1/2" (6.4 cm) / cross-action

- 115-585 straight
- 115-586 curved



**John Hopkins Bulldog Clamp**

**Straight / cross-action**

- 440-352 1 1/2"
- 440-354 2"
- 440-356 2 1/4"
- 440-358 2 1/2"
- 440-360 2 3/4"
- 440-362 3"
- 440-364 3 1/2"

**Curved / cross-action**

- 440-370 1 1/2"
- 440-372 2"
- 440-374 2 1/4"
- 440-376 2 1/2"
- 440-378 2 3/4"
- 440-380 3"
- 440-382 3 1/2"

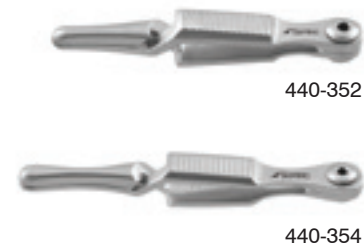

**Cooley and Debakey Neonatal Cardiovascular Clamp**

Especially developed for delicate cardiovascular and neonatal surgery / Ultra fine Cooley and Debakey jaws are atraumatic and provide a secure grip to even the most delicate vessels / 72 varieties available - choose a handle style (by letter) and tip style (by number) / 12 cm / 4 3/4" overall length

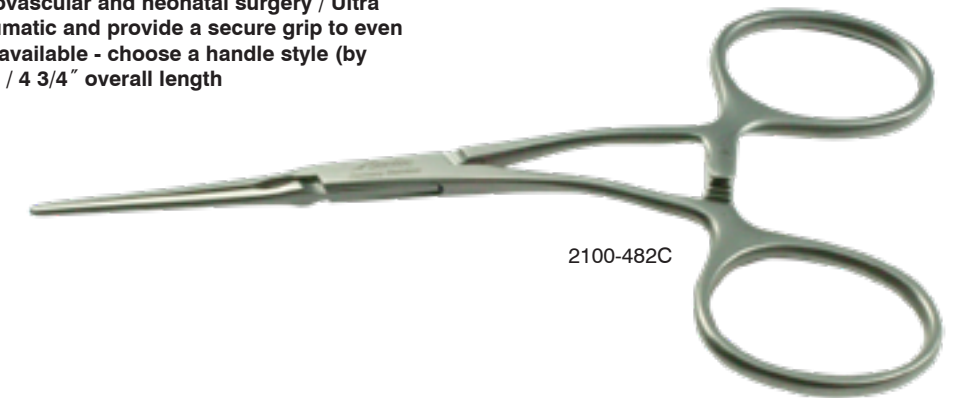

2100-482C

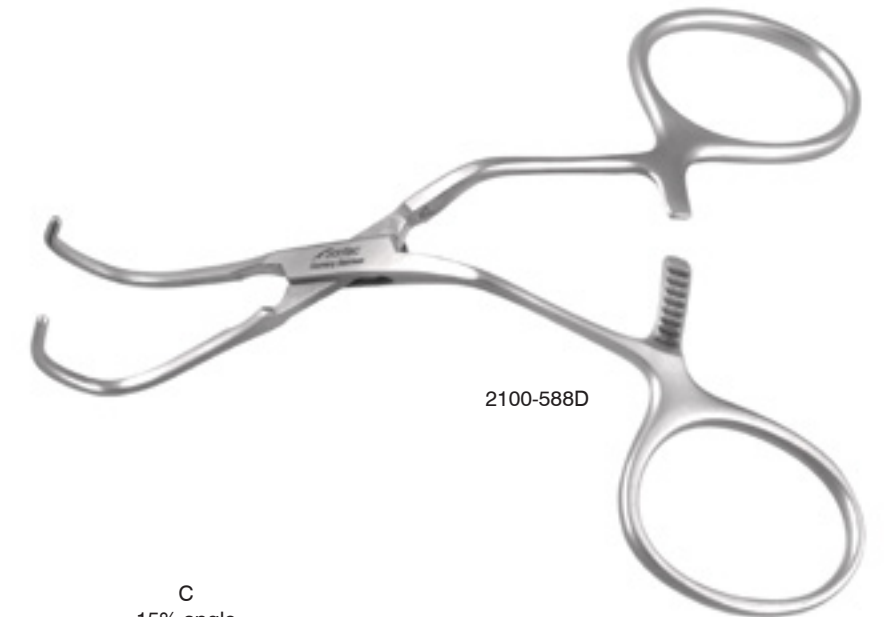

2100-588D

A  
straight

B  
curved

C  
15% angle

D  
45% angle



**Cooley Neonatal Cardiovascular Clamp**

Atraumatic jaws / 4 3/4" (12 cm)



Handle Style	Straight	30 degree	45 degree	60 degree	90 degree
A	2100-482A	2100-483A	2100-484A	2100-485A	2100-486A
B	2100-482B	2100-483B	2100-484B	2100-485B	2100-486B
C	2100-482C	2100-483C	2100-484C	2100-485C	2100-486C
D	2100-482D	2100-483D	2100-484D	2100-485D	2100-486D

Handle Style	45D double angle	65D small double angle	65D long double angle	Reverse double angle	90D small double angle	90D long double angle
A	2100-487A	2100-488A	2100-489A	2100-490A	2100-491A	2100-492A
B	2100-487B	2100-488B	2100-489B	2100-490B	2100-491B	2100-492B
C	2100-487C	2100-488C	2100-489C	2100-490C	2100-491C	2100-492C
D	2100-487D	2100-488D	2100-489D	2100-490D	2100-491D	2100-492D

Handle Style	45D reverse angle	50D reverse angle	Medium full curve	Small full curve	Large full curve	Curved angle	Spoon
A	2100-493A	2100-494A	2100-495A	2100-496A	2100-497A	2100-498A	2100-499A
B	2100-493B	2100-494B	2100-495B	2100-496B	2100-497B	2100-498B	2100-499B
C	2100-493C	2100-494C	2100-495C	2100-496C	2100-497C	2100-498C	2100-499C
D	2100-493D	2100-494D	2100-495D	2100-496D	2100-497D	2100-498D	2100-499D

**Debakey Neonatal Cardiovascular Clamp**

Atraumatic jaws / 4 3/4" (12 cm)



Handle Style	Straight	30 degree	45 degree	60 degree	90 degree
A	2100-575A	2100-576A	2100-577A	2100-578A	2100-579A
B	2100-575B	2100-576B	2100-577B	2100-578B	2100-579B
C	2100-575C	2100-576C	2100-577C	2100-578C	2100-579C
D	2100-575D	2100-576D	2100-577D	2100-578D	2100-579D

Handle Style	45D double angle	65D small double angle	65D long double angle	Reverse double angle	90D small double angle	90D long double angle
A	2100-580A	2100-581A	2100-582A	2100-583A	2100-584A	2100-585A
B	2100-580B	2100-581B	2100-582B	2100-583B	2100-584B	2100-585B
C	2100-580C	2100-581C	2100-582C	2100-583C	2100-584C	2100-585C
D	2100-580D	2100-581D	2100-582D	2100-583D	2100-584D	2100-585D

Handle Style	45D reverse angle	50D reverse angle	Medium full curve	Small full curve	Large full curve	Curved angle	Spoon
A	2100-586A	2100-587A	2100-588A	2100-589A	2100-590A	2100-591A	2100-592A
B	2100-586B	2100-587B	2100-588B	2100-589B	2100-590B	2100-591B	2100-592B
C	2100-586C	2100-587C	2100-588C	2100-589C	2100-590C	2100-591C	2100-592C
D	2100-586D	2100-587D	2100-588D	2100-589D	2100-590D	2100-591D	2100-592D

**DeBakey-Satinsky Clamp**

Atraumatic jaws / double angled / with curved shanks

- 2100-781 9 1/4" (23.5 cm)
- 2100-782 9 1/2" (24cm)
- 2100-783 9 3/4 (24.5 cm)
- 2100-784 10" (25 cm)
- 2100-785 11 1/4" (28.5 cm)

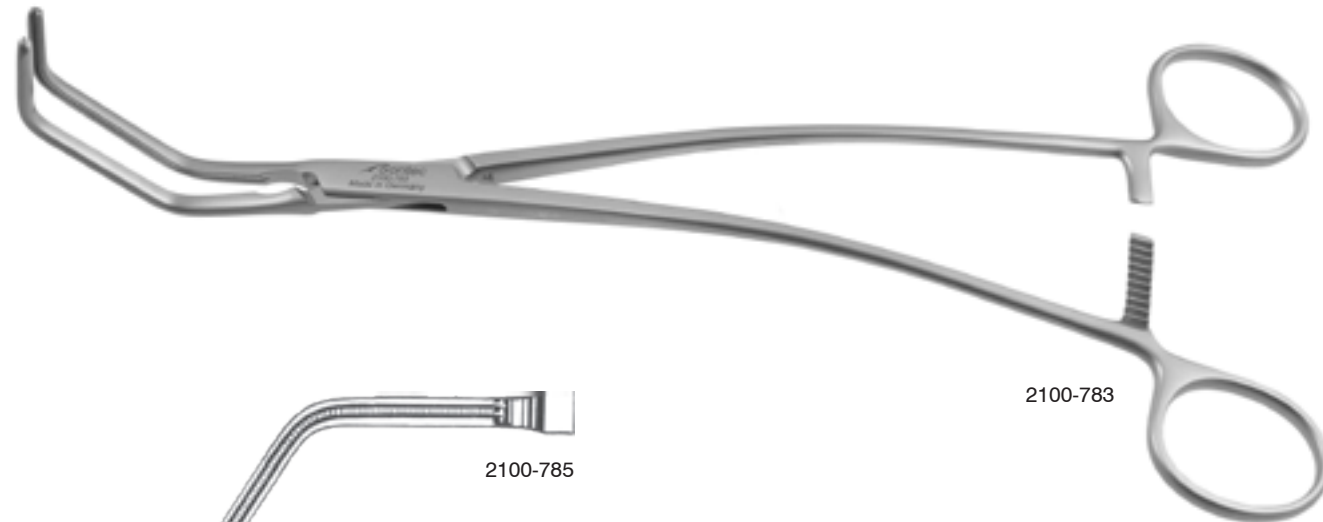

2100-783

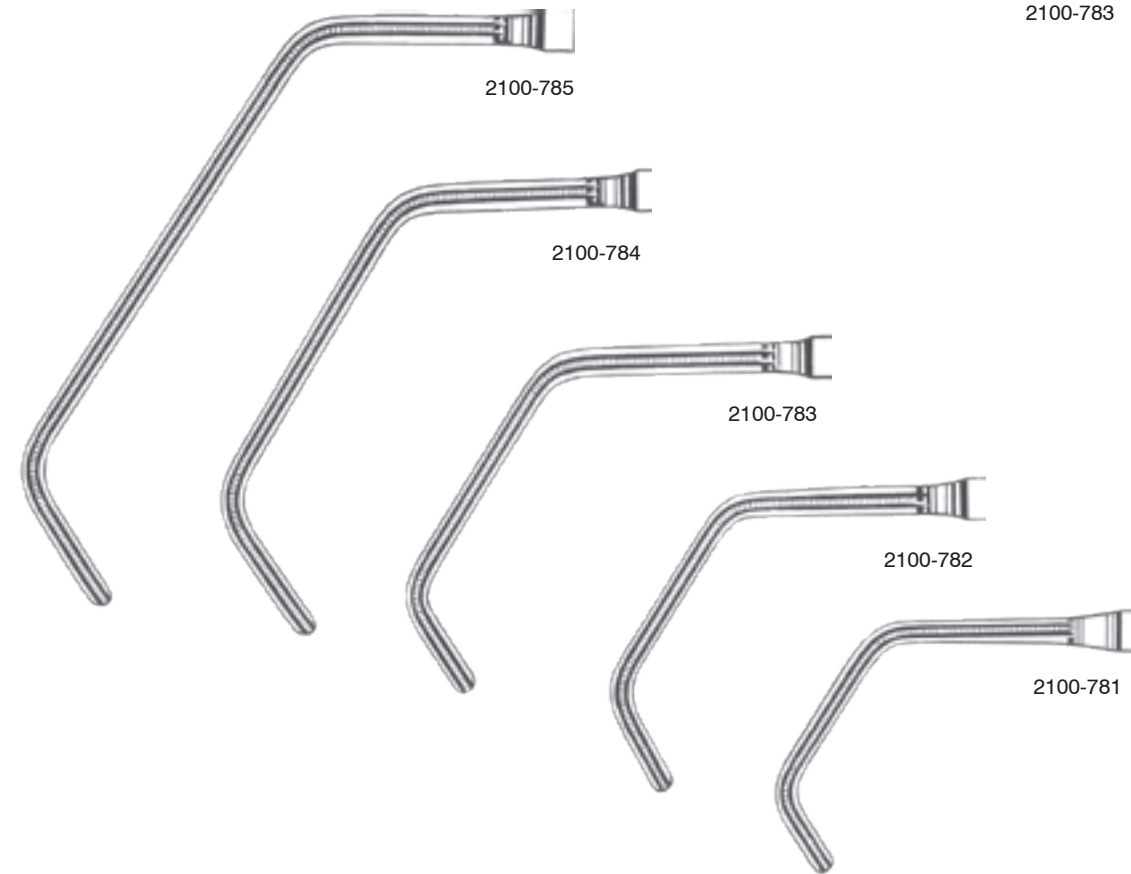

2100-785

2100-784

2100-783

2100-782

2100-781

**DeBakey-Derra Anastomosis Clamp**

Atraumatic jaws

- 2100-755 small jaws 6 3/4" (17 cm)
- 2100-756 medium jaws 6 3/4" (17 cm)
- 2100-757 large jaws 7" (18 cm)

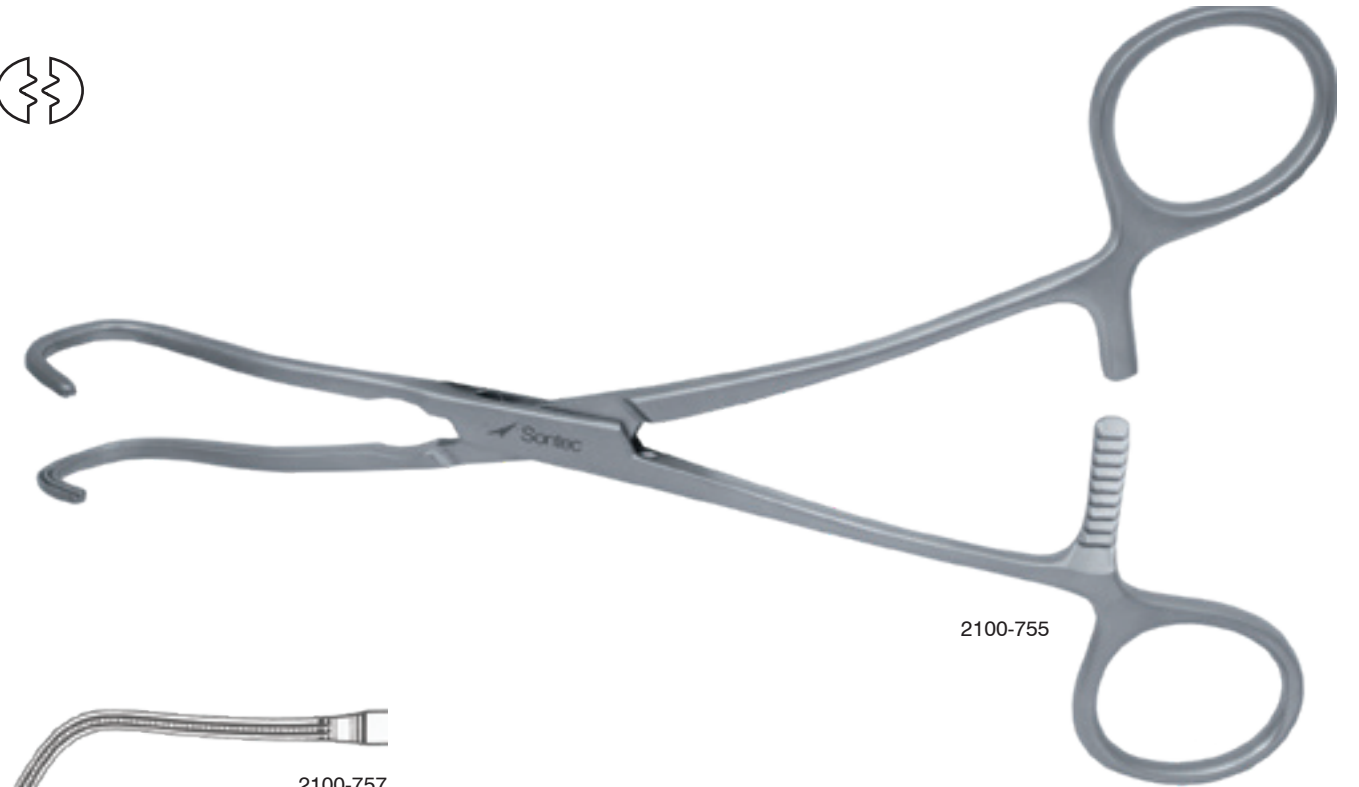

2100-755

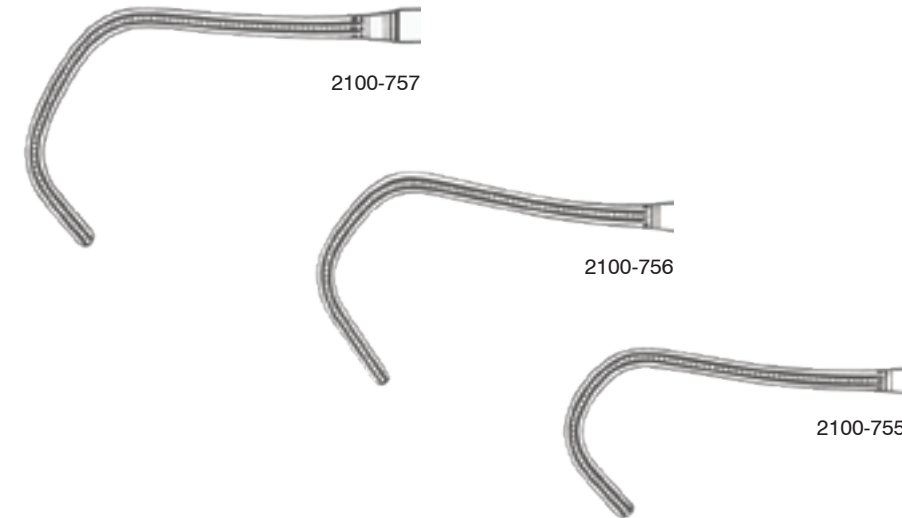

2100-757

2100-756

2100-755

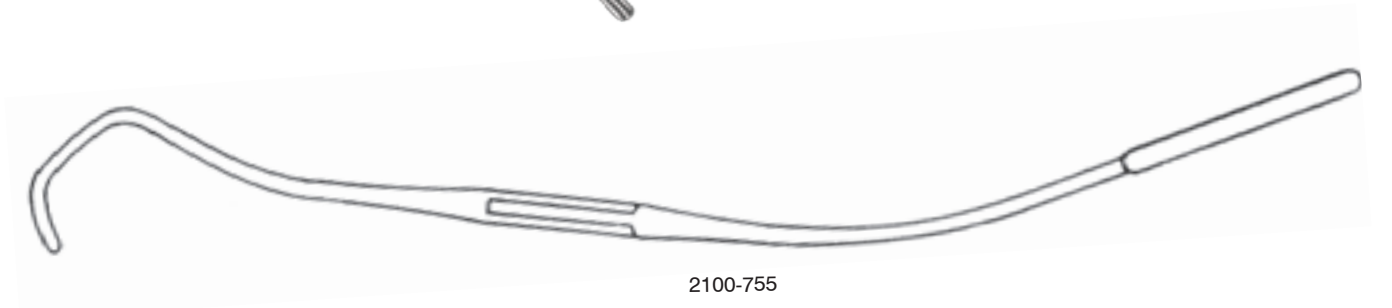

2100-755

**Strong Aortic Clamp**

With DeBakey jaws / 7 1/2" (19 cm)  
2100-733

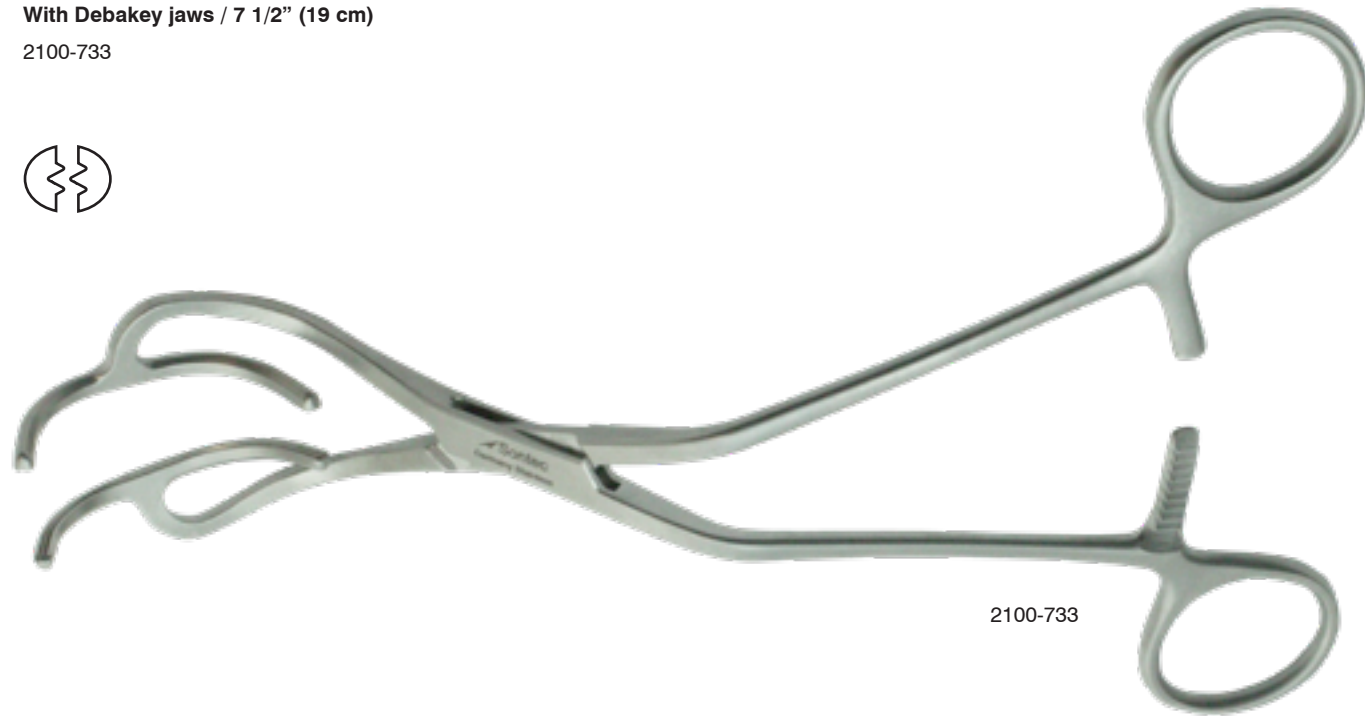

2100-733

**Blalock Aorta Clamp**

Flexible shaft / DeBakey jaws / 8 3/4" (22 cm)

- 2100-894 12 mm jaw length
- 2100-896 20 mm jaw length
- 2100-898 30 mm jaw length



Flexible shaft / Smooth Jaws / 8 3/4" (22 cm)

- 2100-895 12 mm jaw length
- 2100-897 20 mm jaw length
- 2100-899 30 mm jaw length



2100-895



2100-897



2100-899

**Vorse Tube Occluding Clamp**

Serrated jaws

- 117-543 5 1/4" (13 cm)
- 117-546 7 1/4" (18.5 cm)
- 117-549 8" (20 cm) heavy

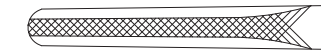

117-565

Serrated jaws / with u-shaped guard

- 117-562 5 1/4" (13 cm)
- 117-565 7 1/4" (18.5 cm)
- 117-568 8" (20 cm) heavy

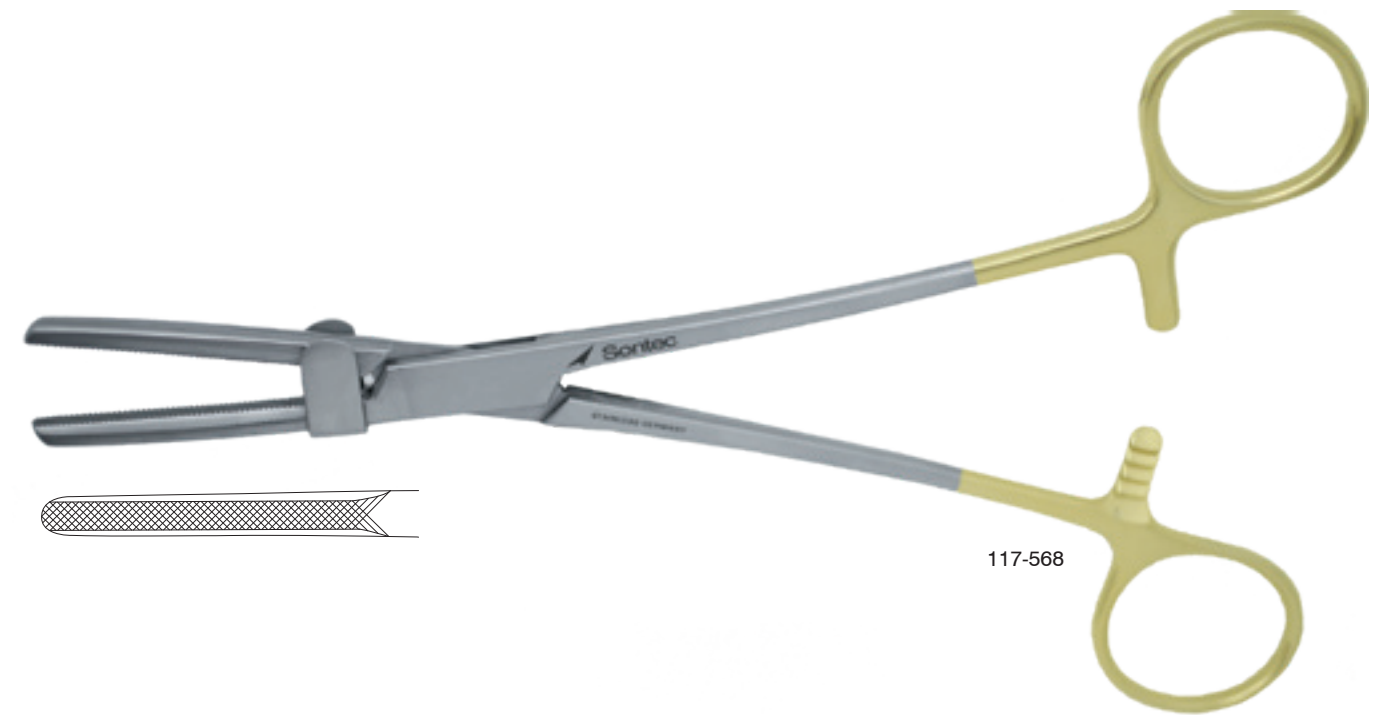

117-568



 Sontec Instruments®

Eye RETRACTORS

**Alm Retractor**

2 3/4" (7cm) spread / 2 3/4" (7cm) in length

- 230-380 4mm
- 230-381 7mm
- 230-382 11mm

3" (7.5cm) spread / 4" (10cm) in length

- 230-385 5mm
- 230-386 9mm
- 230-387 16mm

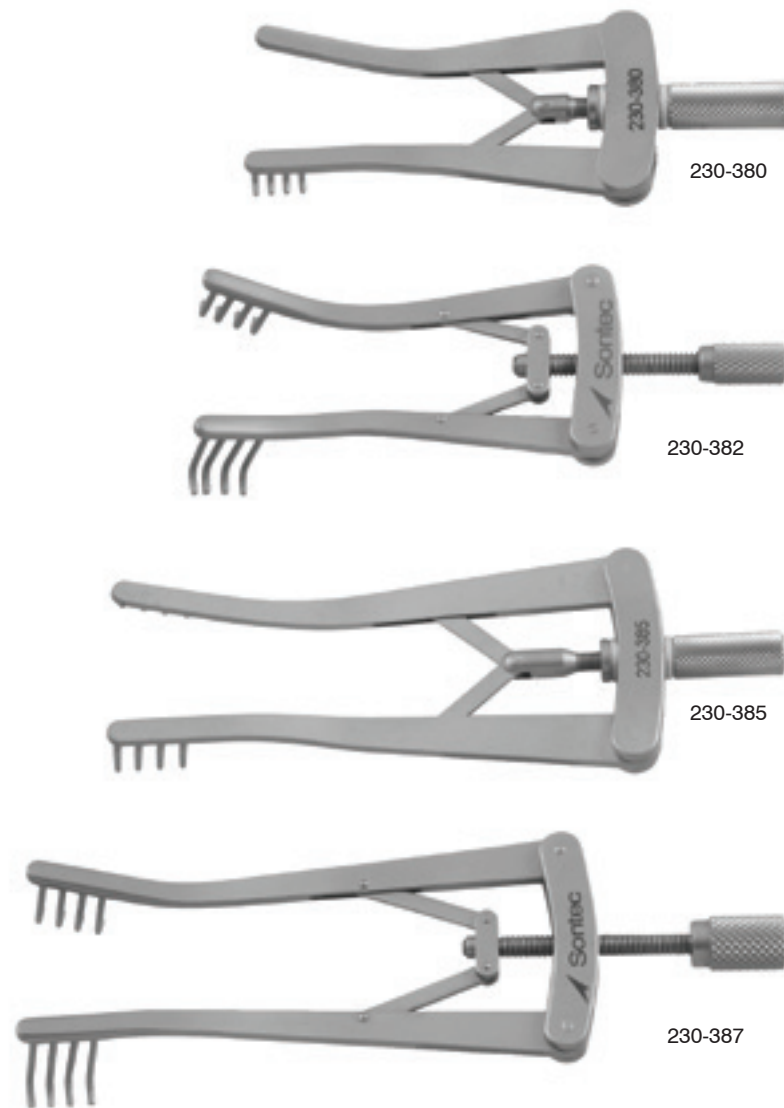

**Jaffe Wire Lid Retractor**

15mm

10-1370

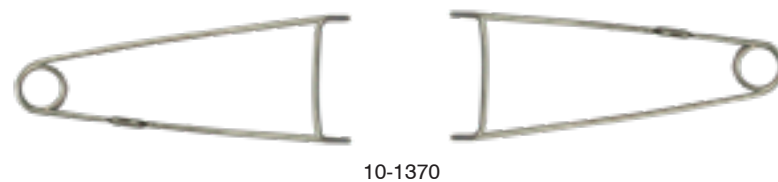

**Rizzuti Iris Retractor & Lens Expressor**

2.0 mm wide lip

12-4800



**Jaeger Lid Plate**

**Stainless**

- 10-4520 1/2 laser finish
- 10-4521 broad laser finish mini 3 3/4"
- 10-4522 1/2 laser finish slight "S" curved
- 10-4525 blue electro coat
- 10-4530 stainless steel
- 10-4535 black laser finish

**Titanium**

10-4540

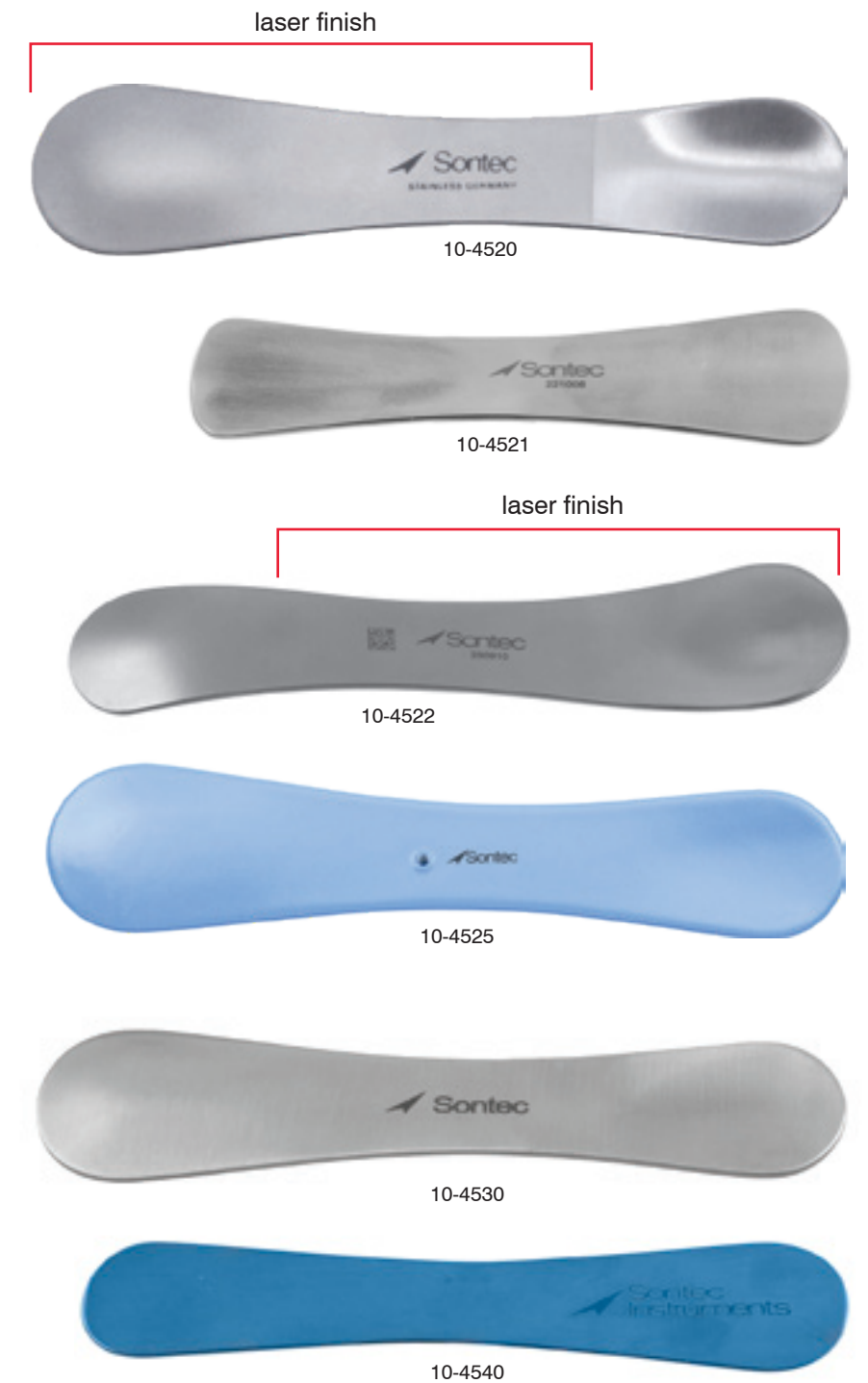

**Sewall Orbital Retractor**

Double ended / 7mm curved / 3.5mm curved

10-3890



**Barraquer Wire Speculum**

**Standard**

10-1000	10 mm blades	
T10-1000	10 mm blades	titanium
10-1005	12 mm blades	
T10-1005	12 mm blades	titanium
10-1007	14 mm blades	
T10-1007	14 mm blades	titanium
10-1010	15 mm blades	
T10-1010	15 mm blades	titanium

**Closed wire / curved blades**

10-1000C	10 mm blade	15 mm spread small	
10-1000C-13	13 mm blade	10 mm spread	
T10-1000C	10 mm blade	15 mm spread small	titanium
10-1005C	12 mm blade	18 mm spread medium	
10-1010C	14 mm blade	18 mm spread large	
10-1010C-08	8 mm blade	16 mm spread	
T10-1010C	14 mm blade	18 mm spread large	titanium

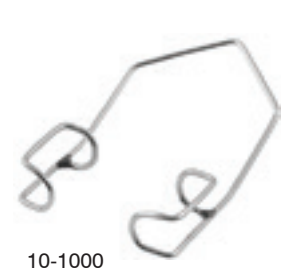

10-1000

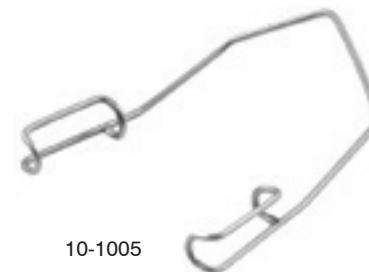

10-1005

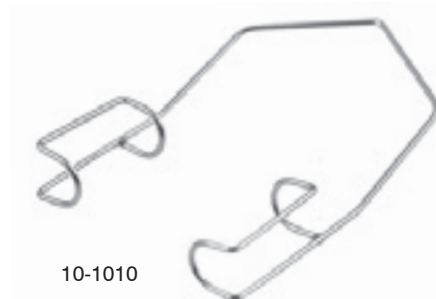

10-1010

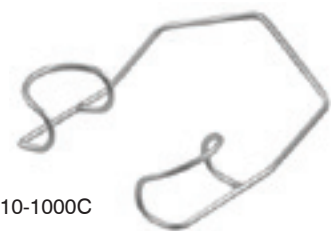

10-1000C

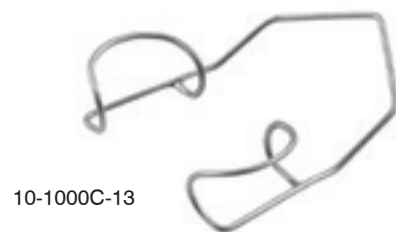

10-1000C-13

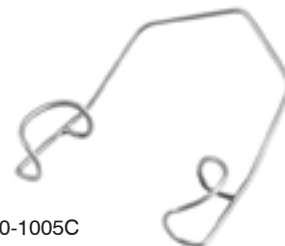

10-1005C

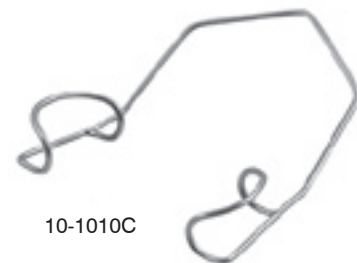

10-1010C

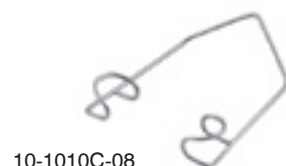

10-1010C-08

**Barraquer Wire Speculum Third Eye Lid**

**Closed blades**

T10-1013	10 mm blades	18 mm spread	left third eye lid	titanium
T10-1014	10 mm blades	18 mm spread	right third eye lid	titanium
10-1015	14 mm blades	18 mm spread	left third eye lid	
10-1016	14 mm blades	18 mm spread	right third eye lid	
T10-1015	14 mm blades	18 mm spread	left third eye lid	titanium
T10-1016	14 mm blades	18 mm spread	right third eye lid	titanium

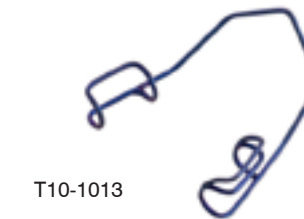

T10-1013

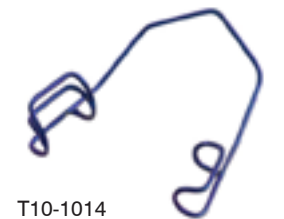

T10-1014

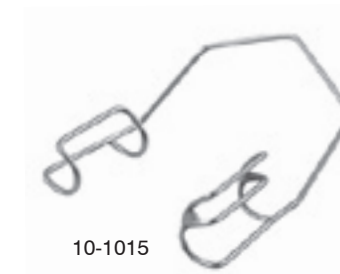

10-1015

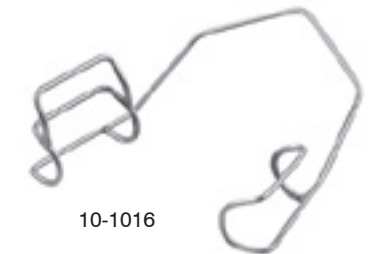

10-1016

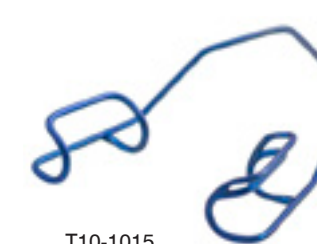

T10-1015

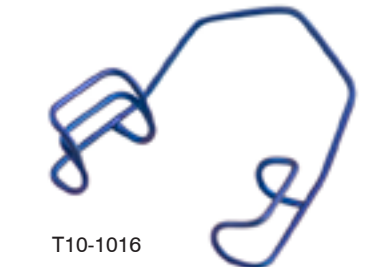

T10-1016

**Barraquer Wire Speculum**

**Solid blades**

10-1020	small	stainless
T10-1020	small	titanium
10-1030	large	stainless
T10-1030	large	titanium



10-1020



10-1030

**Castroviejo Equine Eye Speculum**

1" / 25 mm blades / 4 3/4" ( cm)

10-1704



10-1704

**Williams Eye Speculum**

**Locking screw / open blades**

10-1500	small
10-1510	large



10-1500



10-1510

**Desmarres Lid Retractor**

**Stainless steel / 5 1/2" (14 cm)**

- 10-4192 6 mm
- 10-4194 8 mm
- 10-4196 9 mm
- 10-4198 10 mm
- 10-4200 11 mm
- 10-4201 11 mm electro-blue coated
- 10-4206 12 mm
- 10-4207 12 mm electro-blue coated
- 10-4210 13 mm
- 10-4213 13 mm electro-blue coated
- 10-4216 14 mm
- 10-4220 15 mm



10-4200



10-4223

- 10-4218 14 mm
- 10-4223 15 mm electro-blue coated
- 10-4226 16 mm
- 10-4227 16 mm electro-blue coated
- 10-4230 17 mm



10-4236

- 10-4233 17 mm electro-blue coated
- 10-4236 18 mm
- 10-4237 18 mm electro-blue coated
- 10-4240 19 mm



10-4192 10-4196 10-4198 10-4206 10-4216 10-4226

**Kawamoto Double-Ended Retractor**

**14 mm x 16 mm / 6" (15.2 cm)**

- 10-4269
- 10-4270 blue electro coating



10-4269



10-4270

**McGannon Retractor**

**Fenestrated blade / 5" (12.5 cm)**

- 205-800 2.5 mm



205-800

**Desmarres Lid Retractor Titanium**

**10 mm / 4 3/4" (12.1 cm)**

- T10-4198



T10-4198

**Double-ended / 10 mm & 12 mm / 5 7/8" (14.7 cm)**

- T10-4255 6 mm



T10-4255

**Desmarres Lid Retractor Autoclavable Plastic**

**Double ended / transparent yellow / autoclave safe / 5 1/2" (14 cm)**

- 10-4245 10 mm & 12 mm
- 10-4246 14 mm & 16 mm



10-4245



10-4246

**Gil-Vernet Desmarres Retractor**

**5 3/4" (14.5 cm)**

- 10-4211 size 1
- 10-4221 size 2
- 10-4231 size 3
- 10-4241 size 4



10-4211

10-4231



10-4221

10-4241



10-4241



 Sontec Instruments®

Eye SPECIALTY

**New Orleans Lens Loop**

Single-ended  
T12-4330



T12-4330

**Culler Lens Spoon**

Single-ended / 3 mm spoon width / 12.8 cm total length  
12-4500



12-4500

**Bunge Evisceration Spoon**

Straight head

- 12-4601 6.0 mm
- 12-4602 7.0 mm
- 12-4600 8.0 mm
- 12-4604 10.0 mm
- 12-4608 11.0 mm
- 12-4610 12.0 mm



12-4610

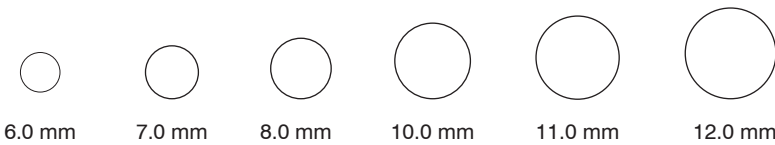

**Wells Enucleation Spoon**

Angled head  
12-4750



12-4750

**Sontec Corneal Cutting Block**

Delren plastic  
11-9350



11-9350

**Algerbrush II Corneal Rust Ring Remover Burr**

Battery powered

- 11-4600 complete w/ 0.5 mm burr
- 11-4601 complete w/ 1 mm burr
- 11-4610 burr only 0.5 mm
- 11-4609 burr only 1 mm



11-4600

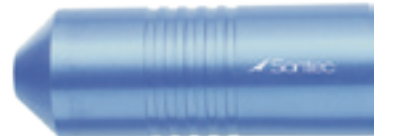

11-4610

**Algerbrush II Pterygium Burr**

Battery powered

- 11-4611 complete w/ 2.5mm Fine ball tip
- 11-4612 2.5 mm fine ball tip only
- 11-4613 complete w/ 3.5mm medium ball tip
- 11-4614 3.5 mm medium ball tip only
- 11-4615 complete w/ 4mm fine wheel
- 11-4616 4 mm fine wheel tip only
- 11-4617 complete w/ 5mm medium wheel
- 11-4618 5 mm wheel tip only



11-4611



11-4612

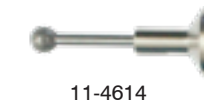

11-4614



11-4616



11-4618



**Martinez Corneal Dissector**

Double-ended

11-3420



11-3420

**Castroviejo Lacrimal Dilator**

Double-ended

16-2510



16-2510

**Castaneda Enucleation Clamp Forceps**

Autramatic curved jaw / curved shank / 4 3/4" (12 cm)  
23-1818



23-1818

**Enucleation Scissors**

PC Gold / 5 1/4" (13 cm)

- 13-9805 light curve
- 13-9810 medium curve
- 13-9820 full curve
- 13-9822 full curve PC Black



13-9820



13-9822



**Intraocular Grasping Forceps**

Axial squeeze handle  
14-7750



14-7750

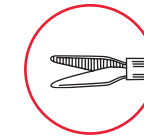

Cap

**Intraocular Micro Biopsy Forceps**

Axial squeeze handle  
14-7751



14-7751

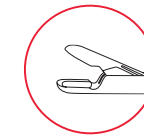

Cap

**Vitrectomy Scissors**

20 G

- 13-5600 straight
- 13-5605 30°
- 13-5610 60°
- 13-5615 90°



straight

30°

60°

90°



13-5600

**Intraocular Scissors**

Squeeze handle / with protective sleeve

- 13-5700 straight
- 13-5710 curved
- 13-5710B curved ceramic coated blade



13-5700



13-5710B

Squeeze handle / irrigation with protective sleeve

- 13-5701 straight
- 13-5711 curved

**Bowman Lacrimal Probe**

**Sterling silver / butterfly handle**

- 16-2520 set of six probes
- 16-2530 size 0000/000
- 16-2540 size 00/0
- 16-2541 size 0/1
- 16-2550 size 1/2
- 16-2551 size 2/3
- 16-2560 size 3/4
- 16-2561 size 4/5
- 16-2570 size 5/6
- 16-2571 size 6/7
- 16-2580 size 7/8

**Stainless steel / butterfly handle**

- 16-2530S size 0000/000
- 16-2540S size 00/0
- 16-2550S size 1/2
- 16-2560S size 3/4
- 16-2570S size 5/6



**Bowman Lacrimal Probe**

**Stainless steel / round handle**

- 16-2578 set of six probes
- 16-2579 size 0000/000
- 16-2581 size 00/0
- 16-2582 size 0/1
- 16-2583 size 1/2
- 16-2584 size 2/3
- 16-2585 size 3/4
- 16-2586 size 4/5
- 16-2587 size 5/6
- 16-2588 size 6/7
- 16-2589 size 7/8



**Pigtail Lacrimal Probe Dilator**

- 15 mm tip w/holes
- 16-2600



**French Lacrimal Dilator**

- Double-ended / 3"
- 16-2442



**Castroviejo Lacrimal Dilator**

- Double-ended
- 16-2510



**Infant Lacrimal Dilator**

- Single-ended
- 16-2440



**Wilder Lacrimal Dilator**

- Single-ended
- 16-2460 fine, #1
- 16-2470 medium, #2
- 16-2480 heavy, #3



**Muldoon Lacrimal Dilator**

- Single-ended / graduated blunt tip
- 16-2500



**Silicone Eye Implants**

Please specify size when ordering  
/ not for medical use (vet only)

- 1100-411-10 10 mm
- 1100-411-11 11 mm
- 1100-411-12 12 mm
- 1100-411-13 13 mm
- 1100-411-14 14 mm
- 1100-411-15 15 mm
- 1100-411-16 16 mm
- 1100-411-17 17 mm
- 1100-411-18 18 mm
- 1100-411-19 19 mm
- 1100-411-20 20 mm
- 1100-411-21 21 mm
- 1100-411-22 22 mm
- 1100-411-23 23 mm
- 1100-412-24 24 mm
- 1100-412-26 26 mm
- 1100-412-28 28 mm
- 1100-412-30 30 mm
- 1100-412-33 33 mm
- 1100-412-36 36 mm
- 1100-412-38 38 mm
- 1100-412-40 40 mm
- 1100-412-43 43 mm
- 1100-412-45 45 mm
- 1100-412-47 47 mm

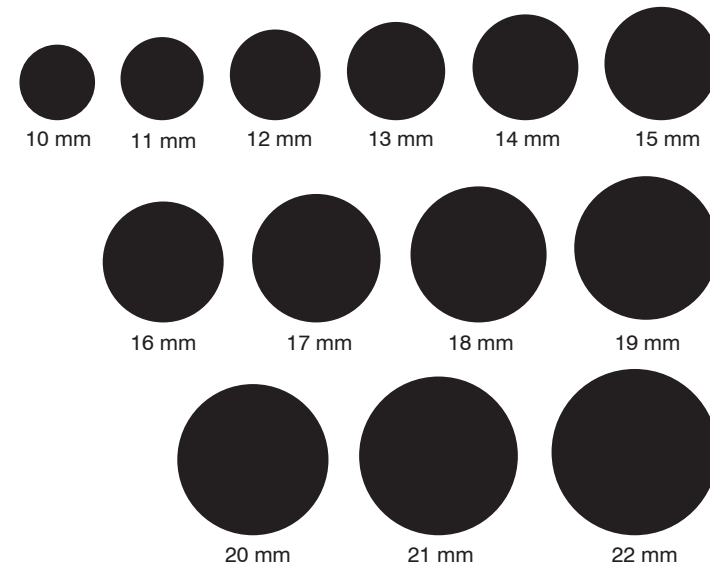

**Carter Sphere Introducer**

5" (12.5 cm)  
17-1000



**Suction Cup Handle for Eye Shields**

18-8028 silicone blue



18-8028

**Corneal Eye Shields in Non-Reflective Laser Finish or Electro Blue Coating**

**Non-reflective laser finish stainless / 22 mm x 27 mm**

- 18-8026 can be used with suction cup 18-8028
- 18-8025 can be used with suction cup 18-8028 pair
- 18-8022 with handle
- 18-8020 with handle pair

**Electro blue coated / 22 mm x 27 mm**

- 18-8026B without handle
- 18-8025B without handle pair
- 18-8022B with handle
- 18-8020B with handle pair

**Titanium / 24 mm x 21 mm**

- T18-8023 with handle



18-8022



18-8026



18-8022B



T18-8023

### Bishop-Harmon Irrigation Bulb Cannula Set

#### Adapter and blue silicone bulb / angled cannula

- 16-5300-SET complete (bulb, adapter, 19 gauge cannula)
- 16-5310 silicone bulb
- 16-5330 19 gauge cannula
- 16-5331 21 gauge cannula (separate purchase)
- 16-5340 bulb & adapter (separate purchase)
- 16-5320 SS adapter
- 16-5325 plastic adapter (bag of 5 each)
- 16-5321 plastic adapter (1 each)

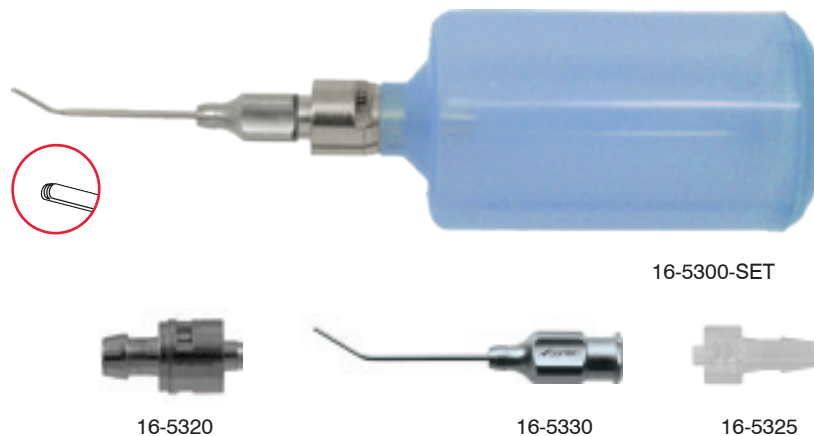

### Flieringa Scleral Fixation Ring

Set of 9 sizes, 14 mm - 22 mm

10-3100-SET

#### Also sold individually

- 10-3140 14 mm
- 10-3150 15 mm
- 10-3160 16 mm
- 10-3170 17 mm
- 10-3180 18 mm
- 10-3190 19 mm
- 10-3200 20 mm
- 10-3210 21 mm
- 10-3220 22 mm

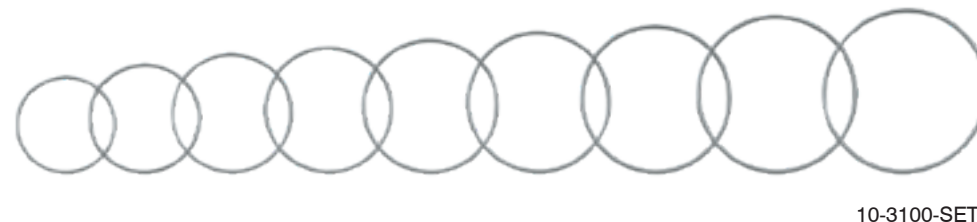

### McNeill-Goldman Scleral Fixation Ring & Blepharostat

#### Stainless

- 10-3310 small 15 mm inside diameter
- 10-3312 medium 16 mm inside diameter
- 10-3314 large 17 mm inside diameter

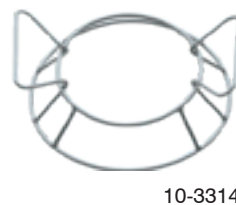

### Lacrimal Cannula

#### Reinforced shaft / 23 gauge

- 16-3300 straight
- 16-3310 curved

#### Straight / 23 gauge / 25 mm length

16-3290

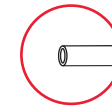

16-3310



16-3290

### Severin Lacrimal Cannula

#### Curved

- 1103-500 19 gauge
- 1103-500A 20 gauge
- 1103-500B 21 gauge
- 1103-500C 22 gauge
- 1103-500D 23 gauge
- 1103-500E 24 gauge
- 1103-500F 25 gauge
- 1103-500G 26 gauge
- 1103-500H 27 gauge
- 1103-500J 30 gauge

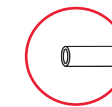

1103-500A

### Fasanella Lacrimal Cannula

#### Curved / 15 mm length / 23 gauge

16-3350



16-3350

### Lacrimal Cannula

#### Side opening / straight / 28 mm length / 19 gauge

16-3346

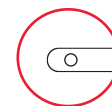

16-3346

### Shahinian Lacrimal Cannula

#### Smooth conical tip / straight / 0.3 mm side opening / 11 mm length / 23 gauge

16-3314

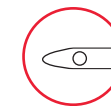

16-3314

### McIntyre Lacrimal Cannula

#### 0.3 mm dual sideports / 23 gauge

- 16-3320 straight
- 16-3330 curved

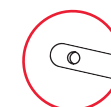

16-3330

### West Cannula

#### Side opening / curved / 25 mm length / 23 gauge

16-3348

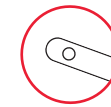

16-3348

### Air Injection Cannula

#### Angled / 5 mm tip

- 16-3810 25 gauge
- 16-3820 27 gauge
- 16-3800 30 gauge



16-3820

#### Angled / 7 mm tip

- 16-3821 27 gauge
- 16-3826 30 gauge

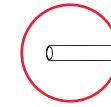

16-3821



 Sontec Instruments®

Eye FORCEPS

#00 Jewelers aka Cilia & Suture Removal Forceps

Fine Tip / TC Dust / 4 1/2" (11.5cm)

14-6805 stainless steel  
T14-6805 titanium



14-6805



T14-6805

Jewelers Classic Forceps

#1 / standard handle / extra delicate

14-6810 stainless  
T14-6810 titanium



14-6810

#2 / standard handle / delicate / stair

14-6815  
14-6816 TCD  
T14-6816 titanium



14-6815

#3 / standard handle / standard

14-6830 stainless  
T14-6830 titanium



14-6830

#3 / standard handle / standard / stainless / TCD

14-6831



T14-6831

#3C / standard handle / short

14-6820 stainless  
T14-6820 titanium



14-6820

#3C / standard handle / standard / stainless / TCD

14-6821



T14-6821

#4 / standard handle / standard

14-6840 stainless  
T14-6840 titanium



14-6840

#5 / standard handle / extra delicate

14-6850 stainless  
T14-6850 titanium

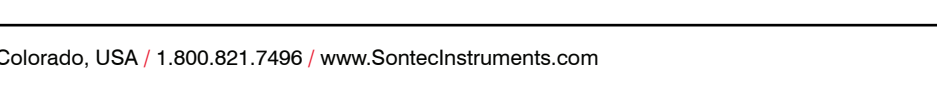

14-6850

#7 / standard handle / curved

14-6870 stainless  
T14-6860 titanium

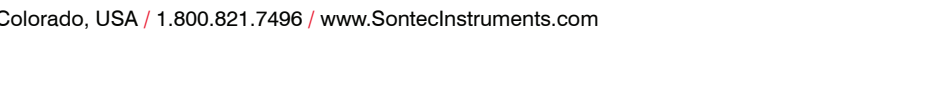

14-6870

Harms-Colibri 1x2 Tissue Forceps

Tying platform / stainless / 1 x 2 box teeth

14-1845 0.12 mm delicate  
14-1847 0.2 mm  
14-1851 0.3 mm  
14-1850 0.4 mm  
14-1852 0.5 mm



14-1845

Tying platform / titanium / 1 x 2 box teeth

T14-1845 0.12 mm delicate  
T14-1847 0.2 mm  
T14-1851 0.3 mm  
T14-1850 0.4 mm  
T14-1852 0.5 mm



T14-1845

Tying platform / wide tip / titanium / 1 x 2 teeth

T14-1845W 0.12 mm



T14-1845W

Harms-Colibri 1x2 Tissue Forceps

Tying platform / 1 x 2 angled teeth / delicate / 0.12 mm

14-1820 stainless 0.12 mm  
T14-1820 titanium 0.12 mm  
T14-1819 0.3 mm



14-1820

Polack Corneal Forceps

Colibri style / double tips / (1x2)x2=6 teeth / 3 mm spread

14-3910 0.12 mm delicate  
14-3900 0.3 mm



14-3910

Colibri style / double tips / (1x2)x2=6 teeth / 3 mm spread

T14-3910 0.12 mm delicate  
T14-3900 0.3 mm



T14-3910

Fenestrated handle / double tips / (1x2)x2=6 teeth / 3 mm spread

T14-3920 .12 mm



T14-3920

**Hyde Corneal Forceps**

Tying platform / 2 x 2 box teeth / 0.12 mm / delicate

T14-2220  
14-2220

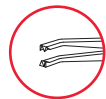

14-2220

**Bishop-Harmon 1x2 Tissue Forceps Titanium**

1 x 2 box teeth / 3 1/2" (9 cm)

T14-3803 0.3 mm  
T14-3805 0.5 mm  
T14-3810 0.8 mm  
T14-3800 0.12 mm

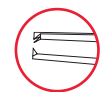

T14-3810

**Bishop-Harmon 1x2 Tissue Forceps**

1 x 2 teeth / 3 1/2" (9 cm)

14-3800 0.3 mm tip delicate  
14-3805 0.5 mm tip  
14-3810 0.8 mm tip

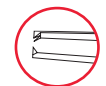

14-3810

**Castroviejo Suture 1x2 Teeth Forceps**

With tying platform / 1 x 2 teeth / stainless

14-2800 0.12 mm tip  
14-2805 0.2 mm tip  
14-2810 0.3 mm tip  
14-2860 0.3 mm tip angled tips on flat  
14-2815 0.4 mm tip  
14-2820 0.5 mm tip  
14-2880 0.5 mm tip angled tips on flat  
14-2830 0.9 mm tip  
14-2840 1.5 mm tip



14-2810

With tying platform / 1 x 2 teeth / titanium

T14-2800 0.12 mm tip  
T14-2805 0.2 mm tip  
T14-2810 0.3 mm tip  
T14-2815 0.4 mm tip  
T14-2820 0.5 mm tip  
T14-2830 0.9 mm tip  
T14-2840 1.5 mm tip

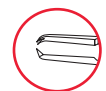

T14-2810

**Kelman & Hoffer Suture Tissue Forceps**

Angled / tying platform / 1 x 2 box teeth / 0.12 mm / ergonomic handle

14-2935

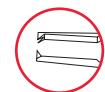

14-2935

**Lester Fixation 1x2 Tissue Forceps**

4" (10 cm)

14-4600 1 x 2 teeth  
14-4620 2 x 3 teeth

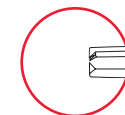

14-4620

**Lester Fixation Tissue Forceps**

Serrated tip / 4" (10 cm)

14-4625



14-4625

**Girard 1x2 Fixation Forceps**

With sliding lock / 1 x 2 angled teeth

14-3240 0.3 mm  
14-3245 0.9 mm  
14-3246 0.5 mm

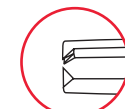

14-3240

With sliding lock / 0.5 mm / with tying platform / 1 x 2 angled teeth

14-3247 curved  
14-3248 straight



14-3245



14-3247

**Strabismus Forceps**

1x2 teeth / slide lock

14-3150 straight  
14-3152 right  
14-3154 left



14-3150



14-3152



14-3154

**Girard 1x2 Fixation Forceps**

With push lock / 1 x 2 box teeth

14-3260A 0.3 mm  
14-3260B 0.5 mm  
14-3260C 0.9 mm  
14-3260D 1.2 mm

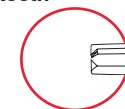

**Bonaccolto Suture Forceps**

Conjunctiva forceps / longitudinally serrated jaws / with cross serrations at tips / straight

- 14-6500 1.2 mm tip
- 14-6510 1.7 mm tip



Titanium / conjunctiva forceps / longitudinally serrated jaws / with cross serrations at tips / straight

- T14-6500 1.2 mm tip
- T14-6510 1.7 mm tip



14-6510



T14-6510

**Barraquer Cilia Forceps**

TC Dust / slightly angled

- 14-6303

Titanium / TC dust / slightly angled

- T14-6303



14-6303



T14-6303

**Gradle Cilia Forceps**

Smooth square jaws

- 14-6400
- T14-6400 titanium



14-6400



T14-6400

**Cilia Forceps**

Smooth jaws / polished finish / serrated handle / narrow

- 14-6415



14-6415

**Graefe Fixation Forceps**

4.5 mm jaw / 4 1/2" (11.5 cm)

- 14-5120 with lock
- 14-5122 with lock curved
- 14-5130 without lock



14-5120



14-5122



14-5130

**Green Fixation Forceps**

Atraumatic integrating teeth / 4" (10 cm)

- 14-5200 5 mm jaw
- 14-5205 5 mm jaw with lock
- 14-5215 10 mm jaw with lock
- 14-5220 10 mm jaw

Titanium / atraumatic integrating teeth / 4" (10 cm)

- T14-5220 10 mm jaw
- T14-5200 5 mm jaw



14-5215



14-5220



T14-5220

**Sontec Eye Lid Forceps**

Serrated / 5" (12.5 cm)

- 14-5240



14-5240

**Desmarres Chalazion Clamp Forceps**

Lower solid blade / stainless

- 14-9900 17 mm
- 14-9901 21 mm
- 14-9902 28 mm

Lower solid blade / laser finished

- 14-9893 17 mm
- 14-9894 21 mm
- 14-9895 28 mm

Lower solid blade / blue electro coat

- 14-9896 17 mm
- 14-9897 21 mm
- 14-9898 28 mm



14-9901

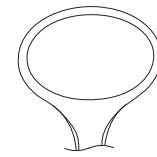

small (17 mm)

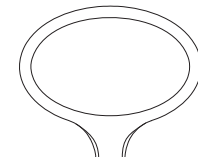

medium (21 mm)

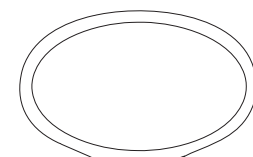

large (28 mm)

**Desmarres Severin Chalazion Clamp Forceps**

Two open tips / both blades fenestrated

- 14-9908 17 mm
- 14-9907 21 mm
- 14-9906 28 mm

Two open tips / both blades fenestrated

- T14-9908 17 mm
- T14-9907 21 mm
- T14-9906 28 mm



14-9908



17 mm

21 mm

28 mm



T14-9908



T14-9907

**Kelman-McPherson 1x2 Tissue Forceps**

8 mm long / 0.3 mm / angled / 1 x 2 box teeth

- 14-2630

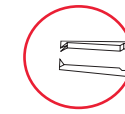

14-2630

**Stern-Castroviejo Suture 1x2 Tissue Forceps**

6 mm long / 1 x 2 box teeth / 0.5 mm / straight / handle with thumb catch lock

- 14-2890

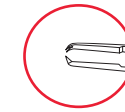

14-2890

**Manhattan 1x2 Tissue Forceps**

Tying platform / 1 x 2 box teeth / stainless

- 14-3050 0.7 mm
- 14-3070 0.6 mm
- 14-3060 0.3 mm

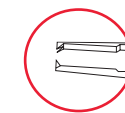

14-3070

Tying platform / 1 x 2 box teeth / titanium

- T14-3050 0.7 mm
- T14-3070 0.6 mm
- T14-3060 0.3 mm

**Manhattan Severin 1x2 Tissue Forceps**

Tying platform / 1 x 2 angled teeth / stainless

- 14-3073 0.12 mm delicate
- 14-3075 0.3 mm
- 14-3071 0.5 mm
- 14-3072 0.6 mm
- 14-3077 0.7 mm
- 14-3074 0.9 mm

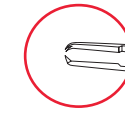

14-3077

Tying platform / 1 x 2 angled teeth / titanium

- T14-3073 0.12 mm delicate
- T14-3075 0.3 mm
- T14-3071 0.5 mm
- T14-3072 0.6 mm
- T14-3077 0.7 mm
- T14-3074 0.9 mm

**Bracken 1x2 Fixation Forceps**

1 x 2 teeth / angled / 4 1/4" (10.5 cm)

- 14-4800

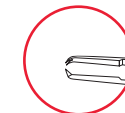

14-4800

**Lester Fixation 1x2 Tissue Forceps**

4" (10 cm)

- 14-4600 1 x 2 teeth
- 14-4620 2 x 3 teeth

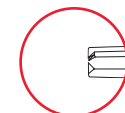

14-4620



 Sontec Instruments®

Eye ENT SCISSORS

**Stevens Tenotomy Ergonomic Spread Handle Power Cut Black® Scissors**

Blunt / long tip / PC black / ergonomic spread handle / curved / 4 1/2" (11.5 cm)

1200-708

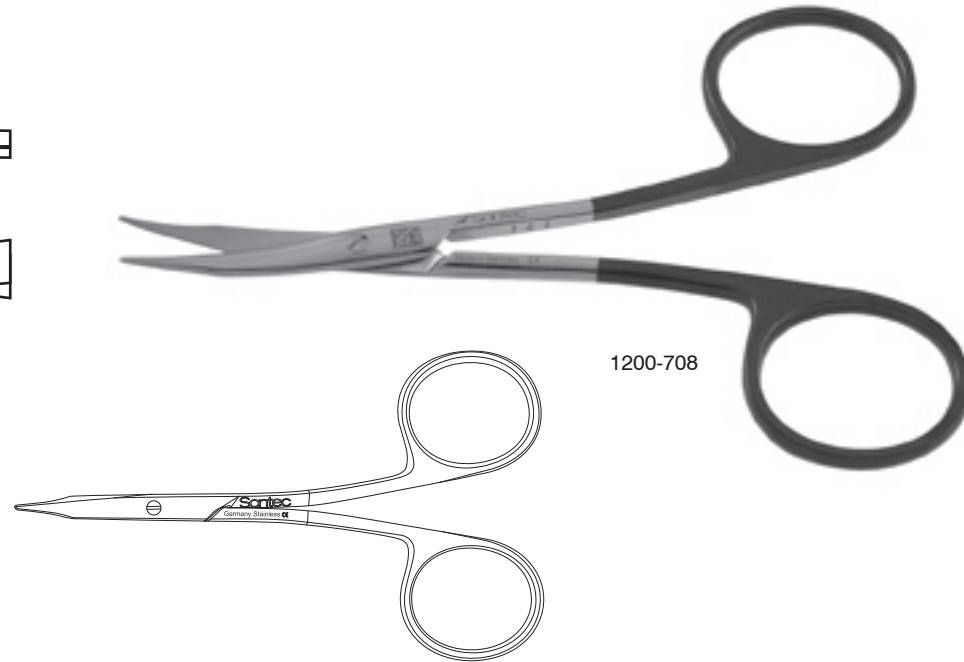
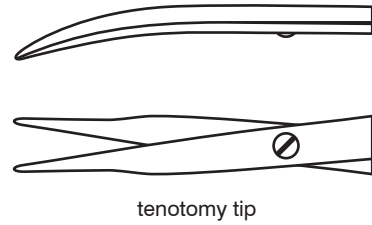

**Ceramitec Stevens Tenotomy Ergonomic Spread Handle Power Cut Black® Scissors**

Black with gold screw / blunt / long tip / PC Black / ergonomic spread handle / curved / 4 1/2" (11.5 cm)

1200-935



**Stevens Tenotomy Classic, Tungsten Carbide, Power Cut Gold, Power Cut Black®, Ceramic Coated Scissors**

Blunt / short blades / PC Black / 4 3/4" (12 cm)

1200-701 straight  
1200-705 curved

Blunt / long blades / classic / 5" (13 cm)

2400-364 straight  
2400-366 curved

Blunt / long blades / PC black / 5" (13 cm)

2400-865 straight  
2400-867 curved

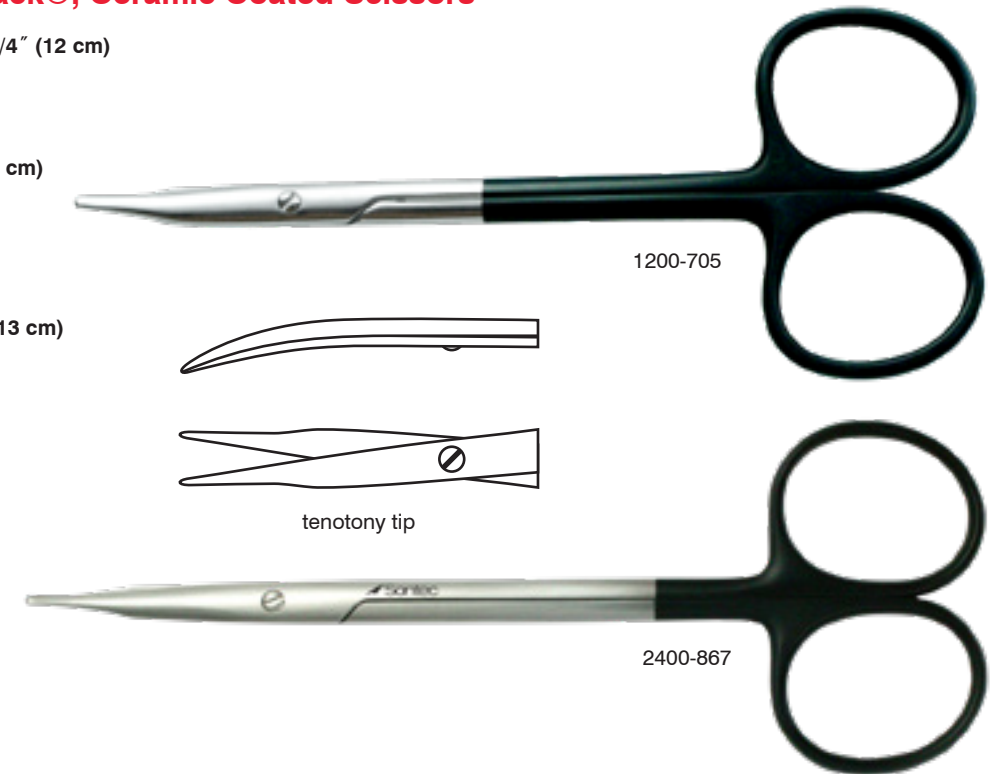

**Stevens Tenotomy Classic PC Gold Scissors**

Pointed sharp tips / short blades / classic / 4 1/8" (10.5 cm)

13-8805 straight  
13-8815 curved

Pointed sharp tips / long blades / classic / 4 1/2" (11.5 cm)

13-8820 straight  
13-8825 curved

Pointed sharp tips / long blades / PC Gold / 4 1/2" (11.5 cm)

13-8865 straight  
13-8866 curved



**Bonn Scissors**

**Classic / 3 1/2" (9 cm)**

- 13-7550 straight
- 13-7560 curved

**PC / 3 3/4" (9.5 cm)**

- 1200-008 straight
- 1200-009 curved

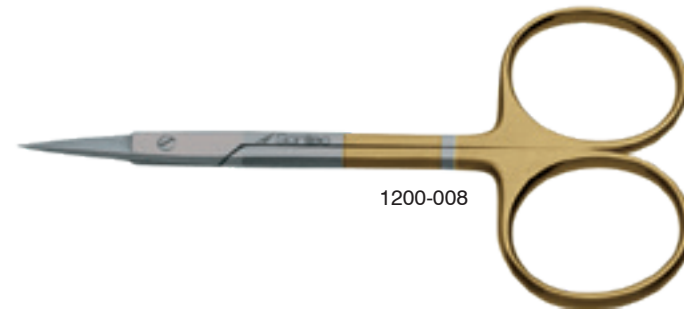
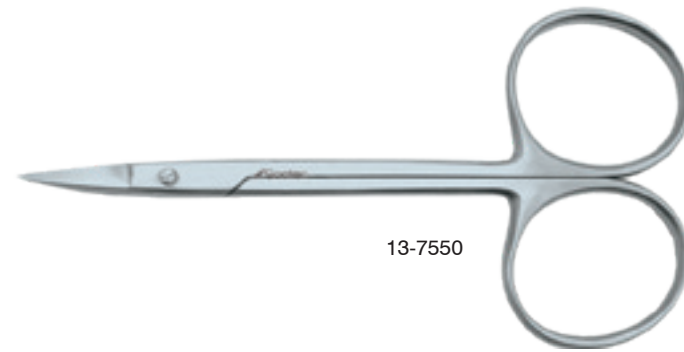

**Utility Scissors**

**Ribbon handled / delicate flat blade / slight curve / 4" (10 cm)**

- 13-9340 PC Gold
- 13-9341 PC Black

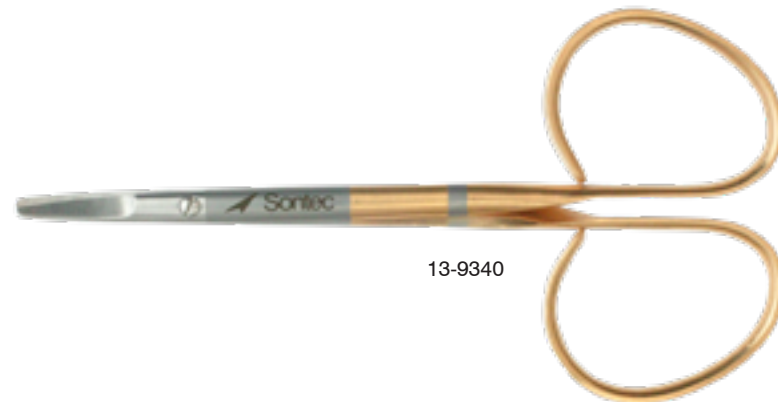

**Strabismus Classic Tungsten Carbide Power Cut Gold® Power Cut Black® Scissors**

**Delicate / PC gold / 4 1/4" (11 cm)**

- 1200-021 straight
- 1200-023 curved

**Classic / 4 1/2" (11.5 cm)**

- 1100-344 straight
- 1100-346 curved

**PC gold / 4 1/2" (11.5 cm)**

- 1200-020 straight
- 1200-022 curved

**PC black / 4 1/2" (11.5 cm)**

- 1200-775 straight
- 1200-776 curved

**PC black / sharp/sharp tips / curved / 4 1/2" (11.5 cm)**

1200-776S

**TC / 4 1/2" (11.5 cm)**

- 2400-360 straight
- 2400-362 curved



**Iris Stille Classic Large Cut Out Rings Scissors**

**Curved / 4" (10.2 cm)**

13-7786



**Iris Classic Tungsten Carbide Power Cut Gold®  
Power Cut Black® TC/PC Scissors**

**Delicate / mini model / 3 1/2" (9 cm)**

- 13-7500 straight
- 13-7510 curved

**Ribbon handle / mini pattern / classic / 14 mm blades / 3 3/4" (9.5 cm)**

- 13-7720 straight
- 13-7730 curved

**PC gold / sharp tips / 4" (10 cm)**

- 2400-010 straight
- 2400-012 curved

**PC gold / blunt / 4" (10 cm)**

- 2400-015 straight
- 2400-017 curved

**PC black / sharp tips / 4" (10 cm)**

- 2400-710 straight
- 2400-712 curved

**Classic / 4 1/8" (10.2 cm)**

- 13-7528 straight
- 13-7530 curved

**Classic / delicate / 4 1/8" (10.2 cm)**

- 13-7524 straight
- 13-7526 curved

**PC gold / 4 1/8" (10.2 cm)**

- 13-7532 straight
- 13-7533 curved

**PC gold / delicate / 4 1/8" (10.2 cm)**

- 13-7520 straight
- 13-7522 curved



**Sontec® Stitch Scissors**

**Ribbon handle / Needle point tip / sharp tips / curved**

- 199-517 4" (10 cm)
- 199-520 4 1/2" (11.5 cm)
- 199-522 5" (13 cm)

**Classic rings / needle point tip / sharp / curved / 5" (12.7 cm)**

- 199-524

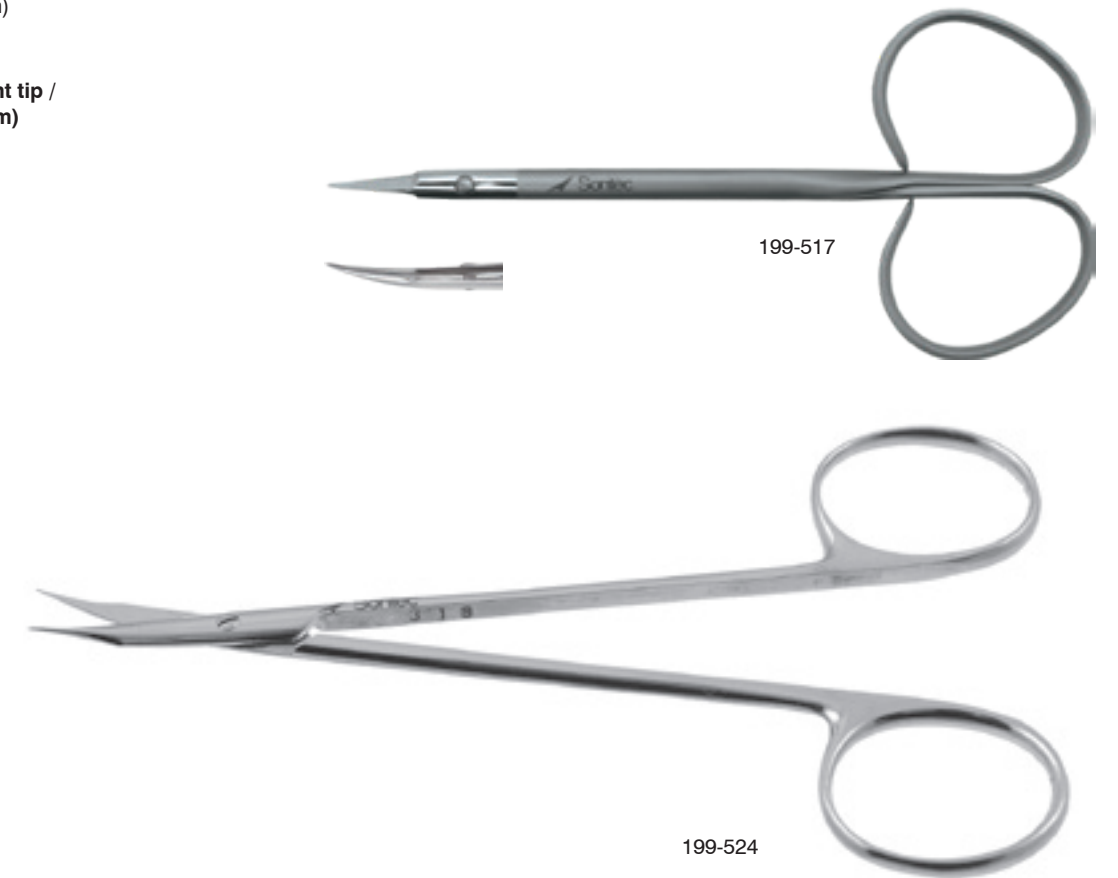

**O'Brien Stitch Scissors**

**Side-angled / sharp tips / 3 3/4" (9.5 cm)**

- 134-304 classic
- 134-305 PC gold



**Walton Thorek Scissors**

PC gold / beveled blades / full curved / 6 1/2" (16.5 cm)

508-624



**Fomon Lateral Scissors**

PC Gold / right-angled / beveled blades / 4 1/2" (11.5 cm)

508-622

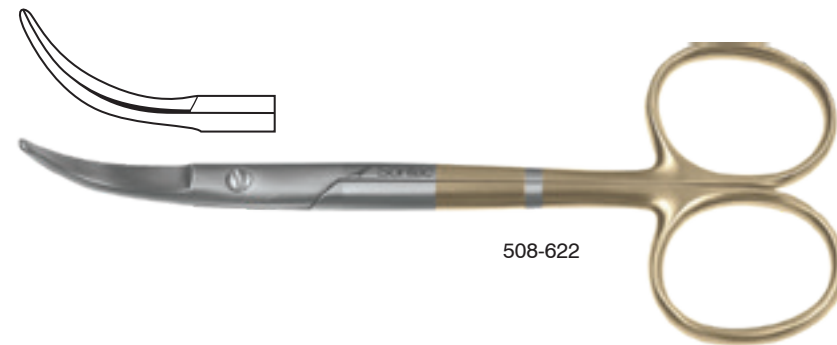

**Cinelli lower lateral Scissors**

PC Gold / full curve / 4 1/2" (11 cm)

508-619



**Fomon Scissors**

PC Gold / right-angled / 5 1/2" (14 cm)

508-615



**Enucleation Scissors**

PC Gold / 5 1/4" (13 cm)

- 13-9805 light curve
- 13-9810 medium curve
- 13-9820 full curve
- 13-9822 full curve PC Black



**Baby Stratte Scissors**

PC Gold / full s-curved / 5 1/2" (14 cm)

- 508-616 metzenbaum tip
- 508-618 tenotomy tip

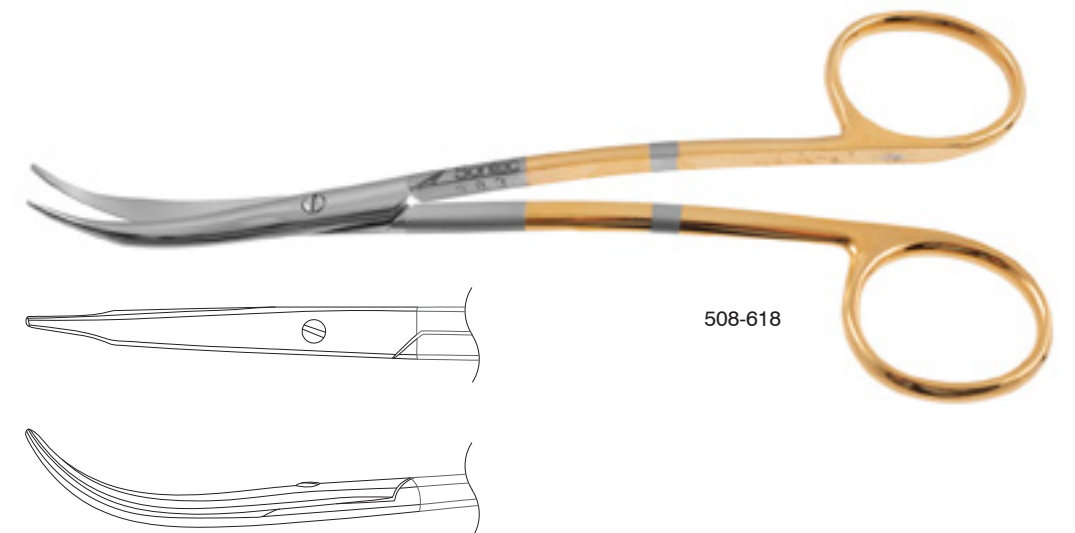

**Noyes Iris Scissors**

Flat handle / straight / 4 1/2" (11.5 cm)

- 13-3420 sharp-sharp
- 13-3425 sharp-blunt
- 13-3430 blunt-blunt



Flat handle / curved / sharp-sharp tips / 4 1/2" (11.5 cm)

13-3435



13-3435

**Noyes Iris Scissors**

Round handle / blunt tips / slightly curved / 4" (10.2 cm)

13-3460



13-3460

**Castroviejo Corneoscleral Scissors**

Small 8 mm blades / 4" (10.2 cm)

- 13-1300 right
- 13-1310 left

Small / medium 10 mm blades / 4" (10.2 cm)

- 13-1306 right
- 13-1307 left

Medium 12.5 mm blades / 4" (10.2 cm)

- 13-1320 right
- T13-1320 right titanium
- 13-1330 left
- T13-1330 left titanium

Large blades / 4" (10.2 cm)

- 13-1340 right
- 13-1350 left



13-1306



13-1307



13-1320



13-1330



right

left

**Westcott Tenotomy Scissors**

Curved sharp tips / medium blades / 4 3/4" (12.1 cm)

13-3303 fenestrated handle



13-3303

Curved blunt tips / medium blades / 4 3/4" (12.1 cm)

13-3304 fenestrated handle



13-3304

**Westcott Utility Scissors**

Sharp / round blades / curved / 5 1/4" (13.3 cm)

13-3311



13-3311

**Titanium Westcott Tenotomy Scissors**

Blunt tip / fenestrated handle / 4 1/2" (11.5 cm)

- T13-3417 curved
- T13-3418 straight



T13-3417

**McPherson-Westcott Stitch Scissors**

Curved sharp tips / small blades / 4" (10.2 cm)

13-4300



13-4300

**Castroviejo Corneal Scissors**

Curved blunt tips / 4 1/4" (10.8 cm)

- 13-2500 small
- 13-2520 medium
- 13-2540 large



13-2500

Curved blunt tips / 4 1/4" (10.8 cm)

- 13-2500F small
- 13-2520F medium



13-2520F

**Azar Corneal Scissors**

Caliper blade / 11 mm blades / 4 1/4" (10.8 cm)

- 13-1840 curved blades
- 13-1842 full curved blades



13-1840

**Castroviejo Keratoplasty Scissors**

Angled to side / medium blades / 4" (10.2 cm)

- 13-3140 sharp
- 13-3150 blunt



13-3150

**Castroviejo Keratoplasty & Keratectomy Wide Handle Scissors**

Curved / wide serrated handles

- 13-3160 5 1/4" (13 cm)
- 13-3162 5 3/4" (14.5 cm)



13-3160

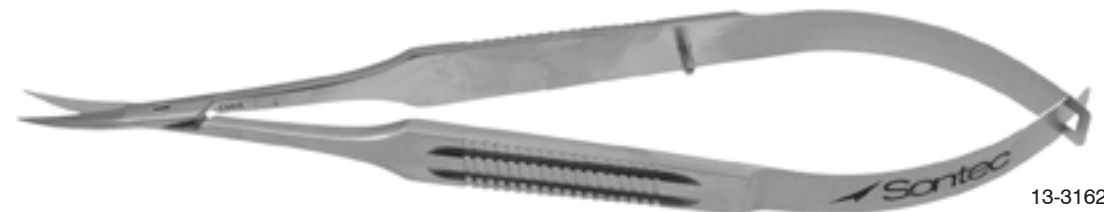

13-3162

**Westcott Stitch Scissors**

Sharp tips / classic blades / 4 1/2" (11.5 cm)

- 13-4400 curved
- 13-4402 straight



13-4400



13-4402

**Westcott Wide Handle Tenotomy Scissors**

Wide handle / curved / classic blades / 5 1/2" (14 cm)

- 13-3307 sharp
- 13-3306 blunt
- 13-3307S blunt serrated blades



13-3306



13-3307

**Westcott Wide Handle Conjunctival Scissors**

Lightly curved / blunt tip / wide serrated handle / 5 1/2" (14 cm)

- 13-3301



13-3301



 Sontec Instruments®

Veterinary Small & Equine Large Animal Specialty

**Snook Ovariectomy**

8" (20 cm)  
1100-756



1100-756

**Snook Feline Spay**

8" (20 cm)  
1100-758



1100-758

**Tankersly Ovariectomy Hook**

Used in Laparoscopic approach / 8 1/4" (21 cm)  
1100-757



1100-757

**Michel Clips Applier Remover**

For Michel Clips / apply / remove forceps / 4 3/4" (12 cm)  
1100-781

Stainless / 100 per box / steel clips

- 1100-772 11 mm
- 1100-774 14 mm
- 1100-776 16 mm
- 1100-778 18 mm
- 1100-780 22 mm

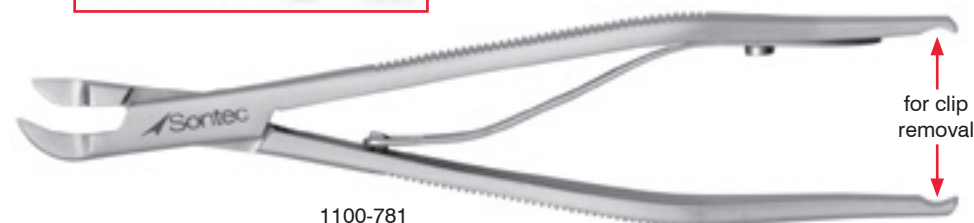

for clip removal

1100-781

**Lubra™ Plates**

Plastic / available straight or curved / autoclavable / ethylene oxide sterilizable / easily adaptable for a variety of animals / trim with bone cutters to fit the patient / checkered surface forms friction grip / lock into position with stainless steel bolts

**CURVED Lubra™ Plates**

Sold in pairs / available small, medium, large, or extra large / unique design / flexible and contouring / for dogs, cats, and subhuman primates / use when stabilization of the spinal column is required

**STRAIGHT Lubra™ Plates**

Sold individually / for ventral fixation of the cervical vertebrae in the canine "wobbler syndrome" / also used for fractures of the scapula or pelvis, and reconstructive surgery of chest or orbit



**Bolt set includes:**

- 1 bolt
- 1 washer
- 1 nut



Bolt set made with 316L Implantable Stainless Steel



checkered surface, front side



smooth surface, back side

**Lubra™ Wrench**

- 1106-960 3 1/2" (9 cm)
- 1106-962 5" (12.7 cm)



1106-960

1106-962

**Lubra Stainless Steel Nut Only**

1106-948



**Lubra Stainless Steel Washer Only**

1106-948



**Lubra™ Plates**

Item Number	Description	Patient Weight	Approximate Length	Number of Bolts Required
1106-900	small, cvd (pair)	under 20 lb	4" (10 cm)	6
1106-905	medium, cvd (pair)	20 - 40 lb	5 3/4" (14.5 cm)	8
1106-910	large, cvd (pair)	40 - 70 lb	8" (20 cm)	8
1106-915	extra large, cvd (pair)	over 70 lb	13" (33 cm)	10
1106-930	str, 7/16" wide (single)	(multi-purpose)	3 7/16" (8.5 cm)	varies
1106-935	str, 1/2" wide (single)	(multi-purpose)	3 7/16" (8.5 cm)	varies

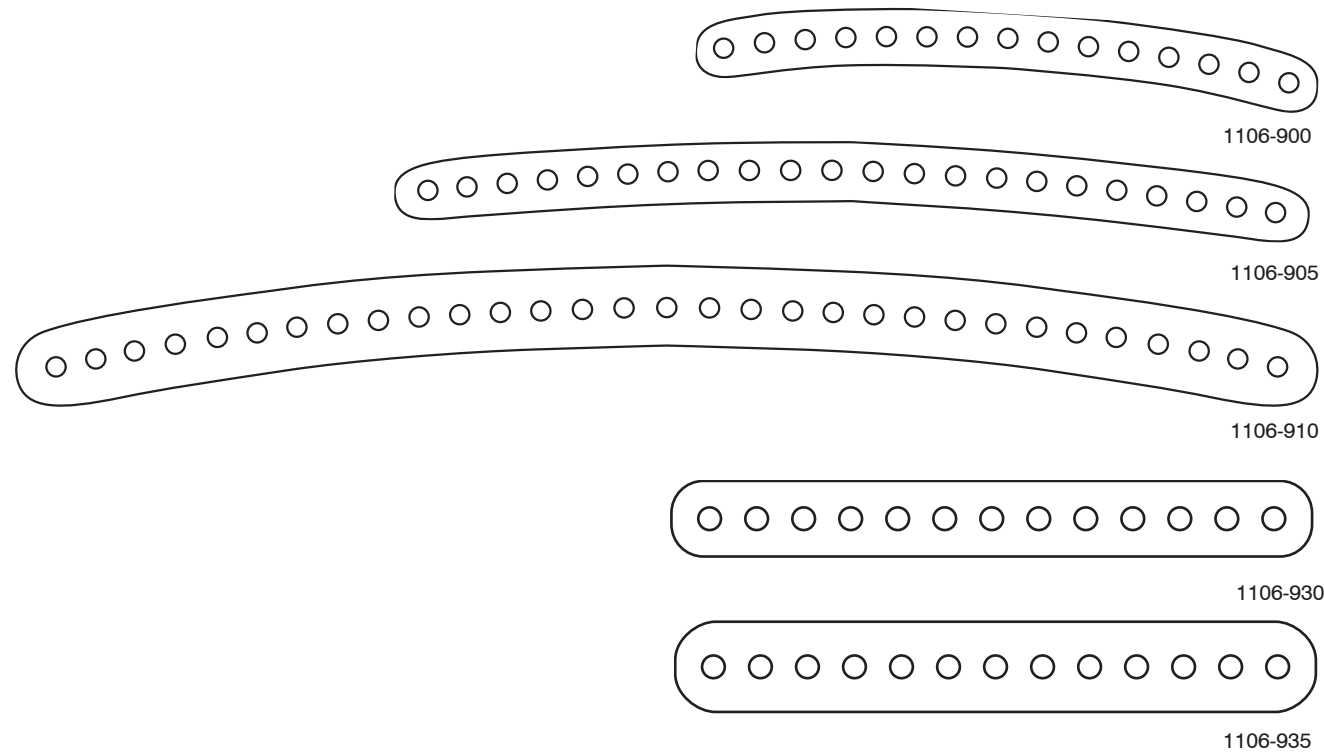

**Lubra Stainless Steel Bolt**

- 1106-950 1/2"
- 1106-949 3/4"
- 1106-952 1"
- 1106-950H 1/2"
- 1106-949H 3/4"
- 1106-952H 1"



**Stainless Steel Bolts**

For use with Lubra™ Plates / includes bolt, washer and nut

- 1106-940 1/2"
- 1106-945 3/4"
- 1106-946 1"



Hex Head Available

**Equine Epiglottis Entrapment Knife**

29" (74 cm) handle / includes one blade

- 1404-885-SET handle with single blade
- 1404-886-SET handle with double blades
- 1404-887-SET handle with both blades
- 1404-890 single blade only
- 1404-8902 double blade only
- 1404-885H handle only

\* Extra long instrument. Many Extra long instruments are also available, including:

- Extra long scissors
  - Extra long needle holders
  - Extra long forceps
  - Extra long knife handles
- Please call Sontec® for details

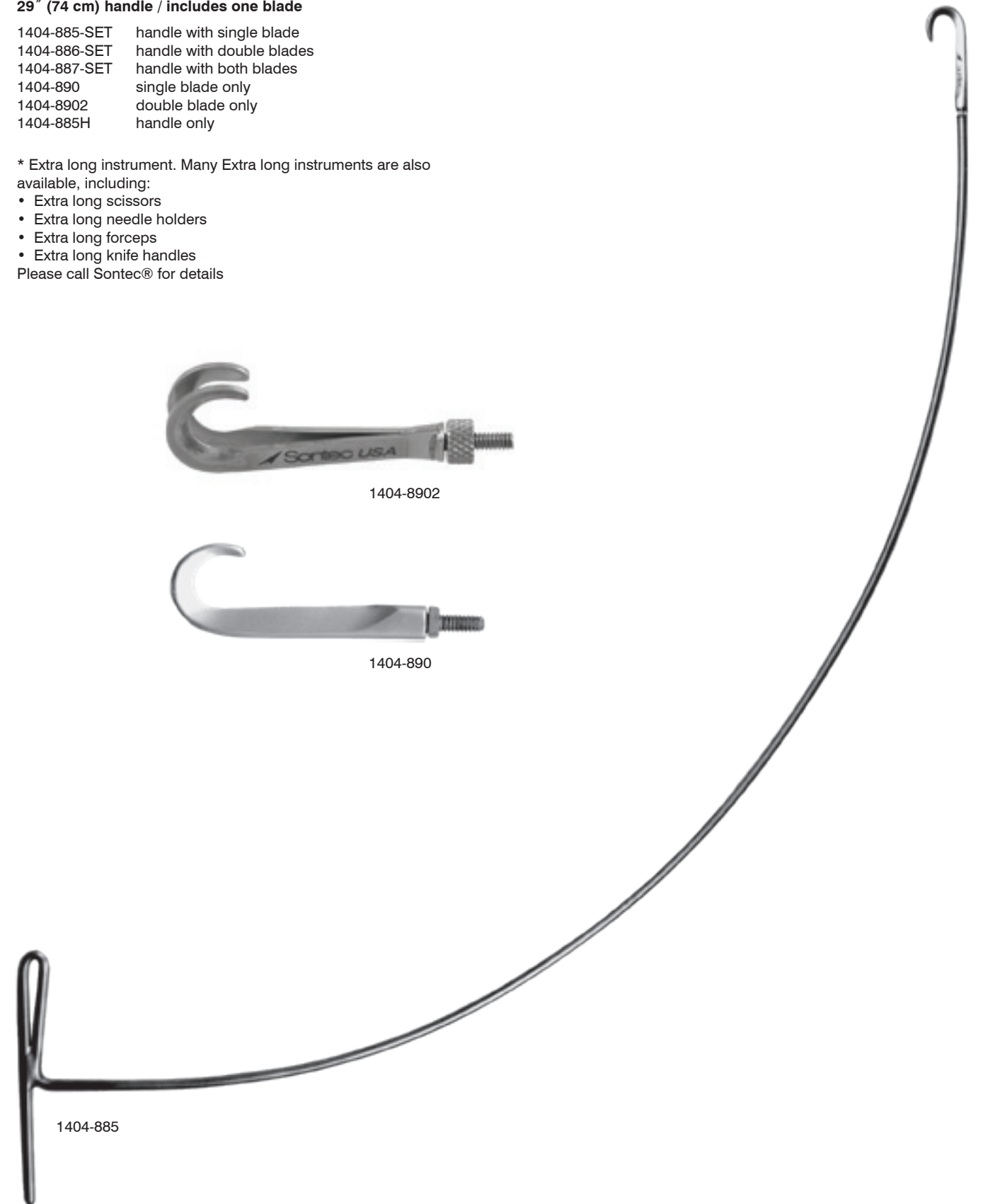

**Serra Modified Emasculator**

Curved / 14" (35.5 cm)  
1100-903  
1100-905 w/ ratchet



**Reimer Emasculator**

With ratchet / 12 1/2" (32 cm)  
1100-904



**Embertson Esophageal Epiglottis Scissors**

30" (75 cm) long / Metzenbaum tip / curved shaft  
1404-883B curved shaft black coated  
1404-883BM curved shaft black coated malleable  
1404-883BH curved shaft black coated  
1404-884BM straight shaft black coated malleable



**Esophageal Epiglottis Hook Scissors**

30" (75 cm) long / curved shaft  
1404-882B black coated  
1404-882BM malleable



**Harrison Needle Holder**

TC serrated / stainless / round handle / with lock  
1103-889 6" (15 cm)  
1103-890 7 1/4" (18.5 cm)



**University of Pennsylvania Equine Biopsy**

5 mm x 20 mm jaw / 26" (66 cm) shaft

1100-728

1100-728S detachable handle 360° rotating shaft



**Cerclage Wire**

Stainless steel

1106-629	18 gauge	1106-623	25 gauge
1106-628	19 gauge	1106-622	27 gauge
1106-627	20 gauge	1106-621	30 gauge
1106-626	21 gauge	1106-620	36 gauge
1106-625	22 gauge	1106-619	24 gauge
1106-624	23 gauge	1106-618	26 gauge



**Shanz Pin**

Package of 6 / partially threaded / 45 mm thread length / 5 mm diameter

1106-631	6" (15.5 cm)
1106-632	6 3/4" (16 cm)
1106-633	8" (20.5 cm)
1106-634	10" (25.5 cm)



**Steinmann Trocar Pin Kit Deluxe**

Comes with autoclavable pin bag

1106-730 set

Set includes:

0.9 mm	k-wire	6 each
1.1 mm	k-wire	6 each
1.6 mm	k-wire	6 each
1.6 mm	IM pin	4 each
2.0 mm	IM pin	4 each
2.3 mm	IM pin	6 each
2.6 mm	IM pin	6 each
3.0 mm	IM pin	6 each
3.4 mm	IM pin	6 each
3.8 mm	IM pin	6 each
4.5 mm	IM pin	4 each
6.0 mm	IM pin	4 each

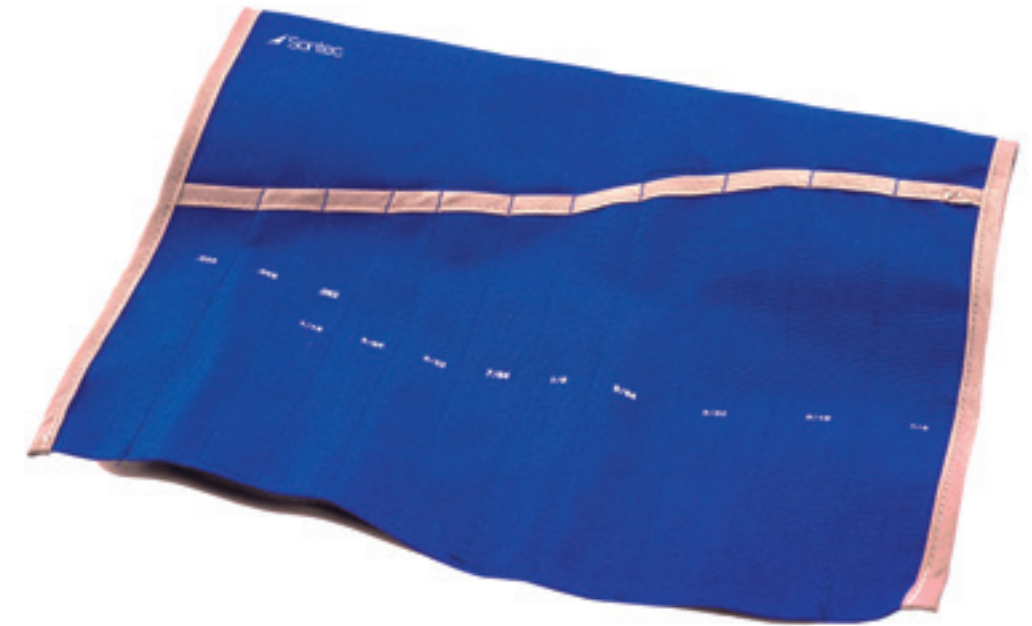

**External Fixator TPLO Set**

Set includes rack, nut, screw, rod and allen wrench

- 1106-990 2.7 mm
- 1106-992 3.5 mm



**Scudder Intestinal Clamp**

Heavy / 22" (55.88 cm)

1404-895



Double screw end / 22" (55.88 cm)

1404-897



**Stainless Steel Feeding & Dosing Cannula**

Needles for Veterinary Use adapted for flushing and injection procedures in small animals, including:  
 Treating feline urologic syndrome / flushing ear canal / rectal flushing and injection / many other innovative uses

**Straight**

Item #	Length	Gauge	Ball Size
1103-750	1 1/2" (4 cm)	22	2.4 mm
1103-752	1 1/2" (4 cm)	20	2.4 mm
1103-754	2" (5 cm)	18	2.4 mm
1103-756	3" (7.5 cm)	16	3.0 mm
1103-758	3" (7.5 cm)	14	4.0 mm
1103-760	4" (10 cm)	12	6.4 mm
1103-762	6" (15 cm)	10	6.4 mm



**Curved**

Item #	Length	Gauge	Ball Size
1103-770	1 1/2" (4 cm)	22	2.4 mm
1103-772	1 1/2" (4 cm)	20	2.4 mm
1103-774	2" (5 cm)	18	2.4 mm
1103-776	3" (7.5 cm)	16	3.0 mm
1103-778	3" (7.5 cm)	14	4.0 mm
1103-780	4" (10 cm)	12	6.4 mm
1103-782	6" (15 cm)	10	6.4 mm



**3.0 mm Micro External Fixator Set**

1106-970-SET set

- Set includes:  
 8 locks (1106-971)  
 8 screws (1106-974)  
 1 allen wrench (1106-975)  
 10 k-wire pins (1106-972)  
 2 rods (1106-973) OR (1106-973C)



3.0 mm

**For reordering individual parts:**

1106-971	1 lock	5.0 mm		
1106-972	10 k-wire pins	.062"	smooth double tocar	6" ( 15 cm)
1106-973	2 rods	3.0 mm	stainless steel serrated	8" (20.5 cm)
1106-973C	2 rods	3.0 mm	carbon fiber	8" (20.5 cm)
1106-974	1 screws	3.0 mm		
1106-975	1 allen wrench			2" (5 cm)

\* K-wires and Pins may be ordered with threading and/or other models

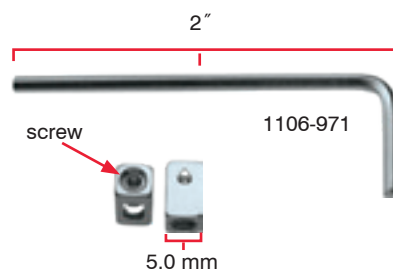
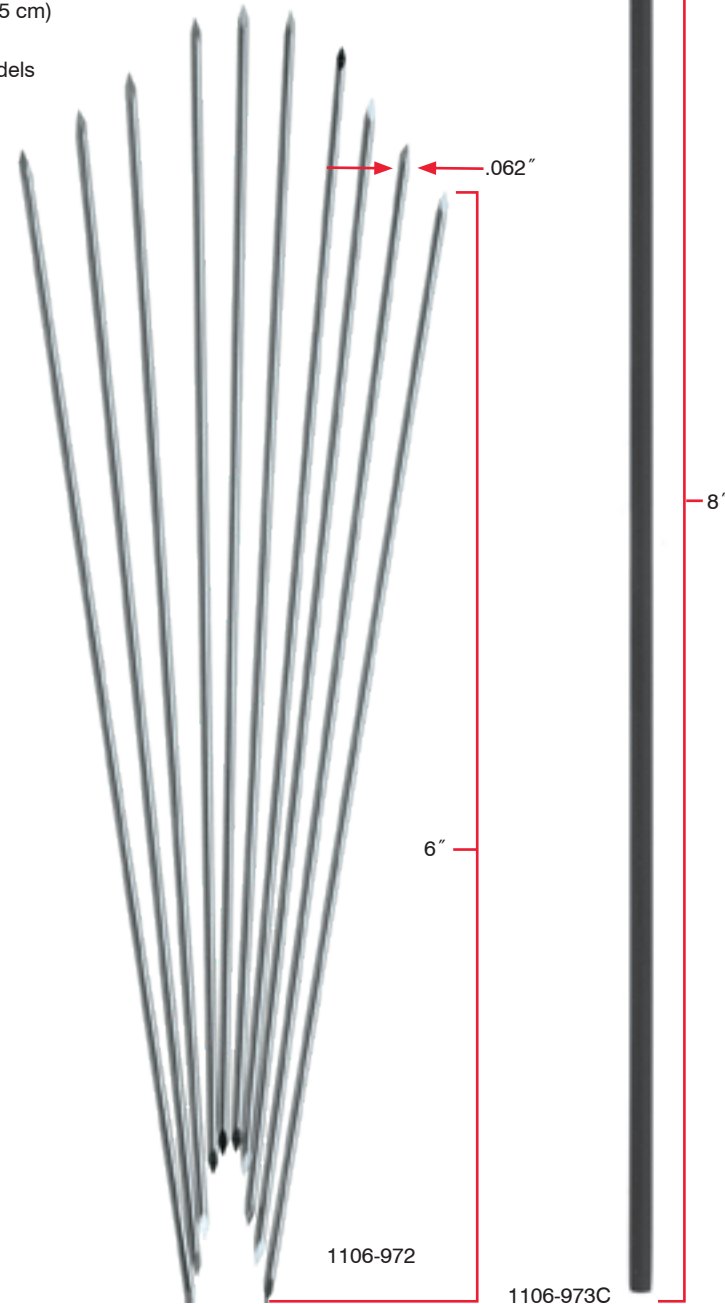
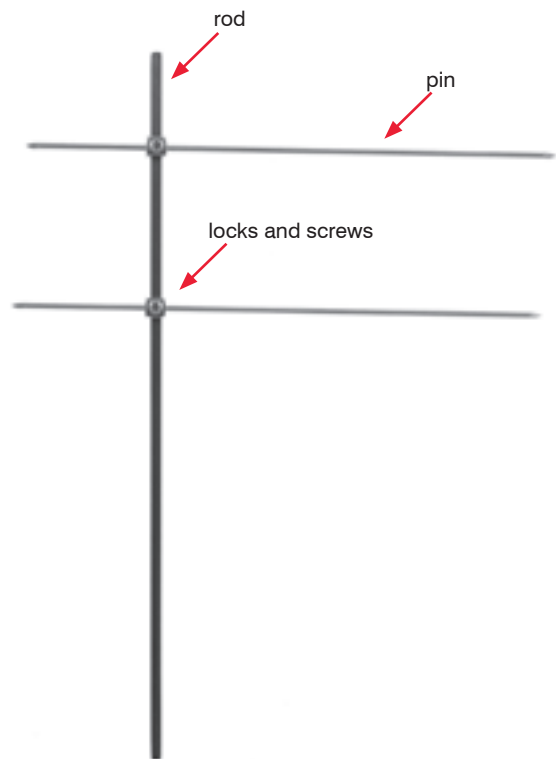

1106-972

1106-973C

8"

6"

**4.0 mm Micro External Fixator Set**

1106-980-SET set

- Set includes:  
 8 locks (1106-981)  
 8 screws (1106-984)  
 1 allen wrench (1106-985)  
 10 k-wire pins (1106-982)  
 2 rods (1106-983) OR (1106-983C)



4.0 mm

**For reordering individual parts:**

1106-981	1 lock	4.0 mm		
1106-982	10 Steinmann pins	5/64"		6" ( 5 cm)
1106-983	2 rods	4.0 mm	stainless steel serrated	8" (20.5 cm)
1106-983C	2 rods	4.0 mm	carbon fiber	8" (20.5 cm)
1106-984	1 screw	4.0 mm		
1106-985	1 allen wrench			2" (5 cm)

\* K-wires and Pins may be ordered with threading and/or other models

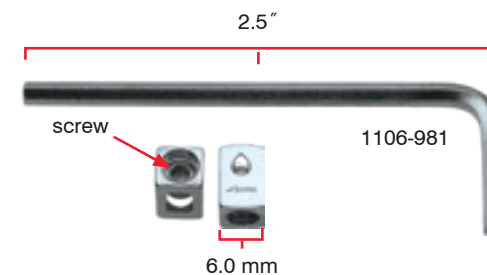
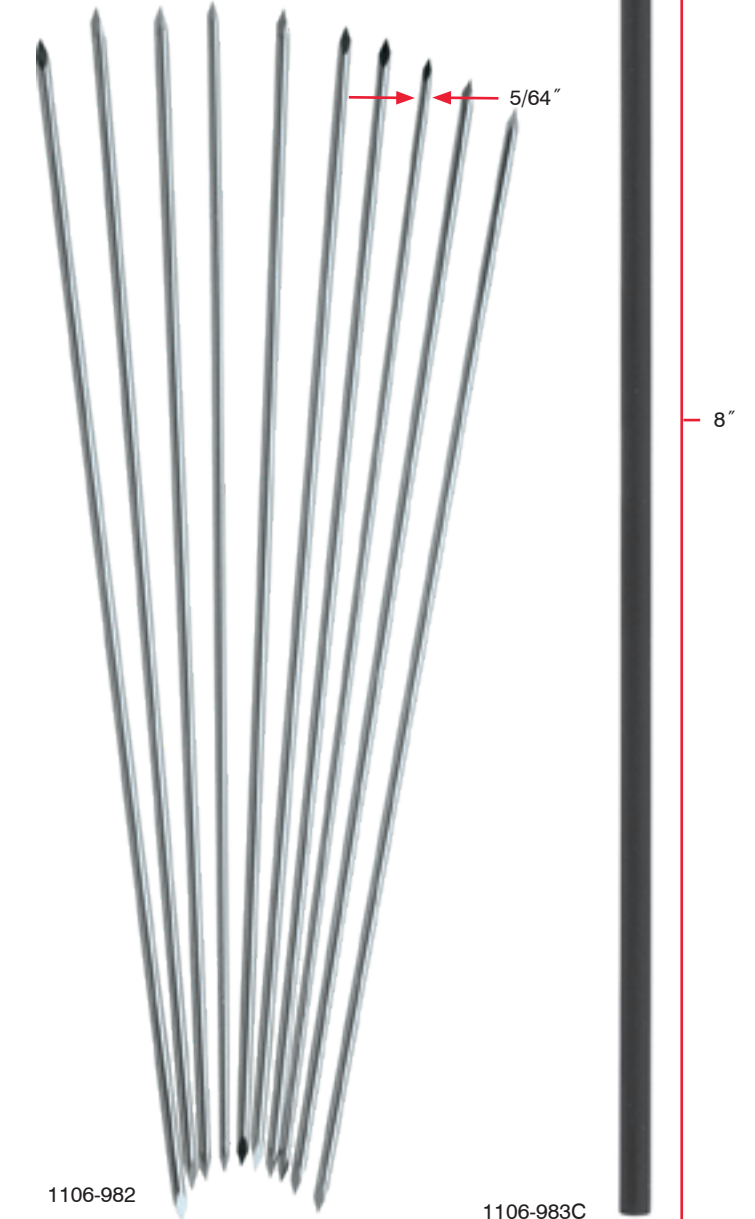
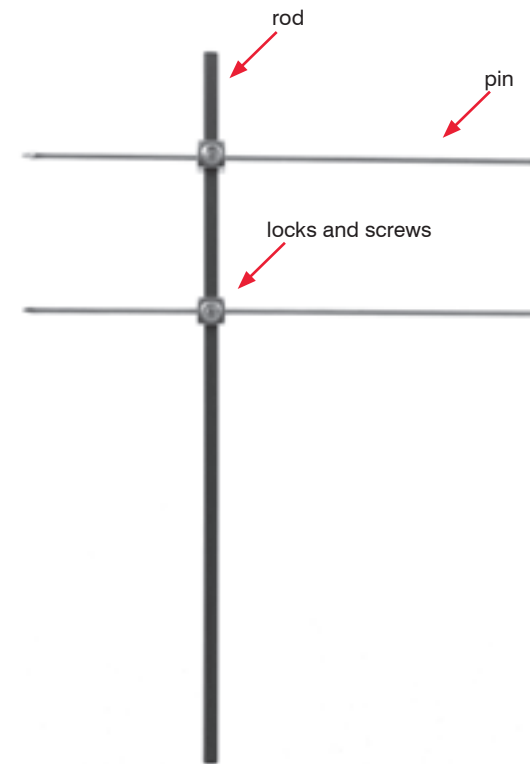

1106-982

1106-983C

8"

**Telescoping Metal Fragment Retriever**

Magnetic / 5" (12.5 cm) closed / chrome / 25" extended  
1404-840

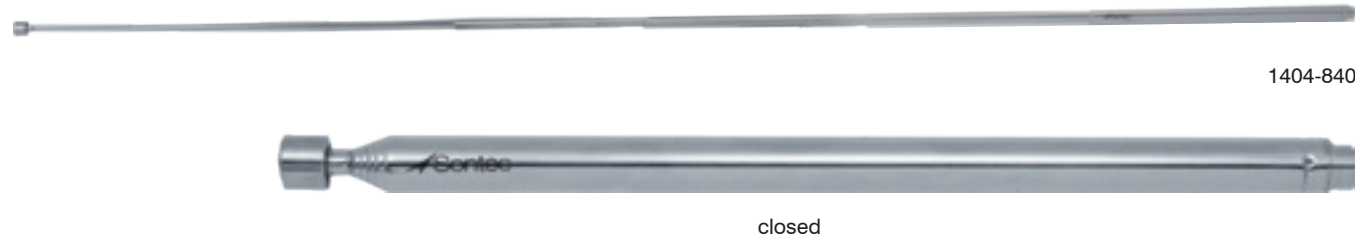

1404-840

closed

**Universal Magnet for Retrieval/Demagnetizing**

1404-841 tubular handle 6" (15 cm)  
1404-841P phenolic handle 7" (18 cm)



1404-841



1404-841P

**Virginia Roaring Burr Short**

9" (23 cm)  
1271-281D right clockwise is for the left ventricle  
1271-282 left counter clockwise is for the right ventricle



1271-281D

**Virginia Roaring Burr Long**

41 1/2" (104 cm)  
1271-283 right long-clockwise is for the left ventricle  
1271-284 left long-counter clockwise is for the right ventricle

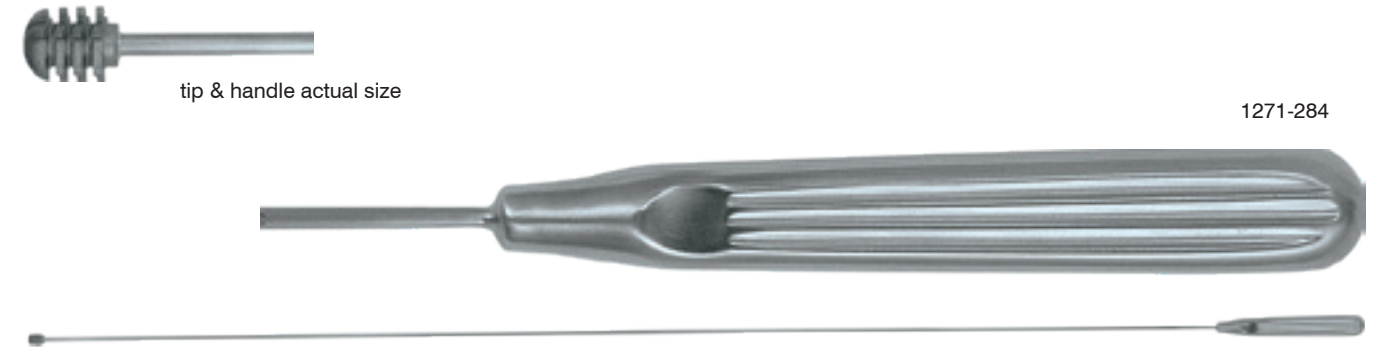

tip & handle actual size

1271-284

**Hobday's Roaring Retractor**

Self-retaining  
1101-560 standard 25 mm blades  
1101-561 long 40 mm blades



1101-561

**Depth Gauge**

6 1/4" (16 cm) /  
Screw size 2.4 - 4.0 /  
10 mm - 60 mm

355-162

8 3/4" (22 cm) /  
Screw size 3.5 - 6.5 /  
10 mm - 90 mm

355-163

Screw size 3.5 - 6.5 /  
10 mm - 120 mm

355-163L



1.) Scale

a.) Scale gradations  
please mark your desired scale design

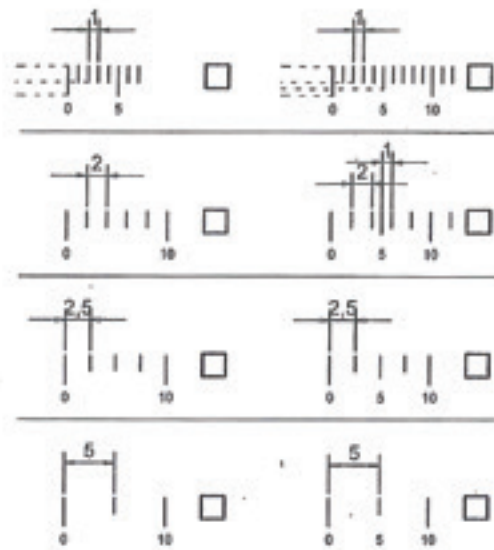

b.) length of scale    \_\_\_ mm  
                                  \_\_\_ mm

c.) customized scale (please add your drawing)

2.) Distance dimension of zero-point to the tip distance

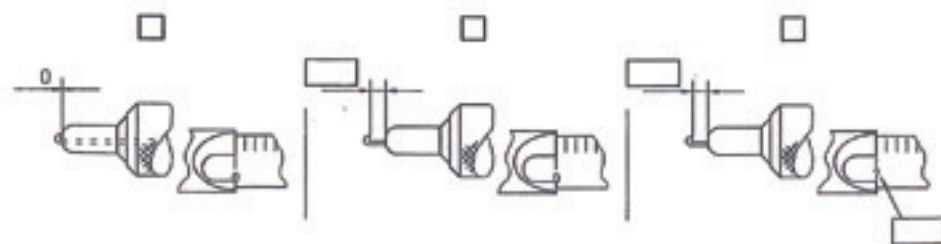

**Depth Gauge EZ Clean**

355-170	1.2/1.5mm	screw size 0-30mm
355-171	2.0/2.4mm	screw size 0-30mm
355-171L	2.0/2.4mm	screw size 0-50mm
355-172	2.7mm	screw size 0-50mm
355-173	3.5/4.0mm	screw size 0-50mm
355-173L	3.5/4.0mm	screw size 0-80mm

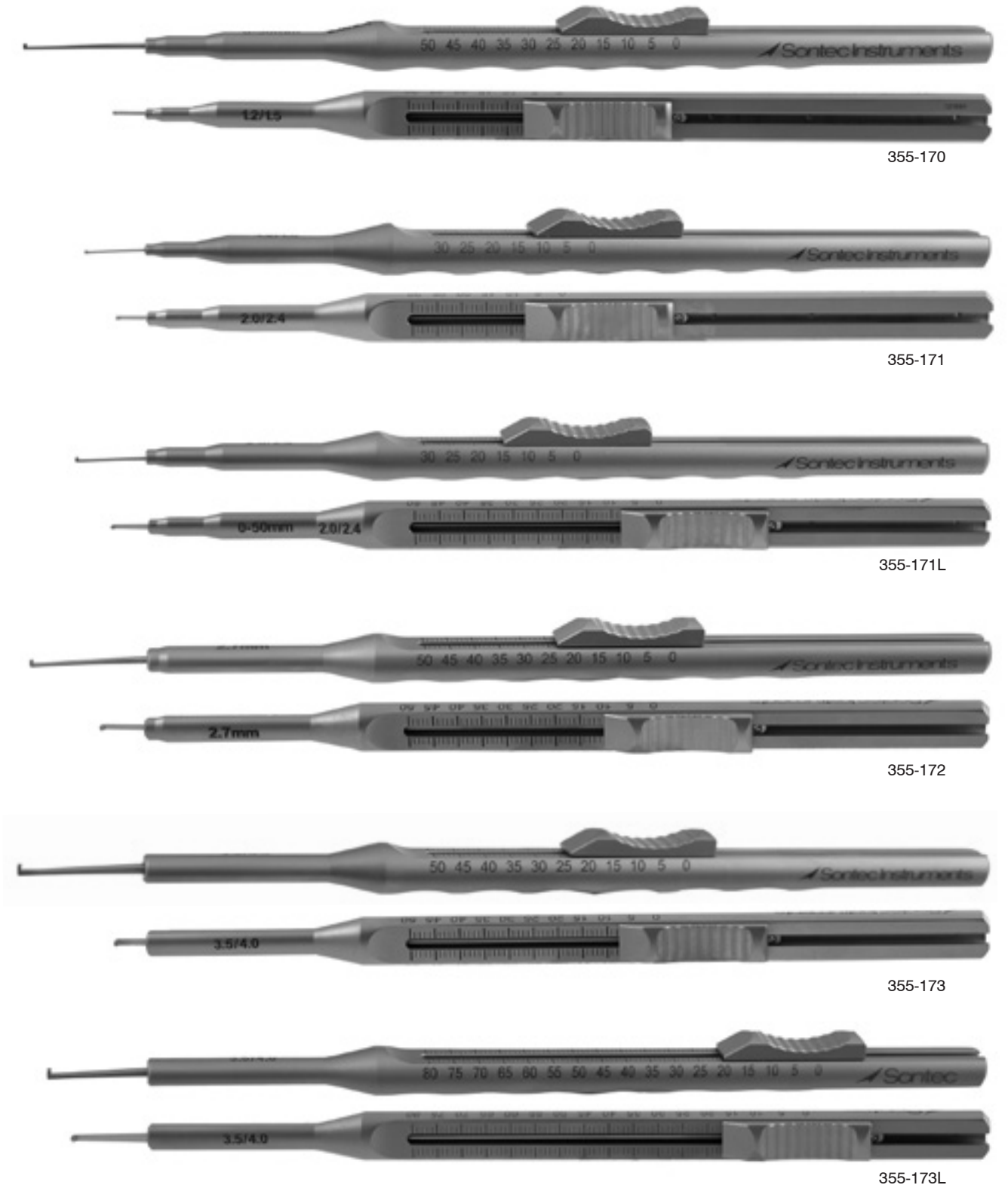

**Mini Depth Gauge**

Screw size 1.5 / 10 mm - 30 mm  
355-161



355-161

**Taylor Micro Arthroscopic Pick**

Straight / 1.2 mm / 8" (20 cm)  
1271-120



1271-120

**Daniel Nasal Awl**

6 1/4" (10.8 cm)  
467-414



467-414

**Liska Awl**

T- handle / 3" shaft  
1271-342



1271-342

**Sontec® Bone Hook**

9" (23 cm)  
320-925 small  
320-930 medium  
320-935 large



320-930

**Miller Skin Rake Retractor**

5" (12.5 cm)

199-480	9 prong	sharp
199-481	9 prong	blunt
199-482	6 prong	sharp
199-483	6 prong	blunt



199-481

**Blair Hook Retractor**

Four prongs / 5" (12.5 cm)

205-847	sharp
205-848	blunt



205-848

**Knapp Rollet Hook Retractor**

4 prongs / 5" (12.5 cm)

205-844	sharp
205-846	blunt



205-844

**Meyerding Finger Retractor**

7" (18 cm)

205-856	style 1
205-857	style 2
205-858	style 3
205-859	style 4
205-860	style 5
205-861	style 6

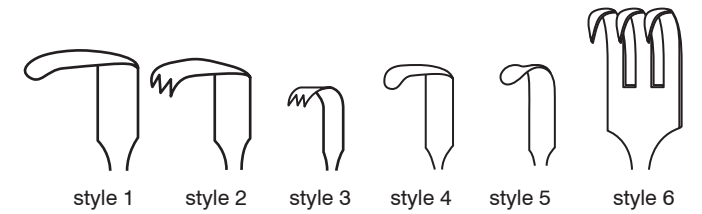

205-857



205-858



205-861

**Lukens Thymus Retractor**

7" (18 cm)

502-409



502-409

**Sontec Tissue Twist Hook**

5 1/2" (14 cm)  
199-372



199-372

**Frazier Skin Hook**

5" (12.5 cm)  
199-380 sharp  
199-382 blunt



199-380

**Hartman Ear Hook**

6 1/4" (15.9 cm)  
467-441



467-441

**Tyrell Skin Hook**

5" (12.5 cm)  
199-385 sharp  
199-387 blunt



199-385

**Gillies Skin Hook**

7" (18 cm)  
199-390 large  
199-391 small



199-391

**Gillies Skin Hook Titanium**

Small / sharp / 6 1/2" (16.5 cm)  
199-384T

Large / sharp / 6 1/4" (15.9 cm)  
199-3841T



199-384T

199-3841T

**Cottle Double Skin Hook**

Sharp / 5 1/2" (14 cm)  
199-394



199-394

**Cottle Skin Hook**

5 1/2" (14 cm)  
199-393A angled  
199-393B shallow curve  
199-393C deep curve



angled shallow curve deep curve

6 1/4" (15.9 cm)  
199-392 angled  
199-392A angled 180°



199-393C

199-392

199-392A

**Cottle Skin Hook Titanium**

Angled 180° / 17.5 cm / 7" (17.8 cm)  
199-392T



199-392T

**Cottle Skin Hook Titanium**

Angled 180° / 6 1/4" (15.9 cm)  
199-3921T



199-3921T

**Freer Double Skin Hook**

2.5 mm wide / 6" (15 cm)  
199-395 sharp  
199-396 blunt



199-395

**Sontec Freer Skin Hook Titanium**

Flat handle / 2 sharp prongs / 3 mm wide / 6" (15 cm)  
199-402T



199-402T

**Lockhart Mummy Fistula Probe**

With eye hole at tip / 6 1/2" (16.5 cm)

- 15-0230 #1 straight
- 15-0231 #2 45° curve
- 15-0232 #3 90° curve
- 15-0233 #4 hook



15-0230

15-0231

15-0232

15-0233

**Grooved Director Tongue Tie**

- 197-690 4 1/2" (11.5 cm)
- 197-691 5" (12.5 cm)
- 197-692 5 1/2" (14 cm)
- 197-693 6" (15 cm)
- 197-694 7" (17.8 cm)
- 197-695 8" (20 cm)

With probe point

- 197-700 4 1/2" (11.5 cm)
- 197-701 5" (12.5 cm)
- 197-702 5 1/2" (14 cm)
- 197-703 6" (15 cm)
- 197-704 7" (17.8 cm)
- 197-705 8" (20 cm)



197-701

**Larry Fistula Probe**

Grooved director / 6" (15 cm)

508-544



508-544

**St. Marks Fistula Probe**

Curved / 7" (18 cm)

508-541



508-541

**Buie Fistula Probe**

Sterling silver shaft / 5 3/8" (13.5 cm)

508-536

508-538 heavy



508-536

**Barr Fistula Probe**

11" (28 cm)

508-542 w/ eye at tip

508-543



508-543

**Barr Double Ended Probe**

Double-ended / 7" (18 cm)

508-547



508-547

**Davis Gallstone Scoop**

Double-ended / oval cup / oval cup / blunt

- 1100-521S 5 1/2" (14 cm)
- 1100-521 6 1/2" (16.5 cm)
- 1100-521L 8" (20 cm)



1100-521



1100-521S



1100-521



1100-521L

**Ferguson Gallstone Scoop**

Double-ended / oval cup / oval cup / blunt / 9 1/2" (24 CM)

- 150-239 small
- 150-241 medium
- 150-243 large



150-239

**Bone Grinder**

355-265



355-265

**Cartilage Cutting Block Titanium**

120mm x 120mm x 15mm  
350-8453T



350-8453T

**Segmented Adjustable Aluminum Retractor**

5 1/2" x 5 1/2"

- 516-770 frame only
- 516-771 single prong elastic retractor hook 8-pack



516-771



516-770



 Sontec Instruments®

Dental

**Warwick James Root Elevator**

Straight / 6" (15 cm)  
1102-WJ-S



1102-WJ-S

**Slimline Back Bent Elevator**

RTH2 handle style / #100C / 6" (15 cm)  
1102-100C



1102-100C

**Dental Root Tip Elevator**

1.3mm tip / 6" (15 cm)  
1102-1.3S straight  
1102-1.30C outside-bent curved



1102-1.3S



1102-1.30C

**Root & Fragment Dental Extracting Forceps**

TC dust / serrated / upper & lower / #69 / 6" (15 cm)  
1100-600



1100-600

**Sontec Dental Bone Cutting Forceps**

Small / 6" (15 cm)  
1100-584

Large / 6 1/2" (16.5 cm)  
1100-584A



1100-584



1100-584



1100-584A

**Winged Dental Elevator Set Short Handle**

5 1/4" (13 cm)

- 1103-389H .75 mm
- 1103-389J 1.0 mm
- 1103-389X 1.5 mm delwng2
- 1103-389A 2 mm delwng2
- 1103-389B 3 mm delwng3
- 1103-389C 4 mm delwng4
- 1103-389D 5 mm delwng5
- 1103-389E 6 mm delwng6
- 1103-389F 7 mm delwng7
- 1103-389G 8 mm delwng8



1103-389D

Additional options available upon request

- A. available with TC dust
- B. available with serrations

**Winged Dental Elevator Set Classic Handle**

Slim head design / 5 1/2" (14 cm) / v-notch

- 1100-586W1V size 1
- 1100-586W2V size 2
- 1100-586W3V size 3
- 1100-586W4V size 4
- 1100-586WSV set with sizes 1-4
- 1100-586W5V size 5
- 1100-586W6V size 6
- 1100-586W7V size 7
- 1100-586W8V size 8
- 1100-586V V notched EX 5H

Additional options available upon request

- A. available with TC dust
- B. available with serrations



1100-586W4V

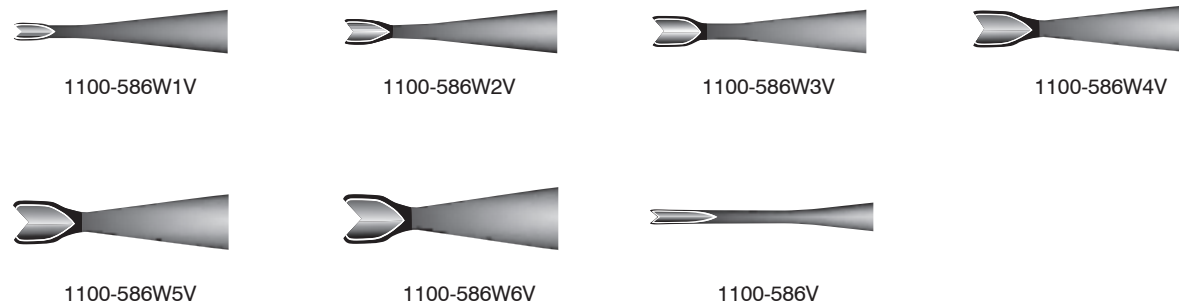

**Winged Dental Elevator Set Classic Handle**

Slim head design / 5 1/2" (14 cm)

- 1100-586W.75 0.75 mm
- 1100-586W1.5 1.5 mm
- 1100-586W1 1 mm
- 1100-586W2 2 mm
- 1100-586W3 3 mm
- 1100-586W4 4 mm
- 1100-586WS set with sizes 1-4
- 1100-586W5 5 mm
- 1100-586W6 6 mm
- 1100-586W7 7 mm

Additional options available upon request

- A. available with TC dust
- B. available with serrations



1100-586W4

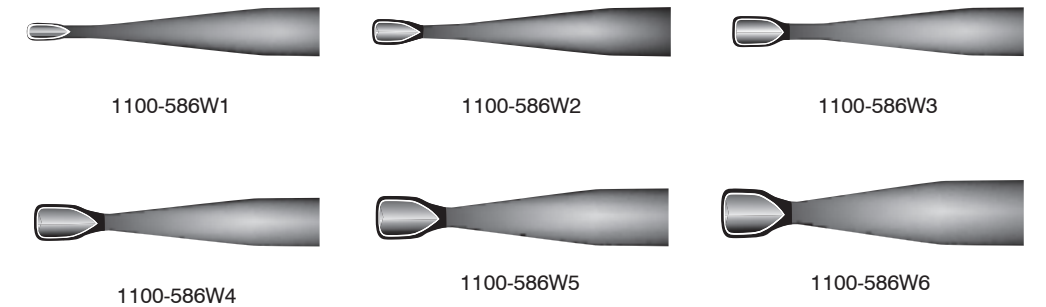

**Dental Elevator Set Classic Handle**

5 1/2" (14 cm)

- 1103-3901 DEL4 serrated tip
- 1103-391 34
- 1103-391S 34S
- 1103-392 E81
- 1103-393 301
- 1103-394 E40
- 1103-395 E80
- 1103-396 46
- 1103-396A E46

Additional options available upon request

- A. available with TC dust
- B. available with serrations



1103-395

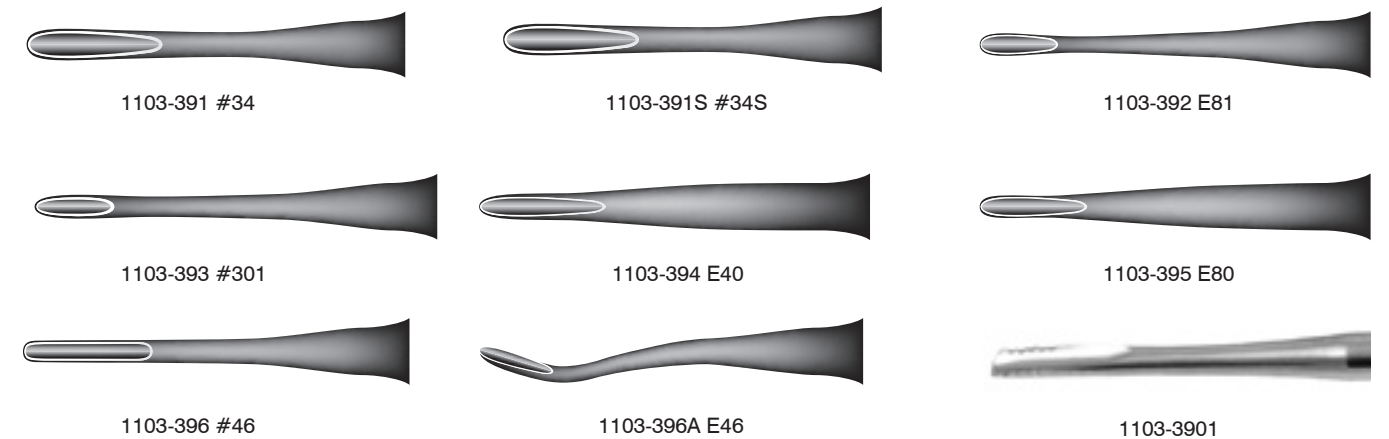

### Chisel Edge EX-16 Dental Elevator

1 edge serrated / EX 16 / 6" (15 cm)

- 1103-397 EX-16 curved out
- 1103-398 EX-15 curved in

Additional options available upon request

- A. available with TC dust
- B. available with serrations



1103-397

### Dental Luxating Elevator Short Handle

Short handle / blade head design / 5" (12.5 cm)

- 1100-586-SET all the elevators below (1 each) with tray 1103-715
- 1100-5860-SET all the elevators below (1 each) without tray
- 1100-586S1 straight 1.5 mm
- 1100-586C1 curved 1.5 mm
- 1100-586S2 str 2 mm
- 1100-586C2 cvd 2 mm
- 1100-586S3 str 3 mm
- 1100-586C3 cvd 3 mm
- 1100-586S4 str 4 mm
- 1100-586C4 cvd 4 mm
- 1100-586S5 str 5 mm
- 1100-586C5 cvd 5 mm

Additional options available upon request

- A. available with TC dust
- B. available with serrations



1100-586S5

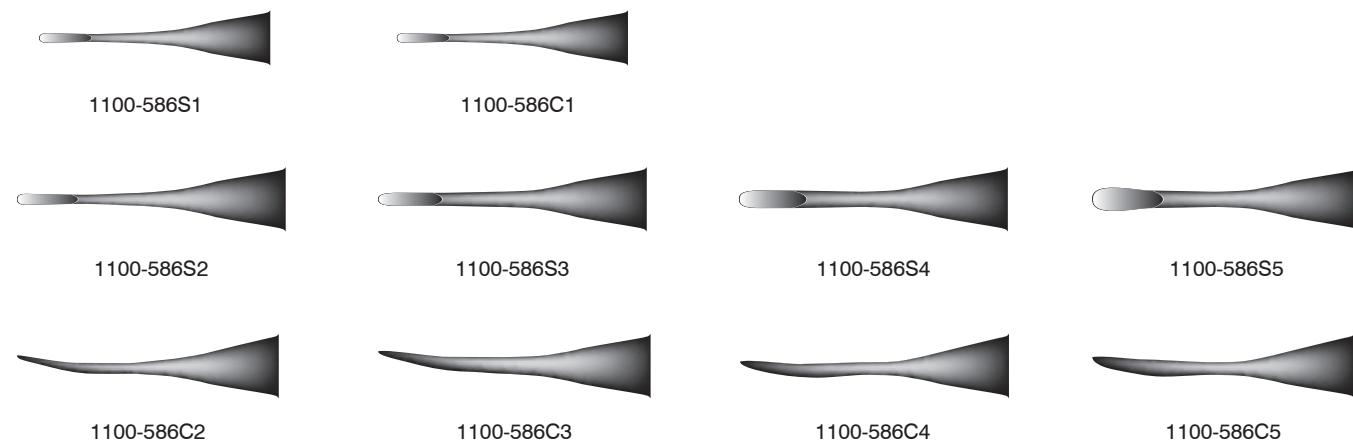

### Hirschfeld Periosteal Dental Elevator

Hirschfeld #20 / sharp "hatchet" shaped 3.5mm straight blade / flat 4mm round tip blade

1102-CPLH20



1102-CPLH20

### Unique Dental Periosteal Elevator Set

- 1102-EX-SET
- 1102-REEP24G EX-7
- 1102-EX9 EX-9
- 1102-EX9M EX-9M
- 1102-EPGAR2 EX-8



1102-REEP24G



1102-EX9



1102-EX9M



1102-EPGAR2

### Periosteal Elevator

Double-ended / small

- 1102-EX19 7"
- 1102-EX51 7 1/4"



1102-EX19



1102-EX51

**Dental Periosteal Elevator**

Double-ended / OHL  
1103-320



1103-320

**Molt Periosteal Dental Elevator**

1103-310 Molt  
1103-337 MX 2/4  
1103-340 EX-1  
1103-339A EX-6  
1103-583 CS M-9



1103-310



1103-337



1103-340



1103-339A



1103-583

**Tooth Splitting & Separating Extracting Forceps**

Upper & lower / 7" (18 cm) / #6  
1100-602

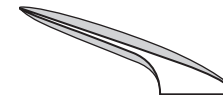

1100-602

**Tartar Remover Forceps**

TC dust  
1103-357 small 4 1/2" (11.5 cm)  
1103-358 large 5 1/2" (14 cm)



1103-357

**Blumenthal Oral Surgery Rongeur**

Tapered jaw / delicate / 4 1/2" (11.5 cm)  
315-500M 30° angle  
315-501M 45° angle

Tapered jaw / 6" (15 cm)  
315-500 30° angle  
315-501 45° angle



315-501

**Root Extracting Forceps**

#300 / TC dust / micro 1.5 tip / cross-serrated / s-curved / with spring

1103-348

#300 / micro 1.5 tip / cross serrate / straight handle

1103-348S



**Pedo Extracting Forceps**

TC dust / serrated / for teeth & roots / 4 3/4" (12 cm)

1103-350 upper

1103-351 lower



**Mini Pedo Extracting Forceps**

TC dust / serrated / for teeth & roots / upper / 4 3/4" (12 cm)

1100-599



**Dental Micro Fragment Forceps**

Angled / with spring / 5" (13 cm)

1100-595



**Micro Pedo Extracting Forceps**

With ergonomic handle / TC dust / serrated / for teeth & roots / 4 3/4" (12 cm)

1103-353 upper  
1103-352 lower



1103-353



1103-352

**Dental Corn Forceps**

Ring tip / 6" (15 cm)

1103-346



1103-346

**Hooks / Probes / Explorer / Curette / Scalers Handle Styles**

Please choose your preferred handle



Single ended Light Handle



Double ended Light Handle



Single ended Standard Handle



Double ended Standard Handle

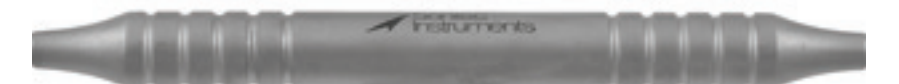

Double ended Light Handle

**Double-ended Dental Explorer**

**#3DE**

1102-REEX3DE light handle  
1102-EX3DE standard handle



**#3 Cow Horn**

1102-REEX3CH light handle  
1102-EX3CH standard handle



**Old Dominion University #11-12**

1102-REEX11-12 light handle  
1102-EX11-12 standard handle



**Old Dominion University #11-12L/  
extended terminal shanks**

1102-REEX11-12L light handle  
1102-EX11-12L standard handle



**Double-ended Endodontic**

**#DG16**

1102-REEX16 light handle  
1102-EX16 standard handle



**#DG16-23**

1102-REEX16-23 light handle  
1102-EX16-23 standard handle



**Double-ended Dental Explorer/Probe  
Combination**

**W-23 / non-color coded William Probe- 1-2-3-5-7-8-9-  
10mm marking / #23 Shepherd's Hook Explorer**

1102-REPW23 light handle  
1102-PW23 standard handle



**OW-23 / color coded William Probe- 1-2-3-5-7-8-9-  
10mm marking / #23 Shepherd's Hook Explorer**

1102-REPCOW-23 light handle  
1102-PCOW23 standard handle



**N12-23 / color coded UNC screening probe- 1-2-3-4-5-6-7-  
8-9-10-11-12mm markings / #23 Shepherd's hook explorer**

1102-REPCN12-23 light handle  
1102-PCN12-23 standard handle



**N15-23 / color coded UNC screening probe- 1-2-3-4-5-6-7-  
8-9-10-11-12-13-14-15mm marking / #23 Shepherd's hook  
explorer**

1102-REPCN15-23 light handle  
1102-PCN15-23 standard handle



**WHO-23 / color coded "PSR" ball tip screening probe- 3.5-  
5.5-8.5-11.5mm markings / #23 Shepherd's hook explorer**

1102-REPCWHO-23 light handle  
1102-PCWHO-23 standard handle



**Sickle/Curette Combinations**

**Sickle/Spoon #1 / sickle- small size, medium-reach, 0.8mm blade,  
tapers to a point / spoon- long-reach, contra-angle, 2mm blade**

1102-RESCN1 light handle  
1102-SCN1 standard handle



**Sickle N5-Curette #48 / N5- moderate size, medium-reach, 0.9mm  
blade, tapers to a point / #48- small, contra-angle, 2mm blade**

1102-RESCN5-48 light handle  
1102-SCN5-48 standard handle



**Towner U15-Curette #47 / U15- large size, long-reach, 1mm blade,  
tapers to a point / #47- medium contra-angle, 2.5mm blade**

1102-RESCU15-47 light handle  
1102-SCU15-47 standard handle



**Towner U15-Kirland #13 / U15- large size, long-reach, 1mm blade,  
tapers to a point / #13- large contra-angle, 3.5mm blade**

1102-RESCU15-K13 light handle  
1102-SCU15-K13 standard handle



**Lingual Curette**

**Anterior Lingual Stain Remover (ALSR) / curette- contra-angled,  
2mm blade / spoon- contra-angled, 2mm blade**

1102-RESCALSR light handle  
1102-SCALSR standard handle



**Cumine #152 / large spoon / sickle**

1102-RESCCUMINE light handle  
1102-SCCUMINE standard handle



**Contra-angle Curette #45-46A / opposing 10° cutting edge  
angles / 2.5mm blades / contra-angle shanks**

1102-RESC45A-46A light handle  
1102-SC45A-46A standard handle



**Straight Curette #45-46 / opposing 10° cutting edge angles /  
2.5mm blade / straight shank**

1102-RESC45-46 light handle  
1102-SC45-46 standard handle



**Orban Hoe #7-9 / mirror image curette / 1.5mm blades /  
12mm long shank / 35° angled**

1102-RESCO7-9 light handle  
1102-SCO7-9 standard handle



**Jacquettes Anterior Scaler**

**Jacquette #1-1S / large & small combination / large- 5mm  
long, 1mm blade, tapers to a point / small- 4mm long, 0.9mm  
blade tapers to a point**

1102-RESCJ1-1S light handle  
1102-SCJ1-1S standard handle



**Morse #0-00 / both tips-straight shank, very fine Jacquette  
blades / #0- 3.5mm long, 0.7mm blade, tapers to a point /  
#00- 2mm long, 0.6mm blade, tapers to a point**

1102-RESCM0-00 light handle  
1102-SCM0-00 standard handle



**Jacquettes/Sickle Combinations**

**Goldman Fox 21S / Jacquette- 4mm long, 0.7mm blade, tapers to a point / U15- long-reach, 1mm blade, tapers to a point**

1102-RESC21S-U15 light handle  
1102-SC21S-U15 standard handle



**Jacquette #1S-Sickle N5 / #1S-small size, straight blade, 0.9mm blade, tapers to a point / N5- moderate size, medium-reach, 0.9mm blade, tapers to a point**

1102-RESCJ1S-N5 light handle  
1102-SCJ1S-N5 standard handle



**Jacquette #1S- Towner U15 / #1S- small size, stright, 0.9mm blade, tapers to a point / U15- long-reach, 1mm blade, tapers to a point**

1102-RESCJ1S-U15 light handle  
1102-SCJ1S-U15 standard handle



**Jacquettes Posterior Scaler**

**Jacquette #2-3 / both blades 5mm long, 1mm blade**

1102-RESCJ2-3 light handle  
1102-SCJ2-3 standard handle



**Jacquette #2S-3S / both blades 4mm long, 0.9mm blades**

1102-RESCJ2S-3S light handle  
1102-SCJ2S-3S standard handle



**Sickles Posterior Scaler**

**Sickle #157-158 / mirror image blades / long-reach shank / 40° / 5mm reach / 0.8mm blade**

1102-RESC157-158 light handle  
1102-SC157-158 standard handle



**Sickle #204 / mirror image blades / long-reach shank / 30° / 5mm reach / 0.8mm blade**

1102-RESC204 light handle  
1102-SC204 standard handle



**Sickle #204 "Indiana Univeristy-Fort Wayne" / mirror image blades / long-reach shank / 30° / 5.5 mm reach / 0.9mm blade**

1102-RESC204IUFW light handle  
1102-SC204IUFW standard handle



**Sickle #204S / mirror image blades / short-reach shank / 40° / 4.5mm reach / 0.9mm blade**

1102-RESC204S light handle  
1102-SC204S standard handle



**Sickle #204SD "Distal" / mirror image blades / short-reach shank / 25° / 4.5mm reach / 0.9mm blade**

1102-RESC204SD light handle  
1102-SC204SD standard handle



**#129 Anterior/ Posterior Sickle / mirror image blades / medium-reach shank / 10mm reach / 0.8mm blades / tapers to a point**

1102-RESCN129 light handle  
1102-SCN129 standard handle



**Dental Scaler**

**Single-ended**

1102-SCJ2S Jacquette



**Dental Scaler/Curette**

**Double-ended**

1102-SCJ2S-3SL Jacquette  
1102-SCM17-18 McCall  
1102-SCGR13-14 Gracey #13-14 all distal surface / 0.9 mm reach

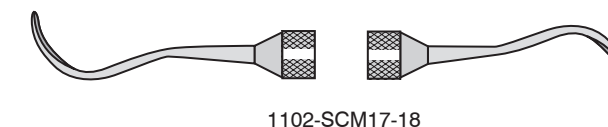
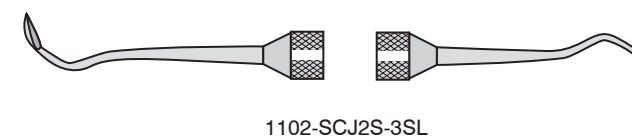

**Baylor Tactile Tone Periodontal Probe**

**Double-ended / 6 1/2"**

1102-EEB12



**India Sharpening Stone**

Medium / 4 1/4" x 1" x 3/4" x 3/8" / SS5

1100-579

\*use to keep your elevators burr free.

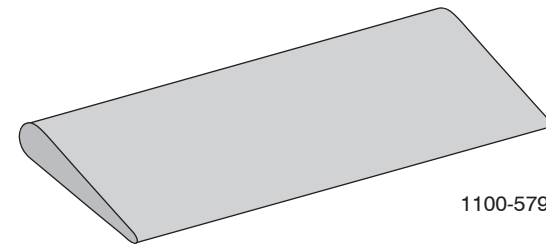

1100-579

**Arkansas Sharpening Stone**

Hard / 4" x 2 1/2"

1100-581 SS6

1100-581A SS1

Hard / 4" x 1" / SS2

1100-582

\*use to keep your elevators burr free.

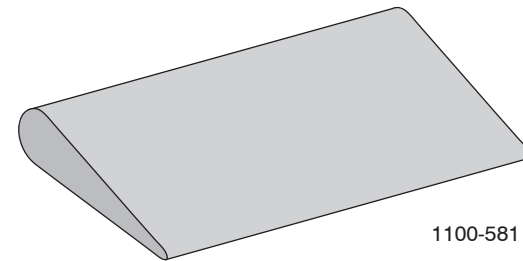

1100-581

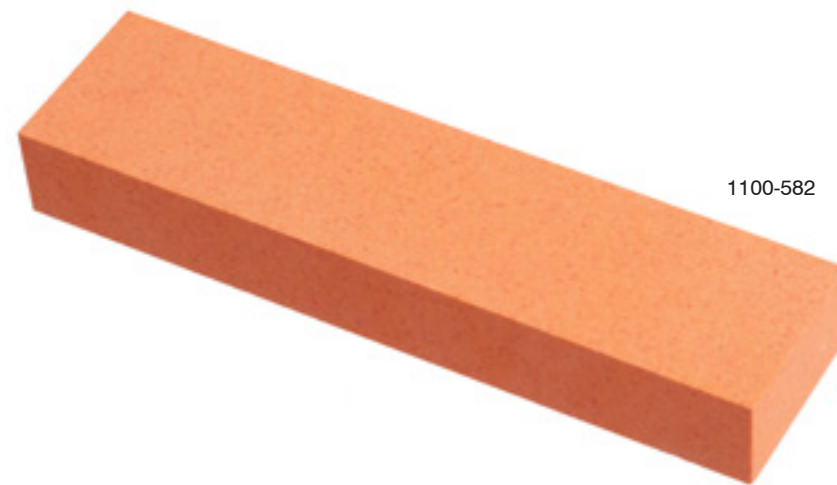

1100-582

**Heavy Tartar Hoe**

Double ended / P35

1103-329



1103-329

**Spring Mouth Gag**

**Feline**

1103-299 extra small 1 1/8" (3.2 cm)

1103-300 small 2 1/2" (6.5 cm)

1103-301 large 3" (7.5 cm)

**Canine**

1103-302 small 4 1/4" (11.5 cm)

1103-303 medium 5 3/4" (14.5 cm)

1103-304 large 6 3/4" (17 cm)



1103-299



1103-300



1103-303

**Small Animal Dental**

TC Serrated / 7" (18 cm)

1103-371



1103-371

**Grooved Diamond Coated Dental Rasp**

Curved / fine grit / 7 1/2" (19.1 cm)

- 1103-379 3 mm x 22 mm
- 1103-378 4 mm x 22 mm



1103-379

Curved / medium grit / 7 1/2" (19.1 cm)

- 1103-378M 4 mm x 22 mm
- 1103-379M 3 mm x 22 mm

**Classic Bayonet Dental Rodent Rasp**

7" (18 cm)

- 1103-372 fine
- 1103-374 medium



1103-372

**Rodent Molar Extractor Forceps**

6 1/2" (16.5 cm)

- 1103-308



1103-308

**Rodent Molar Cutter**

Spring handle / 7 1/4" (18.5 cm)

- 1103-370



1103-370

actual size

**Rodent-Classic Wolf Tooth Cutting Forceps**

TC / 7" (18 cm)

- 1103-368 regular
- 1103-369 heavy



1103-368

**Rodent Tooth Cutting Set**

- 1103-360 includes:  
 1103-376 Rodent Table Retractor Restrainer  
 1103-362 Cheek Spreader, delicate  
 1103-368 Tooth Cutting Forceps, TC serrated  
 1103-372 Diamond Coated Tooth Rasp

**Rodent Table Retractor Restrainer**

Base: 8 1/2" x 7 3/4" / platform: 5 3/8" x 9 7/8" /  
 maximum spread: 3 1/2" / varying adjustments  
 possible

1103-376

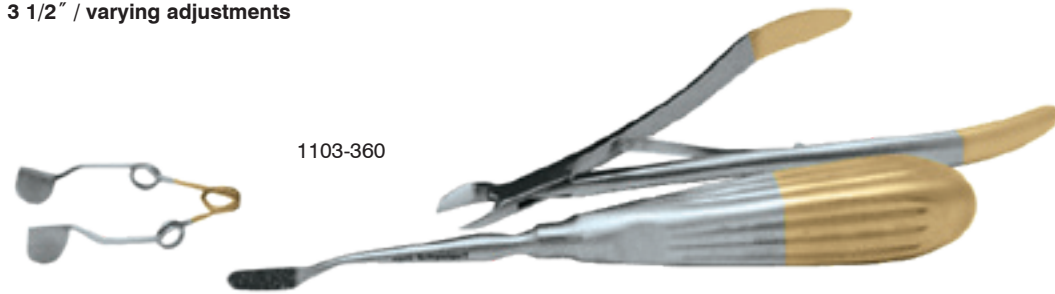

**Rodent Incisor Luxator**

Double-ended / 6 1/4" (16 cm)

1103-385



**Crossley Molar Luxator**

Double-ended / 6 1/4" (16 cm)

1103-386



**Rodent Dental Spatula**

7" (18 cm)

1103-390



**Wellace Rodent Mouth Spreader**

Fenestrated blade / 4 1/2" (11.5 cm)

1103-380



1103-380

**Weitlaner Rodent Mouth Spreader**

Fenestrated blade / 4 1/2" (11.5 cm)

1103-382



1103-382

**Rodent Cheek Spreader Set**

1103-362	delicate	9 mm x 8 mm blades	
1103-363	small	10 mm x 14 mm blades	
1103-364	long	11 mm x 30 mm blades	
1103-365	extra large	15 mm x 22 mm blades	
1103-366	extra long	10 mm x 40 mm blades	
1103-367S	small	5 mm x 30 mm blades	for chinchilla
1103-367	extra narrow	5 mm x 40 mm blades	for chinchilla

**Tapered blades / 40 mm**

1103-3661	solid blades convex
1103-3662	wire blades

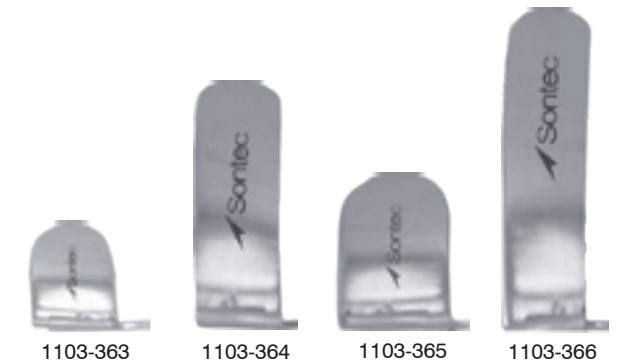

1103-363

1103-364

1103-365

1103-366

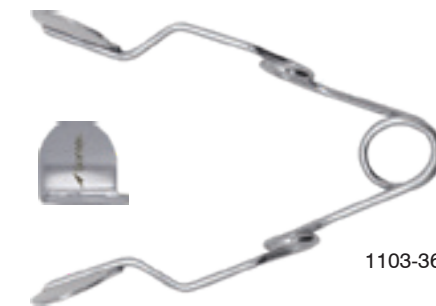

1103-362

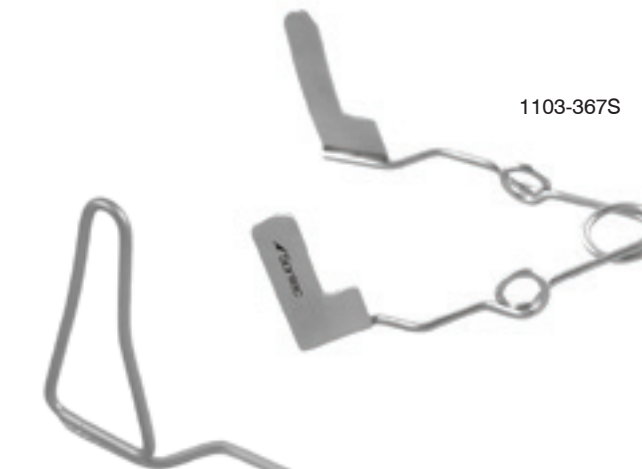

1103-367S

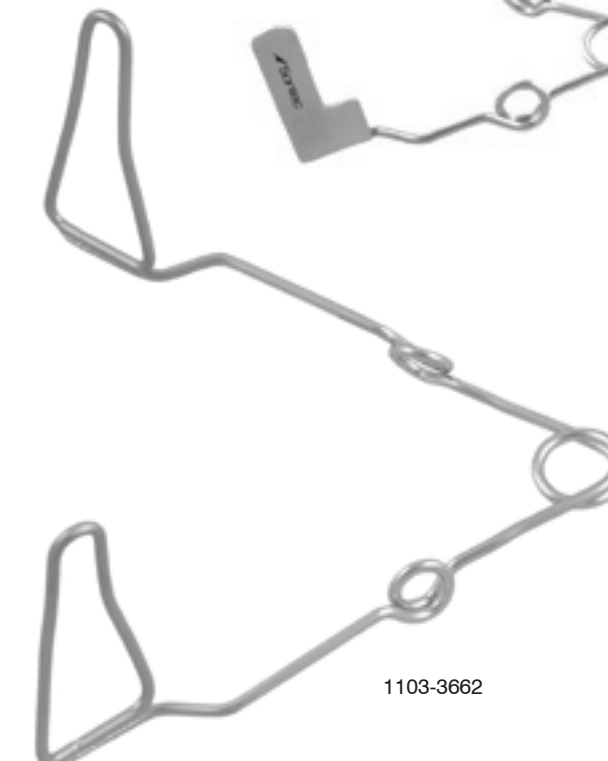

1103-3662



1103-367

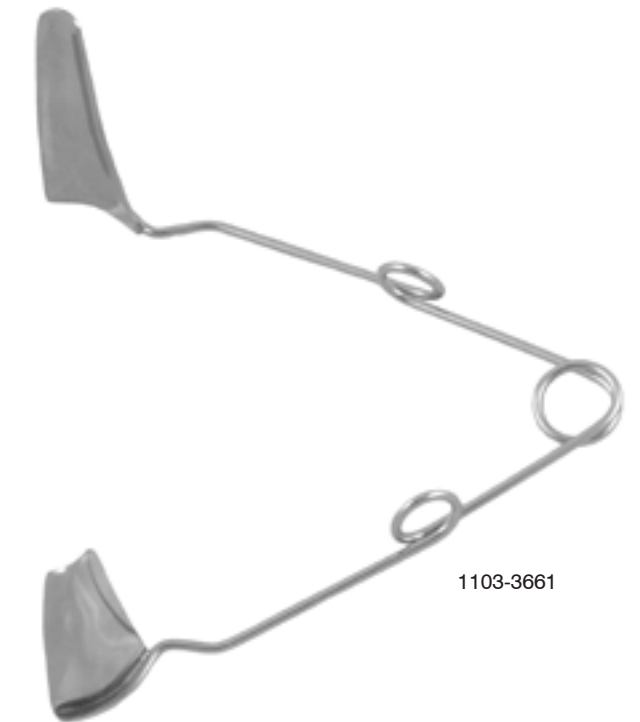

1103-3661

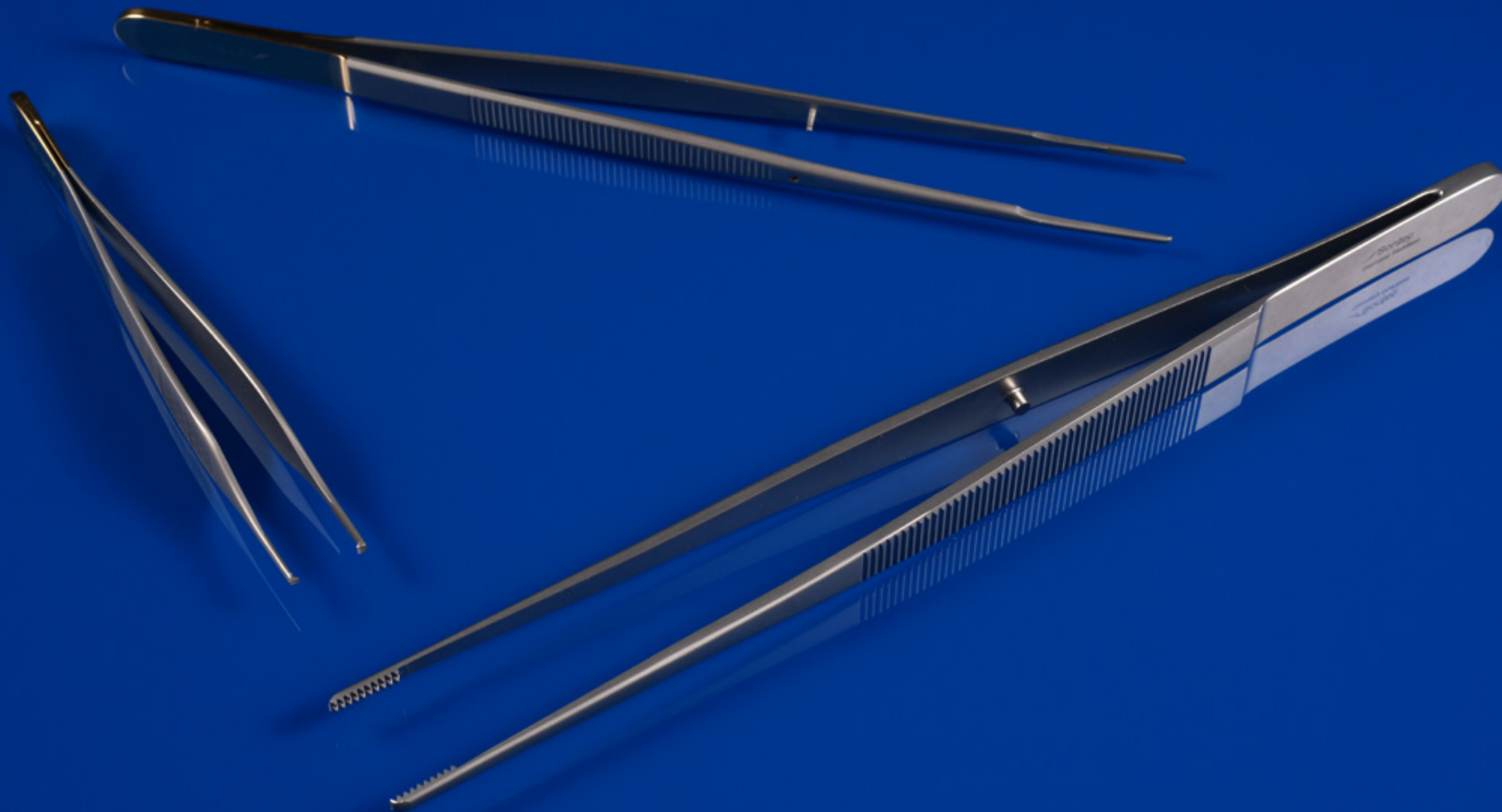

 Sontec Instruments®

FORCEPS Flat Handle

**DeBakey Tissue Forceps**

**Flat handle / 6" (15 cm)**

- 2200-101 1.0 mm tip
- 2200-101A 1.5 mm tip
- 2200-105 2.0 mm tip
- 2200-105A 2.5 mm tip
- 2200-105B 2.8 mm tip

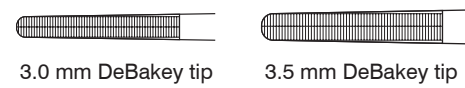
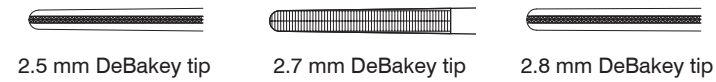

**Flat handle / 7 3/4" (19.5 cm)**

- 2200-102 1.0 mm tip
- 2200-102A 1.5 mm tip
- 2200-107 2.0 mm tip
- 2200-110 2.7 mm tip
- 2200-112 3.5 mm tip

**Flat handle / 9 1/2" (24 cm)**

- 2200-103 1.5 mm tip
- 2200-108 2.0 mm tip
- 2200-111 2.7 mm tip
- 2200-1133 3.0 mm tip
- 2200-113 3.5 mm tip

**Flat handle / 12" (30 cm)**

- 2200-104 1.5 mm tip
- 2200-109 2.0 mm tip
- 2200-1112 2.7 mm tip
- 2200-1132 3.5 mm tip

**With pin / flat handle / 7 3/4" (19.5 cm)**

- 2200-107P 2.0 mm tip
- 2200-110P 2.7 mm tip

**With pin / flat handle / 9 1/2" (24 cm)**

- 2200-108P 2.0 mm tip
- 2200-111P 2.7 mm tip

**With pin / flat handle / 12" (30 cm)**

- 2200-1112P 2.7 mm tip

\* other sizes available with pin upon request.



**DeBakey Angled Tissue Forceps**

**Flat Handle / 40° angle**

- 2200-106 2.0 mm 6"
- 2200-107C 2.0 mm 7 3/4"
- 2200-107A 2.7 mm 7 3/4"
- 2200-103A 1.5 mm 9 1/2"
- 2200-108A 2.0 mm 9 1/2"
- 2200-1132A 3.5 mm 12"



**DeBakey Needle-Pulling Tissue Forceps**

**Flat handle / TC platform / 6" (15 cm)**

- 2200-074 1.0 mm
- 2200-077 1.2 mm
- 2200-078 1.5 mm
- 2200-080 2.0 mm
- 2200-079 2.7 mm
- 2200-081 3.5 mm

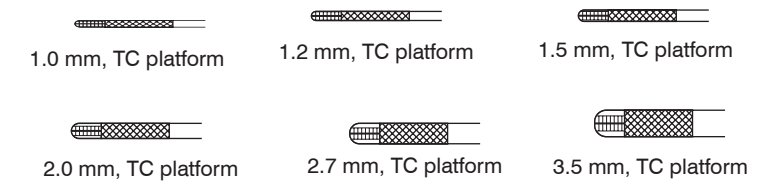

**Flat handle / TC platform / 8" (20 cm)**

- 2200-075 1.0 mm
- 2200-096 1.2 mm
- 2200-097 1.5 mm
- 2200-100 2.0 mm
- 2200-099 2.7 mm
- 2200-099P 2.7 mm with guide pin
- 2200-098 3.2 mm
- 2200-098P 3.2 mm with guide pin



**Flat handle / TC platform / 9 1/2" (24 cm)**

- 2200-076 1.0 mm
- 2200-085 1.5 mm
- 2200-092 2.0 mm
- 2200-091 2.7 mm
- 2200-090 3.5 mm
- 2200-090P 3.5 mm with guide pin

**Flat handle / TC platform / 12" (30 cm)**

- 2200-0922 2 mm
- 2200-0912 2.7 mm
- 2200-0902 3.5 mm

**DeBakey Ergonomic-Handle Forceps**

Extra lightweight / 1.0 mm tip / fenestrated handle

- 2200-101F 6" (15 cm)
- 2200-102F 7 7/8" (20 cm)
- 2200-103F 9 1/2" (24 cm)
- 2200-104F 12" (30 cm)



2200-102F



2200-103F



**Micro Gerald Tissue Forceps**

Round handle / TC serrated platform / 0.9 mm tip

- 2200-1431 7 1/4"
- 2200-1441 8 1/4"



2200-1431

**Brown Tissue Forceps**

9 x 9 teeth

- 136-690 6" (15.5 cm)
- 136-692 8" (20.5 cm)
- 136-694 10" (25.5 cm)

9 x 9 teeth / TC

- 136-691 6" (15.5 cm)
- 136-695 10" (25.4 cm)



136-690

**McGravey Tissue Forceps**

5 x 6 delicate teeth

- 136-766 7" (18 cm)
- 136-767 9" (22.9 cm)



136-766

**Russian Tissue Forceps**

- 136-771 6" (15.5 cm)
- 136-773 8" (20.5 cm)
- 136-775 10" (25.5 cm)
- 136-776 12" (30.5 cm)

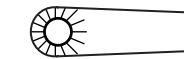

136-773

**Selman Tissue Forceps**

Round cup teeth

- 142-113 8" (20.3 cm)
- 142-114 10" (25.4 cm)



142-113

**Singley Tuttle Forceps**

**Serrated**

142-103	6" (15 cm)	
142-108	7" (18 cm)	
142-110	9" (23 cm)	
2200-0175	9" (23 cm)	large ring
142-107	10" (25 cm)	
142-111	12" (30 cm)	
142-104	14" (35.5 cm)	
142-106	16" (40.5 cm)	



142-108

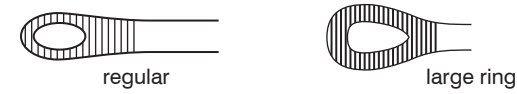

**Wangensteen Tissue Forceps**

**TC Serrated**

2200-015	6" (15 cm)
2200-016	8" (20 cm)
2200-017	9" (23 cm)
2200-018	10" (25.5 cm)



2200-017

**Evans Tissue Forceps**

**TC serrated / 10" (25 cm)**

2200-382



2200-382

**Electro Blue Coated Skinner Tissue Forceps**

**Monopolar use / TC serrated platform / 1 x 2 teeth / insulated / 9" (22.9 cm)**

140-376B



140-376B

**Semken Forceps**

**Dressing / serrated**

136-702	4 3/4" (12 cm)
136-704	6" (15.5 cm)

**Tissue / 1 x 2 teeth / delicate / 0.7mm tip / 4 3/4" (12 cm)**

136-701

**Tissue / 1 x 2 teeth**

136-706	5" (13 cm)
136-708	6" (15.5 cm)

**Tissue / TC platform / 1 x 2 teeth**

140-350	5 3/4" (15 cm)
140-358	6 1/4" (16 cm)
140-364	7" (18 cm)

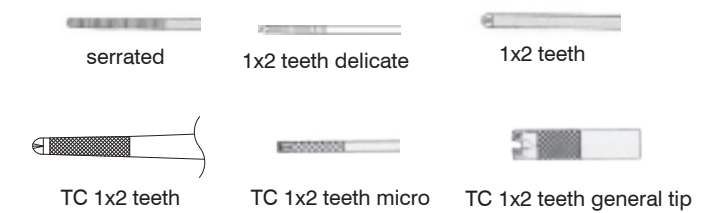

140-350



140-364

**Tissue / TC platform / 1 x 2 teeth / micro**

140-352	5 3/4" (15 cm)
140-360	6 1/4" (16 cm)
140-366	7" (18 cm)

**Tissue / TC platform 1 x 2 teeth / general**

140-354	5 3/4" (15 cm)
140-362	6 1/4" (16 cm)
140-368	7" (18 cm)
140-369	8" (20.5 cm)

**Tissue Forceps with Teeth**

**1 x 2 teeth**

136-621	4 1/2" (11.5 cm)	
136-624	5" (12.7 cm)	
136-626	5 1/2" (14 cm)	
136-626F	5 1/2" (14 cm)	fine tip
136-629	6" (15.5 cm)	
136-632	7" (18 cm)	
136-632B	7" (18 cm)	electro blue coated
136-634	8" (20.5 cm)	
136-634D	8" (20.5 cm)	delicate
136-636	10" (25.5 cm)	
136-636D	10" (25.5 cm)	delicate



136-632B



136-626F



136-634B

**2 x 3 teeth**

136-639	5" (12.7 cm)	
136-633	5" (12.7 cm)	TC serrated
136-640	5 1/2" (14 cm)	
136-637	5 1/2" (14 cm)	TC serrated
136-642	6" (15.5 cm)	
1100-179	6 1/4" (16 cm)	
136-641	6 1/4" (16 cm)	TC serrated
1100-165	7" (18 cm)	
136-643	7" (18 cm)	TC serrated
1100-167	8" (20 cm)	
136-645	8" (20 cm)	TC serrated
1100-187	9 3/4" (25 cm)	
136-649	9 3/4" (25 cm)	TC serrated
1100-169	10" (25 cm)	
136-651	10" (25 cm)	TC serrated



136-640

**3 x 4 teeth**

136-644	5 1/2" (14 cm)	
136-652	5 1/2" (14 cm)	TC serrated
136-646	6" (15 cm)	

**4 x 5 teeth**

136-648	5 1/2" (14 cm)	
136-653	5 1/2" (14 cm)	TC serrated
136-650	6" (15.5 cm)	
136-6508	8" (20.3 cm)	

**McIndoe Forceps Titanium**

Fine tip / serrated handle / serrated / 6" (15.2 cm)

2600-391	1 x 2 teeth
2600-392	serrated



2600-391



2600-392

**McIndoe Dressing and Tissue Forceps**

Fine serrations / 6" (15 cm)

2200-750



2200-750

Cross serrations with 1x2 teeth / 6" (15 cm)

2200-752



2200-752

**Thumb Dressing Forceps**

Serrated

136-600	4" (10 cm)
136-602	4 1/2" (11.5 cm)
136-605	5" (13 cm)
136-607	5 1/2" (14 cm)
136-610	6" (15.5 cm)
136-613	7" (18 cm)
136-615	8" (20.5 cm)
136-617	10" (25.5 cm)
136-619	12" (30.5 cm)



136-607

TC serrated

1100-739B	6" (15.5 cm)
1100-739A	7" (18 cm)

**Ferlit Micro Forceps**

1 x 2 teeth / cross serrated tying platform

140-504A 7" (18cm) 1.5 mm  
140-504B 4" (10cm) 0.9 mm

1 x 2 teeth / TC Dust / 0.5 mm teeth / 4 1/4" (10.8 cm)

140-505T

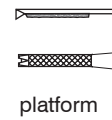

140-505T



140-504B



140-504A

**Bonney Tissue Forceps**

Serrated / 6 3/4" (17 cm)

140-502 1 x 2 teeth TC serrated  
136-578 2 x 3 teeth serrated



1 x 2 / 7" (18 cm)

136-580 serrated  
140-500 TC serrated



140-502



136-578



136-580

**Hudson-Ewald Forceps**

Heavy / serrated adson handle / 4 3/4" (12 cm)

136-684 1 x 2 teeth  
136-680 serrated tip

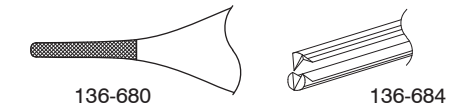

136-684

**Troutman Micro Hook Forceps**

With tying platform / TC dust / round handle

199-365S 5" (12.5 cm)  
199-365 6 1/4" (16 cm)  
199-365T 6 1/4" (16 cm) titanium



199-368

Adson handle

199-368 4 3/4" (12 cm)



199-365T

**Adson Tissue Forceps Titanium**

TC dust / 1.0 mm tips / 4 3/4" (12 cm)

140-298T



140-298T

**Adson Tissue Forceps Titanium**

1 x 2 / TC dust / tying platform / 4 3/4" (12 cm)

140-304T



140-304T

**Adson Tissue Forceps Titanium**

TC dust / with tying platform / 0.6 mm / 4 3/4" (12 cm)

140-296T



140-296T

**Adson Tissue Forceps Titanium**

TC dust / 0.3 mm / 1 x 2 tip / 4 3/4" (12 cm)

140-297T



140-297T

**Adson Tissue Forceps Titanium**

Serrated handle / TC dust / 0.5 mm / 1 x 2 tip / 4 3/4" (12 cm)  
140-302T



140-302T

**Adson-Harris Ring Tip Forceps Titanium**

Fenestrated / 1 mm ring-tip / TC dust / 4 3/4" (12 cm)  
1103-812T



1103-812T

**Adson Tissue Forceps Titanium**

1 x 2 Teeth  
2600-302 4 3/4"  
2600-311 5 7/8"



2600-311

**Brown Adson Tissue Forceps Titanium**

1.8 mm tips / 7x7 teeth  
T136-688 4 3/4" (12 cm) fenestrated handle  
136-688T 6" (15.2 cm)



T136-688

1.8 mm tips / 9x9 teeth / 4 3/4" (12 cm)  
T136-686 4 3/4" (12 cm)



136-688T



T136-686

**Gorney-Adson Forceps**

1 x 2 teeth with platform / stop pin,  
4 3/4" (12 cm)  
136-6741



136-6741

**DeBakey-Adson Tissue Forceps**

1.5 mm / atraumatic DeBakey jaws / 4 3/4" (12 cm)  
1100-185



1100-185

**Adson Tissue Forceps**

1 x 2 teeth / serrated handle / 4 3/4"  
136-668 0.8 mm  
136-666 1.3 mm  
136-672 1.3 mm 45° angled tips



136-666

1 x 2 teeth / serrated handle / 6"  
136-683 0.8 mm  
136-682 1.3 mm



1 x 2 teeth / serrated handle / TC dust platform / 6"  
136-682P 1.3 mm



136-672

1 x 2 teeth / fenestrated handle / 4 3/4"  
136-669 1.0 mm  
136-667 1.3 mm

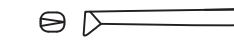

2 x 3 teeth / serrated handle / 4 3/4"  
136-676 1.0 mm



136-682P



136-669



136-676



2 x 3 teeth

**Beasley-Babcock Tissue Forceps**

Serrated adson handle / 5 x 6 teeth / 5" (13 cm)

136-699



136-699

**Adson Tissue Smooth Platform Forceps**

1 x 2 teeth / smooth platform / serrated handle / 4 3/4"

- 136-668A 0.8 mm
- 136-674D 1.0 mm
- 136-674 1.3 mm

1 x 2 teeth / smooth platform / fenestrated handle / 4 3/4"

- 136-679 1.3 mm



136-674

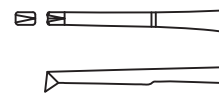

136-679

**Adson Tissue TC Dust Platform Forceps**

1 x 2 teeth / TC Dust platform / serrated handle / 4 3/4"

- 140-302D 0.8 mm
- 140-302 1.0 mm

1 x 2 teeth / TC Dust platform / fenestrated handle / 4 3/4"

- 140-302F 0.8 mm
- 140-303F 1.0 mm



140-303F

**Adson Tissue TC Serrated Platform Forceps**

1 x 2 teeth / TC serrated platform / serrated handle / 4 3/4"

- 140-305 1.0 mm
- 140-304 1.3 mm
- 140-303 1.8 mm



140-303



140-304

1 x 2 teeth / TC serrated platform / serrated handle / 6"

- 140-207 0.8 mm
- 140-309 1.0 mm
- 140-202 1.3 mm
- 140-203 1.8 mm



140-309

1 x 2 teeth / TC serrated platform / fenestrated handle / 4 3/4"

- 140-305F 1.0 mm
- 140-3042 1.3 mm
- 140-3032 1.8 mm



140-305F

2 x 3 teeth / TC serrated platform / serrated handle / 4 3/4"

- 140-306 0.8 mm
- 140-307 2.0 mm



140-307

2 x 3 teeth / TC serrated platform / fenestrated handle / 4 3/4"

- 140-304F 1.0 mm



140-304F

**Stille-Adson Tissue Forceps**

1 x 2 teeth / 4 3/4" (12 cm)

- 136-675 platform
- 136-677 serrated
- 136-678P cross-serrated platform

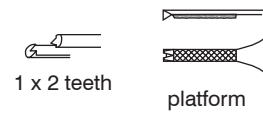

136-675

**Stille-Adson Dressing Forceps**

Serrated / 4 3/4" (12 cm)

- 136-659
- 136-659D delicate

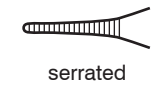

serrated



136-659

**Adson Harris Ring Tip Forceps**

Ring tip / TC dust / 1 mm tip / 4 3/4" (12 cm)

- 1103-808 fenestrated handle curved
- 1103-810
- 1103-812 fenestrated handle



ring tip  
1mm



1103-808

Ring tip / 2 mm tip / 4 3/4" (12 cm)

- 1103-809



1103-810



1103-812

**Brown Forceps**

9x9 teeth / castroviejo handle / 4 1/4" (10.8 cm)

- 14-6560
- 14-6562 with TC dust platform
- 14-6564 with TC insert



14-6560

**Harris Ring Tip Forceps**

Fenestrated handle / ring tip / 1 mm tip / 6" (15.5 cm)

- 1103-811
- 1103-811T titanium

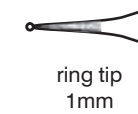

ring tip  
1mm

Fenestrated handle / TC dust ring tip / 2 mm tip / 6" (15.5 cm)

- 1103-813



1103-811



1103-811T

**Russian Adson Micro Forceps**

Fenestrated handle / with platform / 5 1/4" (13.3 cm)

- 136-671A straight
- 136-671B curved



136-671A



136-671B

Fenestrated handle / 1 x 2 teeth / 5 1/4" (13.3 cm)

- 136-671C straight



136-671C

Fenestrated handle / straight / 1 x 2 teeth / 5 3/4" (14.5 cm)

- 136-671D

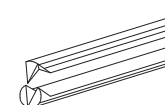

136-671D

**Jewelers Bipolar Forceps**

**Straight / 0.5 mm tip / #5 tip / 4 3/4" (12.1 cm)**

2700-918



2700-918

**Adson Bipolar Forceps**

**1 mm tip / 4 3/4" (12 cm)**

2700-905

2700-900

2700-902 4mm angled tip blue electro coat



2700-900



2700-902

**1 mm tip / fenestrated handle / 4 3/4" (12 cm)**

2700-902F 4 mm angled tip blue electro coat

2700-906 pointed tips



2700-902F



2700-906

**1 mm tip / fenestrated handle / non-stick / black coated / 4 3/4" (12 cm)**

2700-908NS straight

2700-903NS angled



2700-908NS

**Jewelers Bipolar Forceps**

**0.4 mm tip / 4" (10 cm)**

2700-920 straight

2700-922 curved

2700-915 straight blue coat



2700-920



2700-915

**Insulated / non-stick / straight / 4 1/4" (10.8 cm)**

2700-924NS 0.5 mm



2700-924NS

**McPherson Bipolar Forceps**

**Smooth tying platform / 0.4 mm tip / 3 1/2" (9 cm)**

16-2700 straight

16-2710 angled



16-2700



16-2710

**Jewelers Bipolar Forceps**

**Blue electro coat / straight**

16-2760



16-2760

**Tenzel Bipolar Forceps**

**Stop gap 0.5 mm / 0.4 mm tip / 4" (10 cm)**

2700-925



2700-925

**Cushing Bipolar Forceps**

1.5 mm tip / blue electro coating / 7" (18 cm)  
2700-995



2700-995

**Cushing Bipolar Forceps**

Black insulated / non-stick / 1.5 mm tip  
/ 7" (18 cm)  
2700-995NS



**Tissue Bipolar Forceps**

Black insulated / non-stick / 2.0 mm tip  
/ 6" (15 cm)  
2700-862NS  
2700-864NS with stop pin



2700-862NS



2700-864NS

**Hardy Bayonet Bipolar Forceps**

1 mm tip / insulated / straight / 8 1/2" (21.5 cm)  
2700-959



2700-959

**Coaptation Bipolar Forceps**

0.4 x 3 mm tip / 4 1/4" (10.5 cm)  
2700-930



2700-930

**Bipolar Bayonet Suction Wide Grip Forceps**

Black insulated / with suction / stop pin / 1.4 mm  
2700-817 8" (20.3 cm)  
2700-819 9" (22.9 cm)



2700-817

**Black Bipolar Bayonet Irrigation Forceps**

Insulated / with stop pin / straight / 1.2 mm  
2700-810 6 3/4"  
2700-812 8"  
2700-814 8 3/4"  
2700-815 9"



2700-810



 Sontec Instruments®

FORCEPS Ring Handle

**Jacobson-Gemini Mixer Right Angle Forceps**

**Full curve**

- 150-348 5" (12.7 cm)
- 150-349 5 1/2" (14 cm)
- 150-350 6 1/4" (16 cm)
- 150-351 7 1/8" (18.25 cm)
- 150-353 8" (20 cm)
- 150-355 9" (23 cm)
- 150-356 10" (25.5 cm)
- 150-357 11" (28 cm)
- 150-361 12" (30.5 cm)
- 150-358 14" (35.5 cm)
- 150-359 16" (40.5 cm)



150-348

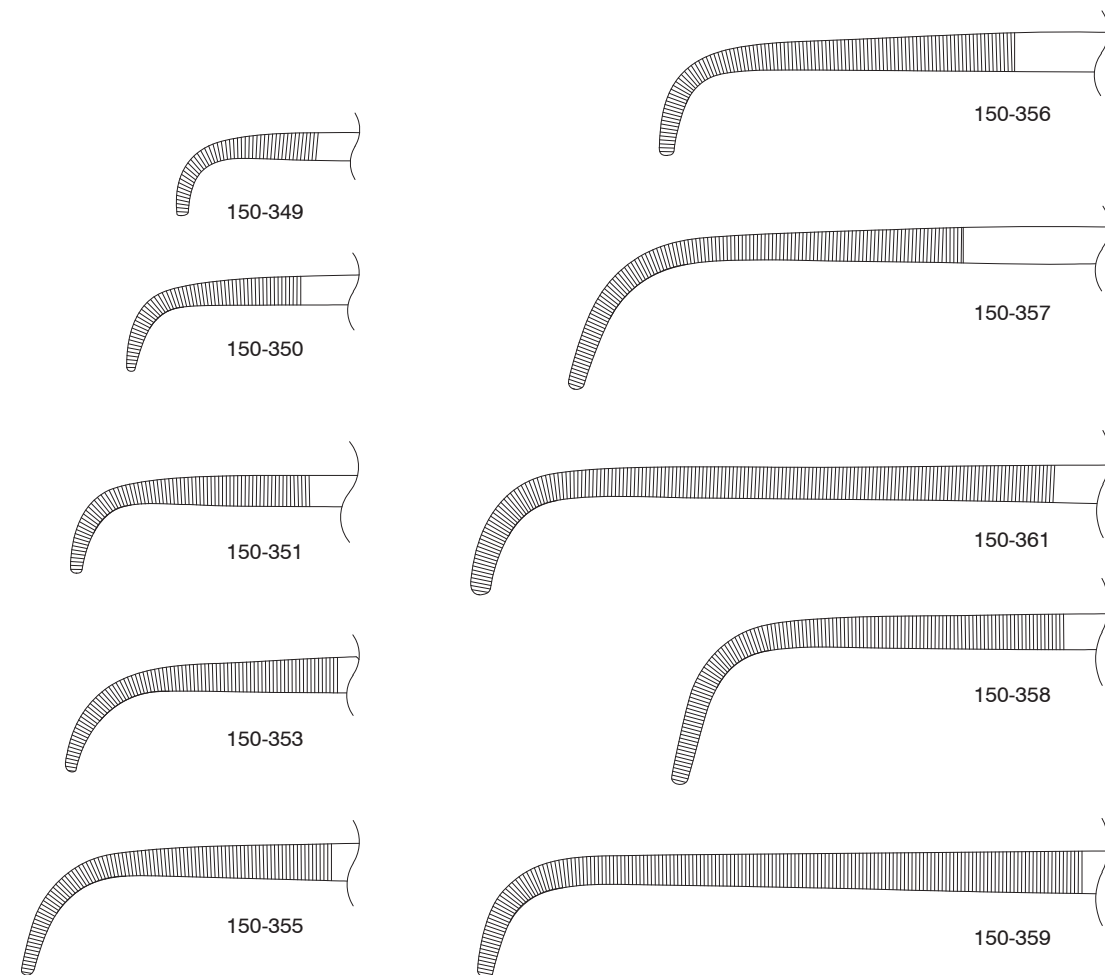

**Lincoln Dissecting Forceps**

4 1/2" (11.5 cm)

115-295 90° 15 mm jaw length

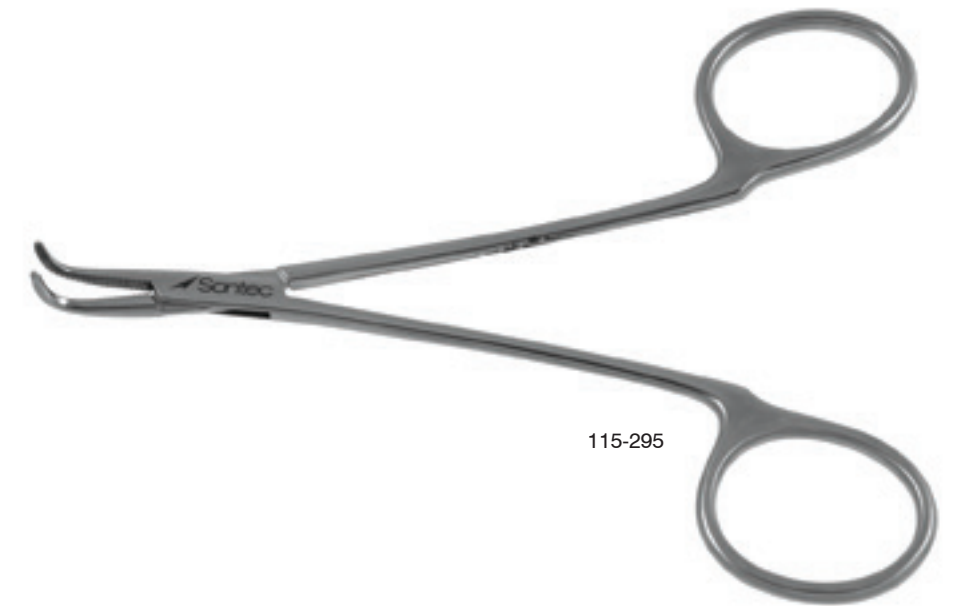

115-295

**Mixer Right Angle Forceps**

**Right angle / serrated**

- 2200-530 6 1/4" (15 cm)
- 2200-532 7" (18 cm)
- 2200-534 9" (23 cm)
- 2200-536 10 3/4" (26.5 cm)

**Right angle / longitudinal serrations**

- 2200-540 8 3/4" (22 cm)
- 2200-542 10 3/4" (26.5 cm)
- 2200-544 11" (28 cm)

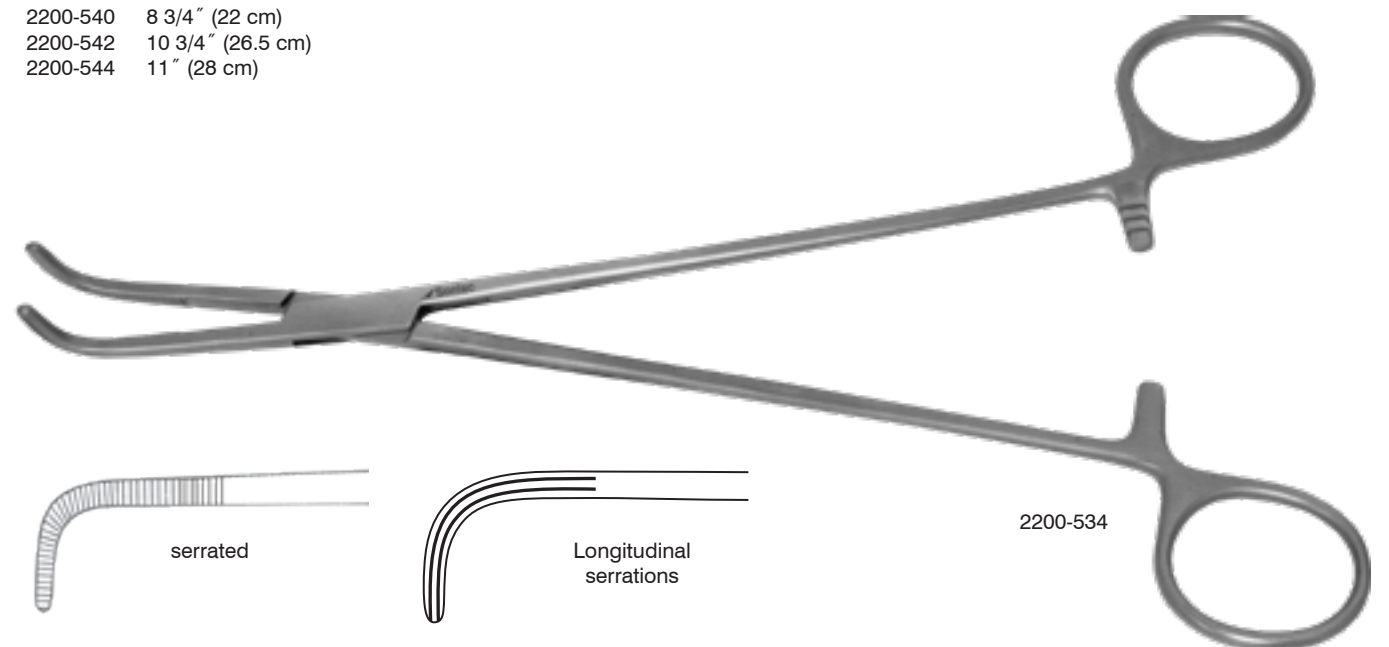

2200-534

**Mixer-Paul Right Angle Forceps**

Right angle / serrated / 8" (20 cm)

2200-550



2200-550

right angle

**Micro Tip Mixer Right Angle Forceps**

Partial serrated / 90° angle / 5 1/4" (13 cm)

2200-521

Serrated / 90° angle / 7 1/4" (18.5 cm)

2200-523A



2200-521

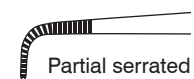

Partial serrated



serrated

**Waterston Dissecting Forceps**

Curved

2200-567 40 mm jaw 6" (15 cm)

2200-569 41 mm jaw 6 3/4" (17 cm)

90° angle

2200-566 33 mm jaw 6" (15 cm)

2200-568 43 mm jaw 6 3/4" (17 cm)

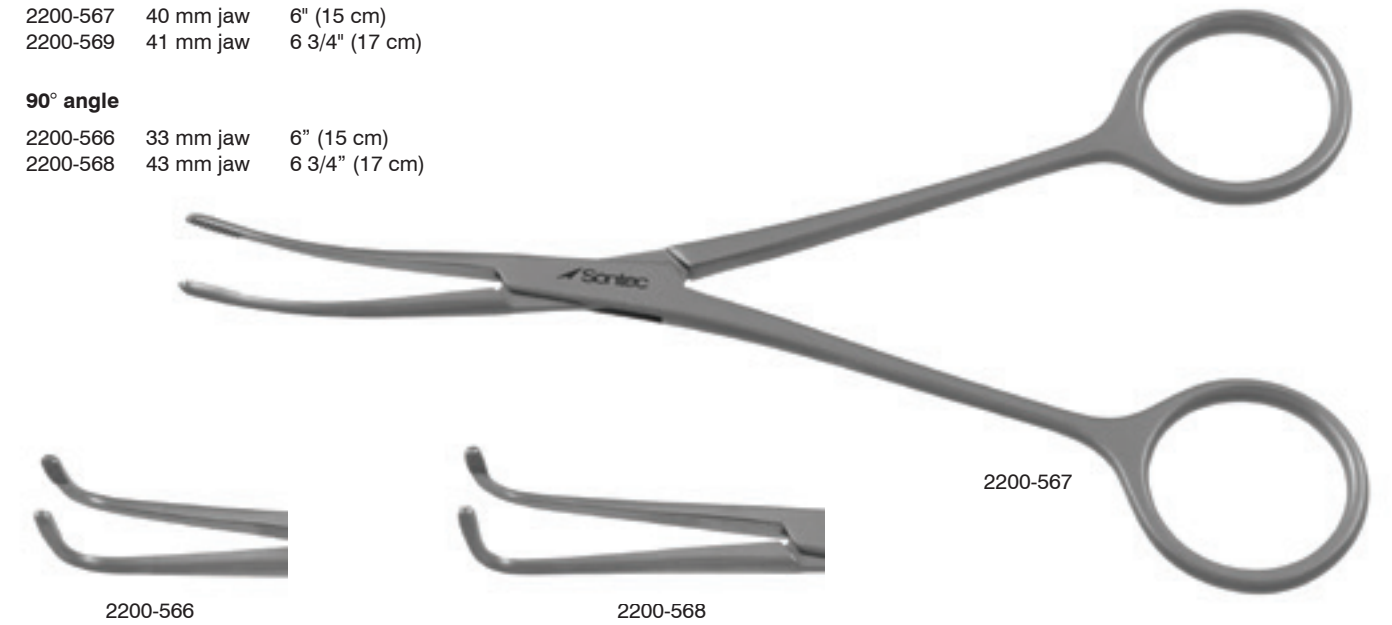

2200-567

2200-566

2200-568

**Bailey Hemostatic Acute Angle Forceps**

Extra-fine tapered jaws / 30° angle

2200-526 5 1/4" (13 cm)

2200-524 7" (18 cm)

2200-537 9" (23 cm)



30°

60°

90°

Extra-fine tapered jaws / 60° angle

2200-527 5 1/4" (13 cm)

2200-525 7" (18 cm)

2200-538 9" (23 cm)

2200-546 10" (25 cm)

2200-547 11" (28 cm)

2200-548 12" (30.5 cm)

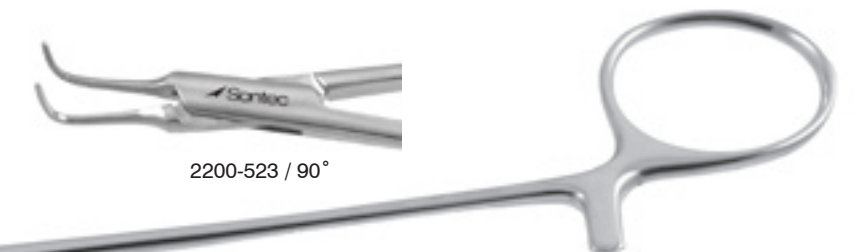

2200-523 / 90°



2200-525 / 60°

Extra-fine tapered jaws / 90° angle

2200-528 5 1/4" (13 cm)

2200-523 7" (18 cm)

2200-539 9" (23 cm)

2200-554 10" (25 cm)

2200-555 11" (28 cm)

2200-556 12" (30.5 cm)



2200-524 / 30°

**Olsen-Lahey Right Angle Forceps**

For PDA procedures / longitudinal serrations / cross-serrated tip

- 150-307 5 3/4" (14.5 cm)
- 150-315 7" (18 cm)

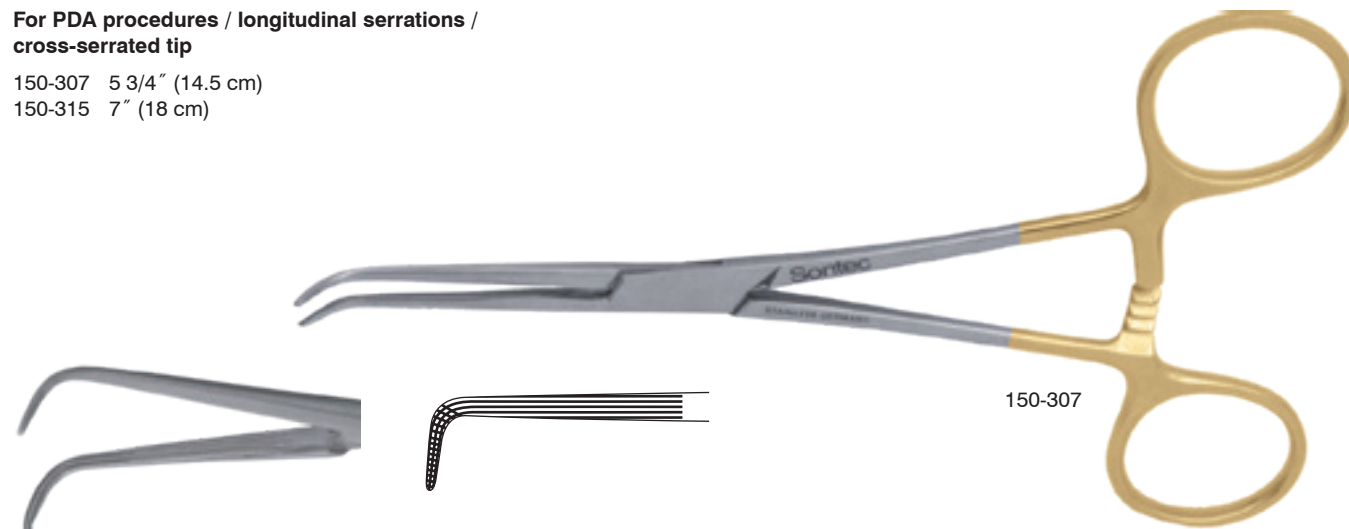

**Ochsner Acute Angle Forceps**

Extra-fine tapered jaws / 4 3/4" (12 cm)

- 2200-518 60°
- 2200-519 90°

5 1/2" (14 cm)

- 2200-516 60°
- 2200-517 90°

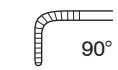
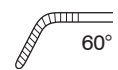

**Hartman Mosquito Forceps**

Delicate / 3 1/2" (9 cm)

- 115-426D straight
- 115-428D curved



Standard / 3 1/2" (9 cm)

- 115-426 straight
- 115-428 curved

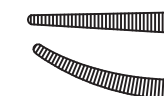

Micro tip / 3 3/4" (9.5 cm)

- 115-310 straight
- 115-312 curved

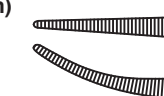

Shank angled on flat / straight / 3 1/2" (9cm)

- 115-429



straight



**Halstead Mosquito Forceps**

Standard / 1 x 2 teeth / 5" (13 cm)

- 115-422 straight
- 115-424 curved



1 x 2 teeth straight



1 x 2 teeth curved

Specially tapered jaws / straight / 1 x 2 micro teeth / 5" (13 cm)

- 115-422M



**Halstead Mosquito Forceps**

5" (13 cm)

- 115-410 straight standard
- 115-410D straight delicate
- 115-412 curved standard
- 115-412D curved delicate
- 1100-140L curved standard left

**Blue coated / standard / 5" (13 cm)**

- 115-4121 curved

**Curved/ streamlined/ 5" (13 cm)**

- 115-412S

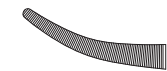

115-412



115-410

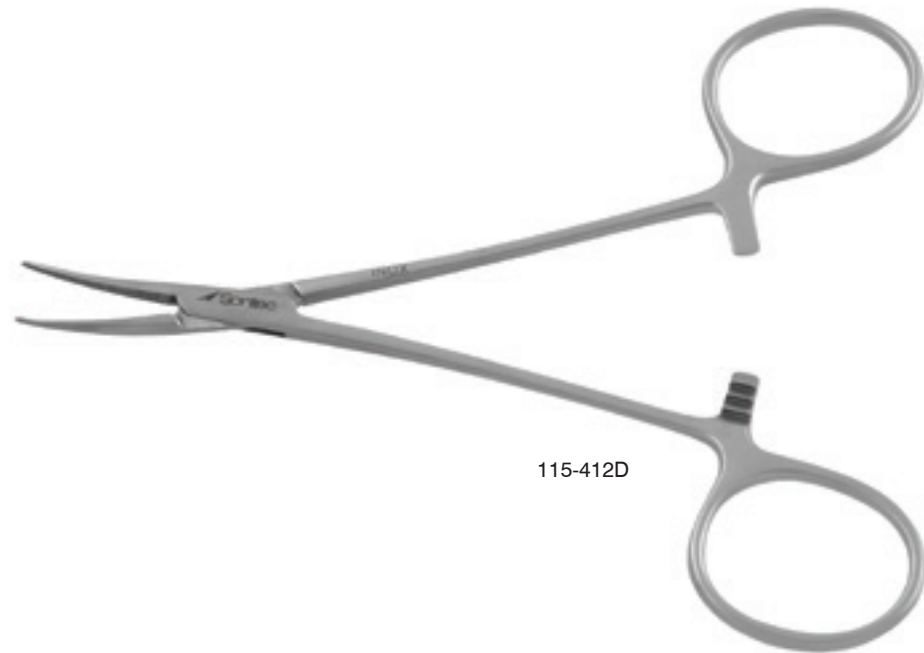

115-412D

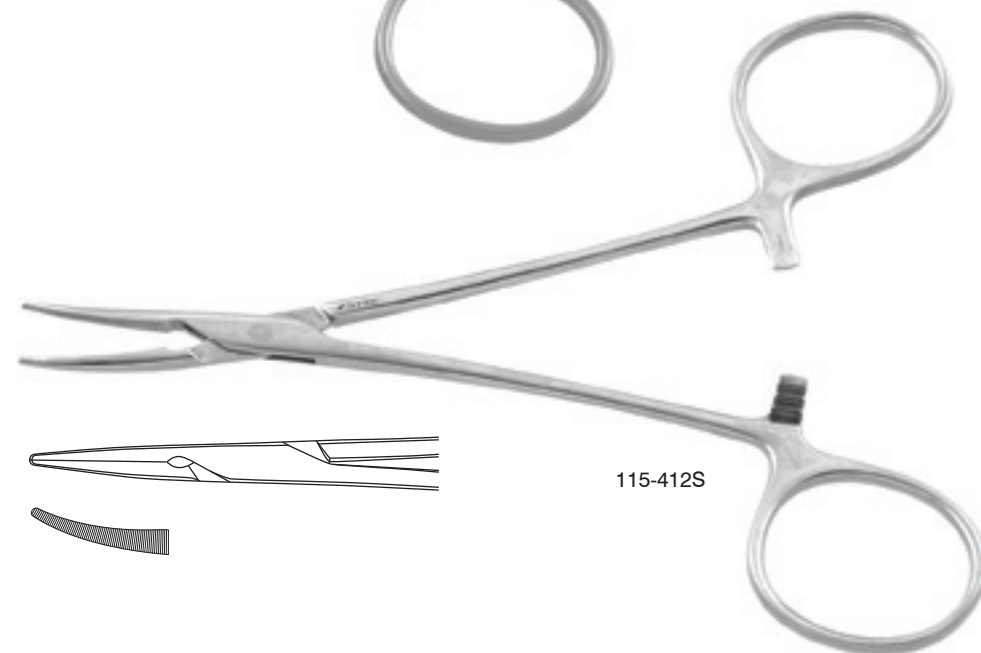

115-412S

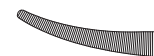

**Sontec Mosquito Forceps**

**Extreme micro / overall extremely delicate design / 1 mm tip / 3 3/4" (9.5 cm)**

- 1103-817 straight
- 1103-818 curved

**Extreme micro / overall extremely delicate design / 1 mm tip / 5" (13 cm)**

- 1103-815 straight
- 1103-816 curved

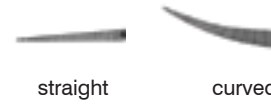

straight

curved

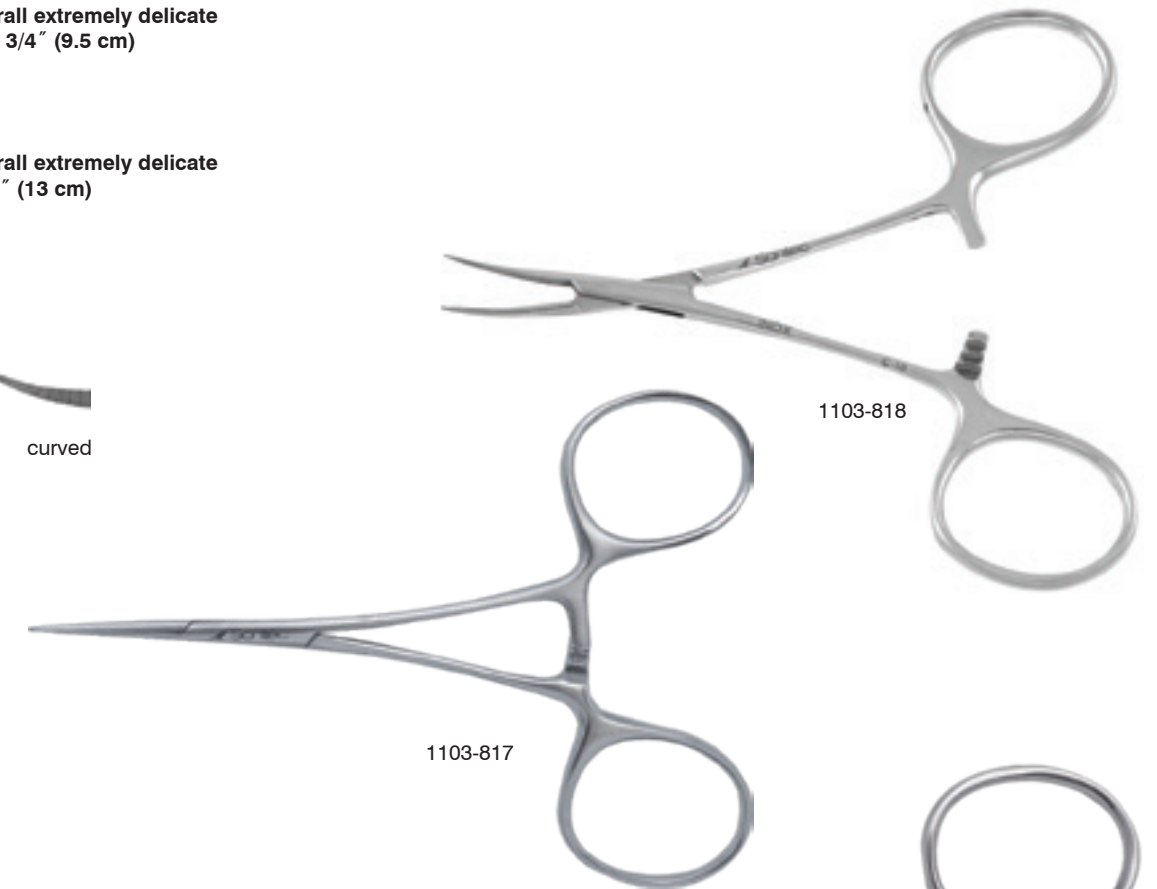

1103-818

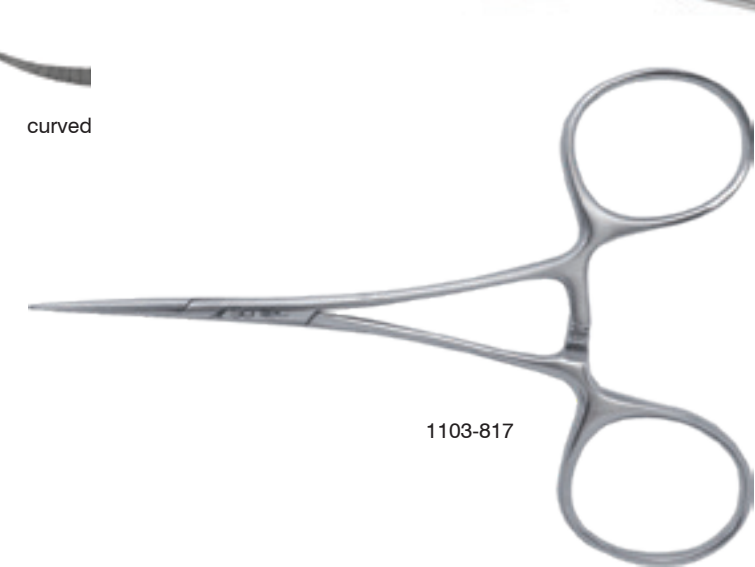

1103-817

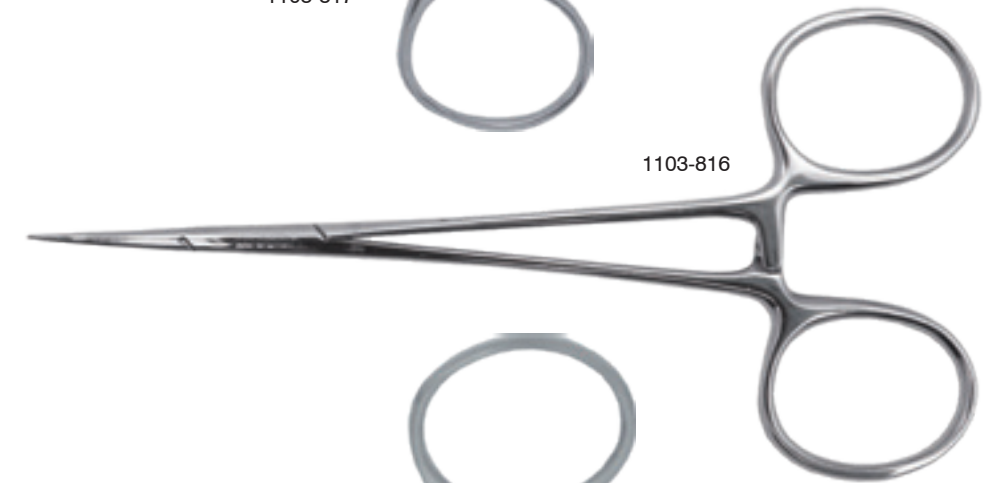

1103-816

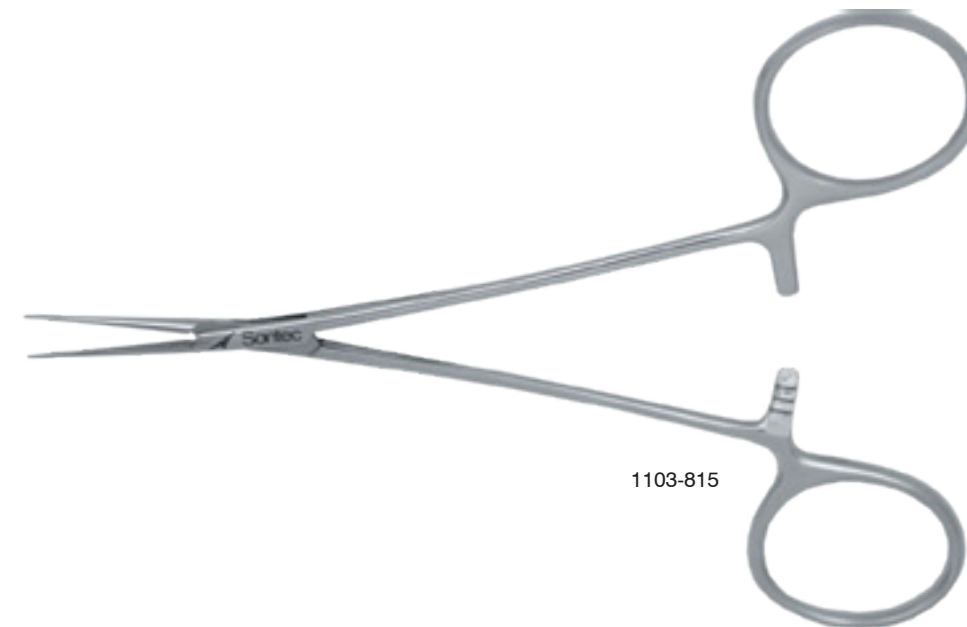

1103-815

**Schmidt Hemostatic Forceps**

**Serrated / 7 1/2" (19cm)**

- 485-634 slight curve
- 485-636 curved
- 485-646 slight curve closed ring
- 485-648 curved closed ring

**Serrated / 11" (28 cm)**

- 438-591 straight closed ring
- 438-592 slight curve closed ring

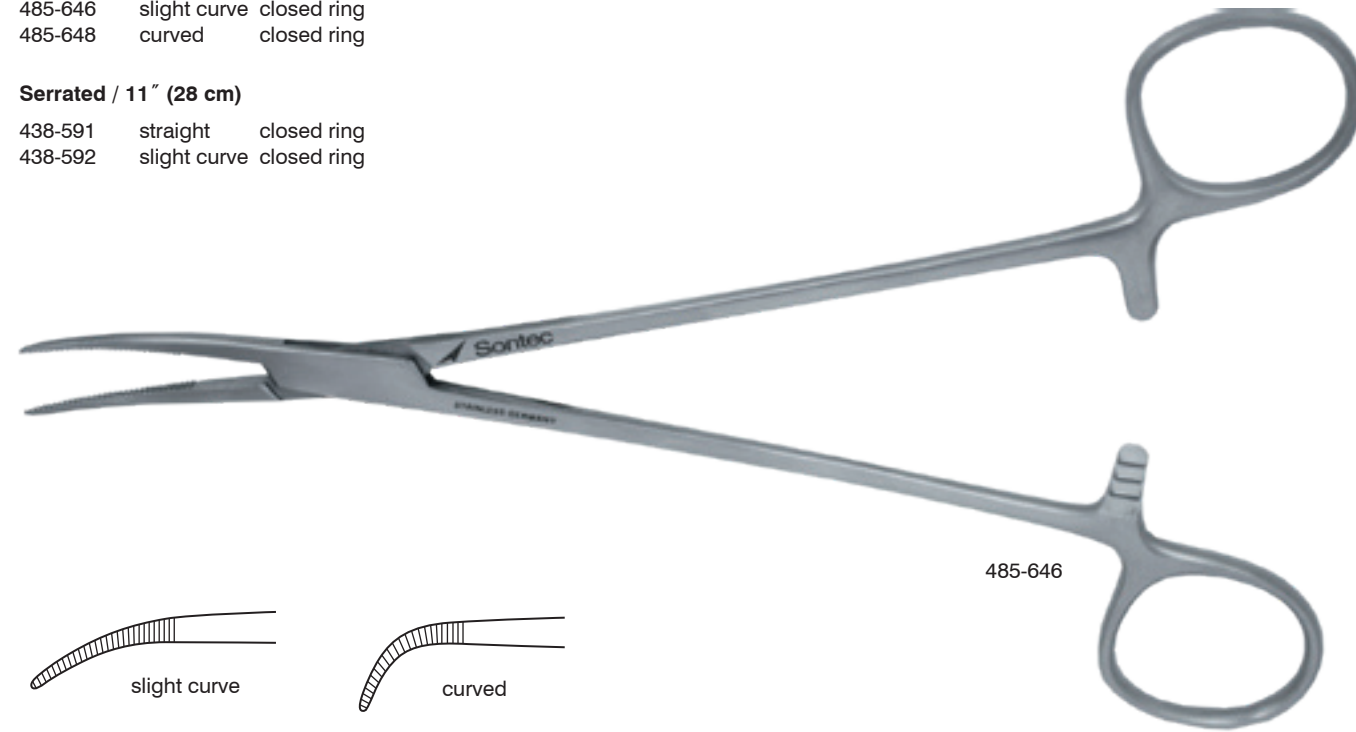

485-646

**Bainbridge Forceps**

**Delicate / Longitudinal serrations with cross-serrated tip / 6" (15 cm)**

- 115-600 straight
- 115-602 curved

**Delicate / Longitudinal serrations with cross-serrated tip / 7 1/4" (18.5 cm)**

- 115-604 straight
- 115-606 curved

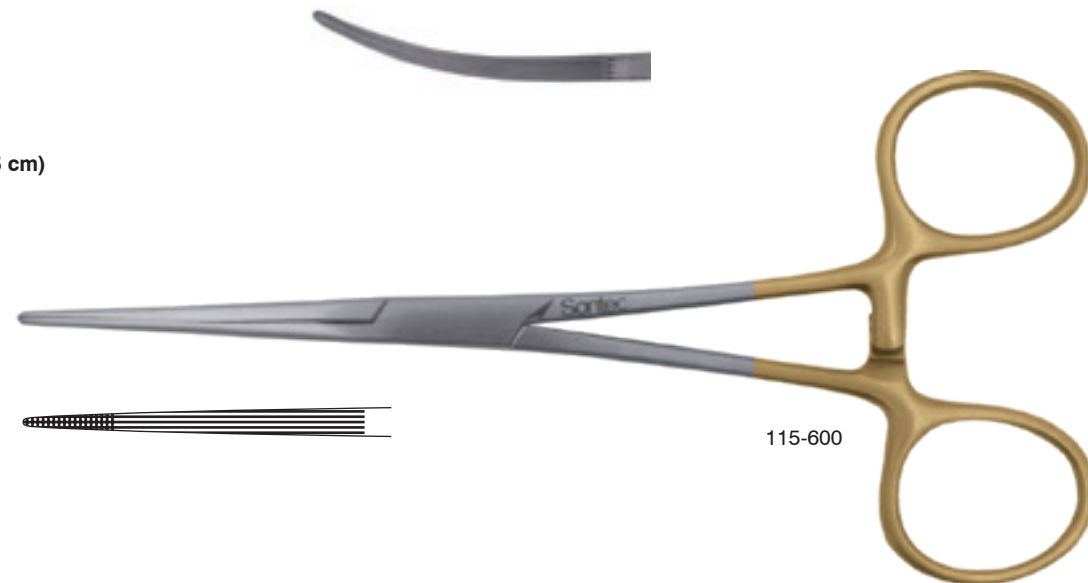

115-600

**Rankin-Kelly Forceps**

**6 1/4" (16 cm)**

- 115-465 straight
- 115-467 curved

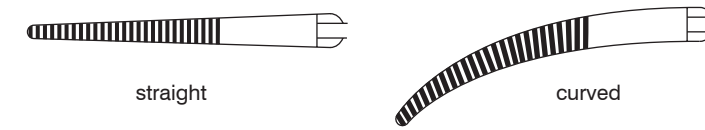

straight

curved

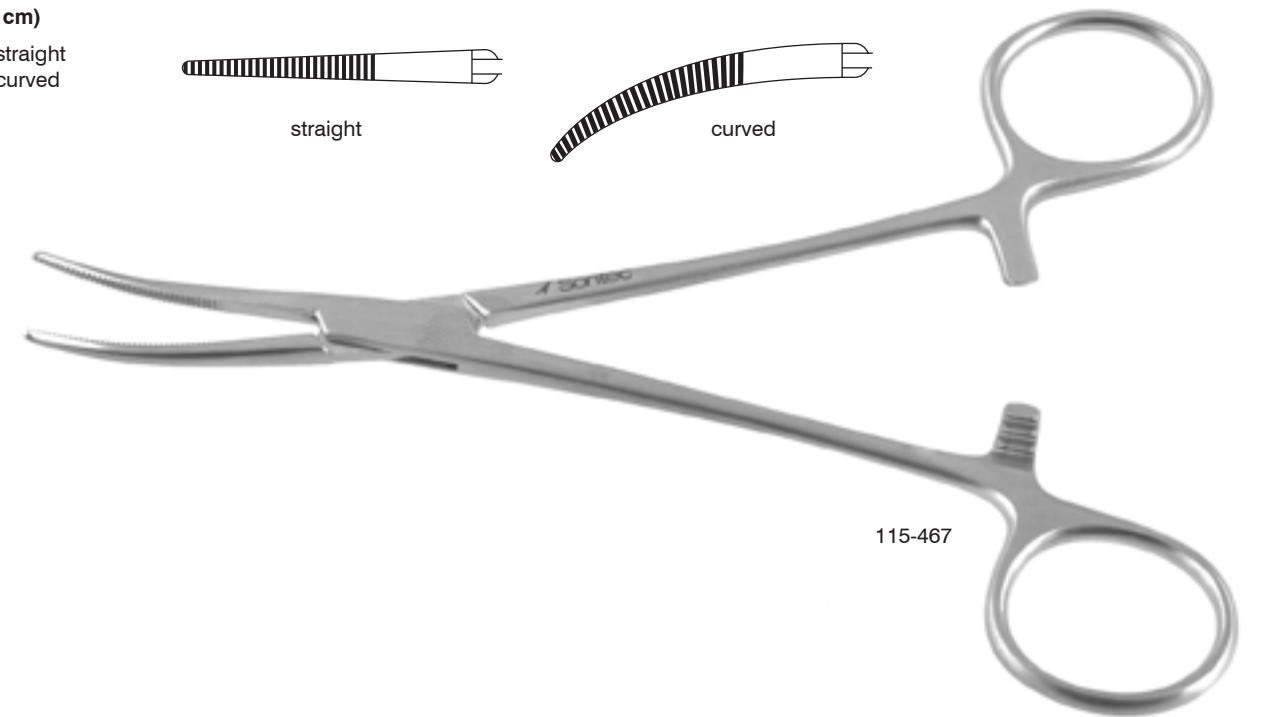

115-467

**Coller-Crile Forceps**

**Delicate jaw / 5 1/2" (14 cm)**

- 115-454 straight
- 115-458 curved

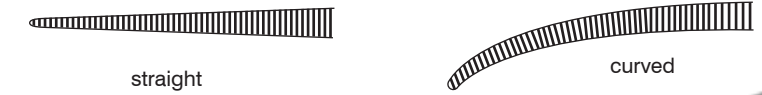

straight

curved

**Delicate jaw / 6 1/4" (16 cm)**

- 115-456 straight
- 115-460 curved

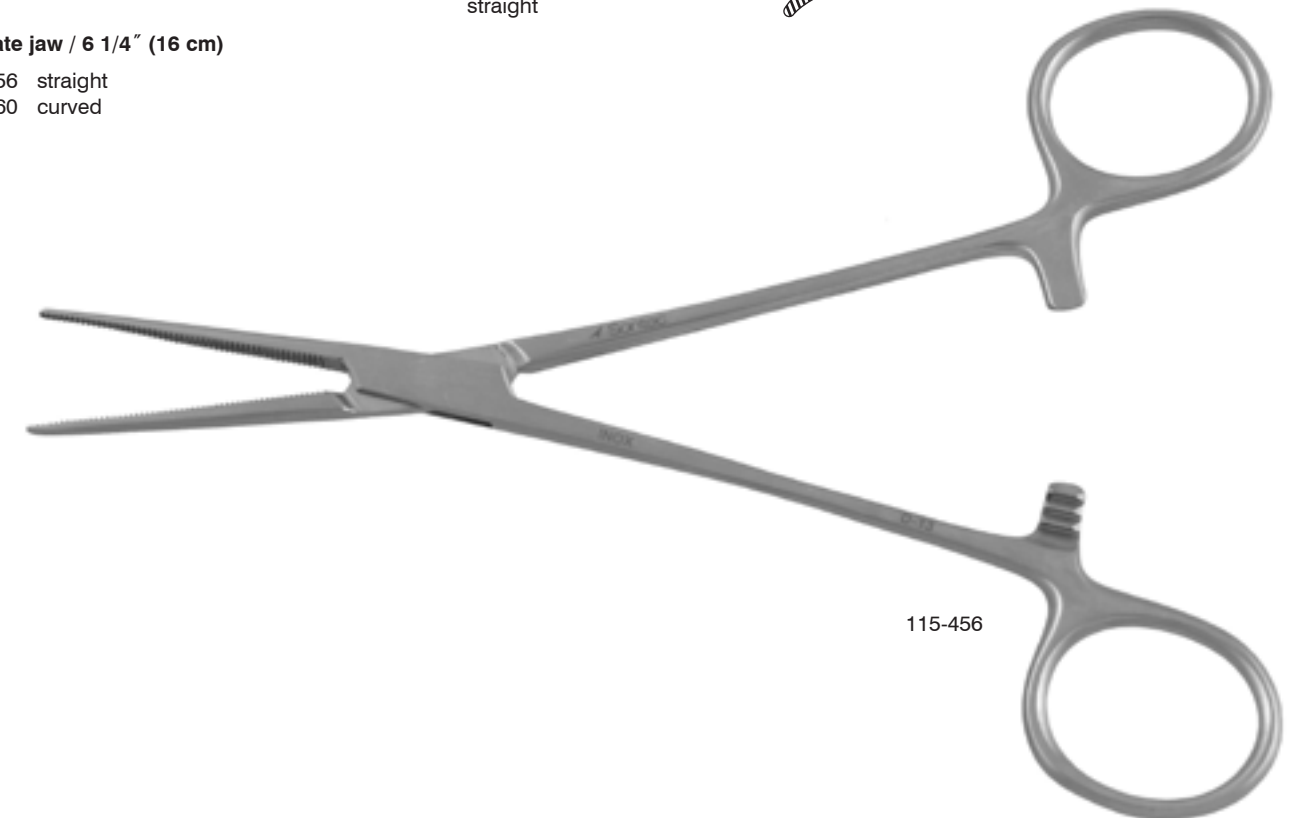

115-456

**Crile Forceps**

**5 1/2" (14 cm)**

- 115-432 straight
- 115-434 curved

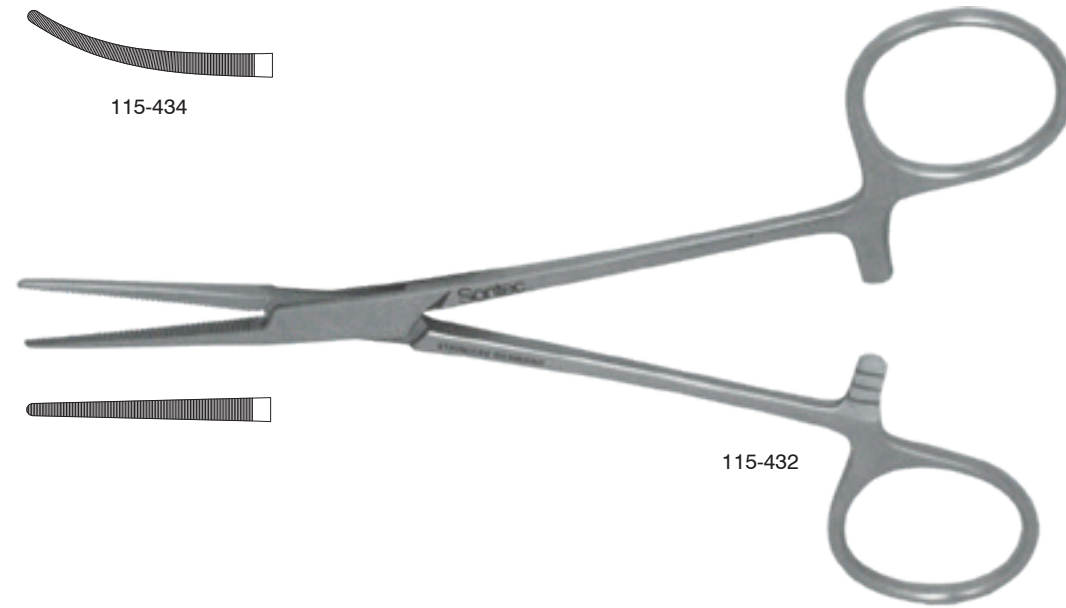
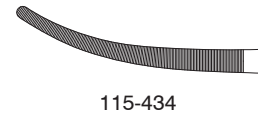

**6 1/4" (16 cm)**

- 115-450 straight
- 115-452 curved



**Titanium / 6 1/4" (16 cm)**

- T115-452 curved
- T115-450 straight



**Rochester-Pean Forceps**

**Serrated / 5 1/2" (14 cm)**

- 115-480 straight
- 115-482 curved

**Serrated / 6 1/4" (16 cm)**

- 115-484 straight
- 115-486 curved

**Serrated / 7 1/4" (18.5 cm)**

- 115-490 straight
- 115-492 curved

**Serrated / 8" (20 cm)**

- 115-500 straight
- 115-502 curved

**Serrated / 9" (23 cm)**

- 115-506 straight
- 115-508 curved

**Serrated / 10 1/4" (25.5 cm)**

- 115-514 straight
- 115-515 curved

**Serrated / 12" (30 cm)**

- 115-510 straight
- 115-512 curved



**Rochester-Ochsner Forceps**

**Serrated / 1 x 2 teeth / 6 1/4" (16 cm)**

- 115-520 straight
- 115-522 curved



straight

**Serrated / 1 x 2 teeth / 7 1/4" (18.5 cm)**

- 115-524 straight
- 115-526 curved



curved

**Serrated / 1 x 2 teeth / 8" (20 cm)**

- 115-530 straight
- 115-532 curved

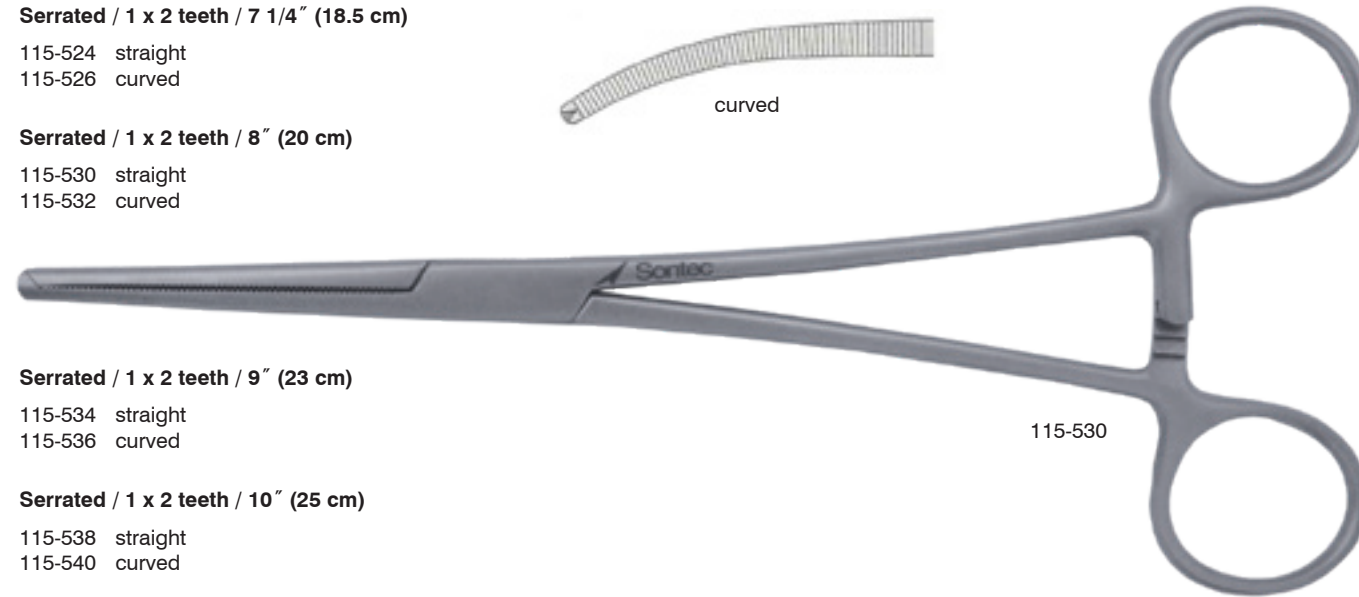

115-530

**Serrated / 1 x 2 teeth / 9" (23 cm)**

- 115-534 straight
- 115-536 curved

**Serrated / 1 x 2 teeth / 10" (25 cm)**

- 115-538 straight
- 115-540 curved

**Ochsner Baby Forceps**

**1 x 2 teeth / 5 1/2" (14 cm)**

- 115-518 straight
- 115-519 curved



115-518

**Rochester-Carmalt Forceps**

**Serrated / cross-serrated tip / 6 1/4" (16 cm)**

- 1100-150 straight
- 1100-152 curved
- 1100-152L curved left

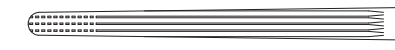

1100-150

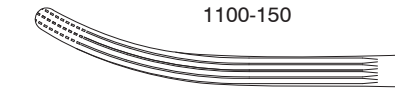

1100-152

**Serrated / cross-serrated tip / 8" (20 cm)**

- 1100-151 straight
- 1100-153 curved

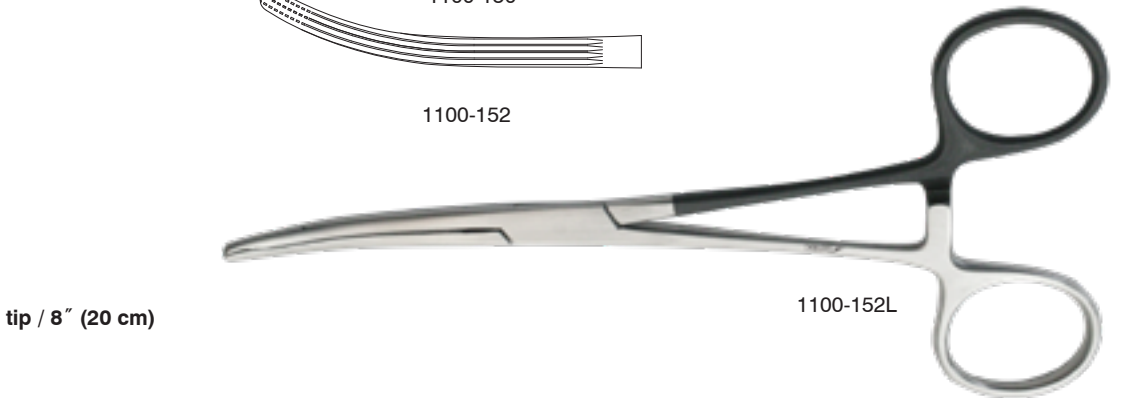

1100-152L

**Serrated / cross-serrated tip / 9" (23 cm)**

- 438-614 straight
- 438-615 curved



1100-151

**Serrated / cross-serrated tip / 10" (25 cm)**

- 438-610 straight
- 438-611 curved



438-610

**Serrated / cross-serrated tip / 12" (31 cm)**

- 438-612 straight
- 438-613 curved

**Kocher Forceps**

**Baby / 1 x 2 teeth / 5" (12.7cm)**

- 115-422K straight
- 115-424K curved

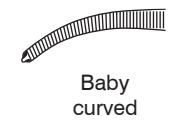
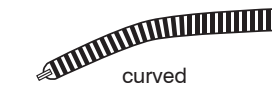

**Pean Intestinal Clamp Forceps**

**Longitudinal serrations / 8" (20 cm)**

- 142-140 straight
- 142-142 curved

**Longitudinal serrations / 9" (24 cm)**

- 142-144 straight
- 142-146 curved

**Longitudinal serrations / 10" (25 cm)**

- 142-148 straight
- 142-150 curved



**Doyen-Kocher Intestinal Forceps**

**Longitudinal serrations / 7" (18 cm)**

- 1101-160 straight
- 1101-161 curved

**Longitudinal serrations / 8" (20.5 cm)**

- 1101-162 straight
- 1101-163 curved

**Longitudinal serrations / 9" (23 cm)**

- 142-200 straight
- 142-202 curved

**Longitudinal serrations / 10 1/2" (27 cm)**

- 1101-164 straight
- 1101-165 curved

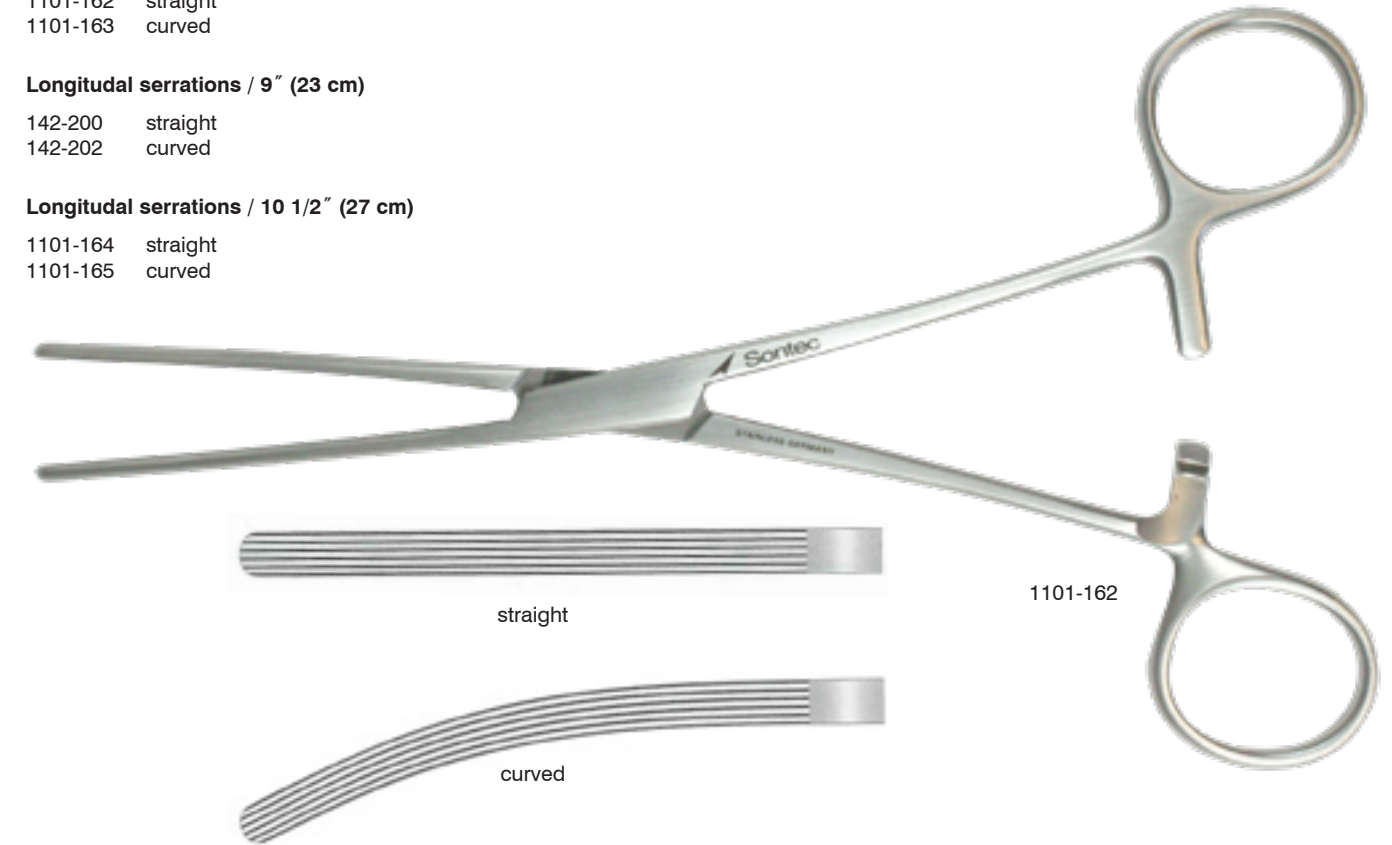

**Mayo Robson Forceps**

**Longitudinal serrations / 10 1/2" (26.5 cm)**

- 142-010 straight
- 142-015 curved



**Doyen-Debaquey Intestinal Clamp Forceps**

**Atraumatic jaws / 5" (13 cm)**

- 142-197 straight
- 142-198 curved



**Atraumatic jaws / 7" (18 cm)**

- 1100-161D straight
- 1100-163D curved



**Atraumatic jaws / 8" (20 cm)**

- 1100-1618 straight
- 1100-1638 curved

**Atraumatic jaws / 9" (23 cm)**

- 1100-162D straight
- 1100-164D curved



**Atraumatic jaws / 10" (25.5 cm)**

- 142-207 straight
- 142-208 curved

**Atraumatic jaws / 11" (28 cm)**

- 1101-162D straight
- 1101-163D curved

**Atraumatic jaws / 13" (33 cm)**

- 1101-160D straight
- 1101-161D curved

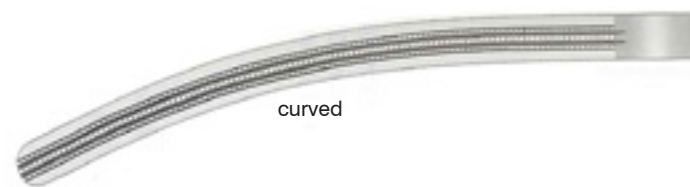
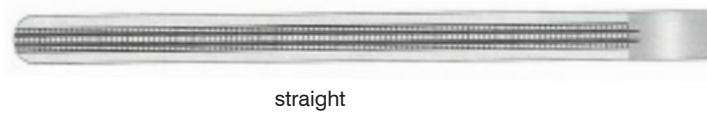
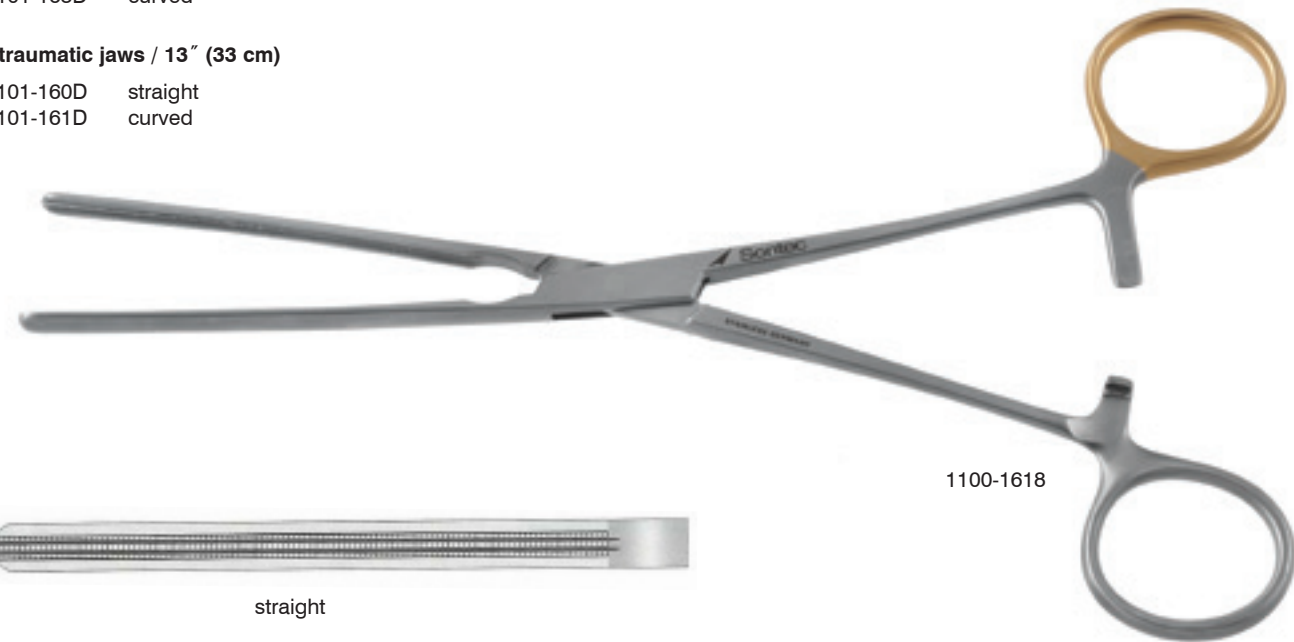

**Doyen Intestinal Clamp Forceps**

**Diagonal serrations / 7" (18 cm)**

- 1100-161 straight
- 1100-163 curved

**Diagonal serrations / 9" (23 cm)**

- 1100-162 straight
- 1100-164 curved

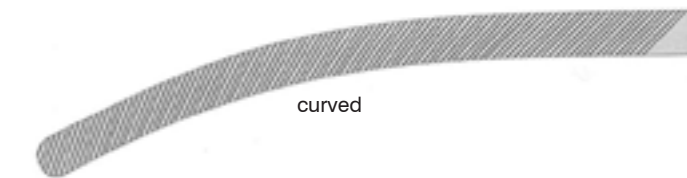
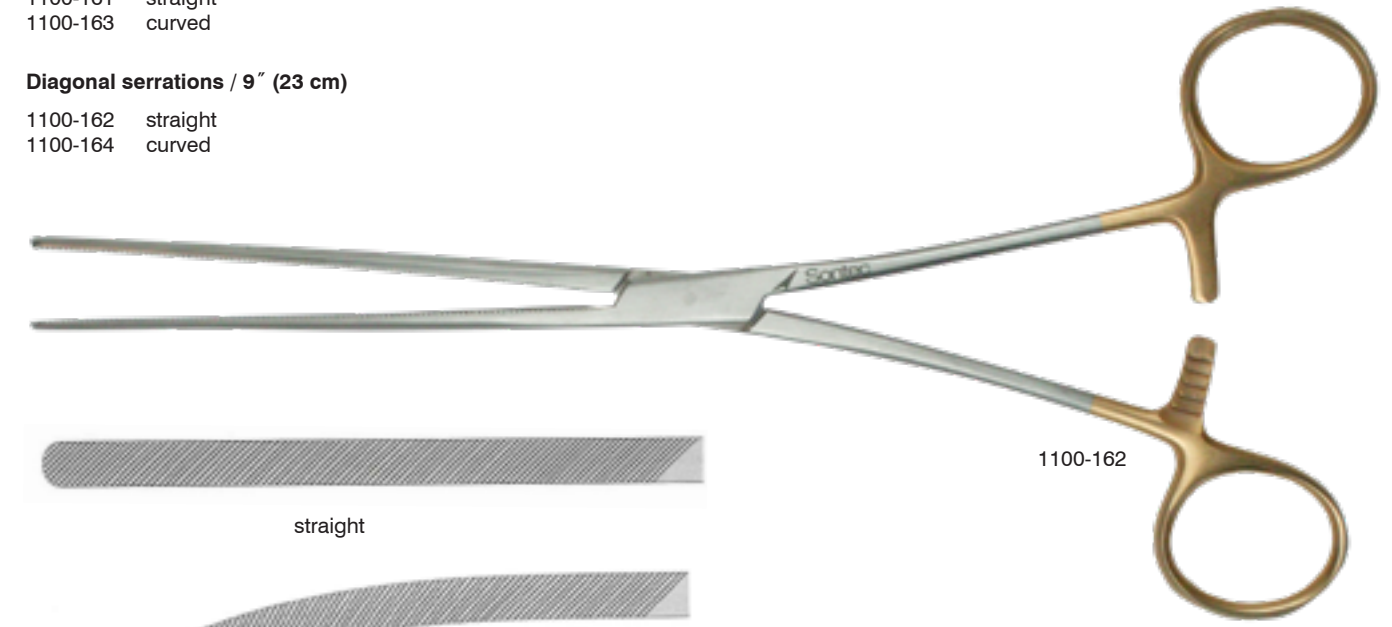

**Babcock Tissue Forceps**

**Micro tip / standard / straight**

- 140-380 5 1/2" (13.5 cm)
- 140-381 6 1/4" (16 cm)
- 140-385 8" (20 cm)
- 140-383 9" (23 cm)

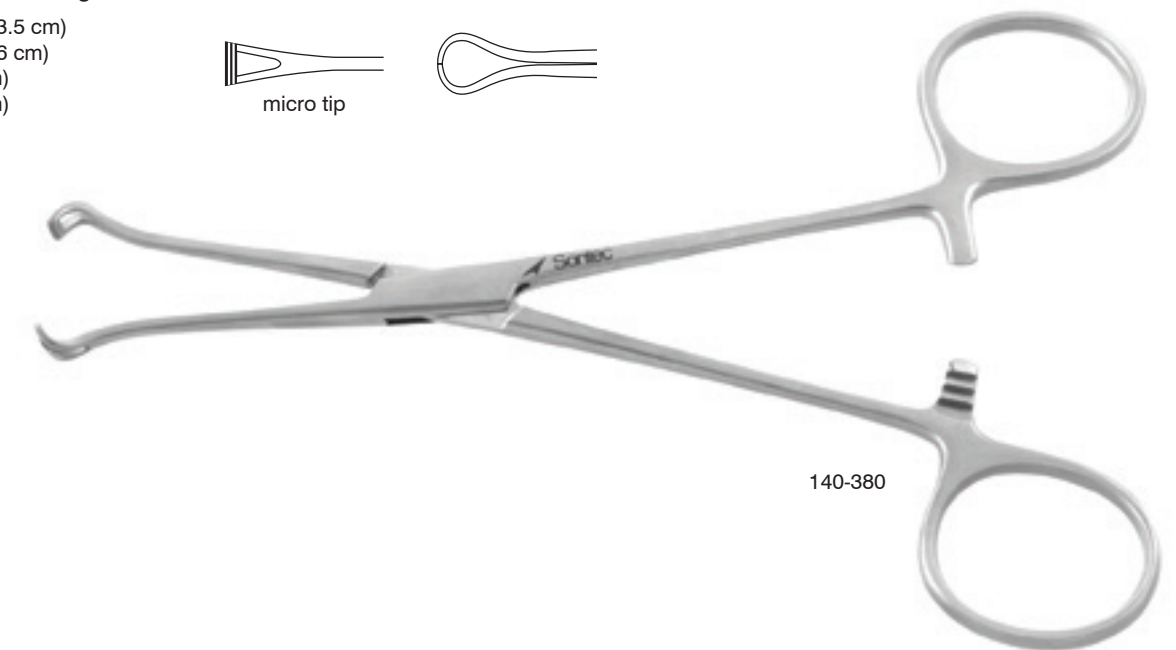

**Randall Kidney Stone Forceps**

8 3/4" (22 cm)

- 516-240 1/4 curve
- 516-242 1/2 curve
- 516-244 3/4 curve
- 516-246 full curve

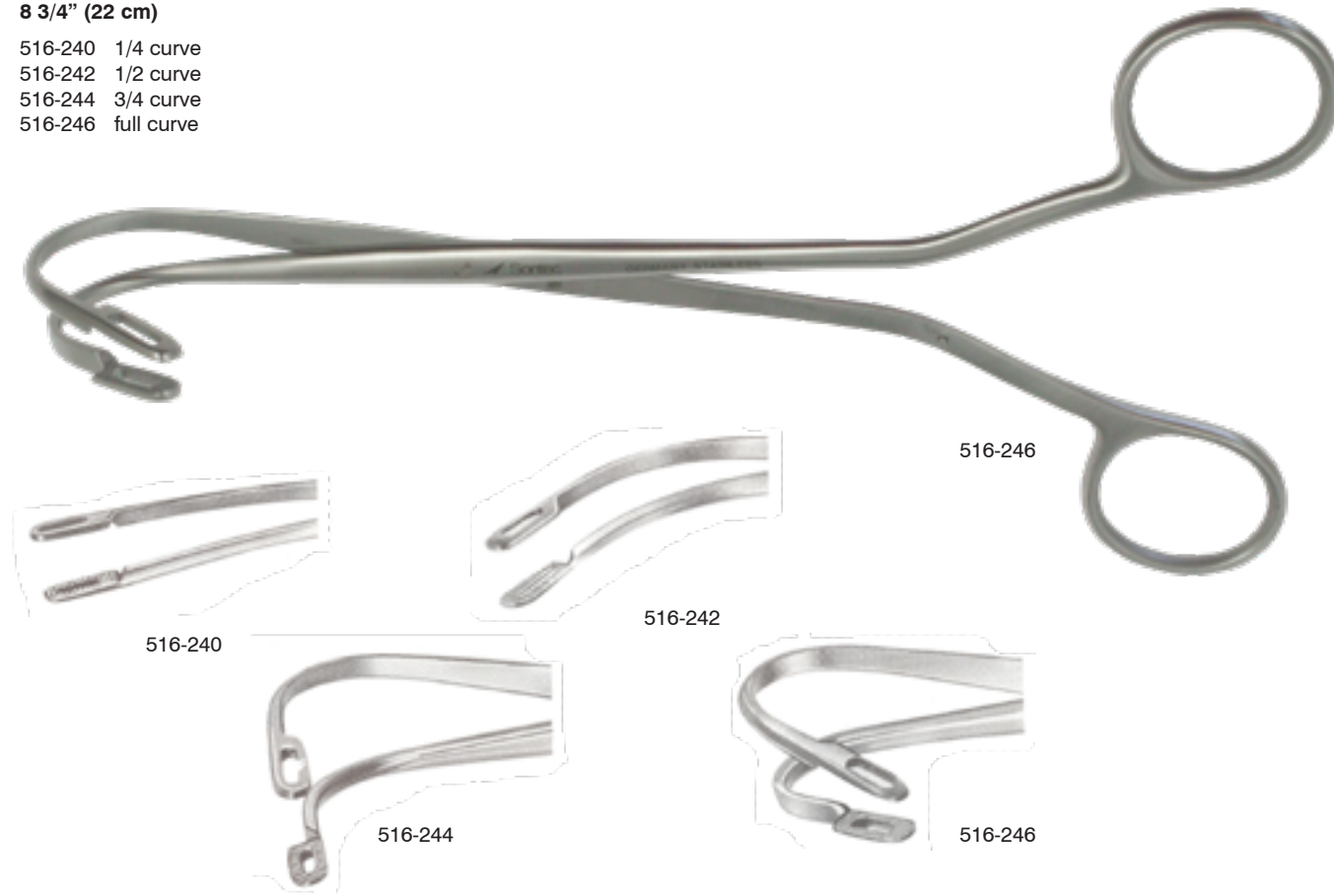

**Ferguson Tenaculum Clamp Forceps**

6 3/4" (17 cm) / straight jaw

508-532



**Allis Tissue Forceps**

4 x 5 teeth

- 140-315 5 1/2" (14 cm) delicate
- 140-320 6" (15 cm)

Baby / 4 x 5 teeth

- 140-313 5" (12.5 cm)

5 x 6 teeth

- 140-322 6" (15 cm)
- 140-330A 7" (18 cm)
- 140-329 7 1/2" (19 cm)
- 140-331 7 1/2" (19 cm) delicate
- 140-334 10" (25 cm)

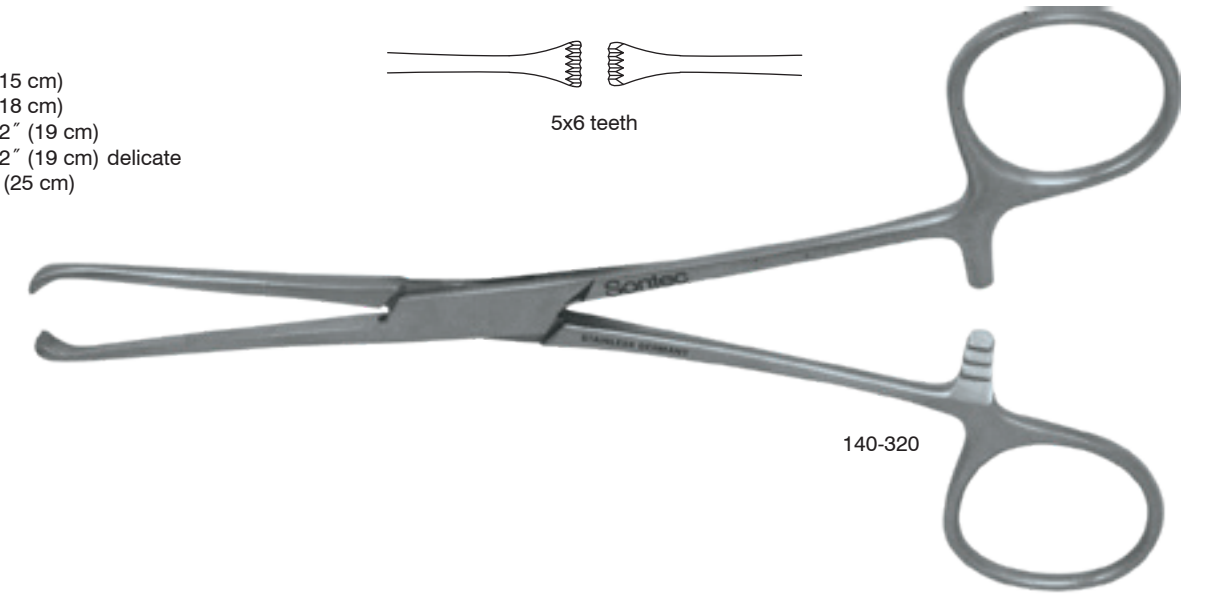
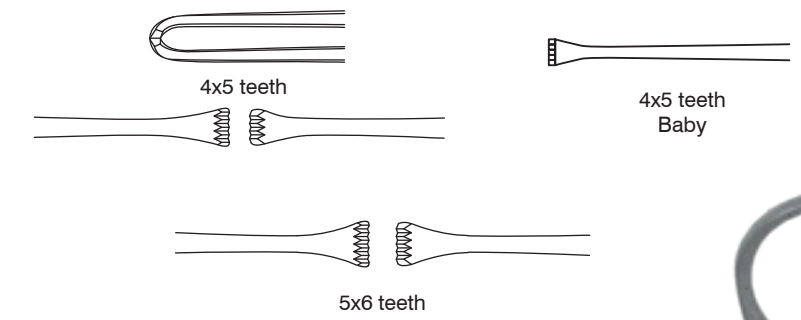

**Buie Pile Clamp Forceps**

Curved angiotribe jaw

508-534 8" (20 cm)

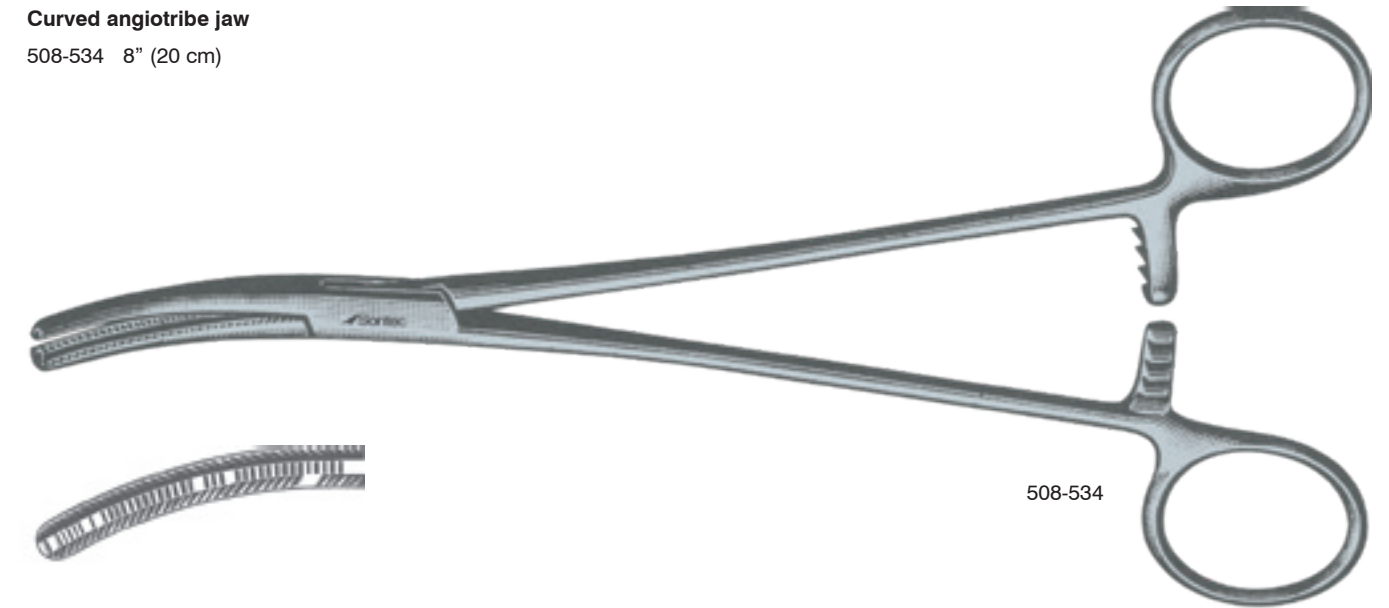

**Foerster Sponge Forceps**

**Straight / serrated**

- 123-601 7" (18 cm)
- 123-603 8" (20.5 cm)
- 123-606 9 1/2" (24 cm))



**Straight / smooth**

- 123-600 7" (18 cm)
- 123-605 9 1/2" (24 cm)



**Curved / serrated**

- 123-611 7" (18 cm)
- 123-608 8" (20.5 cm)
- 123-616 9 1/2" (24 cm)

**Curved / smooth**

- 123-610 7" (18 cm)
- 123-615 9 1/2" (24 cm)



**Jones Towel Clamp Forceps**

**Cross action / stainless**

- 14-9990 2 1/4" (5.5 cm)
- 14-9992 3 1/2" (7.5 cm)

**Cross action / titanium**

- T14-9990 2 1/2" (6 cm)



**Backhaus Towel Forceps**

- 117-500 3 1/2" (9 cm)
- 117-500L 3 1/2" (9 cm) left handed
- T117-500 3 1/2" (9 cm) titanium



**Backhaus Towel Forceps**

117-501 4 1/4" (10.8 cm)  
117-503 5 1/4" (13.5 cm)



117-501

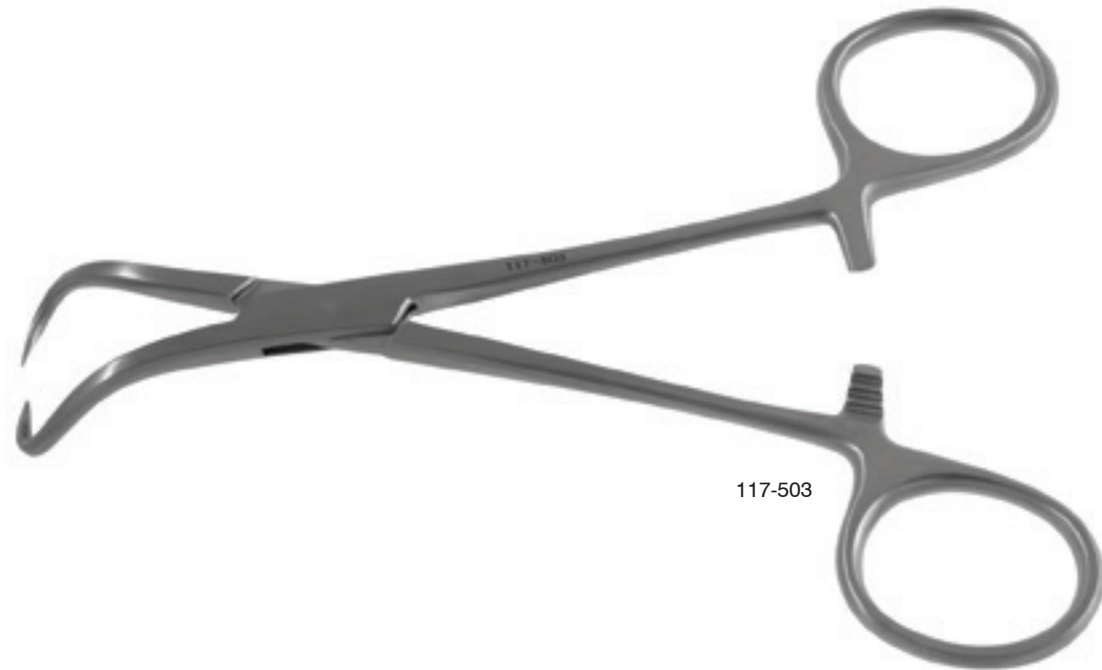

117-503

**Lorna-Edna Towel Forceps**

117-518 4" (10 cm)  
117-521 5 1/2" (14 cm)



117-518



117-521

**Tohoku Towel Forceps**

117-523 5 1/8" (13 cm)



117-523



 Sontec Instruments®

Neuro HOOKS

**Doolen Neuro Hook**

1 mm ball tip / 90° / 8" (20.5 cm)

- 2700-501 2 mm from angle
- 2700-502 3 mm from angle



**Krayenbuehl Nerve Hook**

90° / 7 1/4" (18.5 cm)

- 400-445 2 mm tip length
- 400-445C 2 mm tip length sharp
- 400-447 2 mm tip length 1 mm ball tip
- 400-446 3 mm tip length
- 400-448 3 mm tip length 1 mm ball tip



**Krayenbuehl Nerve Hook Extra Long Version**

Round Handle / special long model / 11" (27.9 cm)

- 400-445L 2 mm tip length
- 400-447L 2 mm tip length 1 mm ball tip
- 400-446L 3 mm tip length
- 400-448L 3 mm tip length 1 mm ball tip



**Tufts Pigtail Neuro Hook Probe**

With ball tip / twist right / large / 6 1/2" (16.5 cm)

412-443



**Culler Neuro Round Handle Hook**

Unique sharp 3 mm tip length / 5 1/2"

412-445D

5 mm tip length

- 412-445B 0.7 mm Ø x 5 mm tip length 4 3/4"
- 412-445A 1 mm Ø x 5 mm tip length 4 3/4"
- 412-445CL 1 mm tip Ø 6 1/4"

0.5 mm Ø tip

- 412-445C 3 mm tip length 4 5/8"
- 412-445AL 3 mm tip length 6 1/4"
- 412-445BL 2 mm tip length 6 1/4"

1 mm Ø 45° 4 mm tip / 6 1/4"

412-445EL



**Lucae Ear Hook**

Fine / indent ball end / 6" (15 cm)

- 468-169 2.0 mm
- 468-170 2.5 mm
- 468-171 3.0 mm
- 468-172 4.0 mm



468-171

**Wagner Hook**

5 1/2" (14 cm)

- 468-181 size 1
- 468-182 size 2
- 468-183 size 3
- 468-184 size 4
- 468-185 size 5



468-183



size 1



size 2



size 3



size 4



size 5

**Nerve Hook Titanium**

Bayonet / ball Tip (0.5mm) / 9 1/4" (23.5 cm)

412-618T



412-618T



**Cushing Dura Hook**

6 1/2" (16 cm)

412-414



412-414

**Cloward Dura Hook**

6 1/2" (16 cm)

412-415



412-415

**Graham Dura Hook**

6 1/2" (16 cm)

412-422



412-422

**Micro Hook Titanium**

90° graduation (1 mm) / 7 1/2" (19 cm)

2700-504



2700-504



enlarged to show tip detail



 Sontec Instruments®

Rhoton Jacobson Curette & Dissector Hook Set

**Rhoton Circular Dissector 45°**

Stainless steel / 7 1/2" (19 cm)

413-001S	1 mm	stainless steel
413-001	1 mm	titanium
413-002S	2 mm	stainless steel
413-002	2 mm	titanium
413-003S	3 mm	stainless steel
413-003	3 mm	titanium

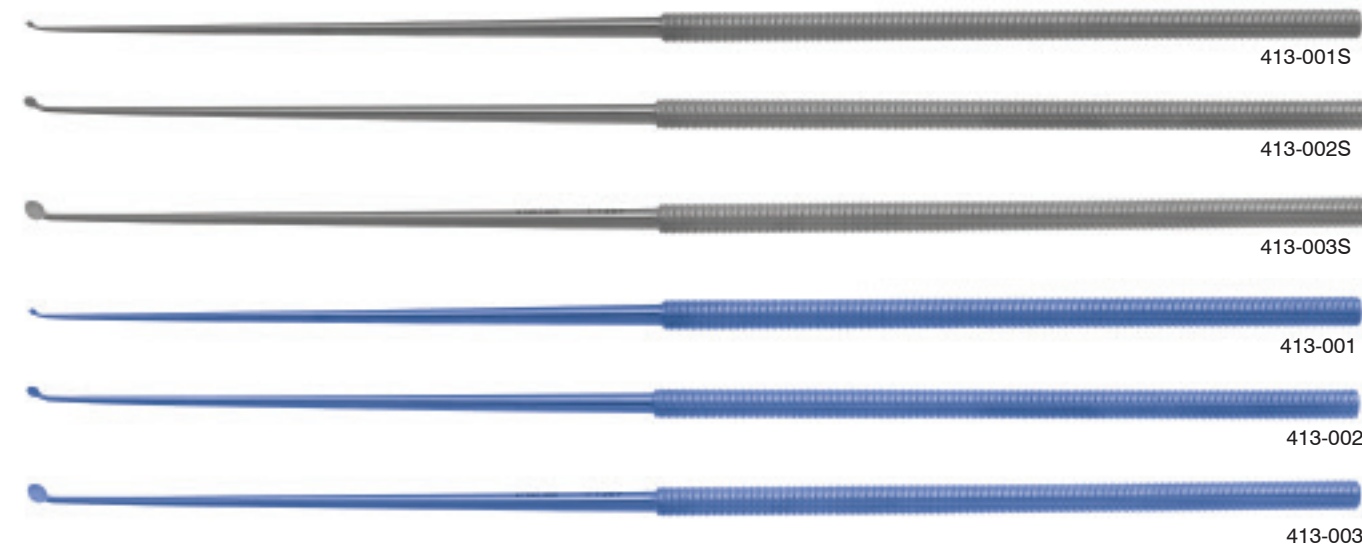

**Rhoton Dissector / Raspatory**

7 1/2" (19 cm)

413-004S	2.8 mm	curved	stainless steel
413-004	2.8 mm	curved	titanium
413-005S	1 mm	angled	stainless steel
413-005	1 mm	angled	titanium



**Jacobson Hook**

Sharp / 2 mm / 90° / 7 1/2" (19 cm)

413-006S	stainless steel
413-006	titanium



**Rhoton Dissector / Raspatory**

Semi-sharp / 25° / 7 1/2" (19 cm)

413-007S	1.5 mm	stainless steel
413-007	1.5 mm	titanium
413-008S	2 mm	stainless steel
413-008	2 mm	titanium
413-009S	1 mm	stainless steel
413-009	1 mm	titanium

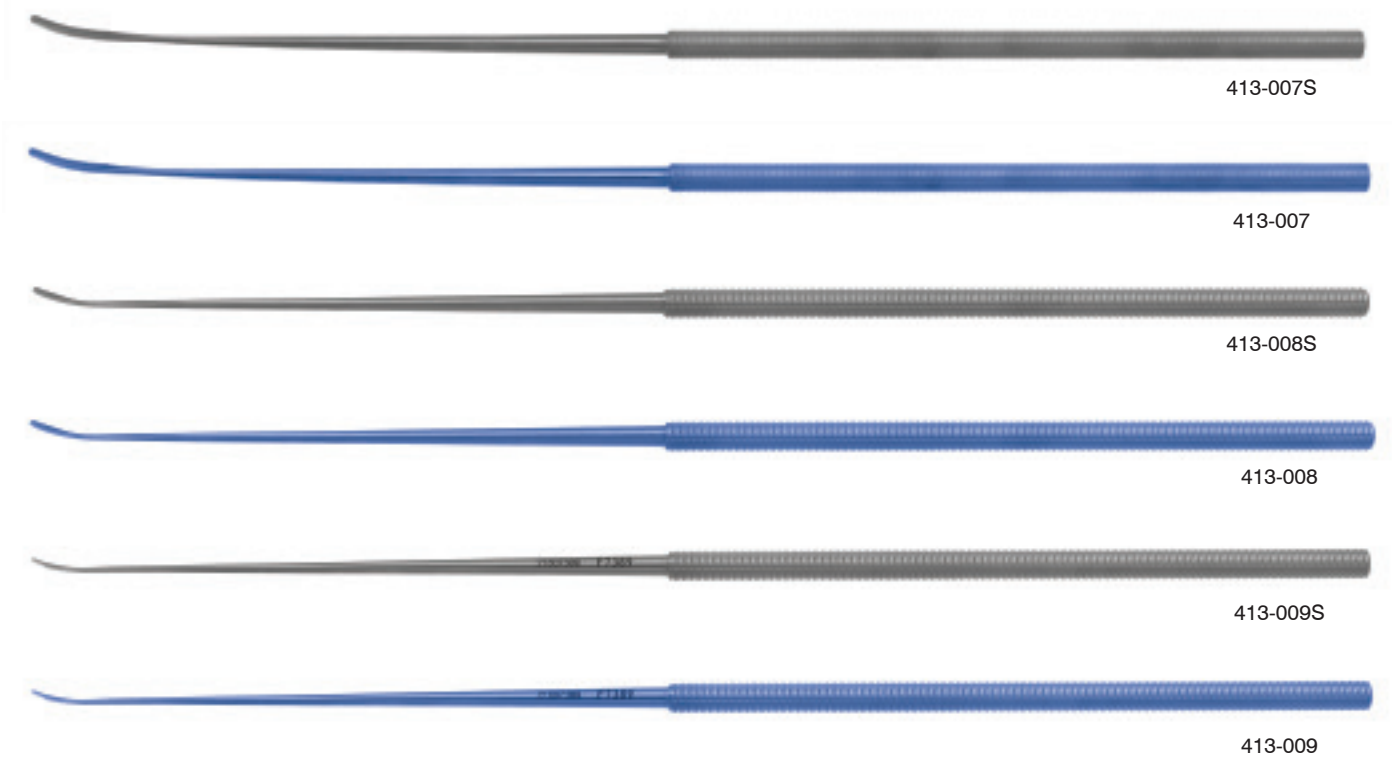

**Rhoton Hook**

7 1/2" (19 cm)

413-010S	90°	2 mm	blunt	stainless steel
413-010	90°	2 mm	blunt	titanium
413-011S	45°	3 mm	semi sharp	stainless steel
413-011	45°	3 mm	semi sharp	titanium



**Rhoton Pick**

Semi Sharp / straight / 7 1/2" (19 cm)

413-012S	stainless steel
413-012	titanium



**Rhoton Curette**

1 x 2 mm / 7 1/2" (19 cm)

413-013S	straight	stainless steel
413-013	straight	titanium
413-014S	45° angled	stainless steel
413-014	45° angled	titanium



**Jacobson Button End Probe**

Straight / blunt / 1 mm / 7 1/2" (19 cm)

413-015S	stainless steel
413-015	titanium



**Jacobson Hook Probe**

Angled 45° / 1x8 mm long / 7 1/2" (19 cm)

413-019S	stainless steel
413-019	titanium



**Jacobson Button End Hook Probe**

Angled 90° / 1 x 3.5 mm / 7 1/2" (19 cm)

413-016S	stainless steel
413-016	titanium



**Jacobson Hook Probe**

Blunt / Angled 90° / 1x5 mm long / 7 1/2" (19 cm)

413-017S	stainless steel
413-017	titanium

Blunt / Angled 45° / 1x5 mm long / 7 1/2" (19 cm)

413-018S	stainless steel
413-018	titanium



**Rhoton Instrument Tray**

**Stainless steel tray**

1103-708

\* instruments sold as complete set  
\* or can order individually / separate



**Rhoton Instrument Tray**

**Stainless solid**

1103-709

\* instruments sold as complete set  
\* or can order individually / separate





 Sontec Instruments®

ENT Plastic SUCTION ELEVATORS

**Pitanguy Raspatory Elevator With Suction**

7" (17 cm)

- 412-667A 2.5 mm
- 412-667B 3 mm
- 412-667D 3.5 mm
- 412-667C 4 mm



**Elevator With Suction**

7 1/4" (18.4 cm)

2700-320



**Nelms Suction Elevator**

- 2700-310 suction freer style sharp 7" (18 cm)
- 2700-312 suction freer style blunt 7" (18 cm)
- 2700-314 suction cottle style blunt 7 1/2" (19 cm)



**Daniel Endoscopic Forehead Elevator**

9 1/4" (23.5 cm)

478-370 slight curve with suction



**Pitanguy Elevator With Suction**

Blunt / 8" (20 cm)

475-855



**Haraldsson Elevator with Suction**

Distal tube connection swivels / 7 1/2" (19 cm)

478-360



**Gorney Elevator With Suction**

7 3/4" (20 cm)

478-375



**Gubisch Suction Elevator**

Straight

- 478-380 6"
- 478-382 8" bayonet





 Sontec Instruments®

SUCTION Selection

## General Suction Information

### French measurement scale for determining suction tube diameter

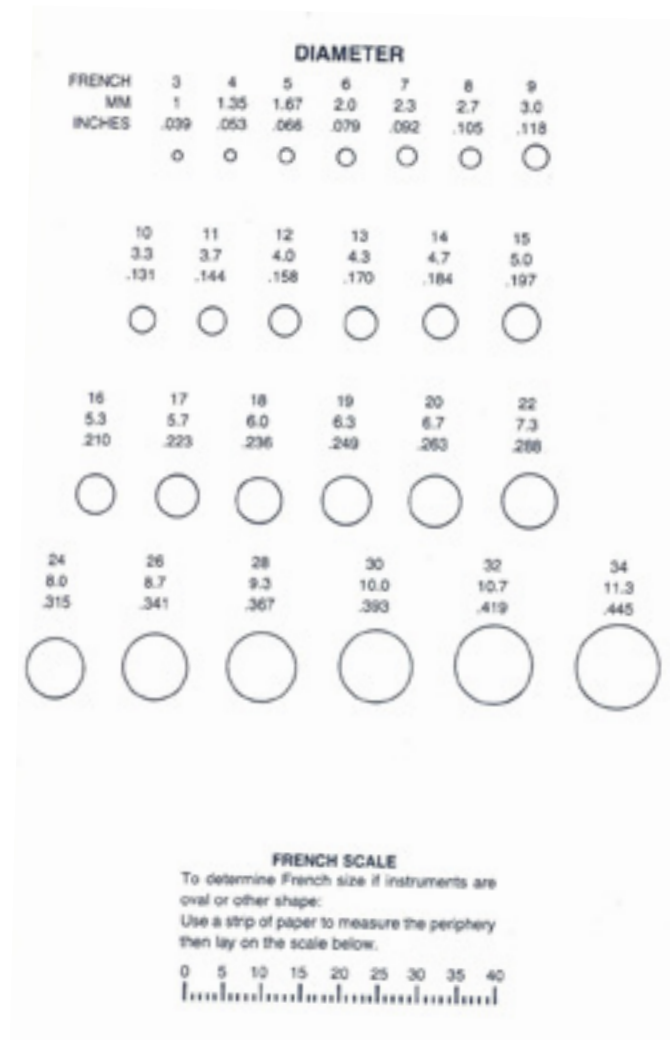

### Frazier Angled Suction

#### Finger cut-off hole to control suction / angled / 7" (18 cm)

- 412-677 3 french
- 412-678 4 french
- 412-679 5 french
- 412-680 6 french
- 412-681 7 french
- 412-682 8 french
- 412-683 9 french
- 412-684 10 french
- 412-685 11 french
- 412-686 12 french
- 412-688 15 french

#### 9" (23 cm)

- 412-705 10 french



#### Finger cut-off hole to control suction / angled / malleable / 7" (18 cm)

- 412-677M 3 french
- 412-678M 4 french
- 412-680M 6 french
- 412-681M 7 french
- 412-682M 8 french
- 412-683M 9 french
- 412-684M 10 french
- 412-685M 11 french
- 412-686M 12 french
- 412-688M 15 french

\* special order

#### Finger cut-off slot to control suction / angled / 7" (18 cm)

- 412-677L 3 french
- 412-678L 4 french
- 412-679L 5 french
- 412-680L 6 french
- 412-681L 7 french
- 412-682L 8 french
- 412-683L 9 french
- 412-684L 10 french
- 412-685L 11 french
- 412-686L 12 french

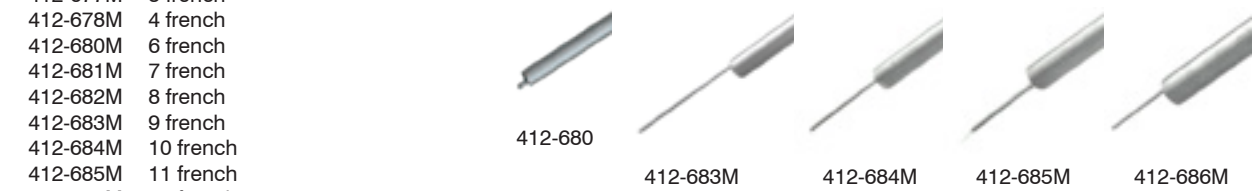

**Frazier Straight Suction**

Finger cut-off hole to control suction / straight / 7" (18 cm)

- 412-689 5 french
- 412-690 6 french
- 412-691 7 french
- 412-692 8 french
- 412-694 10 french
- 412-696 12 french



9" (23 cm)

- 412-700 6 french
- 412-701 7 french
- 412-702 8 french
- 412-704 10 french
- 412-706 12 french



**Frazier Insulated Suction**

Finger cut-off hole to control suction / angled / Insulated electro coated tube / 7" (18 cm)

- 412-677I 3 french
- 412-678I 4 french
- 412-679I 5 french
- 412-680I 6 french
- 412-681I 7 french
- 412-682I 8 french
- 412-683I 9 french
- 412-684I 10 french
- 412-685I 11 french
- 412-686I 12 french



**Fukushima Suction**

Tapered tube shaft / teardrop finger control / 7" (18 cm) working length

- 180-403 3 fr
- 180-404 4 fr
- 180-405 5 fr
- 180-406 6 fr
- 180-407 7 fr
- 180-408 8 fr
- 180-409 9 fr
- 180-410 10 fr
- 180-411 11 fr
- 180-412 12 fr



Tapered tube shaft / teardrop finger control / 8" (20.5 cm) working length

- 180-373 3 fr
- 180-374 4 fr
- 180-375 5 fr
- 180-376 6 fr
- 180-377 7 fr
- 180-378 8 fr
- 180-379 9 fr
- 180-380 10 fr
- 180-381 11 fr
- 180-382 12 fr

\* Also available in 6 1/2" sizes



**Rhoton Micro Neuro Suction**

**Specially blunted atraumatic tips / 80 mm working length**

- 412-839 3 french
- 412-840 5 french
- 412-844 7 french
- 412-841 10 french



**100 mm working length**

- 412-845 3 french
- 412-848 5 french
- 412-846 7 french
- 412-847 10 french

**130 mm working length**

- 412-849 5 french
- 412-850 7 french
- 412-851 10 french
- 412-852 12 french

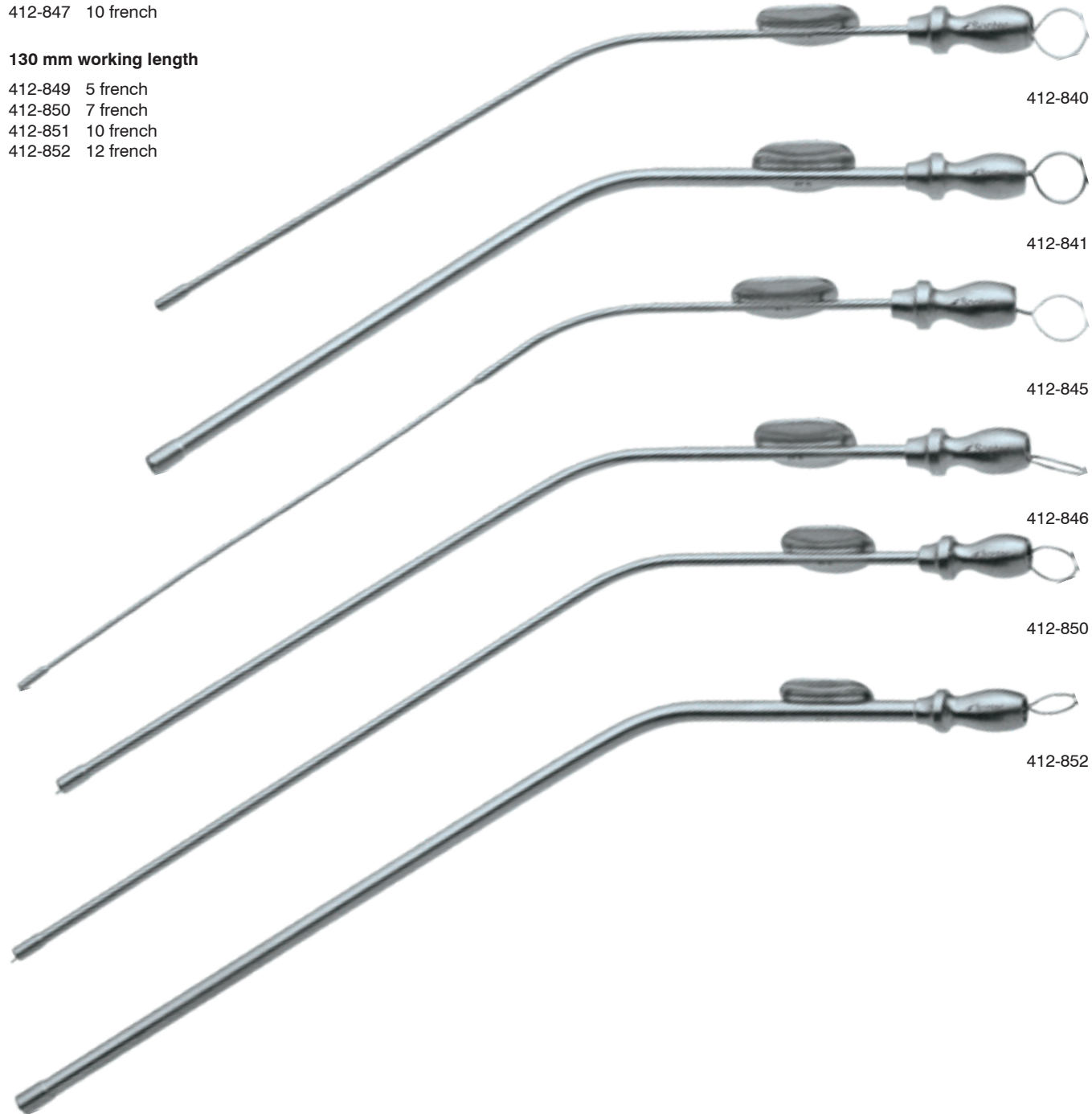

**Sontec Neuro Suction**

**tapered tubing for increased flow / short shaft / 3 hole finger control / 2 3/4" (7 cm)**

- 412-853 1.2mm tip
- 412-854 2mm tip
- 412-855 2.5mm tip

**Medium shaft / 3 hole finger control / 4" (10 cm)**

- 412-856 1.2mm tip
- 412-857 2mm tip
- 412-858 2.5mm tip

**Long shaft / 3 hole finger control / 5 1/2" (14 cm)**

- 412-859 1.2mm tip
- 412-860 2mm tip
- 412-861 2.5mm tip

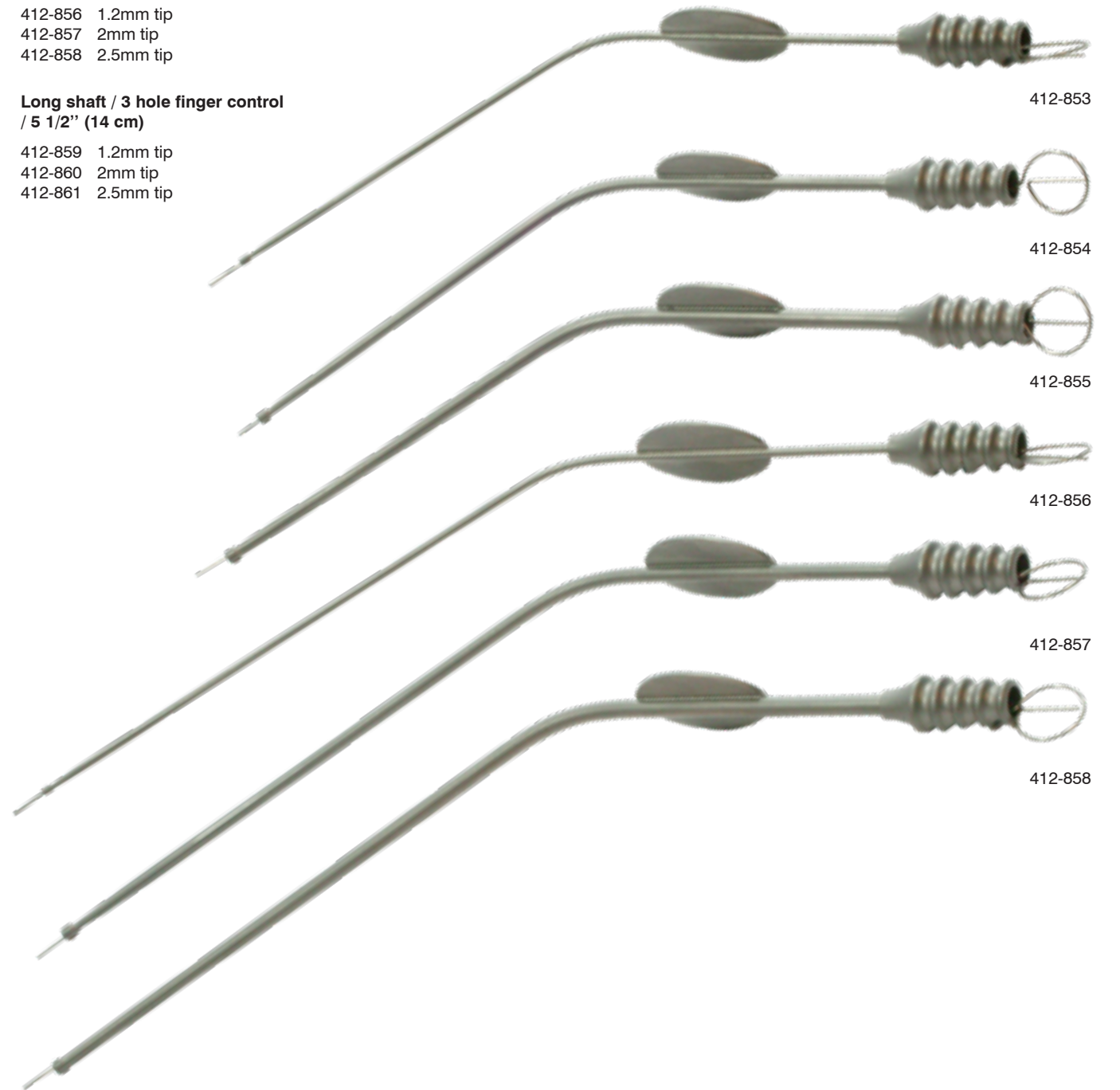

**Schmid Suction Tips**

6" (15 cm)

- 412-736-1
- 412-736-2
- 412-736-3
- 412-736-4



**Suction Irrigation Tube**

5 mm / with stylet / 8" (20 cm)

- 412-830 4 french x 8 french



**House-Baron Suction**

With multi port / 5" (12.5 cm)

- 412-728 5 french
- 412-728B 7 french

7" (18 cm)

- 412-729 5 french
- 412-729B 7 french

11" (28 cm)

- 412-727A 5 french
- 412-727B 7 french



**House Irrigator/Suction**

With thumb plate and cutoff (bypass hole) / 70mm working length / 4 1/2" (11.5 cm)

- 412-715A 2.5 french x 4 french
- 412-715C 4 french x 5 french

85mm working length / 5" (13 cm)

- 412-715 2 french x 2.5 french

95mm working length / 5 1/2" (14cm)

- 412-715B 2.5 french x 4 french
- 412-7151B 3 french x 4 french
- 412-715D 4 french x 5 french
- 412-716 5 french x 7 french
- 412-716A 6 french x 8 french
- 412-717 7 french x 10 french
- 412-718 8 french x 12 french
- 412-719 12 french x 14 french



**Buie Suction Tube**

With finger valve / 16" (40.5 cm)

- 508-523 15 french



**Andrews Pynchon Suction**

**Stainless / 9 1/2" (24 cm)**

- 180-432 3.0 mm
- 180-433 4.2 mm
- 180-436 5.0 mm standard

**Chrome handle / standard 5 mm / 9 1/2" (24 cm)**

180-439



**Anthony Suction**

**4 mm tip / 10" (25.5 cm)**

180-440



**Braun-Ralph Suction**

**5mm suction tube / 70° angle  
with 7 mm Ø 40 mm long fluted  
tip / 10" (25.5 cm)**

2700-309



**Yankauer Suction**

**Stainless Steel / 11 3/4" (30 cm)**

180-448



**With universal fiber optic light guide /  
stainless steel / 11 1/4" (28.5 cm)**

180-449 2mm



**Stainless steel / 16" (41 cm)**

180-451 2mm



**Heartline Ross Sump Sucker**

**Swivel head**

2700-390 adult 4.8mm x 7.5mm O.D. x 43mm length  
 2700-392 child 4.8mm x 6.5mm O.D. x 32.5mm length  
 2700-394 infant 3.2mm x 5mm O.D. x 22.5mm length



**Baby Poole Suction**

**Curved / 17 french / 8" (20.3 cm)**

180-420



**Poole Suction**

**8 3/4" (22 cm)**

180-424 cvd 23 french  
 180-422 str 30 french



**Adson Suction**

**Curved tip**

412-720 12 french 5" (12.5 cm)  
 412-724 12 french 8" (20 cm)



**Killian (Von Eicken) Suction**

**Curved / 6" (15 cm)**

412-815 4 mm end short curve  
 412-810 4 mm end full long curve  
 412-805 3 mm end short curve  
 412-800 3 mm end long curve

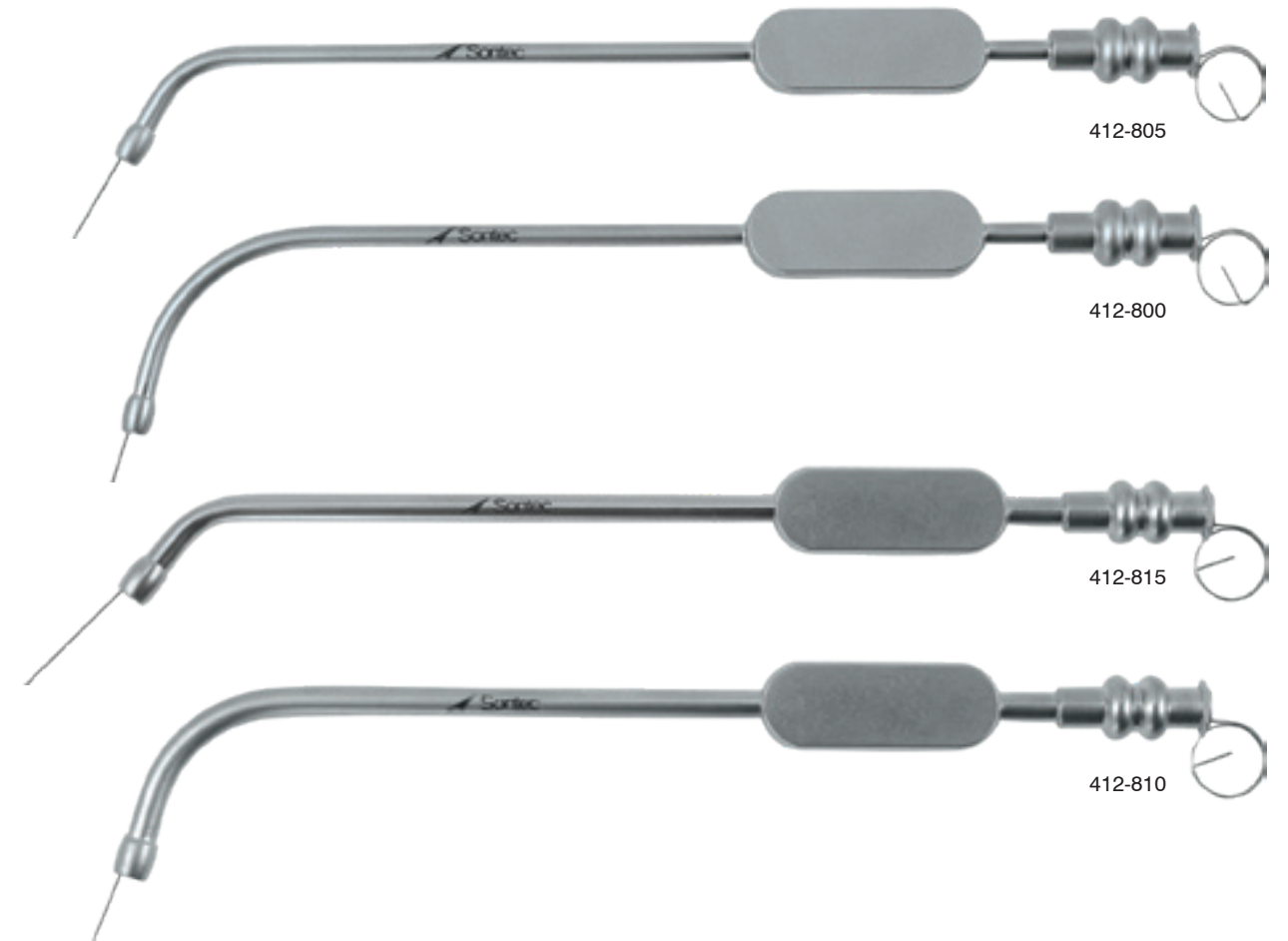

**Sontec Perfusion Cannula Suction**

**For pediatric Use**

412-740 style #1  
 412-741 style #2

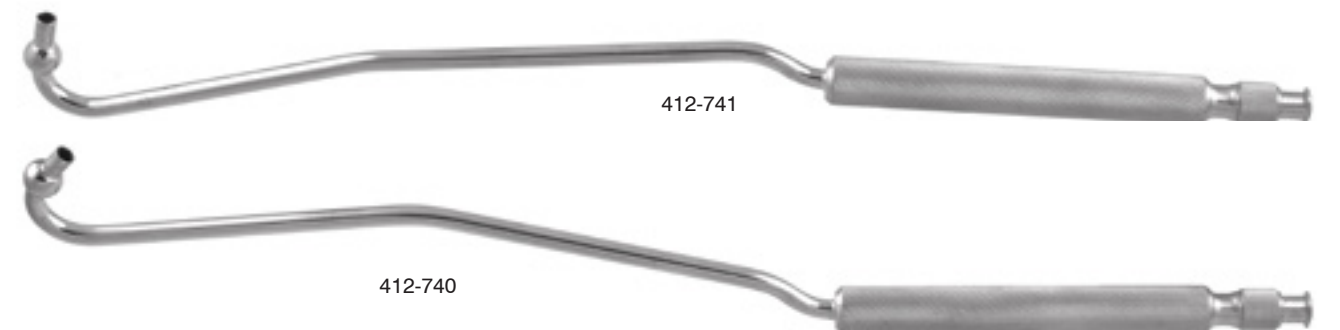



 Sontec Instruments®  
BANDAGE & SUTURE SCISSORS

**Sontec® Scissors are simply unmatched in design, function, quality and variety. Sontec Scissors are offered in any model blade, shape or size in all of our model options listed below:**

**Classic Model**

- Combining extremely high quality with unmatched value
- Satin or high gloss finish

**Tungsten Carbide - TC inserts**

**Gold Rings**

- diamond-ground tungsten-carbide inserts
- extremely sharp
- Blade hardness greatly increases scissor life
- available with or without serrations

**Powercut blades® - PC gold**

**Gold Rings with Stripes on Shanks**

- sharpest cutting edge available
- serrated unless otherwise requested
- Finished in Sontec's Trademarked PC Gold design
- All the attributes of Sontec PC Black scissors

**Powercut blades® - PC black**

**Black Rings**

- All the attributes of Sontec PC Gold
- Beautifully ornamented in black chrome

**Tungsten Carbide / Power Cut - TC/PC:**

**Gold Ring / Black Ring**

- Serrated unless otherwise requested
- a combination of the best options
- HANDLE: one gold ring, one black ring
- This premier line encompasses TC long life, PC power, and Sontec Quality

**Ceramic Coated Scissors:**

**Black Ring**

- offered to protect your investment even further by putting the instrument into an extremely hard coating which adds more life to your Sontec Scissors
- Offered in either PC or TC/PC models



**Spencer Suture Scissors**

**3 1/2" (9 cm)**

- 1100-295 straight
- 1100-296 curved

**4 1/2" (11.5 cm)**

- 1100-298 straight
- 1100-298D straight delicate
- 1100-297 angled north bent

**Curved / 4 3/4" (12 cm)**

- 1100-299

**6" (15 cm)**

- 1100-302 straight
- 1100-301 angled north bent

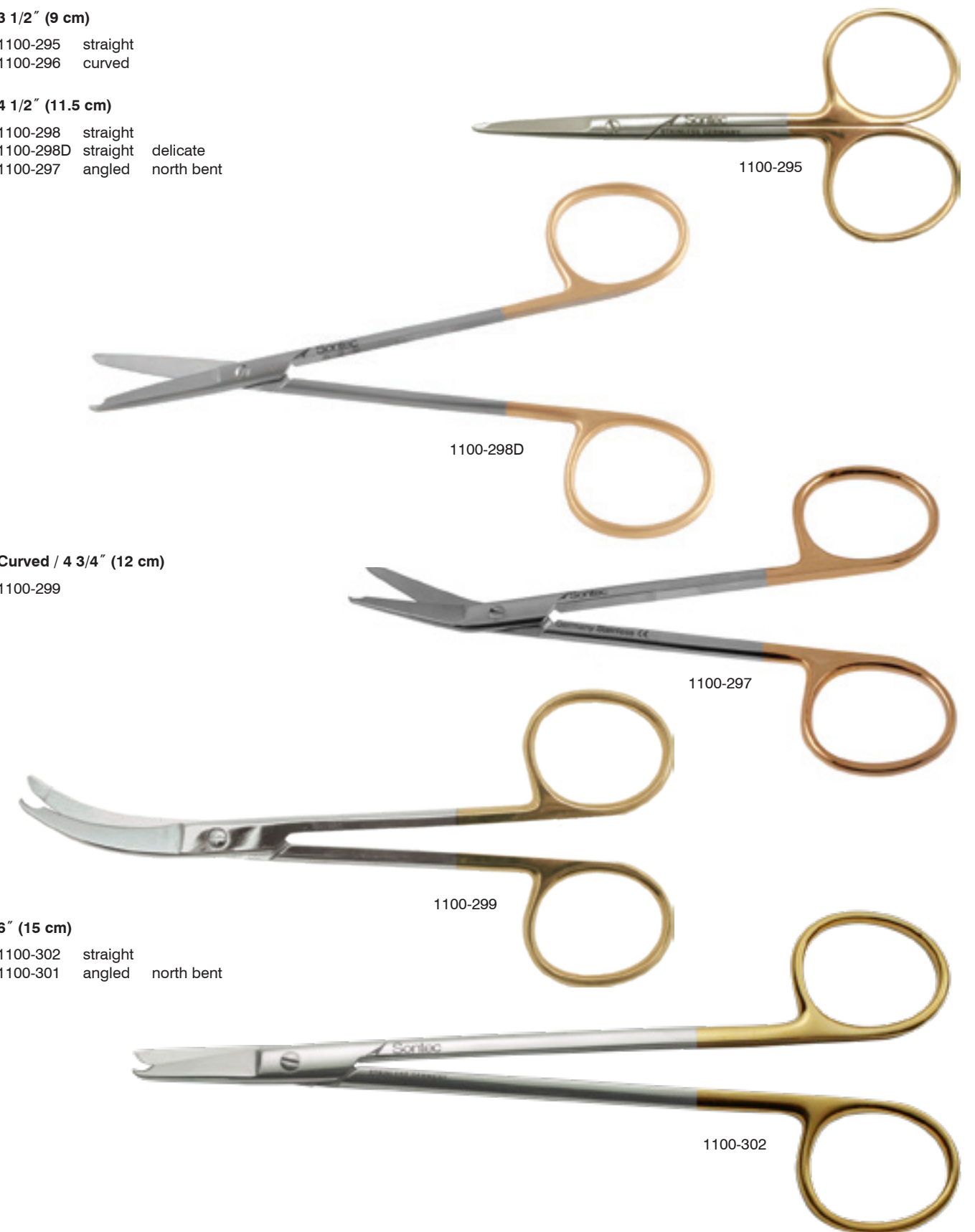

**Wire Suture Scissors**

**Serrated / 4 1/4" (10.5 cm)**

- 1100-304 straight
- 1100-306 curved

**Curved / 4 3/4" (12 cm)**

- 1100-305

**Angled / 5" (12.5 cm)**

- 1100-308 serrated
- 1100-310 TC serrated



1100-304



1100-305



1100-310

**Reeh Stitch Scissors**

**Sharp / ribbon handle / 4" (10 cm)**

- 13-8325 curved

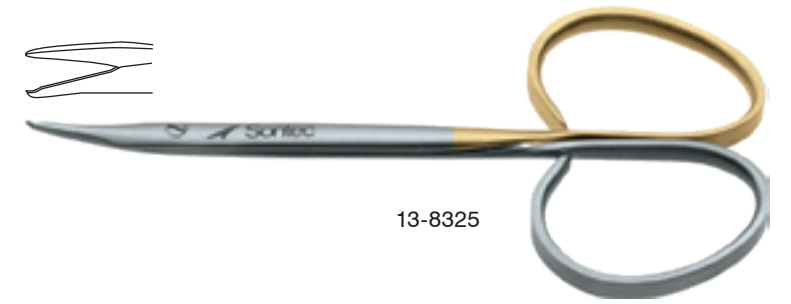

13-8325

**Northbent Stitch Scissors**

**Curved sideways / 4 3/4" (12 cm)**

- 134-296



134-296

**Heath Suture Scissors**

Serrated / 6 1/8" (15.5 cm)  
134-288



**Smith Wire Cutting Scissors**

1 blade serrated / straight / notched tip / 4 3/4" (12.1 cm)  
1100-307



**Lister Bandage Scissors**

**Classic**

- 110-340 3 1/2" (9 cm)
- 110-344 4 3/4" (12.1 cm)
- 1100-204 5 1/2" (14 cm)
- 1100-204L 5 1/2" (14 cm) left
- 110-345 6 1/4" (15.9 cm)
- 1100-206 7 1/4" (18.5 cm)
- 1100-205 8" (20 cm)
- 110-351 8" (20 cm) large double ring



**PC gold**

- 1200-202 3 1/2" (9 cm)
- 1200-203 4 3/4" (12 cm)
- 1200-204 5 1/2" (14 cm)
- 1200-204L 5 1/2" (14 cm) left
- 1200-205 5 1/2" (14 cm) large double ring
- 110-347 6 1/4" (15.9 cm)
- 1200-206 7 1/4" (18.5 cm)
- 1200-210 8" (20 cm) large double ring
- 1200-208 8" (20 cm)

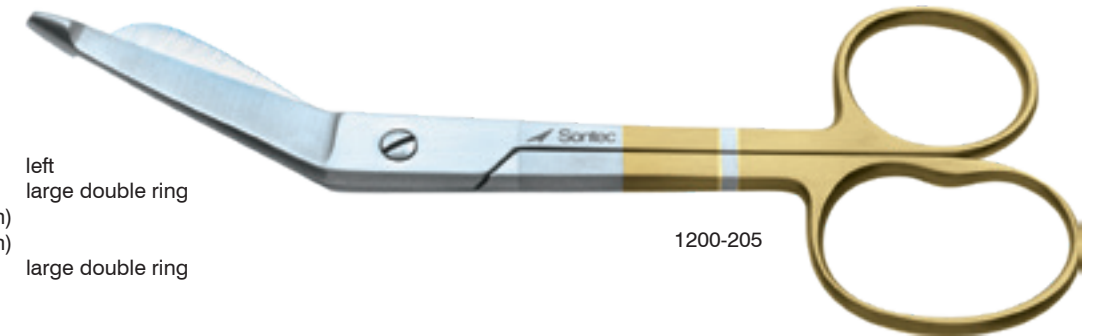

**TC/PC**

- 1200-482 7 1/4" (19 cm)
- 1200-485 5 1/2" (14 cm)
- 1200-488 8" (20.3 cm)



**PC Black**

- 1200-686 5 1/2" (14 cm)
- 1200-688 7 1/4" (18.5 cm)
- 1200-689 8" (20.3 cm) large double ring



**Knowles Bandage Scissors**

Superior cutting ability / straight / 5 1/2" (14 cm)

- 1100-207 classic
- 1200-192 PC gold

Superior cutting ability / angled / 5 1/2" (14 cm)

- 1100-208 serrated
- 1200-190 PC gold
- 1200-690 PC black
- 1200-480 TC/PC



1200-690

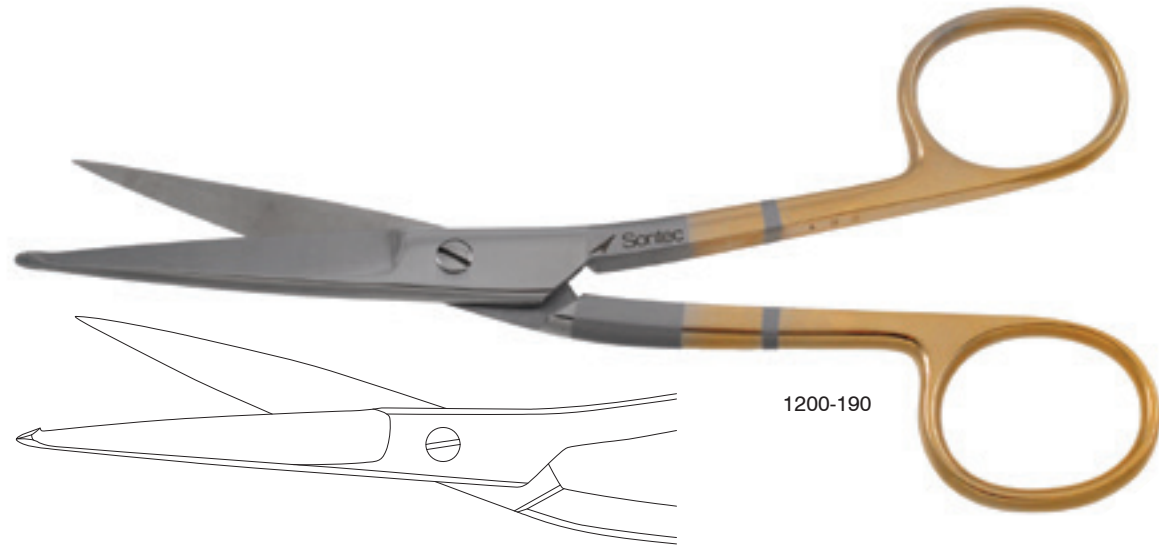

1200-190

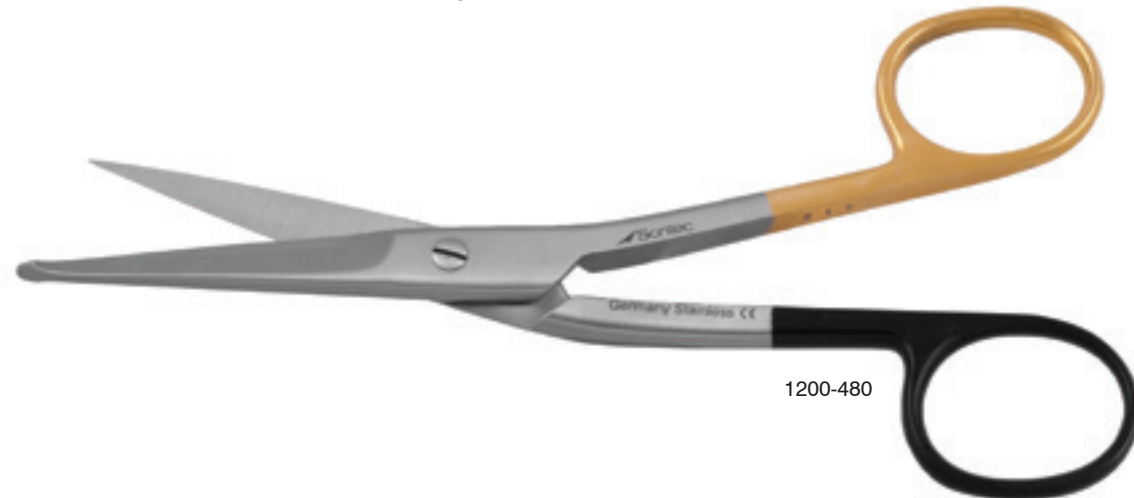

1200-480

**Nemetz Bandage Scissors**

Curved / 3 1/2" (14 cm)

1103-873

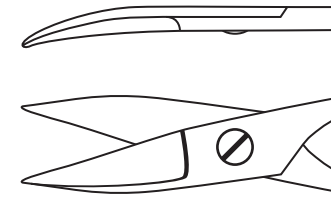

1103-873

**Harris Micro Bandage Scissors**

One serrated blade / ball tip / 4 1/2" (11.5 cm)

- 1103-870 straight
- 1103-871 angled

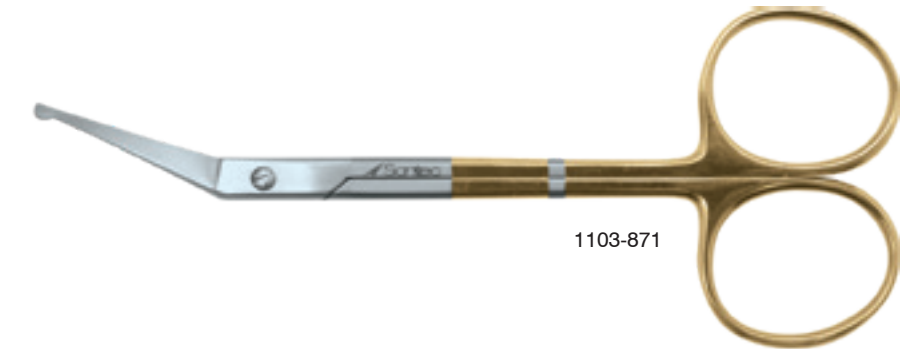

1103-871

**Taylor Dura Scissors**

Beaded tip / PC Gold / 6 1/2" (16.5 cm)

\*Can also be used as a bandage scissors

1200-195

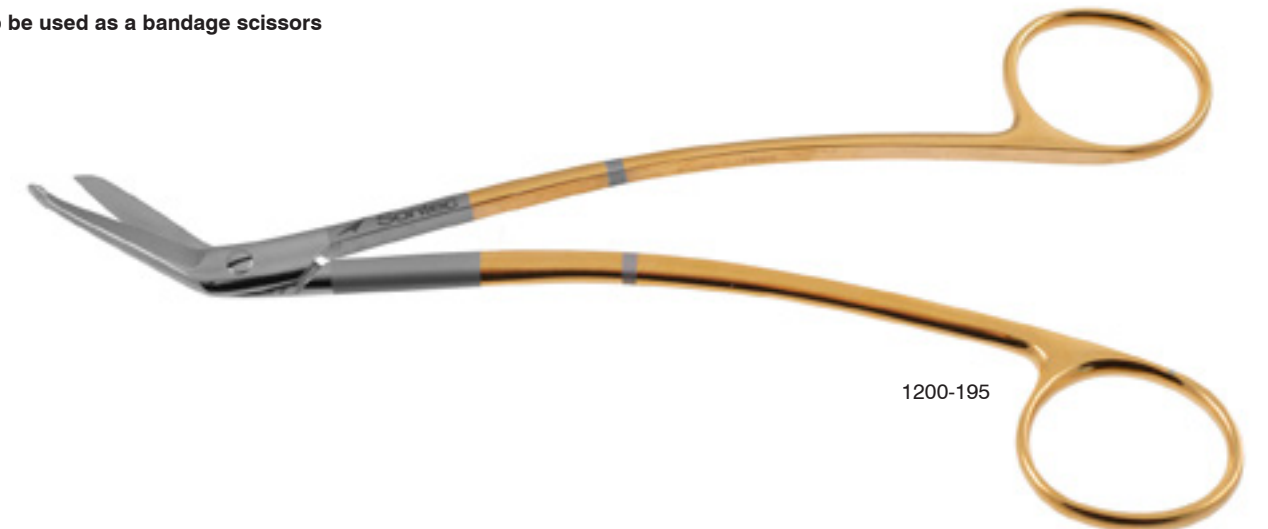

1200-195

**Hercules Bandage/ Plaster Scissors**

One serrated blade / 8" (19.5 cm)  
240-620



**Commander Utility Shears**

One serrated blade / with wire cutter / 8" (19.5 cm)  
240-625



**Heavy Synthetic Cast Shears**

Blunt tip / 9" (22.9 cm)  
240-613  
240-614 TC

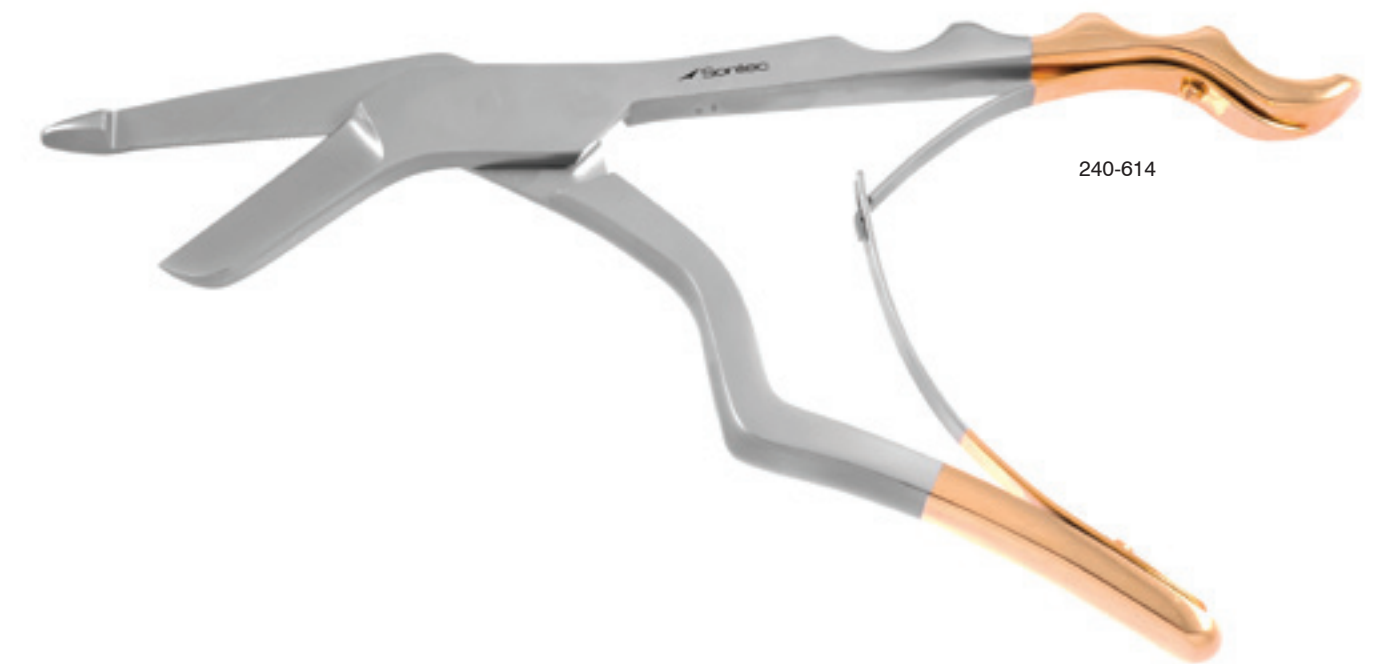

**Utility Scissors**

Autoclavable - serrated / fluoride coated blade / 8 1/4" (21 cm)

- 1100-209-Green green handle
- 1100-209-Pink hot pink handle
- 1100-209-Purple lavender handle
- 1100-209-Blue bright blue handle
- 1100-209-Black black handle



**Nurse's Scissors**

Fluoride coated blades- help prevent adhesive from sticking to the blades surface / 5 1/2" (14 cm)

- 1100-201P pink
- 1100-201B blue





 Sontec Instruments®

MAYO SCISSORS

**Sontec® Scissors are simply unmatched in design, function, quality and variety. Sontec Scissors are offered in any model blade, shape or size in all of our model options listed below:**

**Classic Model**

- Combining extremely high quality with unmatched value
- Satin or high gloss finish

**Tungsten Carbide - TC inserts**

**Gold Rings**

- diamond-ground tungsten-carbide inserts
- extremely sharp
- Blade hardness greatly increases scissor life
- available with or without serrations

**Powercut blades® - PC gold**

**Gold Rings with Stripes on Shanks**

- sharpest cutting edge available
- serrated unless otherwise requested
- Finished in Sontec's Trademarked PC Gold design
- All the attributes of Sontec PC Black scissors

**Powercut blades® - PC black**

**Black Rings**

- All the attributes of Sontec PC Gold
- Beautifully ornamented in black chrome

**Tungsten Carbide / Power Cut - TC/PC:**

**Gold Ring / Black Ring**

- Serrated unless otherwise requested
- a combination of the best options
- HANDLE: one gold ring, one black ring
- This premier line encompasses TC long life, PC power, and Sontec Quality

**Ceramic Coated Scissors:**

**Black Ring**

- offered to protect your investment even further by putting the instrument into an extremely hard coating which adds more life to your Sontec Scissors
- Offered in either PC or TC/PC models



**Mayo-Stille Classic, Tungsten Carbide, Power Cut Gold, Power Cut Black®, TC/PC Power Cut®, Ceramic Coated Scissors**

**Round blades / straight / 5 1/2" (14 cm)**

- 110-268 classic
- 1100-272R TC
- 2400-191 PC gold

**Round blades / curved / 5 1/2" (14 cm)**

- 110-269 classic
- 1100-278R TC
- 2400-192 PC gold

**Round blades / TC/PC / 5 3/4" (14.25 cm)**

- 1200-542 straight
- 1200-547 curved



1200-542

**Round blades / PC gold / 6" (15 cm)**

- 2400-193 straight
- 2400-194 curved

**Round blades / PC black / 6" (15 cm)**

- 2400-706 straight
- 2400-708 curved

**Round blades / straight / 6 3/4" (17 cm)**

- 110-271 classic
- 1100-274R TC
- 2400-195 PC gold
- 2400-704 PC black
- 1200-550 TC/PC

**Round blades / curved / 6 3/4" (17 cm)**

- 110-272 classic
- 1100-280R TC
- 2400-197 PC gold
- 2400-702 PC black
- 1200-551 TC/PC

**Round blades / PC Gold / 7 1/2" (23 cm)**

- 2400-198 straight
- 2400-199 curved

**Round blades / PC Black / 7 1/2" (23 cm)**

- 2400-701 curved
- 2400-703 straight

**Round blades / straight / 8 1/4" (21 cm)**

- 2400-229 TC
- 2400-231 PC gold

**Round blades / curved / 8 1/4" (21 cm)**

- 2400-230 TC
- 2400-232 PC gold

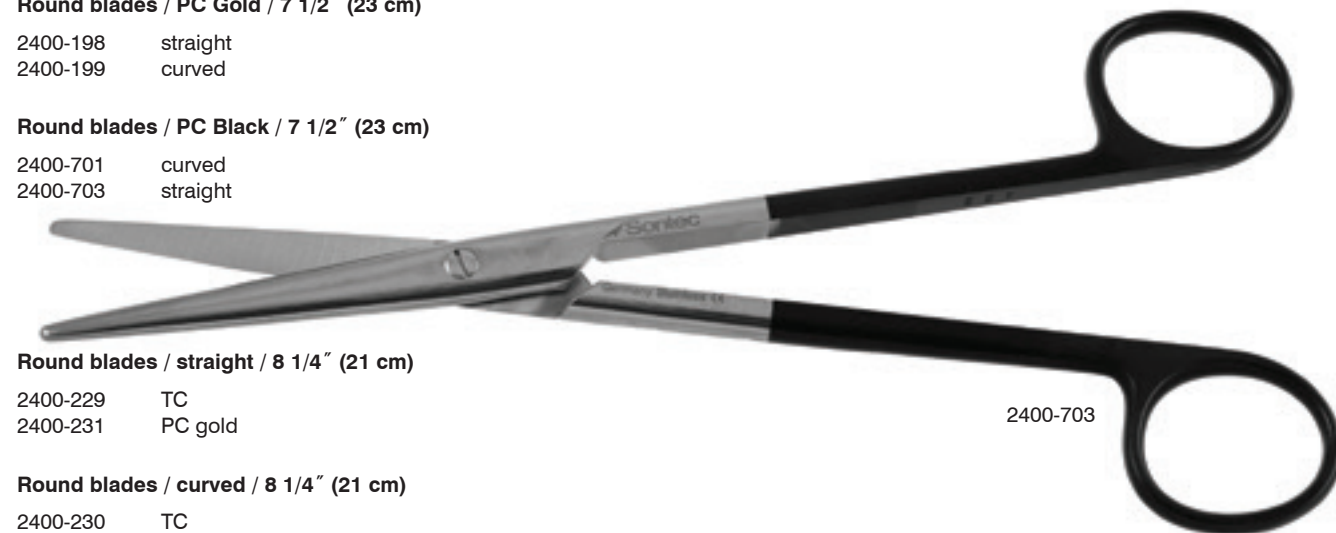

2400-703

**Mayo Classic, Tungsten Carbide, Power Cut Gold, Power Cut Black®, TC/PC Power Cut®, Ceramitec Coated Scissors**

**Classic beveled blades / straight / 6 3/4" (17 cm)**

- 1100-250 classic
- 1100-256L left-handed
- 1100-274 TC
- 1200-250 PC gold
- 1200-727 PC black
- 1200-540 TC/PC



straight

**Classic beveled blades / curved / 6 3/4" (17 cm)**

- 1100-256 classic
- 1100-280 TC
- 1200-256 PC gold
- 1200-730 PC black
- 1200-545 TC/PC



curved

**Classic beveled blades / PC / 7 1/2" (23 cm)**

- 2400-206 straight
- 2400-207 curved

**Classic beveled blades / TC / 8" (20 cm)**

- 2400-187 straight
- 2400-188 curved

**Classic beveled blades / PC / round handle / 8 1/4" (21 cm)**

- 2400-231 straight
- 2400-232 curved

**Classic beveled blades / TC / 9" (23 cm)**

- 2400-189 straight
- 2400-190 curved



1200-250

**Mayo-Lexer Fino Classic Tungsten Carbide Power Cut® Gold Scissors**

**Very delicate / round blades / TC / 6 1/2" (16.5 cm)**

- 2400-222 straight
- 2400-223 curved

**Very delicate / round blades / PC gold / 6 1/2" (16.5 cm)**

- 2400-226 straight
- 2400-227 curved



2400-222

**Mayo-Lexer, Classic, Power Cut Gold, Power Cut Black®, TC/PC Power Cut®, Scissors**

Round more delicate finer shaped blades / straight / 6 1/2" (16.5 cm)

- 110-280 classic
- 1200-543 TC/PC
- 1200-733 PC black
- 2400-227 PC gold

Round more delicate finer shaped blades / curved / 6 1/2" (16.5 cm)

- 110-281 classic
- 1200-548 TC/PC
- 1200-735 PC black
- 2400-226 PC gold

TC / curved / 8 1/4" (21 cm)

- 2400-225



1200-548

**Mayo-Carroll Scissors**

Extra heavy design / TC / 9" (23 cm)

- 1100-276 straight
- 1100-282 curved



1100-282

**Mayo-Harrington Scissors**

Classic beveled blades / straight / 8" (20 cm)

- 2400-214 TC
- 2400-208 PC gold
- 2400-920 PC black

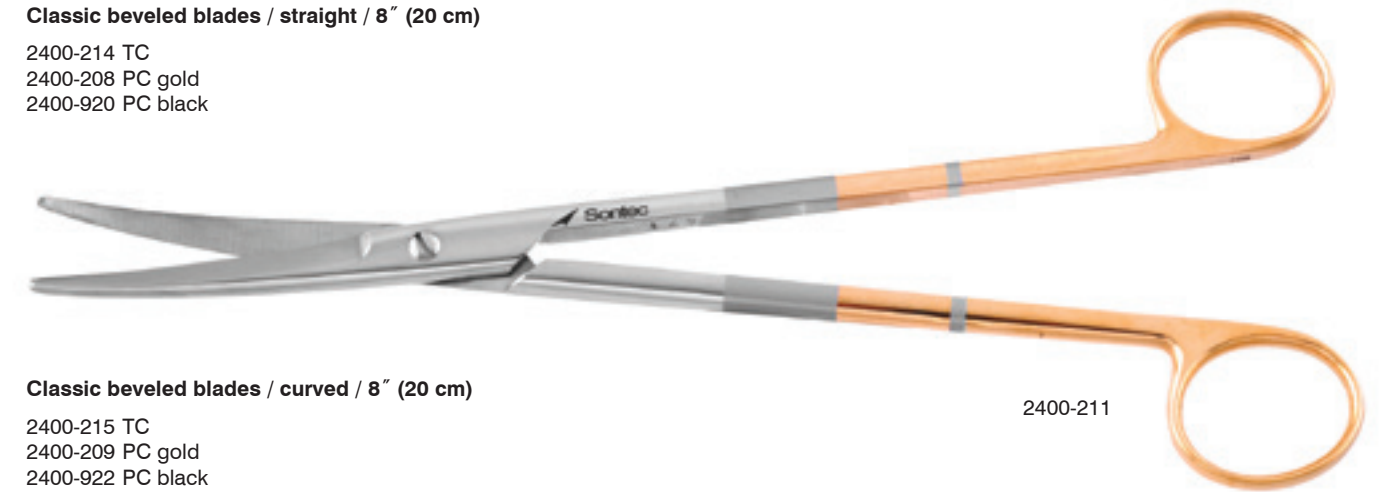

2400-211

Classic beveled blades / curved / 8" (20 cm)

- 2400-215 TC
- 2400-209 PC gold
- 2400-922 PC black

Classic beveled blades / straight / 9" (23 cm)

- 2400-216 TC
- 2400-210 PC gold
- 2400-924 PC black

Classic beveled blades / curved / 9" (23 cm)

- 2400-217 TC
- 2400-211 PC gold
- 2400-926 PC black



2400-214

Classic beveled blades / curved / 11" (30 cm)

- 2400-218 TC
- 2400-213 PC gold
- 2400-928 PC black

Classic beveled blades / curved / PC Gold / 12" (30.5 cm)

- 1200-259

Classic beveled blades / curved / TC / 16" (40.5 cm)

- 2400-212



 Sontec Instruments®

METZENBAUM SCISSORS

**Metzenbaum Classic Model Scissors**

**Classic model / 4 1/2" (11.5 cm)**

- 1100-233 straight
- 1100-241 curved

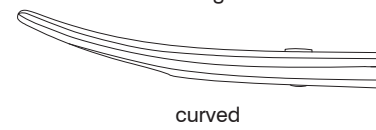
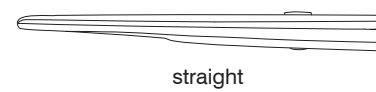

**Classic model / 5 3/4" (14.5 cm)**

- 1100-236 straight
- 1100-236L straight left handed
- 1100-242 curved
- 2400-346 curved extra-light
- 2400-347 curved extra-light tenotomy tip

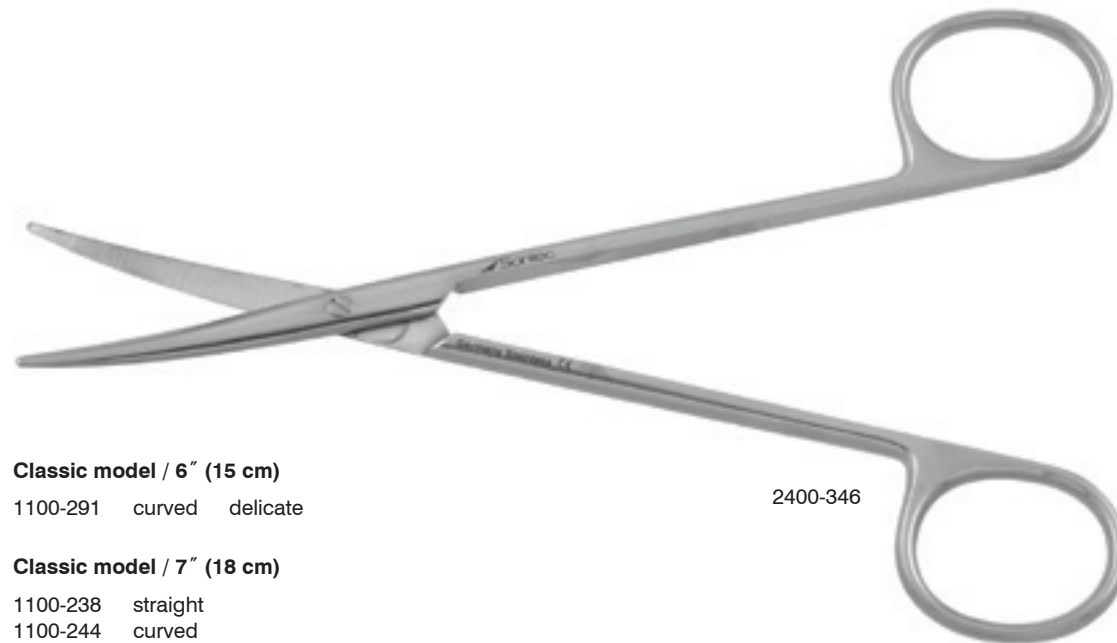
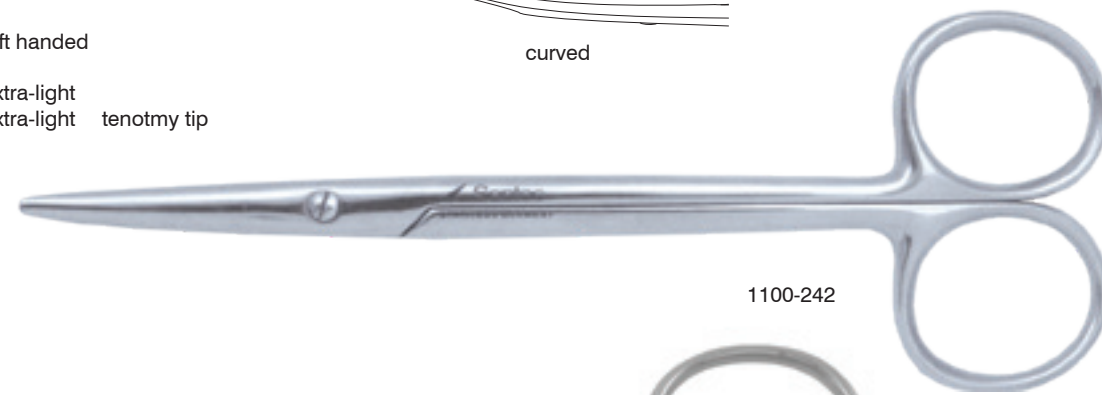

**Classic model / 6" (15 cm)**

- 1100-291 curved delicate

**Classic model / 7" (18 cm)**

- 1100-238 straight
- 1100-244 curved
- 2400-349 curved extra-light



2400-349

**Metzenbaum Power Cut® Gold Scissors**

**Power Cut Gold (PC Gold) / 4 3/4" (12 cm)**

- 1200-326 straight
- 1200-328 curved

**Power Cut Gold (PC Gold) / 5" (12.5 cm)**

- 2400-286 straight
- 2400-287 curved

**Power Cut Gold (PC Gold) / straight / 5 3/4" (15 cm)**

- 1200-330
- 1200-334 delicate

**Power Cut Gold (PC Gold) / curved / 5 3/4" (15 cm)**

- 1200-332
- 1200-335 delicate
- 1200-347 ergonomic spread handle

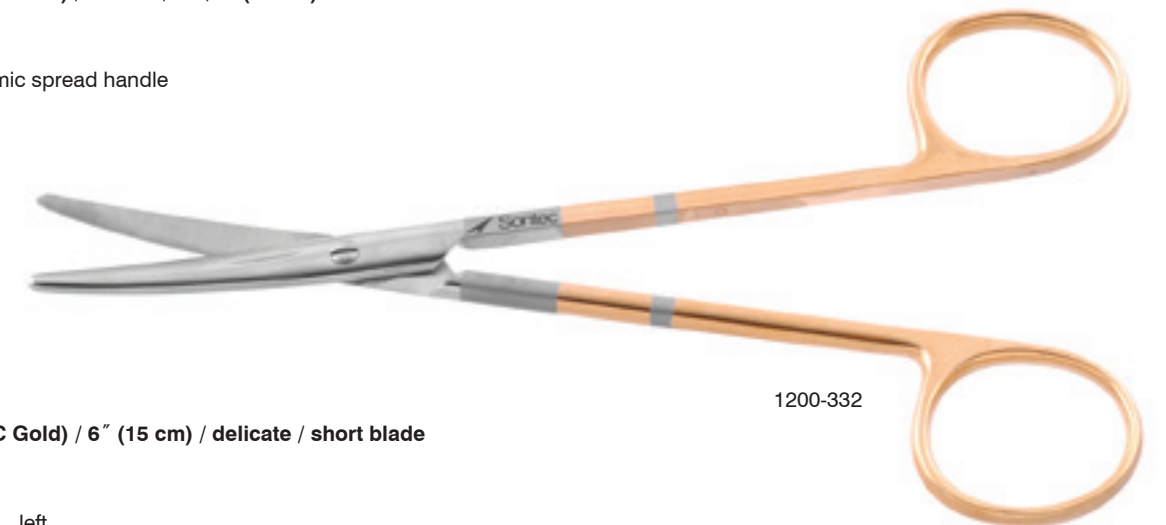

**Power Cut Gold (PC Gold) / 6" (15 cm) / delicate / short blade**

- 2400-314 straight
- 2400-315 curved
- 1200-330L straight left

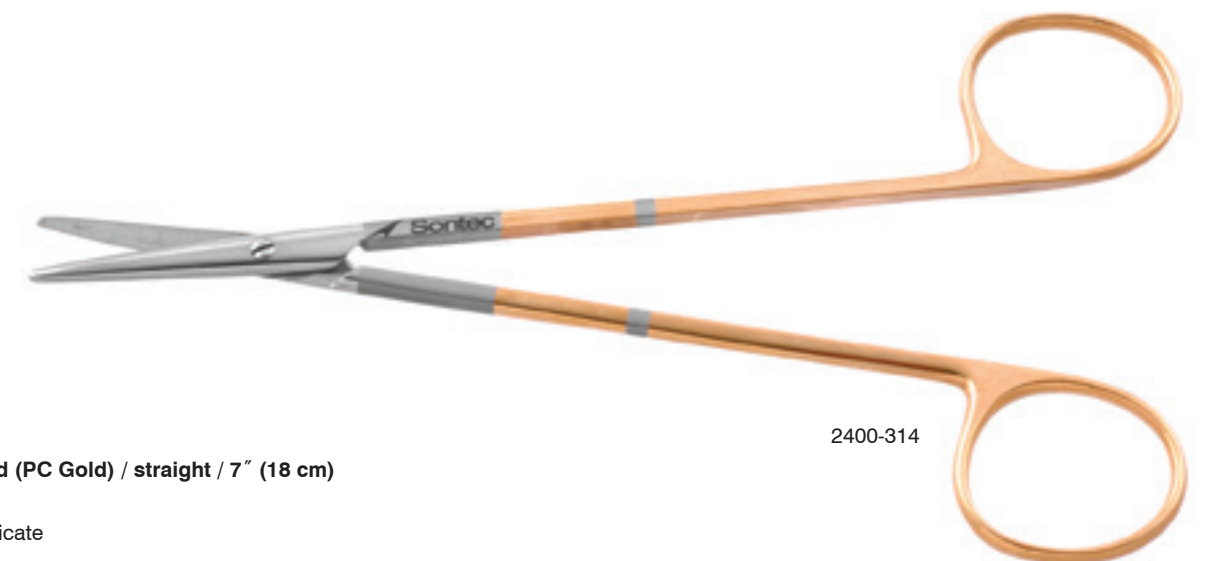

**Power Cut Gold (PC Gold) / straight / 7" (18 cm)**

- 1200-340
- 2400-316 delicate

**Metzenbaum Power Cut® Black Scissors**

**Power Cut Black (PC Black) / 4 1/2" (11.5 cm)**

- 1200-775M straight baby
- 1200-776M curved baby

**Power Cut Black (PC Black) / 5" (13 cm)**

- 1200-780 straight
- 1200-782 curved
- 1200-750 straight tenotomy tip
- 1200-752 curved tenotomy tip

**Power Cut Black (PC Black) / extra delicate / 5 1/4" (13.5 cm)**

- 2400-812A straight
- 2400-813A curved

**Power Cut Black (PC Black) / extra delicate / 5 5/8" (14 cm)**

- 2400-814A straight
- 2400-815A curved

**Power Cut Black (PC Black) / tenotomy tip / 5 3/4" (14.5 cm)**

- 1200-760 straight
- 1200-762 curved

**Power Cut Black (PC Black) / 5 3/4" (14.5 cm)**

- 1200-784 straight
- 1200-786 curved
- 1200-783 straight delicate
- 1200-787 curved delicate



1200-775M

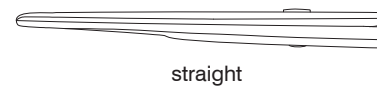

straight



curved

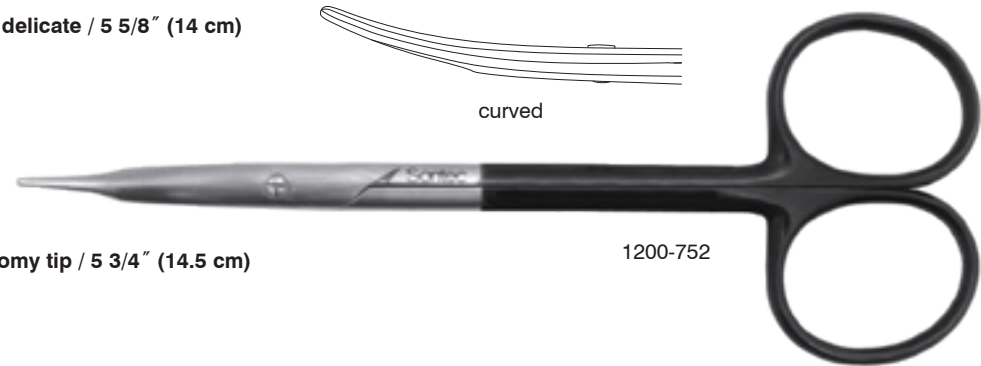

1200-752



2400-815A



1200-760



delicate blade

**Metzenbaum Power Cut® Black Scissors**

**Power Cut Black (PC Black) / 7" (18 cm)**

- 1200-788 straight
- 1200-790 curved
- 2400-797 curved 2.5mm tip



1200-788

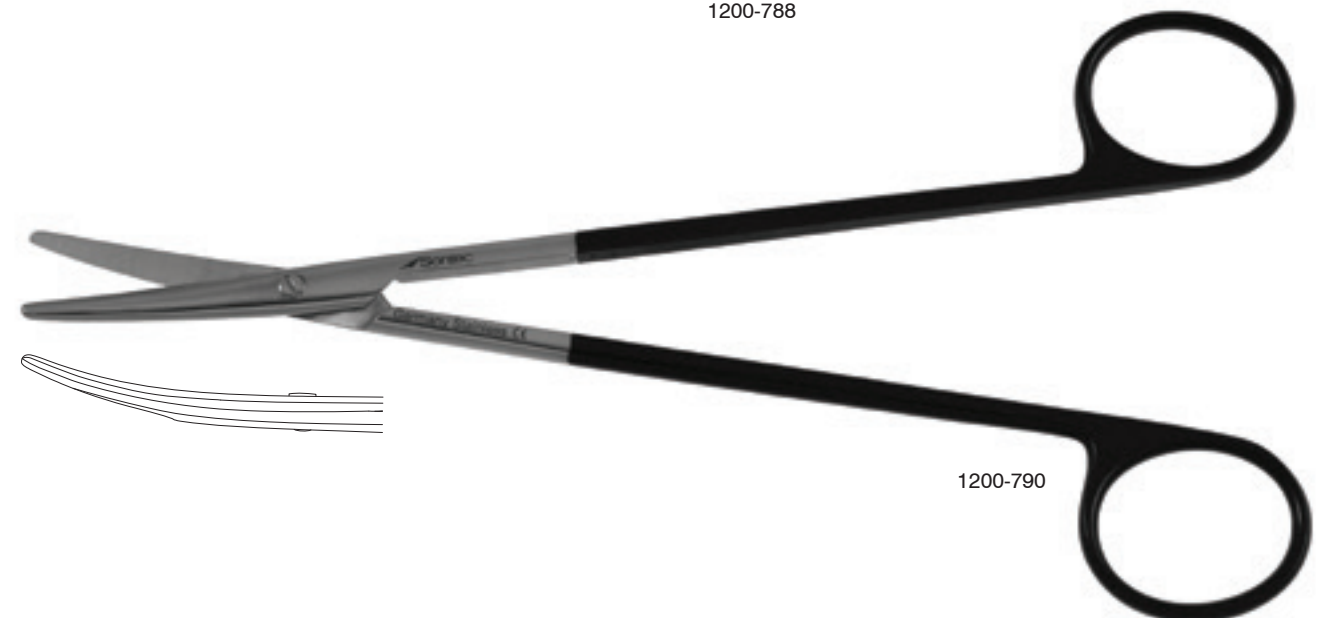

1200-790

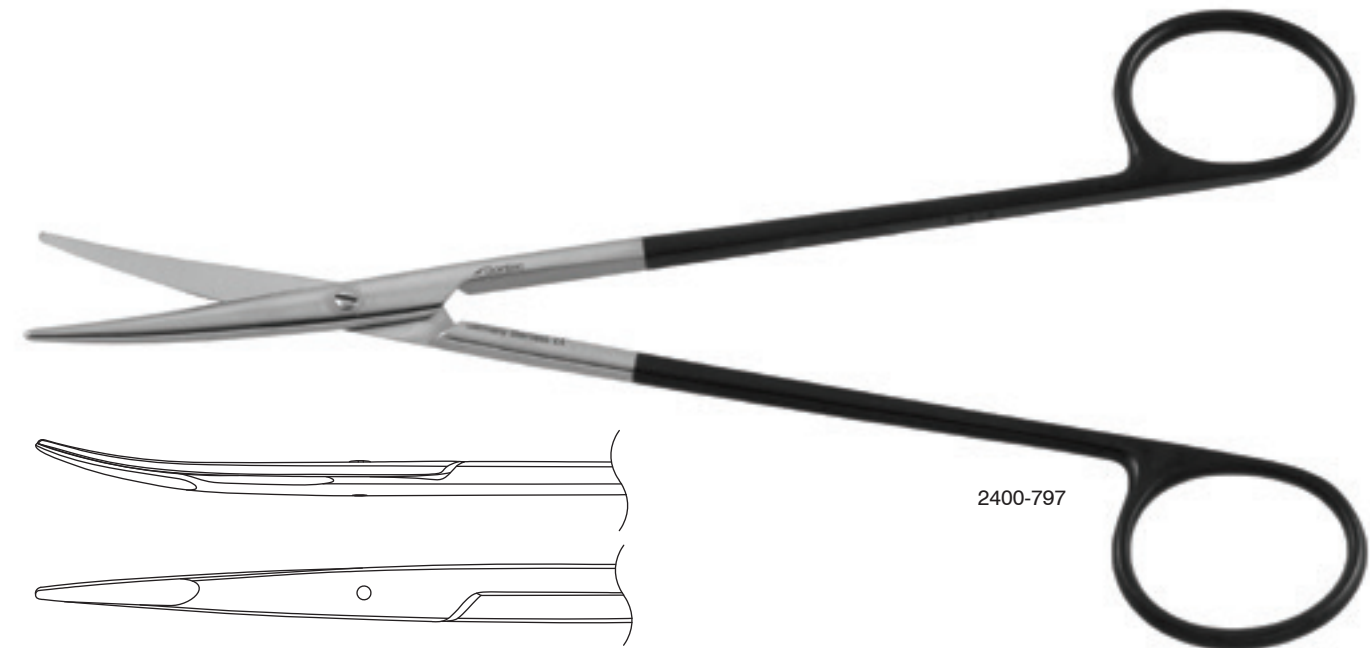

2400-797

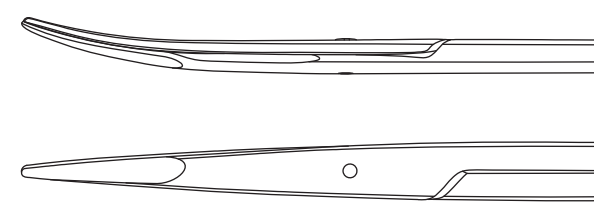

**Metzenbaum Ceramitec Power Cut® Scissors**

Special / ceramic coated scissors / with Power Cut blades / black with gold screw / curved

1200-911		5 3/4" (15 cm)
1200-912		5 3/4" (15 cm)
1200-915		7" (18 cm)
1200-916	delicate	7" (18 cm)



1200-911

\* Titanium Nitrate Coating is a very hard coating that keeps scissors sharper longer, reduces friction and adds a layer of corrosion protection



1200-915

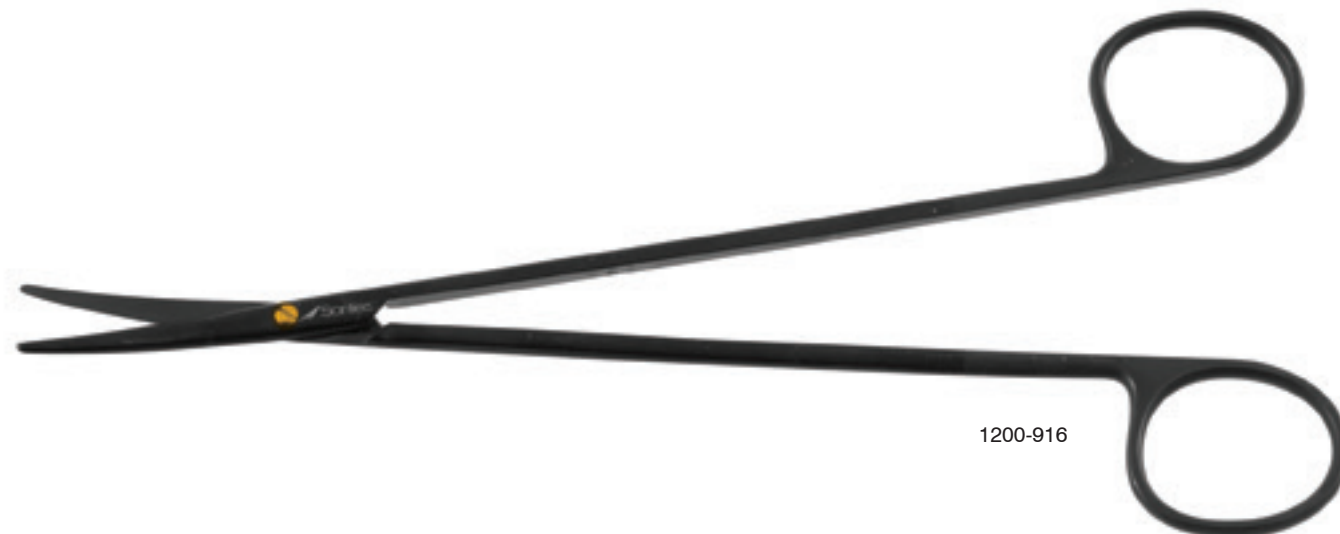

1200-916

**Metzenbaum Tungsten Carbide Power Cut® Gold/Black Scissors**

Strabismus / tungsten Carbide /Power Cut (TC/PC) / 4 1/2" (11.5 cm)

1200-500	straight
1200-501	curved

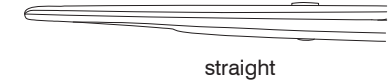

straight

Tungsten Carbide /Power Cut (TC/PC) / Serrated / 5 3/4" (14.5 cm)

1200-505	straight	
1200-510	curved	
1200-507	straight	delicate
1200-512	curved	delicate
1200-514	curved	ergonomic spread handle

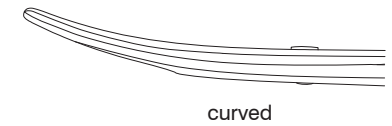

curved



1200-505



1200-514

Tungsten Carbide /Power Cut (TC/PC) / 7" (18 cm)

1200-515	straight	
1200-520	curved	
1200-526	curved	ergonomic spread handle
1200-526S	curved	ergonomic spread handle sharp tips
2400-247	curved	delicate

Tungsten Carbide /Power Cut (TC/PC) / 8" (20.5 cm)

1200-530	straight	
1200-529	curved	
1200-531	curved	ergonomic spread handle
2400-248	curved	delicate

Tungsten Carbide /Power Cut (TC/PC) / 9" (23 cm)

1200-535	straight	
1200-536	curved	
2400-259	curved	delicate

Tungsten Carbide /Power Cut (TC/PC) / 10" (25.5 cm)

1200-537	straight	
1200-538	curved	
2400-281	curved	delicate



1200-529



 Sontec Instruments®

ENT Plastic SCISSORS

**Operating Classic, Tungsten Carbide, Power Cut Gold, Power Cut Black®, TC/PC Power Cut® Scissors**

**Blunt-blunt / straight / 5 1/2" (14 cm)**

- 1100-212 classic
- 1100-212L classic left
- 1100-260 TC
- 1200-212 PC gold
- 1200-712 PC black



blunt-blunt



sharp-blunt

**Blunt-blunt / curved / 5 1/2" (14 cm)**

- 1100-224 classic
- 1100-262 TC
- 1200-224 PC gold
- 1200-713 PC black



1200-229

**Sharp-blunt / straight / 5 1/2" (14 cm)**

- 1100-214 classic
- 1100-214L classic left
- 1100-265 TC
- 1200-214 PC gold
- 1200-229 TC/PC
- 1200-714 PC black



1100-214L

**Sharp-blunt / curved / 5 1/2" (14 cm)**

- 1100-226 classic
- 1100-264 TC
- 1200-226 PC gold
- 1200-715 PC black



1200-714

**Operating Classic, Tungsten Carbide, Power Cut Gold, Power Cut Black®, TC/PC Power Cut® Scissors**

**Sharp-sharp / straight / 5 1/2" (14 cm)**

- 1100-216 classic
- 1100-268 TC
- 1200-216 PC gold
- 1200-231 TC/PC
- 1200-716 PC black



blunt-blunt



sharp-blunt

**Sharp-sharp / curved / 5 1/2" (14 cm)**

- 1100-228 classic
- 1100-270 TC
- 1200-228 PC gold
- 1200-717 PC black



1100-268



1200-716

**Reynolds Tenotomy Classic, Power Cut Gold, Power Cut Black®, TC/PC Power Cut® Scissors**

**Classic / 5 3/4" (14.5 cm)**

2405-324S straight  
2405-324 curved

**PC gold / 5 3/4" (14.5 cm)**

2400-324S straight  
2400-324 curved

**PC black / 5 1/4" (13.3 cm)**

2400-823S straight  
2400-823 curved

**PC black / 5 3/4" (14.5 cm)**

2400-824S straight  
2400-824 curved

**TC/PC / 5 3/4" (14.5 cm)**

2405-824S straight  
2405-824 curved

**Classic / 6 1/4" (16 cm)**

2405-326 straight  
2405-327 curved

**PC gold / 6 1/4" (16 cm)**

2400-326 straight  
2400-327 curved  
1200-348 curved spread handle

**PC black / 6 1/4" (16 cm)**

2400-826 straight  
2400-827 curved  
2400-827S curved spread handle

**TC/PC / spread handle / 6 1/4" (16 cm)**

2405-826 straight  
2405-827 curved



2405-324S



2400-327



2400-827S

**Freeman-Kaye Ergonomic Spread Handle Saberback Scissors**

Ergonomic / spread handle / double beveled blades / spatulated tip / curved / TC/PC

475-188 7 1/4" (18.5 cm)  
475-187 9" (23 cm)

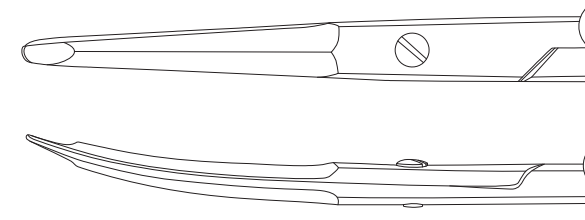

475-188

Ergonomic / spread handle / double beveled blades / flat tip / straight / TC/PC

475-185 7 1/4" (18.5 cm)  
475-186 9" (23 cm)



475-185

**Martin Cartilage Tenotomy Classic Power Cut Gold® Scissors**

**Classic / 8" (20.5 cm)**

- 350-861 straight
- 350-862 curved



350-864

**PC gold / 8" (20.5 cm)**

- 350-863 straight
- 350-864 curved

**PC black / 8" (20.5 cm)**

- 350-861B straight
- 350-862B curved



350-861B

**Doyen Classic Model Power Cut Gold® Scissors**

**Serrated / classic / 6 1/2" (16.5 cm)**

- 1100-196 straight
- 1100-198 curved

**Serrated / PC gold / 6 1/2" (16.5 cm)**

- 1200-601 straight
- 1200-603 curved

**Serrated / classic / 7 1/4" (18.5 cm)**

- 1100-197 straight
- 1100-199 curved

**Serrated / PC gold / 7 1/4" (18.5 cm)**

- 1200-600 straight
- 1200-602 curved



1200-602

**Goldman-Fox Scissors**

**Tenotomy tip / classic / curved / 5" (12.5 cm)**

- 110-908 straight shanks
- 110-910 angled shanks

**Tenotomy tip / TC / curved / 5" (12.5 cm)**

- 112-908 straight shanks
- 112-910 s-curved shanks

**Tenotomy tip / PC gold / curved / straight shanks / 5" (12.5 cm)**

- 1200-405

**Tenotomy tip / PC gold / straight / 5" (12.5 cm)**

- 1200-404

**Tenotomy tip / PC black / 5" (12.5 cm)**

- 1200-404B straight
- 1200-405B curved



112-908



112-910



1200-404B



1200-405B

**LaGrange Scissors**

S-curve blade & shank / PC / 4 1/2" (11.5 cm)

- 110-920 strong curve
- 110-915 slight/regular curve

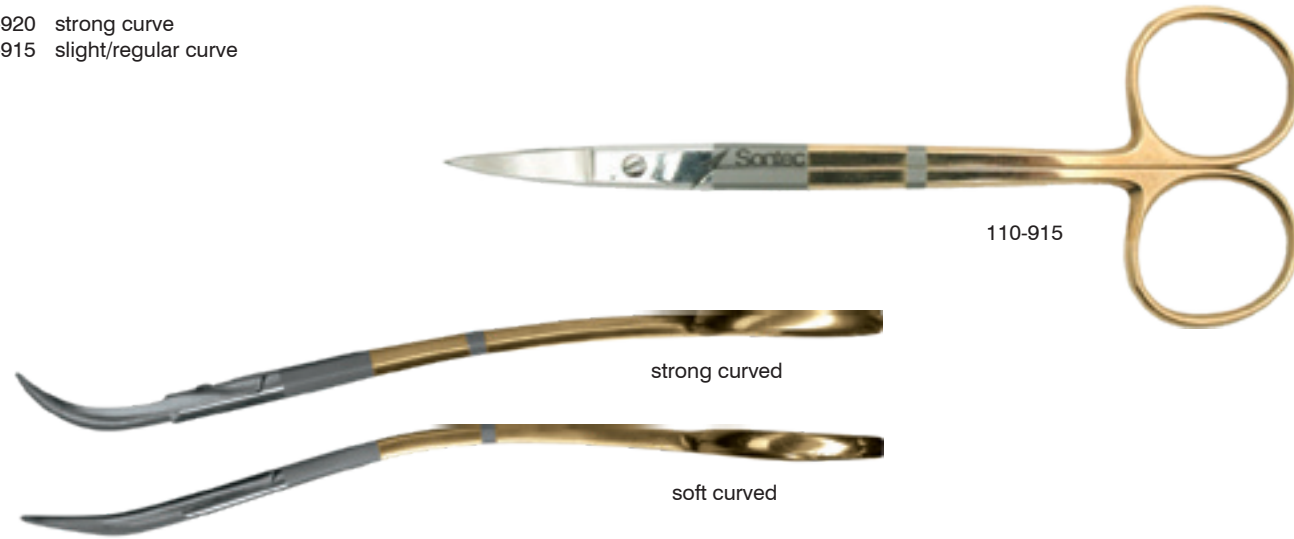

**Eye Scissors**

Bead tips / 4 1/4" (11 cm)

- 13-9334 straight
- 13-9335 curved

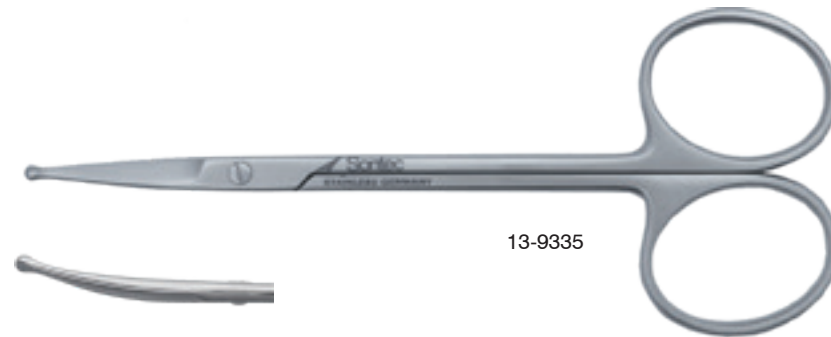

**Converse Daniel Scissors**

Angled-up / PC Black / 3 3/4" (9.5 cm)

- 460-156



**Converse Wilmer Scissors**

Pointed angled up serrated blades / 4" (10 cm)

- 13-9800 classic non-serrated
- 460-158 PC gold
- 1200-720 PC black
- 460-159 PC gold spread handle

Pointed angled up serrated blades / PC gold / 3 1/2" (8.9 cm)

- 460-160 3 1/2"

Pointed angled up serrated blades / PC black / 3 1/2" (8.9 cm)

- 1200-719

Pointed angled up serrated blades / PC / black Ceramitec / gold screw / 1 blade serrated / spread handle / 4" (10 cm)

- 1200-990

Pointed angled up serrated blades / PC black / sharp / spread handle / 4 1/2" (11 cm)

- 2400-714

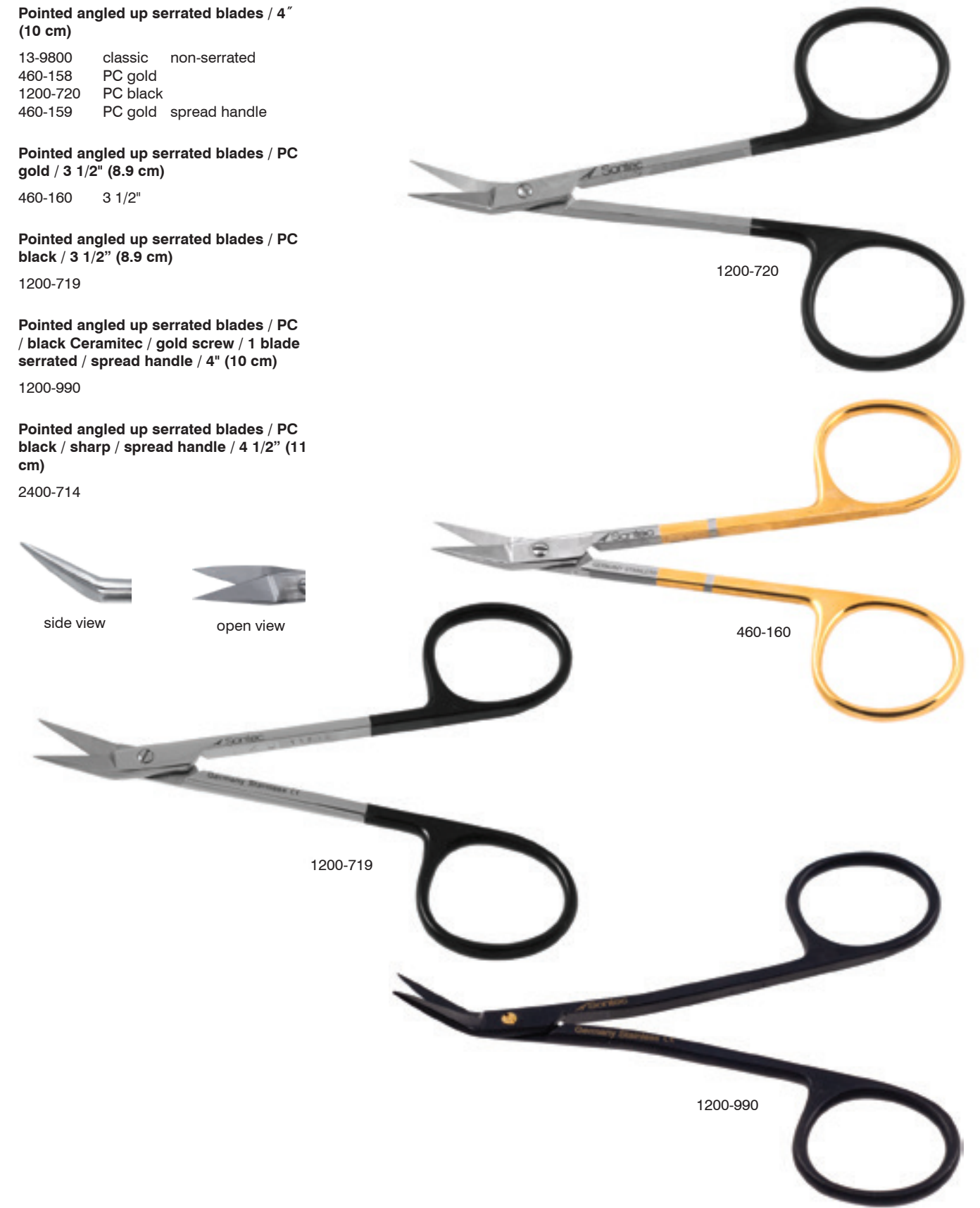

**Jabaley Scissors**

**PC black / 4 3/4" (11 cm)**

- 2400-753 straight
- 2400-755 curved

**Ergonomic spread handle / PC black / 5" (12.7 cm)**

- 2400-756 curved
- 2400-757 straight

**Black ceramic with gold screw / ergonomic spread handle / PC / 5" (12.7 cm)**

- 1200-940 curved



2400-756



1200-940

**Par Scissors**

**TC / 4 1/2" (11.5 cm)**

- 112-580 straight
- 112-585 curved

**TC / 5 3/4" (14.5 cm)**

- 112-581 straight
- 112-582 curved

**PC gold / curved/ 5 3/4" (14.5 cm)**

- 1200-402



1200-402

**Joseph-Peck Saberback Classic Power Cut Gold®  
Power Cut Black® TC/PC Power Cut Scissors**

**Saberback / curved / 4 1/2" (15 cm)**

- 2400-438 PC Gold

**Saberback / curved / 6" (15 cm)**

- 2400-440 classic
- 2400-439 PC Gold
- 2400-442 TC/PC
- 2400-739 PC Black curved
- 2400-733 PC Black straight

**Straight / 6" (15 cm)**

- 2400-433 PC Gold

**Ceramic coated / saberback / TC/PC curved blades / black with gold screw and gold shiny rings / 6" (15 cm)**

- 1200-945

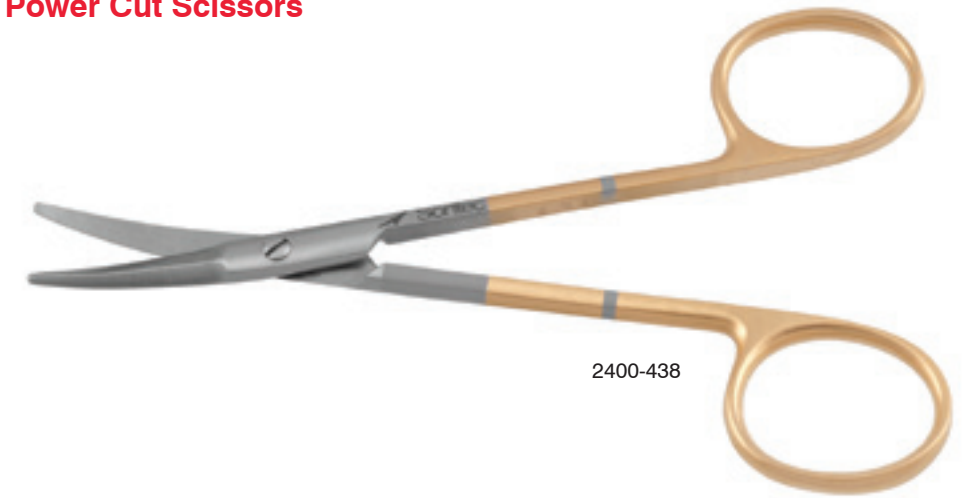

2400-438



2400-442



1200-945

**Ragnell Undermining Power Cut Gold® Scissors**

**PC gold / spatulated tips / curved**

- 2400-374 4 1/2" (11.5 cm)
- 2400-375 5" (12.5 cm)
- 2400-3751 5" (12.5 cm) full curved
- 2400-376 5 1/2" (14 cm)
- 2400-377 6" (15 cm)
- 2400-379 7" (18 cm)
- 2400-381 8" (20 cm)
- 2400-383 9" (23 cm)
- 2400-383S 9" (23 cm) strong curved
- 2400-385 10 3/4" (26.5 cm)



strong curved  
2400-383S

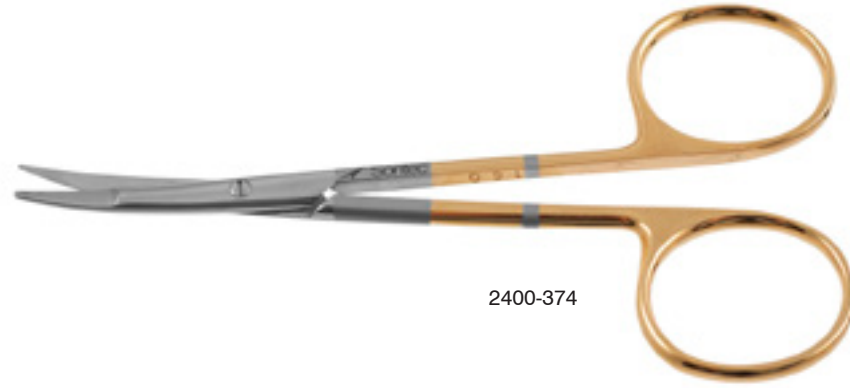

2400-374



2400-375



2400-377

**Kaye Blepharoplasty Scissors**

**TC / 4 1/2" (11.5 cm)**

- 112-602 straight
- 112-603 curved

**Serrated / ribbon handle / 4 1/4" (10.8 cm)**

- 1200-070 PC gold straight
- 1200-072 PC gold curved
- 13-6800 PC silver straight
- 13-6810 PC silver curved
- 13-6815 PC Black curved

**Curved / spread handle / 4 3/4" (12 cm)**

- 1200-076 PC Gold
- 1200-076B PC Black



112-603



1200-072



13-6815



1200-076

**Castanares Scissors**

**Classic / 6" (15.2 cm)**

110-308

**TCPC / 6 1/2" (16.5 cm)**

1200-843 straight

**PC Black / 6" (15.2 cm)**

1200-845 straight

1200-846 curved



110-308



1200-845



1200-843

**Castanares Scissors**

**PC Gold / 6 3/4" (17.1 cm)**

1200-445 straight



1200-445

**Sontec® Bipolar Metzenbaum Scissors**

For dissecting, cutting, and bipolar coagulation of tissue /  
one prong / classic blades

- 2700-5331 7"
- 2700-5341 8"
- 2700-5351 9"
- 2700-5371 11"

For dissecting, cutting, and bipolar coagulation of tissue /  
one prong / delicate blades

- 2700-5411 7"
- 2700-5431 8"
- 2700-5451 9"
- 2700-5471 11"

One prong cord / sold separately

- 2700-5251 3 meter cord
- 2700-5271 5 meter cord



130-141-300

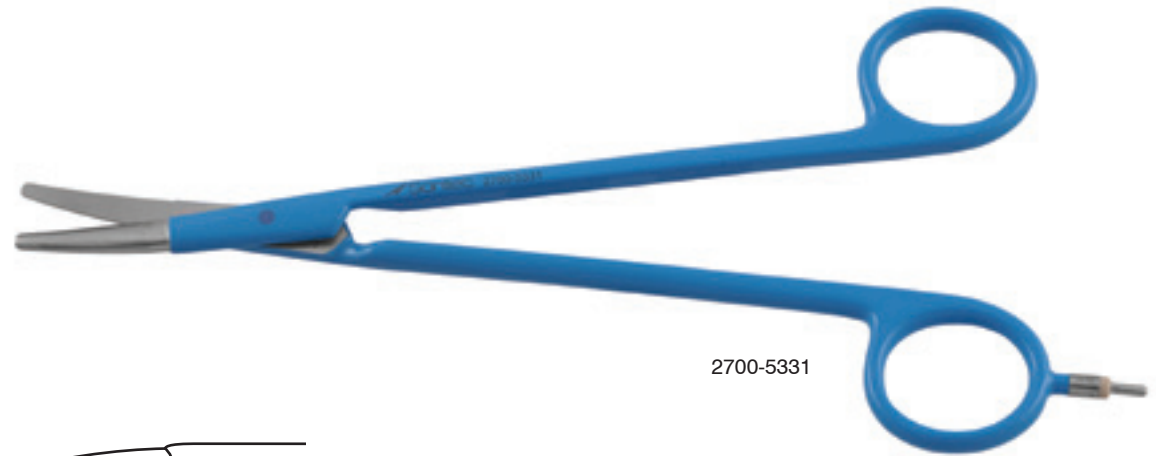

2700-5331

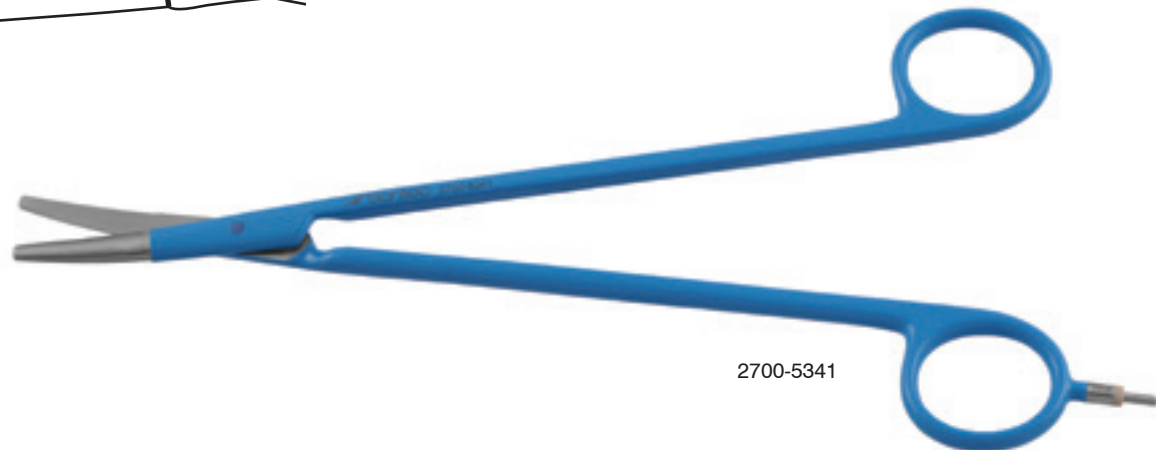
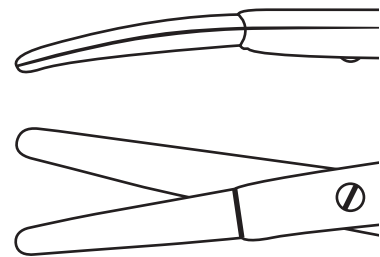

2700-5341



 Sontec Instruments®

NEEDLE HOLDERS Ring Handle

Sontec® offers variety of needle holder styles to choose from

**Classic Serrated Jaws  
(no inserts)**

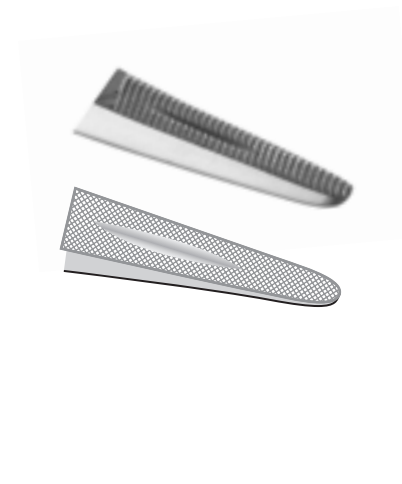

**Classic Jaws**

- stainless
- most often a serrated pattern
- featuring satin rings

**TC Smooth Inserts**

- a rigid, clean & flat surface
- for delicate use
- eliminates needle scoring for a smooth pass each time

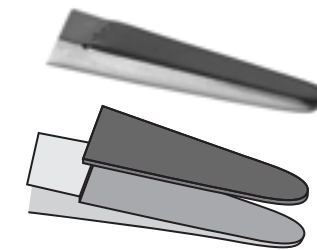

**TC Serrated Inserts**

- a diamond serrated teeth-like pattern
- 2,600 & 4,200 teeth per square inch for medium to heavier needles
- 7,000 & 10,000 teeth per square inch for small to micro needles

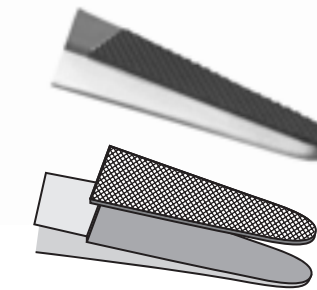

**Jaws with TC Inserts**

- diamond ground tungsten carbide
- incredibly hard & durable
- for a more secure grasp of the needle, preventing rotation & slippage
- featuring gold rings

**TC Dust (no inserts)**

- a very thin coating applied
- an almost smooth yet remarkably gritty surface
- eliminates needle scoring for a smooth pass each time



**Derf Needle Holder**

**Mini / 3 1/2" (9 cm)**

- 132-375 TC dust
- 132-376 TC serrated
- 132-376S TC smooth

**Mini / 4 1/4" (11 cm)**

- 132-632 TC serrated
- 132-634 smooth

**4 3/4" (12 cm)**

- 130-508
- 132-364 TC serrated
- 132-364L TC serrated left streamlined large rings
- 132-364S TC serrated
- 132-365 TC Dust

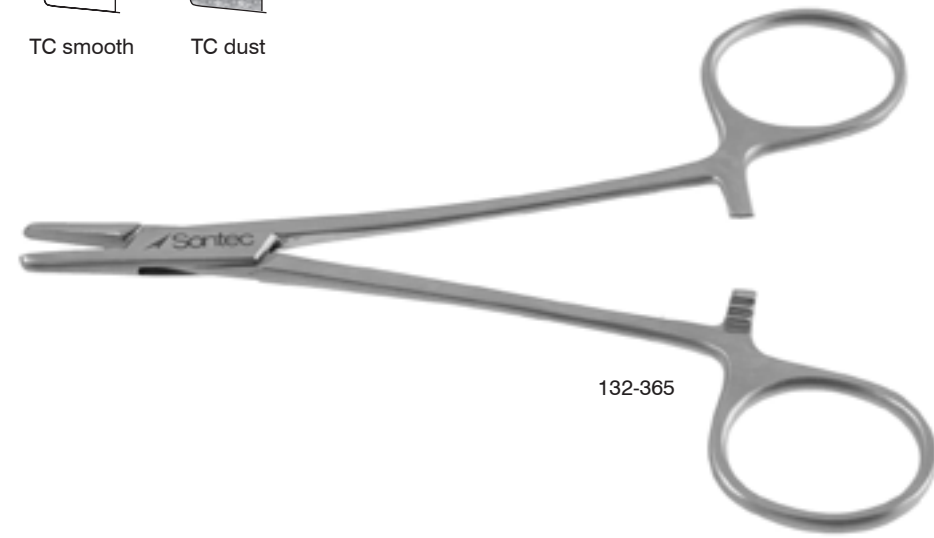
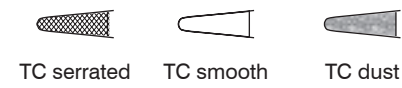

**Derf Needle Holder Titanium**

**Mini / 4 1/4" (11 cm)**

- 2600-714 TC dust
- 2600-716 TC serrated

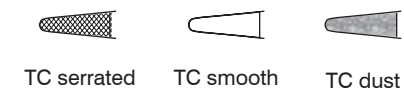

**Halsey Needle Holder**

**5" (12.5 cm)**

- 130-517 serrated without TC/standard
- 130-518 smooth without TC/standard
- 132-372 TC serrated
- 132-374 TC smooth
- 132-373 TC Dust

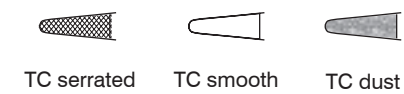

**Webster Needle Holder**

4 3/4" (12 cm)

- 1100-392 serrated w/out TC
- 2300-516 TC serrated
- 2300-518 TC smooth
- 2300-520 TC dust
- 2300-521 6" TC dust



2300-516



2300-520 TC Dust      2300-518 TC Smooth      2300-516 TC Serrated

**Webster Needle Holder Titanium**

TC Dust / 4 3/4" (12.1 cm)

2600-725



2600-725

**Mayo-Hegar Needle Holder**

Serrated jaws without TC

- 130-527 6 1/4" (15 cm)
- 130-529 7 1/4" (18 cm)
- 130-531 8" (20 cm)



130-527



130-529



130-531

Tungsten carbide serrated jaws

- 2300-328 5 3/4" (14.6 cm)
- 132-115 6 1/4" (15 cm)
- 1100-114L 7 1/4" (18 cm) left
- 132-118 7 1/4" (18 cm)
- 132-120 8" (20 cm)
- 132-122 9" (23 cm)
- 132-123 10" (25 cm)
- 132-125 12" (30 cm)
- 1100-853 14" (35 cm)
- 1100-851 16" (40 cm)
- 1100-854 18" (45 cm)



132-115



132-118

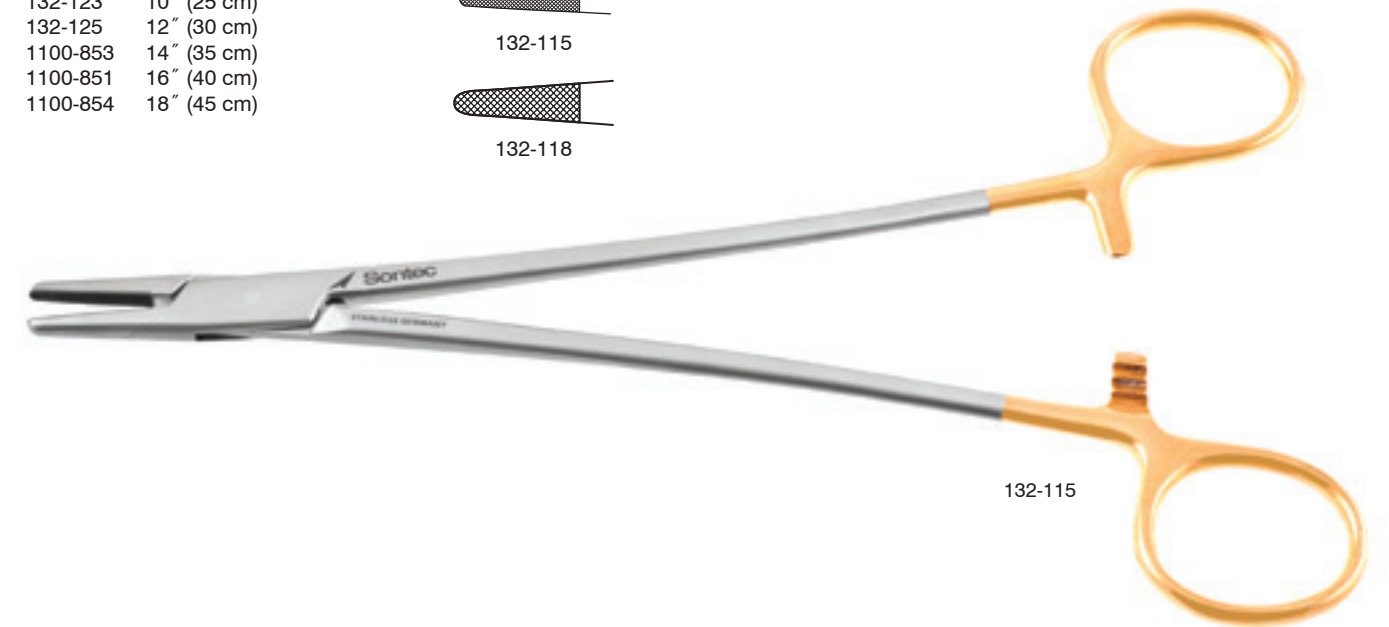

132-115

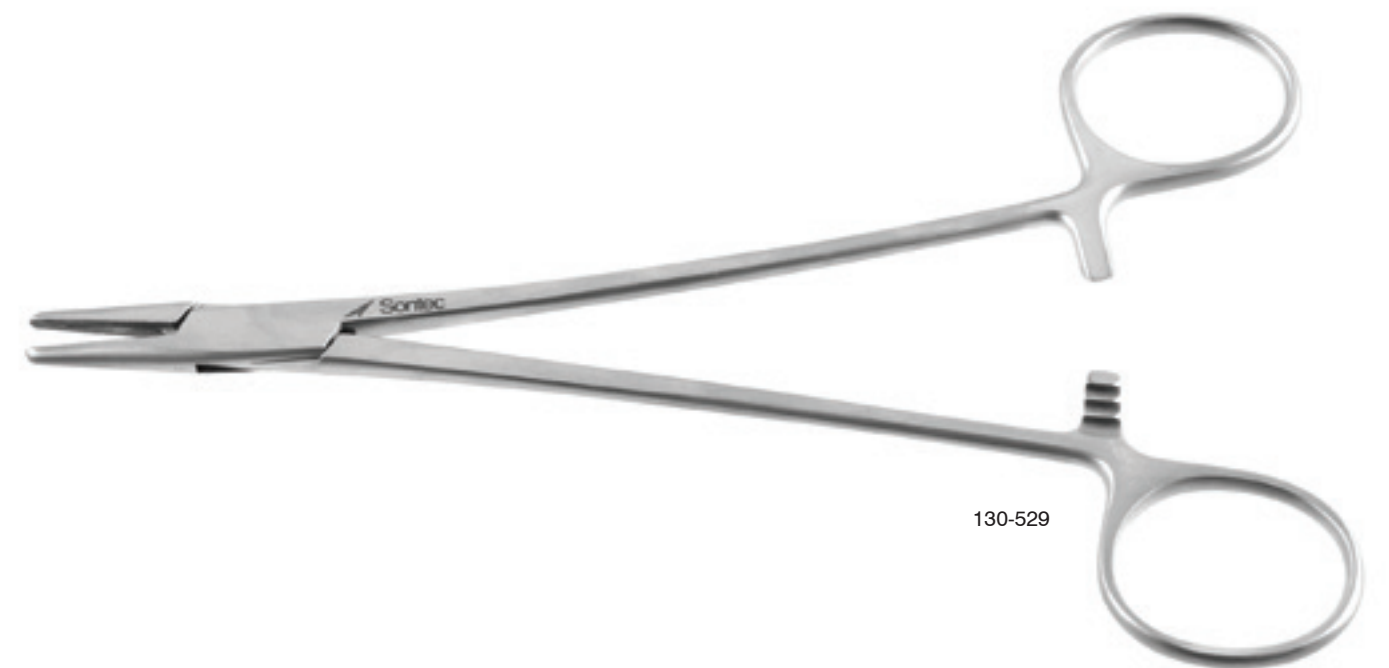

130-529

**Mayo-Hegar Streamlined Needle Holder**

Tungsten carbide serrated jaws / streamlined box lock

2300-714	5 3/4" (14.5 cm)	
2300-716	6 1/4" (16 cm)	
2300-718	7" (18 cm)	
2300-718N	7" (18 cm)	Neivert offset rings
2300-720	8" (20 cm)	
2300-723	9" (23 cm)	
2300-726	10 1/4" (25.5 cm)	
2300-730	12" (30 cm)	

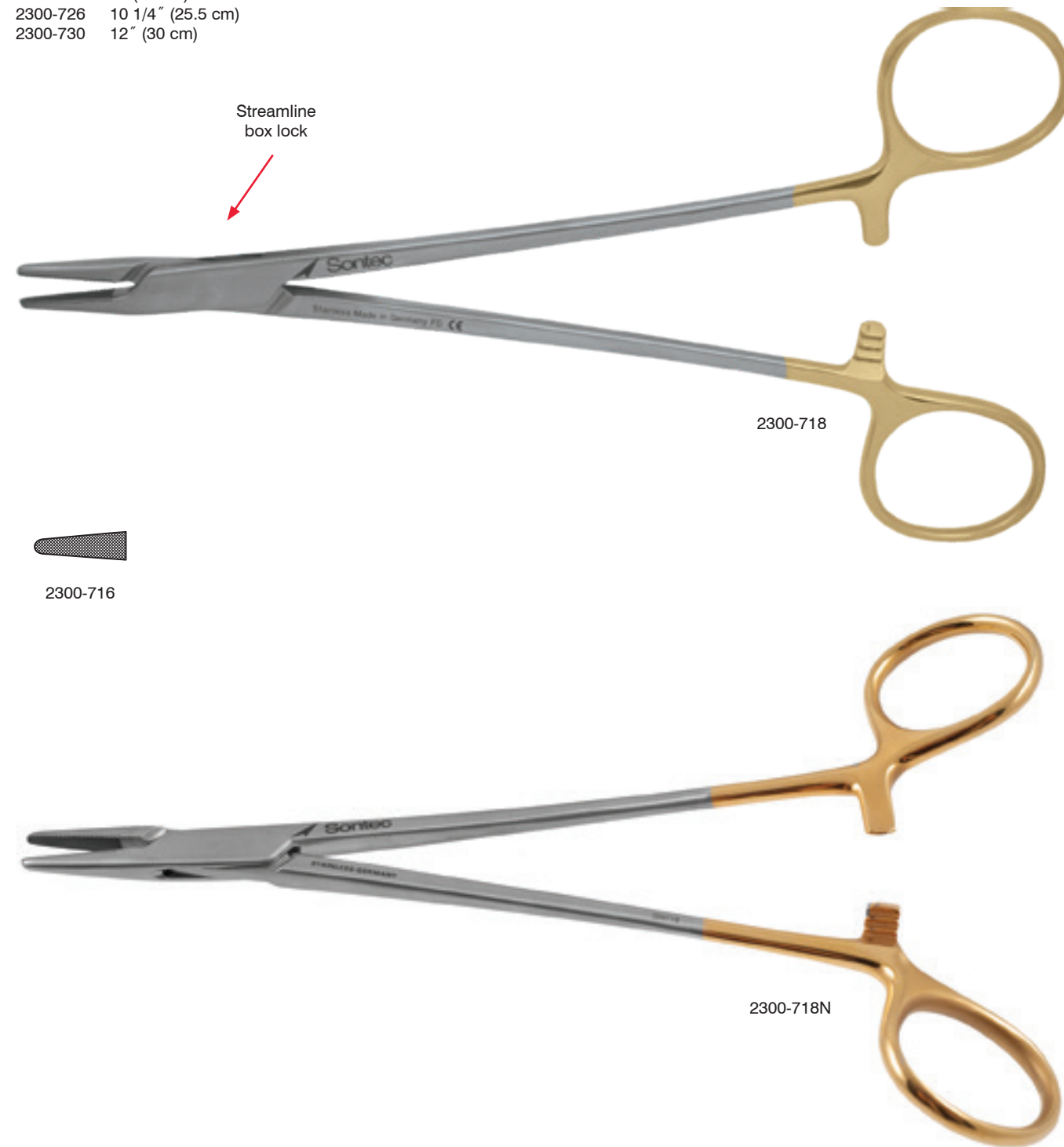

**Mayo-Hegar Needle Holder Titanium**

Standard box lock / TC serrated

2600-755	6 1/4" (16 cm)
2600-757	7 1/8" (18.25 cm)
2600-759	8" (20 cm)
2600-761	8 3/4" (22 cm)

Standard box lock / TC dust

2600-745	6 1/4" (16 cm)
2600-747	7 1/8" (18.25 cm)
2600-749	8" (20 cm)
2600-751	8 3/4" (22 cm)

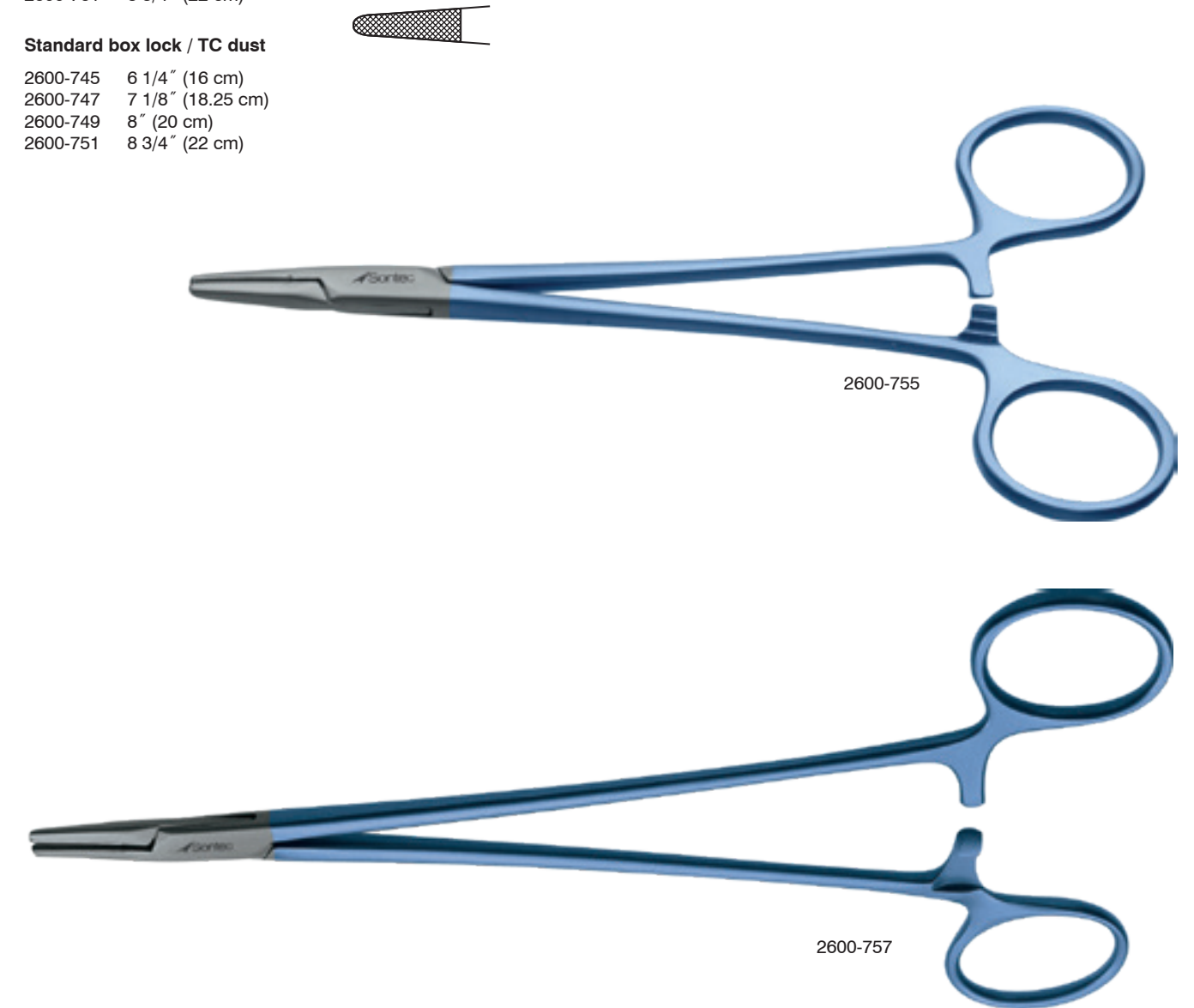

**Crile-Wood Needle Holder**

**Serrated without TC**

- 130-521 6" (15 cm)
- 130-523 7" (18 cm)
- 130-525 8" (20 cm)
- 130-526 9" (23 cm)



130-521



132-210



132-214



132-218

**TC Serrated**

- 132-388 str 6" (15 cm)
- 132-210 str 7" (18 cm)
- 132-223 cvd 7" (18 cm)
- 132-212 str 8" (20 cm)
- 132-225 cvd 8" (20 cm)
- 132-214 str 9" (23 cm)
- 132-224 cvd 9" (23 cm)
- 132-216 str 10" (25 cm)
- 132-218 str 12" (30 cm)



132-388

**Streamlined box lock / TC serrated**

- 2300-378 6" (15 cm)
- 2300-384S 7" (18 cm)
- 2300-388S 8" (20 cm)
- 2300-390S 9" (23 cm)
- 2300-394S 10" (25 cm)
- 2300-396S 12" (30 cm)

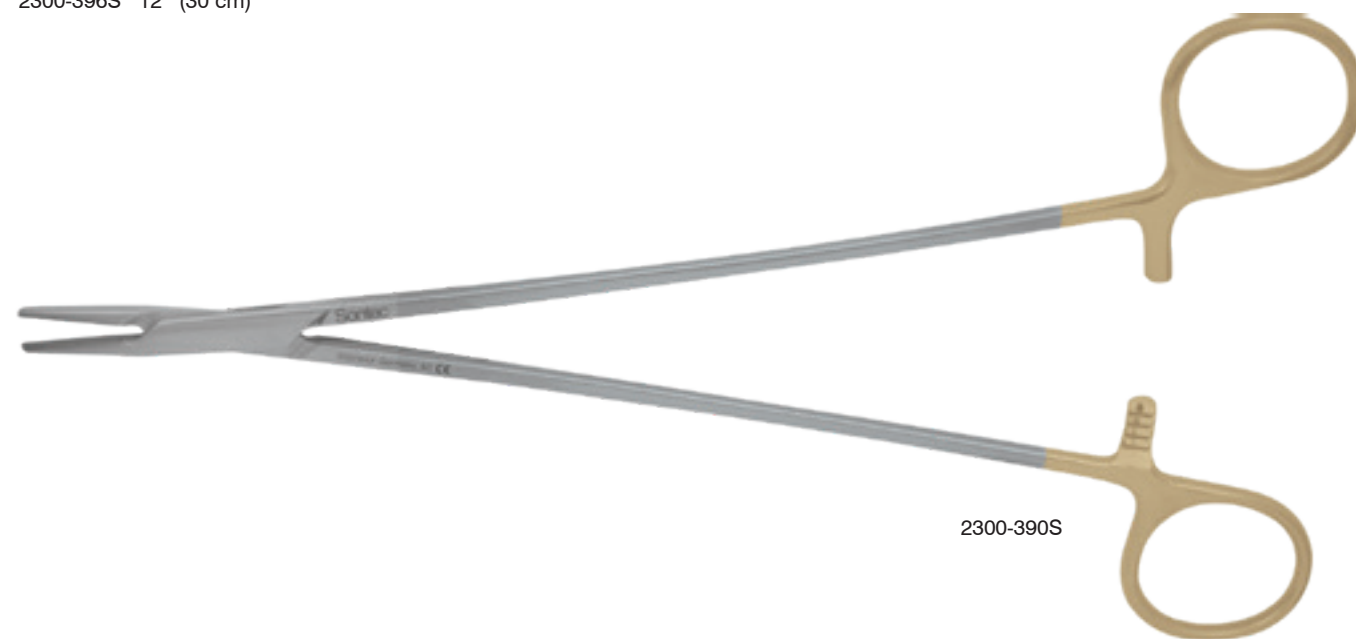

2300-390S

**Ryder Standard Size Needle Holder**

**1.5 mm jaw / streamlined box lock / TC / serrated**

- 2300-307 5" (13 cm)
- 2300-309 6" (15 cm)
- 2300-310L 6" (15 cm) left
- 2300-310 6 1/2" (15.5 cm)
- 2300-311 7" (18 cm)
- 2300-313 8" (20 cm)
- 2300-315 9" (23 cm)

**2 mm jaw / streamlined box lock / TC**

- 2300-3132 8" (20 cm)



TC Serrated straight



TC Dust straight

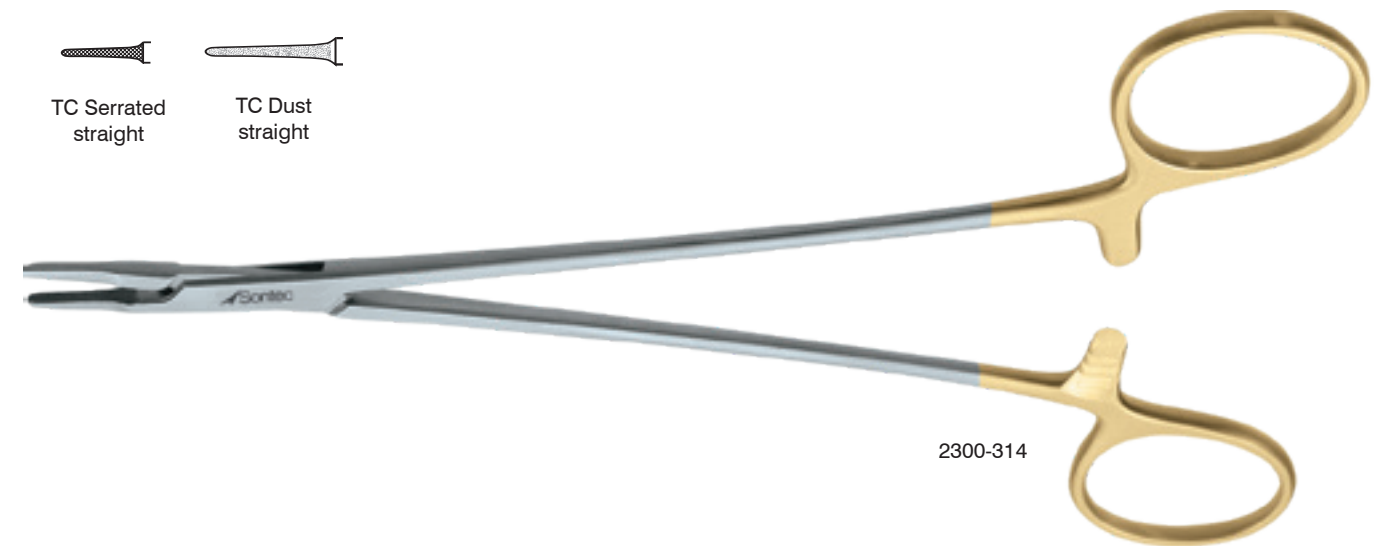

2300-314

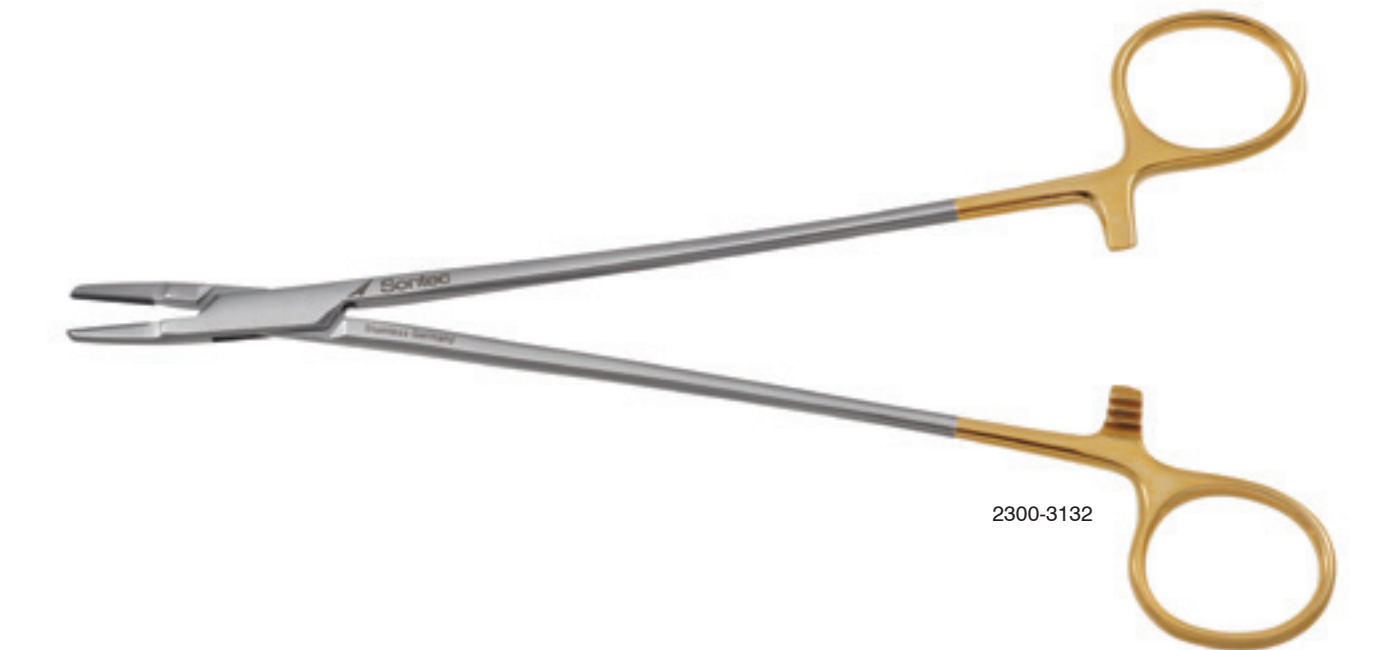

2300-3132



 Sontec Instruments®

NEEDLE HOLDERS Spring Handle - Eye, Cardio & Micro

**Gregory Needle Holder**

TC dust / straight / double action / round handle with lock / suggested suture size 7.0 and smaller

2300-048	7" (17.8 cm)	
2300-0481	7" (17.8 cm)	TC serrated
2600-730	7" (17.8 cm)	titanium
2300-049	8 1/4" (21 cm)	



2300-048



2300-0481



2600-730



2300-049

**Castroviejo Needle Holder**

Flat handle / TC dust / 5 3/4" (14.5 cm) / suggested suture size 7-0 and smaller

15-1916	str	w/o lock	
15-1917	cvd	w/o lock	
15-1912	str	w/lock	
15-1913	cvd	w/lock	
15-1914	str	w/lock	delicate
15-1915	cvd	w/lock	delicate

Flat handle / TC dust / 5 3/4" (14.5 cm) / suggested suture size 7-0 and smaller / titanium

T15-1916	str	w/o lock	
T15-1917	cvd	w/o lock	
T15-1912	str	w/lock	
T15-1913	cvd	w/lock	
T15-1914	str	w/lock	delicate
T15-1915	cvd	w/lock	delicate

Flat handle / TC insert / 5 3/4" (14.5 cm) / suggested suture size 7-0 and smaller

15-1900	str	w/ lock	
15-1910	cvd	w/ lock	
15-1901	str	w/o lock	
15-1911	cvd	w/o lock	



15-1912



15-1913



T15-1913



15-1900



15-1910



TC Smooth straight



TC Dust straight



TC Dust curved



TC Insert straight



TC Insert curved



TC Serrated

**Sontec Extra Micro Needle Holder**

Round handle / TC dust / extra delicate jaws / specially serrated grip on shanks / 6" (15 cm) / suggested suture size 8-0 and smaller

- 400-254 str w/lock
- 400-256 cvd w/lock
- 400-250 str w/o lock
- 400-252 cvd w/o lock

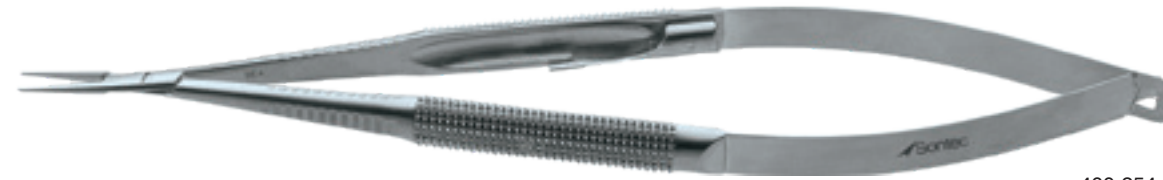

400-254

**Boynton Needle Holder**

Delicate

- 130-563 4 3/4" (12 cm) serrated without TC
- 132-450 4 3/4" (12 cm) TC serrated
- 132-452 6 1/4" (16 cm) TC serrated

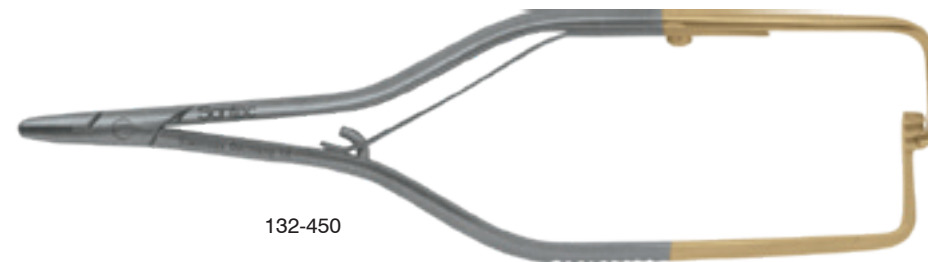

132-450

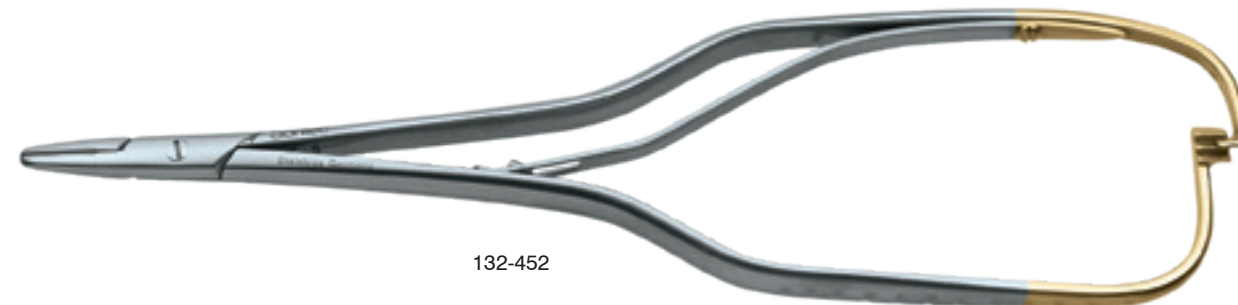

132-452

**Mathieu Heavy Needle Holder**

Standard

- 130-564 6 3/4" (17 cm) \*
- 130-565 8" (20 cm) \*

Tungsten carbide serrated

- 1100-094 6 3/4" (17 cm) \*
- 1100-098 8" (20 cm) \*
- 1100-096G 6 3/4" (17 cm) with finger grip

\* Also suitable as a wire twister



1100-096G

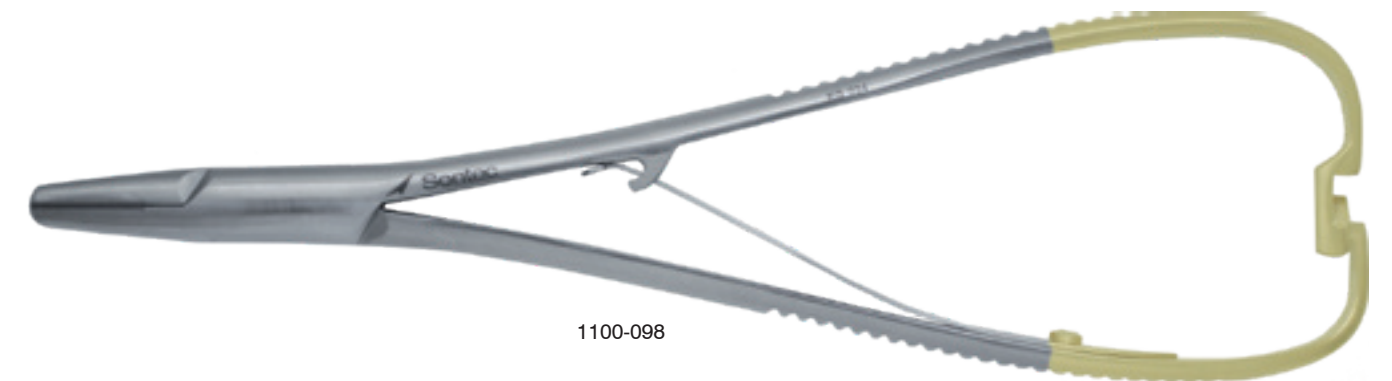

1100-098

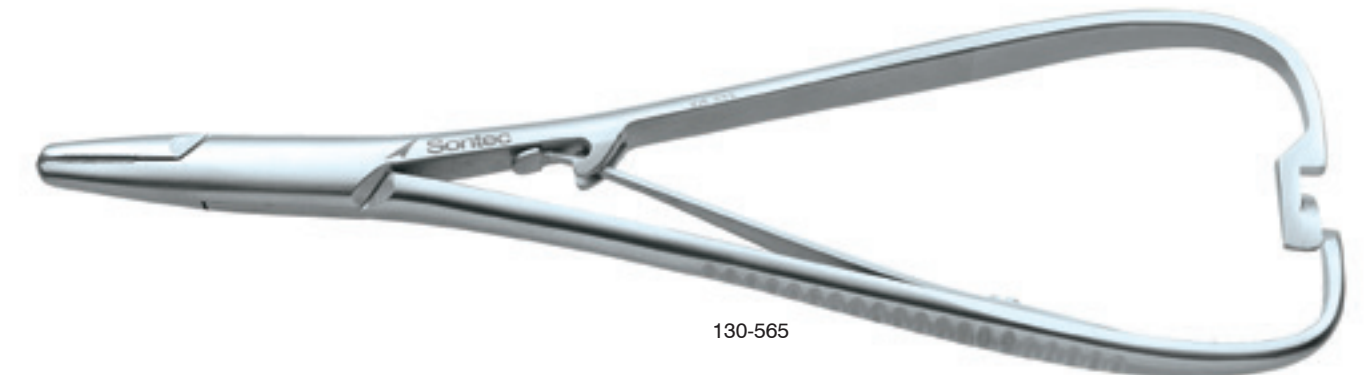

130-565

**Barraquer Needle Holder**

**Round handle / regular jaw / 5 1/2" (14 cm)**

15-3960	straight	w/ lock	stainless	TC serrated
15-3965	curved	w/ lock	stainless	TC serrated
15-3961	straight	w/o lock	stainless	TC serrated
15-3964	curved	w/o lock	stainless	TC serrated

**Round handle / 5 1/4" (13 cm)**

15-3915	straight			
15-3920	curved		TC Dust	
T15-3920	curved	titanium	TC Dust	
15-3925	w/ lock	straight		
T15-3925	straight	w/ lock	titanium	
15-3930	w/ lock	curved		TC Dust
T15-3930	curved	w/ lock	titanium	

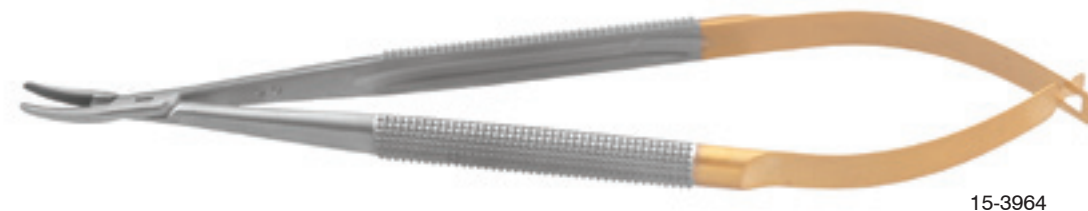

15-3964



15-3930

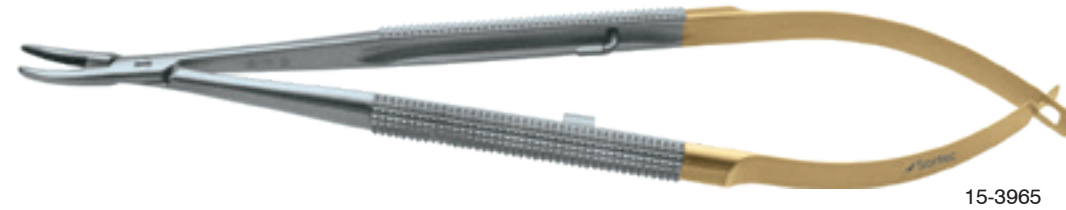

15-3965



15-3925

**Castroviejo Needle Holder**

**Round handle / TC dust / with lock / suggested suture size 7-0 and smaller**

2300-020	str	4 3/4" (12 cm)
2300-024	cvd	4 3/4" (12 cm)
2300-030	str	5 3/4" (14.5 cm)
2300-034	cvd	5 3/4" (14.5 cm)
2300-038	str	6" (15 cm)

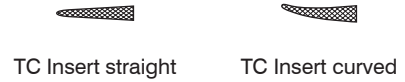

**Round handle / with out lock / TC dust**

2300-022	str	4 3/4" (12 cm)
2300-026	cvd	4 3/4" (12 cm)
2300-032	str	5 3/4" (14.5 cm)
2300-036	cvd	5 3/4" (14.5 cm)

**Round handle / TC insert / with lock**

2300-040	str	6" (15 cm)
2300-042	cvd	6" (15 cm)

**Round handle / streamlined / TC serrated / with lock**

2300-040S	str	6" (15 cm)
2300-042S	cvd	6" (15 cm)



2300-030



2300-042



2300-040S



2300-042S

**Jacobson Needle Holder**

Round handle / TC dust / streamlined box lock / suggested suture size 5-0 and smaller

2300-130S	str	w/o lock	6" (15 cm)
2300-132S	cvd	w/o lock	6" (15 cm)
2300-138S	str	w/o lock	7 1/8" (18.25 cm)
2300-140S	cvd	w/o lock	7 1/8" (18.25 cm)
2300-170	str	w/o lock	8 1/4" (21 cm)
2300-172	cvd	w/o lock	8 1/4" (21 cm)

2300-154S	str	w/o lock	9 1/4" (23.5 cm)
2300-156S	cvd	w/o lock	9 1/4" (23.5 cm)

2300-126S	str	w/ lock	6" (15 cm)
2300-128S	cvd	w/ lock	6" (15 cm)
2300-134S	str	w/ lock	7 1/8" (18.25 cm)
2300-136S	cvd	w/ lock	7 1/8" (18.25 cm)
2300-166	str	w/ lock	8 1/4" (21 cm)
2300-168	cvd	w/ lock	8 1/4" (21 cm)

2300-150S	str	w/ lock	9 1/4" (23.5 cm)
2300-152S	cvd	w/ lock	9 1/4" (23.5 cm)
2300-1510S	str	w/ lock	10" (25.5 cm)
2300-1530S	cvd	w/ lock	10" (25.5 cm)



TC Dust straight



TC Dust curved



Streamlined Box-lock



Regular Box-lock

Streamlined needle holders feature a smooth (streamlined) box-lock that does not snag suture when tying.



2300-126S



2300-134S



2300-166

**Glasser Micro Needle Holder**

TC dust / round handle / with lock / inverted spring / suggested suture size 5-0 and smaller/ 4 7/8" (12 cm)

2300-0496	straight
2300-0497	curved

TC dust / round handle / with lock / inverted spring / suggested suture size 5-0 and smaller/ 7" (17.8 cm)

2300-0498	straight
2300-0499	curved



2300-0496



2300-0499



 Sontec Instruments®

NEEDLE HOLDERS with Scissors

**Olsen-Hegar Deluxe Needle Holder**

**Tungsten carbide**

- 1100-105A 5" (12.5 cm)
- 1100-106D 5 3/4" (14.5 cm)
- 1100-106DL 5 3/4" (14.5 cm) left-handed



**TC Dust jaws**

- 1100-105D 5 3/4" (14.5 cm)

**Serrated without TC/standard**

- 1100-124D 5 3/4" (14.5 cm)
- 1100-126D 6 3/4" (17 cm)
- 1100-128D 7 3/4" (19.5 cm)

\* Custom micro serrations on cutting blade available upon request

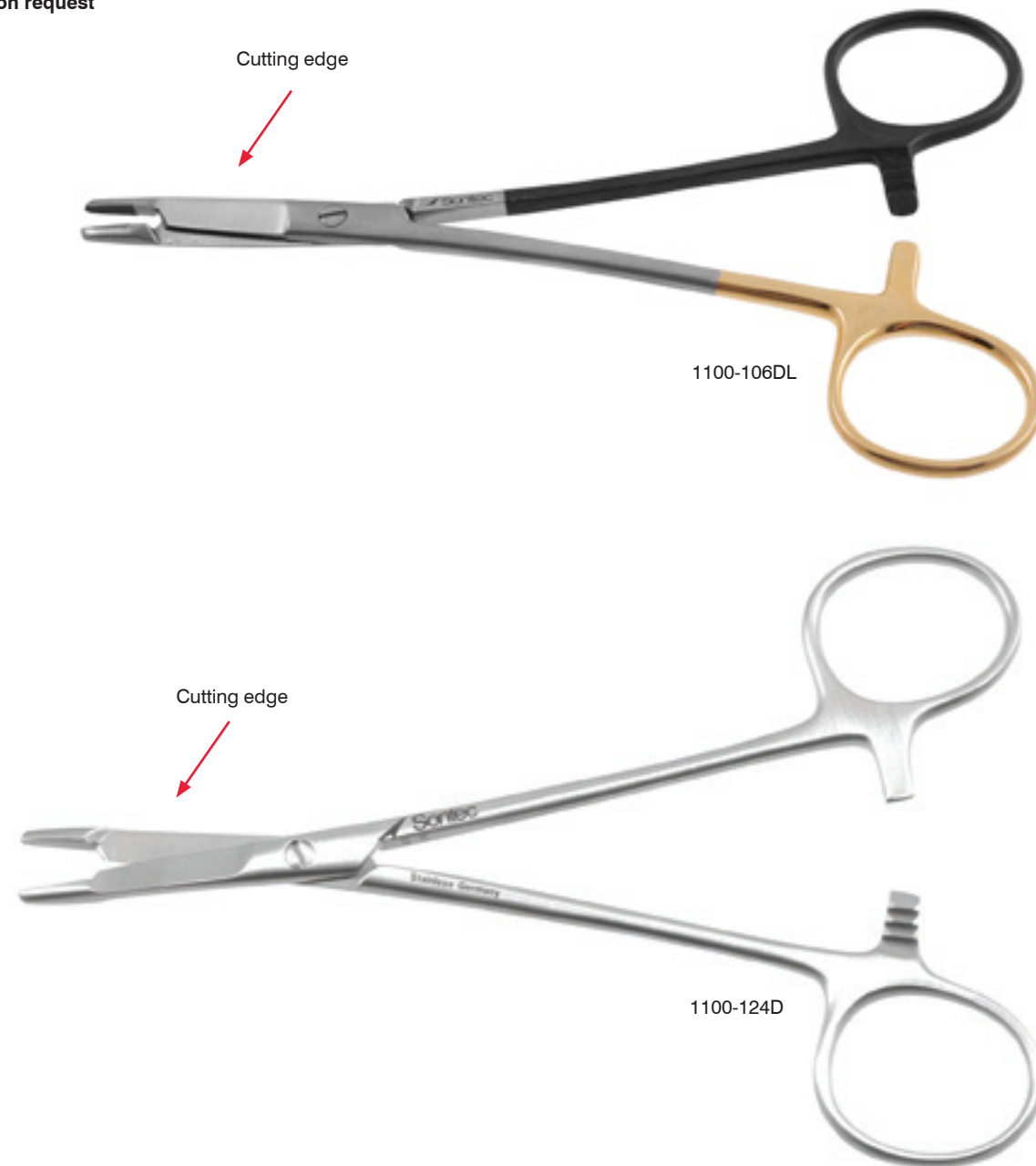

**Bipolar Sontec Olsen-Hegar Deluxe Needle Holder**

**Serrated TC / suggested suture size 5-0 and smaller**

- 1100-106DBP 5 1/2" (14 cm)
- 1100-110DBP 7 1/2" (19 cm)

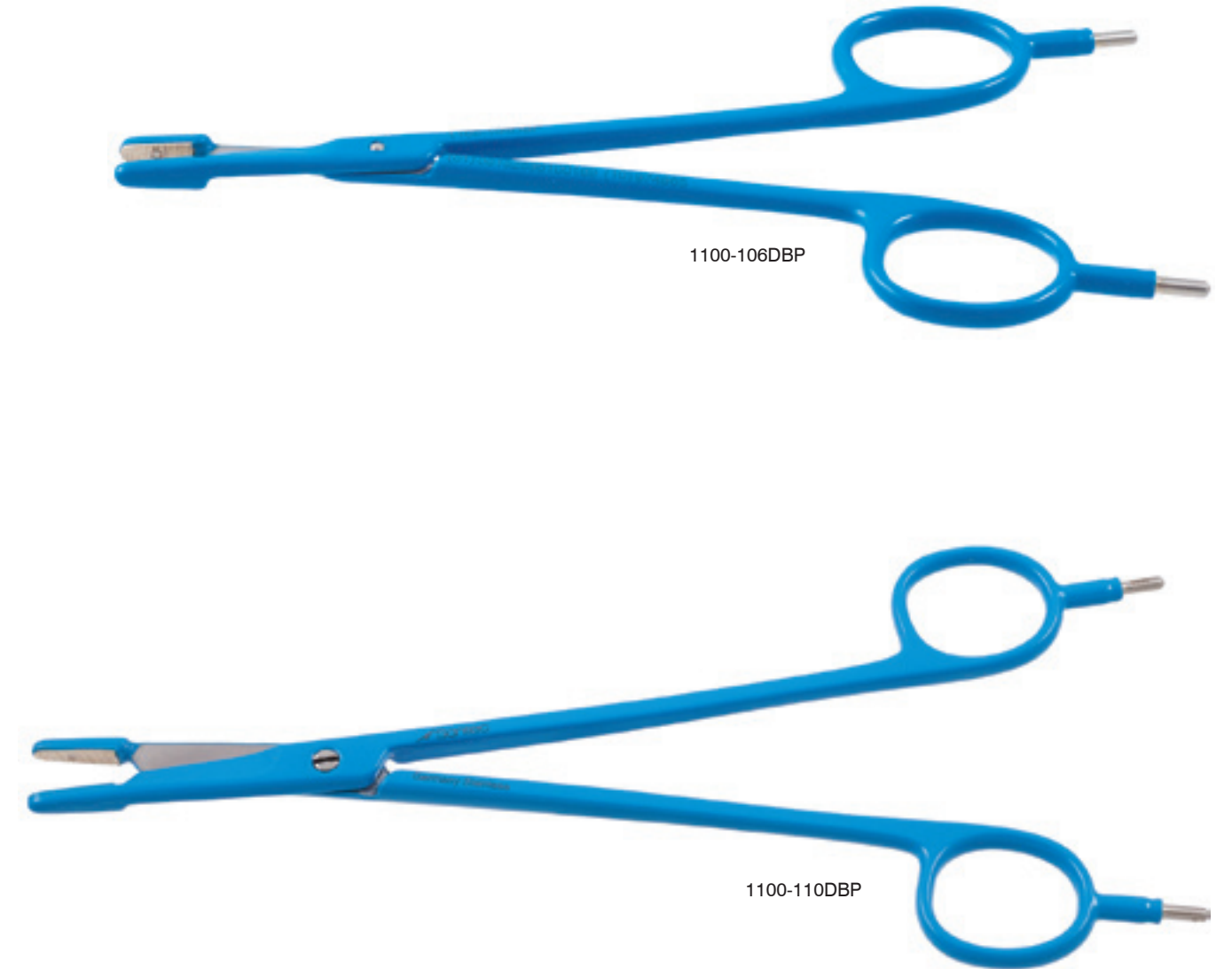

**Sontec Olsen-Hegar Needle Holder**

Unique jaw design / tungsten carbide

- 1100-106 5 1/2" (14 cm)
- 1100-106A 5 1/2" (14 cm) delicate
- 1100-108 6 1/2" (16.5 cm)

\* Custom micro serrations on cutting blade available upon request



1100-106A



1100-106

**Sontec Olsen-Hegar Needle Holder**

Unique jaw design / serrated without TC-standard

- 1100-124 5 1/2" (14 cm)
- 1100-126 6 1/2" (16.5 cm)

\* Custom micro serrations on cutting blade available upon request

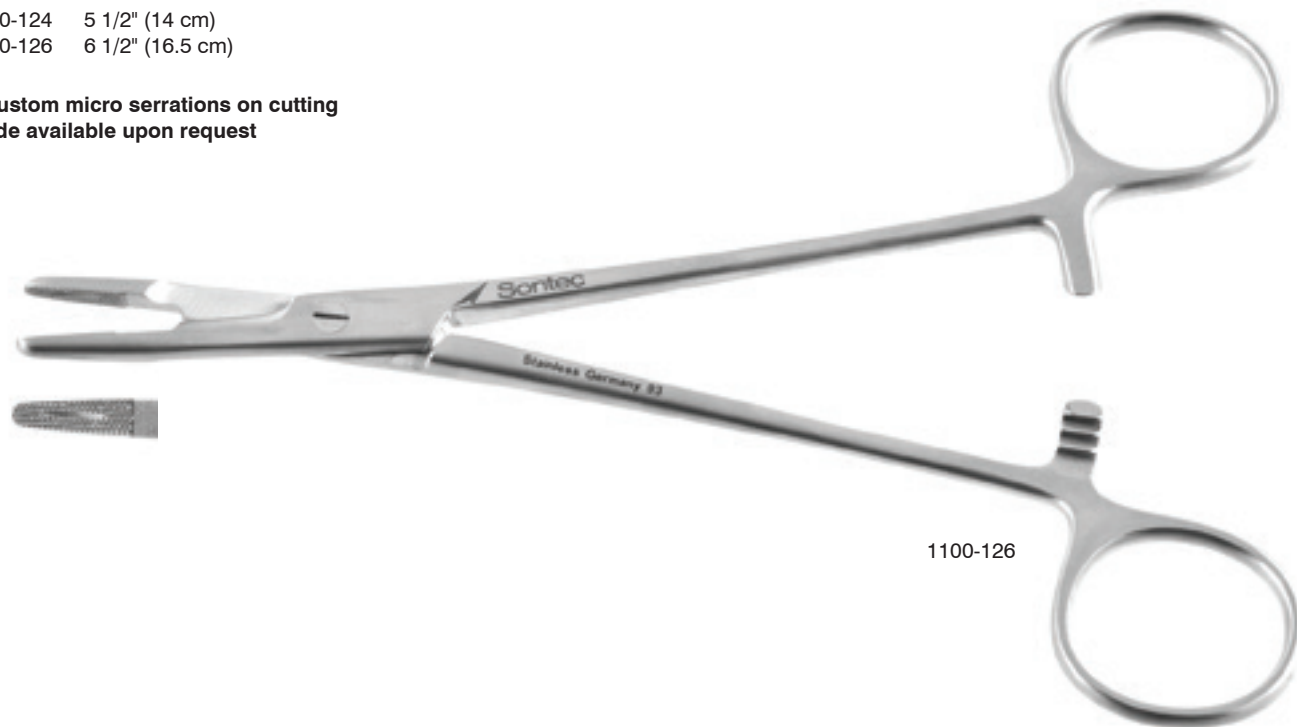

1100-126

**Olsen-Webster Needle Holder**

4 3/4" (12 cm)

- 1103-601 serrated w/out TC/standard
- 132-362 TC serrated
- 132-359 TC serrated delicate
- 132-360 TC smooth
- 1103-604 TC dust delicate
- 132-361 TC dust
- 132-362D TC serrated \*
- 132-362S TC offset ring

\* Double offset ring  
\* Custom micro serrations on cutting blade available upon request

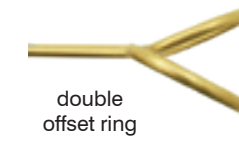

double offset ring

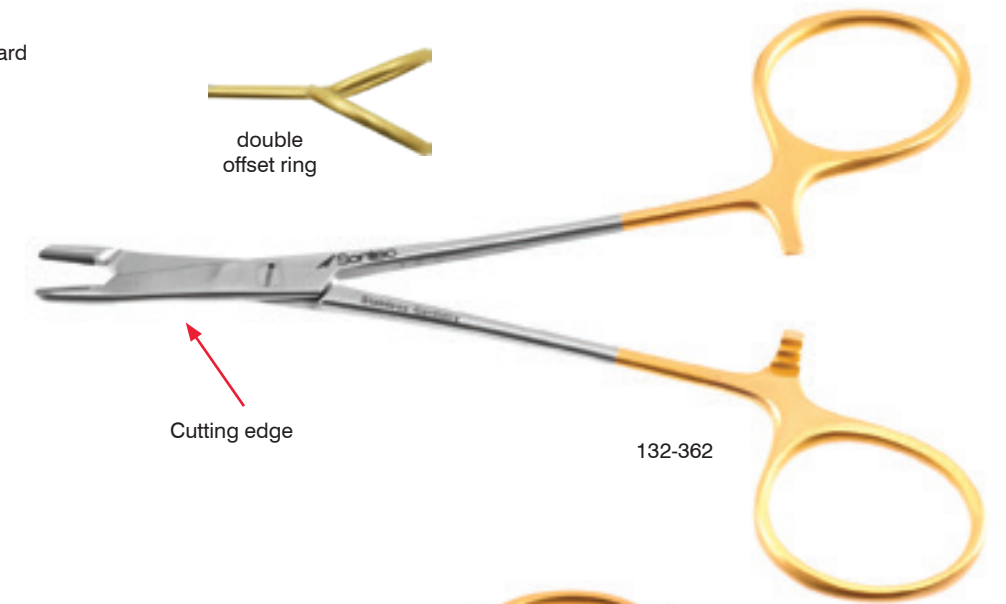

132-362

Cutting edge



TC Dust

Cutting edge

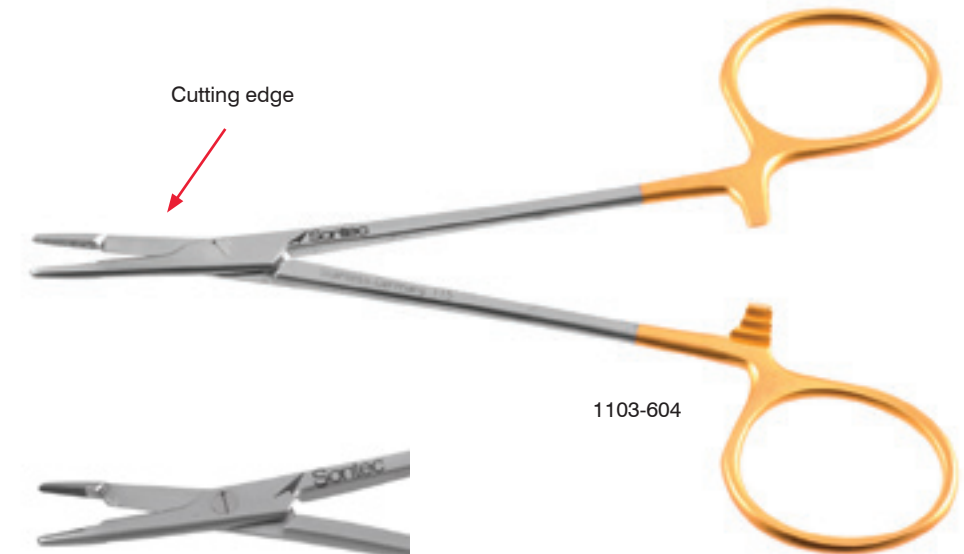

1103-604



132-359

Cutting edge



132-361

**Gillies Needle Holder**

Curved / 6 1/8" (15.5 cm)

- 132-384C TC serrated
- 132-384D TC dust
- 132-384L left handed

\* Custom micro serrations on cutting blade available upon request

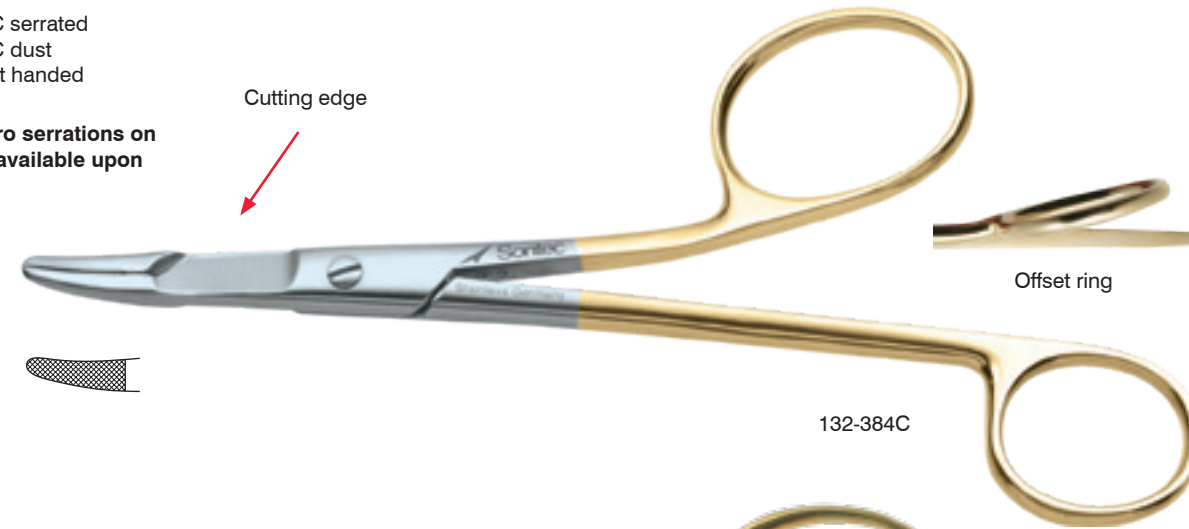

132-384C



132-384L

**Parkhouse Needle Holder**

TC serrated / 5 1/2" (14 cm)

132-135

\* Custom micro serrations on cutting blade available upon request



132-135

**Foster-Gillies Needle Holder**

TC serrated

- 132-387 straight 3 7/8" (10 cm)
- 132-382 angled 4 3/4" (12 cm)
- 132-383 curved 5 3/4" (14.5 cm)
- 132-382L angled 4 3/4" (12 cm) \*
- 132-383L curved 5 3/4" (14.5 cm) \*

\* Left handed

\* Custom micro serrations on cutting blade available upon request



straight

angled

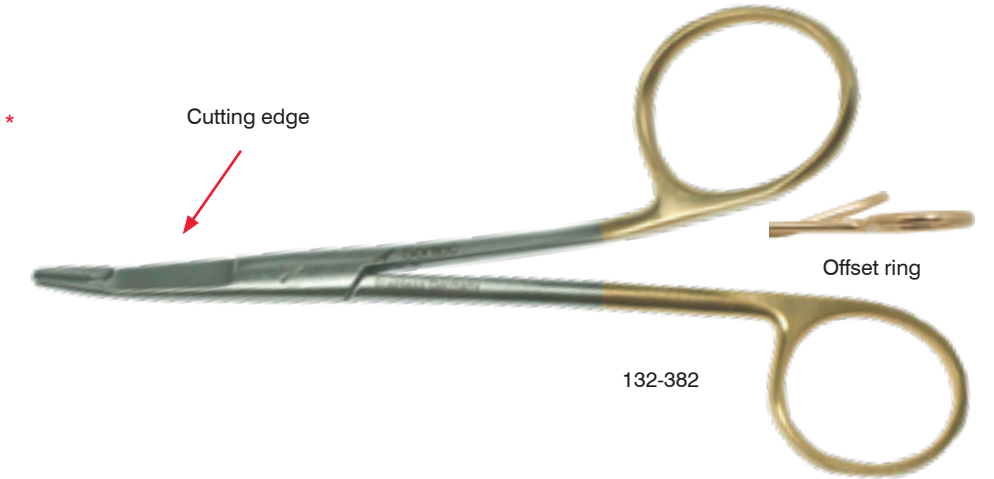

132-382



132-383



straight

angled

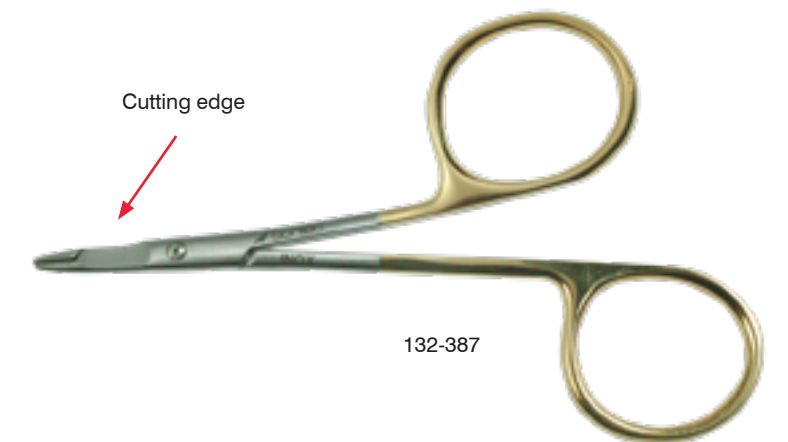

132-387

**Castroviejo Needle Holder with Scissors**

Flat handle / TC insert / 5 1/2" (14 cm) / suggested suture size 7-0 and smaller

- 15-1980 str w/ lock
- 15-1982 cvd w/ lock

\* Custom micro serrations on cutting blade available upon request



15-1980



15-1982

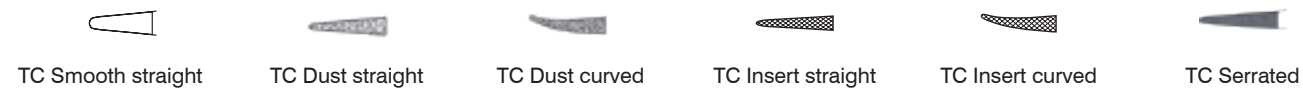

**Mathieu-Olsen Needle Holder**

Serrated without TC

- 130-570 5 1/2" (14 cm)
- 130-572 6 3/4" (17 cm)
- 130-574 8" (20 cm)

Tungsten carbide serrated

- 1103-597 5 1/2" (14 cm)
- 1103-596 6 3/4" (17 cm)
- 1103-595 8" (20 cm)

\* Custom micro serrations on cutting blade available upon request



1103-595



1103-597

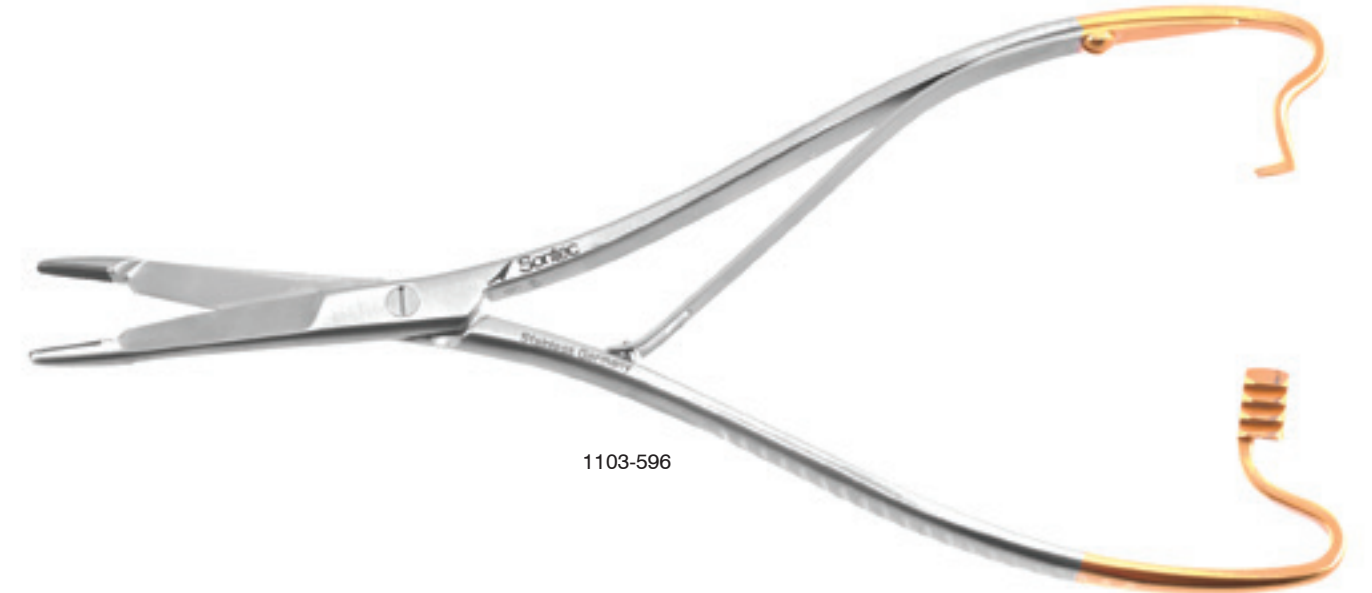

1103-596



 Sontec Instruments®

ARTHROSCOPIC

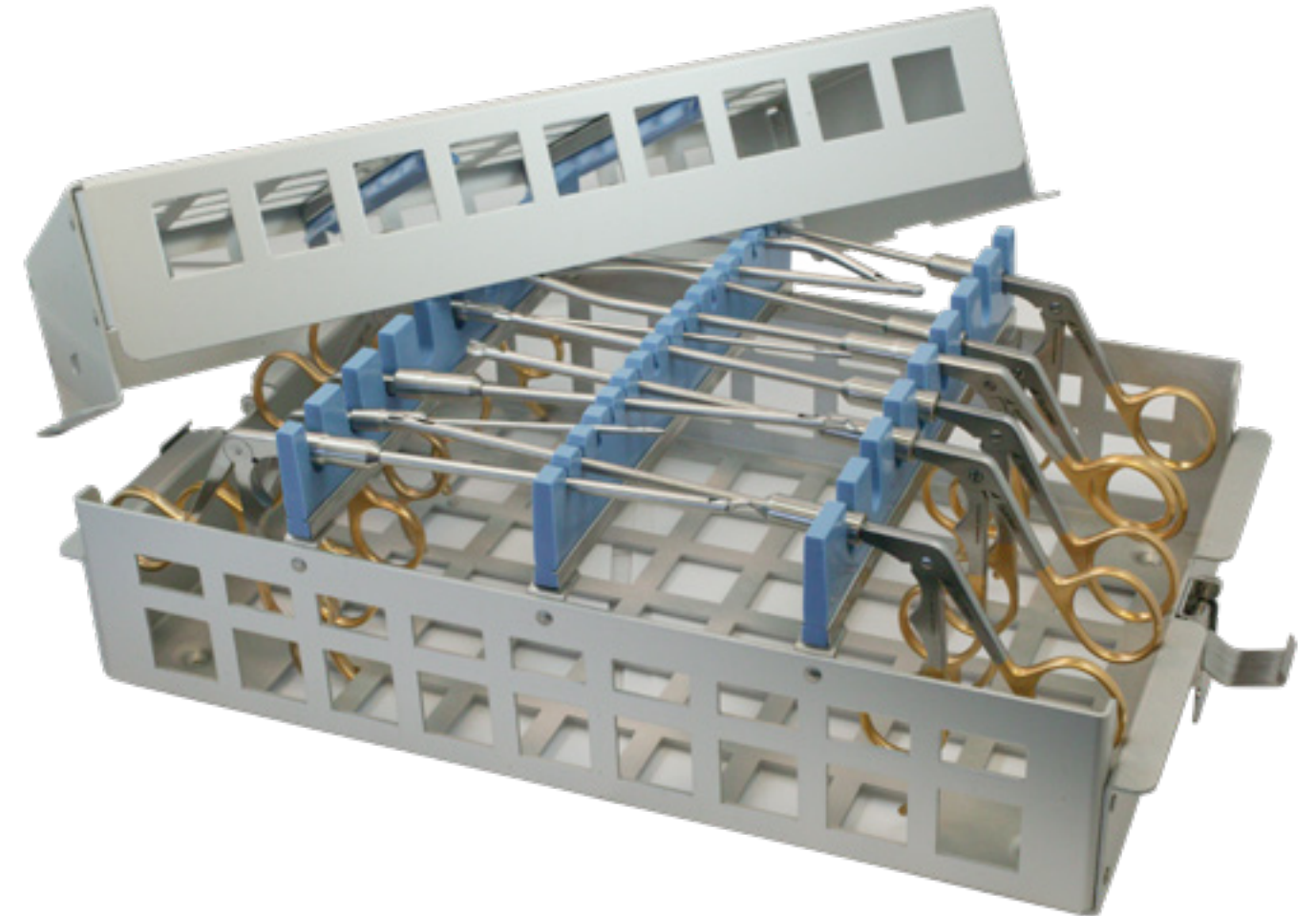

**Complete Arthroscopic sets (including tray) are available upon request. Please contact Sontec for more information.**

**Items shown are examples only. Customer must choose which 16 items to include in the set.**

**Restrictions apply 18-3318 tray only**

**Arthroscopic Hook Punch**

7" (18 cm)

2.7mm - custom size / please call Sontec for availability



with overload cone

1271-440

**With Scoop / with overload cone / 7" (18 cm)**



**Standard / with overload cone / 7" (18 cm)**



**2.7 mm**

- 1271-370 straight
- 1271-371 30° left
- 1271-372 30° right
- 1271-373 45° left
- 1271-374 45° right
- 1271-375 15° curved up

**2.7 mm**

- 1271-420 straight
- 1271-421 30° left
- 1271-422 30° right
- 1271-423 45° left
- 1271-424 45° right
- 1271-425 15° curved up

**3.4 mm**

- 1271-380 straight
- 1271-381 30° left
- 1271-382 30° right
- 1271-383 45° left
- 1271-384 45° right
- 1271-385 15° curved up

**3.4 mm**

- 1271-430 straight
- 1271-431 30° left
- 1271-432 30° right
- 1271-433 45° left
- 1271-434 45° right
- 1271-435 15° curved up

**4.5 mm**

- 1271-390 straight
- 1271-391 30° left
- 1271-392 30° right
- 1271-393 45° left
- 1271-394 45° right
- 1271-395 15° curved up

**4.5 mm**

- 1271-440 straight
- 1271-441 30° left
- 1271-442 30° right
- 1271-443 45° left
- 1271-444 45° right
- 1271-445 15° curved up

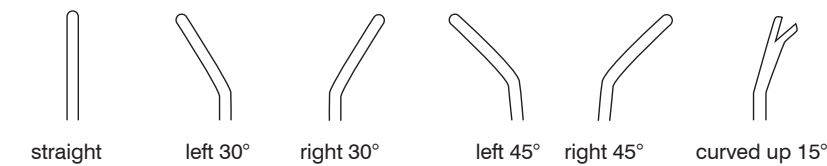

**Arthroscopic Metzenbaum Hook Scissors**

7" (18 cm)

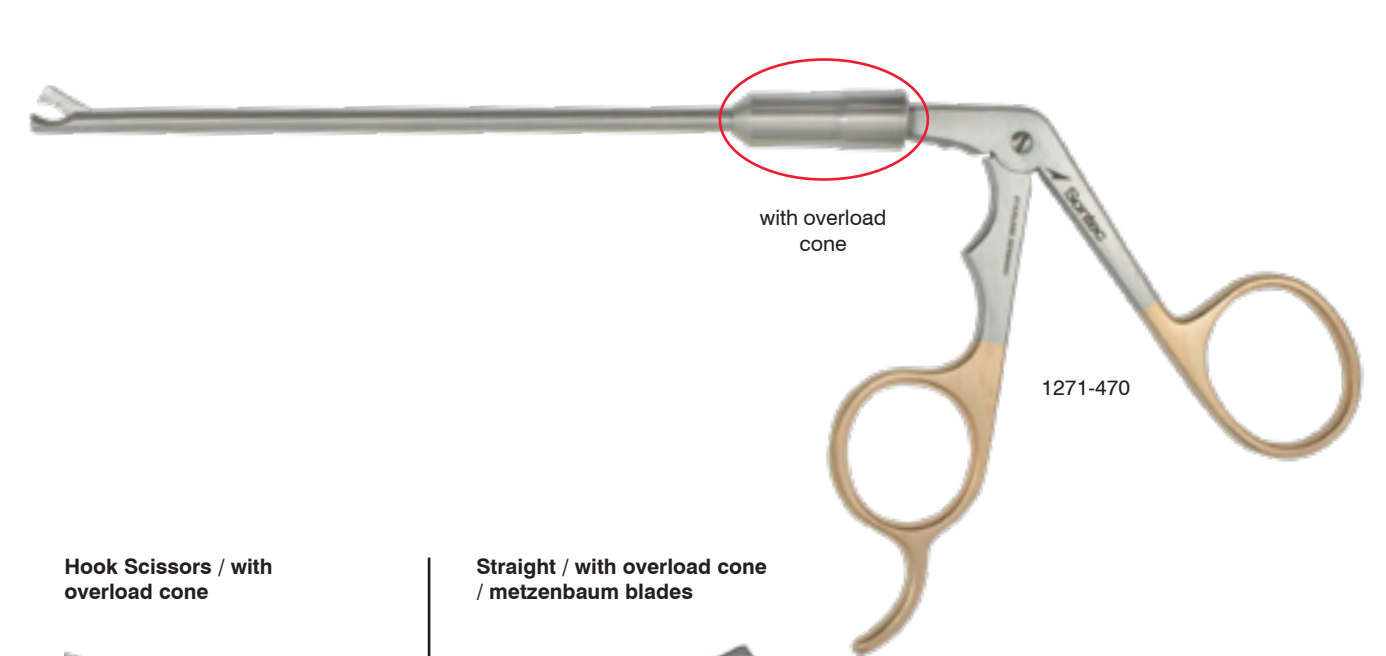

with overload cone

1271-470

**Hook Scissors / with overload cone**



**Straight / with overload cone / metzenbaum blades**



**2.7 mm**

- 1271-450 straight
- 1271-451 30° left
- 1271-452 30° right
- 1271-453 45° left
- 1271-454 45° right

**3.4 mm**

- 1271-550 straight
- 1271-551 30° left
- 1271-552 30° right
- 1271-553 45° left
- 1271-554 45° right
- 1271-555 15° curved up

**3.4 mm**

- 1271-460 straight
- 1271-461 30° left
- 1271-462 30° right
- 1271-463 45° left
- 1271-464 45° right

**4.5 mm**

- 1271-470 straight
- 1271-471 30° left
- 1271-472 30° right
- 1271-473 45° left
- 1271-474 45° right

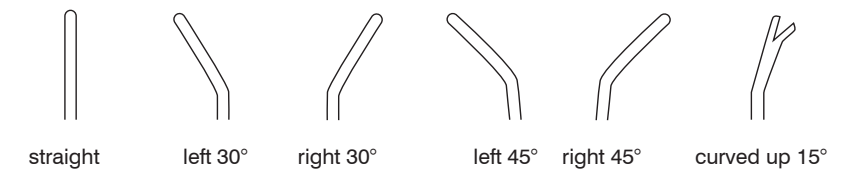

**Arthroscopic Biopsy & Grasping Rongeur**

7" (18 cm)

2.7mm - custom size / please call Sontec for availability

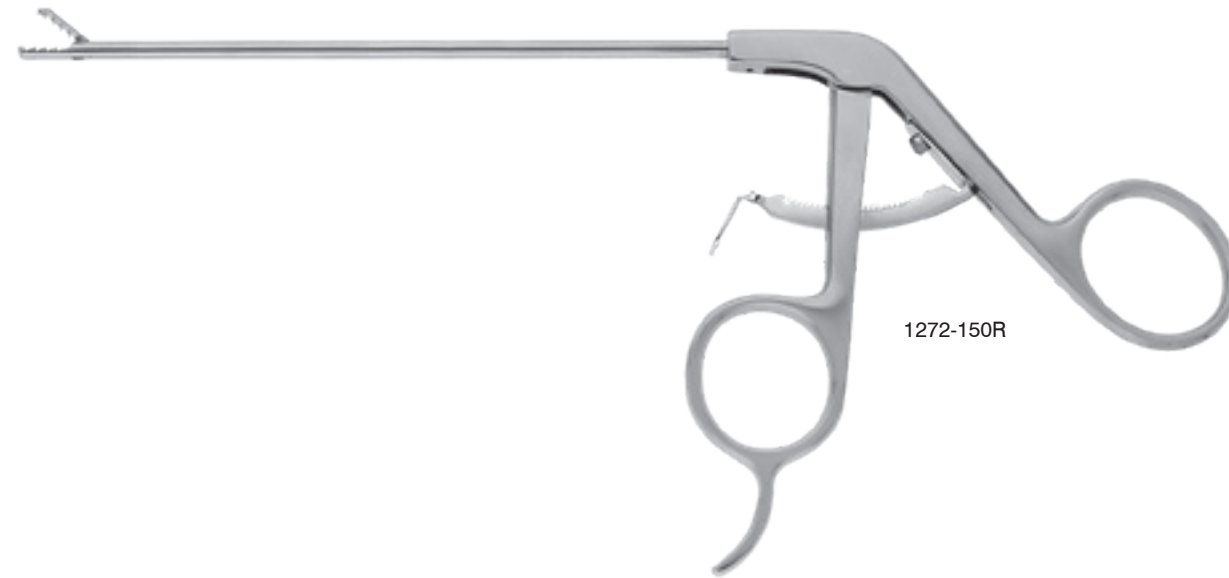

1272-150R

1x2 teeth / with ratchet handle



2.7 mm  
1272-150R

3.4 mm  
1272-151R

Grasping forceps / with ratchet handle



2.7 mm  
1272-146R

3.4 mm  
1272-147R

Biopsy spoon forceps / with ratchet handle



3.4 mm  
1272-155R

1x2 teeth / with ratchet handle



2.7 mm  
1272-148R

3.4 mm  
1272-149R

Biopsy grasping forceps / with ratchet handle



2.7 mm  
1272-152R

3.4 mm  
1272-153R

**Arthroscopic, Forceps, Biopsy & Grasping Rongeur Forceps**

Biopsy grasper forceps / tubular shaft / serrated bite

- 1271-020 2.0 mm cup 4" (10 cm) shaft
- 1271-016 2.7 mm cup 4" (10 cm) shaft
- 1271-018 3.4 mm cup 4" (10 cm) shaft
- 1271-021 2.0 mm cup 6" (15.5 cm) shaft
- 1271-021A 2.0 mm cup 6" (15.5 cm) shaft rear actuator hand

\* Available in 4.5 mm, please ask for details

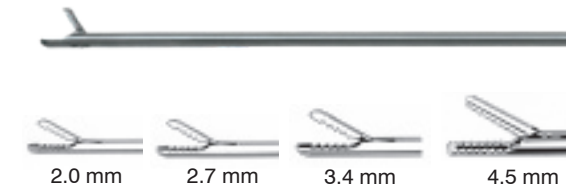

2.0 mm 2.7 mm 3.4 mm 4.5 mm

Tubular 4" (10.2 cm) shaft / 2.0 mm jaws

- 1271-005 grasping forceps
- 1271-005A grasping forceps rear actuator handle 6"
- 1271-006 fine scissors
- 1271-007 basket punch
- 1271-008 round cup biopsy rear actuator handle
- 1271-009 round cup biopsy

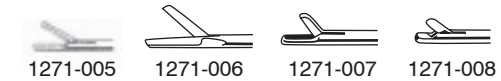

1271-005 1271-006 1271-007 1271-008

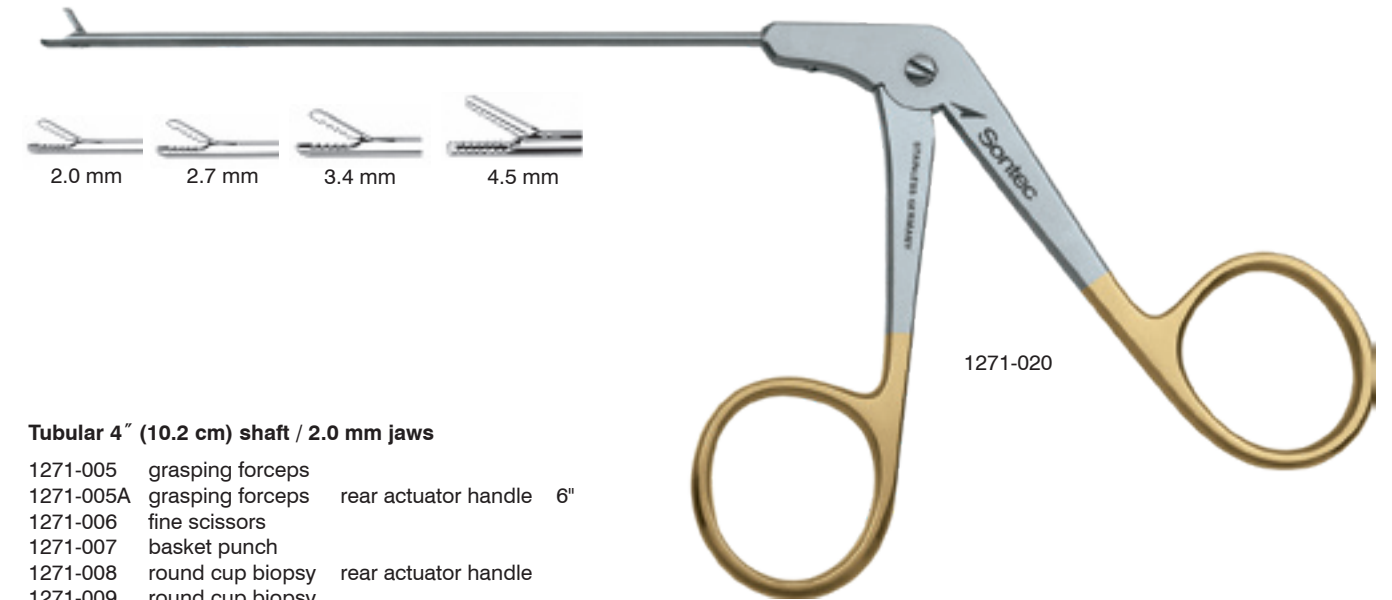

1271-020





















1271-005A

All tubular shaft instruments available upon request with rear actuator handles

**Arthroscopic Punch & Scissors**

Overload cone for added strength / 5 3/4" (14.5 cm)  
shaft measurement is from jaw to overload cone

		Straight	Left 30°	Right 30°	Left 45°	Right 45°	wCurved Up 15°
							
<b>Square Punch</b>	2.7 mm 	1271-350	1271-351	1271-352	1271-353	1271-354	1271-355
	3.4 mm 	1271-360	1271-361	1271-362	1271-362	1271-364	1271-365
<b>Hook Punch with Sccep</b>	2.7 mm 	1271-370	1271-371	1271-372	1271-373	1271-374	1271-375
	3.4 mm 	1271-380	1271-381	1271-382	1271-383	1271-384	1271-385
	4.5 mm 	1271-390	1271-391	1271-392	1271-393	1271-394	1271-395
<b>Basket Punch</b>	3.4 mm 	1271-400	1271-401	1271-402	1271-403	1271-404	
		1271-410	1271-411	1271-412	1271-413	1271-414	
	4.5 mm 						
<b>Hook Punch</b>	2.7 mm 	1271-420	1271-421	1271-422	1271-423	1271-424	1271-425
	3.4 mm 	1271-430	1271-431	1271-432	1271-433	1271-434	1271-435
	4.5 mm 	1271-440	1271-441	1271-442	1271-443	1271-444	1271-445
<b>Hook Scissors</b>	2.7 mm 	1271-450	1271-451	1271-452	1271-453	1271-454	
	3.4 mm 	1271-460	1271-461	1271-462	1271-463	1271-464	
	4.5 mm 	1271-470	1271-471	1271-472	1271-473	1271-474	



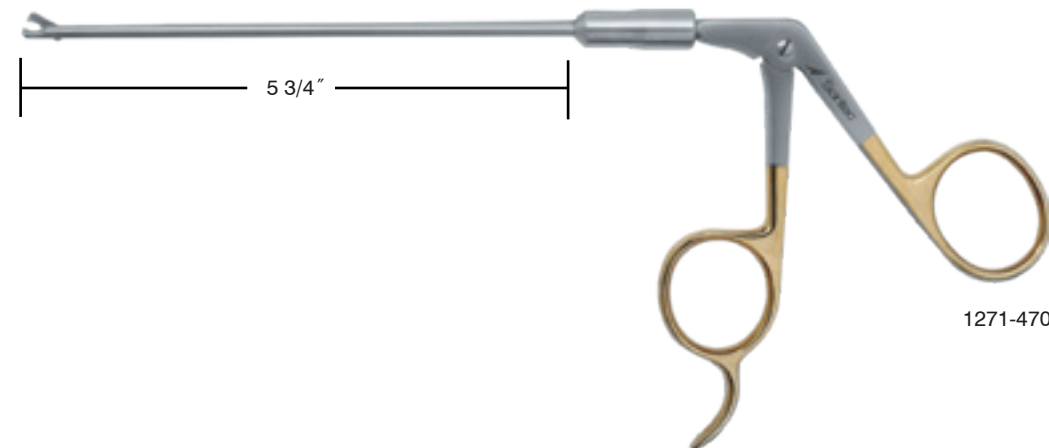







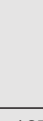

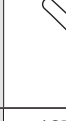
continues on next page



1271-470

**Arthroscopic Punch Rongeur**

Overload cone for added strength / 5 3/4" (14.5 cm)  
shaft measurement is from jaw to overload cone

		Straight	Left 30°	Right 30°	Left 45°	Right 45°	wCurved Up 15°
							
<b>Hook Punch with Mini Jaw</b>	2.7 mm 	1271-480	1271-481	1271-482	1271-483	1271-484	1271-485
	3.4 mm 	1271-490	1271-491	1271-492	1271-493	1271-494	1271-495
	4.5 mm 	1271-500	1271-501	1271-502	1271-503	1271-504	1271-505
<b>Square Bite / curved up</b>	3.4 mm 	1271-510	1271-511	1271-512	1271-513	1271-514	1271-515
<b>Square Bit / curved up 15°</b>	3.4 mm 	1271-520	1271-521	1271-522	1271-523	1271-524	1271-525
<b>Side punch / left</b>	3.4 mm 	1271-530	1271-531	1271-532	1271-533	1271-534	1271-535
<b>Side Punch / right</b>	3.4 mm 	1271-540	1271-541	1271-542	1271-543	1271-544	1271-545
<b>Scissor, / straight</b>	3.4 mm 	1271-550	1271-551	1271-552	1271-553	1271-554	1271-555

**Triangle Handle Arthroscopic Meniscotome, Hook, Probe & Knife**

9 1/4" (23.5 cm) / triangle handle

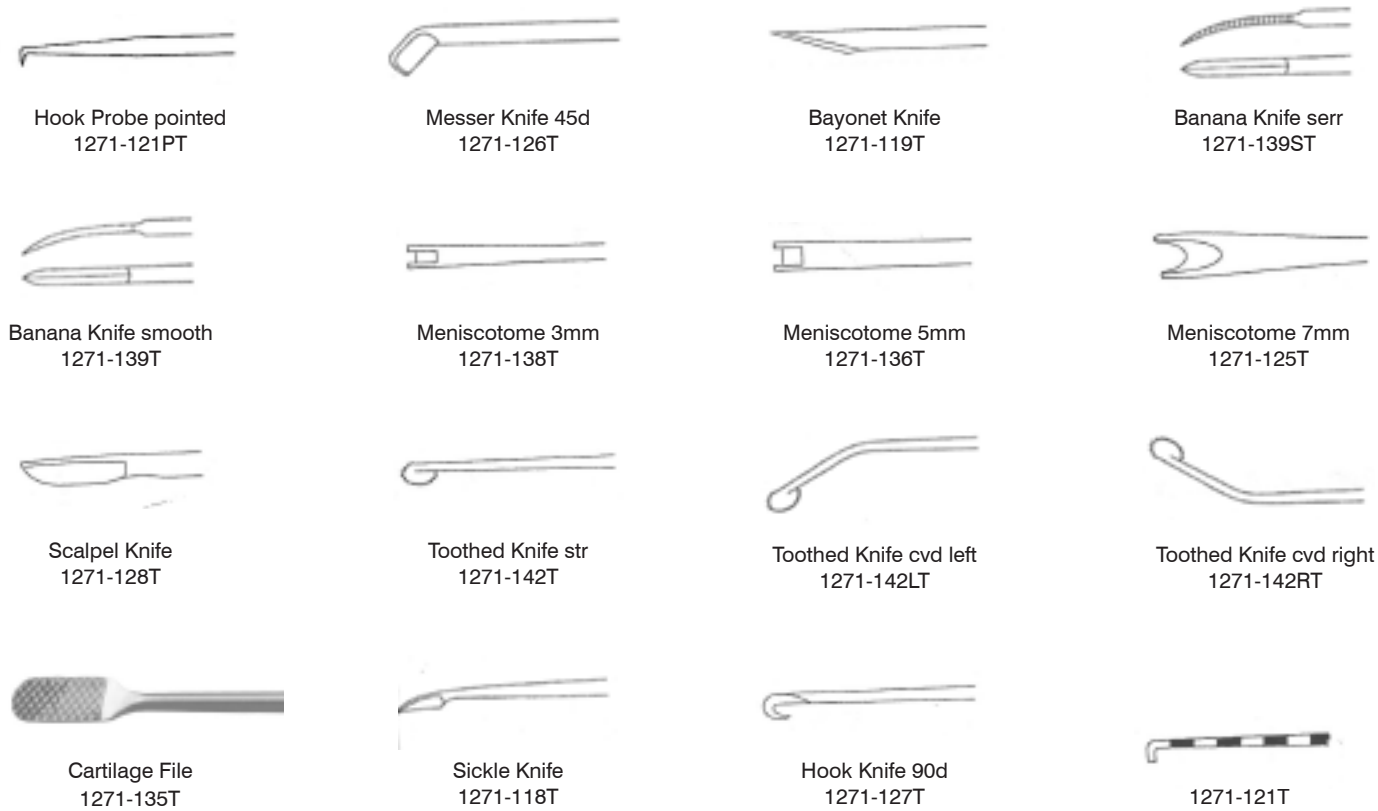

**Arthroscopic Meniscotomes Hook, Probe & Knife**

9" (23 cm) / item numbers followed by "U" fit universal handle. Handle is sold separately / choose either knurled handle or universal handle-shaft combination

1271-143 universal handle sold separately 4 3/4"  
1271-143L universal handle extra long 8" special order

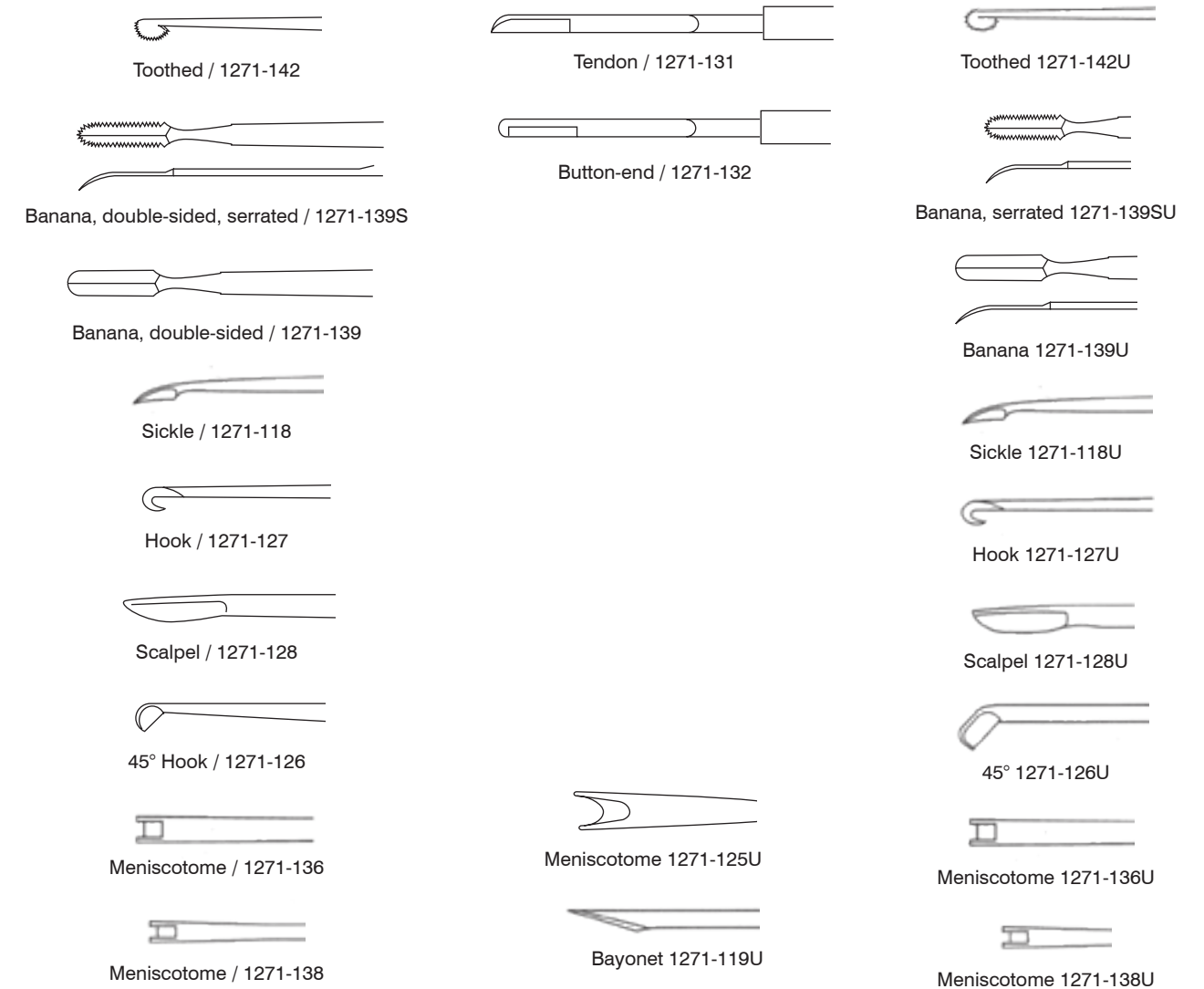

**Arthroscopic Curette & Ring Curette**

**9 1/4" (23.5 cm) / triangle handle**

- 1271-116T 30 degrees
- 1271-148S 3 mm ring tip
- 1271-148T 7 mm ring tip 30°

**9 1/4" (23.5 cm) / triangle handle / 30°**

- 1271-149 5 mm ring tip

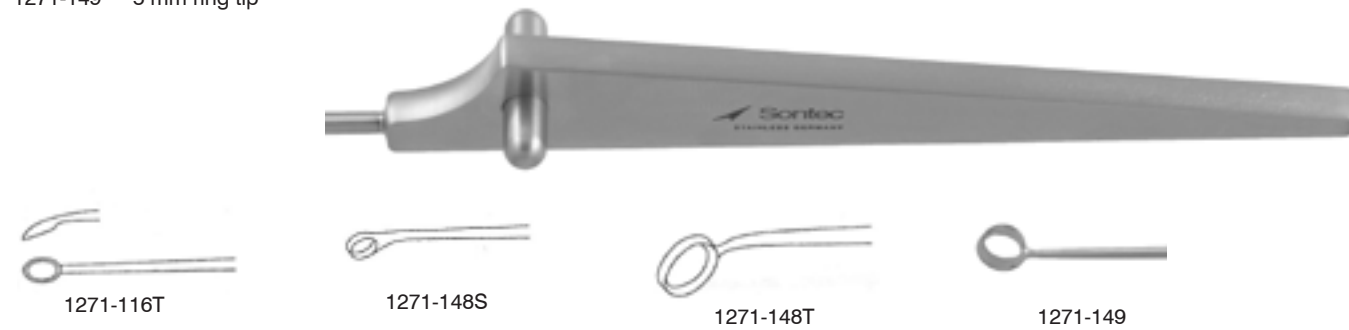

**Knurled handle / 3 mm / 9" (23 cm)**

- 1271-115 30° curved curette
- 1271-140 right angled sharp ring tip

**"U" Fit universal handle / 3 mm / 9" (23 cm)**

- 1271-116U 30° curved curette
- 1271-140U right angled sharp ring tip

**Universal handle sold separately**

- 1271-143 universal handle sold separately

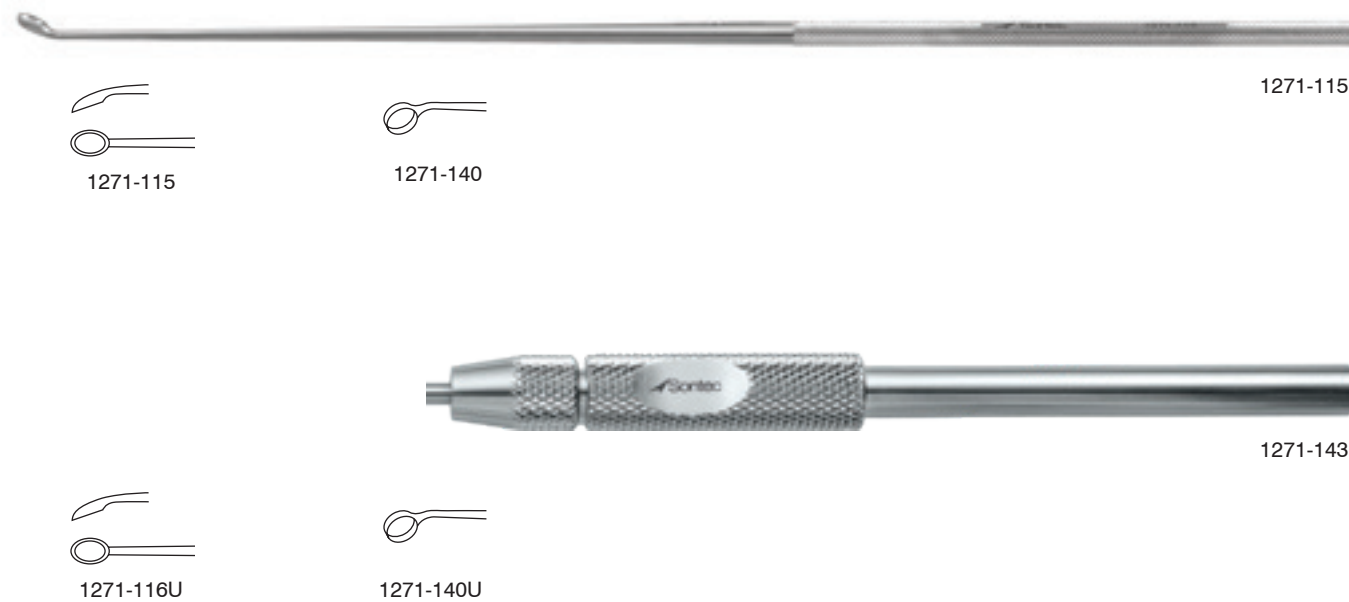

**Arthroscopic Hook Probe**

**9" (23 cm)**

- 1271-121 3.5 mm knurled handle
- 1271-122 2.5 mm knurled handle
- 1271-122U 2.5 mm for universal handle
- 1271-121U 3.5 mm for universal handle
- 1271-1204U 4 mm for universal handle
- 1271-120U 5 mm for universal handle

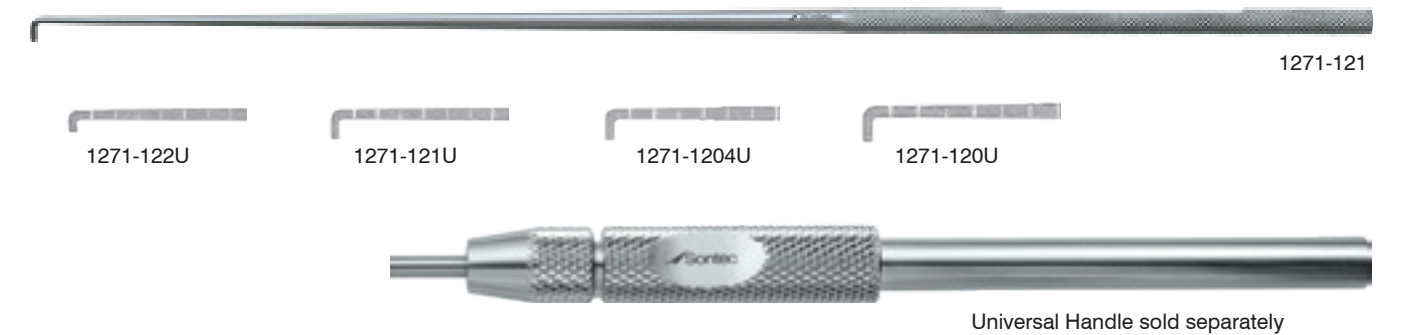

**Arthroscopic Rasp**

**Item numbers followed by "U" fit universal handle / 9" (23 cm)**

- 1271-134
- 1271-143 universal handle sold separately

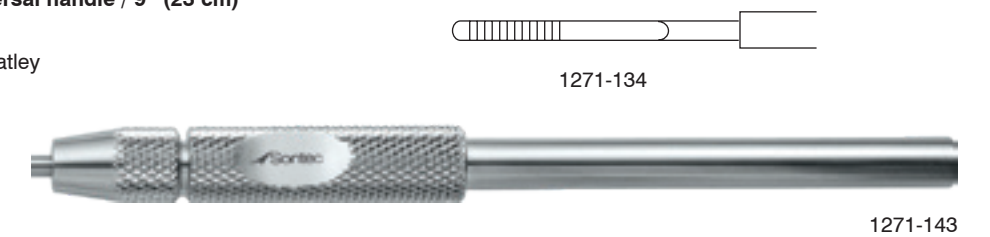

**Arthroscopic Hook Probe with Conical Handle**

**3.5 mm tip**

- 1271-121A 4 1/2"
- 1271-121B 6"
- 1271-121C 7 1/2"

**4 mm tip Ø**

- 1271-1218 8 1/4"



**McIlwraith Arthroscopic Hook Probe**

Graduated / light / 9 1/2" (24 cm)

1271-129



1271-129

Graduated / heavy / 10 1/2" (26 cm)

1271-130



1271-130

Phenolic handle / 10 1/4" (26 cm)

1271-130PH



1271-130PH

**Taylor Micro Arthroscopic Hook Probe & Pick**

1.2mm / 8" (20 cm)

1271-120 straight  
1271-123 curved

3 mm hook / 1 mm ball tip / lightweight type handle / 8 1/2" (21.5 cm)

1271-123LW



1271-123



1271-120



1271-123LW

**Arthroscopic Rasp**

Item numbers followed by "U" fit universal handle / 4x6 mm / 9" (23 cm)

1271-133U straight  
1271-133AU 15° angle  
1271-143 universal handle sold separately



1271-133U



1271-143

**Bone Pick Micro Fracture**

Phenolic handle / 30° tip

1271-320 6 7/8" (17.5 cm) mini  
1271-330 7 1/2" (19 cm) peterson  
1271-325 10 3/4" (27.5cm) equine

Phenolic handle / 60° tip

1271-321 6 7/8" (17.1 cm)  
1271-322 7 1/2" (19.1 cm)  
1271-326 10 3/4" (27.3 cm)

Phenolic handle / 90° tip

1271-323 6 7/8" (17.1 cm)  
1271-324 7 1/2" (19.1 cm)  
1271-327 10 3/4" (27.3 cm)



1271-325



1271-330



1271-320

**Egress Cannula Set**

Cutting obturator / lateral irrigation holes / 2 3/4" (7 cm) working length / set includes a sharp and blunt cannula

SC95-0310-SET	3.2 mm diameter	without stop cock	special order
SC95-0315-SET	3.2 mm diameter	with stop cock	
SC95-0415-SET	4.5 mm diameter	with stop cock	

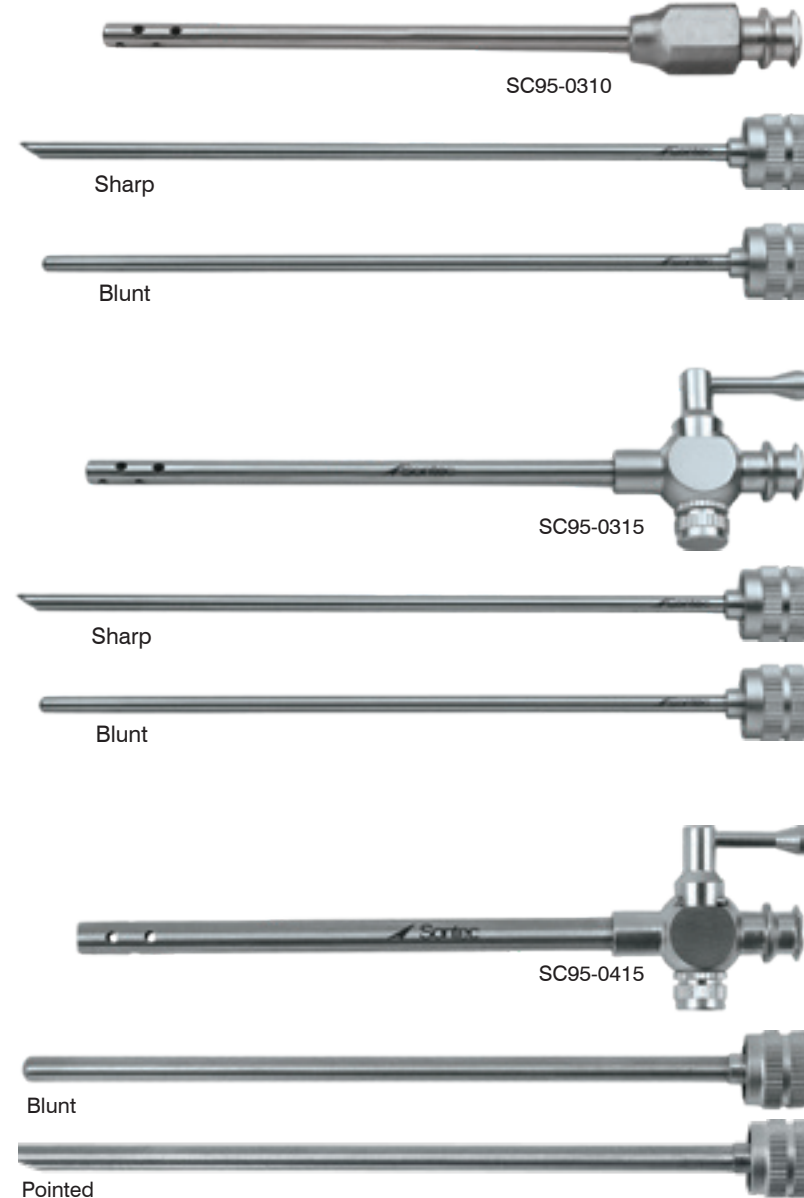

**Egress Cannula Set**

With conical obturator / 6" (15.2 cm) working length

SC94-0312	3.1 mm ID
SC94-0313	4.1 mm ID
SC94-0314	5.1 mm ID
SC94-0315	6.1 mm ID
SC94-03157	7.1 mm ID
SC94-03158	8.1 mm ID
SC94-03159	9.1 mm ID

With Conical obturator / 12" (30.5 cm) working length

SC94-0316	3.1 mm ID
SC94-0317	4.1 mm ID
SC94-0318	5.1 mm ID
SC94-0319	6.1 mm ID
SC94-0320	7.1 mm ID
SC94-0321	8.1 mm ID
SC94-0322	9.1 mm ID

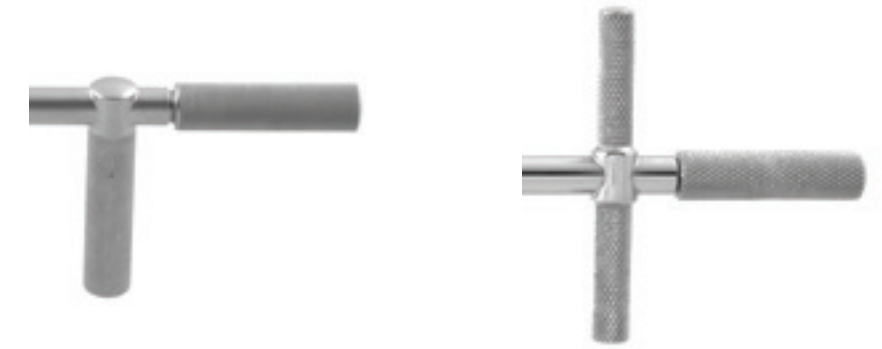

available with T-handle or L-handle shown above

\* CUSTOM - specify size (diameter & length) when ordering



**Arthroscopic Switch Stick**

8 3/4"

1271-117-1	1.1mm
1271-117-5	2.4mm
1271-117-2	2.9mm
1271-117	3.2mm
1271-117-3	3.7mm

Set of 5 / 8 3/4"

1271-117-4	sizes in set:
	1.1mm
	2.4mm
	2.9mm
	3.2mm
	3.7mm



1271-117

**Small Joint Arthroscopic Cannula Switch Stick Set**

Complete with 4 cannulas, 4 switch sticks, cannulated obturator, and lightweight anodized case

SC95-0425

\*Instruments are also available separately

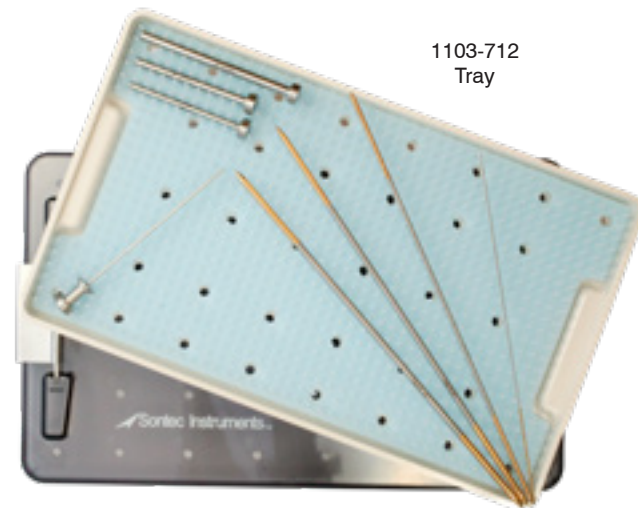

1103-712  
Tray

**Small Joint Arthroscopic Cannula**

- SC95-0421 2.9 mm 2 1/2" (6.5cm)
- SC95-0422 3.7 mm 2 1/2" (6.5cm)
- SC95-0423 4.3 mm 3 1/4" (8.3cm)
- Sc95-0424 5.1 mm 3 1/4" (8.3cm)

**Arthroscopic Cannulated Obturator**

Small joint / 1.3 mm / 4 1/2" (11.5cm)

SC95-0420



SC95-0421

SC95-0422

SC95-0423

SC95-0424

**Arthroscopic Switch Stick**

- 1271-117 3.2mm 8 3/4" (22 cm)
- 1271-117-1 1.1mm 7" (18cm)
- 1271-117-2 2.9mm 8 3/4 (22cm)
- 1271-117-3 3.7mm 8 3/4 (22cm)
- 1271-117-4 complete switch stick set



1271-117

1271-117-1

1271-117-2

1271-117-3

SC95-0420

**Small Joint Complete Arthroscopic Set**

Includes the following instruments

Sc95-0427 complete set

\* instruments are also available separately

Item Number	Description				
1271-020	grasping biopsy forcep	2 mm	serrated	4" (10 cm)	
1271-090	grasping biopsy forcep	2.7 mm	straight	7" (18 cm)	overload cone
1271-060R	grasping forcep with ratchet	2.7 mm	straight	7" (18 cm)	overload cone
1271-480	hook punch with mini jaws	2.7 mm	straight	7" (18 cm)	overload cone
1271-143	universal anthro handle	125 mm			
1271-127U	universal hook probe	3 mm	90°		
1271-139U	universal banana knife				
1271-122U	universal hook probe	2.5 mm	graduated		
1271-121U	universal hook probe	3.5 mm	graduated		
1271-142U	universal toothed knife		straight		
1271-140U	universal ring curette	3 mm	angled		
SC95-0315	irrigation cannula	3.2 mm			with stop cock
1271-117-1	arthroscopic switch stick	1.1 mm		8" (20.3 cm)	
1271-117-2	arthroscopic switch stick	2.9 mm		8" (20.3 cm)	
1271-117-3	arthroscopic switch stick	3.7 mm		8" (20.3 cm)	
SC95-0420	cannulated obturator	1.3 mm		4" (10 cm)	small joint
SC95-0421	arthroscopic cannula	2.9 mm		2 1/4" (6 cm)	small joint
SC95-0422	arthroscopic cannula	3.7 mm		2 1/4" (6 cm)	small joint
SC95-0423	arthroscopic cannula	4.3 mm		3 1/4" (8 cm)	small joint

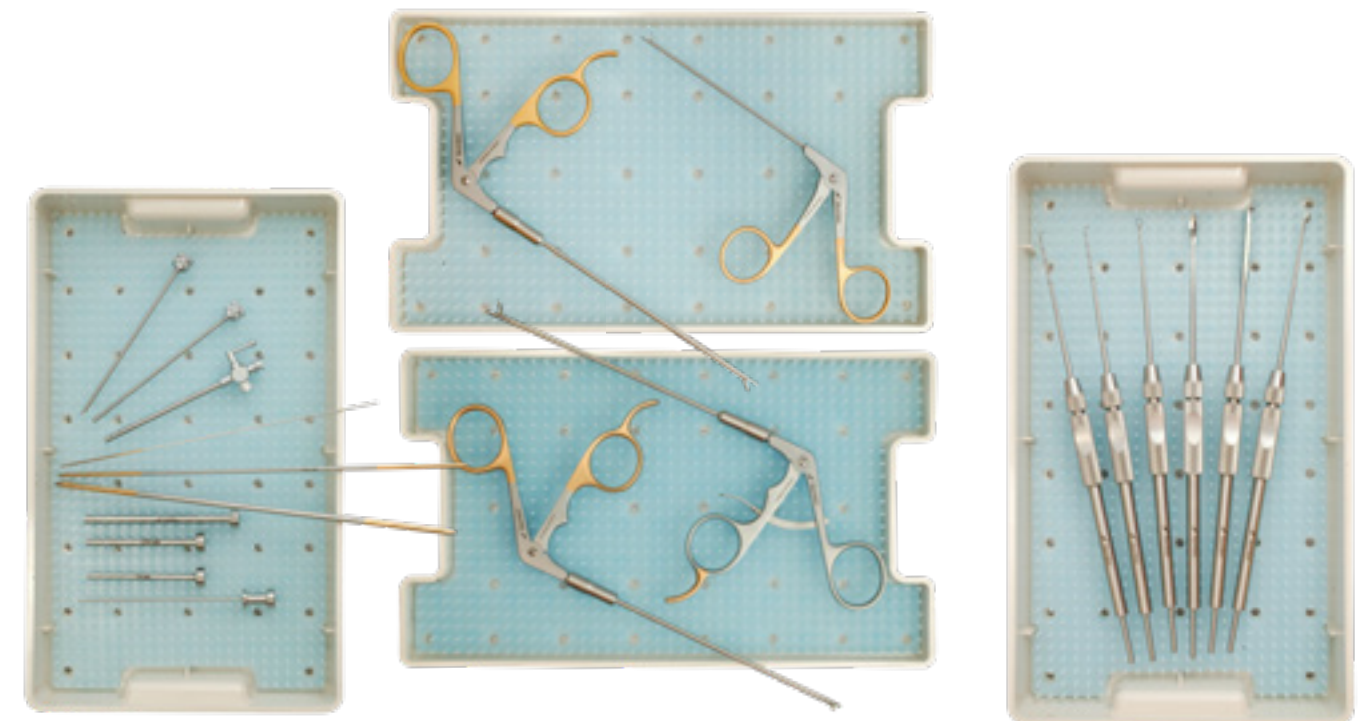

SMALL JOINT INSTRUMENTS

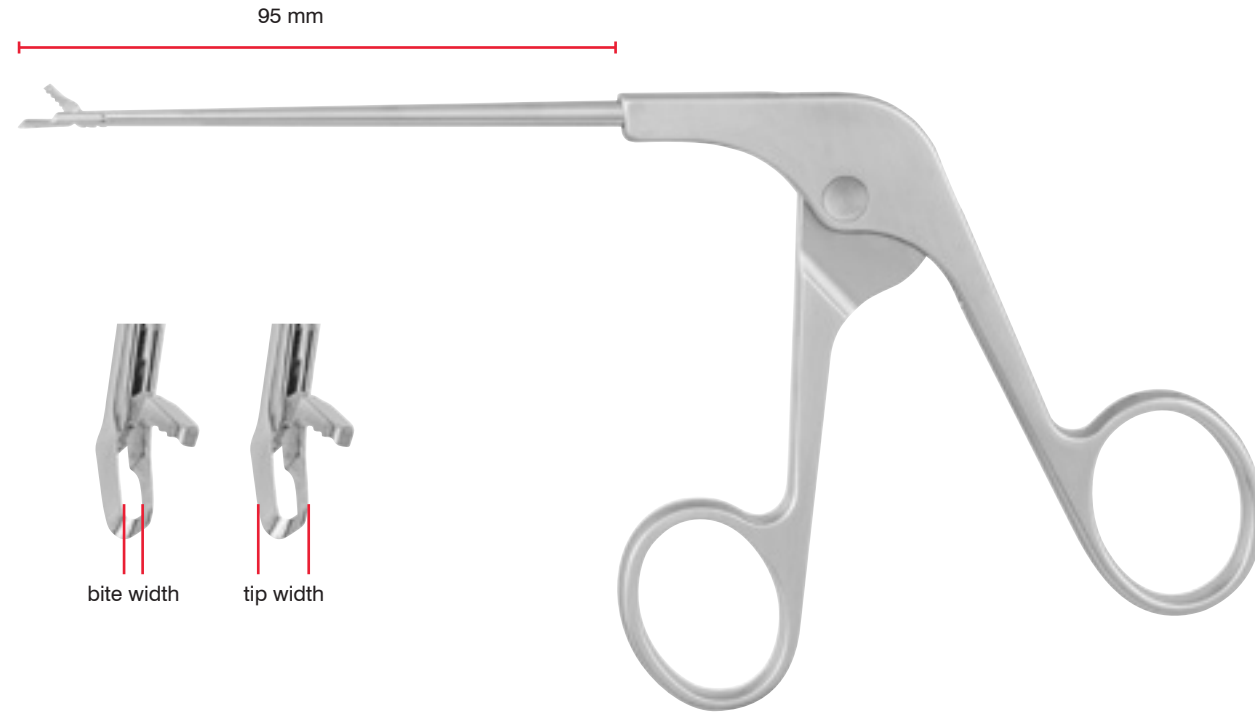

**Straight:** The primary style for direct approach



**Upbiter:** Angled up at the tip



**Upswept:** Angled up on the shaft

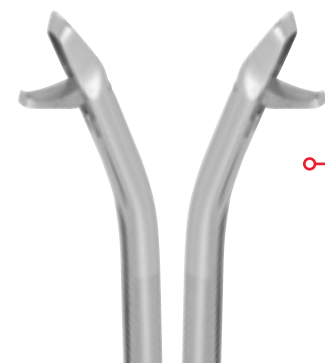

**Curved left and curved right:** Curved on the shaft left or right

SMALL JOINT INSTRUMENTS

Classic Handle

Scissors, basket punches and graspers are equipped with our traditional classic handle



Slide Lock Handle

All graspers are equipped with this infinite position locking handle design



**SMALL JOINT INSTRUMENTS**

Designed especially for small joints, these instruments have shorter stems and smaller jaws to provide ideal access for the elbow, wrist and ankle

**Punch**

**Punch / oval Jr. / 3 3/4" shaft / 2.30 mm bite width / 3.50 tip width / classic handle**

- 1273-151 straight shaft
- 1273-153 left Cvd Shaft
- 1273-152 right Cvd Shaft



**Basket Punch / Jr. / 3 3/4" straight shaft / 2.30 mm bite width / 3.50 tip width / classic handle**

- 1273-150
- 1273-150L left curved shaft



**Basket Punch / Jr. / upbiter / 3 3/4" straight shaft / 2.30 mm bite width / 3.50 tip width / classic handle**

- 1273-154



**Basket Punch / blunt Jr. / 3 3/4" straight shaft / 1.70 mm bite width / 3.00 tip width / classic handle**

- 1273-155



**Scissors**

**Hook Scissors / 3 3/4" straight shaft / classic handle**

- 1273-156



**Rongeur**

**Rongeur Raptor / Jr. / 3 3/4" straight shaft / classic handle**

- 1273-161



**Forceps**

**Grasping Forceps Alligator / Jr. / 3 3/4" straight shaft / slide-lock handle**

- 1273-122



**Grasping Forceps Alligator / Jr. / 1x2 teeth / 3 3/4" shaft / slide-lock handle**

- 1273-123



**SHOULDER INSTRUMENTS**

155 mm



**Straight:** The primary style for direct approach

**Upbiter:** Angled up at the tip

**Upswept:** Angled up on the shaft

**Curved left and curved right:** Curved on the shaft left or right

**Arthroscopic Crocodile Grasping Forceps**

**Straight / 2.7 mm jaw / 5" (13 cm) shaft**

- 1273-112 with locking mechanism
- 1273-113 without locking mechanism



**Arthroscopic Rottweiler Loosebody Grasping Forceps**

**With locking mechanism / 1 x 2 teeth / 2.7 mm / 6 1/2" (16.5 cm)**

- 1273-114 with locking mechanism
- 1273-1141 without locking mechanism



**Rottweiler Junior Loosebody Grasping Forceps**

With locking mechanism / straight / 1 x 2 teeth / 2.7 mm / 5" (12.7 cm)  
1273-115

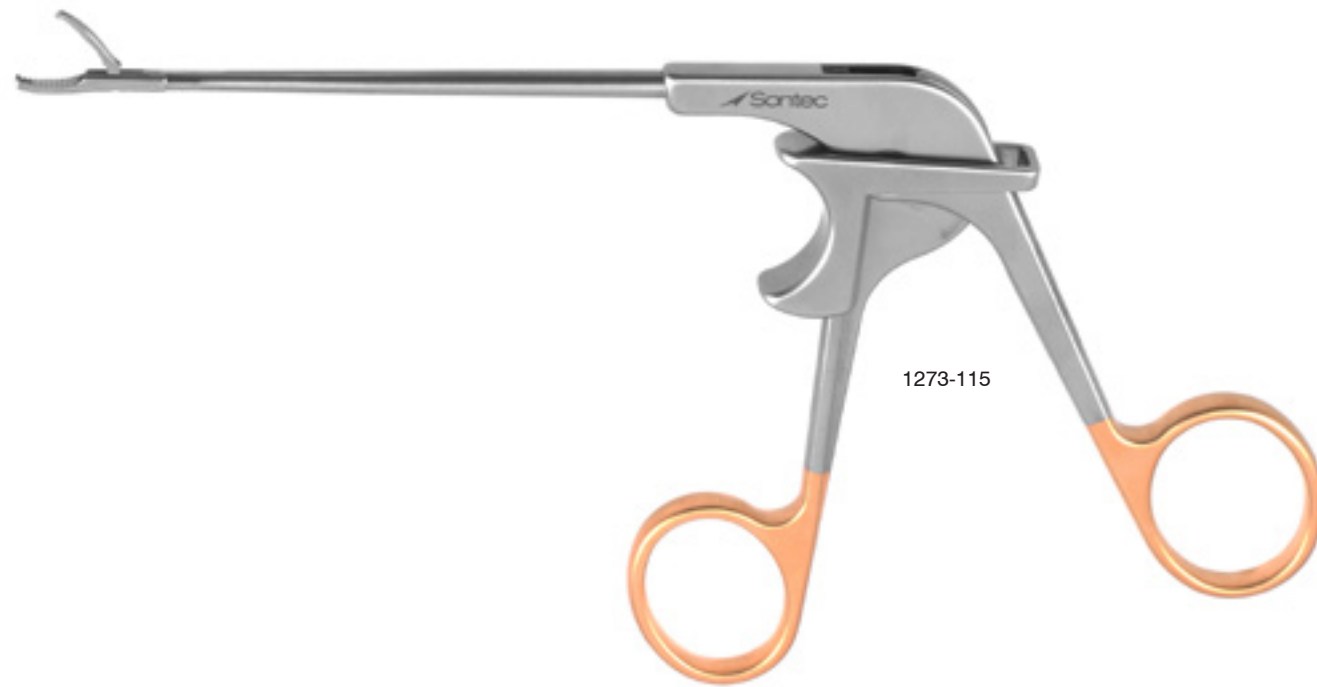

**Arthroscopic Velociraptor Biopsy Forceps**

Straight / 3.4 mm jaw / 5" (13 cm) shaft  
1273-162



**Arthroscopic Velociraptor Junior Biopsy Forceps**

Straight / 2.7 mm jaw / 3 1/2" (9 cm) shaft  
1273-171





 Sontec Instruments®

Bone & NAIL CUTTING Forceps

**Liston Bone Cutting Forceps**

**5 1/2" (14 cm)**

- 315-765 straight
- 315-775 angled

**6 1/2" (16.5 cm)**

- 315-766 straight
- 315-776 angled

**7 1/2" (19 cm)**

- 315-767 straight
- 315-777 angled
- 315-779 angled to side

**8 1/2" (21.5 cm)**

- 315-768 straight
- 315-778 angled



315-776

**Ruskin-Liston Bone Cutting Forceps**

**Double-action**

- 1103-092 straight 5 3/4" (14.5 cm)
- 1103-093 angled 5 3/4" (14.5 cm)
- 1103-094 straight 7 1/4" (18.5 cm)
- 1103-095 angled 7 1/4" (18.5 cm)

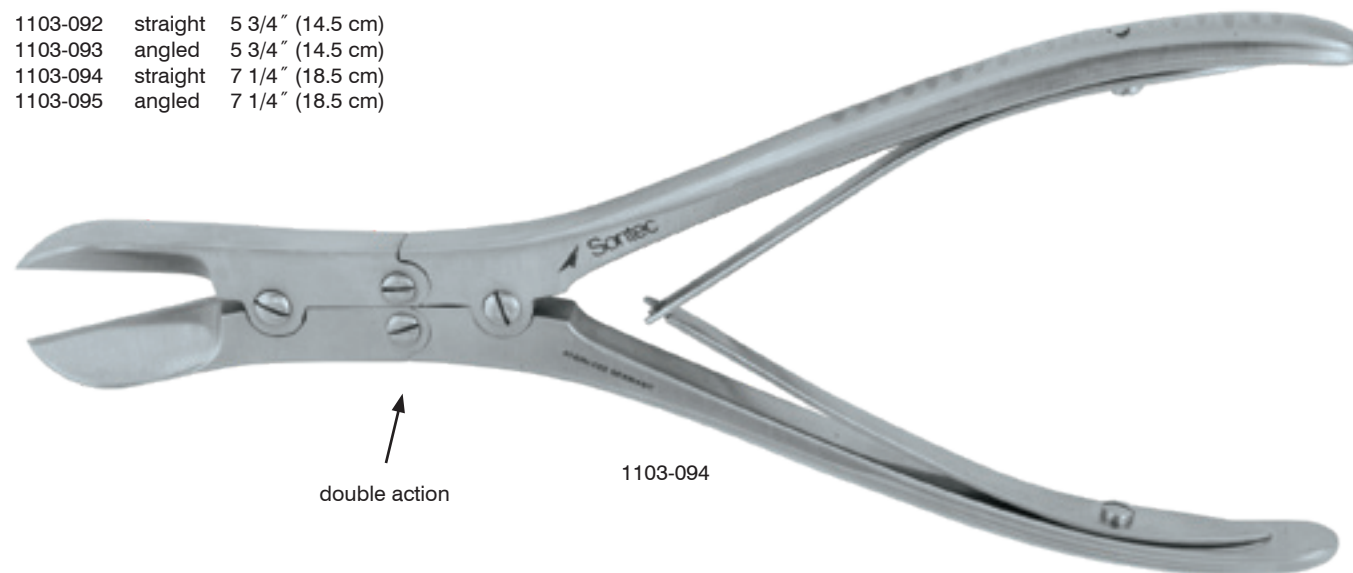

double action

1103-094

**Stille-Liston Bone Cutting Forceps**

**Double-action / 9" (23 cm)**

- 315-752 angled up

**Double-action / 10 1/2" (26 cm)**

- 315-754 straight
- 315-756 angled

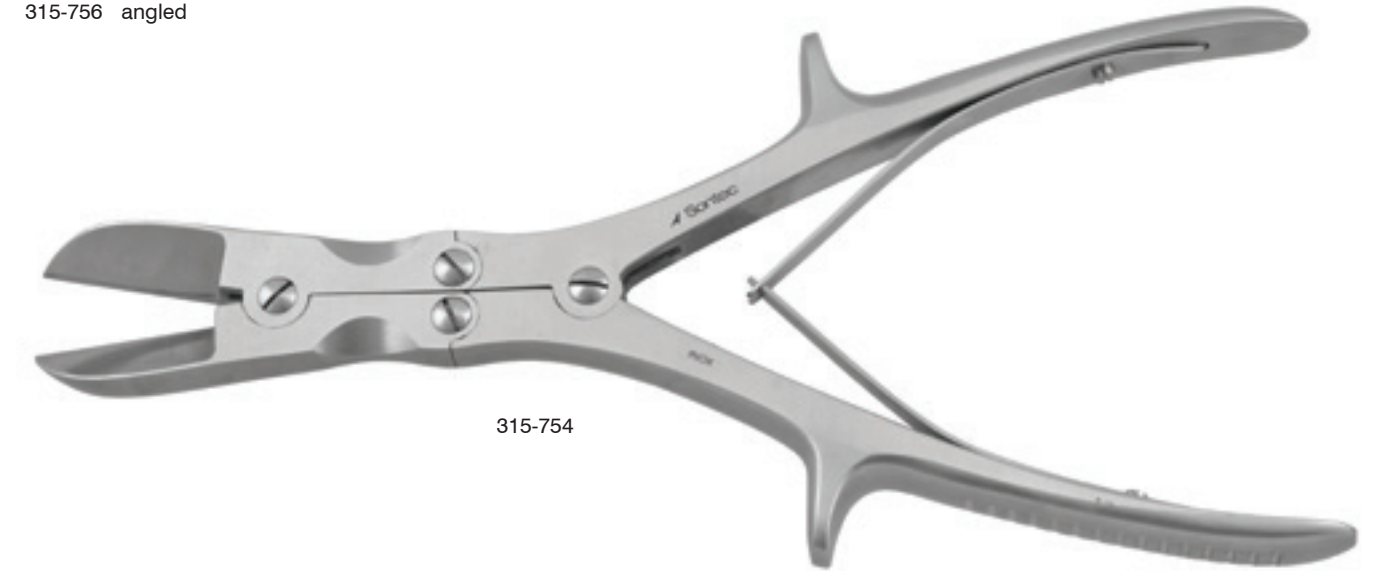

315-754

**McIndoe Bone Cutting Forceps**

**Double-action / angled / 7 1/4" (18.5 cm)**

- 315-781

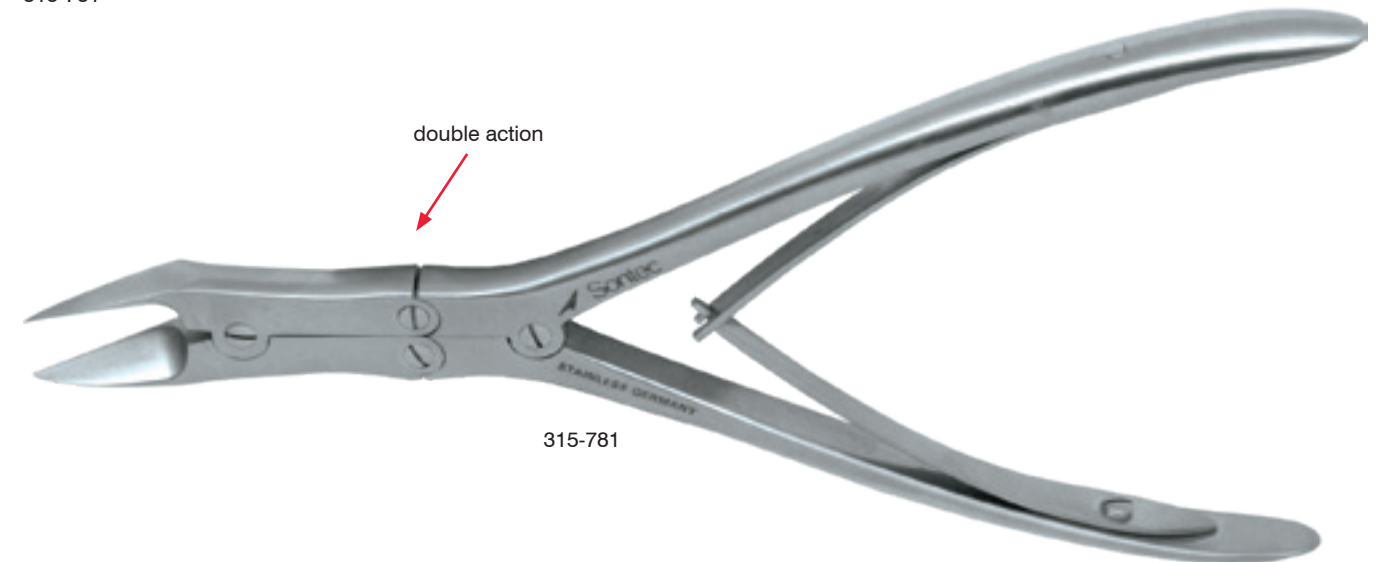

double action

315-781



 Sontec Instruments®

ENT SAWS

**Langenbeck Metacarpal Saw**

Blade length 4 1/4" (10 cm) / 9 1/4" (23.5 cm)

345-212



345-212

**Linderman Amputation Saw**

Blade length 20 cm / 8" (20.5 cm)

345-214



345-214

**Wellenschliff Nasal Saw**

Straight / 7 1/2" (19 cm)

345-248

345-249 round end



345-248



345-249

**Cottle Bone Saw**

AKA Patella Bone Saw / Delrin handle

1103-220-SET includes handle and blade

1103-221 replacement blade only

1103-219 handle only

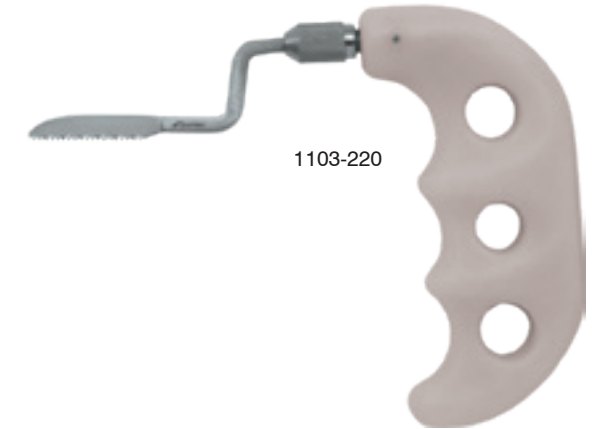

1103-220

**Gigli Saw Blades**

1100-503 12" (30 cm)

1100-504 20" (51.5 cm)

1100-505 30" (76 cm)



1100-503

**Gigli Saw Blade Handle**

Available in pairs

1100-506 loop style

1100-508 T-Handle



1100-508

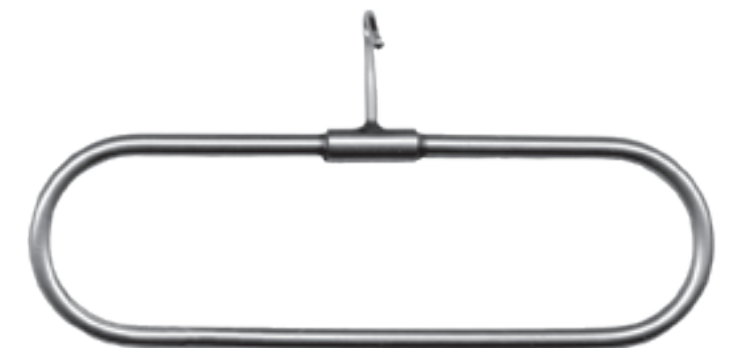

1100-506

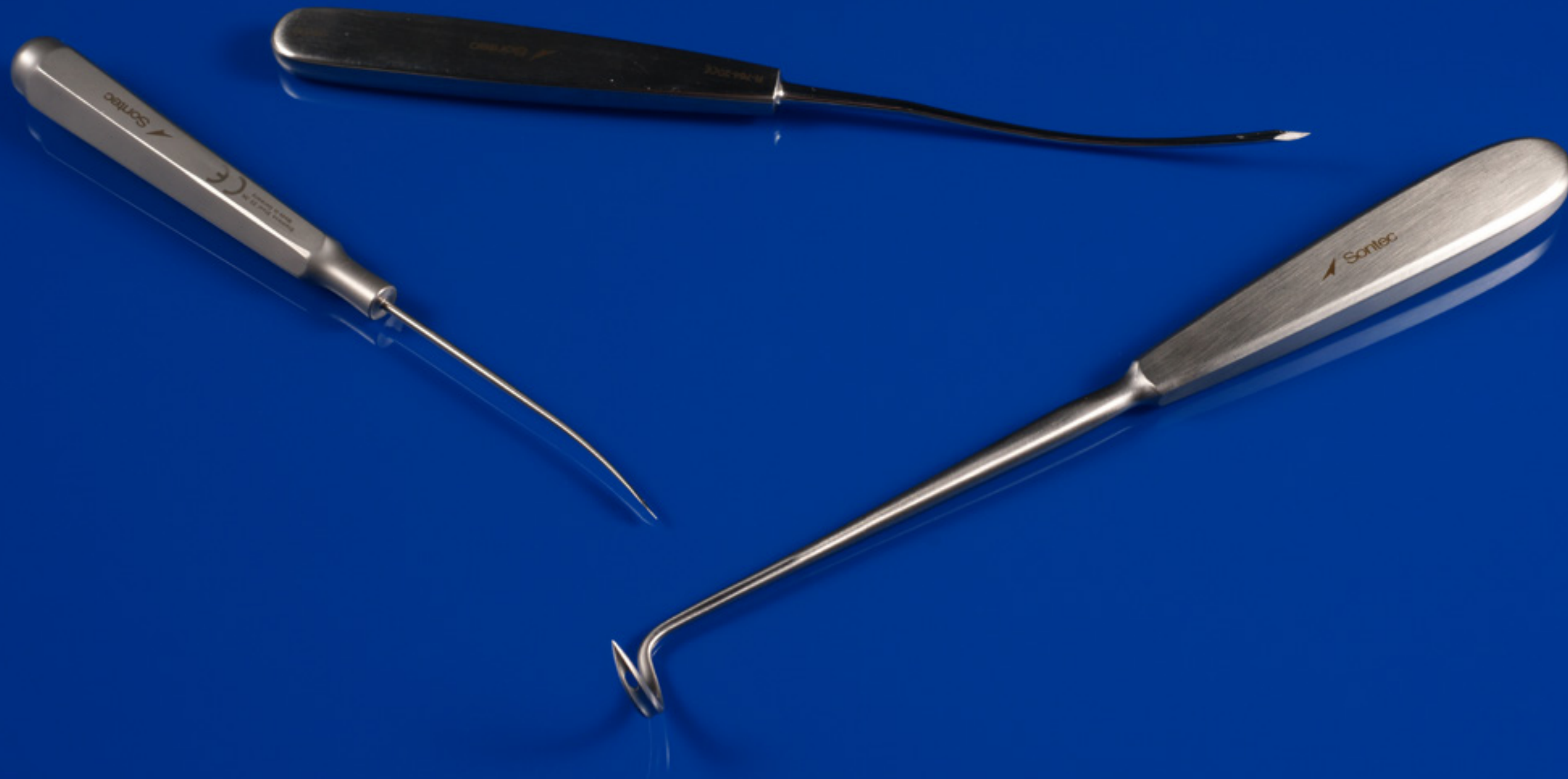

 Sontec Instruments®

Ligature Carriers

**Cassio Ligature Carrier**

Sharp / straight / 8" (20.5 cm)  
134-240

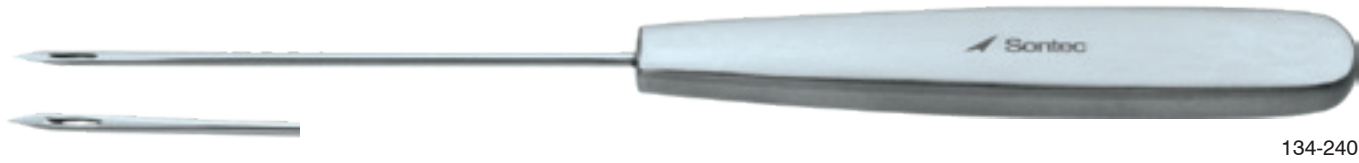

**Sontec Reverdin Blunt Needle/Ligature Carrier**

Blunt / curved / 8" (20.5 cm)  
134-242



**Reverdin Needle/Ligature Carrier**

Sharp / curved / 8" (20.5 cm)  
134-276



**Durrani Dorsal Vein Complex Ligation Needle**

90° sharp / 9" (22.9 cm)  
515-505

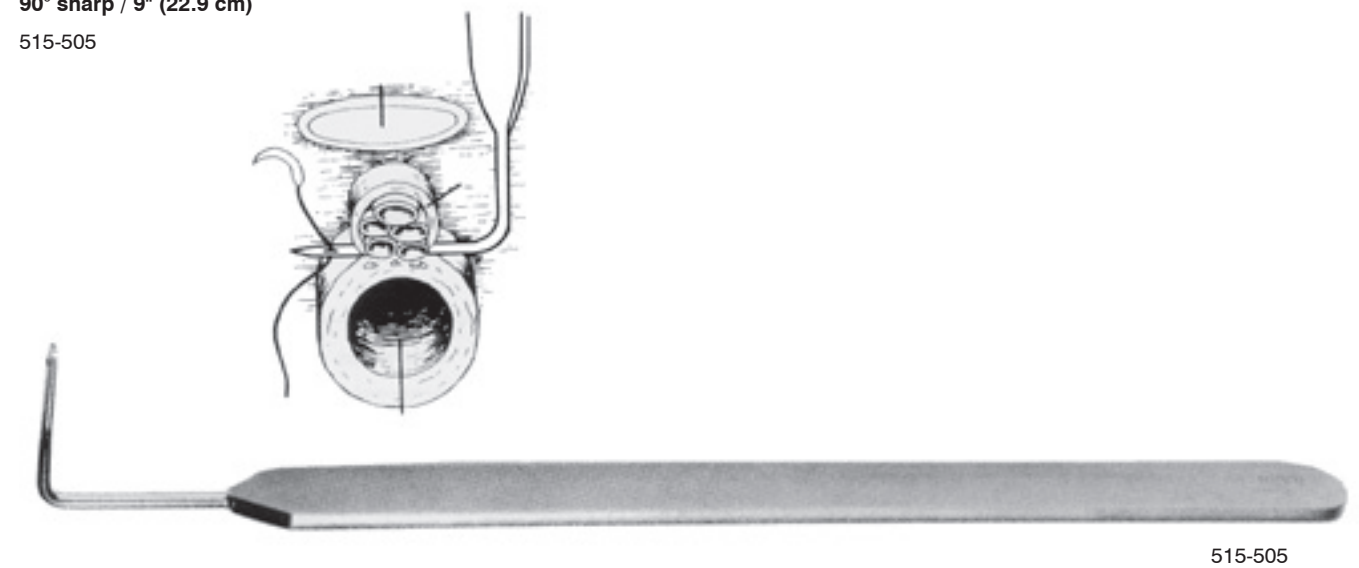

**Tendon Passer Ligature Carrier**

10.5" (26 mm) / 11" phenolic handle  
305-910



**Graft Passer Ligature Carrier**

**Curved**  
1106-400 2 cm extra small  
1106-401 3 cm small  
1106-402 4.5 cm large  
1106-403 6 cm extra large  
1106-404 8cm XX large

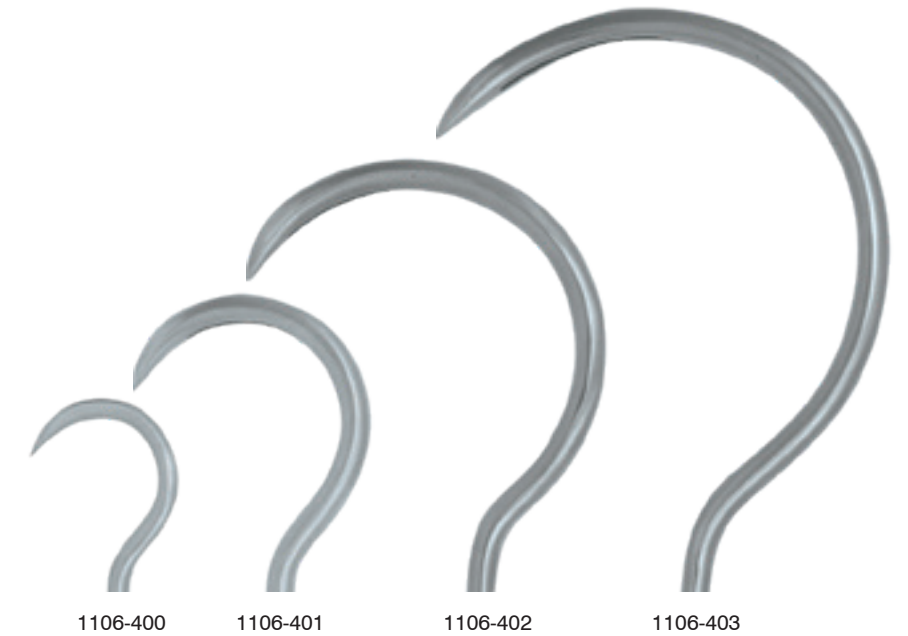

**Deschamps Ligature Carrier**

**Small / 25 mm / 8" (20 cm)**

- 134-277 sharp left
- 134-278 sharp right
- 134-280 blunt left
- 134-281 blunt right



134-278

**Medium / 30 mm / 8" (20 cm)**

- 134-277M sharp left
- 134-278M sharp right
- 134-280M blunt left
- 134-281M blunt right

**Large / 35 mm / 9 1/2" (24 cm)**

- 134-282A sharp left
- 134-282B sharp right



134-277

**Schmieden-Dick Ligature Carrier**

**Malleable / 12 3/4" (32.5 cm)**

- 134-267



134-267

**Entner Ligature Carrier**

**Curved**

- 134-243 8.1/4" (21 cm)
- 134-245 6.1/2" (16.5 cm)



134-243

**Sanders Brown Ligature Carrier**

**10" (25 cm)**

- 134-248



134-248

**Eyebrow Lifting Ligature Carrier**

**11" (28 cm)**

- 134-268



134-268

**Facia Ligature Carrier**

**6" (15 cm)**

- 134-247



134-247



 Sontec Instruments®

RASPS

**Double-Ended Rasp**

Single-sided / 7" (18 cm)

1103-224



**Sontec® Fomon Rasp**

Double-ended / four-sided / 8 1/2" (21.5 cm)

- 1100-492 straight
- 1100-492A straight fine
- 1100-492B one end concave
- 1100-492C one end convex

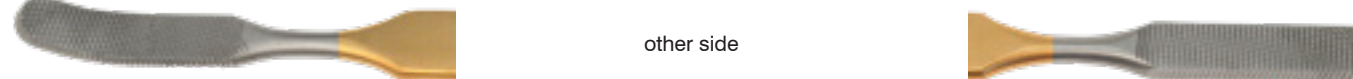
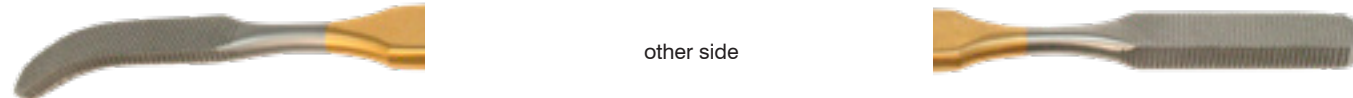

**Fomon Rasp**

Double ended / single-sided / 8 1/2" (21.5 cm)

- 1100-492F straight
- 1100-492G one side concave
- 1100-492D one side convex



**Foman TC Insert Rasp**

TC / double-ended / single-sided / 8 1/2" (21.5 cm)

- 345-289 9 / 10
- 345-287 7 / 8
- 345-285 5 / 6
- 345-283 3 / 4
- 345-282 2 / 3
- 345-281 1 / 2

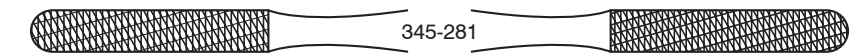
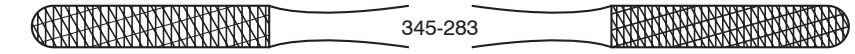
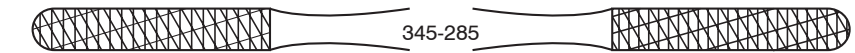
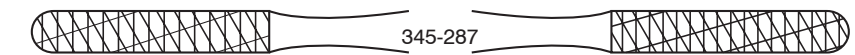
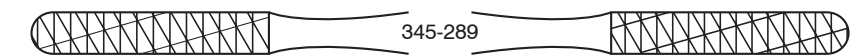

**Miller Cross Serrated Rasp**

Double-ended / cross-serrated / up & down rasping / 7 1/8" (18.25 cm)

- 1103-232 4 mm & 4 mm wide
- 1100-490C 5 mm & 6 mm wide
- 1103-225C 5 mm & 7 mm wide
- 1100-491 6 mm & 7 mm wide

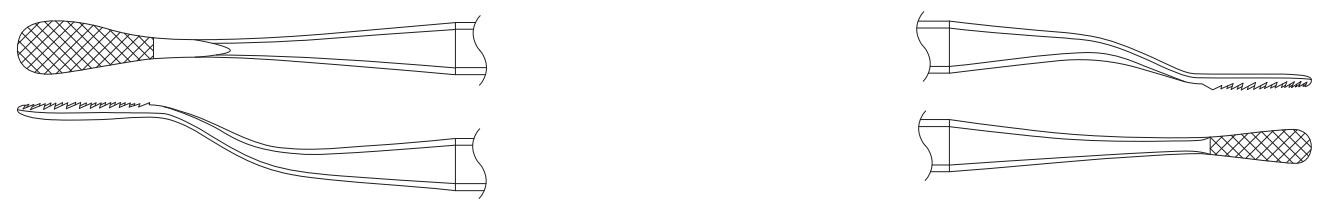

**Miller Parallel Serrated Rasp**

Double-ended / regular cut / down rasping / 7 1/8" (18.25 cm)

- 1103-228 4 mm & 4 mm wide
- 1100-490 5 mm & 5 mm wide
- 1103-238 5 mm & 7 mm wide
- 1103-236 5 mm & 8 mm wide
- 1103-237 6 mm & 7 mm wide

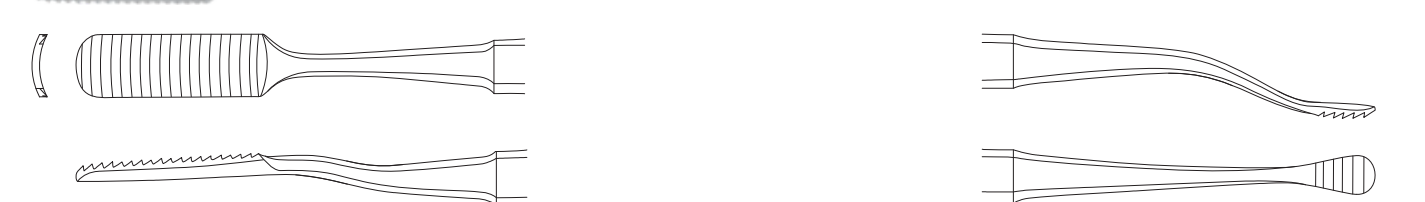

**Sontec Micro Rasp**

Single-ended / double-sided / 5 1/2" (14 cm)

- 345-265 straight 2.1 mm x 30 mm x 1 mm
- 345-264 curved 3.2 mm x 30 mm x 2.5 mm

Single-ended / single-sided / special order

- 345-266 5 1/2" (14 cm) 3 mm x 30 mm x 2.0 mm
- 345-267 7" (18 cm) 3 mm x 30 mm x 2.0 mm



345-265



345-264



345-267

**Nail Rasp**

Single-sided / 6 3/4" (17 cm)

- 345-243



345-243

**Maltz Single-Ended Rasp**

Single-sided / 7" (18 cm)

- 345-310 reverse
- 345-311 forward cut

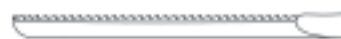

345-310 (reverse)



345-311 (forward cut)



345-310



345-311

**Putti Bone Rasp**

Single-ended / phenolic handle

- 345-226 leaflet 9 3/4" (24.8 cm)
- 345-228 conical 10" (25.4 cm)



345-226



345-228

**Single Side Rasp**

8" / phenolic handle / flat

- 345-222 straight 0.5" x 1.5" tip



345-222

**Combination Bone Rasp**

With 3 interchangeable heads

1100-485-SET

set includes the following:

- 1100-485 combination bone rasp handle only
- 1100-4851 combination bone rasp round tip only
- 1100-4852 combination bone rasp putti leaflet only
- 1100-4853 combination bone rasp flat round tip only



1100-485



1100-4851



1100-4852



1100-4853

**Gallaher Bone Rasp Set**

7 1/8" (18.25 cm)

77-0450 str

77-0451 convex curve

77-0452 concave curve



77-0450



77-0451



77-0452

**Good Bone Rasp**

Conical / 6 1/2" (16.5 cm)

- 345-263 straight
- 345-262 curved



345-263



345-262

**Sontec®-Glabella Sculpting TC Insert Rasp**

TC / 7" (18 cm)

345-246



345-246

**Webster Glabella Sculpting Rasp**

TC serrated tip / 4 mm x 8 mm / 8 1/4" (21 cm)

345-246A



345-246A

**Obwegeser Fenestrated Serrations Rasp**

Double-ended / flat, straight / infinity cut / 7 1/2" (19 cm)

- 345-320 fine grit
- 345-322 medium grit



345-322

Double-ended / flat, curved / infinity cut / 7 1/2" (19 cm)

- 345-324 fine grit
- 345-326 medium grit



345-326

Double-ended / concave / infinity cut / 7 1/2" (19 cm)

- 345-330 fine grit
- 345-332 medium grit



345-332

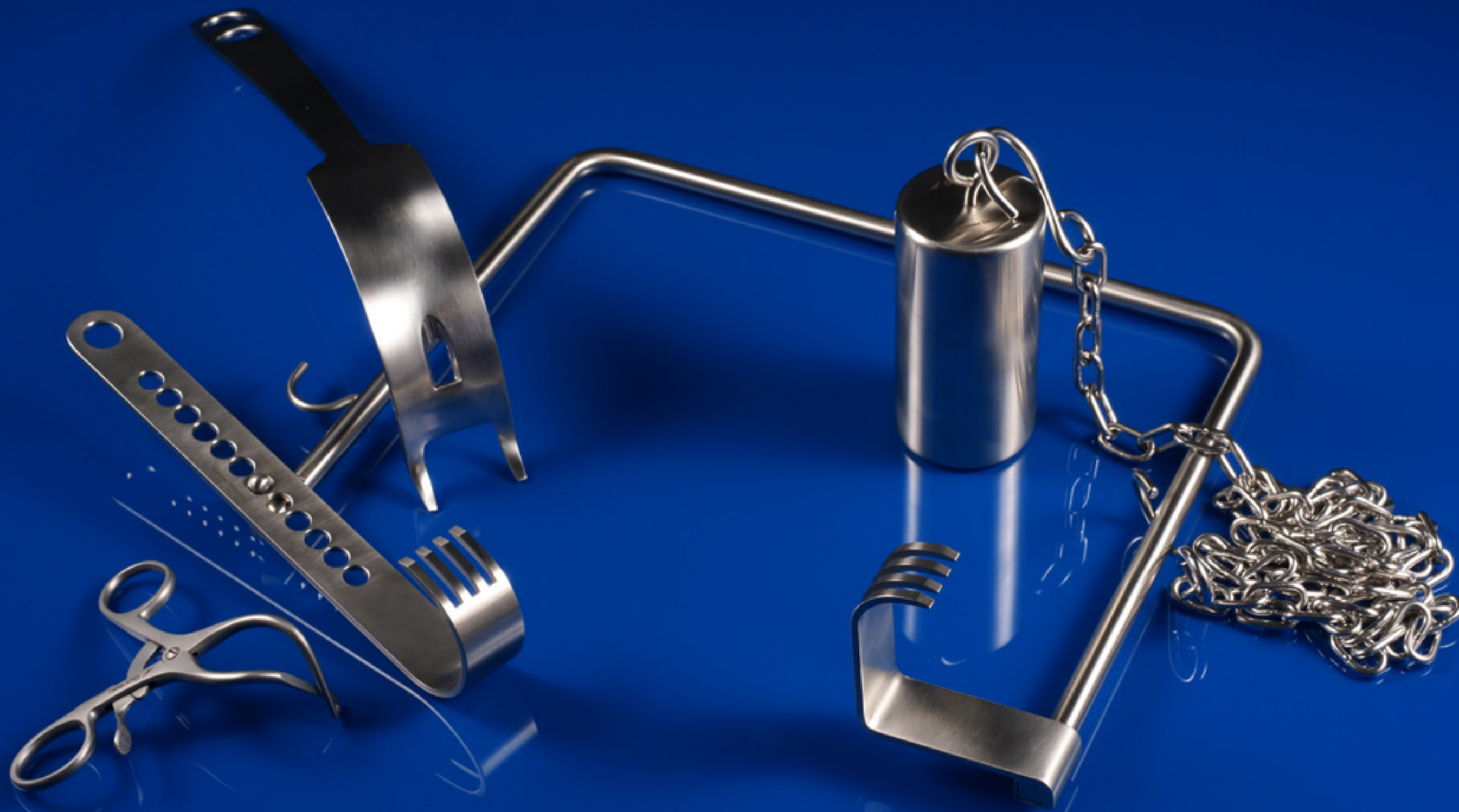

 Sontec Instruments®

Orthopedic RETRACTORS

**Gelpi Deep Angle Retractor**

- 1100-629A 3 1/2"(9 cm)
- 1100-628A 4 1/2"(11.5 cm)
- 1100-628C 5 1/2"(14 cm)
- 1100-631 6 3/4"(17.5 cm)
- 1100-631S 6 3/4"(17.5 cm)
- 4.5 mm prong 3 cm deep
- 1100-631A 7 1/2"(19 cm)
- 1100-631B 8" (20 cm)

\* Custom blunt or shortened tips available upon request



1100-628C

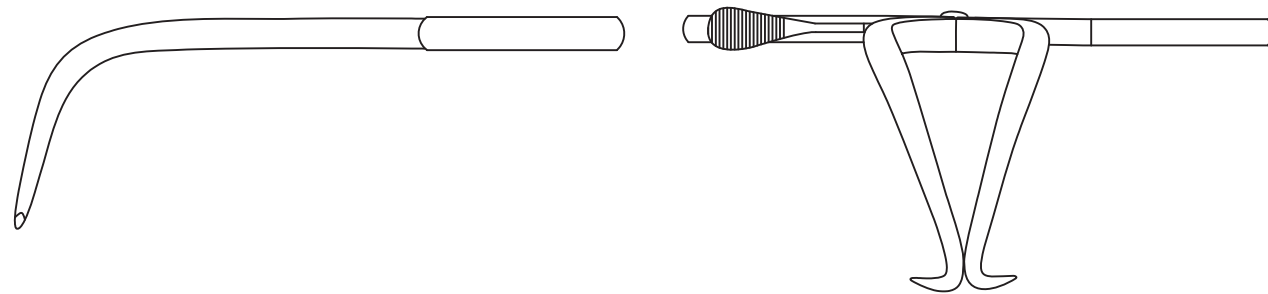

**Gelpi Neroma (Crossover) Retractor**

- 1100-633A 4 1/2" (11.5 cm)
- 1100-633B 3 1/2" (9 cm)
- 1100-633 5 1/2" (14 cm)
- 1100-633C 6 1/2" (16.5 cm)
- 1100-633D 7 1/2" (19 cm)
- 1100-633E 3 1/2" (9 cm) heavy

**Enclosed ratchet version**

- 1100-633BR 3 1/2" (9 cm)

\* Custom blunt or shortened tips available upon request



1100-633A



enclosed ratched

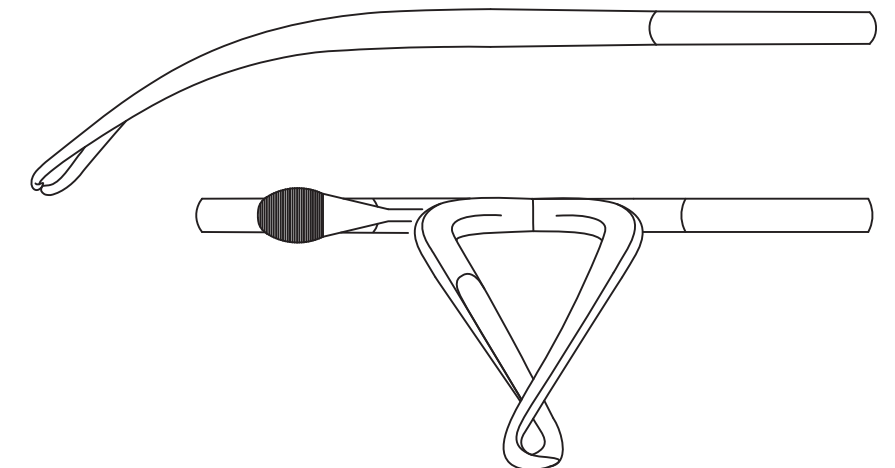

**Gelpi Deep Angle Neroma (Crossover) Retractor**

**Deep angle**

1100-633H	3 1/2" (9 cm)
1100-633G	4 1/2" (11.5 cm)
1100-633F	5 1/2" (14 cm)
1100-633I	6 1/2" (16.5 cm)
1100-632R	6 3/4" (17.5 cm)
1100-630N	7 1/2" (19 cm)
1100-631N	8" (20 cm)

**Enclosed ratchet / deep angle**

1100-633HR	3 1/2" (9 cm)
1100-633GR	4 1/2" (11.5 cm)
1100-633FR	5 1/2" (14 cm)

\* Custom blunt or shortened tips available upon request



enclosed ratched



1100-633G

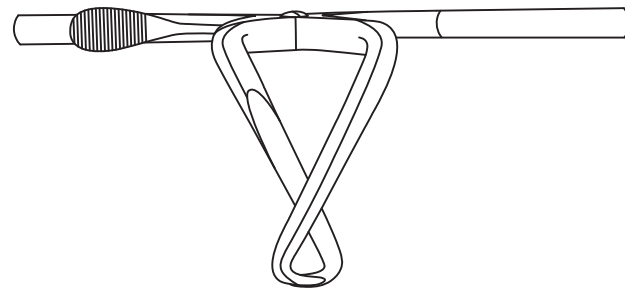
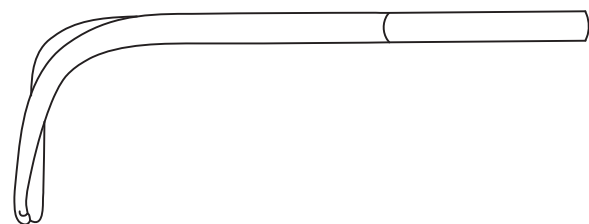

**Gelpi Classic Retractor**

**Standard**

1100-629	3 1/2" (9 cm)	micro
1100-629L	3 1/2" (9 cm)	lightweight
1100-628	3 3/4" (9.5 cm)	heavy
1100-629B	4 1/2" (11.5 cm)	
1100-6280	4 1/2" (11.5 cm)	heavy
1100-628B	5 1/2" (14 cm)	
1100-632	6 1/2" (16.5 cm)	
1100-630	7 1/2" (19 cm)	
1100-630A	8" (20 cm)	

\* Custom blunt or shortened tips available upon request

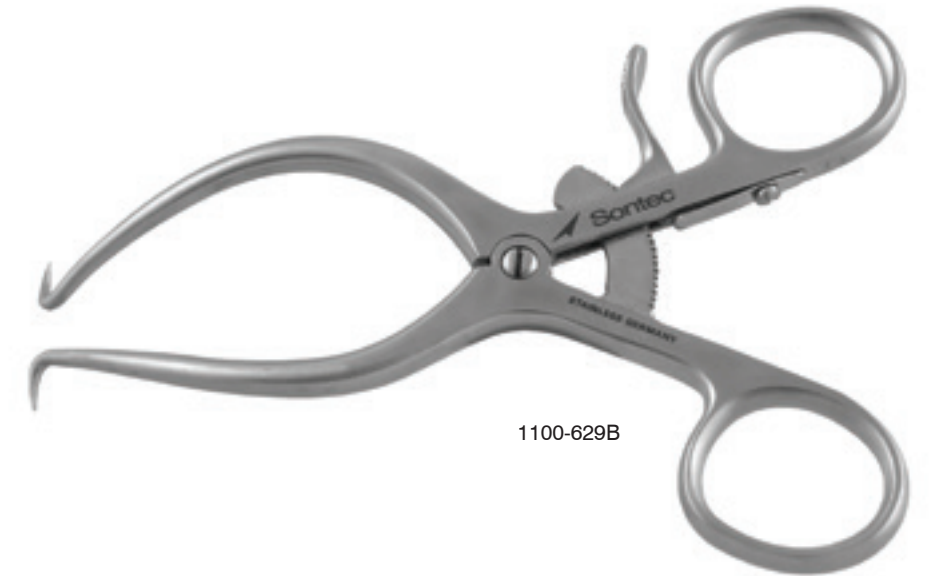

1100-629B

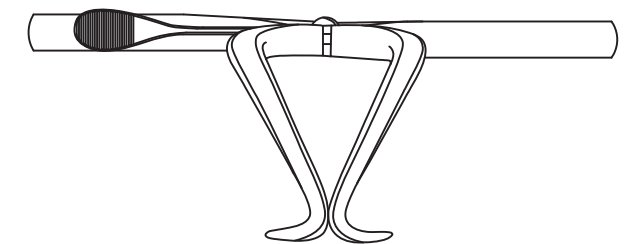
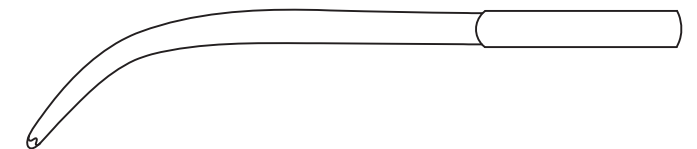

**Gelpi 1st Generation Deep Angle Retractor**

**Original deep angle**

1100-629G	3 1/2" (9 cm)
1100-628G	4 1/2" (11.5 cm)
1100-632G	5 1/2" (14 cm)
1100-631G	6 1/2" (16.5 cm)
1100-630G	7 1/2" (19 cm)

**Original deep angle with enclosed ratchet**

1100-629GR	3 1/2" (9 cm)
1100-628GR	4 1/2" (11.5 cm)
1100-632GR	5 1/2" (14 cm)
1100-631GR	6 1/2" (16.5 cm)
1100-630GR	7 1/2" (19 cm)

\* Custom blunt or shortened tips available upon request

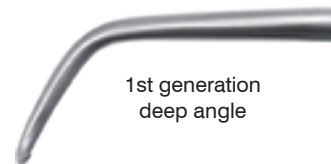

1st generation deep angle



1100-628G



1100-629GR

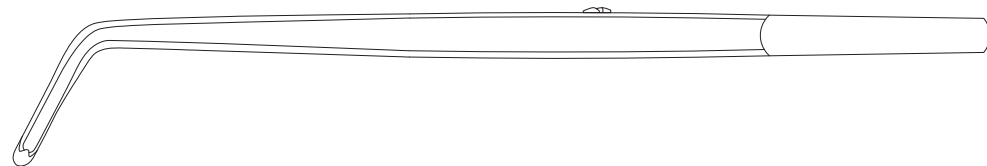
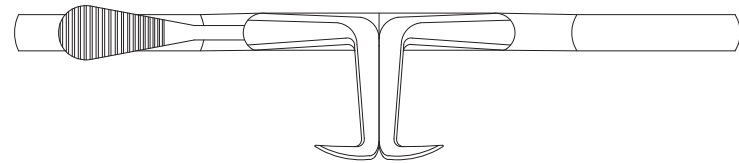

**Davis Stifle Retractor**

With speed lock / 6 3/4" (17 cm)

1103-290

\* Custom blunt or shortened tips available upon request



1103-290

**Allen Inge Stifle Retractor**

With speed lock / 11" (27.9 cm)

1103-297

\* Custom blunt or shortened tips available upon request



1103-297

**Inge Neroma Retractor**

With crossover tip / 6 1/2" (16.5 cm)

- 417-048 with speedlock
- 417-048R with ratchet

\* Custom blunt or shortened tips available upon request



**Mini Inge Neroma Retractor**

With crossover tip / speed lock / 5" (12.7 cm)

417-0482

\* Custom blunt or shortened tips available upon request



**Mini Inge Neroma Ceramitec Retractor**

With crossover tip / speed lock / 5" (12.7 cm)

417-0482B

\* Custom blunt or shortened tips available upon request



**Foremann Kwire Distractor**

Tapered arms / 7 1/2" (19.1 cm)  
417-062D



417-062D

**Mini Foremann Distractor**

Tapered arms / 5" (12.7 cm)  
417-061



417-0621

**Inge Lamina Spreader**

With unique selection of tips / pediatric  
/ 6 1/2" (16.5 cm)

- 417-064 standard tip
- 417-064A tip A
- 417-064B tip B
- 417-064C tip C
- 417-064D tip D micro tip 1mm wide
- 417-064E tip E smooth
- 417-064F flat delicate, cross serrated tips with calibrated ratchet

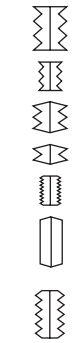

child standard tip



417-064D 417-064A 417-064  
Fine Serrations

417-064E

tip A  
tip B  
tip C  
tip D  
tip E  
tip F

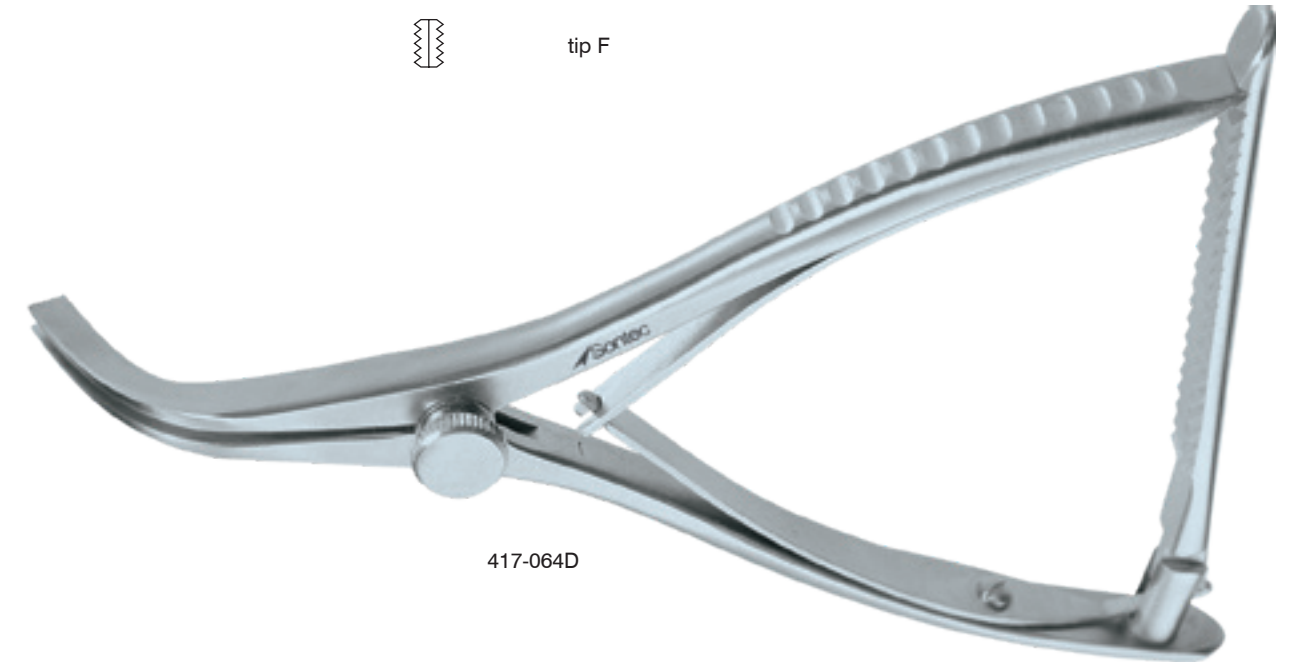

417-064D

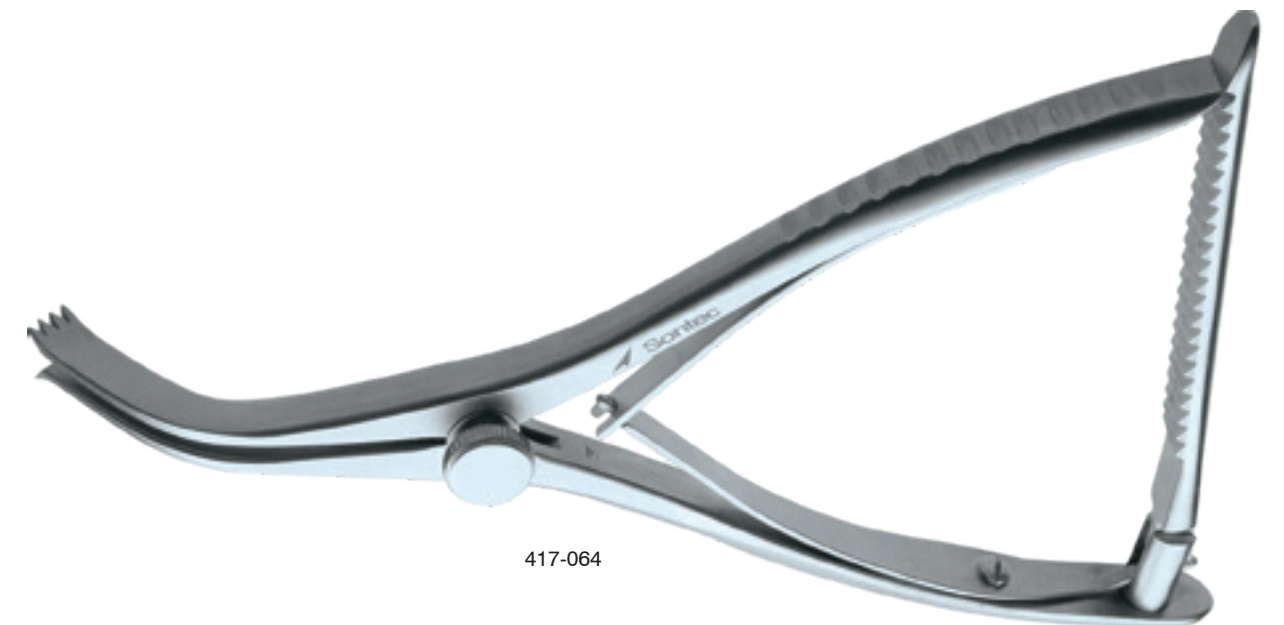

417-064

**Wellace Stifle Retractor**

Improved retraction / turn-key action

- 1100-635 standard
- 1100-635C crossover style



**Sisson Spring Retractor**

Sharp / 1 x 1 prongs / with ratchet / 4" (10 cm)

220-114

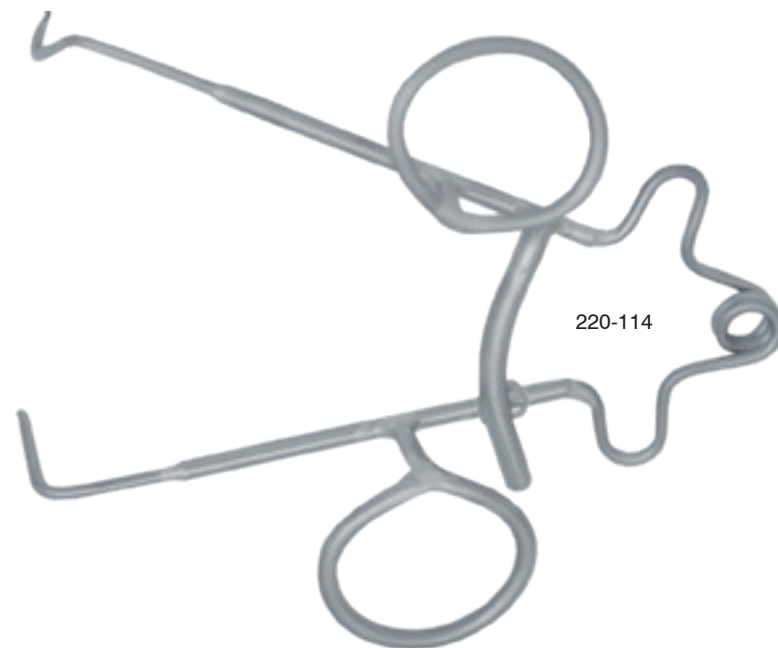

**Murphy-Lane Bone Skid**

Double ended / 1 1/4" cup & 3/4" cup / 12" (30.5 cm)

310-160



**Aufranc Cobra Retractor**

10 1/2" (26 cm)

- 1100-682 sharp serrated tip
- 1100-684 blunt serrated tip
- 1100-686 blunt smooth tip
- 1100-687 pointed smooth tip

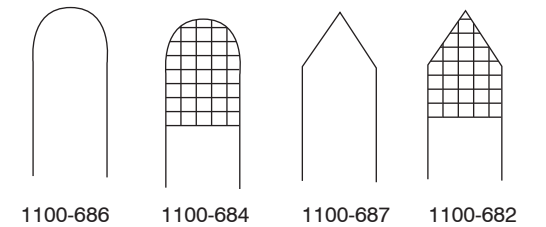

**Sontec Stifle Thrust Lever**

- 1100-6691 8 3/8"
- 1100-6692 11"



**Malleable Ribbon Retractor**

**Malleable**

- 207-454 1/4" x 7"
- 207-455 3/8" x 7"
- 207-456 1/2" x 7"
- 207-460 5/8" x 7"
- 207-461 3/4" x 7"
- 207-462 1" x 7"
- 207-463 3/4" x 13"
- 207-464 1" x 13"
- 207-465 1 1/4" x 13"
- 207-466 1 1/2" x 13"
- 207-467 2" x 13"
- 207-468 2 1/2" x 13"
- 207-469 3" x 13"
- 207-470 3 1/2" x 13"
- 207-471 4" x 13"
- 207-472 5" x 13"
- 207-474 1 3/4" x 13"
- 207-473 2 3/4" x 13"



207-466

207-460



**Malleable Ribbon Retractor**

**Hollow Grip Handle**

- 207-482 3/4" wide blade
- 207-484 1" wide blade
- 207-486 1 1/4" wide blade
- 207-488 1 1/2" wide blade
- 207-490 2" wide blade



207-486



207-488

**Meyering Retractor**

- 207-415 large blade 3 1/2" x 2" x 9 1/2"
- 207-413 medium blade 3" x 1" x 9 1/2"
- 207-411 small blade 2" x 5/8" x 9 1/2"



207-411

**Volkman Retractor**

**Sharp / 4 1/2" (11.5 cm)**

- 1100-648 2 prong
- 1100-650 3 prong
- 1100-652 4 prong
- 1100-654 6 prong

**Sharp / 8" (20 cm)**

- 1100-656 2 prong
- 1100-658 3 prong
- 1100-662 6 prong

**Sharp / 8 1/2" (22 cm)**

- 1100-660 4 prong

**Blunt / 4 1/2" (11.5 cm)**

- 1100-648B 2 prong
- 1100-650B 3 prong
- 1100-652B 4 prong
- 1100-654B 6 prong

**Blunt / 8 1/2" (22 cm)**

- 1100-656B 2 prong
- 1100-658B 3 prong
- 1100-660B 4 prong
- 1100-662B 6 prong

**Sharp / 8 3/4" (23 cm)**

- 214-052 4 prong



1100-652

**Gruber Skin Hook**

**10 mm tip / with weight / 5" (12.7 cm)**

- 199-383



199-383

**Platypus Micro Inge Lamina Spreader**

Platypus tip / 7" (17.8 cm)  
417-049



417-049

**Inge Micro Ring Handle Lamina Spreader**

With ratchet / 6 1/4" (16 cm)  
417-046 4x4 mm tip  
417-047 1.5x4 mm tip

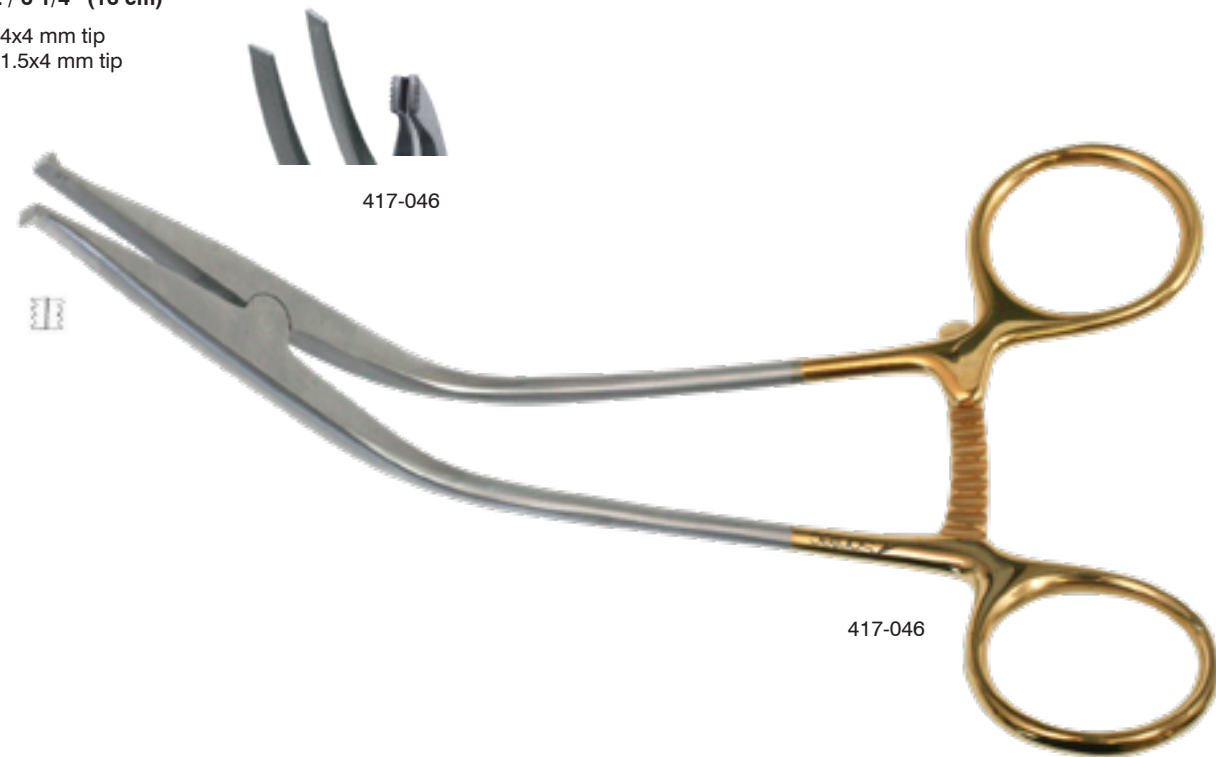

417-046

417-046

**Micro Lamina Spreader**

With speed lock / many tip widths available / 5 3/4" (14.5 cm)  
417-058

With speed lock / deep angle / 6 3/4" (17.1 cm)  
417-058D

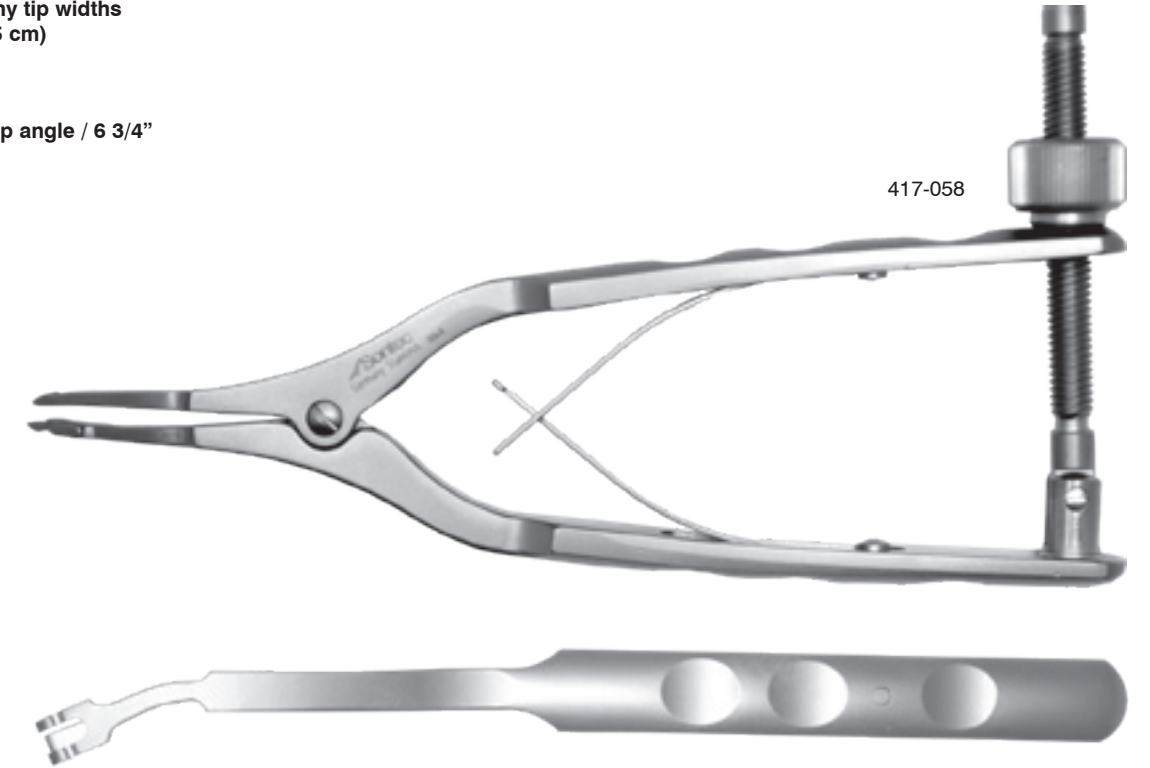

417-058



417-058D

**Senn Retractor**

Double-ended / 6 1/4" (16 cm)

- 1100-668 sharp
- 1100-668B blunt
- 1100-668T sharp titanium



1100-668



1100-668T

**Senn Retractor**

Blue electro coated / Double-ended / 6 1/4" (16 cm)

- 1100-669 sharp
- 1100-669B blunt



1100-669



1100-669B

**Ragnell Retractor**

Double-ended / 6" (15 cm)

205-849



205-849

**Ragnell Retractor**

Blue coated / double-ended / 6" (15 cm)

205-849B



205-849B

**Kelly Lamb Retractor**

10" overall length

- 207-350 1 1/2" x 2"
- 207-352 2" x 2 1/2"
- 207-354 2 1/2" x 3"
- 207-356 3" x 3 1/2"

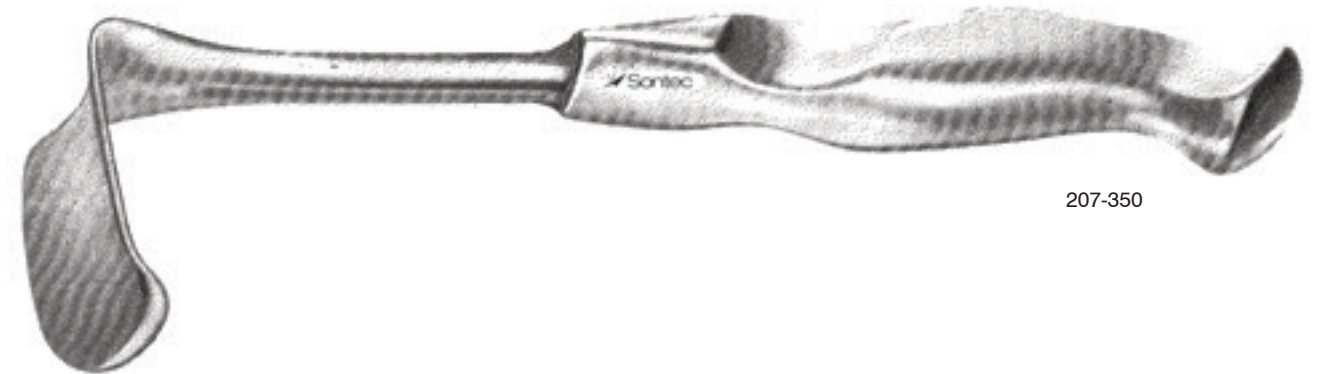

207-350

**U.S. Army-Navy Retractor**

Set of 2 / 8 1/2" (21.5 cm)

1100-670



1100-670

**U.S. Army-Navy Retractor**

Set of 2 / blue electro coated / 8 1/2" (21.5 cm)

1100-670B



1100-670B

**Hohman Elevator Retractor**

**8 1/2" (21.5 cm)**

1100-671 8 mm blade

**9 1/4" (23.5 cm)**

1100-672 10 mm blade  
 1100-673 18 mm blade  
 1100-674 25 mm blade  
 1100-675 43 mm blade  
 1100-676 70 mm blade

**9 1/2" (24 cm) / with extra long tip**

1100-671E 8 mm blade  
 1100-672E 10 mm blade  
 1100-673E 18 mm blade



1100-673



1100-671E



1100-672E



1100-673E

**Mini Hohman Elevator Retractor**

**6 1/4" (16 cm)**

1100-6780 2.5 mm blade  
 1100-679 4 mm blade  
 1100-678 6 mm blade  
 1100-680 8 mm blade



1100-679



1100-678

**Sontec-Hohman Retractor**

**Radical bend / 25 mm tip / 10 1/2" (27 cm)**

1100-677



1100-677

**Sontec Lane Lever Elevator**

**Ring handle style 30-100 lbs**

1100-6696





 Sontec Instruments®

Orthopedic BONE HOLDING CLAMPS

**Patella 2 x 2 Prong Bone Clamp**

With speed lock / 7 1/4" (18.5 cm)

1103-215



1103-215

**Verbrugge-Rogalski Bone Clamp**

With speedlock / 1.5 mm jaw / 4" (10 cm)

1103-069



1103-069

**Kern Hybrid Bone Clamp**

With speedlock / fenestrated head / 4 3/4" (12 cm)

305-344A



305-344A

**Kern Bone Clamp**

Fenestrated jaw / with ratchet

- 305-332 4 3/4" (12 cm)
- 305-334 5 1/2" (14 cm)
- 305-328 6 1/4" (15.9 cm)
- 305-338 7" (18 cm)
- 305-336 8 1/2" (21.5 cm)

With ratchet

- 305-347 13" (33 cm)

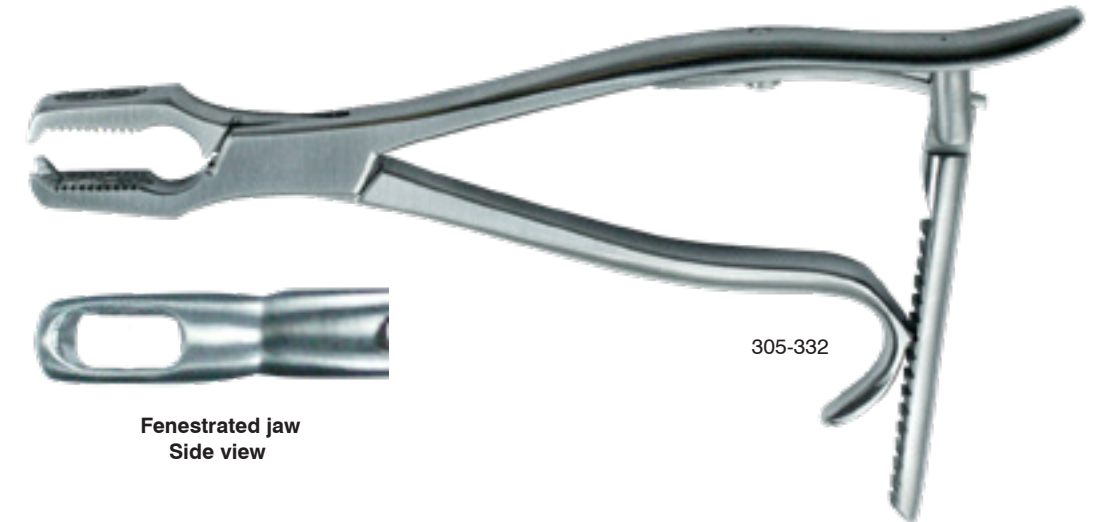

305-332

Fenestrated jaw  
Side view

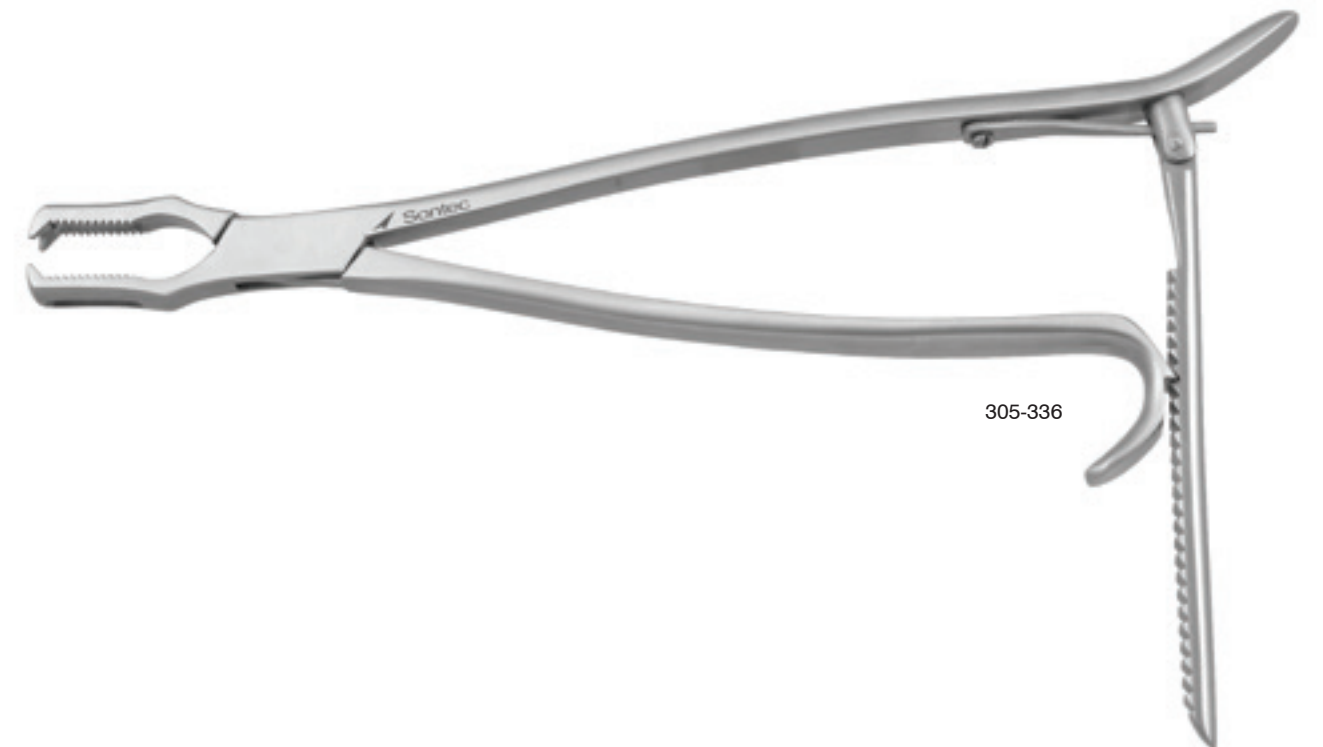

305-336

**Verbrugge Bone Clamp**

**Curved to side / with speedlock**

- 1103-070 6" (15.5 cm)
- 1103-074 7 1/2" (19 cm)
- 1103-075 8 1/4" (21 cm)
- 1103-075D 8 1/4" (21 cm) delicate
- 1103-076 9 1/2" (24 cm)
- 1103-080 10" (25.5 cm)

**Swivel jaw / curved to side/with speedlock**

- 1103-071 5 3/4" (15 cm)
- 1103-073 8" (20.5 cm)
- 1103-077 9" (23 cm)
- 1103-078 10 1/4" (26 cm)
- 1103-079 11 1/4" (29 cm)



1103-076



1103-071

**Ulrich Bone Clamp**

**With speedlock / straight**

- 305-367S\* 7 1/8" (18.25 cm)
- 305-368 9" (23 cm)
- 305-369 10 1/2" (27 cm)

**Curved to side**

- 305-365 5 1/4" (13.5 cm)
- 305-365M\* 5 1/2" (14 cm)
- 305-366 6 1/2" (16.5 cm)
- 305-367\* 7 1/8" (18.25 cm)
- 305-368A 9" (23 cm)
- 305-369A 10 1/2" (27 cm)

\* micro jaws



305-369



305-367



305-365

**Kern Bone Clamp**

**Fenestrated jaw / with ratchet**

- 305-332 4 3/4" (12 cm)
- 305-334 5 1/2" (14 cm)
- 305-328 6 1/4" (15.9 cm)
- 305-338 7" (18 cm)
- 305-336 8 1/2" (21.5 cm)

**With ratchet**

- 305-347 13" (33 cm)

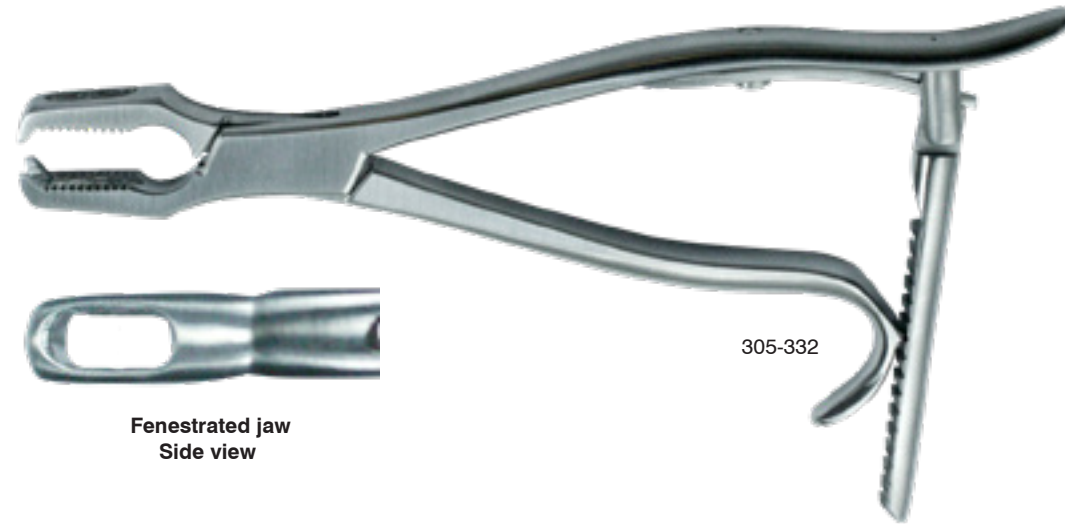

Fenestrated jaw  
Side view

305-332



**Stefan Mini Bone Holding Forceps**

**Curved / 4 mm opening / mini**

- 1103-003 4" (10 cm) with speedlock
- 1103-004 4" (10 cm) with ratchet
- 1103-005 5 1/2" (14 cm) with ratchet



1103-003



1103-004

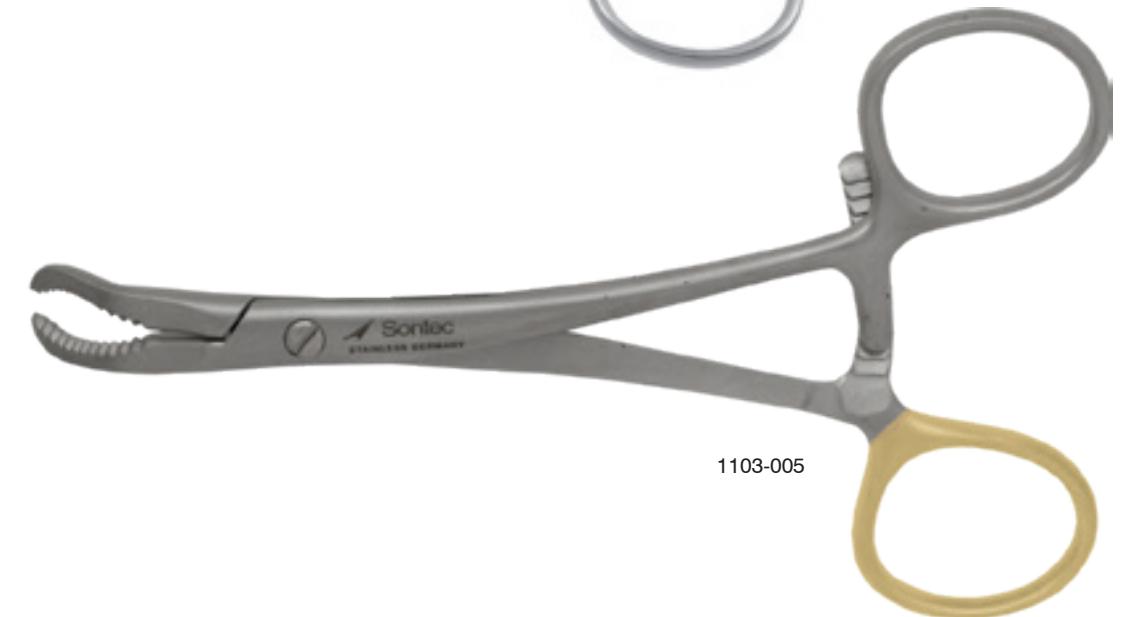

1103-005

**Stefan Bone Holding Forceps**

Curved / with speed lock

- 1103-006 5 1/2" (14 cm)
- 1103-008 6" (15.5 cm)
- 1103-010 7" (18 cm)
- 1103-011 9 1/2" (24 cm)



**Sequestrum Sontec Bone Forceps**

Serrated jaws / 8" (20.3 cm)

- 1103-013 straight
- 1103-014 curved



**Doolen Bone Holding Clamp**

2mm wide jaw / 5.5" (14cm)

- 1103-845 str w/ speedlock
- 1103-846 ang w/ speedlock
- 1103-846R ang w/ ratchet

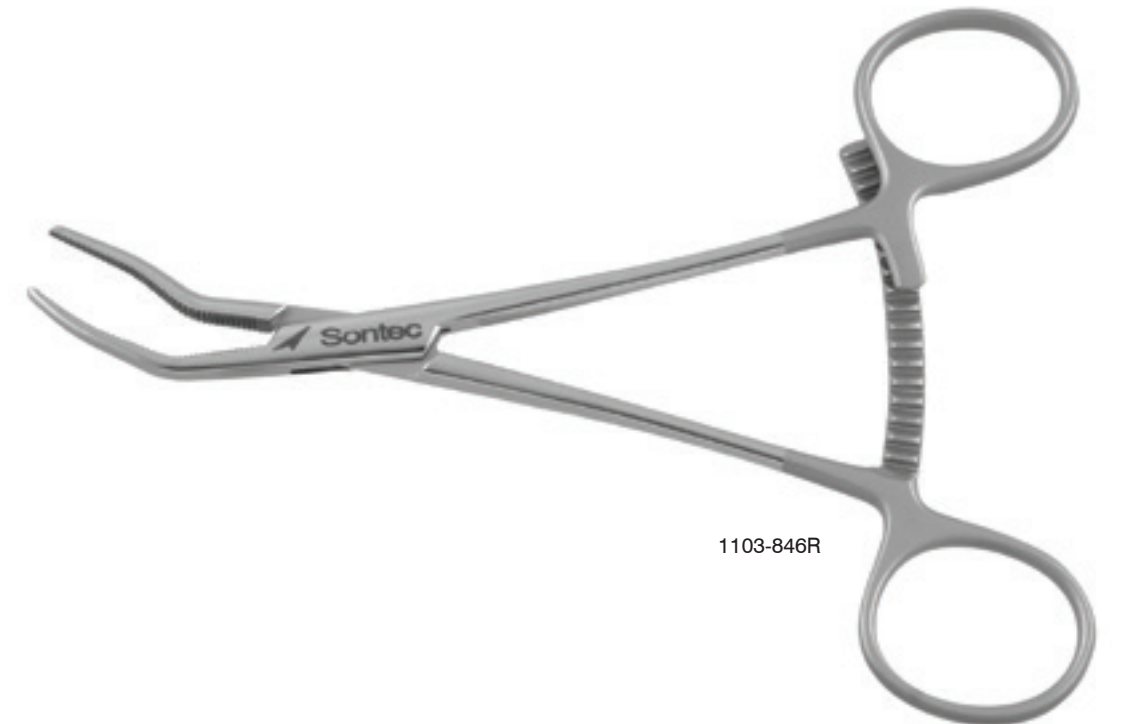
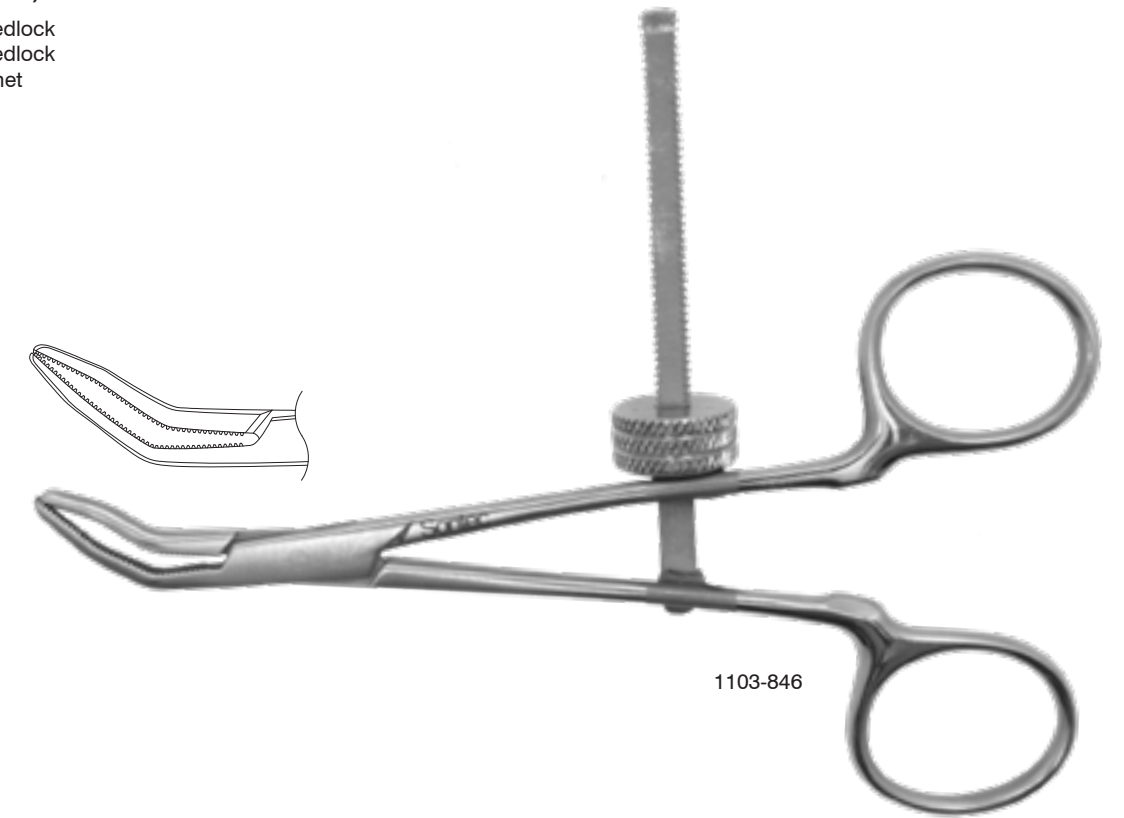



 Sontec Instruments®

Orthopedic BONE REDUCTION CLAMPS

**Bone Reduction Clamp**

**With ratchet**

- 1103-039L\* 6" (15 cm) long double ratchet
- 1103-039N\* 7" (17.8 cm) long double ratchet
- 1103-045 8" (20 cm) extra long ratchet

\* Other sizes available

\* Custom extra sharp or blunt tips available upon request

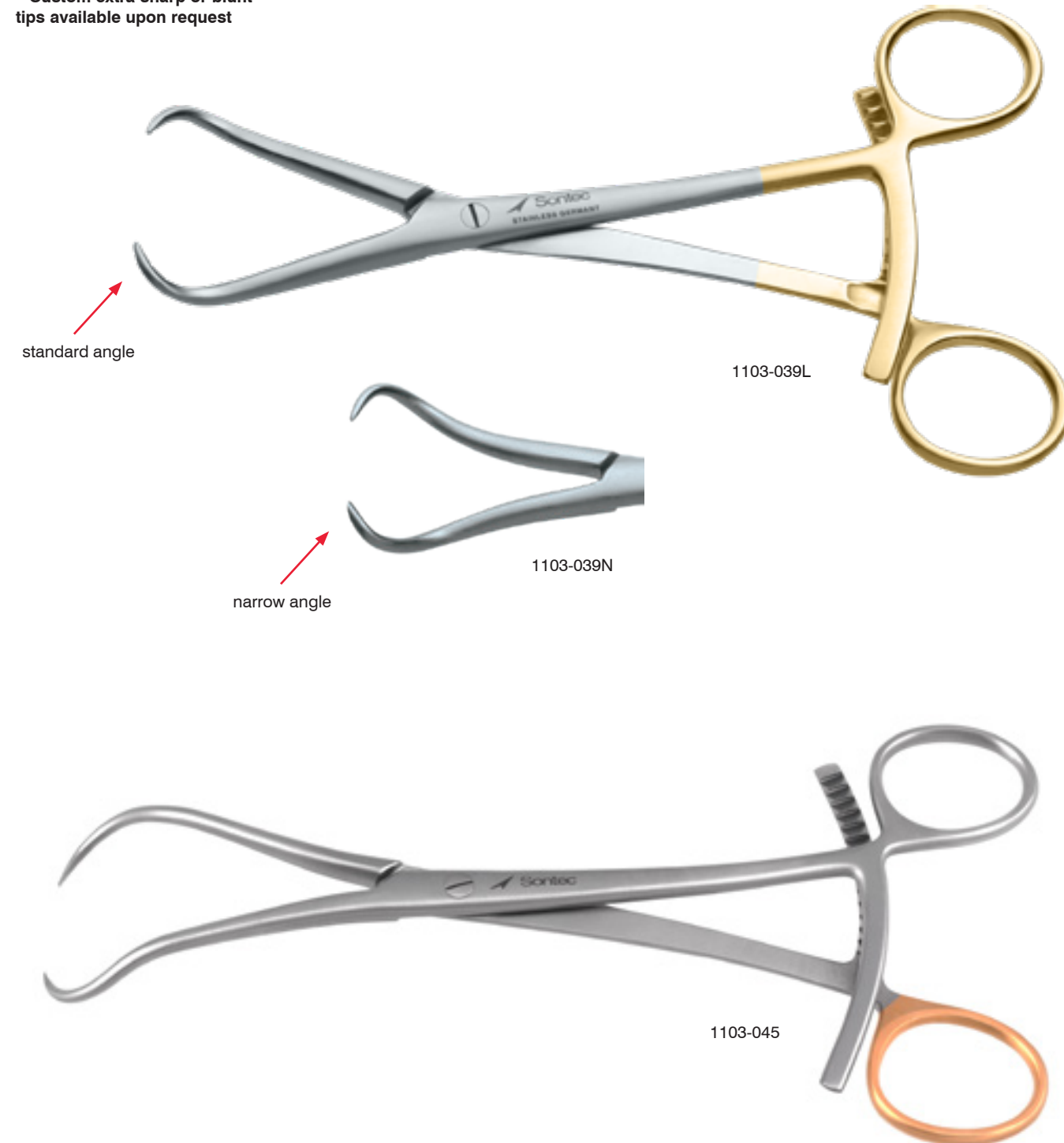

**Raleigh Bone Holding Forceps**

- 1103-040A 3 mm 5 1/2" with ratchet
- 1103-040B 5 mm 5 1/2" with ratchet
- 1103-040C 12 mm 7" with speedlock
- 1103-040AS 3 mm 5 1/2" with speedlock
- 1103-040BS 5 mm 5 1/2" with speedlock



**Bone Reduction Clamp**

**With extra long ratchet**

- 1103-040 5 1/8" (13.25 cm)
- 1103-040R 5 1/8" (15.2 cm) longer ratchet
- 1103-042 7" (18 cm)

**With speedlock**

- 1103-041 5 1/8" (13.25 cm)
- 1103-0425 6 1/8"
- 1103-043 6 1/2" (16.5 cm)

\* Custom extra sharp or blunt tips available upon request

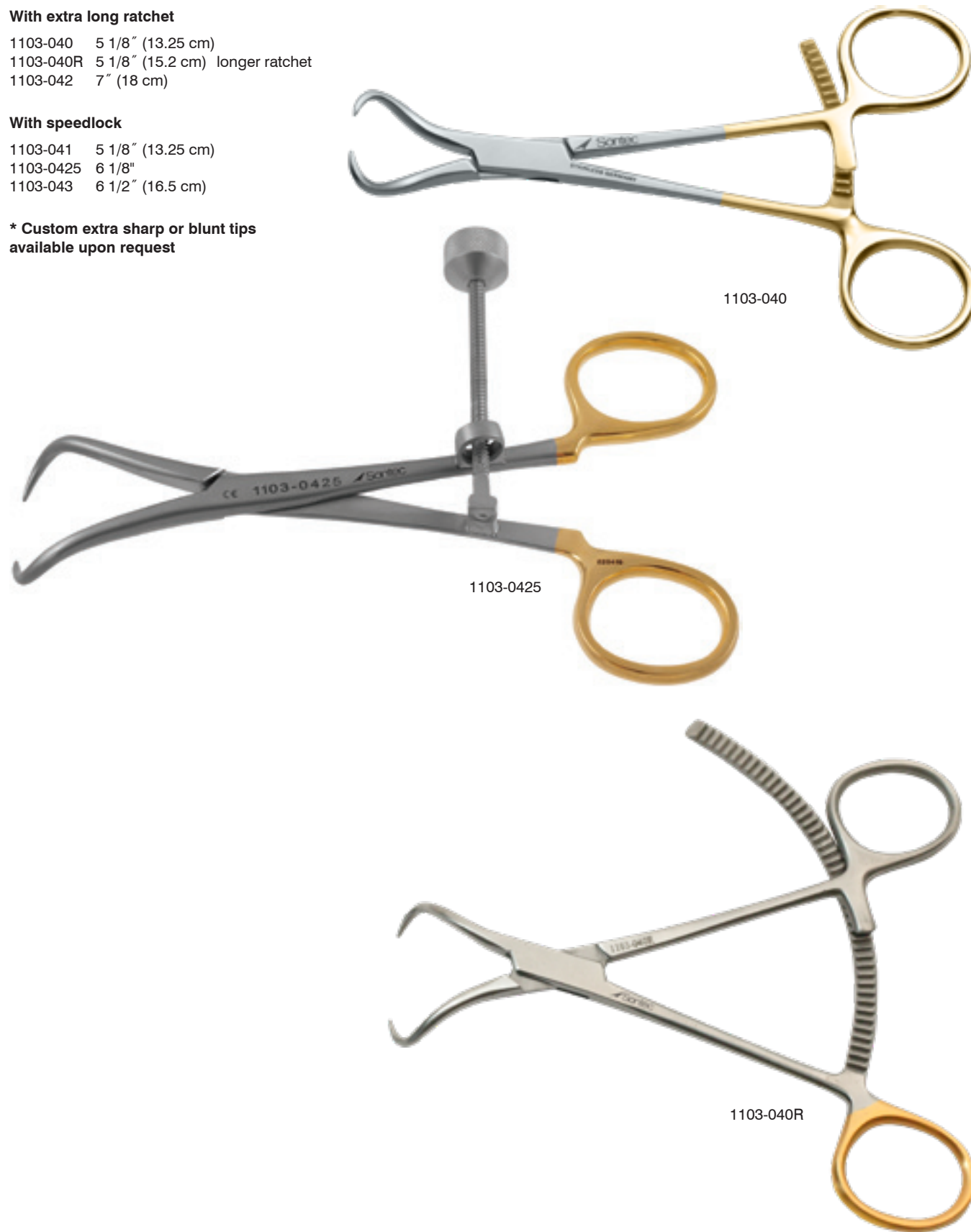

**Bone Reduction Clamp**

**AO types**

- 1103-041A 8" (20.5 cm)
- 1103-041B 6" (15 cm)
- 1103-041C 10" (25.5 cm)

\* Custom extra sharp or blunt tips available upon request

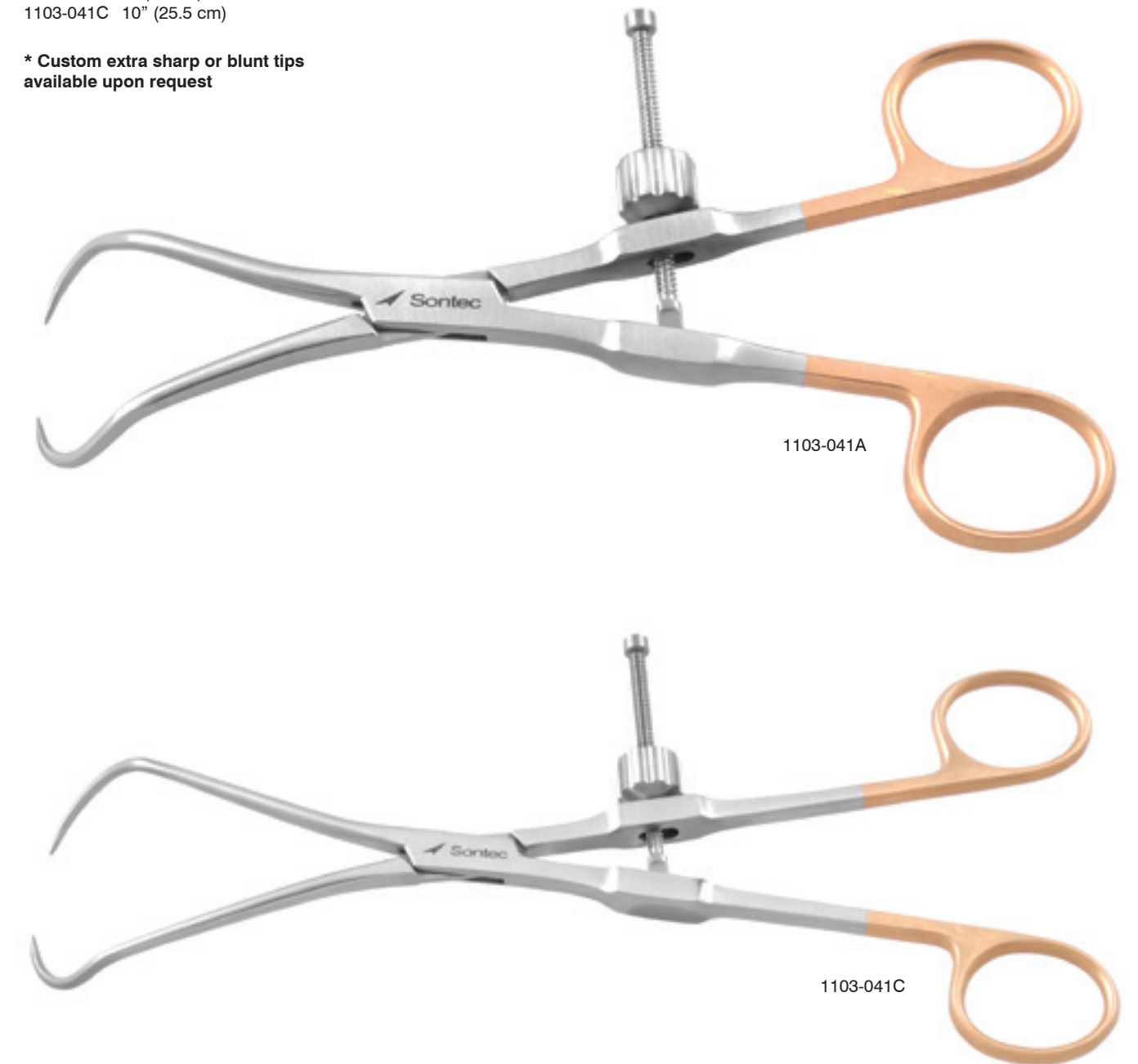

**Ikuta Bone Clamp**

5" (13 cm)

1103-054A	2.0 mm	straight
1103-054B	2.0 mm	curved
1103-054C	3.0 mm	straight
1103-054D	3.0 mm	curved



**Schroeder Vulsellum Bone Reduction Clamp**

9 3/4" (24 cm)

1103-055	str	with speedlock
1103-056	cvd up	with speedlock
1103-057	cvd up	with speedlock
1103-060	str	with ratchet
1103-061	cvd up	with ratchet
525-364	cvd sideways	with ratchet

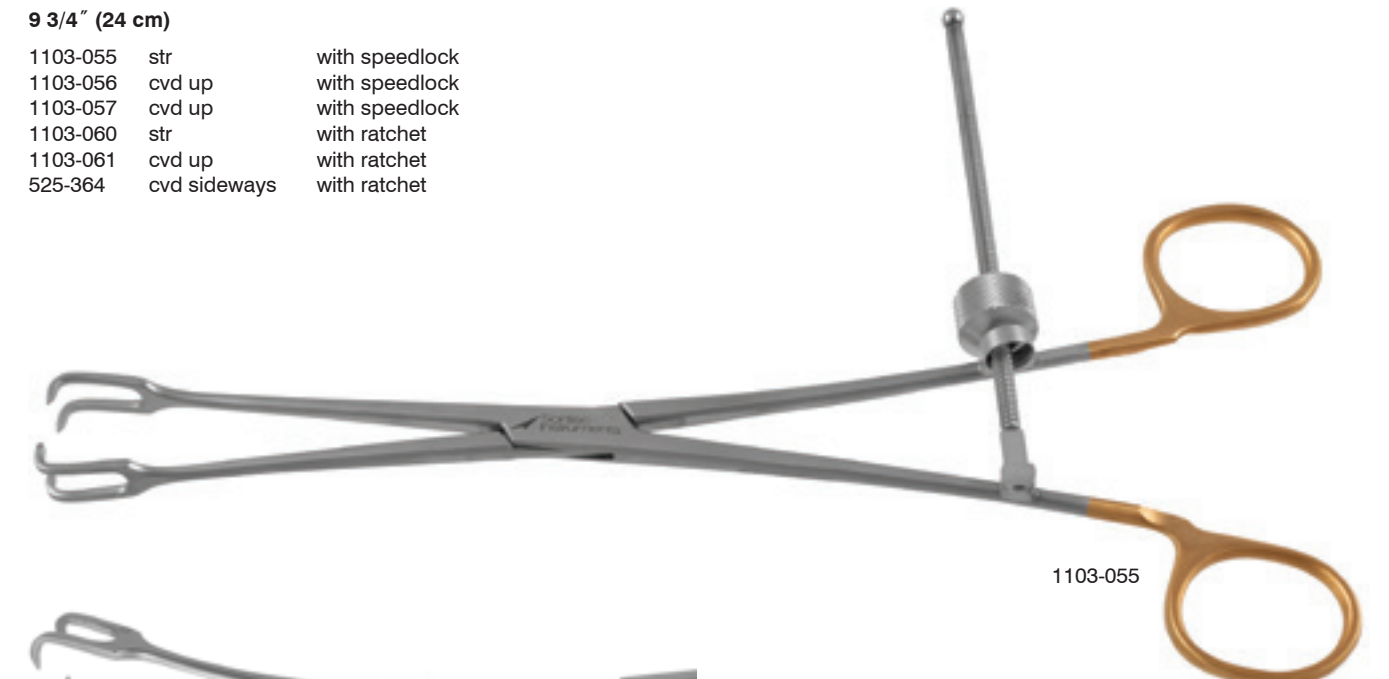

**Redler Reposition Reduction Clamp**

With K-wire guide / 1.6 mm / 5 1/4" (13.5 cm)

1103-031

\* Custom extra sharp or blunt tips available upon request



1103-031

**Plate & Bone Reduction Forceps**

With long ratchet / 4 3/4" (12 cm)

1103-038

\* Custom extra sharp or blunt tips available upon request



1103-038

**Micro Bone Reduction Clamp**

1103-037 3 3/4" (9.5 cm) with holding tip

1103-037A 4 3/4" (12 cm)

\* Custom extra sharp or blunt tips available upon request



1103-037

**Bone Reduction Clamp**

With speedlock / 3 3/4" (9.5 cm)

1103-037S

\* Custom extra sharp or blunt tips available upon request



1103-037S



 Sontec Instruments®

Orthopedic CURETTES

**Stille Curette**

**Flat handle / round cup**

1103-263	2 mm	6 1/2"
1103-264	3 mm	6 1/2"
1103-265	4 mm	6 1/2"
1103-266	5 mm	7 3/4"
1103-267	6 mm	7 3/4"
1103-268	7 mm	7 3/4"
1103-269	8 mm	7 3/4"
1103-270	10 mm	8"
1103-271	12 mm	8"
1103-272	14 mm	8"

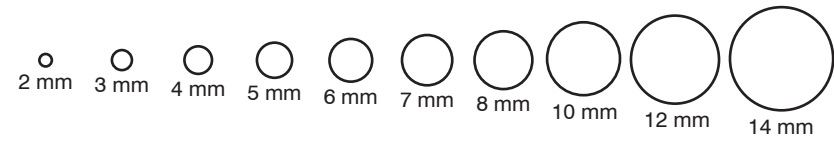

1103-267

**Bruns Round Cup Curette**

**Round cup / straight / 6 3/4" (17 cm)**

320-708	size 00000
320-709	size 0000
320-710	size 000
320-711	size 00
320-712	size 0
320-713	size 1
320-714	size 2
320-715	size 3
320-716	size 4
320-717	size 5
320-718	size 6

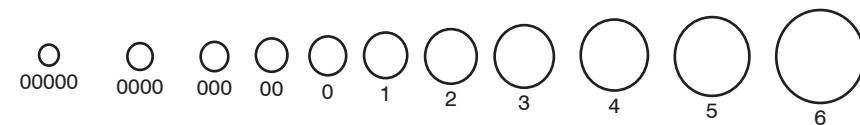

320-718

**Bruns Oval Cup Curette**

**Oval cup / straight / 6 3/4" (17 cm)**

320-808	size 00000
320-809	size 0000
320-810	size 000
320-811	size 00
320-812	size 0
320-813	size 1
320-814	size 2
320-815	size 3
320-816	size 4
320-817	size 5
320-818	size 6

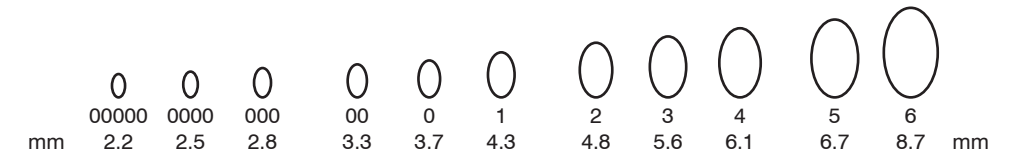

320-811

**Oval cup / straight / 9" (23 cm)**

320-827	size 00000
320-829	size 0000
320-830	size 000
320-831	size 00
320-832	size 0
320-833	size 1
320-834	size 2
320-835	size 3
320-836	size 4
320-837	size 5
320-838	size 6



320-834

**Oval cup / angled / 9" (23 cm)**

320-848	size 00000
320-849	size 0000
320-850	size 000
320-851	size 00
320-852	size 0
320-853	size 1
320-854	size 2
320-855	size 3
320-856	size 4
320-857	size 5
320-858	size 6



320-854

**Bruns Solid Hexagonal Curette**

Angled / solid hexagonal handle / oval / 9" (22.9 cm)

- 320-870A size 000
- 320-871A size 00
- 320-872A size 0
- 320-873A size 1
- 320-874A size 2
- 320-875A size 3
- 320-876A size 4
- 320-877A size 5
- 320-878A size 6

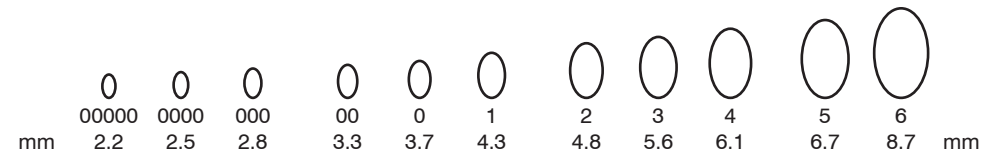

320-870A



320-876A

**Bruns Hexagonal Handle Curette**

Solid hexagonal handle / 9" (23 cm)

- 320-870 size 000
- 320-871 size 00
- 320-872 size 0
- 320-873 size 1
- 320-874 size 2
- 320-875 size 3
- 320-876 size 4
- 320-877 size 5
- 320-878 size 6

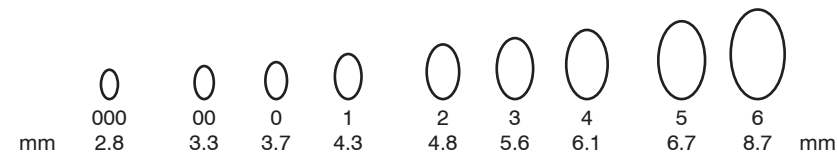

320-876

**Cone Ring Curette**

Aluminum handle / inside ring diameter / 9" (23 cm)

- 320-952 3mm straight
- 320-955 3mm angle
- 320-951 6mm straight
- 320-954 6mm angle
- 320-950 8mm straight
- 320-953 8mm angle



320-950



3 mm

6 mm

8 mm

**Hatt Spoon Curette**

Solid hexagonal handle / 9" (23 cm)

- 320-778 10 mm
- 320-779 15 mm
- 320-780 20 mm



320-780

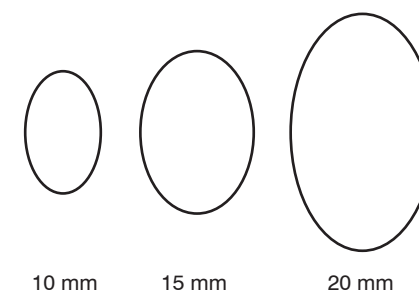

10 mm

15 mm

20 mm



 Sontec Instruments®

ENT CURETTES

**Meyerhoefer-Chalazion Curette**

5" (12.5 cm)

- 12-1285 0.5 mm
- 12-1290 1.0 mm
- 12-1300 1.5 mm
- 12-1310 1.75 mm
- 12-1320 2.0 mm
- 12-1355 2.5 mm
- 12-1360 3.0 mm
- 12-1365 3.5 mm
- 12-1367 4.0 mm
- 12-1368 4.5 mm

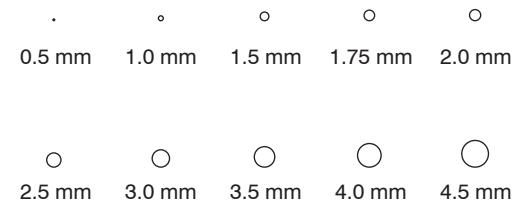

12-1368

**Shapleigh Ear Curette**

Serrated loop / 6" (15 cm)

- 467-430 small angled
- 467-431 small straight
- 467-432 large angled
- 467-433 large straight

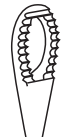

467-430



467-433

**Shapleigh Ear Curette**

Smooth loop / octagonal handle / 6" (15.2 cm)

- 467-434 small straight
- 467-4341 small angled
- 467-435 large straight
- 467-4351 large angled



467-434



467-4341



467-435

**Williger Curette**

Double-ended / 5 1/2" (14 cm) / str

- 467-4131 #0/1
- 467-4132 #00/0
- 467-4133 #1/2
- 467-4134 #3/4

Double-ended / 5 1/2" (14 cm) / each end angled 45°

- 467-4131A #0 / 1
- 467-4132A #00 / 0
- 467-4133A #1 / 2



66-0165

**Martini Bone Curette**

Double-ended / straight / 3mm/4mm / 5 1/2" (14 cm)

- 467-415



467-415

**Billeau Ear Loop/Curette**

6 1/2" (16.5 cm)

- 467-440XS extra small
- 467-440 small
- 467-438 medium
- 467-436 large

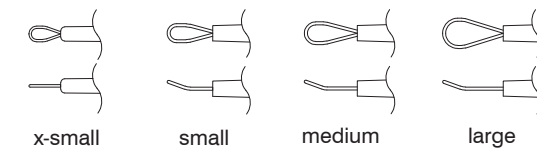

467-440

**House Curette**

**Double-ended / 5 3/4" (14.5 cm)**

199-133 both ends cvd 1.5 mm x 1.2 mm micro tip



**Double-ended / 6" (15 cm)**

199-132 one end angled, one end str 2.0 mm x 3.2 mm  
 199-129 both ends angled 2.0 mm x 3.5 mm  
 199-131 both ends str 2.0 mm x 3.5 mm



**Double-ended / 7" (18 cm)**

199-130 both ends angled 1.5 mm x 3.0 mm

**Double-ended / 9" (22.8 cm)**

199-136 both ends straight 2.0 mm x 3.5 mm



**Frontal Sinus Curette**

**7 1/2" (19 cm)**

320-769 straight  
 320-770 55°  
 320-771 90°



**Tholl Curette**

**Double ended / 1 round and 1 oval cups / 8 1/4" (21 cm)**

320-949



**Sontec® Excavator Curette**

**Single-ended / 5" (12.5 cm)**

199-300 1 mm  
 199-308 1 mm w/ hole  
 199-302 1.5 mm  
 199-310 1.5 mm w/ hole  
 199-304 2 mm  
 199-312 2 mm w/ hole  
 199-306 2.5 mm  
 199-314 2.5 mm w/ hole



**Double-ended / 5 1/2" (14 cm) / with hole**

199-320 1.5 mm / 2 mm  
 199-322 1.5 mm / 2.5 mm



**Buck Ear Round Handle Curette**

**Round Handle / str / blunt / 5 3/4" (14 cm)**

- 467-371 size 000
- 467-370 size 00
- 467-372 size 0
- 467-374 size 1
- 467-376 size 2
- 467-378 size 3



467-372

**Round Handle / str / sharp / 5 3/4" (14 cm)**

- 467-389 size 000
- 467-390 size 00
- 467-392 size 0
- 467-394 size 1
- 467-396 size 2
- 467-398 size 3

**Round Handle / angled / blunt / 5 3/4" (14 cm)**

- 467-379 size 000
- 467-380 size 00
- 467-382 size 0
- 467-384 size 1
- 467-386 size 2
- 467-388 size 3



467-380

**Round Handle / angled / sharp / 5 3/4" (14 cm)**

- 467-403 size 000
- 467-404 size 00
- 467-406 size 0
- 467-408 size 1
- 467-410 size 2
- 467-412 size 3

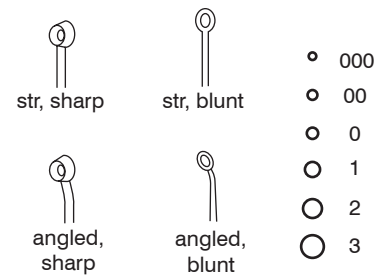

**Buck Ear Curette Hex Handle**

**Hex handle / str / blunt / 5 3/4" (14 cm)**

- 467-371S size 000
- 467-370S size 00
- 467-372S size 0
- 467-374S size 1
- 467-376S size 2
- 467-378S size 3



467-370S

**Hex handle / str / sharp / 5 3/4" (14 cm)**

- 467-389S size 000
- 467-390S size 00
- 467-392S size 0
- 467-394S size 1
- 467-396S size 2
- 467-398S size 3



467-398S

**Hex handle / angled / blunt / 5 3/4" (14 cm)**

- 467-379S size 000
- 467-380S size 00
- 467-382S size 0
- 467-384S size 1
- 467-386S size 2
- 467-388S size 3



467-386S

**Hex handle / angled / sharp / 5 3/4" (14 cm)**

- 467-403S size 000
- 467-404S size 00
- 467-406S size 0
- 467-408S size 1
- 467-410S size 2
- 467-412S size 3



467-406S

**Hex handle / straight / blunt / 6 1/2" (16.5 cm)**

- 467-372SL size 0
- 467-376SL size 2

**Hex handle / angled / blunt / 6 1/2" (16.5 cm)**

- 467-379SL size 000
- 467-380SL size 00
- 467-382SL size 0
- 467-384SL size 1
- 467-386SL size 2
- 467-388SL size 3



467-379SL

**Hex handle / angled / sharp / 6 1/2" (16.5 cm)**

- 467-410HL size 2



467-410HL

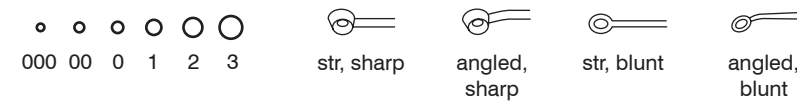

**Vogel Infant Adenoid Curette**

8 1/4" (21 cm)  
478-260



478-260

**Barnhill Adenoid Curette**

8 3/4" (22 cm)  
478-265 #0  
478-267 #1  
478-269 #2  
478-271 #3  
478-273 #4



478-273

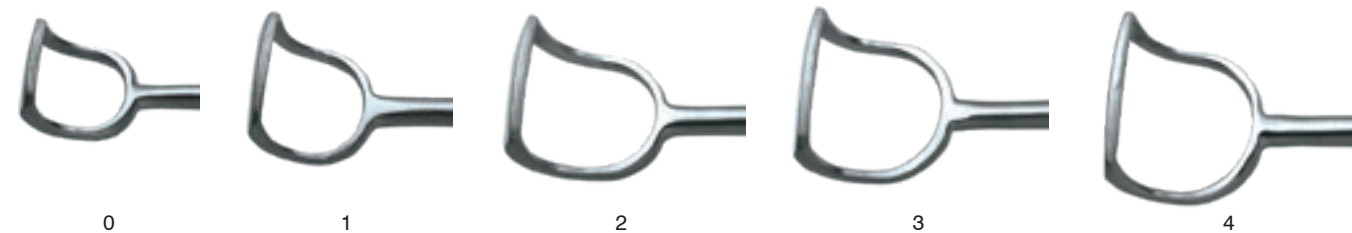

**Coakley Antrum Curette**

Large / 7" (18 cm)

478-276 #1 30° angle  
478-277 #2 60° angle  
478-278 #3 100° angle

Small / 7" (18 cm)

478-279 #4 30° angle  
478-280 #5 60° angle  
478-281 #6 30° angle triangle tip



478-279

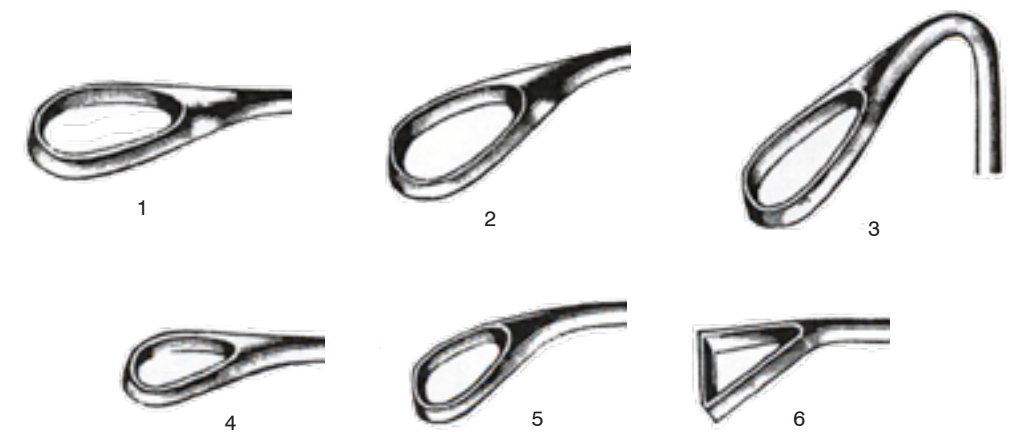



 Sontec Instruments®

Orthopedic SINGLE ACTION RONGEURS

**Mini Neuro Rongeur**

5 1/2" (14 cm)

- 1106-080 str 0.75 mm jaw
- 1106-082 cvd 0.75 mm jaw
- 1106-084 str 1.0 mm jaw
- 1106-086 cvd 1.0 mm jaw
- 1100-577S str 1.3 mm jaw
- 1100-577 cvd 1.3 mm jaw



1100-576

1.4 mm jaw / 6" (15 cm)

- 1100-574 str
- 1100-576 cvd

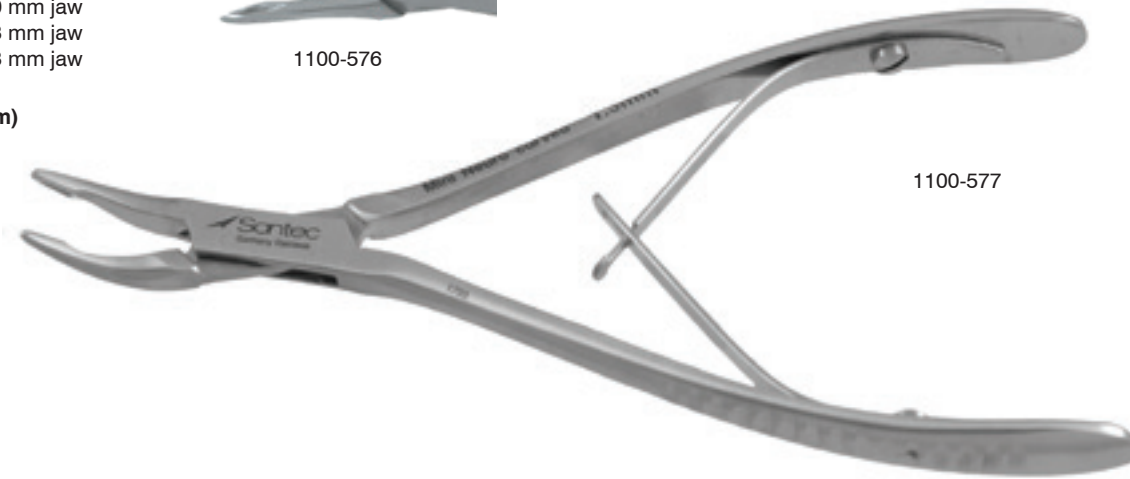

1100-577

**Mini Neuro Premier Rongeur**

0.5 mm tip / 5 1/2" (14 cm)

- 1106-091 str
- 1106-092 cvd



1106-091



1106-092

**Micro Friedman Ring Handle Rongeur**

5 1/2" (14 cm)

- 1106-076 1.3 mm straight
- 1106-077 1.3 mm curved
- 1106-078 1.3 mm full curved
- 1106-079 2.0 mm curved
- 1106-0791 2.0 mm full curved



1106-077



1106-078



1106-079



1106-0791

**Kleinert-Kutz Rongeur**

2 mm x 6 mm jaw / 5 1/4" (13 cm)

- 315-581 slight curve
- 315-580 full curve



315-581



315-581



315-580

**Micro Friedman Rongeur**

1.5 mm x 5 mm jaw / 5 1/2" (14 cm)

- 315-505S str
- 315-505C 30° angle
- 315-505 90° angle

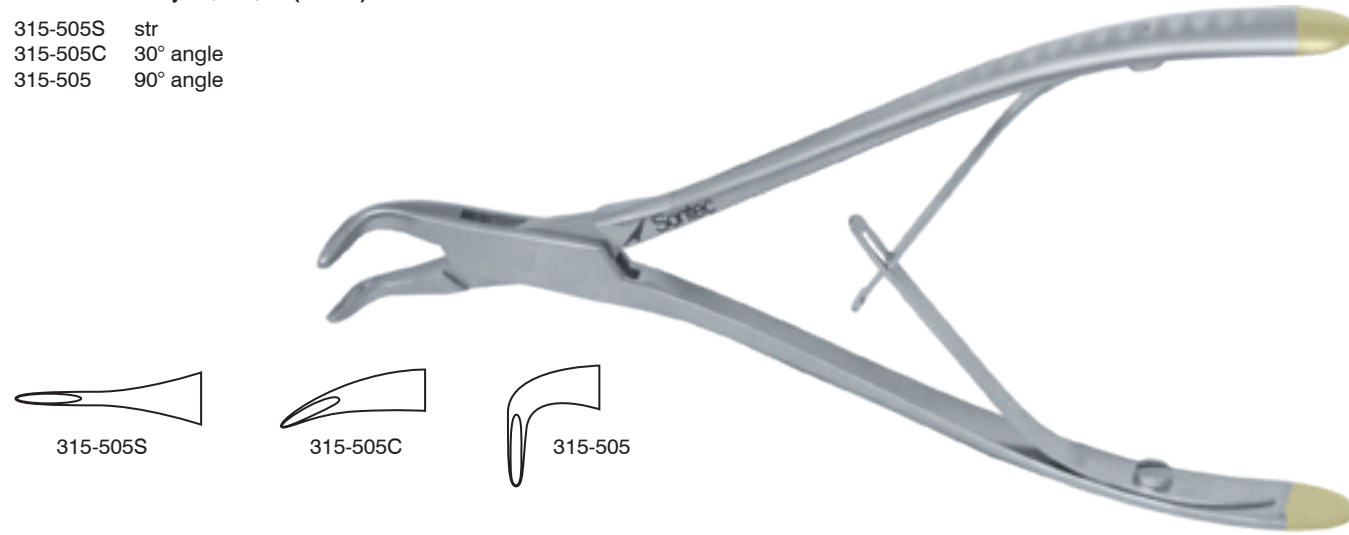

315-505

**Mini Friedman Rongeur**

2 mm x 8 mm jaw / 5 1/2" (14 cm)

- 1106-070 str
- 1106-075 cvd



1106-075

**Shearer Chickenbill Rongeur**

Curved / 3 mm x 12 mm jaw

- 315-511 5 1/2" (14 cm)
- 315-513 6 1/2" (16.5 cm)
- 315-515 7" (18 cm)



315-511

**Hakansson Rongeur**

2.5 mm x 12 mm jaw / curved / 6 1/4" (16cm)

- 1103-230



1103-230

**Stellbrink Rongeur**

2 mm x 8 mm jaw / 6 1/2" (16.5 cm)

- 315-566 slight curve
- 315-567 full curve



315-566

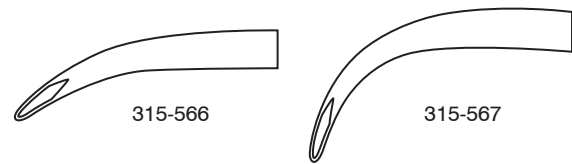

315-566

315-567



315-567

**Classic Lempert Rongeur**

2.5 mm x 10 mm jaw

- 315-542 straight 6 1/4" (16 cm)
- 315-544 curved 6 1/4" (16 cm)
- 315-548 straight 7 1/2" (19 cm)
- 315-550 curved 7 1/2" (19 cm)

\* Additional Rongeurs available. Please call for styles, sizes & details



315-544



straight

curved

**Sontec Lempert Rongeur**

2.5 mm jaw / 6 1/2" (16.6 cm)

- 1100-542 straight
- 1100-544 curved

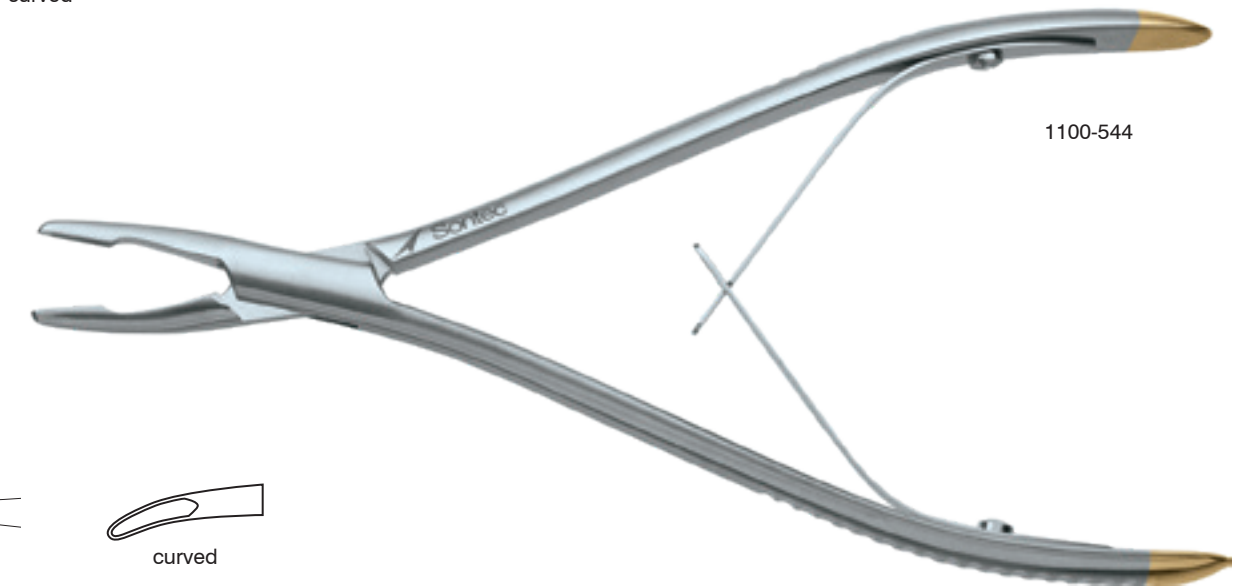

1100-544



straight

curved

**Jeurs Lempert Neuro Rongeur**

Curved to side / 2.5 mm jaw / 7 1/2" (19 cm)

1100-578



1100-578

**Levesque Neuro Rongeur**

Curved to side / low profile / extra delicate / 1.3 mm jaw / 7 1/2" (19 cm)

1100-578A



1100-578A

1100-578A

**Cicherelli Rongeur**

3 mm x 12 mm jaw / full curve / 6 1/2" (16.5 cm)

315-559



315-559

**Cleveland Rongeur**

Curved

315-526 5 1/2" (14 cm)

315-527 6 3/4" (17cm)



315-527

**Bane Single Action Rongeur**



315-540

**Blumenthal Rongeur**

**Tapered jaw / delicate / 4 1/2" (11.5 cm)**

- 315-500M 30° angle
- 315-501M 45° angle

**Curved / 2.5 mm x 10 mm jaw / 6" (15 cm)**

- 315-500 30° angle
- 315-501 45° angle

**Curved / 2.5 mm x 10 mm jaw / 7" (15 cm)**

- 315-499 30° angle



315-500

**Cushing Rongeur**

**6 mm x 14 mm jaw / 8" (20.5 cm)**

- 315-574 straight
- 315-576 curved

315-576

**Serrated jaw / 6 mm x 14 mm jaw / 8" (20.5 cm)**

- 315-572 straight
- 315-573 curved

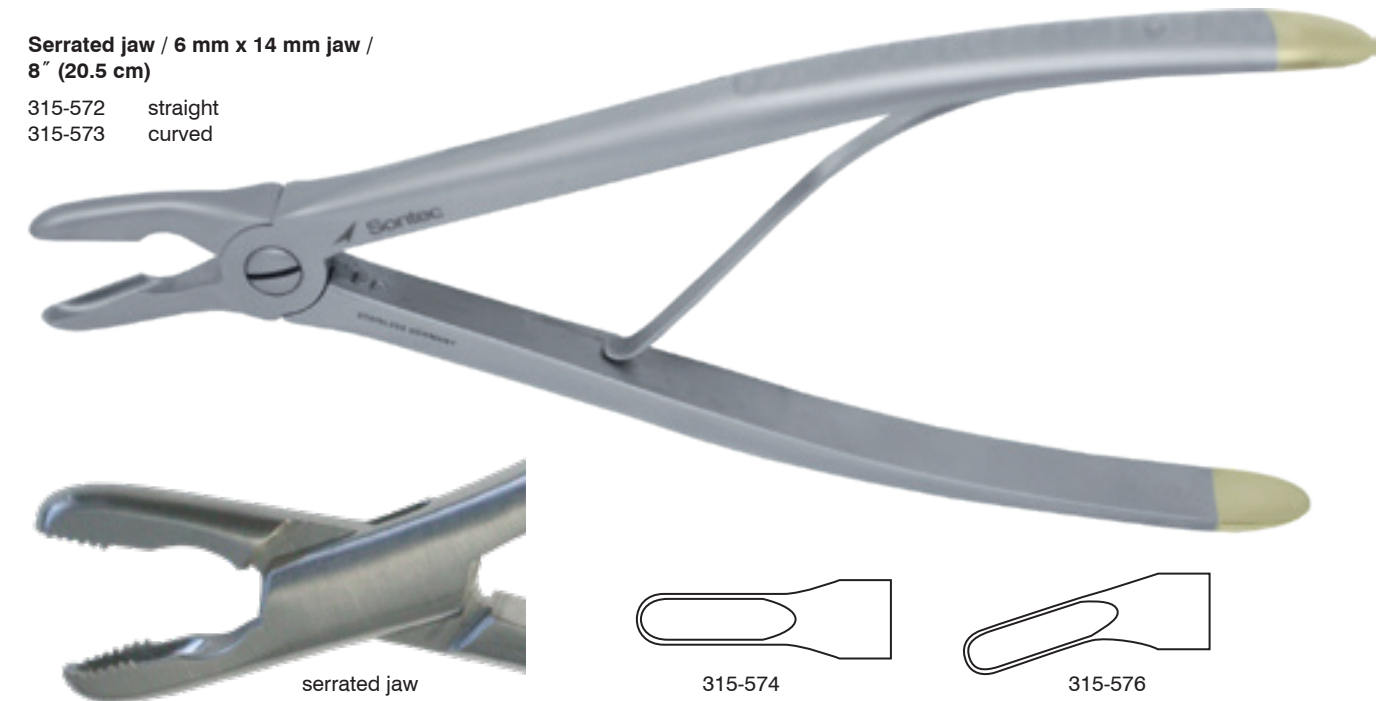

serrated jaw

315-574

315-576

**Sontec Dental Bone Cutting Forceps**

**Small / 6" (15 cm)**

- 1100-584

**Large / 6 1/2" (16.5 cm)**

- 1100-584A

1100-584



1100-584

1100-584A



 Sontec Instruments®

Orthopedic DOUBLE ACTION RONGEURS

**Ruskin Rongeur**

**Double action / 6" (15.5 cm)**

315-585	2 mm jaw	str
315-587	2 mm jaw	cvd
315-590	3 mm jaw	str
315-588	3 mm jaw	slight curve
315-589	3 mm jaw	full curve
315-586	4 mm jaw	str
315-593	4 mm jaw	cvd

**Double action / 7 1/4" (18.5 cm)**

315-610	5 mm jaw	str
315-612	5 mm jaw	cvd
315-614	6 mm jaw	str
315-616	6 mm jaw	cvd

**Double action / 5 mm / 9 1/2" (23.1 cm)**

315-619	str
315-621	cvd

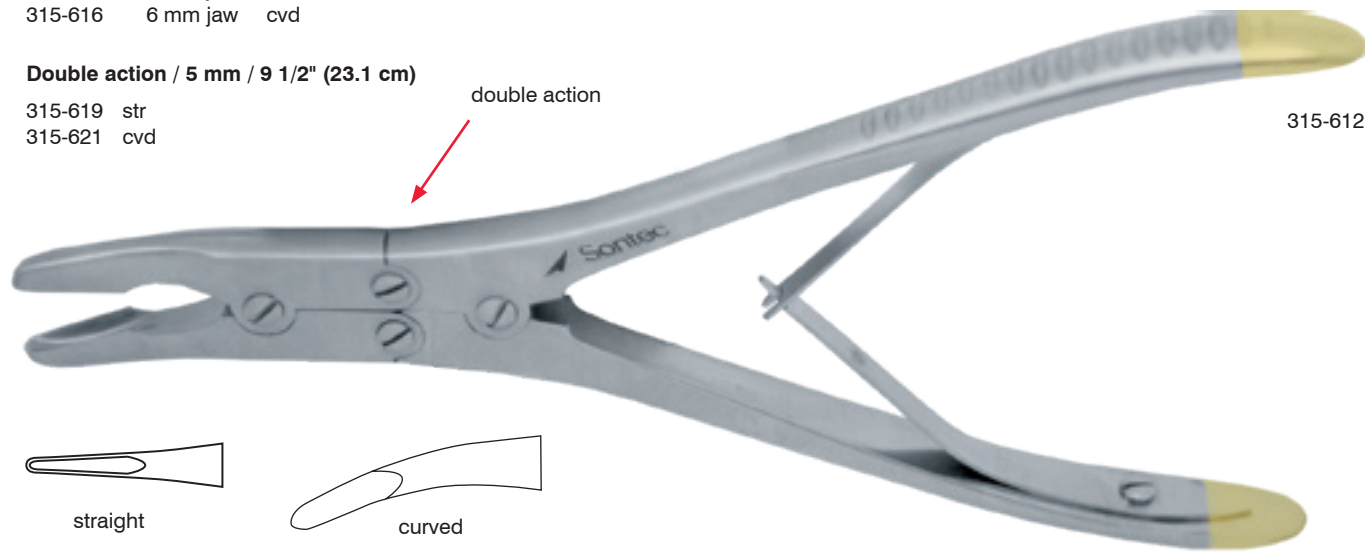

**Leksell Duckbill Rongeur**

**Double action / curved to side / 9" (23 cm)**

315-674	3 mm x 16 mm jaw
315-671	4 mm x 16 mm jaw
315-673	5 mm x 16 mm jaw
315-677	6 mm x 16 mm jaw
315-679	7 mm x 16 mm jaw
315-680	8 mm x 16 mm jaw

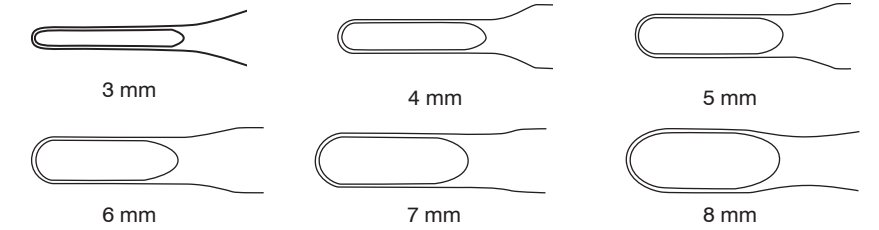

**Double action / curved to side / full curve / 9" (23 cm)**

315-676	3 mm x 16 mm jaw
315-672	4 mm x 16 mm jaw
315-675	5 mm x 13 mm jaw
315-678	6 mm x 16 mm jaw
315-681	7 mm x 16 mm jaw
315-682	8 mm x 16 mm jaw

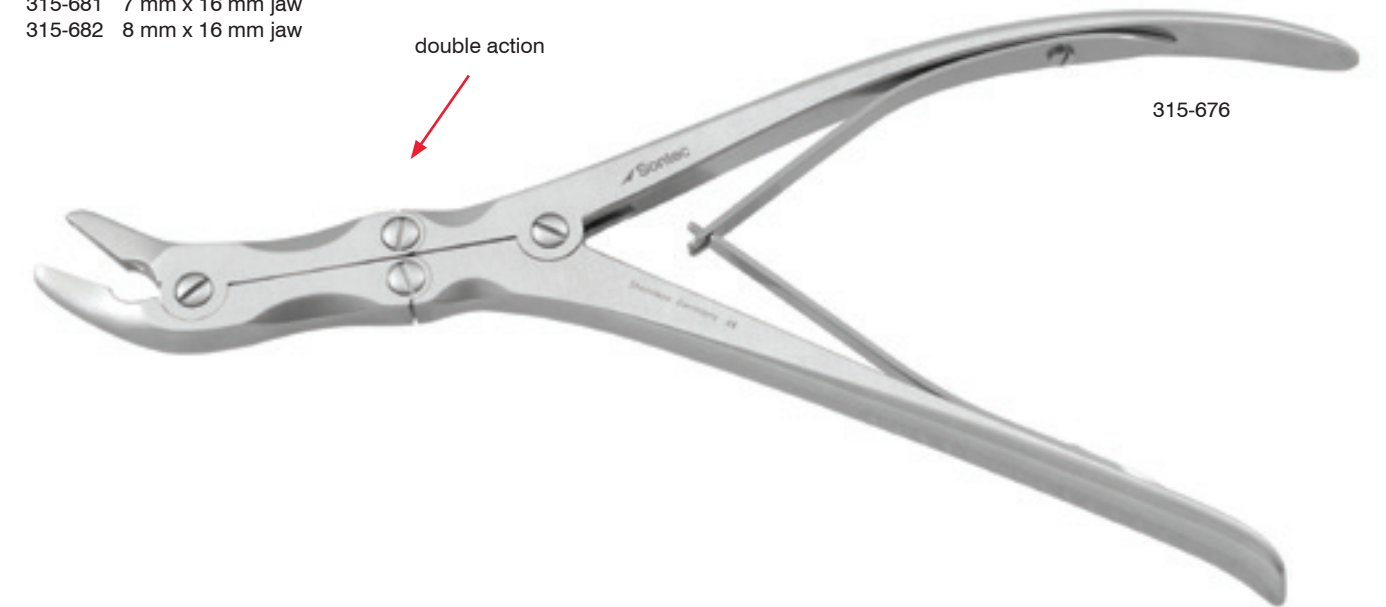



 Sontec Instruments®

Kerrison RONGEURS

**Universal Klick Kerrison Rongeur Set with Tray**

404-608-SET Set  
 Classic Standard Set includes:  
 404-6081 1 mm 40° 8" shaft  
 404-6082 2 mm 40° 8" shaft  
 404-6083 3 mm 40° 8" shaft  
 404-6084 4 mm 40° 8" shaft  
 404-6085 5 mm 40° 8" shaft  
 404-6086 2 universal handles

18-3564 tray only

To configure you own personalized set, refer to "Kerrison Section" > "Kerrison Universal Rotating 360° Rongeur" for all possible options

\*different size shafts available up request



**Kerrison Universal Rotating 360° Rongeur**

**Special**

404-606B handle \*special order

**Bayonet shaft / black ceramic / 12 1/2" (31.8 cm)**

404-6061B 1 mm bite 40°  
 404-6062B 2 mm bite 40°  
 404-6063B 3 mm bite 40°

**Endoscopic / black ceramic / 16" (40.6 cm)**

404-6063EB 3 mm bite 40°

**Quick trigger release / shaft locks in 8 positions through a 360° rotation / 8" (20cm) shaft**

404-6082B 2 mm bite 40° up curved with tissue ejector  
 404-6082C 2 mm bite 40° down curved with tissue ejector  
 404-60825E 2.5 mm bit 40°  
 404-6083B 3 mm bite 40° up curved with tissue ejector  
 404-6083E 3 mm bite 40° endoscopic

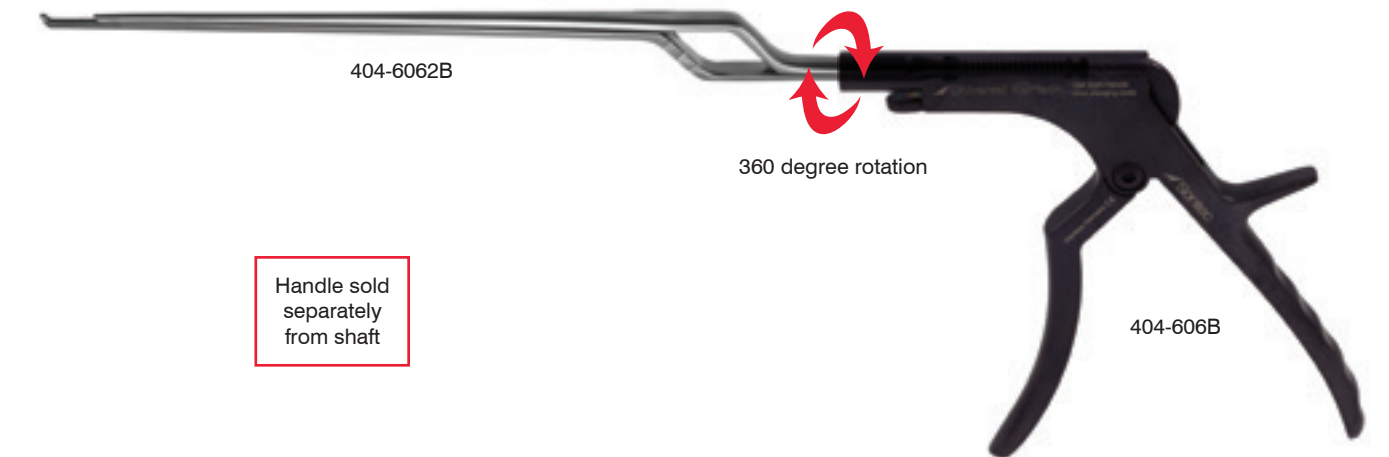
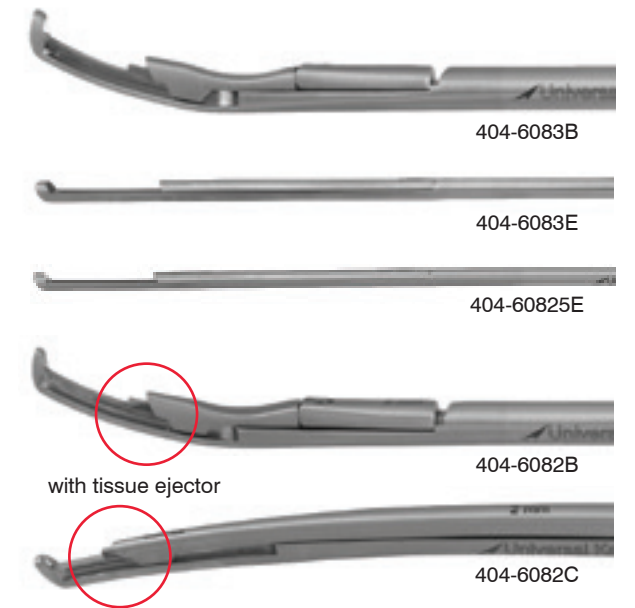

**Kerrison Universal Rotating 360° Rongeur**

Quick trigger release / with tissue ejector / shaft locks in 8 positions through a 360° rotation / 8" (20cm) shaft / 40°

- 404-606 handle
- 404-605 full set includes: handle all 40° sizes 8", all 90° sizes 8"
- 404-6081 1 mm bite
- 404-6082 2 mm bite
- 404-6083 3 mm bite
- 404-6084 4 mm bite
- 404-6085 5 mm bite

With tissue ejector / 10" (25.5cm) shaft

- 404-606 handle
- 404-607 full set includes: handle all 40° sizes 10", all 90° sizes 10"
- 404-6086 1 mm bite
- 404-6087 2 mm bite
- 404-6088 3 mm bite
- 404-6089 4 mm bite
- 404-6090 5 mm bite

7" (17.5cm) shaft

- 404-6091 0.8 mm bite
- 404-6093 1.5 mm bite

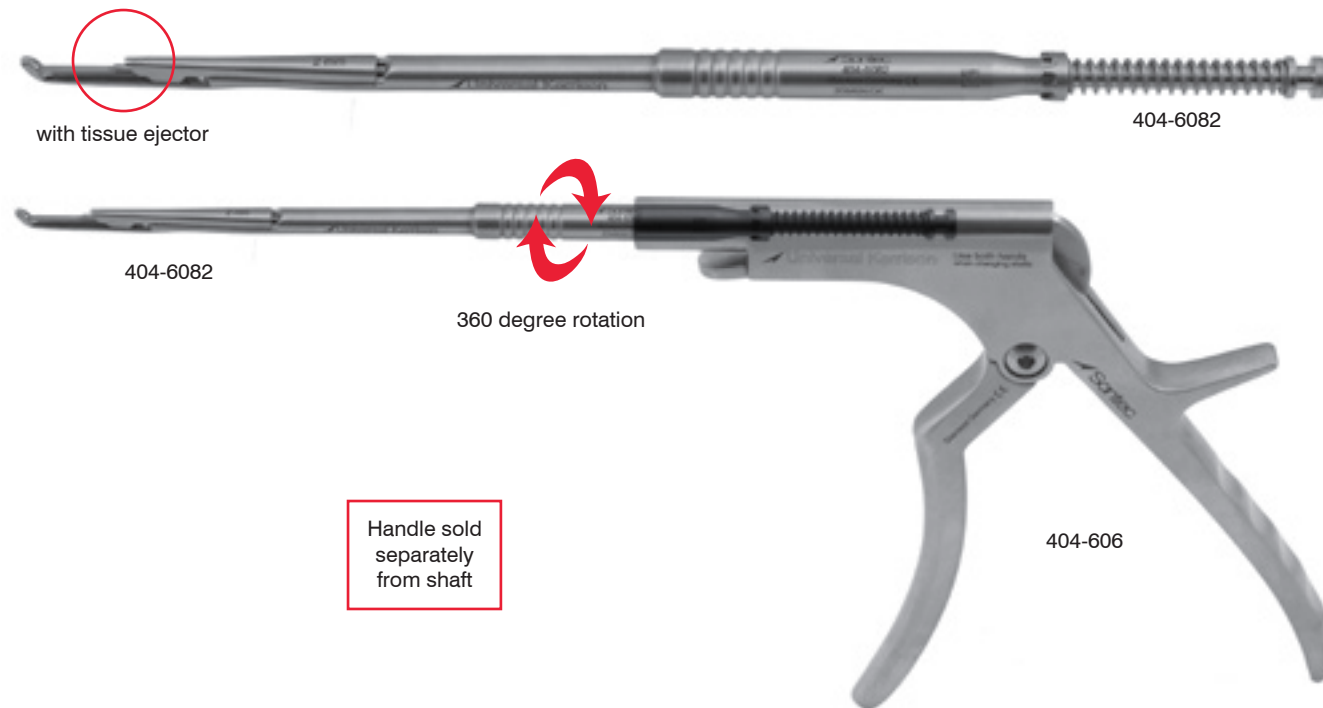

**Kerrison Universal Rotating 360° Rongeur**

Quick trigger release / with tissue ejector / shaft locks in 8 positions through a 360° rotation / 8" (20cm) shaft / 90°

- 404-606 handle
- 404-605 full set includes: handle all 40° sizes 8", all 90° sizes 8"
- 404-6071 1 mm bite 90°
- 404-6072 2 mm bite 90°
- 404-6073 3 mm bite 90°
- 404-6074 4 mm bite 90°
- 404-6075 5 mm bite 90°

With tissue ejector / 10" (25.5cm) shaft

- 404-606 handle
- 404-607 full set includes: handle all 40° sizes 10", all 90° sizes 10"
- 404-6076 1 mm bite 90°
- 404-6077 2 mm bite 90°
- 404-6078 3 mm bite 90°
- 404-6079 4 mm bite 90°
- 404-6080 5 mm bite 90°

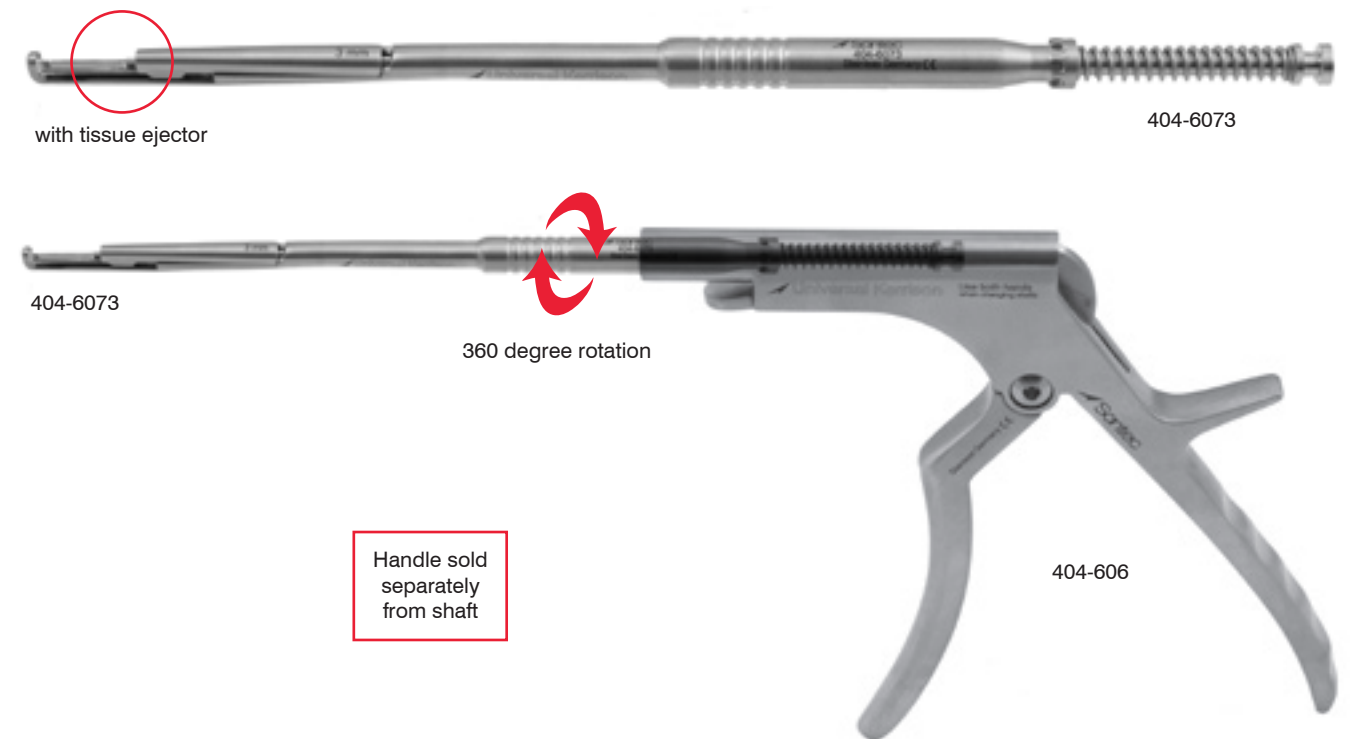



 Sontec Instruments®

Pistol Grip RONGEURS

**Weil-Blakesley Rongeur**

**Pointed elliptical fenestrated jaw / 4 1/2" (11.5 cm) shaft**

- 404-767 3 x 8 mm jaw
- 404-768 4 x 12 mm jaw
- 404-769 5 x 12.5 mm jaw
- 404-770 6 x 13 mm jaw

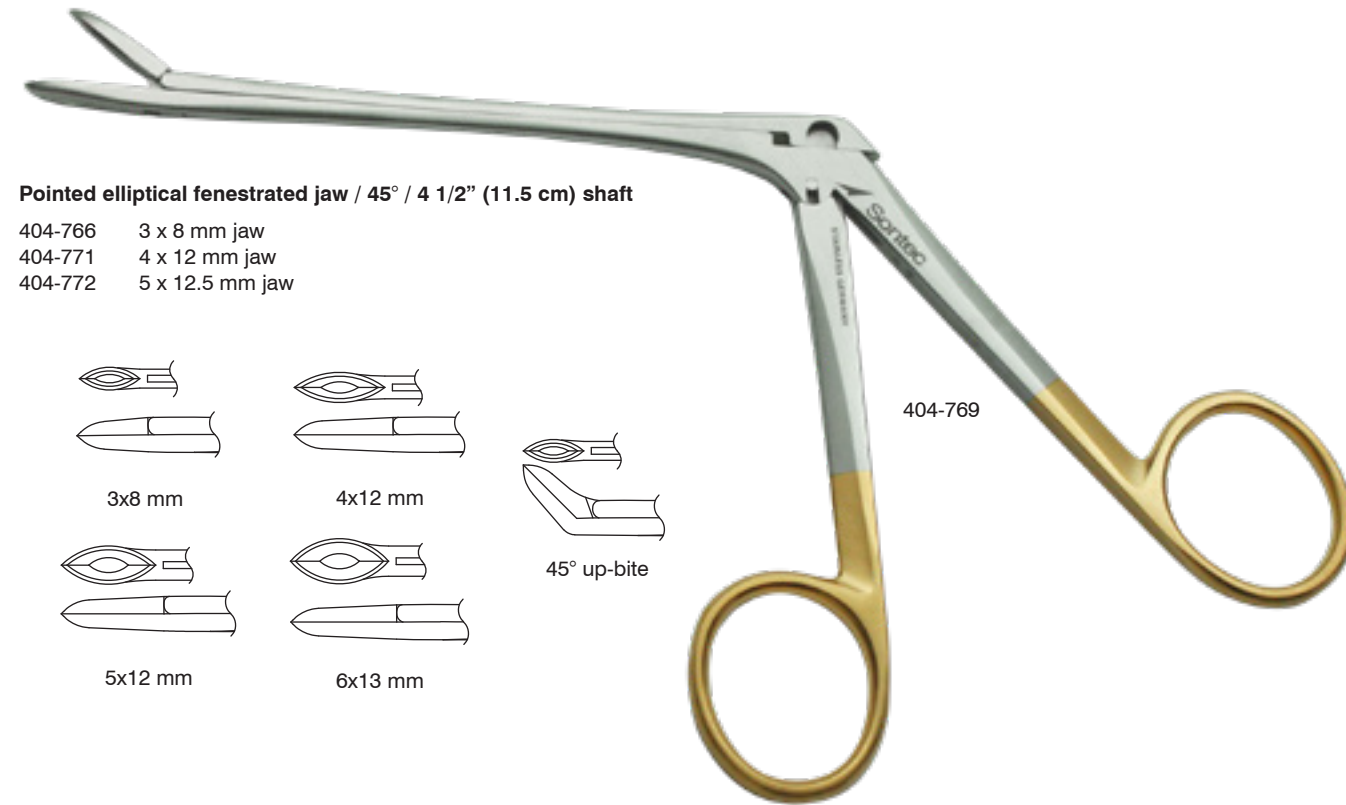

**Pointed elliptical fenestrated jaw / 45° / 4 1/2" (11.5 cm) shaft**

- 404-766 3 x 8 mm jaw
- 404-771 4 x 12 mm jaw
- 404-772 5 x 12.5 mm jaw

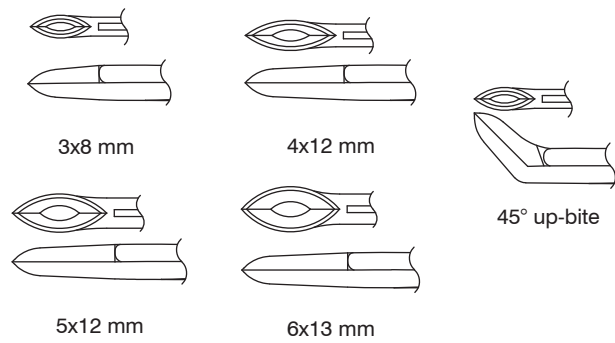

**Weil Nasal Rongeur**

**5 mm bite / 4 1/4" (10.5 cm) shaft**

- 468-548 straight
- 468-550 45° angled up



**Wilde Ethmoid Rongeur**

**Rounded elliptical fenestrated jaw / 4 1/2" (11.5 cm) shaft**

- 468-600 3x8 mm jaw
- 468-610 4x12 mm jaw
- 468-620 5x12.5 mm jaw

**Rounded elliptical fenestrated jaw / 45° up-bite / 4 1/2" (11.5 cm) shaft**

- 468-606 3x8 mm jaw
- 468-616 4x12 mm jaw
- 468-622 5x12.5 mm jaw

**Rounded elliptical fenestrated jaw / 3x8.0 mm jaw / with suction / 4 1/2" (11.5 cm) shaft**

- 468-636 straight
- 468-638P 45° up-bite

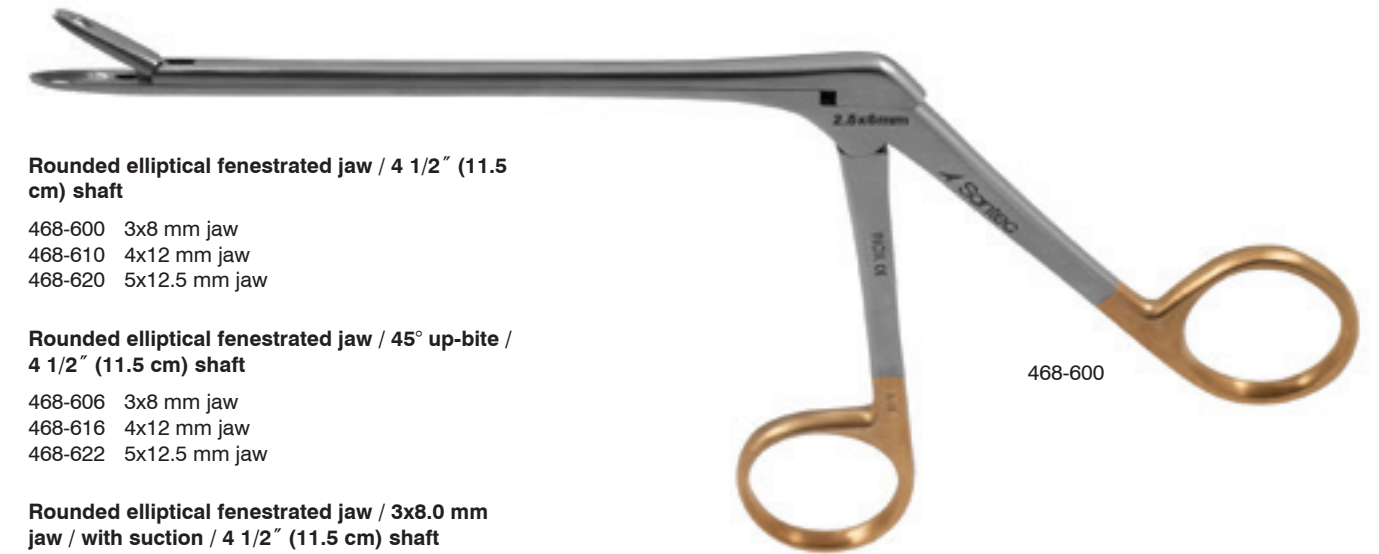
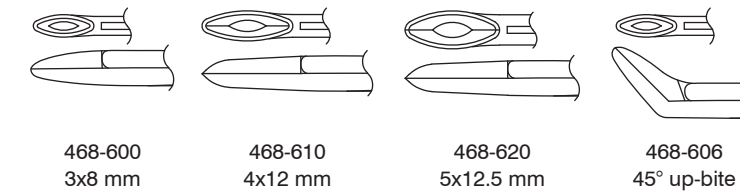

**Takahashi Rongeur**

**2.5 mm x 10 mm jaw cup / straight**

- 404-786 3 1/2" (9 cm) shaft
- 404-787 4 1/2" (11.5 cm) shaft
- 404-788 5 1/2" (14 cm) shaft

**3 mm x 10 mm jaw cup / 4 1/2" (11.5 cm) shaft**

- 404-788U up-angled
- 404-7871 straight

**3 mm x 8 mm oval jaw cup / straight**

- 404-7885 5 1/2" (14 cm) shaft

**3.5 mm x 10 mm jaw cup / straight**

- 404-7875 4" (10 cm) shaft



404-788U



404-7871



404-7875

**McIlwraith Cup Rongeur**

**Round cup / straight / 7" (18 cm) shaft**

- 1404-845A 2 mm cup
- 1404-845B 4 mm cup
- 1404-845D 6 mm cup

**Round cup / up-angled / 7" (18 cm) shaft**

- 1404-846A 2 mm cup
- 1404-846B 4 mm cup
- 1404-846D 6 mm cup



1404-846D



1404-845A



1404-845D

**Sheen Fragment Retriever Forceps**

**Low profile / 7" (18 cm)**

- 469-035



469-035

**Schlesinger (Cloward) Rongeur**

**Serrated bite / straight / 6" (15 cm) shaft**

- 404-754 2 mm x 10 mm bite
- 404-755 3 mm x 10 mm bite
- 404-755L 3 mm x 10 mm bite
- 404-756 4 mm x 10 mm bite
- 404-761 6 mm x 10 mm bite

7" shaft

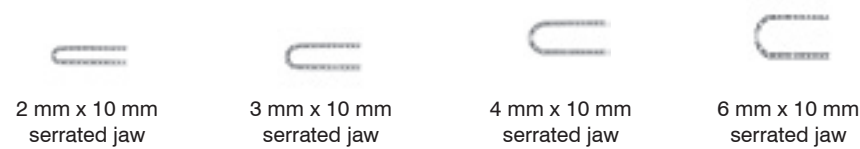

**Serrated bite / up-angled / 6" (15 cm) shaft**

- 404-758 2 mm x 10 mm bite
- 404-759 3 mm x 10 mm bite
- 404-760 4 mm x 10 mm bite
- 404-762 6 mm x 10 mm bite

**Serrated bite / down-angled / 6" (15 cm) shaft**

- 404-754D 2 mm x 10 mm bite
- 404-755D 3 mm x 10 mm bite
- 404-756D 4 mm x 10 mm bite
- 404-763 6 mm x 10 mm bite

**Spurling Pituitary Rongeur**

**4 mm x 10 mm bite**

- 404-740 straight 5" (12.5 cm) shaft
- 404-742 up-angled 5" (12.5 cm) shaft
- 404-744 down-angled 5" (12.5 cm) shaft
- 404-747 straight 7" (18 cm) shaft
- 404-749 up-angled 7" (18 cm) shaft
- 404-751 down-angled 7" (18 cm) shaft
- 404-739 straight 12" (30.5 cm) shaft
- 404-739U up angle 12" (30.5 cm) shaft
- 404-739D down angle 12" (30.5 cm) shaft



**NEW EASY CLEAN**

**Cushing Pituitary Rongeur**

**Easy clean / straight / 2 mm x 10 mm jaw / 7" (17.8 cm)**

404-719E



**Love Gruenwald Pituitary Rongeur**

**Easy clean / straight / 3 mm x 10 mm jaw / 7" (17.8 cm)**

404-734E



**Spurling Pituitary Rongeur**

**Easy clean / straight / 4 mm x 10 mm jaw / 7" (17.8 cm)**

404-747E



### Caspar Grasping Rongeur

#### Straight / 5 1/2" (14 cm) shaft

- 53-0510 2 mm x 12 mm jaw
- 53-0512 3 mm x 12 mm jaw
- 53-0514 4 mm x 14 mm jaw
- 53-0516 5 mm x 14 mm jaw
- 53-0518 6 mm x 16 mm jaw

#### Straight / 6 1/4" (16 cm) shaft

- 53-0520 2 mm x 12 mm jaw
- 53-0522 3 mm x 12 mm jaw
- 53-0524 4 mm x 14 mm jaw
- 53-0526 5 mm x 14 mm jaw
- 53-0528 6 mm x 16 mm jaw

#### Straight / 7 1/4" (18.5 cm)

- 53-0530 2 mm x 12 mm jaw
- 53-0532 3 mm x 12 mm jaw
- 53-0534 4 mm x 14 mm jaw
- 53-0536 5 mm x 14 mm jaw
- 53-0538 6 mm x 16 mm jaw

#### Straight / custom instrument / fenestrated / 6 mm x 16 mm jaw / 9" (23 cm) shaft

53-0539

#### Up-angled / 5 1/2" (14 cm) shaft

- 53-0542 3 mm x 12 mm jaw
- 53-0544 4 mm x 14 mm jaw
- 53-0546 5 mm x 14 mm jaw

#### Up-angled / 6 1/4" (16 cm) shaft

- 53-0552 3 mm x 12 mm jaw
- 53-0554 4 mm x 14 mm jaw
- 53-0556 5 mm x 14 mm jaw

#### Up-angled / 7 1/4" (18.5 cm) shaft

- 53-0560 2 mm x 12 mm jaw
- 53-0562 3 mm x 12 mm jaw
- 53-0564 4 mm x 14 mm jaw
- 53-0566 5 mm x 14 mm jaw

#### Down-angled / 5 1/2" (14 cm) shaft

- 53-0572 3 mm x 12 mm jaw
- 53-0574 4 mm x 14 mm jaw

#### Down-angled / 6 1/4" (16 cm) shaft

- 53-0582 3 mm x 12 mm jaw
- 53-0584 4 mm x 14 mm jaw

#### Down-angled / 7 1/4" (18.5 cm) shaft

- 53-0590 2 mm x 12 mm jaw
- 53-0592 3 mm x 12 mm jaw
- 53-0594 4 mm x 14 mm jaw

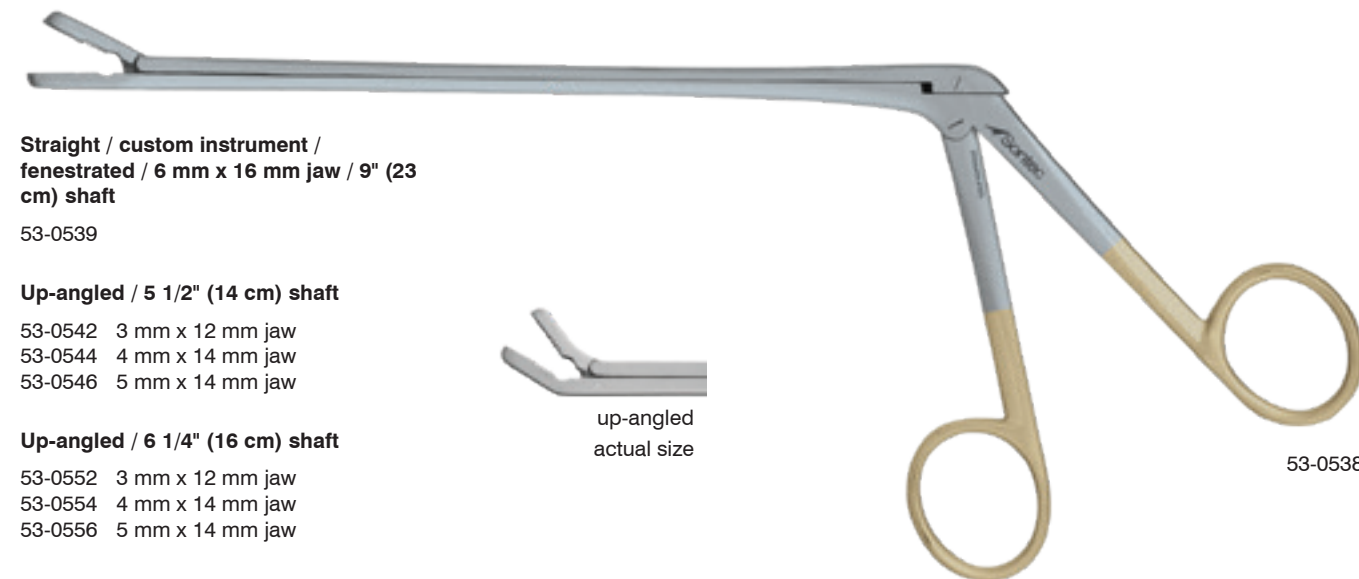
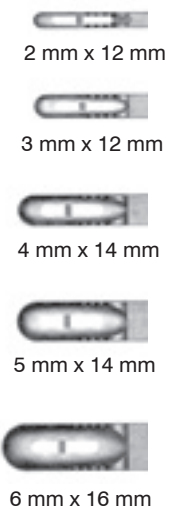

up-angled  
actual size



down-angled  
actual size

### Ferris-Smith Arthroscopic Rongeur

#### 4 mm x 6 mm square jaw / 7" (18 cm) shaft

- 404-813 round jaw
- 404-814 square jaw



### Ferris-Smith Arthroscopic Rongeur

#### Low profile / straight / 7" (18 cm) shaft

- 404-790LP 2 mm x 10 mm bite
- 404-791LP 3 mm x 10 mm bite
- 404-792LP 4 mm x 10 mm bite
- 404-793LP 4 mm x 8 mm bite
- 404-796LP 5 mm x 10 mm bite
- 404-794LP 6 mm x 10 mm bite
- 404-795LP 6 mm x 12 mm bite
- 404-795SLP 6 mm x 12 mm bite serrated

#### Low profile / up-angled / 7" (18 cm) shaft

- 404-800LP 2 mm x 10 mm bite
- 404-801LP 3 mm x 10 mm bite
- 404-802LP 4 mm x 10 mm bite
- 404-803LP 6 mm x 10 mm bite

#### Low profile / down-angled / 7" (18 cm) shaft

- 404-810LP 2 mm x 10 mm bite
- 404-811LP 3 mm x 10 mm bite
- 404-812LP 4 mm x 10 mm bite

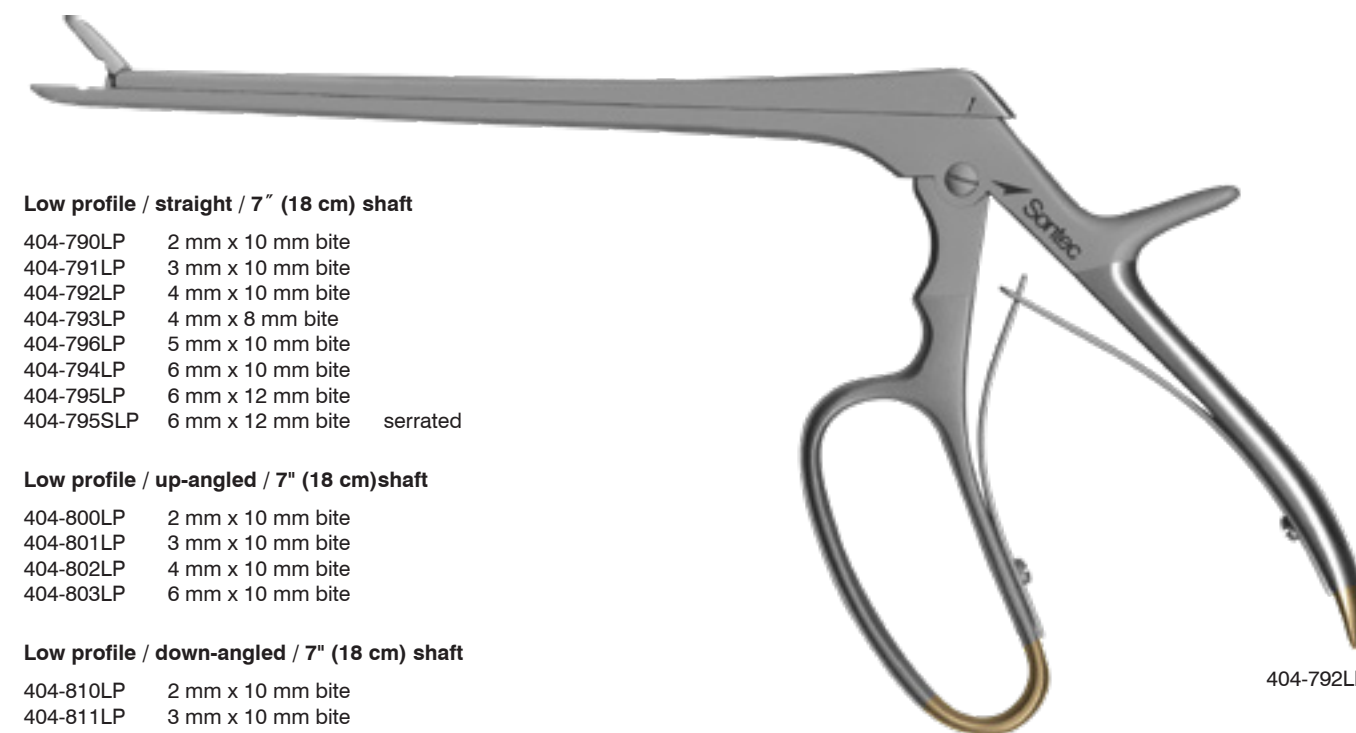

**Ferris-Smith Arthroscopic Rongeur**

**Straight / 7" (18 cm) shaft**

404-790	2 mm x 10 mm bite	
404-791	3 mm x 10 mm bite	
404-792	4 mm x 10 mm bite	
404-792B	4 mm x 10 mm bite	Ceramitec
404-793	4 mm x 8 mm bite	
404-792S	4 mm x 10 mm bite	serrated
404-796	5 mm x 10 mm bite	
404-794	6 mm x 10 mm bite	
404-795	6 mm x 12 mm bite	

**Straight/ 8" (20.5 cm) shaft / special order**

404-825	2 mm x 10 mm bite	
404-826	3 mm x 10 mm bite	
404-827	4 mm x 10 mm bite	
404-828	5 mm x 10 mm bite	
404-829	6 mm x 10 mm bite	

**Straight/ 9" (23 cm) shaft**

404-7929	4 mm x 10 mm bite	
404-7929LP	4 mm x 10 mm bite	low profile
404-7959	6 mm x 12 mm bite	

**Up-angled / 7" (18 cm) shaft**

404-800	2 mm x 10 mm bite	
404-801	3 mm x 10 mm bite	
404-802	4 mm x 10 mm bite	
404-802S	4 mm x 10 mm bite	serrated
404-803	6 mm x 10 mm bite	

**Up-angled/ 8" (20.5) shaft / special order**

404-830	2 mm x 10 mm bite	
404-831	3 mm x 10 mm bite	
404-832	4 mm x 10 mm bite	
404-833	5 mm x 10 mm bite	
404-834	6 mm x 10 mm bite	

\*special order

**Down-angled / 7" (18 cm) shaft**

404-810	2 mm x 10 mm bite	
404-811	3 mm x 10 mm bite	
404-812	4 mm x 10 mm bite	

**Down-angled / 8" (20.5 cm) shaft / special order**

404-835	2 mm x 10 mm bite	
404-836	3 mm x 10 mm bite	
404-837	4 mm x 10 mm bite	
404-838	5 mm x 10 mm bite	
404-839	6 mm x 10mm bite	

\*special order

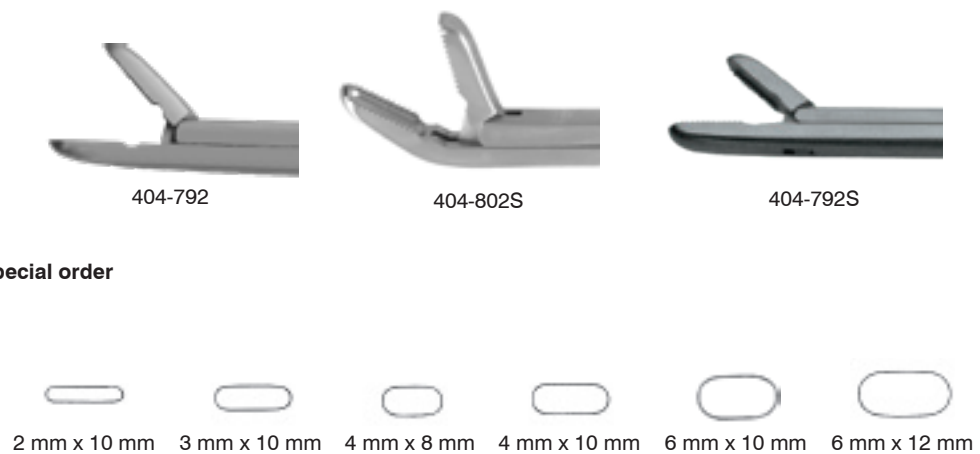

404-792



404-792B

**Ferris-Smith Rongeur**

With Kerrison handle / straight / 4 mm x 8 mm / 7" (18 cm) shaft

404-793K



404-793K

**Ferris-Smith Wilde Rongeur**

Straight / powerful, low profile, tapered Wilde jaw design / 5 mm x 10 mm bite / 7" (18 cm) shaft

404-777



404-777

**Ferris-Smith Spinal Extended Shaft Rongeur**

Extra long shaft / straight / 12" (30.5 cm) shaft

- 404-822 4mm x 10mm bite serrated
- 404-823 3mm x 10mm bite

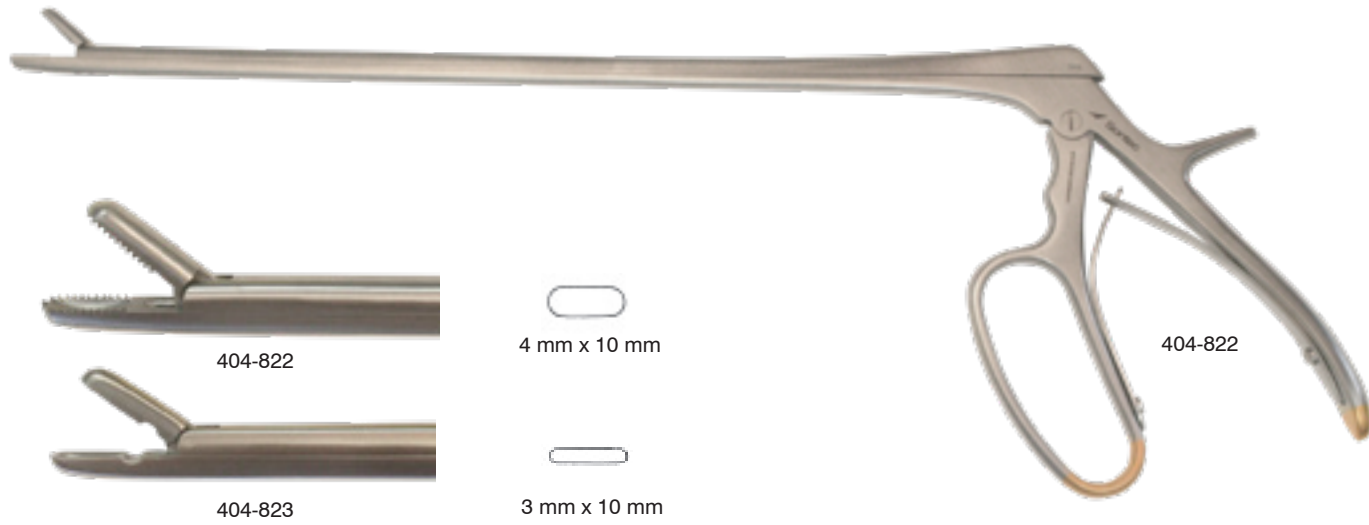

**Decker Micro Rongeur**

2 mm x 6 mm bite

- 469-053 straight 3 1/2" (9 cm) shaft
- 469-056 straight 6" (15 cm) shaft
- 469-057 cvd right 6" (15 cm) shaft
- 469-058 cvd left 6" (15 cm) shaft
- 469-055 angled up 6" (15 cm) shaft

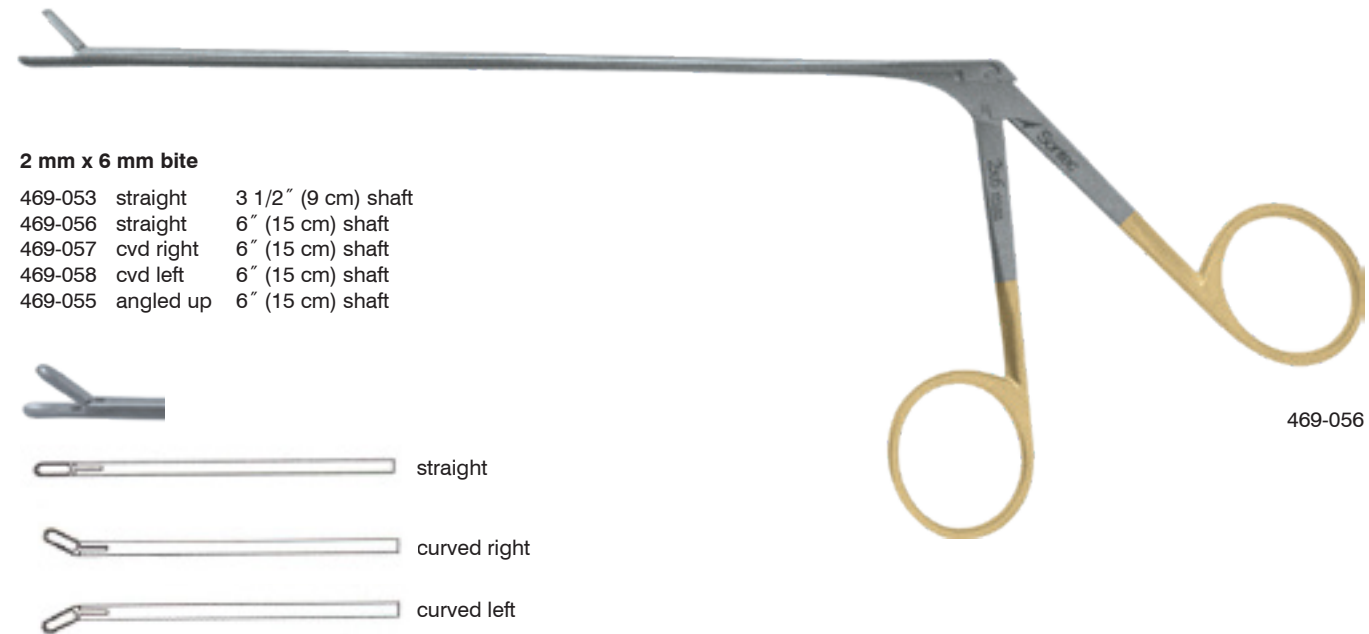

**Hoehn Grasping Forceps**

1 x 2 teeth / 5 1/2" (14 cm) shaft

1404-862



**McIlwraith Arthroscopic Grasping Rongeur**

Heavy duty / 1 x 2 teeth / 6 1/2" (16.5 cm) shaft

- 1404-860 4 mm x 10 mm jaw
- 1404-865 3.4 mm x 10 mm standard
- 1404-861 3 mm x 10 mm jaw delicate



**Williams-Sontec Rongeur**

For arthroscopy & discectomy / very sharp / 2 mm x 5 mm jaw / 1 x 2 teeth / 5 1/2" (14 cm) shaft

404-824



actual size



404-824

**Mcllwraith Basket Cutter Rongeur**

5" (12.5 cm)

1404-857 2.5 mm x 8 mm jaw

1404-858 3.5 mm x 8 mm jaw



actual size



1404-857

**Mcllwraith Arthroscopic Scissors Rongeur**

Scissor action / serrated / 1 mm x 14 mm cup / 5" (12.5 cm) shaft

1404-855



1404-855

**Mcllwraith-Peapod Rongeur**

Longer shaft available by special order

**Straight / 5 1/2" (14 cm) shaft**

404-782 2.2 mm x 6 mm jaw cup

**Up-angled / 5 1/2" (14 cm) shaft**

404-783 2.2 mm x 6 mm jaw cup small

404-784 3 mm x 6 mm jaw cup medium

404-785 4 mm x 6 mm jaw cup large



404-783

**Uterine Biopsy Punch**

Oval basket / 8 1/2" (21.5 cm) shaft  
525-256



525-256

**Uterine Biopsy Forceps**

Horizontal Oval basket / 11" (27.9 cm) shaft  
525-254



525-254

**Sontec Triangle Biopsy Punch Rongeur**

Triangular basket / 5 1/2" (14 cm) shaft  
478-322 size 0  
1100-767A size 1  
1100-767B size 2  
1100-767C size 3

Triangular basket / 8" (20 cm) shaft  
1100-768A size 1  
1100-768B size 2  
1100-768C size 3

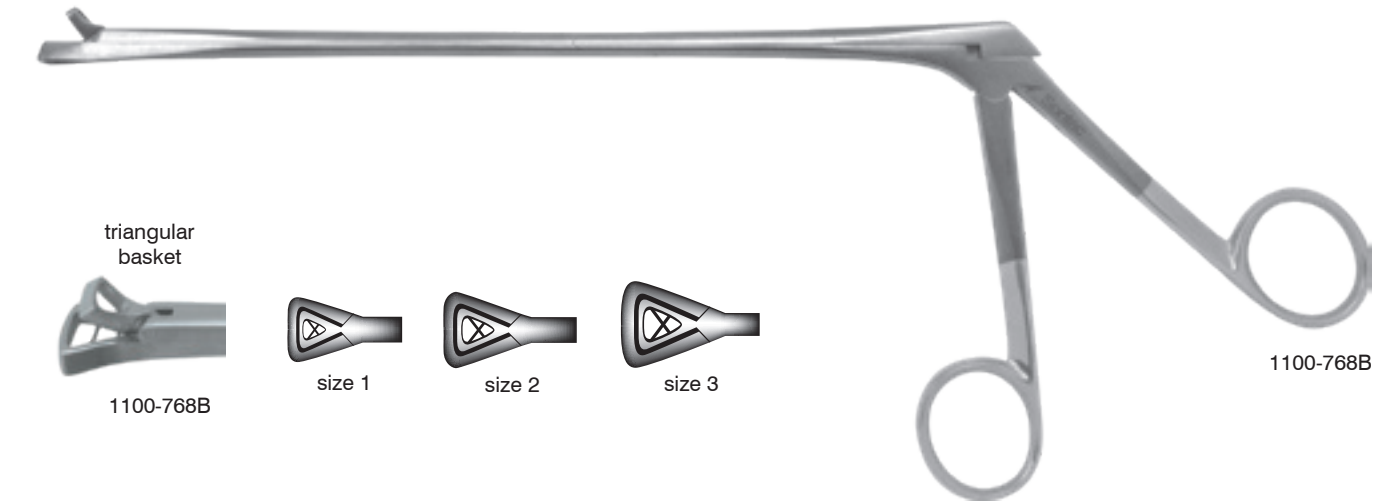

1100-768B

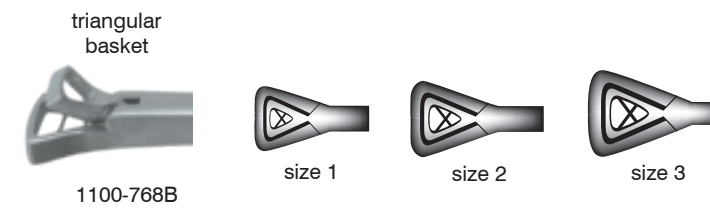

**Yeoman Biopsy Punch Rongeur**

Square basket / 11" (28 cm) shaft  
90-0620 small punch  
90-0630 large punch

Square basket / 14 1/2" (37 cm) shaft  
90-0622 small punch  
90-0632 large punch

Round basket / 360° rotating shaft / 13" (33 cm) shaft  
90-0652 straight punch  
90-0662 angled punch

Round basket / 360° rotating shaft / 16" (40.6 cm) shaft  
90-0654 straight punch  
90-0664 angled punch

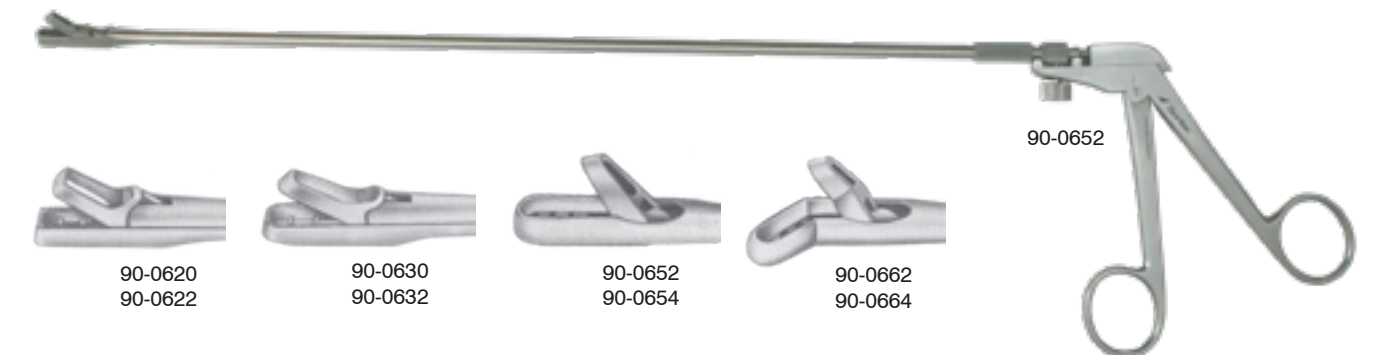

90-0652

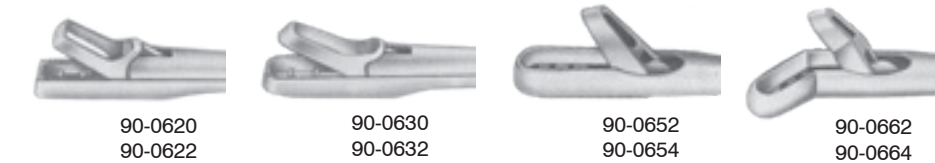



 Sontec Instruments®

ALLIGATOR BIOPSY FORCEPS

**Sontec Alligator Forceps**

With lock / delicate jaw / delicate shaft

- 1100-328L 3 1/2" (9 cm) long jaw
- 1100-330S 5 1/2" (14 cm) shaft
- 1100-333 6 1/2" (16.5 cm) shaft
- 1100-334 9" (23 cm) shaft



1100-328L

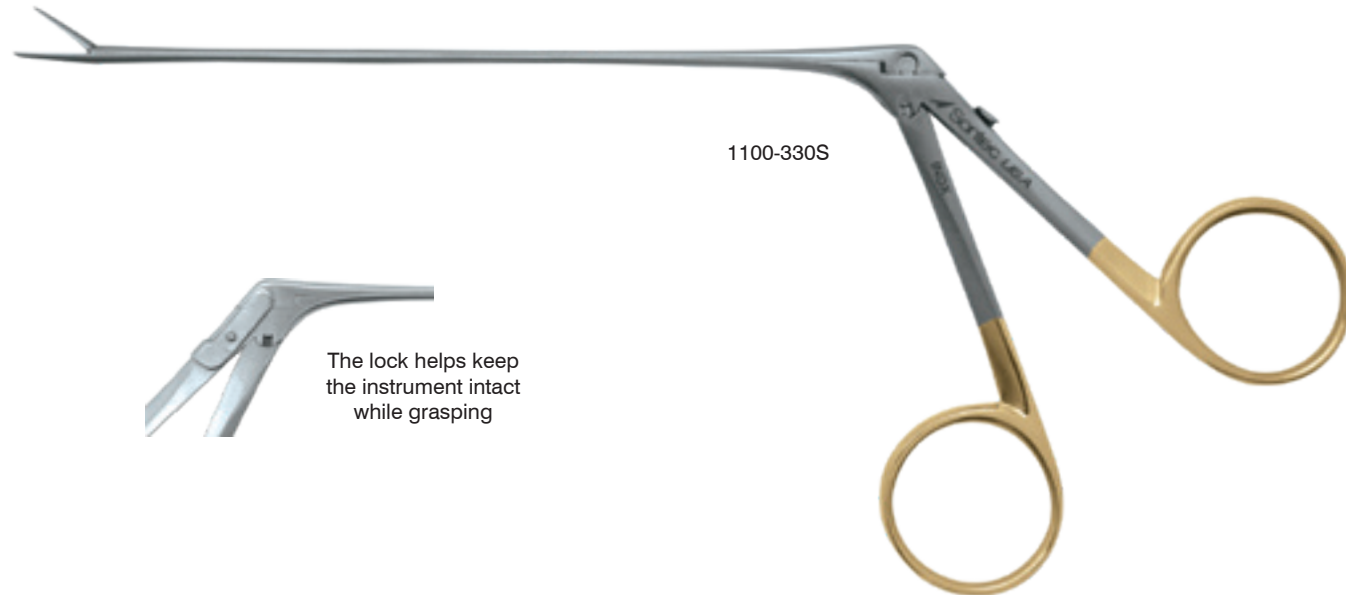

1100-330S



The lock helps keep the instrument intact while grasping

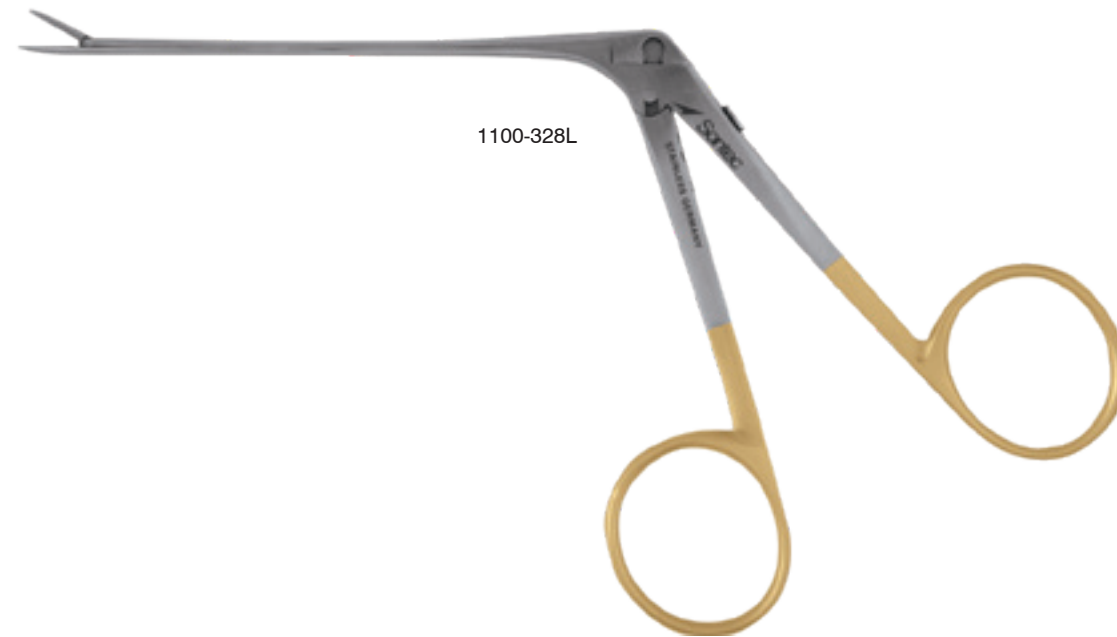

1100-328L

**Sontec Micro Alligator Forceps**

Delicate / lacrimal ducts / 4 mm x 0.9 mm jaw / 3 1/4" (8 cm) shaft

- 469-040 straight with lock
- 469-050 angled right with lock
- 469-048 angled left with lock
- 469-036 straight without lock



469-040

**Hartman Alligator Forceps**

1 x 2 teeth / 6 1/2" (16.5 cm)

- 1100-331



**Alligator Forceps Tubular Shaft**

Delicate, flexible, tubular shaft / jaw width is uniform / 10 mm length x 1 mm width

- 1271-010 3 1/2" (9 cm) shaft
- 1271-011 5 1/2" (14 cm) shaft
- 1271-012 6 1/2" (16.5 cm) shaft
- 1271-013 9" (23 cm) shaft

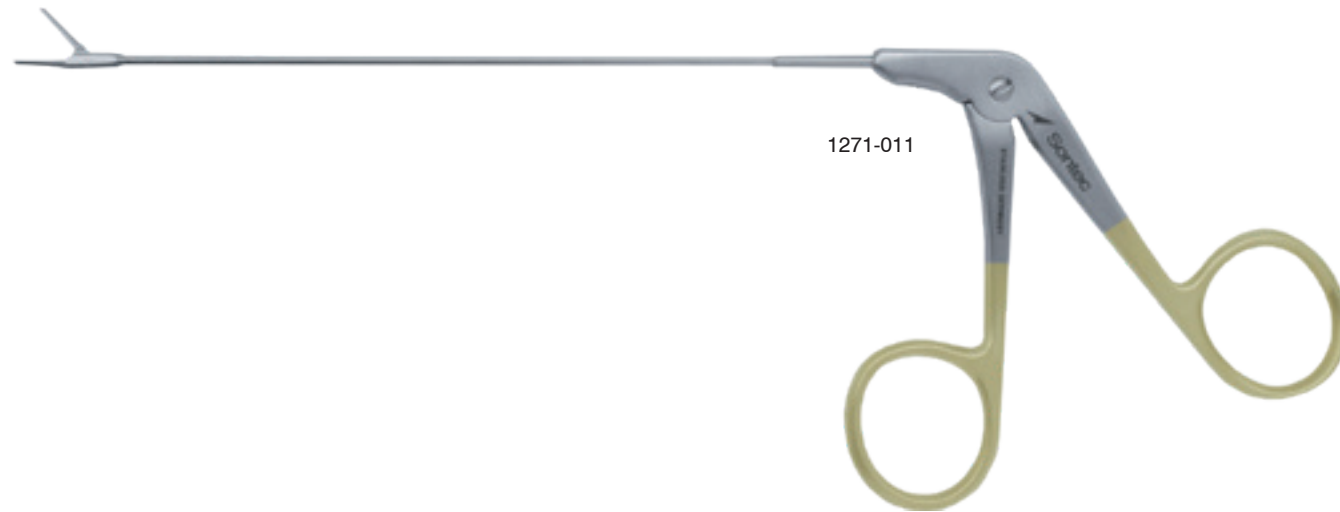

**Sontec Alligator Forceps**

Standard jaw / jaw length 10 mm / standard shaft / jaw width 2.2 tapering at tip to 1mm

- 1100-328 3 1/2" (9 cm) shaft
- 1100-330 5 1/2" (14 cm) shaft
- 1100-332 6 1/2" (16.5 cm) shaft

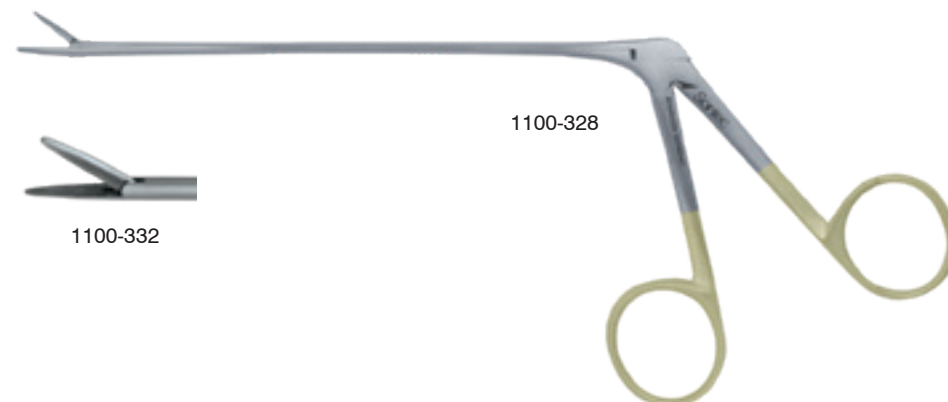

**Arthroscopic Grasping & Biopsy Combo Rongeur Forceps**

Tubular shaft / serrated bite

- 1271-020 2.0 mm cup 4" (10 cm) shaft
- 1271-020R 2.0 mm cup 4" (10 cm) shaft
- 1271-016 2.7 mm cup 4" (10 cm) shaft
- 1271-018 3.4 mm cup 4" (10 cm) shaft
- 1271-021 2.0 mm cup 6" (15.5 cm) shaft
- 1271-021A 2.0 mm cup 6" (15.5 cm) shaftrear actuator hand

\* Available in 4.5 mm, please ask for details

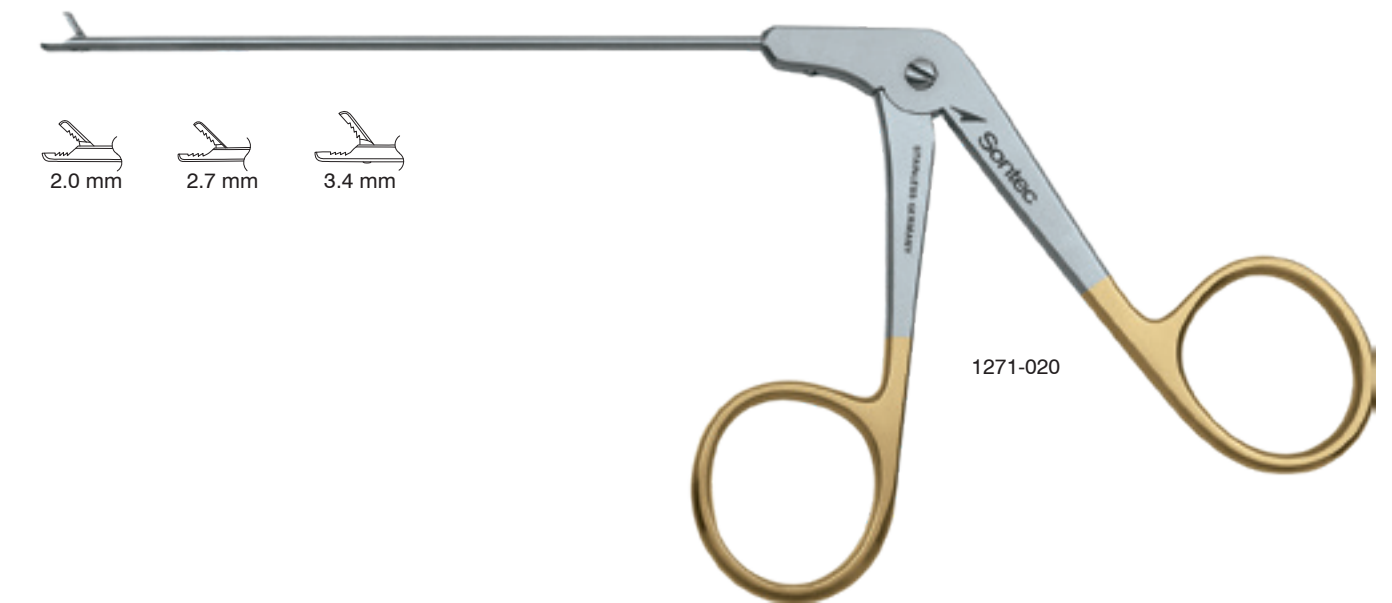

**Jackson / Biopsy Forceps**

**Round cup / straight / 11" (28 cm) shaft**

- 1100-771A 2 mm cup
- 1100-769 4 mm cup
- 1100-770 6 mm cup

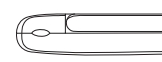
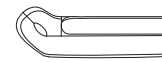

1100-710A

1100-718A

**Round cup / straight / 11 3/4" (29.75 cm) shaft**

- 1100-718A 2 mm cup
- 1100-718B 4 mm cup
- 1100-718C 6 mm cup

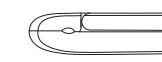
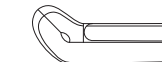

1100-710B

1100-718B

**Round cup / straight / 15 3/4" (40 cm) shaft**

- 1100-720A 2 mm cup
- 1100-720B 4 mm cup
- 1100-720C 6 mm cup

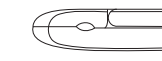

1100-710C

1100-718C

**Round cup / straight / 19 3/4" (51 cm) shaft**

- 1100-722A 2 mm cup
- 1100-722B 4 mm cup
- 1100-722C 6 mm cup

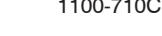

**Round cup / up-angled / 11" (28 cm) shaft**

- 1100-771B 2 mm cup

**Round cup / up-angled / 11 3/4" (29.75 cm) shaft**

- 1100-710A 2 mm cup
- 1100-710B 4 mm cup
- 1100-710C 6 mm cup



1100-710C

**Round cup / up-angled / 15 3/4" (40 cm) shaft**

- 1100-712A 2 mm cup
- 1100-712B 4 mm cup
- 1100-712C 6 mm cup

**Round cup / up-angled / 19 3/4" (51 cm) shaft**

- 1100-714A 2 mm cup
- 1100-714B 4 mm cup
- 1100-714C 6 mm cup

**Round cup / up-angled / 23 3/4" (61 cm) shaft**

- 1100-716A 2 mm cup
- 1100-716B 4 mm cup
- 1100-716C 6 mm cup

**Sontec Micro Biopsy Forceps**

**Round cup**

- 469-062 1.0 mm cup 3 1/4" (8 cm) shaft
- 469-063 2.0 mm cup 3 1/4" (8 cm) shaft
- 469-063A 2.0 mm cup 3 1/4" (8 cm) shaft angled up
- 469-063M 2.5 mm cup 3 1/4" (8 cm) shaft
- 469-063L 3.0 mm cup 3 1/4" (8 cm) shaft
- 469-063X 4.0 mm cup 3 1/4" (8 cm) shaft
- 469-081 1.0 mm cup 6" (15 cm) shaft
- 469-082 2.0 mm cup 6" (15 cm) shaft
- 469-080 2.5 mm cup 6" (15 cm) shaft
- 469-083 3.0 mm cup 6" (15 cm) shaft
- 469-084 4.0 mm cup 6" (15 cm) shaft
- 469-085 5.0 mm cup 6" (15 cm) shaft



469-063M

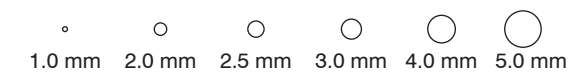



 Sontec Instruments®

Orthopedic DRILLS, DRILL GUIDES & CHUCKS

**Sontec I.M. Pin Chuck**

**Stainless steel keyed drill chuck**

- 1103-190 3/8"
- 1103-191 5/16"

**Key for Sontec I.M. pin chuck**

- 1103-185K for 3/8" chuck
- 1103-184K for 5/16" chuck

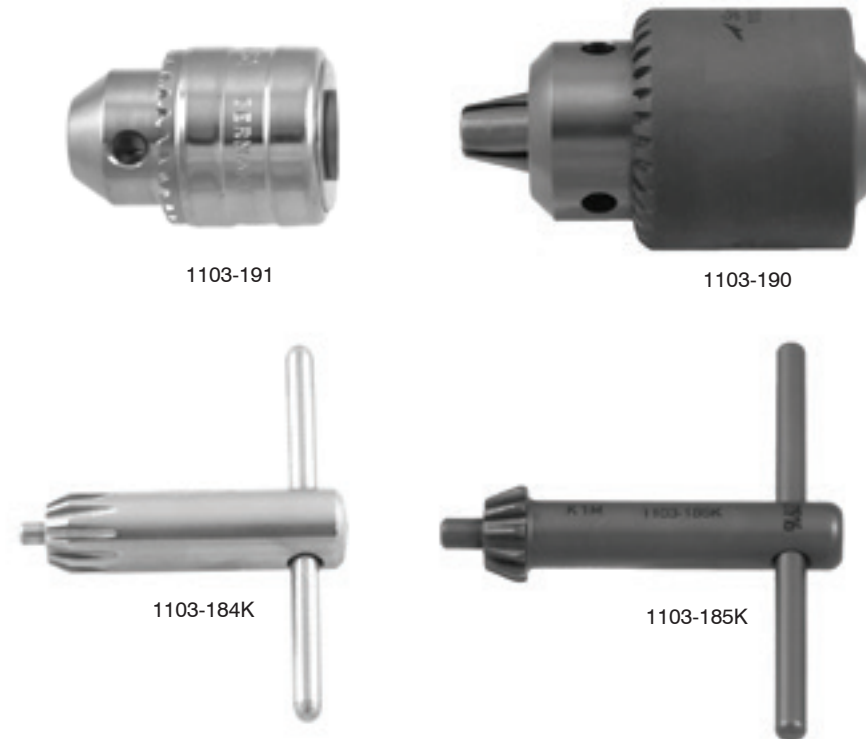

**Sontec Hybrid I.M. Pin Chuck**

**Stainless steel universal use with or without key drill chuck**

- 1103-193 3/8"

**Key for 3/8" hybrid chuck**

- 1103-193K

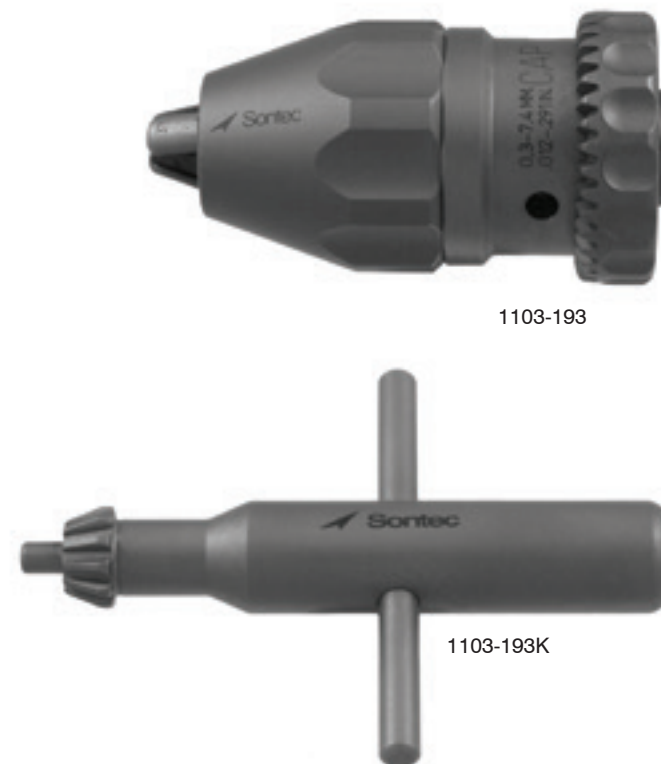

**Sontec I.M. Pin Chuck Set**

**with aluminum handle**

- 1103-184-SET

**Set includes:**

- 1103-191 stainless steel 5/16" chuck
- 1103-184K key
- 1103-191H aluminum handle
- 1103-187 extension handle

- 1103-185-SET

**Set includes:**

- 1103-190 stainless steel 3/8" chuck
- 1103-185K key
- 1103-190H aluminum handle
- 1103-187 extension handle



**Sontec I.M. Pin Chuck Set**

**with t-handle**

- 1103-184T-SET

**Set includes:**

- 1103-191 stainless steel 5/16" chuck
- 1103-184K key
- 1103-185T t-handle

- 1103-185T-SET

**Set includes:**

- 1103-190 stainless steel 3/8" chuck
- 1103-185K key
- 1103-185T t-handle



**K-Wire Pin Driver**

Cannulated for K-wire / 6 3/8" (15.5 cm)

1103-180

1103-180T titanium



1103-180



1103-180T

**Universal Drill Guide**

With adjustable spiked head and 3 different sized interchangeable guide tubes

1103-168-SET

Set include:

1103-168 Universal Drill Guide body with spike

1103-16820 2.0 mm guide tube

1103-16827 2.7 mm guide tube

1103-16835 3.5 mm guide tube



1103-16827



1103-16835

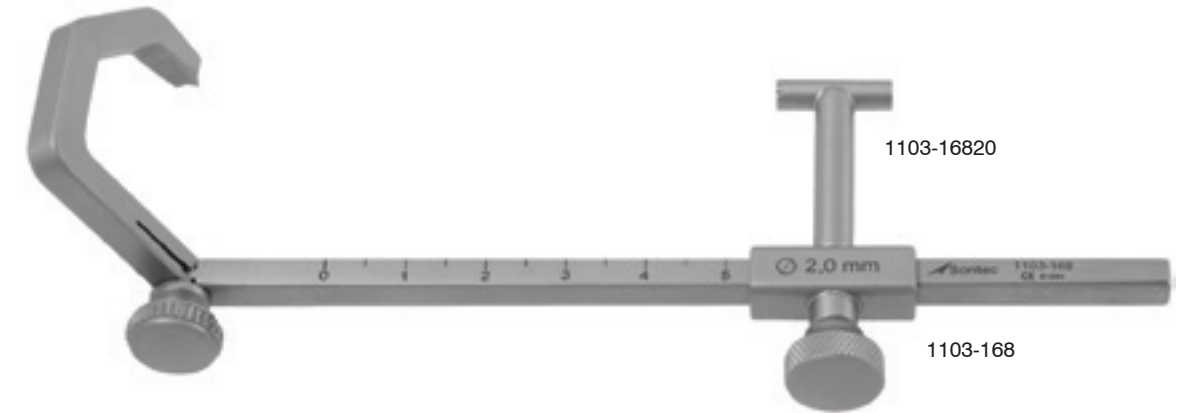

1103-16820

1103-168



 Sontec Instruments®

Orthopedic ELEVATORS

**Freer Periosteal Elevator**

Double-ended / square handle / straight / 4.5 mm tip / sharp/blunt / 7 3/4"

1100-798S

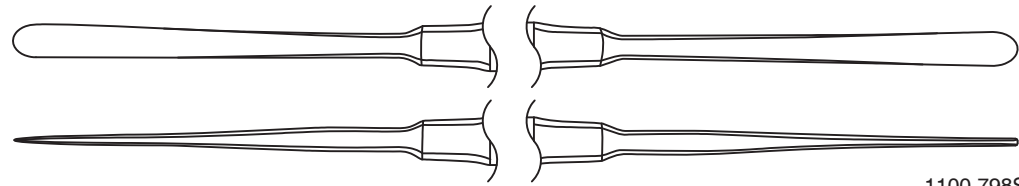

1100-798S

Double-ended / square handle / curved / 4.5 mm tip / sharp/blunt

1100-798 7 3/4"

1100-798G 8 1/2"

1100-798F 8 3/4"



1100-798

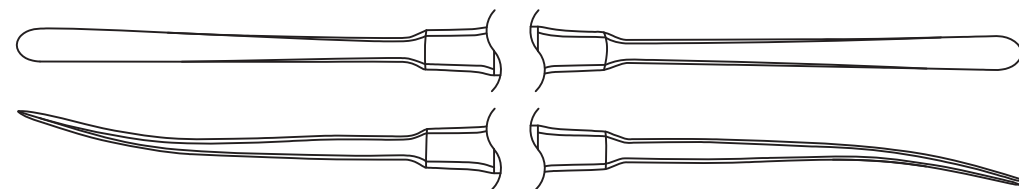

Double-ended / square handle / curved / 6.5 mm tip / sharp/blunt

1100-798A 7 3/4"

1100-798E 8 3/4"



1100-798A

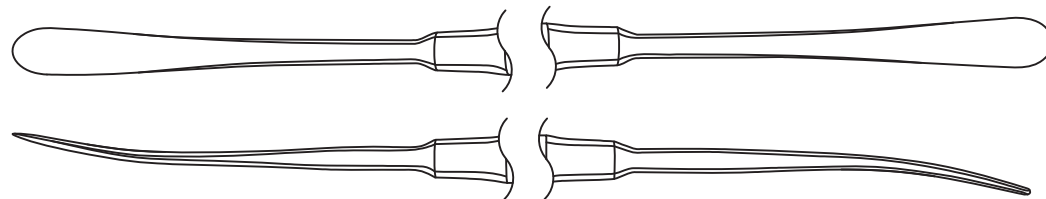

**Freer Periosteal Elevator**

Double-ended / round handle / curved / sharp/blunt / 7 1/2"

1100-798B 5 mm tip

1100-798C 6.7 mm tip



1100-798B

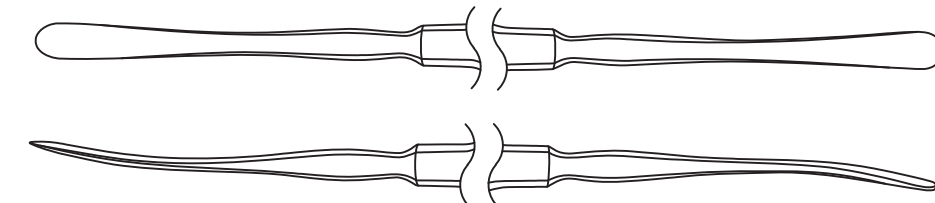

1100-798C

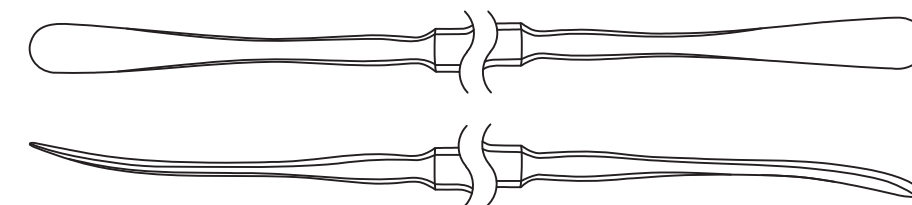

Double-ended / knurled round handle / curved / 4.5 mm tip / sharp/blunt / 6 3/4"

1100-798D



1100-798D

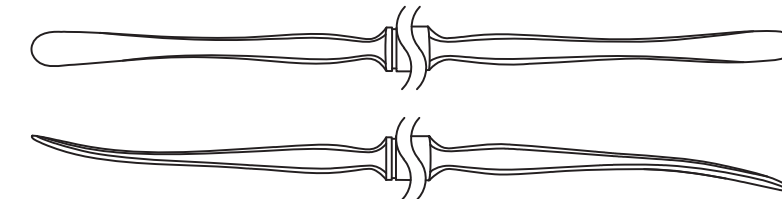

**Freer Periosteal Elevator**

Double-ended / round handle / curved / 3.5 mm tip  
/ sharp / 7 1/4"  
1100-798H

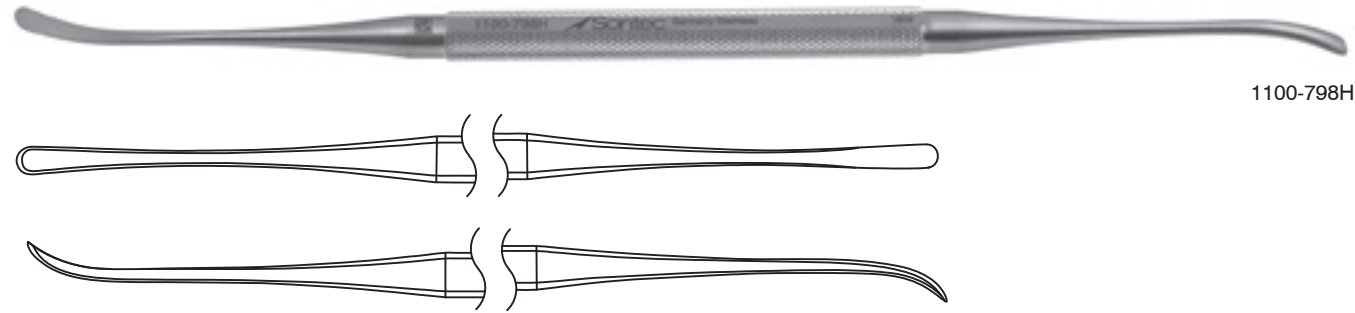

1100-798H

**Adson Periosteal Elevator**

Single-ended / 6 1/2" (16.5 cm)  
412-520 str chisel edge  
412-522 cvd blunt  
412-524 cvd semi-sharp  
412-526 str semi-sharp



412-522

412-524

412-526

**Love Adson Periosteal Elevator**

Single-ended / 6 3/4" (16.5 cm)  
412-528 cvd semi-sharp



412-528

**Langenbeck Periosteal Elevator**

Single-ended / 8" (20 cm)  
335-205 narrow blunt tip 6 mm  
335-207 wide sharp tip 17 mm

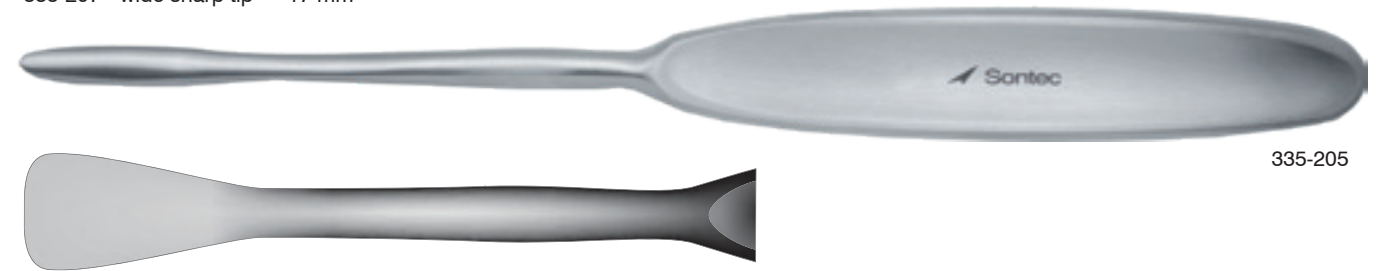

335-205

335-207

**Hoer Periosteal Elevator**

7 mm tip / 6 1/4" (16 cm)  
412-530



412-530

**Lane Periosteal Elevator**

Single-ended / 7 1/2" (19 cm)  
335-210 narrow semi-sharp tip 6 mm  
335-212 wide semi-sharp tip 10 mm



335-210

335-212

**Sontec A O Type Elevator / Raspatory**

Phenolic handles / 7 1/2" (19 cm)

335-250	6 mm tip	str	flat edge
335-254	3 mm tip	slight curve	round edge
335-255	3 mm tip	slight curve	flat edge
335-260	6 mm tip	slight curve	flat edge
335-265	6 mm tip	slight curve	round edge

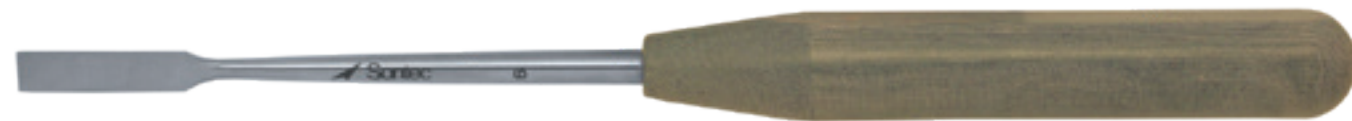

335-250



335-255



335-260

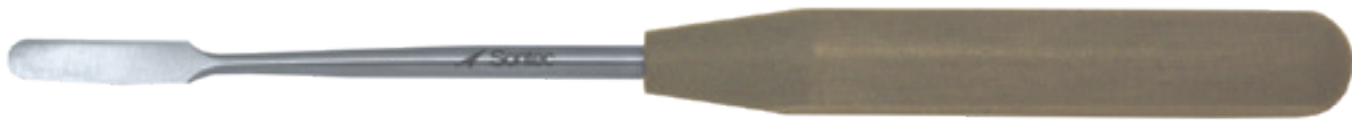

335-265



335-250



335-255



335-260



335-265

**Sontec A O Type Elevator / Raspatory**

Phenolic handles / 8" (20 cm)

335-270	13 mm tip	angled	flat edge
335-275	14 mm tip	str	round edge
335-280	14 mm tip	cvd	round edge
335-285	20 mm tip	str	round edge



335-270



335-275



335-280



335-285

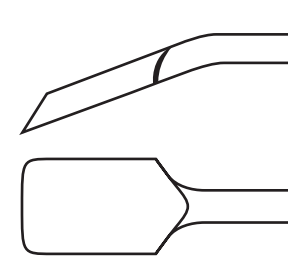

335-270

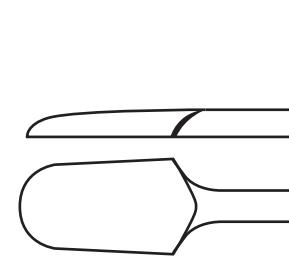

335-275

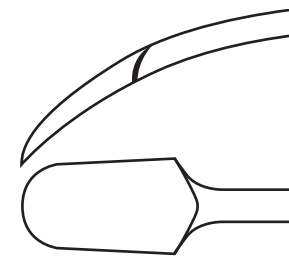

335-280

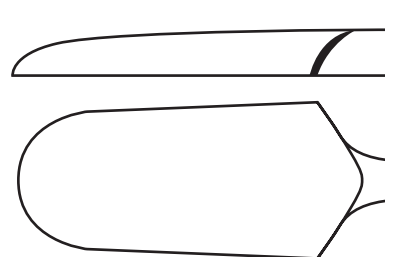

335-285



 Sontec Instruments®

ELEVATORS

**Woodson Elevator**

7 1/8" (18.1 cm)  
412-571



**Joseph Periosteal Elevator**

Curved / 6 3/4" (17 cm)

- 16-2207 3 mm
- 16-2208 3.5 mm
- 16-2209 4 mm
- 16-2210 5 mm
- 16-2200 6.5 mm



**Killian Elevator**

Double-ended / 7 1/4" (18.4 cm)  
412-536



**Masing Elevator / Dissector**

Double-ended / curved / octagonal handle / 7 7/8" (19.75 cm)  
412-575

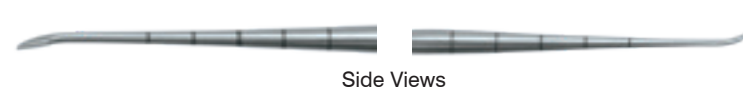

**Sontec-Masing Septal Dissector**

Double-ended / curved/curved / 8 1/4"  
467-535



**Sontec S.P.T. Elevator**

Round handle/ double-ended / curved / sharp / 8 1/4" (21 cm)  
412-583



**McKenty Elevator**

Semi-sharp / curved / 5 1/2" (14 cm)

- 412-5563 3 mm tip
- 412-556 4 mm tip
- 412-557 5 mm tip



Double-ended / curved / 8 1/2" (21.75 cm)

412-555



**Roger Elevator**

Double-ended / full curve / 7 1/4" (18.5 cm)  
412-558



**Mcdonald Elevator**

Double-ended / 7 1/2" (19 cm)  
412-585



**Freer Elevator / Mucosa Knife Round Handle 4.5 mm**

Double-ended / 4.5 mm / 7 3/4" (19.5 cm)  
468-163



468-163

**Freer Elevator / Packer**

Double-ended / 4.5 mm / 7 3/4" (19.5 cm)  
468-165



468-165

**Joseph Massing Elevator**

Bayonet shaft / 8" (20 cm)  
335-105



335-105

Straight / 6 mm / 8" (20.3 cm)  
335-106



335-106

**Pennington Elevator**

Double-ended / 8 1/4" (21 cm)  
412-580



412-580

**House Ear Elevator**

1 mm tip / 6 1/4" (16 cm)  
468-140



468-140

**Cottle Elevator**

Slight curve / 9 mm tip  
/ 7 1/2" (19 cm)  
412-527



412-527

**Boies Nasal Fracture Elevator**

9 mm / wide tip blunt / 7 1/2" (19.1 cm)  
345-315



345-315

**Sontec® Cottle Elevator**

Double-ended / sharp & blunt /  
graduated / 8 1/4" (21 cm)  
1271-302



1271-302

**Sesamoid Cottle Elevator**

Strong curve / double-ended / 9" (23 cm)  
1271-310



1271-310

**CSU Cottle Elevator**

Double-ended / graduated /  
9" (23 cm)  
1271-300 blunt  
1271-301 sharp



1271-300

**Cottle Daniel Raspatory/Packer**

Double-ended / 8 1/2" (22 cm)  
1271-309



1271-309

**Daniel-Gubisch Raspatory/Rasp**

Double-ended / rasp-elevator / 8 1/2" (22 cm)  
1271-307



1271-307

**Sontec® Septum Elevator / Probe**

Double-ended / with ball tips / 7" (18 cm)  
468-150



468-150

**Barns Septum Elevator**

Double-ended / 7 3/4" (19.5 cm)  
467-532 60° disc end/60° 4.5 mm elevator end  
467-533 disc end/4.5 mm Freer end



467-532



467-533

**Maxillary Ostium Elevator / Probe**

Double-ended / with ball tips / 8 1/4" (21 cm)  
468-160



468-160

**Ostium Burnisher Elevator**

Ball #42 / 1.9 & 1.2mm diameters /  
double-ended / 6 1/2" (16 cm)  
1102-BR42



1102-BR42

**Cleft Palate Elevator**

Double-ended / with perpendicular  
blades / 6 1/4" (18 cm)  
478-395



**Cronin Cleft Palate Elevator / Dissector**

Rounded-blunt tip / 7" (18 cm)  
478-402 small  
478-405 medium  
478-400 large

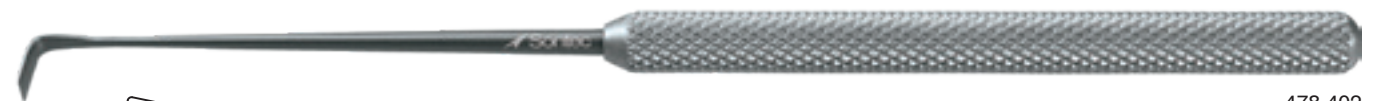

478-402

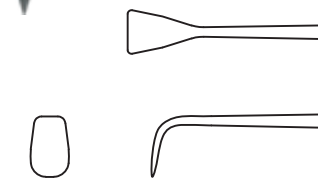

478-405

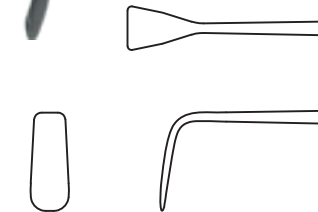

478-400

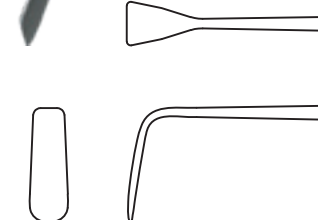



 Sontec Instruments®

Orthopedic MALLETS

**Sontec Combo Nylon Mallet**

1" head diameter / removable heads / 7 3/8" (18.75 cm)

1100-462S deluxe mallet with one nylon head

**Sold separately**

1100-462SH stainless steel head for deluxe mallet

1100-463S nylon head for deluxe mallet



1100-462S



1100-462SH



1100-463S

**Sontec Double Nylon Mallet**

Light-weight / 7 3/8" (18.7 cm) / 7 oz.

330-808



**Sontec Micro Mallet**

3/4" head diameter / 6 1/2" (16.5 cm)

330-817 stainless steel convex/flat combo 4 oz.

330-819 lead filled head no recoil 5.6 oz.



330-817

**Mead Mallet**

3/4" head diameter / 7 1/2" (19 cm) / 8 oz. head  
/ w/replacement nylon caps

330-814

**Replacement caps**

330-814R



330-814

**Brass Head Mallet**

7 3/4" (20 cm)

330-811



330-811

**Large Sontec Combo Mallet**

1 1/2" head / replaceable heads / 8" (20.5 cm)

330-824

330-824S stainless & nylon head

**Replaceable heads / 1 1/2" (3.8 cm)**

330-824NH nylon

330-824SH stainless steel



330-824NH



330-824SH



330-824

**Cottle Mallet**

Convex flat combo / 7 1/2" (19.1 cm)

1100-461S stainless steel head



1100-461S



 Sontec Instruments®

Orthopedic OSTEOTOMES

**West Osteotome**

**Square handle**

330-708	4 mm	6 1/2" (16.5 cm)
330-708A	6 mm	7 1/2" (19 cm)



**Hand Surgery Osteotome**

**Straight / 5" (13 cm)**

1103-281	3/32" (2 mm)
1103-280	1/8" (3 mm)
1103-282	5/32" (4 mm)
1103-283	1/4" (6 mm)
1103-284	5/16" (8 mm)
1103-285	13/32" (10 mm)
1103-286	15/32" (12 mm)
1103-287	9/16" (14 mm)
1103-288	19/32" (15 mm)
1103-289	3/4" (19 mm)
1103-291	5/8" (16 mm)
1103-292	11/16" (18 mm)
1103-293	13/16" (20 mm)

**Curved / 5" (13 cm)**

1103-281C	3/32" (2 mm)
1103-280C	1/8" (3 mm)
1103-282C	5/32" (4 mm)
1103-283C	1/4" (6 mm)
1103-284C	5/16" (8 mm)
1103-285C	13/32" (10 mm)
1103-286C	15/32" (12 mm)
1103-287C	9/16" (14 mm)
1103-288C	19/32" (15 mm)
1103-289C	3/4" (19 mm)
1103-291C	5/8" (16 mm)
1103-292C	11/16" (18 mm)
1103-293C	13/16" (20 mm)



**Sheehan Osteotome**

**6 1/4" (16 cm)**

330-882	2 mm
330-883	3 mm
330-884	4 mm
330-885	5 mm
330-886	6 mm
330-887	7 mm
330-888	8 mm
330-889	9 mm
330-890	10 mm
330-891	11 mm
330-892	12 mm
330-895	15 mm



**Hoke Osteotome**

**Hex handle / straight / 5" (12.5 cm)**

330-690	1/8" (3 mm)
330-691	3/16" (4 mm)
330-692	1/4" (6 mm)
330-693	5/16" (8 mm)
330-694	3/8" (10 mm)
330-695	1/2" (13 mm)
330-696	5/8" (16 mm)



**Curved / 5" (12.5 cm)**

330-700	1/8" (3 mm)
330-701	3/16" (4 mm)
330-702	1/4" (6 mm)
330-703	5/16" (8 mm)
330-704	3/8" (10 mm)
330-705	1/2" (13 mm)
330-706	5/8" (16 mm)

**Cottle Plastic Osteotome**

**Specially designed edge / heavy type / with end stop platform / with no corners on blade / 7" (18 cm)**

330-849A	3/32" (2 mm)
330-849B	5/32" (4 mm)
330-849C	9/32" (7 mm)
330-849D	11/32" (9 mm)
330-849E	15/32" (12 mm)



**Stille Osteotome**

**Hexagonal handle / 8" (20.5 cm)**

330-730	13/32" (10 mm)
330-731	9/16" (14 mm)
330-732	23/32" (18 mm)
330-733	7/8" (22 mm)



**Hardt Micro Cartilage Osteotome Set (with bag)**

5 1/8" (13.25 cm)

330-799-SET includes:

- 330-801M 3/32" (2 mm)
- 330-802M 5/32" (4 mm)
- 330-803M 1/4" (6 mm)
- 330-804M 5/16" (8 mm)
- 330-805M 13/32" (10 mm)
- 330-806M 15/32" (12 mm)
- 330-807M 19/32" (15 mm)

6 3/4" (17 cm)

330-800M-SET includes:

- 330-790M 3/32" (2 mm)
- 330-791M 5/32" (4 mm)
- 330-792M 1/4" (6 mm)
- 330-793M 5/16" (8 mm)
- 330-794M 13/32" (10 mm)
- 330-795M 15/32" (12 mm)
- 330-796M 19/32" (15 mm)

330-799B Canvas Osteotome Bag

Hardt Osteotomes also available individually



330-799B



330-800M



side view

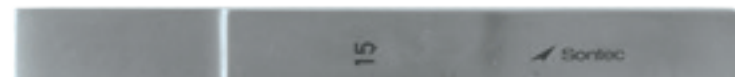

330-796M



330-795M



330-794M



330-793M



330-792M



330-791M



330-790M

**Sontec-Cottle Osteotome Set**

Graduated markings / 7" (18 cm)

1100-479-SET set includes:

7 osteotomes and canvas bag  
2 mm, 3 mm, 4 mm, 6 mm, 8 mm, 10 mm, 12 mm

- 1100-479K 2 mm
- 1100-479M 3mm
- 1100-479L 4 mm
- 1100-479A 6 mm
- 1100-479B 8 mm
- 1100-479C 10 mm
- 1100-479D 12 mm
- 1100-479E 14 mm
- 1100-479F 16 mm
- 1100-479G 18 mm
- 1100-479N 19mm
- 1100-479J 20 mm
- 1100-479H 22 mm
- 330-799B canvas bag



1100-479



1100-479A



1100-479B



1100-479C



1100-479F



1100-479G

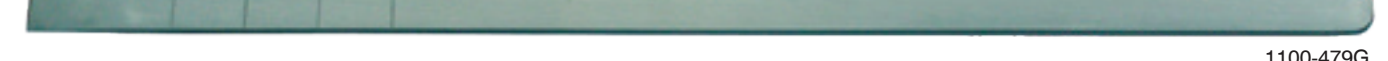

1100-479H

**Smith Peterson Osteotome**

**Straight / 8" (20.5 cm)**

330-610	1/4"
330-611	3/8"
330-612	1/2"
330-613	5/8"
330-614	3/4"
330-615	1"
330-616	1 1/4"



330-610



330-611



330-613



330-614



330-615



330-616

**Curved / 8" (20.5 cm)**

330-620	1/4"
330-621	3/8"
330-622	1/2"
330-623	5/8"
330-624	3/4"
330-625	1"
330-626	1 1/4"

**Hibbs Osteotome**

**Straight / 9 1/2" (24 cm)**

330-550	1/4"
330-551	3/8"
330-552	1/2"
330-553	5/8"
330-554	3/4"
330-555	7/8"
330-556	1"
330-557	1 1/8"
330-558	1 1/4"
330-559	1 1/2"

**Curved / 9 1/2" (24 cm)**

330-570	1/4"
330-571	3/8"
330-572	1/2"
330-573	5/8"
330-574	3/4"
330-575	7/8"
330-576	1"
330-577	1 1/8"
330-578	1 1/4"
330-579	1 1/2"



330-572

**Lambotte Osteotome**

**Straight / 9" (23 cm)**

330-660	1/4" (6 mm)
330-661	1/2" (13 mm)
330-662	3/4" (19 mm)
330-663	1" (25 mm)
330-664	1 1/4" (32 mm)
330-665	1 1/2" (38 mm)

**Curved / 9" (23 cm)**

330-670	1/4" (6 mm)
330-671	1/2" (13 mm)
330-672	3/4" (19 mm)
330-673	1" (25 mm)
330-674	1 1/4" (32 mm)
330-675	1 1/2" (38 mm)



330-675

**Mini Lexer Osteotome**

Small handle / 7" (18 cm)

- 330-001 4 mm tip
- 330-002 6 mm tip
- 330-003 8 mm tip
- 330-004 10 mm tip
- 330-005 12 mm tip



330-004

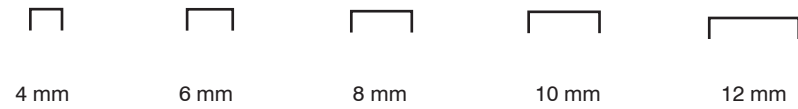

**Lexer Osteotome**

Large handle / 8 3/4" (22.5 cm)

- 330-010 7 mm tip
- 330-011 10 mm tip
- 330-012 15 mm tip
- 330-013 20 mm tip
- 330-014 25 mm tip
- 330-015 30 mm tip



330-011



**Lexer Osteotome**

Large handle / 12" (30.5 cm)

- 330-016 10 mm tip
- 330-017 12 mm tip
- 330-018 15 mm tip

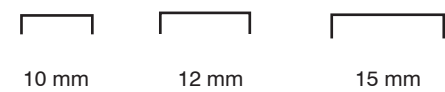

**Obwegeser Split Osteotome**

8 3/4" (22.5 cm)

- 330-120 8 mm tip
- 330-125 12 mm tip
- 330-130 16 mm tip
- 330-135 20 mm tip



330-125

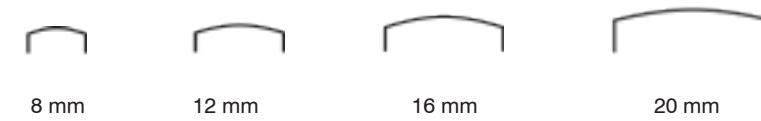

**Obwegeser Wedge Osteotome**

8 3/4" (22.5 cm)

- 330-100 8 mm tip
- 330-105 12 mm tip
- 330-110 16 mm tip



330-100





 Sontec Instruments®

Orthopedic PIN-PULLERS, DRIVERS & BENDERS

**Pin Bender Double-Ended**

Bends K-wire / 4 1/2" (11.5 cm)

- 1106-196 1.6 mm tip / 2.0 mm tip
- 1106-198 0.8 mm tip / 1.25 mm tip



1106-196



1106-198

**Pin Bender Double-Ended**

Bends K-wire / 0.9 mm (0.035") / 1.6 mm (0.062") / 1.1 mm (0.045") / 1.4 mm (0.054") / 4 1/2" (11.5 cm)

1106-206



1106-206

**Piermattei Pin Bender / Driver**

3 1/2" (9 cm)

1103-200

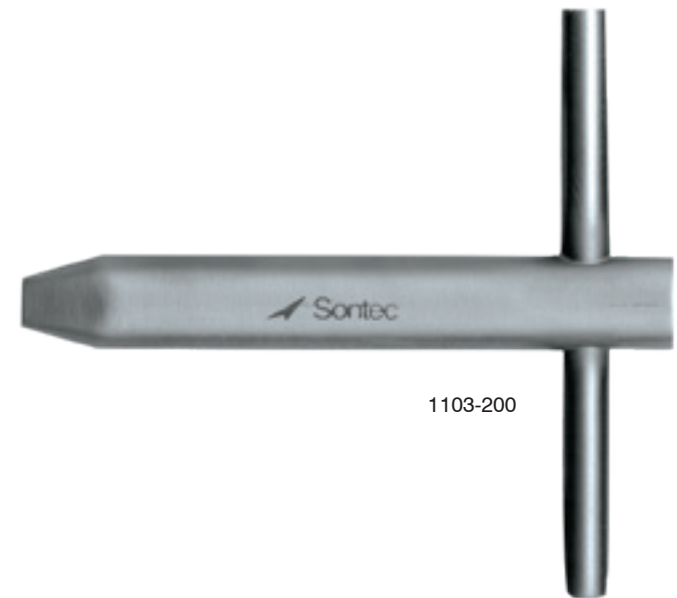

1103-200

**Pin Driver & Bone Tamp**

Single-ended flat tip with 1 mm raised circular lip / 3 1/2" (9 cm) in length

- 1103-2011 1.5 mm tip
- 1103-201A 2 mm tip
- 1103-201B 3 mm tip
- 1103-201C 4 mm tip
- 1103-201D 5 mm tip
- 1103-201E 6 mm tip
- 1103-201F 8 mm tip
- 1103-201G 10 mm tip



1103-2011



1103-201B



1103-201C



1103-201D

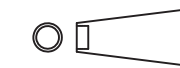

1103-201A



**Sontec Pin Driver / Bender**

Bends K-wire and pins

- 1103-201 2 mm / 2.3 mm 5" (13 cm)
- 1106-199 2 mm / 3.2 mm 6" (15.5 cm)

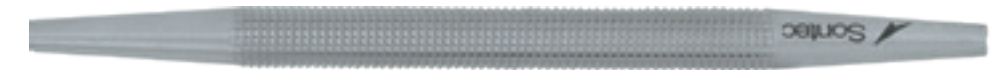

1103-201



1106-199

**Peterson Fully Cannulated Pin Bender**

Double-ended with concave tips / specially cannulated through entire length for better leverage

- 1103-201J 2 mm tip / 2.3 mm tip 5" (13 cm)
- 1103-201H 2 mm tip / 3.2 mm tip 5 3/4" (14 cm)



1103-201J



1103-201H

**Vickers Easy Driver / Bender / Puller**

To drive, bend & pull K-wire / 5 1/2" (14 cm)  
1103-179

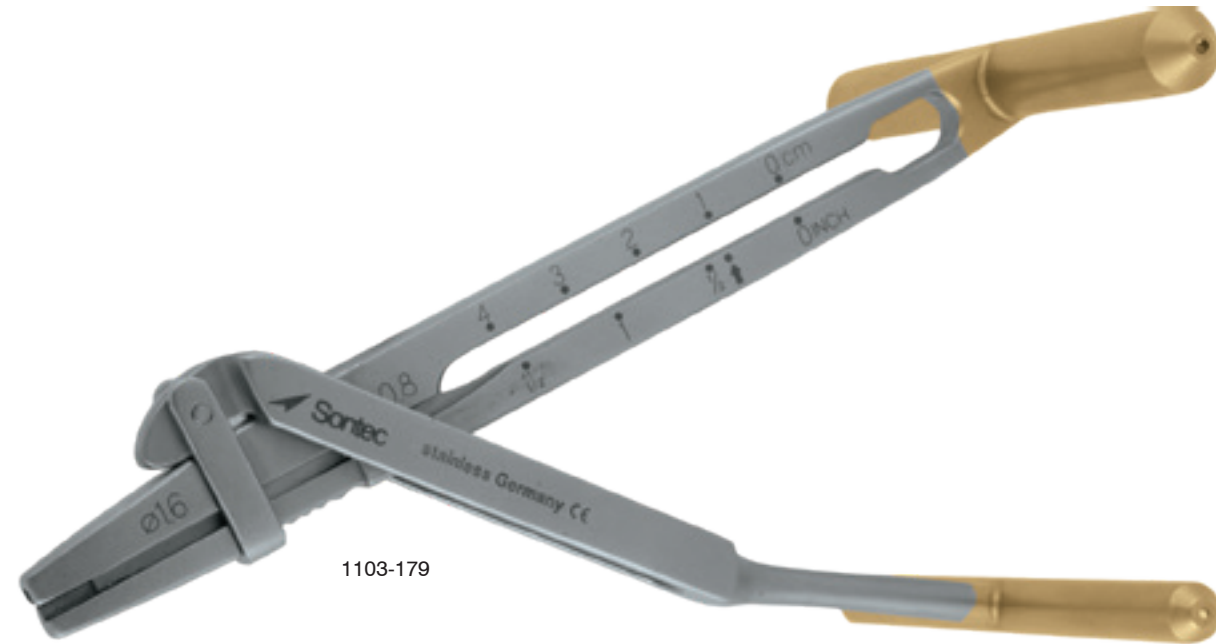

1103-179

**Steinman Pin Puller**

Pulls pins from 1/8" (3.2 mm)  
/ 5 1/2" (14 cm)  
1106-124

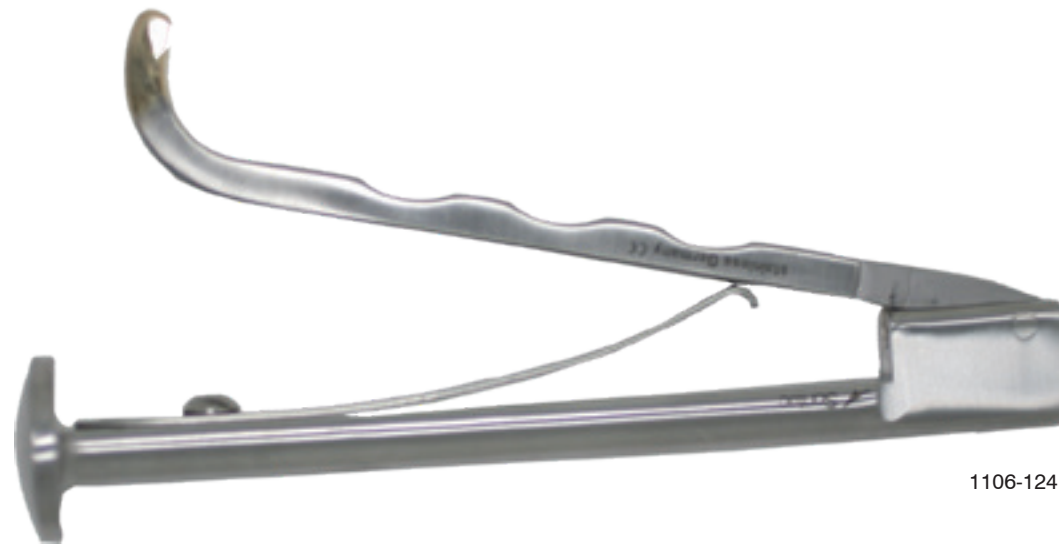

1106-124

**Pin Puller / Side Cutter**

Cuts wire up to 1.6 mm  
1103-125 4 1/2" (11.5 cm)  
1103-126 6 1/2" (16.5 cm)  
1103-127 7 1/4" (18.5 cm)  
1103-127A 7 1/2" (19 cm) without side cutter



1103-125



1103-127



1103-127A

**Pin Pulling Double Action Pliers**

TC serrated / double-action / 7" (18 cm)

- 1100-533 2 mm
- 1100-533A 3 mm
- 1100-532 4 mm
- 1100-536 6 mm

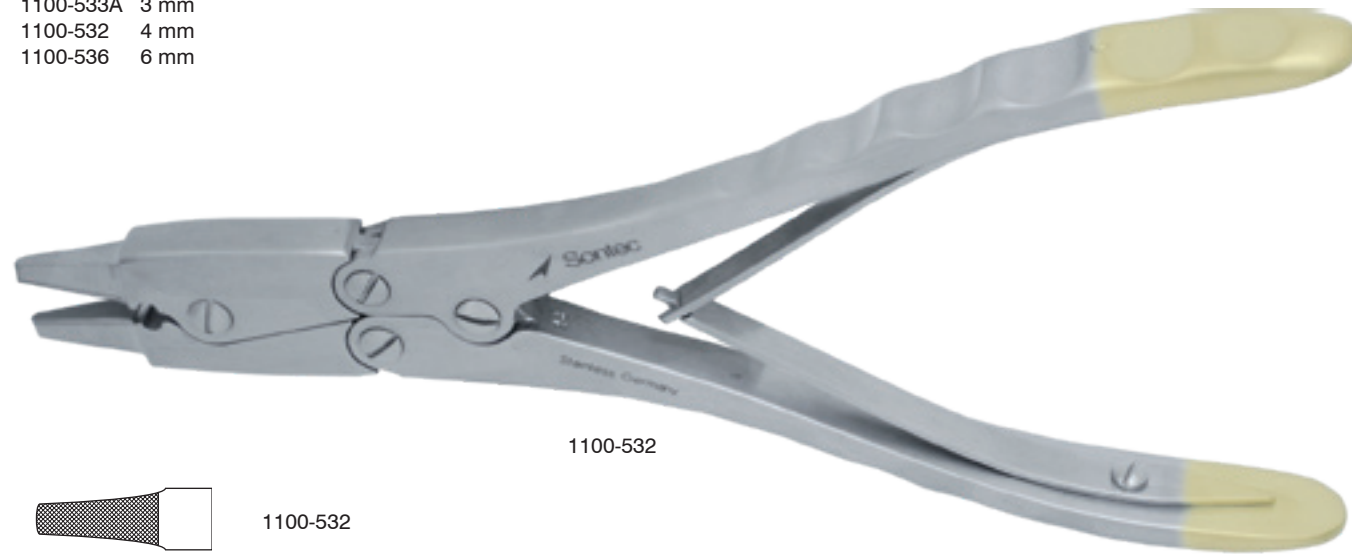

1100-532



1100-532



1100-536

**HERCULES® GRIP Pin Puller**

Over 40% less power required / 7" (18 cm)

- 355-182 3 mm
- 355-183 6 mm

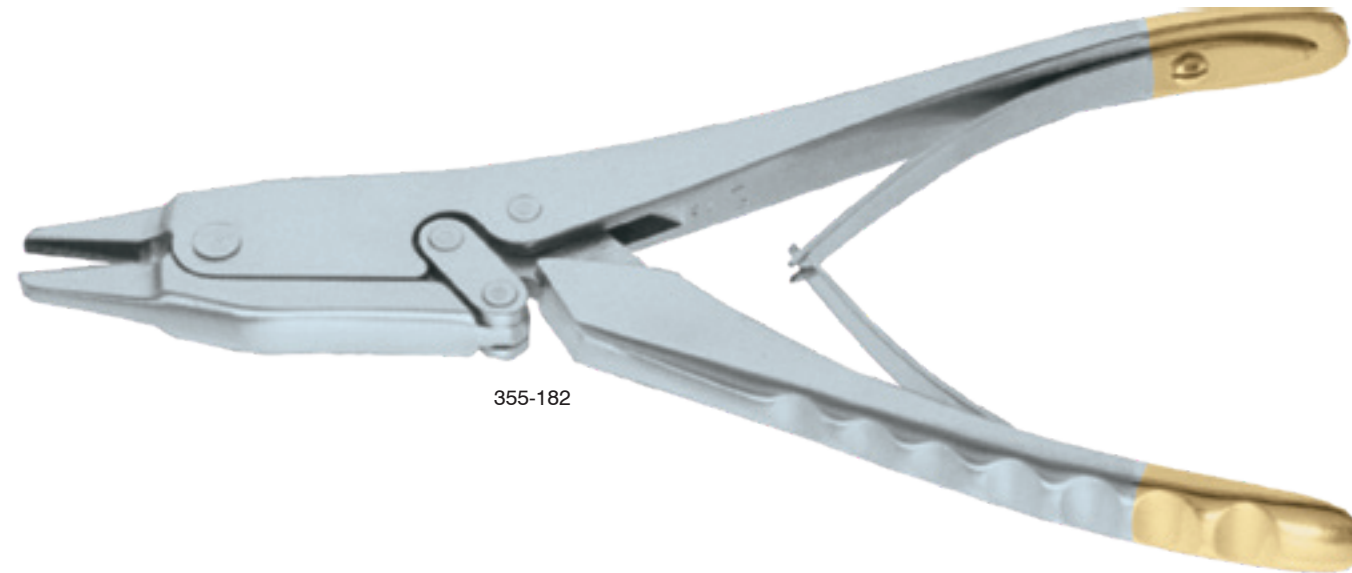

355-182

**Pin Puller**

Grooved serrated jaws / with adjustable screw

- 1103-122 5 1/2"
- 1103-123 7"



1103-122



1103-123

**Aderer Wire Bending Pliers**

5 3/4" (14.5 cm)

1103-120



1103-120

**Waldsachs Universal Pin Bender Pliers**

6" (15 cm)

1103-138  
1103-1381 TC



1103-138



1103-1381

**Wire Extraction Pliers**

7" (18 cm)

1106-130	cross-serrated	6 mm	grooved jaw
1106-131	cross-serrated	3 mm	
1106-132	serrated	3 mm	

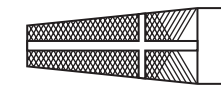

1106-130

1106-130



1106-131

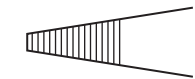

1106-132

**Pin Pulling Pliers**

TC / one grooved jaw / 3 mm  
tip / 5 1/2" (14 cm)

1106-140

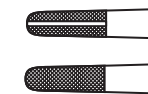

1106-140

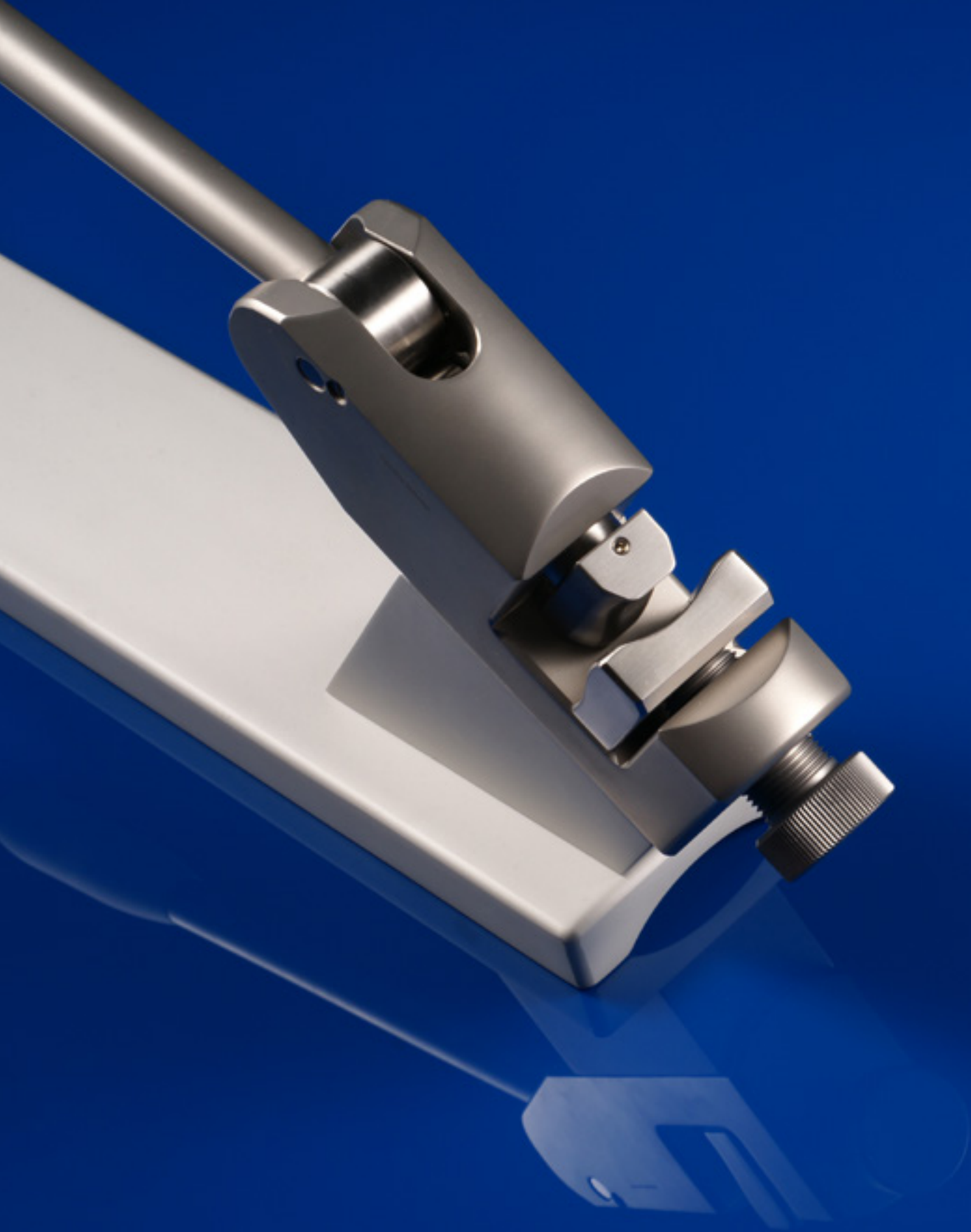

 Sontec Instruments®

Orthopedic PLATE BENDERS & BENDING IRONS

**Plate Bending Table Top Press**

Bends plates up to 6 mm / rotatable anvil / 17" (43 cm) in length  
1106-185



1106-185

**AO Type Bending Pliers Set**

For straight plates / with 2 anvils / 10" (25.4 cm)  
/ comes with 355-236N & 355-236B  
355-236-SET

**Plates for Bending Pliers**

- 355-236A for small plates
- 355-236B for broad plates
- 355-236N for narrow plates

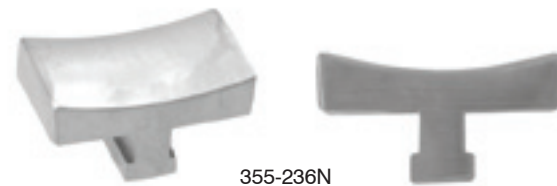

355-236N



355-236

**Whale Nose Plate Bending Pliers**

Bends small plates up to 2.7 mm / 7 3/4" (19.5 cm)  
355-230  
  
Bends large plates up to 3.5 mm / 9 1/2" (24 cm)  
355-235



355-230

**Lateral Plate Bending Pliers**

Bends 2.7 mm x 3.5 mm / contours plates /  
10 1/4 (26 cm)  
355-245



355-245



 Sontec Instruments®

Orthopedic SCREWDRIVERS

**Hexagonal Screw Driver**

**Screw drivers / phenolic handle**

1106-261	2.5 mm	7" (18cm)
1106-263	3.5 mm	7" (18 cm)
1106-270	2.5 mm	7 3/4" (20 cm)
1106-260	2.5 mm	9" (23 cm)
1106-262	3.5 mm	9" (23 cm)
1106-271	2.5 mm	9" (23 cm)

**Universal screw driver sleeve**

1106-270S



1106-270



1106-270S



sleeve and screw drivers sold seperatly

**Phenolic handle / 10 1/2" (27 cm)**

1106-257	2.5mm	screw driver w/ sleeve
1106-258	2.5mm	screw driver
1106-259		sleeve



1106-258



1106-259



1106-257

**A.O. Type Universal Screw Driver**

**Screw drivers / 5" (13 cm)**

1106-280	AO type tap handle
1106-281	AO type tap handle swivel

**Screw driver shaft**

1106-283	1.5 mm
1106-285	2.5 mm
1106-284	3.5 mm



1106-281



1106-285



1106-281 with 2.5mm shaft and universal sleeve

**Lubra® Screw Driver**

**Phenolic Handle / 6 3/4" (17 cm)**

- 1106-965 flat head
- 1106-967 hex head

**Phenolic handle / 10" (25 cm)**

- 1106-264 single slot
- 1106-266 cruciform
- 1106-268 phillips



1106-965

**AO Type Universal Screwdriver Set**

1106-2881 Set includes:

- |           |  |                |
|-----------|--|----------------|
| 1106-288  | AO type tap handle swivel                | 4 1/4" (11 cm) |
| 1106-289A | 1.5mm hex screwdriver shaft              | 2" (5 cm)      |
| 1106-289B | 1.5mm cruciform hex screwdriver shaft    | 2" (5 cm)      |
| 1106-289C | universal sleeve mini screwdriver shafts | 1.5 mm         |

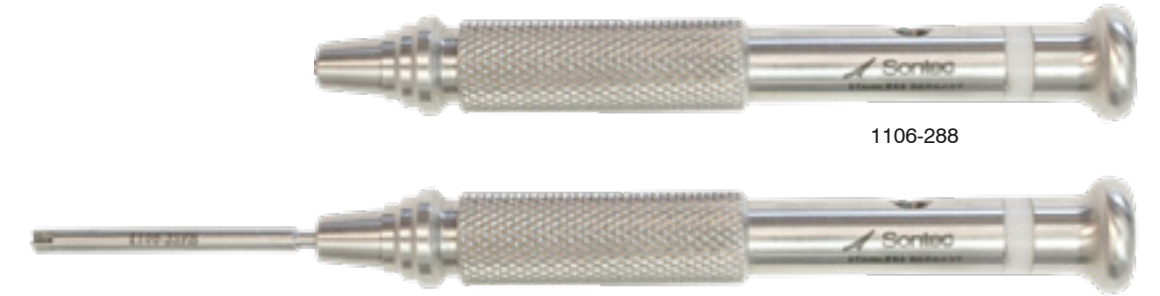

1106-288

sleeve and screw drivers sold separately



1106-289C

1106-289A

1106-289B

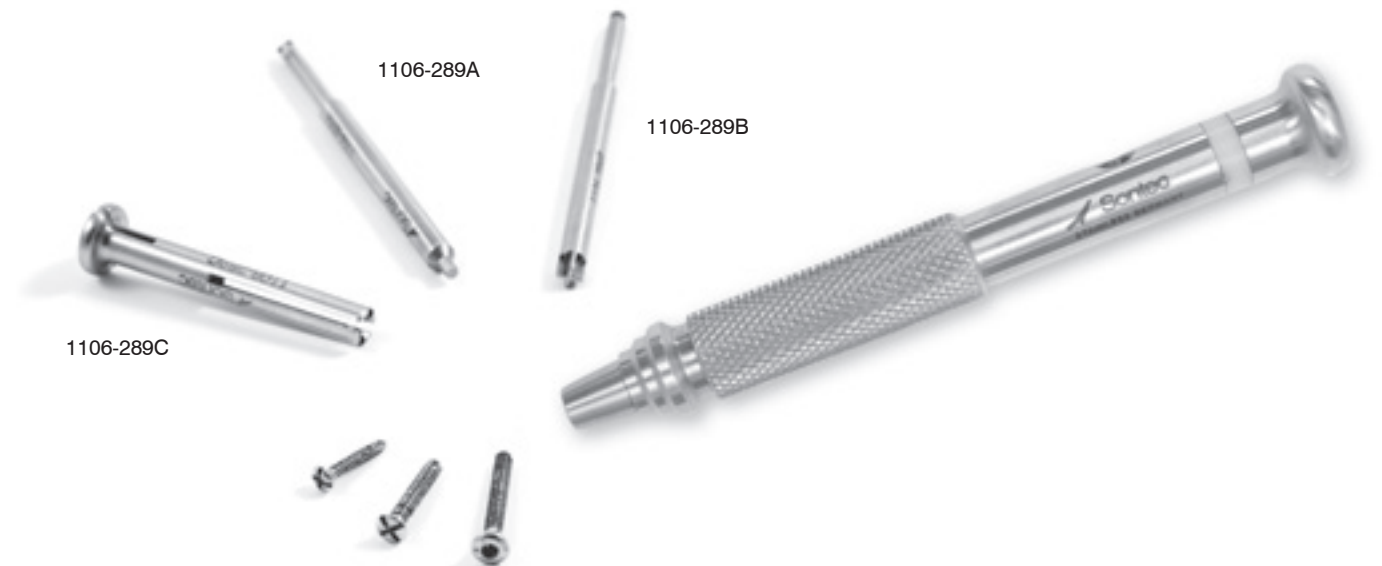

1106-289A

1106-289B

1106-289C



 Sontec Instruments®

Orthopedic WIRE PASSERS

**Sontec Single End Wire Passer**

Phenolic handle / 45 mm / 9" (22 cm)

1103-166

70 mm / 10 1/2" (27 cm)

1103-166X

45 mm / 8 3/8" (21.5 cm)

1103-167

Phenolic handle / with thick tubing wall /

9" (23 cm)

1103-165

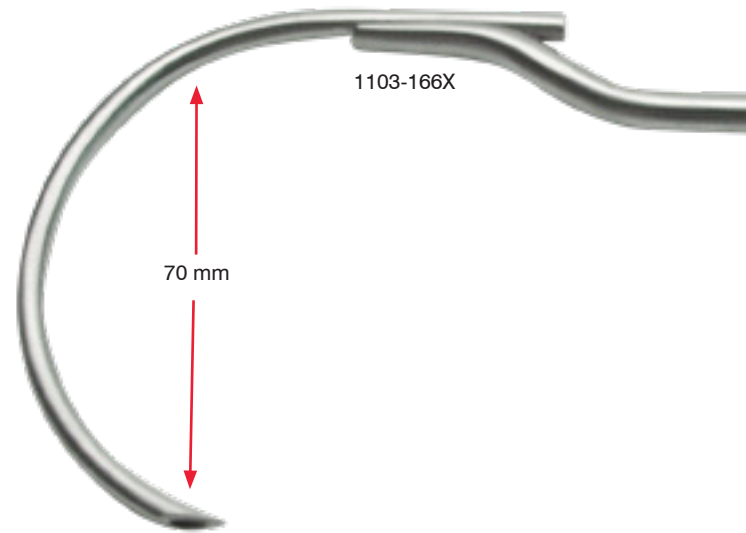

**Herbst-Doolen Wire Passer**

Double-ended / small / medium / 5 1/2" (14 cm) / for 20-26 gauge wire

1103-841



**Herbst Wire Passer**

Double-ended / 5 1/2" (14 cm) / for 18-26 gauge wire

1103-160



**Avian Mini Wire Passer**

For 22-26 gauge wire

1103-848 single ended 22 gauge 4 1/2"

1103-848S single ended 26 gauge 4 1/2"

1103-847 double ended 22-26 gauge 5"





 Sontec Instruments®

Orthopedic WIRE PIN CUTTERS

**Wire Side Cutter**

**TC**

1103-115	5 3/4" (14.5 cm)	cuts wire up to 1.0 mm
1100-528	7 1/2" (19 cm)	cuts wire up to 1.6 mm
1100-528D	8" (20 cm) Deluxe	cuts wire up to 1.6 mm



1103-115

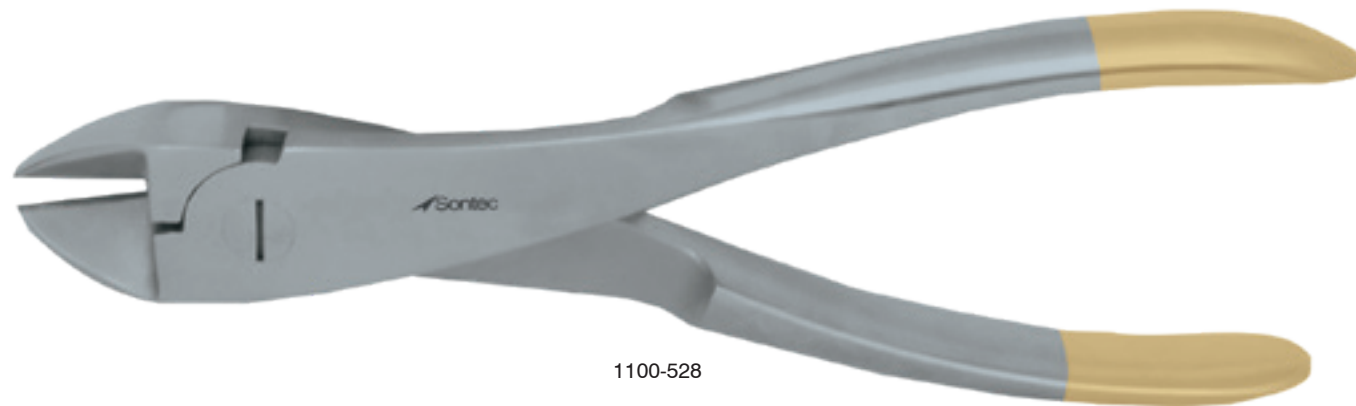

1100-528

**End Pin Cutter**

**Cannulated / cuts pins up to 1.6 mm / single action / 7 1/2" (19 cm)**

1103-109  
1103-108 TC



1103-109

**Large Plate & Pin Cutter**

**Cuts stainless steel wire & plates up to 3.5 mm / replacement jaws available / 9 1/2" (24 cm)**

1103-104

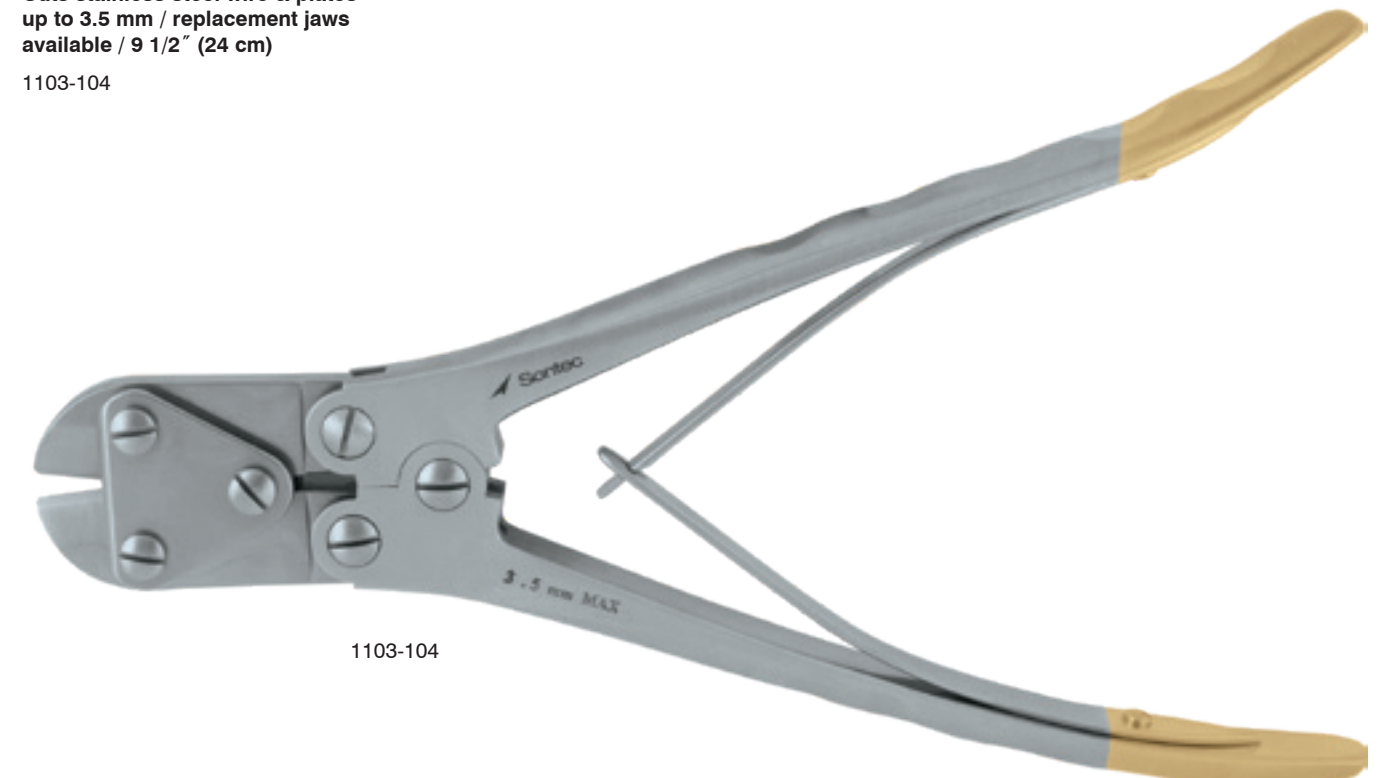

1103-104

**Double Action Wire Cutter**

Angled to the side / TC

1100-529 7 1/4" (18 cm)

Cuts wire up to 1.6 mm / TC

1100-530 7" (18 cm)

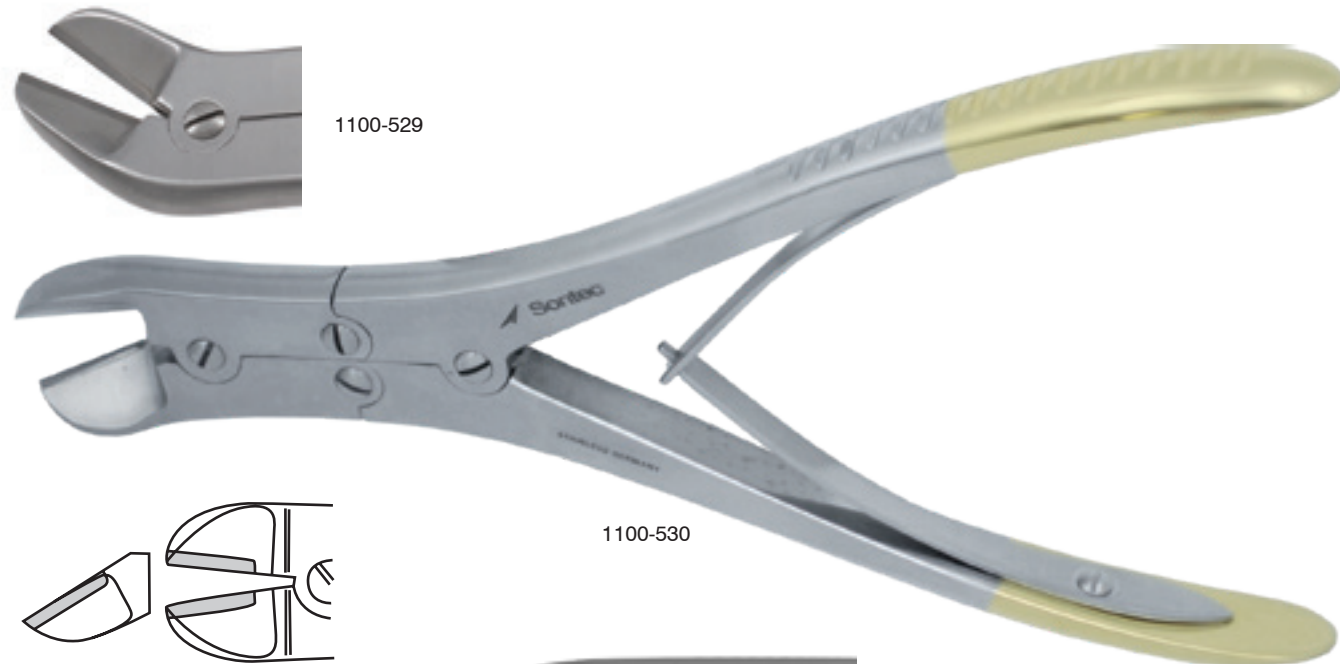

TC / Cuts wire up to 2.2 mm / 8 3/4" (22 cm)

1103-102 15° angle  
1103-103V 30° angle

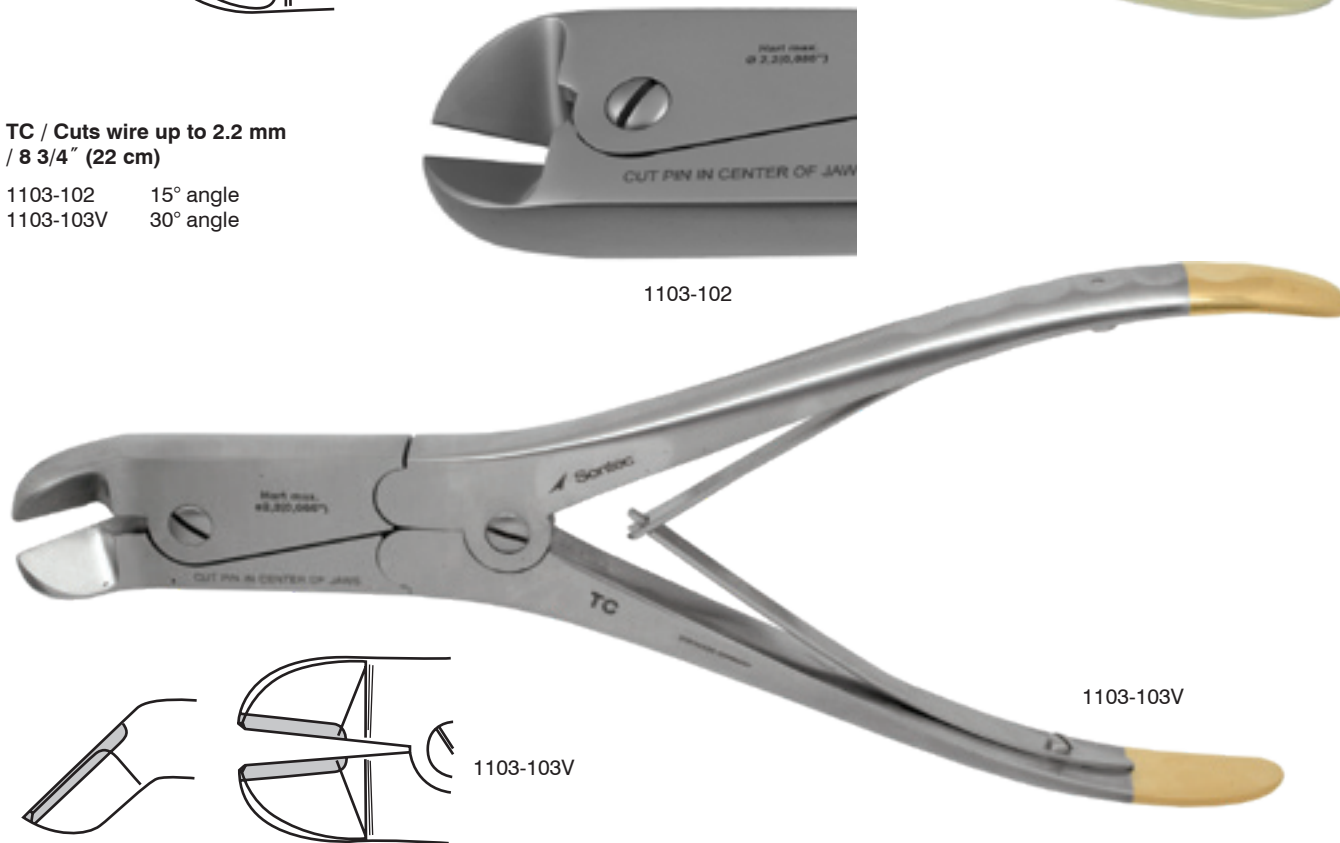

**Wire End Cutter**

TC / double-action / cuts wire up to 1.5 mm / 6 1/4" (16 cm)

1103-105 mini

TC / double-action / Cuts wire up to 2.5 mm / 8 1/2" (21.5 cm)

1103-100 extra large



**Large Pin / Bolt Cutter**

Cuts pins up to 6.3 mm / replaceable jaws

355-212	non-removable handles	22 1/2"
355-213	compact removable handles	18 1/2"
355-214	removable handles	22 1/2"

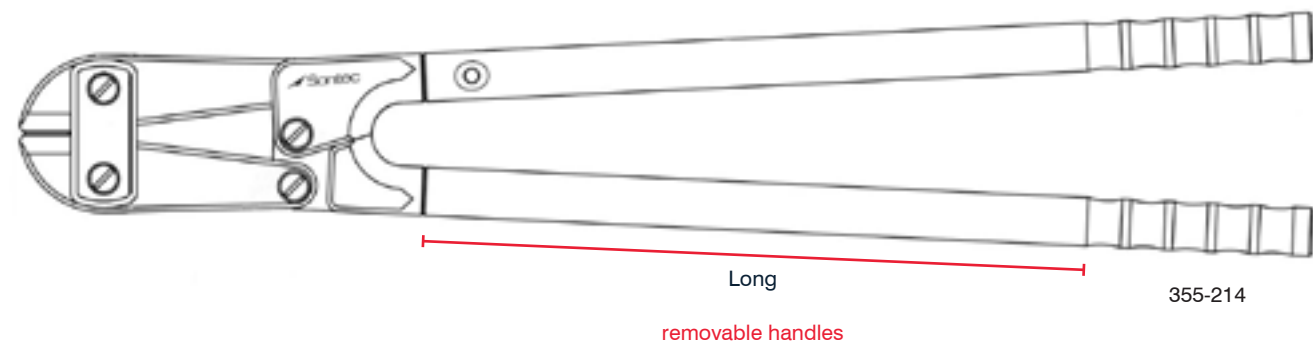
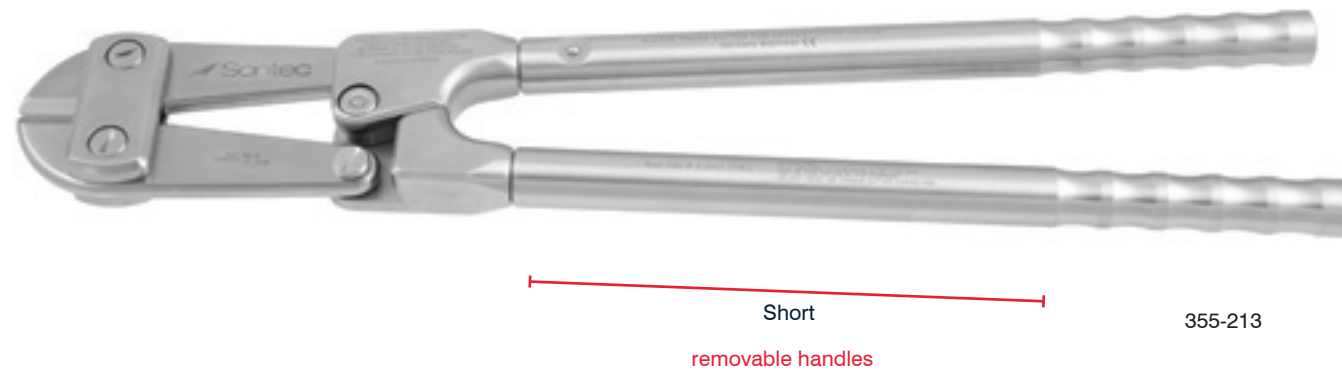
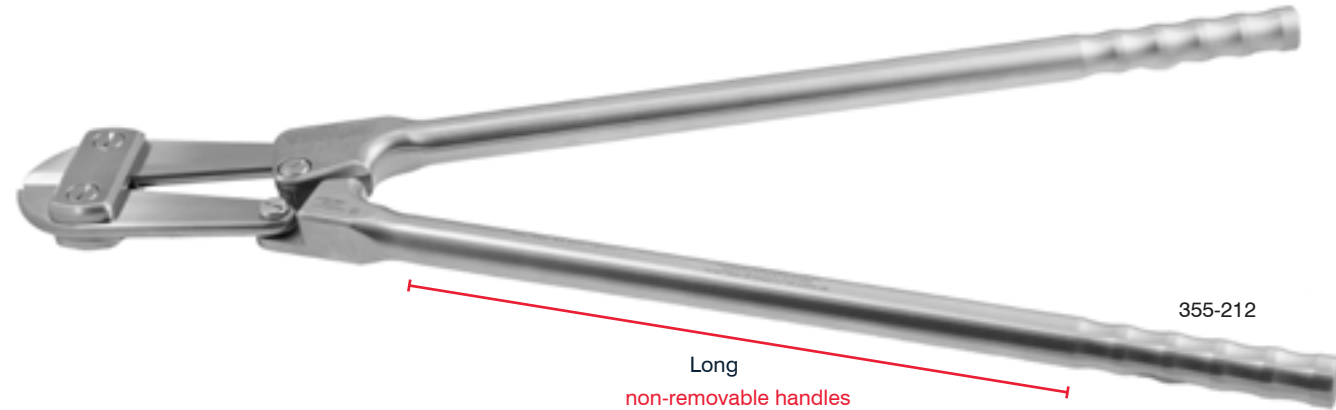

**Sontec Pin Cutter**

With TC inserts / max cap ø 4 mm / 15" (38 cm)

355-209



**Pin End Cutter**

Cuts pins up to 3 mm / 10" (25 cm)

355-202

Cuts pins up to 4.7 mm / 14" (35.5 cm)

355-210

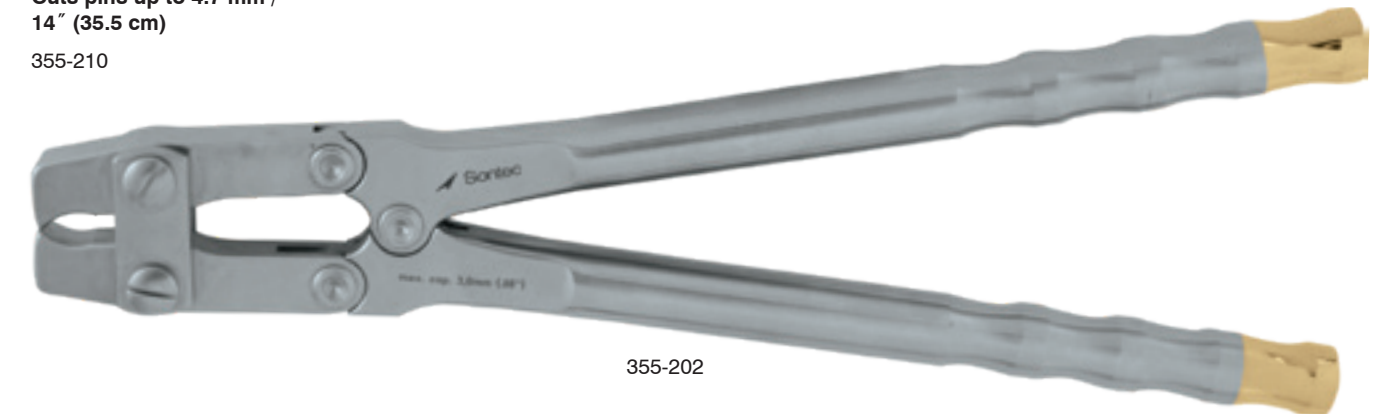

**TC Pin Cutter**

Cuts pins up to 6.0 mm / replaceable jaws

1103-140	19" (48 cm)	special order
1103-140A	19" (48 cm)	handles are removable for smaller autoclaves

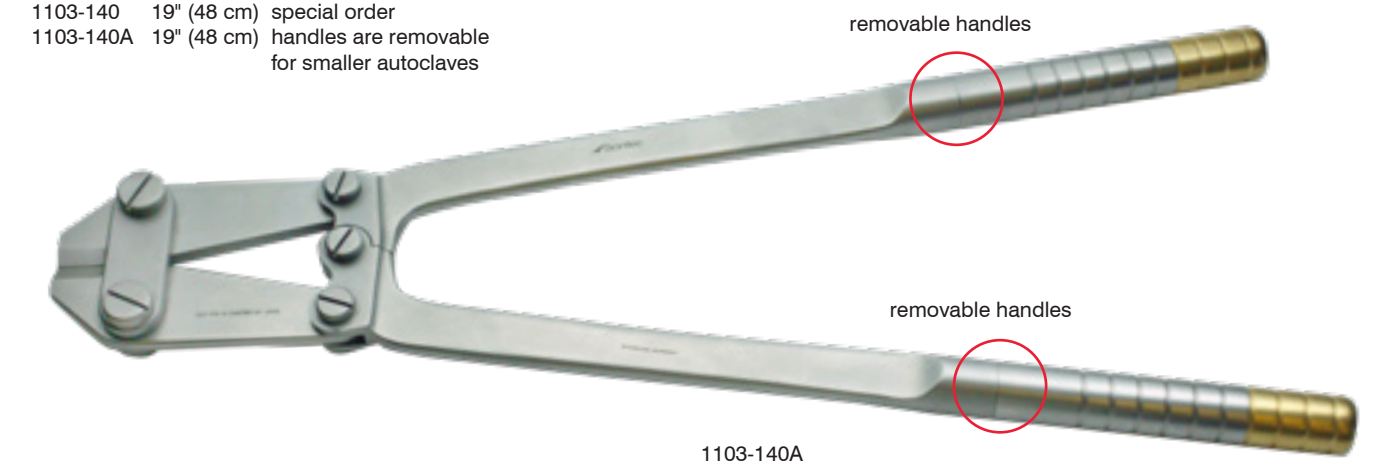

**GOLD-CUT HERCULES® Pin Cutter**

Cuts pins up to 3 mm / exchangeable TC blades / over 40% less power required / exchangeable rubber jaws / fully sterilizable / 9" (23 cm)

- 355-189 wire cutter
- 355-190 TC Blades Replacement Set
- 355-193 Rubber Jaws Replacement Set

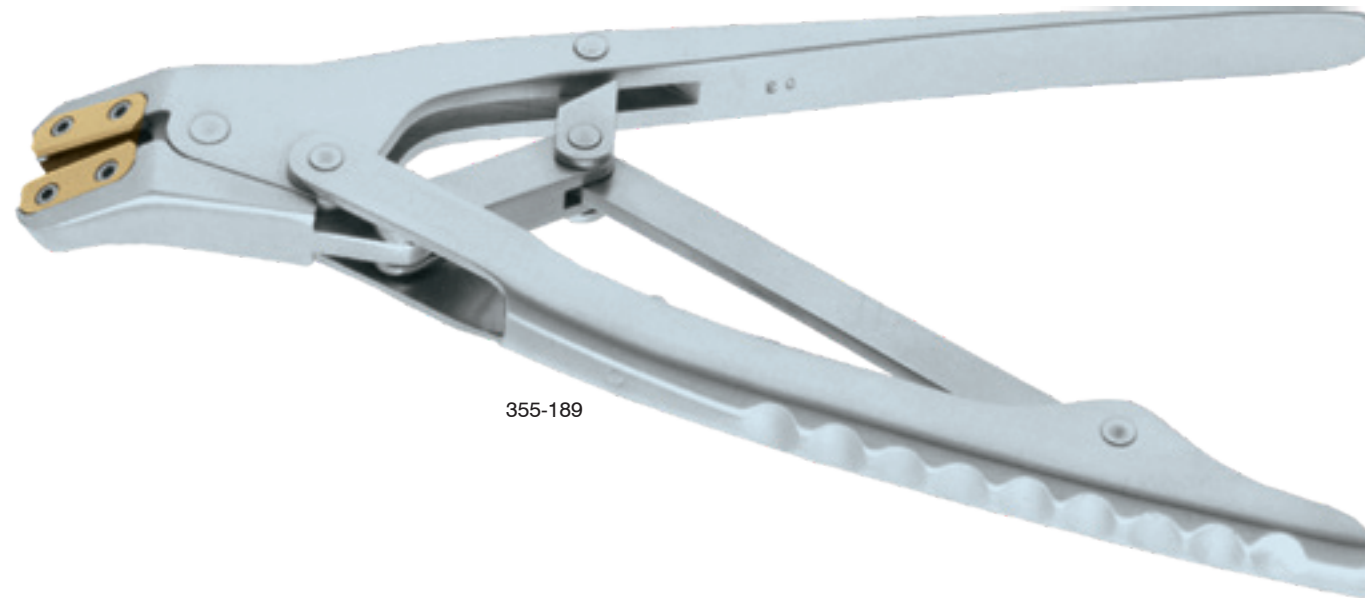

355-189

**The Big GOLD-CUT HERCULES® Pin Cutter**

Cuts pins 2.5 mm - 4.0 mm / exchangeable TC Blades / over 40% less power required / exchangeable rubber jaws / fully sterilizable / 11" (28 cm)

- 355-191 wire cutter
- 355-192 TC Blades Replacement Set
- 355-193 Rubber Jaws Replacement Set

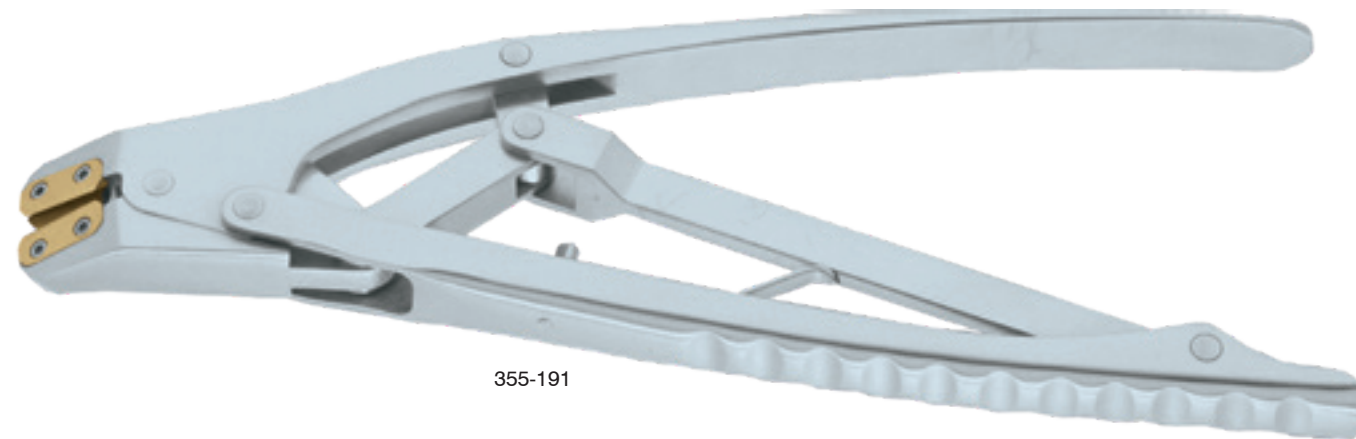

355-191

**Baby GOLD-CUT HERCULES® Pin Cutter**

Cuts pins up to 2.2 mm / exchangeable TC blades / over 40% less power required / exchangeable rubber jaws / fully sterilizable / 7" (18 cm)

- 355-187 left-handed
- 355-186 right-handed
- 355-188 TC Blades Replacement Set
- 355-193 Rubber Jaws Replacement Set

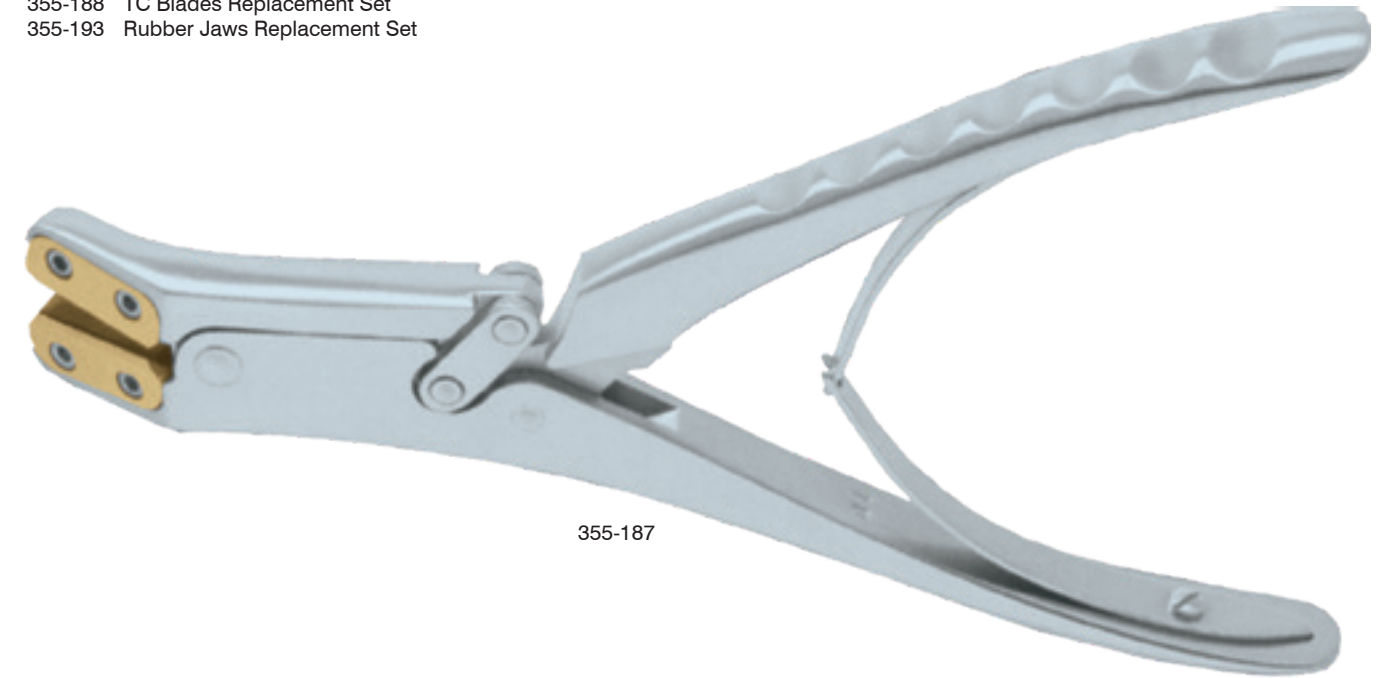

355-187

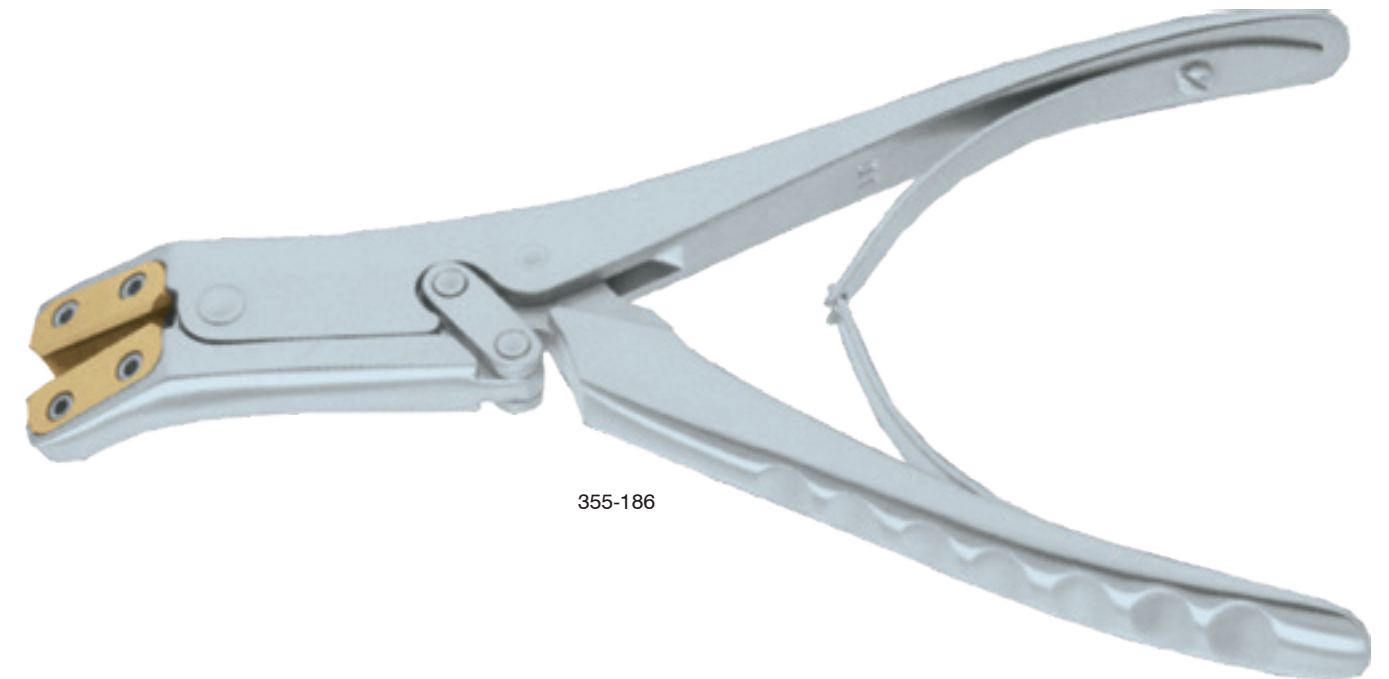

355-186

**Double Action Wire Cutter**

Cuts wire up to 1.6 mm / TC / 6 1/4" (16 cm)  
1100-530A



1100-530A

**Micro Double Action Wire Cutter**

Cuts wire up to 1.6 mm / TC / 6 1/2" (16.5 cm)  
1100-531



**GOLD-CUT HERCULES® Front & Side Pin Cutter**

Cuts pins up to 1.6 mm / over 40% less power required / exchangeable TC blades with integrated rubber jaws / fully sterilizable / 7" (18 cm)

355-198 front & side cutter  
355-199 TC inserts with Rubber Jaws Replacement Set

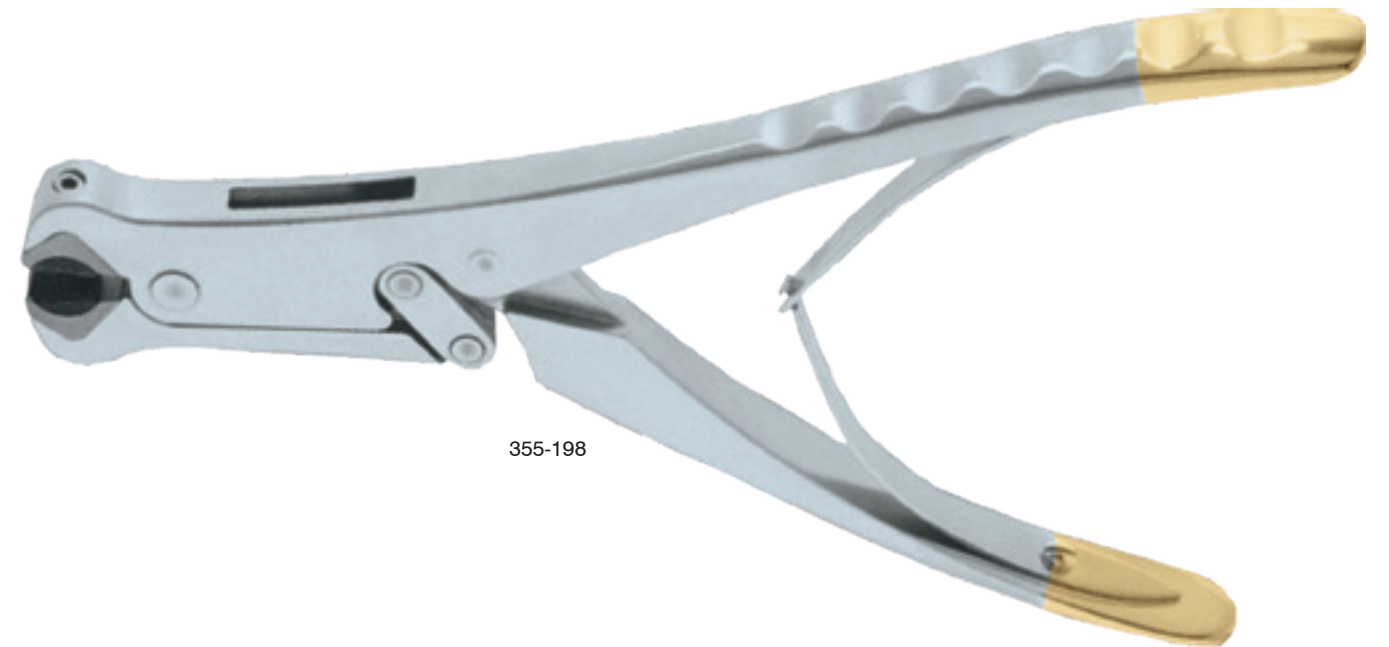

355-198

**Rod Cutter**

Cuts rods Ø2.5 mm, Ø3.0 mm,  
Ø3.5 mm / 11 1/2" (29.2 cm)

355-207



355-207

**Rod Flush Cutter**

With removable handle / cuts rods Ø4.5  
mm, Ø5.5 mm, Ø6.35 mm / 22" (57 cm)

355-211



355-211



**TC Blades Replacement Set For Hercules Wire Cutter**

1 pair of TC blades / 1 pair of screws / 1 allen wrench

355-190 for 355-189

355-192 for 355-191

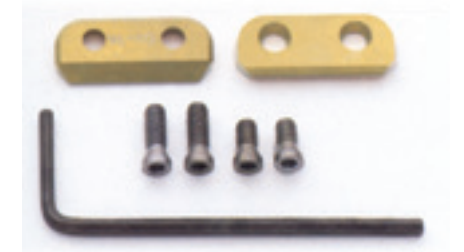

**TC Inserts with Rubber Jaws Replacement Set for Hercules Front & Side Cutter**

1 pair of TC inserts with rubber jaws / 1 pair of screws / 1 allen wrench

355-199 for 355-198





 Sontec Instruments®

Orthopedic WIRE TWISTERS

**Sternal Wire Twister Needle Holder**

Broad jaw / TC serrated / can be used as a wire twister / suggested suture size sternal needles and smaller

- 1103-154S 5 1/8" (13 cm)
- 1103-152 7" (18 cm)
- 1103-153 7 3/4" (19.5 cm)

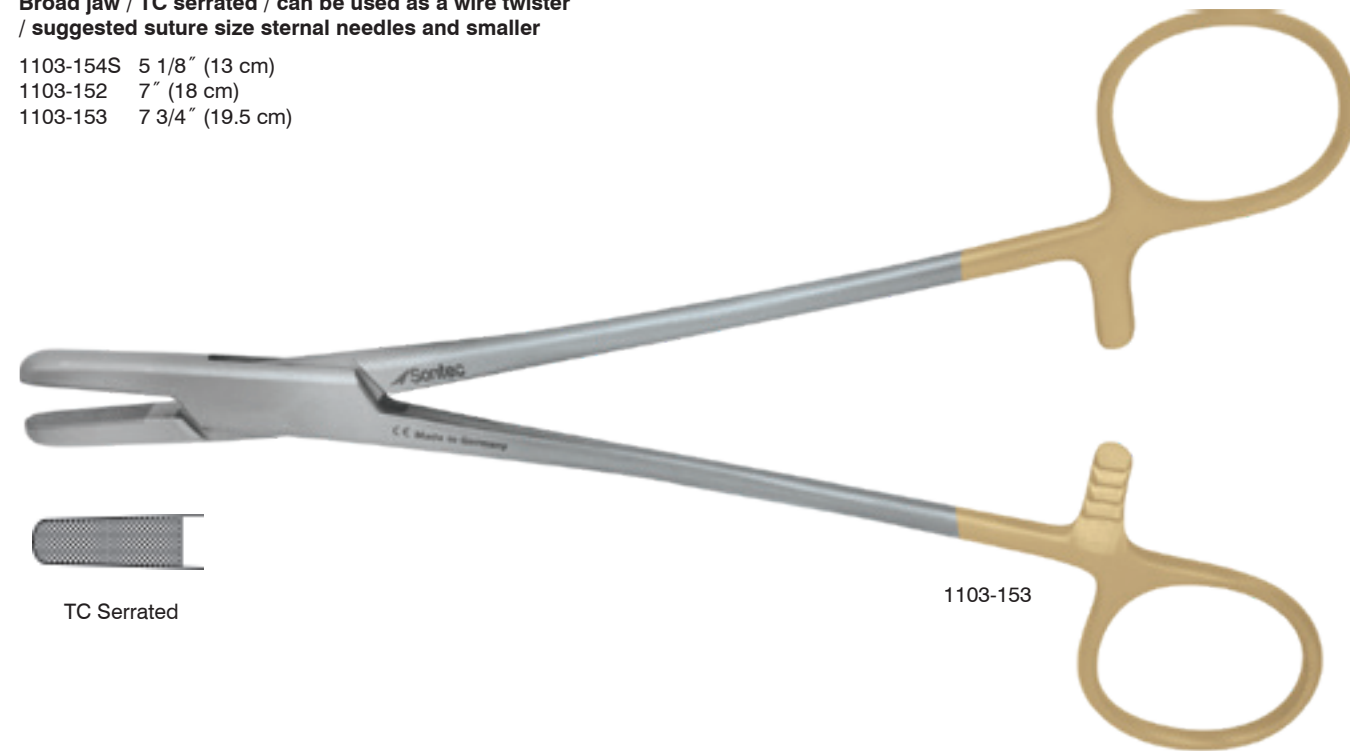

**Axel Wire Twister**

Needle holder style / with hole / 6 3/4" (17 cm)

1103-155

Rounded jaw / with hole / heavy duty XXL

- 1103-1551 7 1/4" (18.4 cm)
- 1103-1552 8" (20.3 cm)

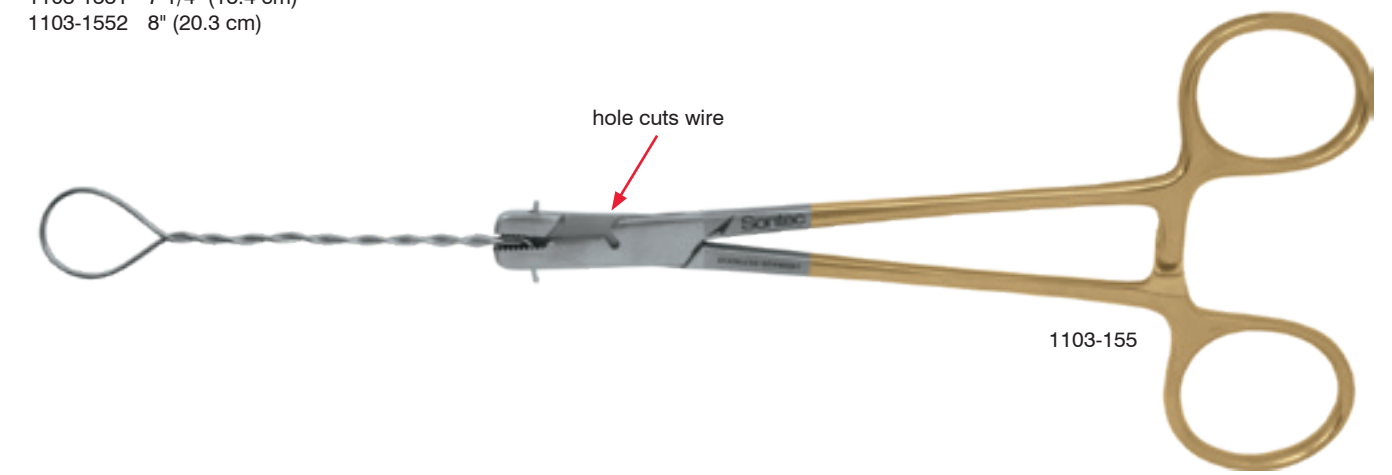

**New Orleans Wire Twister Needle Holder**

TC serrated / suggested suture size 2-0 and smaller

- 2300-600 rounded 6" (15 cm)
- 2300-602 blunt 6" (15 cm)
- 2300-601 rounded 7" (18 cm)
- 2300-604 blunt 7" (18 cm)
- 2300-606 rounded 8" (20.5 cm)
- 2300-607 blunt 8" (20.5 cm)

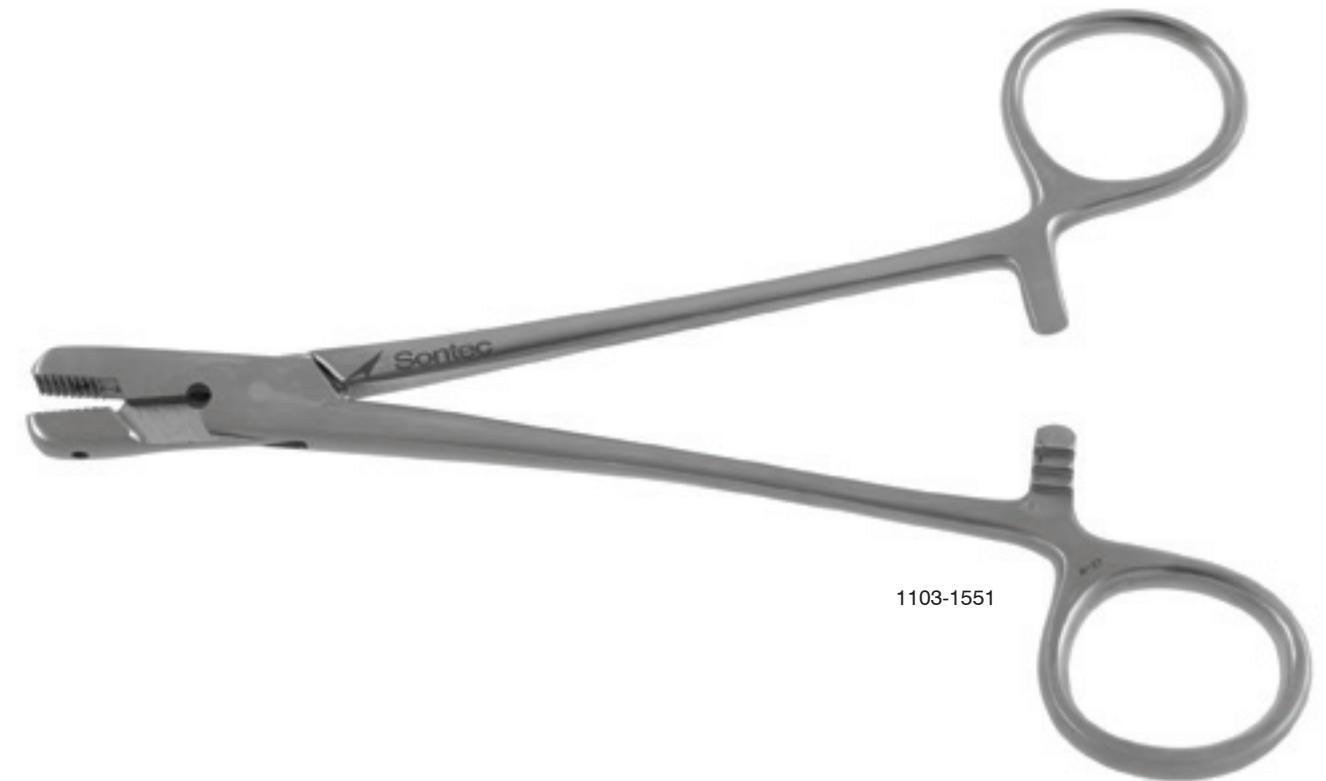
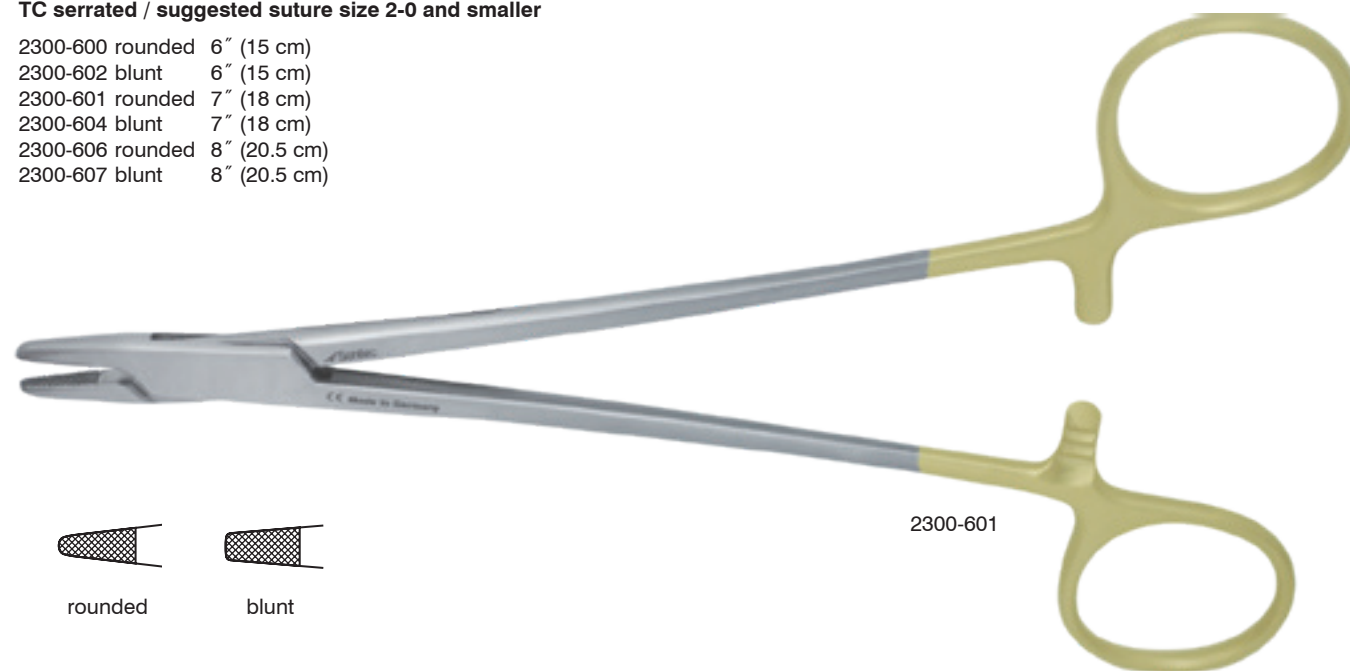

**Wire Twister**

Needle holder style / with hole / 7" (18 cm)  
1103-150



**Mini Jet Wire Twister Needle Holder**

Mayo needle holder style / TC serrated / 6 1/2" (16.5 cm)  
1103-158M

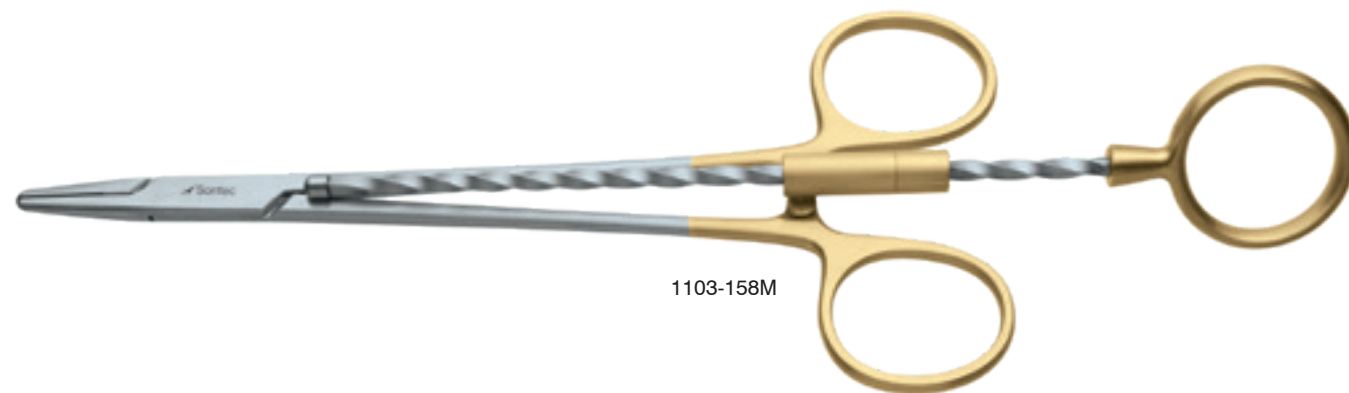

**TC Jet Wire Twister Corkscrew Design Heavy Needle Holder**

Broad jaw / 7" (17.8 cm)  
1103-152A



**Cerclage Torpedo Type Wire Twister**

Stainless / 5" (12.5 cm)  
1100-496



**Bio-Met Wire Twister**

Aluminum handle / 6" (15 cm)  
1103-158B



1103-158B

**Bio-Met Type Wire Twister**

6" (15 cm)  
1103-171



1103-171

**Loute Wire Twister**

Stainless / precise adjustment capabilities / 8 1/2" (22 cm)  
1100-496L

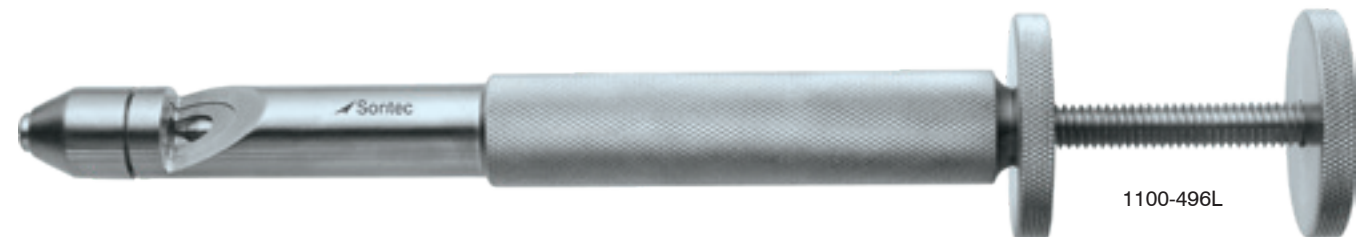

1100-496L

**Jet Wire Twister**

Automatic / 8" (20 cm) / with cutter  
1103-158



1103-158

Spring loaded with ratchet / 11" (28 cm)  
/ without cutter  
1103-158S



1103-158S

**Cerclage Double Torpedo Type Wire Twister**

Stainless / phenolic handle / 9 3/4" (25 cm)  
1100-496D

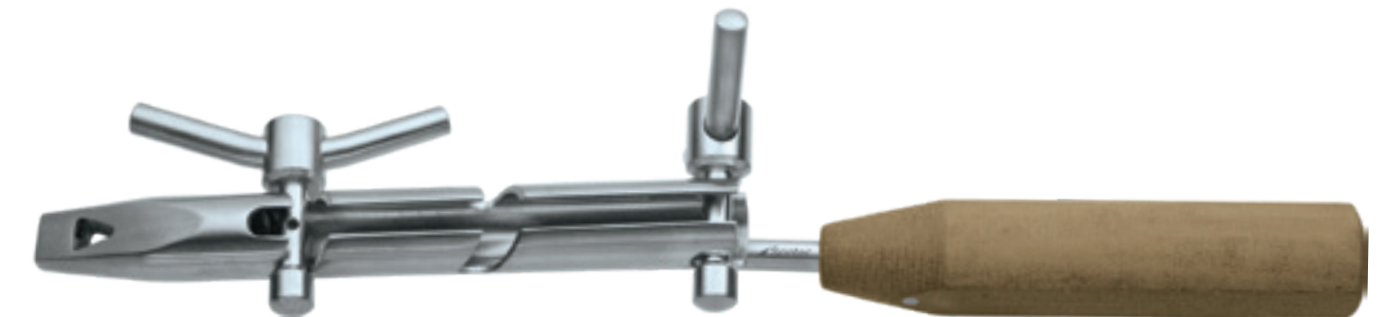

1100-496D



**CSU Meniscus Clamp**

5 3/4" (14.5 cm)  
 1103-204 str  
 1103-204A angled

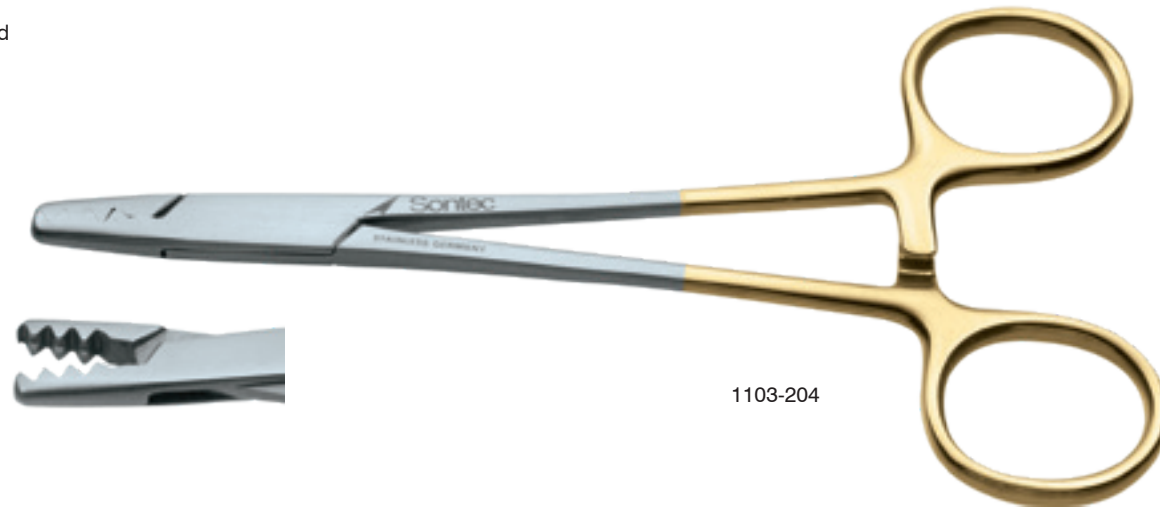

1103-204



1103-204A

**Sontec Meniscus Clamp**

Serrated grooved jaws middle weight  
 / 5 3/8" (13.5 cm)  
 1103-202 str  
 1103-203 angled

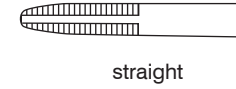

straight

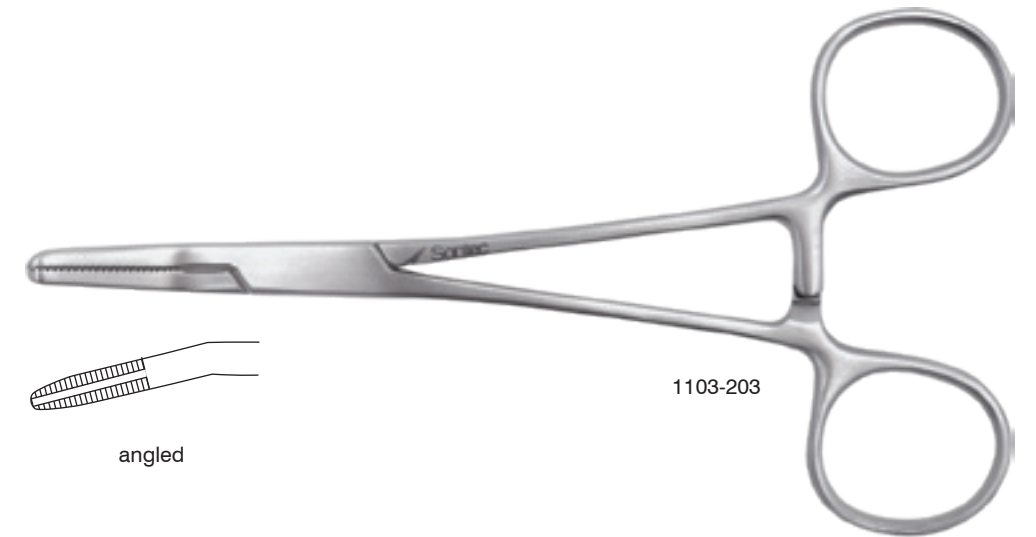

1103-203

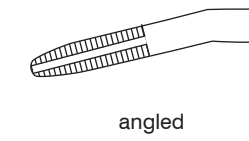

angled

**Sontec Delicate Meniscus Clamp**

Heavy serrated jaws with gap / 5 3/8" (13.5 cm)  
 1103-202D straight  
 1103-203D angled



1103-202D

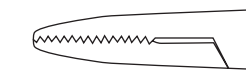

**DeBakey Meniscus Clamp**

Autotraumatic jaw / 3 cm jaw / 5 1/2" (14 cm)

142-199 str



3.0 mm DeBakey tip

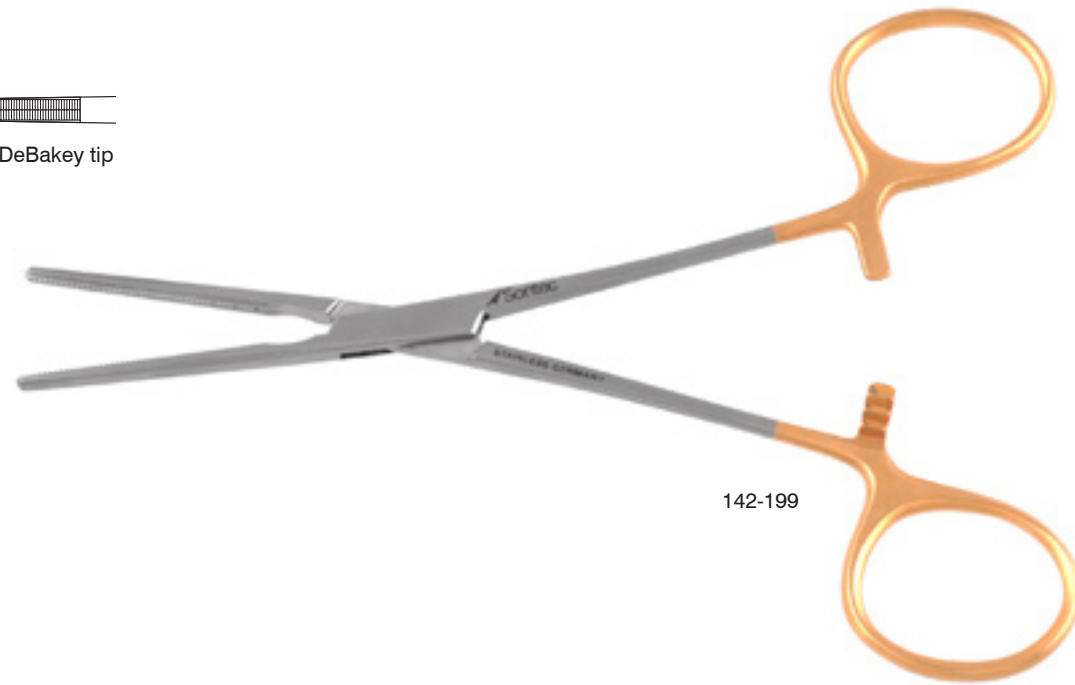

142-199

**Debakey Mosquito Forceps**

6" (15 cm)

2200-403 straight

2200-405 curved

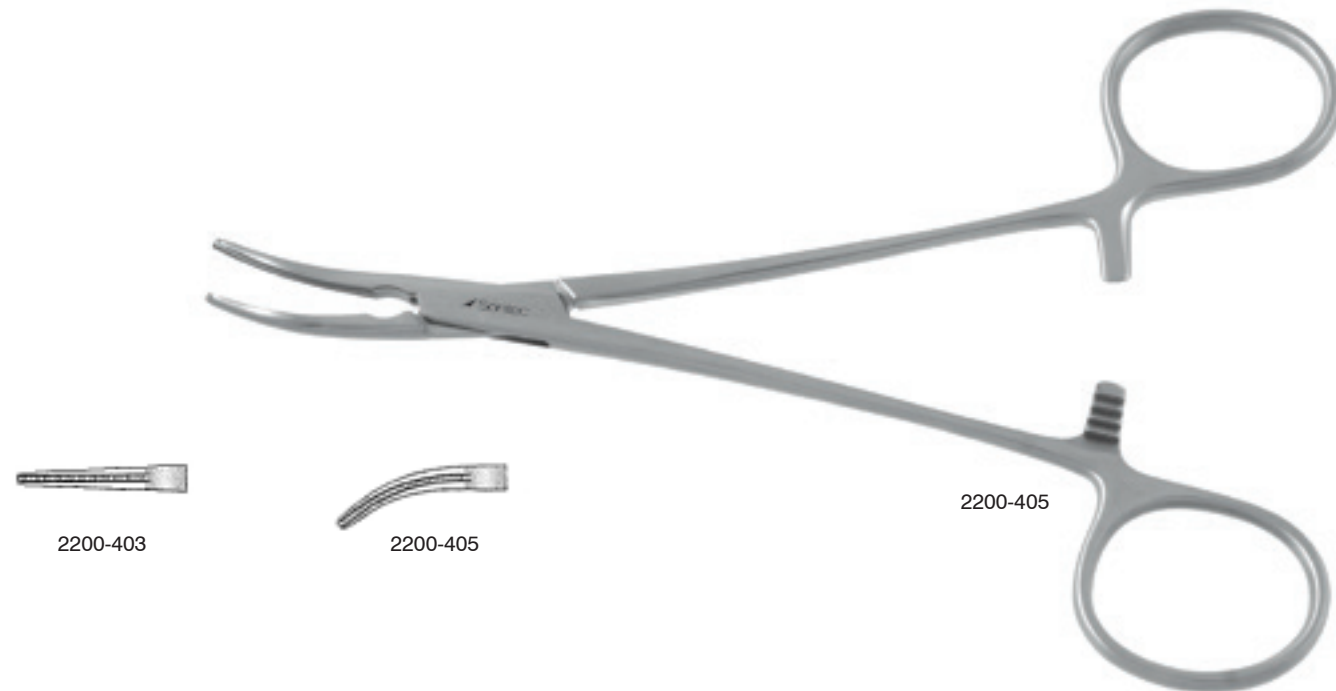

2200-405



2200-403



2200-405

**Martin Cartilage Clamp**

350-866 5 3/4" (14.6 cm)

350-867 6 1/2" (16.5 cm)

350-869 7" (18 cm)

350-871 8" (20 cm)



350-871

**Sontec Mesh Meniscus Clamp**

Fenestrated jaws / 7 1/4" (18.5 cm)

350-880 15 teeth with 1 x 2



350-880



 Sontec Instruments®

Laparoscopy

Features of Modular 2 and 3 Piece System

**Modular System**

1. Pick a tip
2. Choose a shaft that matches
3. Choose a handle type

**3 items complete the whole set**

**Plastic handle with stepless ratchet**

Sontec has fitted this ergonomically-shaped handle with a continuous-action lock that arrests it in any desired position.

A gentle push on the release button is all that is required to unlock it again.

This allows the user to determine the level of pressure to apply to the tissue being clamped, rather than being limited by predefined engaging increments.

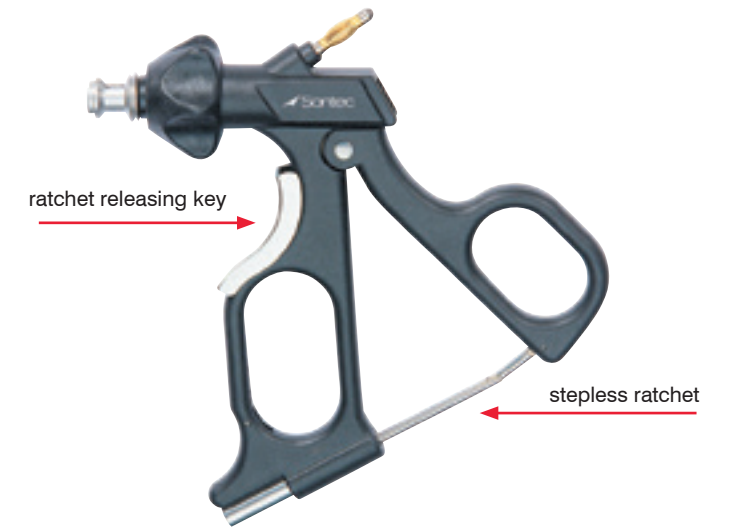

**Nut stopper**

A nut on the sleeve shaft of Sontec modular instruments prevents bothersome slipping or even the loss of the union nut.



**Axial HF connection**

The axial HF connection on Sontec modular angled metal handles prevents irritating pivoting motions of the cable. Moreover, the HF connection's location behind the hand aids well-balanced handling of the instrument.

**Protective bell fitting for HF connection**

A unique protective bell fitting surrounding the HF connection on Sontec modular angled metal handles provides the user with two-fold protection.

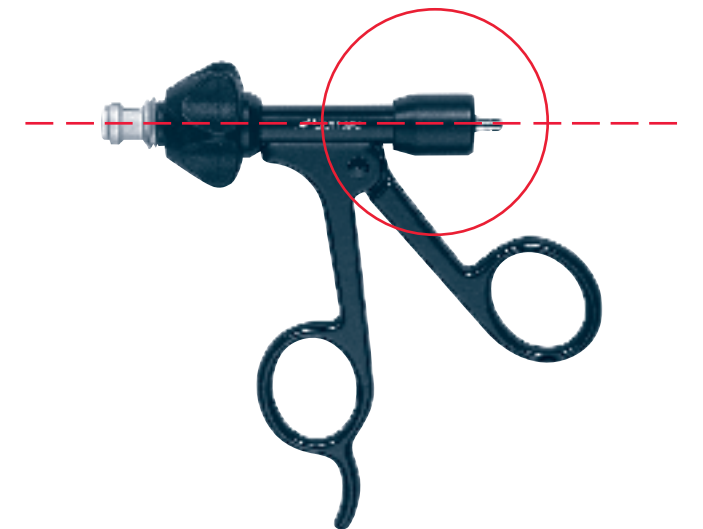

**Ergonomic Highly Rigid Plastic Ring Handle**

For Ø 3 mm, Ø 5 mm & Ø 10 mm tube shaft instruments

- 2901-090 with stepless ratchet, ratchet activating/release lever, rotation module & HF connection
- 2901-092 with stepless ratchet, ratchet release key, rotation module & HF connection
- 2901-094 with ratchet, ratchet activating/release lever, fold out ratchets, rotation module & HF connection
- 2901-096 with rotation module & HF connection
- 2901-098 with ratchet, ratchet activating/deactivating key, rotation module & HF connection

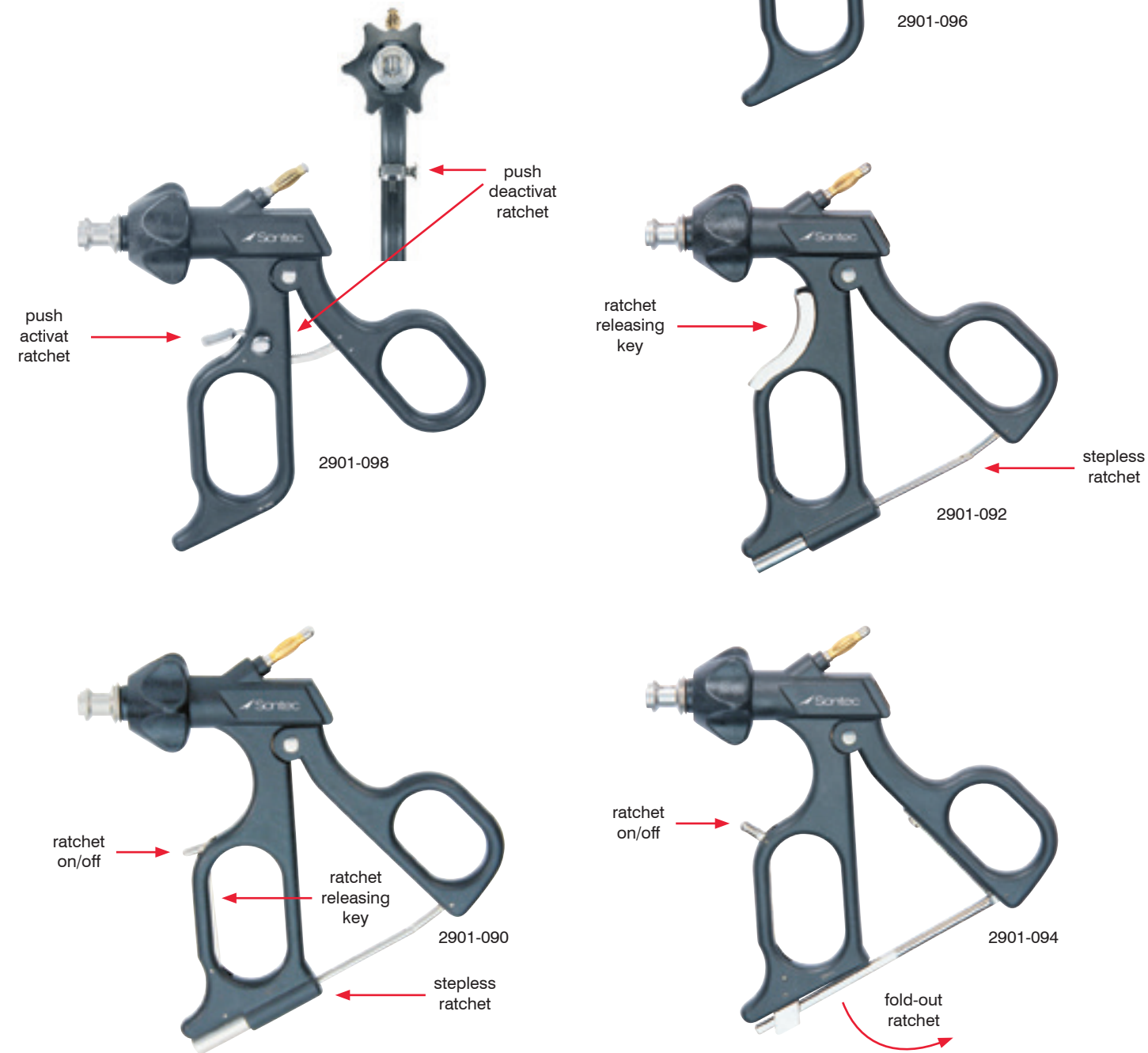

**Angled Insulated Metal Handle**

For Ø 3 mm, Ø 5 mm & Ø 10 mm tube shaft instruments

- 2901-060 with rotating head
- 2901-062 with rotating head & ratchet
- 2901-064 with rotating head & HF connector
- 2901-066 with rotating head, ratchet & HF connector



**Monopolar Cable**

3 meters / 8 mm Bovie Plug / with 4 mm socket

2695-105



**Laparoscopic Bulldog Clamp**

**Straight**

2901-281-45 45 mm jaw  
2901-281-60 60 mm jaw

**Curved**

2901-281-25 25 mm jaw overall length 2"  
2901-281-40 40 mm jaw overall length 2 1/2"



**Knot Pusher**

With hook / Ø4 mm / 330 mm working length

2901-350



**Laparoscopic Bulldog Clamp Forceps**

Applying clamp / rotatable shaft / articulating jaw / 18" working length

2901-281



**Axial Ring Handle**

For Ø 3 mm, Ø 5 mm & Ø 10 mm tube shaft instruments

2901-070 with ratchet  
2901-072 with ratchet for integral needleholder  
2901-074 without ratchet  
2901-078 with branches & ratchet  
2901-084 with branches & ratchet for integral needleholder angle handle  
2901-086 with branches & ratchet for integral needleholder angle handle without flushing



**Axial Handle**

For Ø 3 mm, Ø 5 mm & Ø 10 mm tube shaft instruments

2901-076 with spreading spring & ratchet  
2901-080 with spreading spring  
2901-082 with spreading spring & ratchet angled

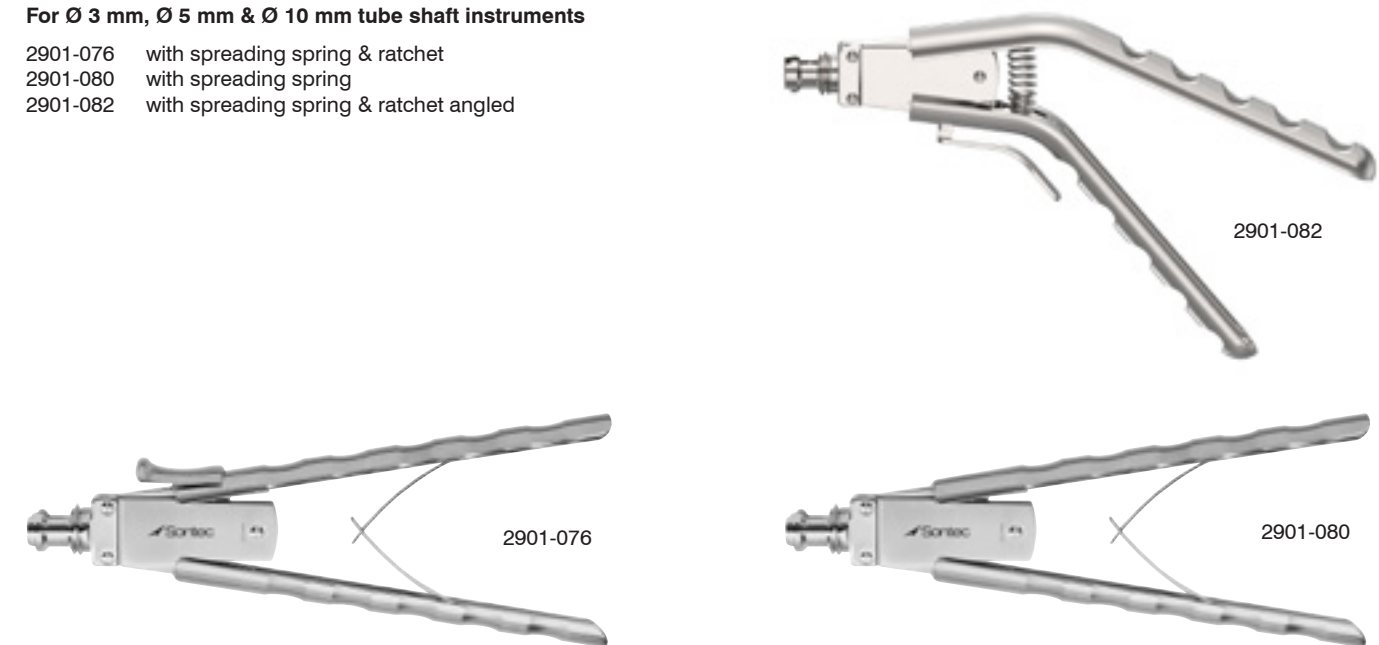

**Tube Shaft Insulated**

For Ø 5 mm modular 2-piece tube shaft instruments / insulated

2901-101	330 mm shaft length	without LUER lock
2901-101L	330 mm shaft length	with LUER lock
2901-102	360 mm shaft length	without LUER lock
2901-102L	360 mm shaft length	with LUER lock
2901-103	450 mm shaft length	without LUER lock
2901-103L	450 mm shaft length	with LUER lock



LUER lock



2901-101



2901-102



2901-103

**Tube Shaft Insulated**

For Ø 10 mm modular 2-piece tube shaft instruments / insulated

2901-104	330 mm shaft length	cylindrical	without LUER lock
2901-104L	330 mm shaft length	cylindrical	with LUER lock
2901-105	330 mm shaft length	reduce to Ø5 mm	without LUER lock
2901-105L	330 mm shaft length	reduce to Ø5 mm	with LUER lock
2901-106	360 mm shaft length	cylindrical	without LUER lock
2901-106L	360 mm shaft length	cylindrical	with LUER lock
2901-107	360 mm shaft length	reduce to Ø5 mm	without LUER lock
2901-107L	360 mm shaft length	reduce to Ø5 mm	with LUER lock
2901-108	450 mm shaft length	cylindrical	without LUER lock
2901-108L	450 mm shaft length	cylindrical	with LUER lock
2901-109	450 mm shaft length	reduce to Ø5 mm	without LUER lock
2901-109L	450 mm shaft length	reduce to Ø5 mm	with LUER lock



LUER lock



2901-104



2901-105



2901-106



2901-107



2901-108



2901-109

**Scissors Insert**

For Ø 5 mm tube shaft instruments

**Metzenbaum preparation scissors / straight / double action jaw**

- 2901-301S 330 mm shaft length
- 2901-301 360 mm shaft length
- 2901-301L 450 mm shaft length



**Metzenbaum preparation scissors / curved / double action jaw**

- 2901-302S 330 mm shaft length
- 2901-302 360 mm shaft length
- 2901-302L 450 mm shaft length



**Power Cut preparation scissors / curved / double action jaw**

- 2901-303S 330 mm shaft length
- 2901-303 360 mm shaft length
- 2901-303L 450 mm shaft length



**Metzenbaum soft preparation scissors / curved / double action jaw**

- 2901-304S 330 mm shaft length
- 2901-304 360 mm shaft length
- 2901-304L 450 mm shaft length



**Metzenbaum preparation scissors / curved / double action jaw / serrated / strong version**

- 2901-305S 330 mm shaft length
- 2901-305 360 mm shaft length
- 2901-305L 450 mm shaft length



**Peritoneal scissors / straight / single action jaw**

- 2901-306S 330 mm shaft length
- 2901-306 360 mm shaft length
- 2901-306L 450 mm shaft length



**Hook scissors / single action jaw**

- 2901-307S 330 mm shaft length
- 2901-307 360 mm shaft length
- 2901-307L 450 mm shaft length



**Micro scissors / straight / single action jaw**

- 2901-308S 330 mm shaft length
- 2901-308 360 mm shaft length
- 2901-308L 450 mm shaft length



**Micro scissors / curved / single action jaw**

- 2901-309S 330 mm shaft length
- 2901-309 360 mm shaft length
- 2901-309L 450 mm shaft length



**Requires shaft & handle**



**Grasping Forceps Insert**

For Ø 5 mm tube shaft instruments

**Universal grasping forceps / double action jaw**

- 2901-211S 330 mm shaft length
- 2901-211 360 mm shaft length
- 2901-211L 450 mm shaft length



**Maxigrip grasping forceps / double action jaw**

- 2901-212S 330 mm shaft length
- 2901-212 360 mm shaft length
- 2901-212L 450 mm shaft length



**Maryland grasping forceps / double action jaw**

- 2901-213S 330 mm shaft length
- 2901-213 360 mm shaft length
- 2901-213L 450 mm shaft length



**Kelly grasping forceps / double action jaw**

- 2901-214S 330 mm shaft length
- 2901-214 360 mm shaft length
- 2901-214L 450 mm shaft length



**Dissecting forceps / fenestrated jaw / double action jaw**

- 2901-215S 330 mm shaft length
- 2901-215 360 mm shaft length
- 2901-215L 450 mm shaft length



**Dorsey grasping forceps / fenestrated / 20 mm jaw length / double action jaw**

- 2901-216S 330 mm shaft length
- 2901-216 360 mm shaft length
- 2901-216L 450 mm shaft length



**Dorsey grasping forceps / fenestrated / 20 mm jaw length / single action jaw**

- 2901-217S 330 mm shaft length
- 2901-217 360 mm shaft length
- 2901-217L 450 mm shaft length



**Dorsey grasping forceps / fenestrated / 40 mm jaw length / double action jaw**

- 2901-218S 330 mm shaft length
- 2901-218 360 mm shaft length
- 2901-218L 450 mm shaft length



**Duck-Bill grasping forceps / fenestrated / single action jaw**

- 2901-219S 330 mm shaft length
- 2901-219 360 mm shaft length
- 2901-219L 450 mm shaft length



**Grasping Forceps Insert**

For Ø 5 mm tube shaft instruments

**Grasping forceps / 2x4 teeth / double action jaw**

- 2901-220S 330 mm shaft length
- 2901-220 360 mm shaft length
- 2901-220L 450 mm shaft length



**Grasping forceps / 2x4 teeth / single action jaw**

- 2901-221S 330 mm shaft length
- 2901-221 360 mm shaft length
- 2901-221L 450 mm shaft length



**Grasping forceps / with reservoir / double action jaw / blunt**

- 2901-222S 330 mm shaft length
- 2901-222 360 mm shaft length
- 2901-222L 450 mm shaft length



**Grasping forceps / with reservoir / double action jaw / sharp**

- 2901-223S 330 mm shaft length
- 2901-223 360 mm shaft length
- 2901-223L 450 mm shaft length



**Grasping forceps / double action jaw**

- 2901-224S 330 mm shaft length
- 2901-224 360 mm shaft length
- 2901-224L 450 mm shaft length



**Dolphin grasping forceps / double action jaw**

- 2901-225S 330 mm shaft length
- 2901-225 360 mm shaft length
- 2901-225L 450 mm shaft length



**Dolphin grasping forceps / long / with reservoir / double action jaw**

- 2901-226S 330 mm shaft length
- 2901-226 360 mm shaft length
- 2901-226L 450 mm shaft length



**Grasping forceps / smooth / double action jaw**

- 2901-227S 330 mm shaft length
- 2901-227 360 mm shaft length
- 2901-227L 450 mm shaft length



**Grasping forceps / sharp / crosswise teeth / 14 mm jaw length / double action jaw**

- 2901-228S 330 mm shaft length
- 2901-228 360 mm shaft length
- 2901-228L 450 mm shaft length



Requires shaft & handle



**Grasping Forceps Insert**

For Ø 5 mm tube shaft instruments

**Grasping forceps / single action jaw / straight / crosswise teeth / 18 mm jaw length**

- 2901-229S 330 mm shaft length
- 2901-229 360 mm shaft length
- 2901-229L 450 mm shaft length



**Grasping forceps / double action jaw / sharp / crosswise teeth / 18 mm jaw length**

- 2901-230S 330 mm shaft length
- 2901-230 360 mm shaft length
- 2901-230L 450 mm shaft length



**Grasping forceps / distal / with row of teeth / single action jaw**

- 2901-231S 330 mm shaft length
- 2901-231 360 mm shaft length
- 2901-231L 450 mm shaft length



**Grasping forceps / distal / with row of teeth / double action jaw**

- 2901-232S 330 mm shaft length
- 2901-232 360 mm shaft length
- 2901-232L 450 mm shaft length



**Grasping forceps / double action jaw**

- 2901-233S 330 mm shaft length
- 2901-233 360 mm shaft length
- 2901-233L 450 mm shaft length



**Grasping forceps / with fine crosswise teeth / double action jaw**

- 2901-234S 330 mm shaft length
- 2901-234 360 mm shaft length
- 2901-234L 450 mm shaft length



**Grasping forceps / with mouse teeth / double action jaw**

- 2901-235S 330 mm shaft length
- 2901-235 360 mm shaft length
- 2901-235L 450 mm shaft length



**Grasping forceps / with mouse teeth / single action jaw**

- 2901-236S 330 mm shaft length
- 2901-236 360 mm shaft length
- 2901-236L 450 mm shaft length



Requires shaft & handle



## Grasping Forceps Insert

For Ø 5 mm tube shaft instruments

**Grasping forceps / with DeBakey teeth / double action jaw**

2901-237S 330 mm shaft length  
 2901-237 360 mm shaft length  
 2901-237L 450 mm shaft length



**Extracting forceps / with rows of retrograde teeth / double action jaw**

2901-238S 330 mm shaft length  
 2901-238 360 mm shaft length  
 2901-238L 450 mm shaft length



**Mixer grasping forceps / 90° angle / double action jaw**

2901-239S 330 mm shaft length  
 2901-239 360 mm shaft length  
 2901-239L 450 mm shaft length



**Mixer grasping forceps / 45° angle / double action jaw**

2901-240S 330 mm shaft length  
 2901-240 360 mm shaft length  
 2901-240L 450 mm shaft length



**Tenaculum grasping forceps / double action jaw**

2901-241S 330 mm shaft length  
 2901-241 360 mm shaft length  
 2901-241L 450 mm shaft length



**Claw grasping & extracting forceps / 2x3 teeth / single action jaw**

2901-242S 330 mm shaft length  
 2901-242 360 mm shaft length  
 2901-242L 450 mm shaft length



**AGRESSIV claw grasping forceps / double action jaw**

2901-243S 330 mm shaft length  
 2901-243 360 mm shaft length  
 2901-243L 450 mm shaft length



Requires shaft & handle



## Grasping Forceps Insert

For Ø 5 mm tube shaft instruments

**Atraumatic grasping forceps / with wavy teeth / with reservoir / single action jaw**

2901-244S 330 mm shaft length  
 2901-244 360 mm shaft length  
 2901-244L 450 mm shaft length



**Atraumatic grasping forceps / with wavy teeth / with reservoir / double action jaw**

2901-245S 330 mm shaft length  
 2901-245 360 mm shaft length  
 2901-245L 450 mm shaft length

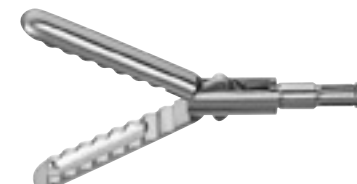

**Claw grasping forceps for retraction / with wavy teeth / single action jaw**

2901-246S 330 mm shaft length  
 2901-246 360 mm shaft length  
 2901-246L 450 mm shaft length



**Claw grasping forceps for retraction / with wavy teeth / double action jaw**

2901-247S 330 mm shaft length  
 2901-247 360 mm shaft length  
 2901-247L 450 mm shaft length



**WAVE grasping forceps / fenestrated / double action jaw**

2901-248S 330 mm shaft length  
 2901-248 360 mm shaft length  
 2901-248L 450 mm shaft length



## Clamp Insert

For Ø 5 mm tube shaft instruments

**DeBakey clamp / 30 mm jaw length / double action jaw**

2901-249S 330 mm shaft length  
 2901-249 360 mm shaft length  
 2901-249L 450 mm shaft length



**Babcock clamp / double action jaw**

2901-250S 330 mm shaft length  
 2901-250 360 mm shaft length  
 2901-250L 450 mm shaft length



**Cup Insert**

For Ø 5 mm tube shaft instruments

**Tumor grasping forceps / pointed / single action jaw**

- 2901-121S 330 mm shaft length
- 2901-121 360 mm shaft length
- 2901-121L 450 mm shaft length



**Biopsy cup / double action jaw**

- 2901-123S 330 mm shaft length
- 2901-123 360 mm shaft length
- 2901-123L 450 mm shaft length



**Biopsy cup / with thorn / double action jaw**

- 2901-125S 330 mm shaft length
- 2901-125 360 mm shaft length
- 2901-125L 450 mm shaft length



**Biopsy cup long / single action jaw**

- 2901-127S 330 mm shaft length
- 2901-127 360 mm shaft length
- 2901-127L 450 mm shaft length



**Biopsy cup long / with thorn / single action jaw**

- 2901-129S 330 mm shaft length
- 2901-129 360 mm shaft length
- 2901-129L 450 mm shaft length



**Alligator grasping forceps / double action jaw**

- 2901-131S 330 mm shaft length
- 2901-131 360 mm shaft length
- 2901-131L 450 mm shaft length



**Punch Insert**

For Ø5 mm tube shaft instruments

**Biopsy punch / without thorn / single action jaw**

- 2901-115S 330 mm shaft length
- 2901-115 360 mm shaft length
- 2901-115L 450 mm shaft length



**Biopsy punch / with thorn / single action jaw**

- 2901-117S 330 mm shaft length
- 2901-117 360 mm shaft length
- 2901-117L 450 mm shaft length



Requires shaft & handle



**Needle Holder Insert**

For Ø 5 mm tube shaft instruments

**Needle holder / with TC serrated crosswise teeth / straight / single action jaw**

- 2901-321S 330 mm shaft length
- 2901-321 360 mm shaft length
- 2901-321L 450 mm shaft length



**Needle holder / with TC serrated crosswise teeth / left curved / single action jaw**

- 2901-322S 330 mm shaft length
- 2901-322 360 mm shaft length
- 2901-322L 450 mm shaft length



**Needle holder / with TC serrated crosswise teeth / right curved / single action jaw**

- 2901-323S 330 mm shaft length
- 2901-323 360 mm shaft length
- 2901-323L 450 mm shaft length



**Needle holder positioner / with TC dust / convex/concave shaped jaws with fixation teeth / single action jaw**

- 2901-324S 330 mm shaft length
- 2901-324 360 mm shaft length
- 2901-324L 450 mm shaft length



**Dissecting Forceps Insert**

For Ø5 mm tube shaft instruments

**Dissecting forceps / fenestrated / double action jaw**

- 2901-252S 330 mm shaft length
- 2901-252 360 mm shaft length
- 2901-252L 450 mm shaft length



**Dissecting forceps / fenestrated / slim / double action jaw**

- 2901-254S 330 mm shaft length
- 2901-254 360 mm shaft length
- 2901-254L 450 mm shaft length



Requires shaft & handle



**Grasping Forceps Insert**

For Ø 10 mm tube shaft instruments

**Claw grasping & extracting forceps / 2x3 teeth / single action jaw**

- 2901-260S 330 mm shaft length
- 2901-260 360 mm shaft length
- 2901-260L 450 mm shaft length



**Claw grasping & extracting forceps / 2x3 teeth / double action jaw**

- 2901-261S 330 mm shaft length
- 2901-261 360 mm shaft length
- 2901-261L 450 mm shaft length



**Maryland grasping forceps / double action jaw**

- 2901-262S 330 mm shaft length
- 2901-262 360 mm shaft length
- 2901-262L 450 mm shaft length



**Grasping forceps / with DeBaakey teeth / fenestrated / double action jaw**

- 2901-264S 330 mm shaft length
- 2901-264 360 mm shaft length
- 2901-264L 450 mm shaft length



**Babcock grasping forceps / double action jaw**

- 2901-265S 330 mm shaft length
- 2901-265 360 mm shaft length
- 2901-265L 450 mm shaft length



**Babcock grasping forceps / with crosswise teeth / double action jaw**

- 2901-266S 330 mm shaft length
- 2901-266 360 mm shaft length
- 2901-266L 450 mm shaft length



Requires shaft & handle



**Grasping Forceps Insert**

For Ø 10 mm tube shaft instruments

**Mixer grasping forceps / double action jaw**

- 2901-267S 330 mm shaft length
- 2901-267 360 mm shaft length
- 2901-267L 450 mm shaft length



**Dorsey grasping forceps / double action jaw**

- 2901-268S 330 mm shaft length
- 2901-268 360 mm shaft length
- 2901-268L 450 mm shaft length



**Tenaculum forceps / double action jaw**

- 2901-275S 330 mm shaft length
- 2901-275 360 mm shaft length
- 2901-275L 450 mm shaft length

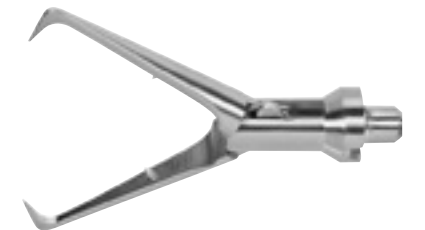

**Cup Insert**

For Ø 10 mm tube shaft instruments

**Large cup / single action jaw**

- 2901-280S 330 mm shaft length
- 2901-280 360 mm shaft length
- 2901-280L 450 mm shaft length



**Scissors Insert**

For Ø 10 mm tube shaft instruments

**Large operating scissors / single action jaw**

- 2901-279S 330 mm shaft length
- 2901-279 360 mm shaft length
- 2901-279L 450 mm shaft length



Requires shaft & handle



**Grasping Clamp Insert**

For Ø 10 mm tube shaft instruments

**Kocher clamp / double action jaw**

- 2901-269S 30 mm jaw length / 330 mm shaft length
- 2901-269 30 mm jaw length / 360 mm shaft length
- 2901-269L 30 mm jaw length / 450 mm shaft length
- 2901-270S 40 mm jaw length / 330 mm shaft length
- 2901-270 40 mm jaw length / 360 mm shaft length
- 2901-270L 40 mm jaw length / 450 mm shaft length
- 2901-271S 50 mm jaw length / 330 mm shaft length
- 2901-271 50 mm jaw length / 360 mm shaft length
- 2901-271L 50 mm jaw length / 450 mm shaft length



**DeBakey clamp / double teeth / double action jaw**

- 2901-272S 30 mm jaw length / 330 mm shaft length
- 2901-272 30 mm jaw length / 360 mm shaft length
- 2901-272L 30 mm jaw length / 450 mm shaft length
- 2901-273S 40 mm jaw length / 330 mm shaft length
- 2901-273 40 mm jaw length / 360 mm shaft length
- 2901-273L 40 mm jaw length / 450 mm shaft length
- 2901-274S 50 mm jaw length / 330 mm shaft length
- 2901-274 50 mm jaw length / 360 mm shaft length
- 2901-274L 50 mm jaw length / 450 mm shaft length



**Babcock clamp / double action jaw**

- 2901-276S 330 mm shaft length
- 2901-276 360 mm shaft length
- 2901-276L 450 mm shaft length



**Collin clamp / double action jaw**

- 2901-277S 330 mm shaft length
- 2901-277 360 mm shaft length
- 2901-277L 450 mm shaft length



**Pennington clamp / double action jaw**

- 2901-278S 330 mm shaft length
- 2901-278 360 mm shaft length
- 2901-278L 450 mm shaft length



**Overhold clamp / with fine teeth / curved / double action jaw**

- 2901-263S 330 mm shaft length
- 2901-263 360 mm shaft length
- 2901-263L 450 mm shaft length



**Integrated Needle Holder**

Axial-ratchet-handle / LUER lock irrigation adapter / Ø 5 mm / 330 mm working length / four jaw types

**Needle holder / with inserted TC crosswise teeth / single action jaw / straight**

- 2901-330 straight
- 2901-331 angled



**Needle holder / with inserted TC crosswise teeth / single action jaw / left curved**

- 2901-334 straight
- 2901-335 angled



**Needle holder / with inserted TC crosswise teeth / single action jaw / right curved**

- 2901-336 straight
- 2901-337 angled
- 2901-337S angled 190 mm



**Needle holder/positioner / with fixation teeth / TC dust / single action jaw / convex/concave jaw / straight**

- 2901-340 straight
- 2901-341 angled





### Scissors Working Part

For Ø 3 mm tube shaft instruments

#### Metzenbaum preparation scissors / straight / double action jaw

2901-311S 180 mm shaft length  
 2901-311 210 mm shaft length  
 2901-311L 330 mm shaft length



#### Metzenbaum preparation scissors / curved / double action jaw

2901-312S 180 mm shaft length  
 2901-312 210 mm shaft length  
 2901-312L 330 mm shaft length



#### Peritoneal scissors / straight / single action jaw

2901-313S 180 mm shaft length  
 2901-313 210 mm shaft length  
 2901-313L 330 mm shaft length



#### Hook scissors / single action jaw

2901-314S 180 mm shaft length  
 2901-314 210 mm shaft length  
 2901-314L 330 mm shaft length



#### Micro scissors / straight / single action jaw

2901-315S 180 mm shaft length  
 2901-315 210 mm shaft length  
 2901-315L 330 mm shaft length



### Biopsy Cup Working Part

For Ø 3 mm tube shaft instruments

#### Double action jaw / without thorn

2901-111S 180 mm shaft length  
 2901-111 210 mm shaft length  
 2901-111L 330 mm shaft length



#### Double action jaw / with thorn

2901-113S 180 mm shaft length  
 2901-113 210 mm shaft length  
 2901-113L 330 mm shaft length



### Grasping Forceps Working Part

For Ø 3 mm tube shaft instruments

#### Universal grasping forceps / double action jaw

2901-201S 180 mm shaft length  
 2901-201 210 mm shaft length  
 2901-201L 330 mm shaft length



#### Maryland grasping forceps / double action jaw

2901-202S 180 mm shaft length  
 2901-202 210 mm shaft length  
 2901-202L 330 mm shaft length



#### Dissecting forceps / fenestrated / double action jaw

2901-203S 180 mm shaft length  
 2901-203 210 mm shaft length  
 2901-203L 330 mm shaft length



#### Grasping forceps / with reservoir / blunt / double action jaw

2901-204S 180 mm shaft length  
 2901-204 210 mm shaft length  
 2901-204L 330 mm shaft length



#### Grasping forceps / with reservoir / sharp / double action jaw

2901-205S 180 mm shaft length  
 2901-205 210 mm shaft length  
 2901-205L 330 mm shaft length



#### Dolphin grasping forceps / double action jaw

2901-206S 180 mm shaft length  
 2901-206 210 mm shaft length  
 2901-206L 330 mm shaft length



#### Grasping forceps / sharp / crosswise teeth / 12 mm jaw length / double action jaw

2901-207S 180 mm shaft length  
 2901-207 210 mm shaft length  
 2901-207L 330 mm shaft length



#### Claw grasping & extracting forceps / 2x3 teeth / single action jaw

2901-208S 180 mm shaft length  
 2901-208 210 mm shaft length  
 2901-208L 330 mm shaft length



Assembling of Modular System

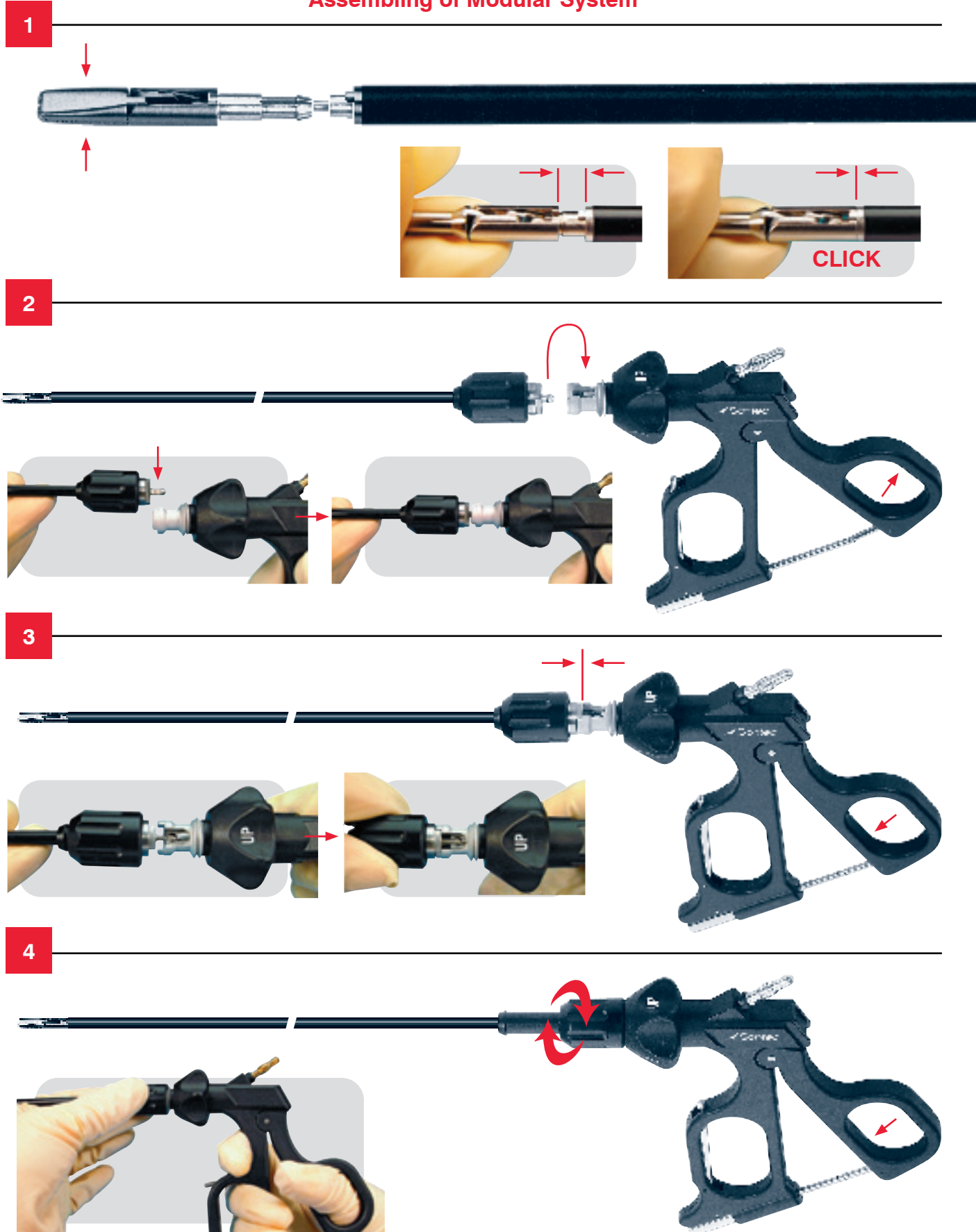

Disassembling of Modular System

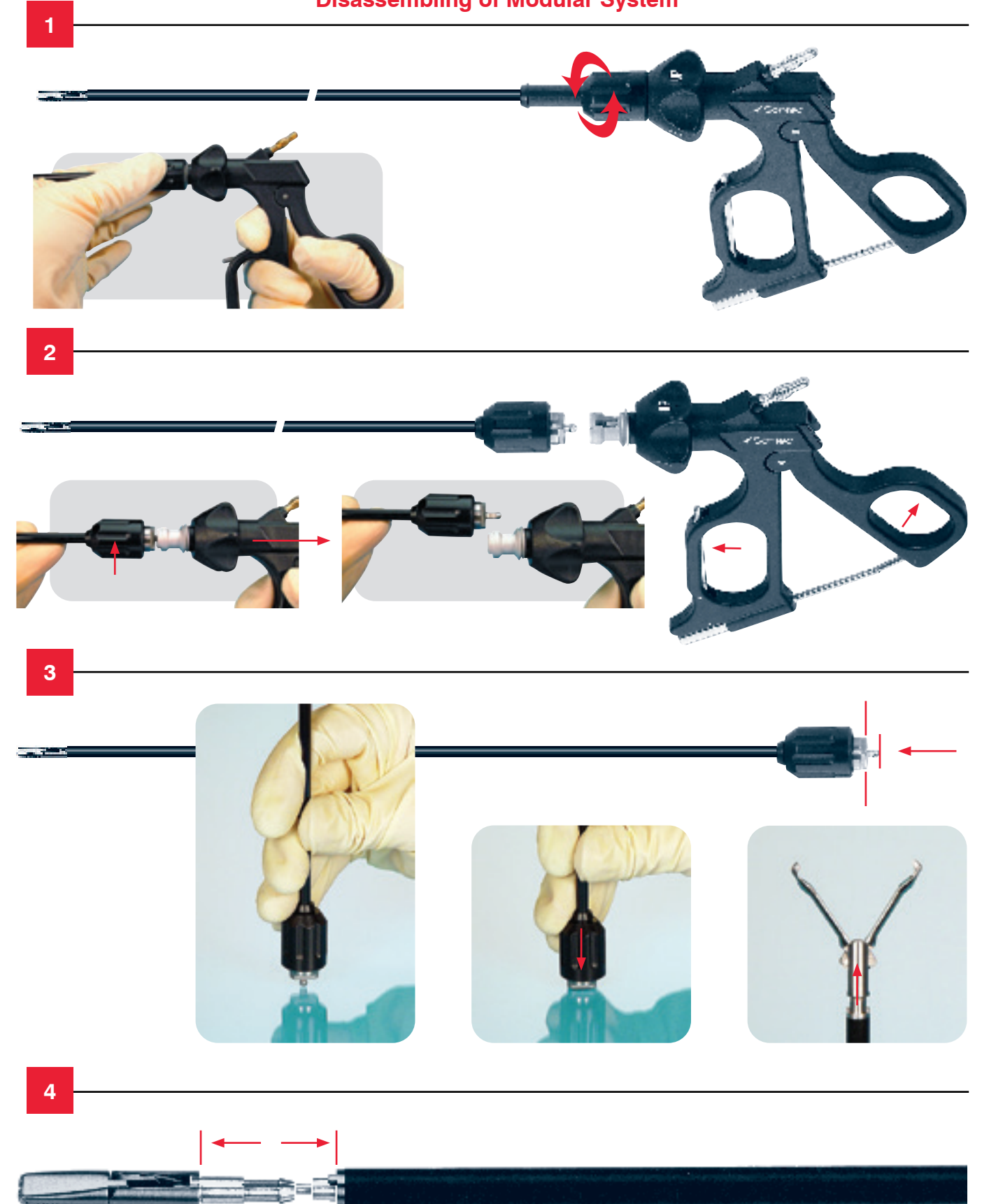



 Sontec Instruments®

Surgical SETS

**Veterinary Surgical Sets**

\* PLEASE NOTE: The instruments included in our sets are "standard quality". All packs are customizable and upgradeable.

**General Surgery Set**

**1100-005**

- 4 6 1/4" Rochester Carmalt Forceps, Curved (1100-152)
- 2 5 1/2" Kelly Forceps, Straight (115-446)
- 1 8" Snook Ovariectomy Hook (1100-756)
- 3 5" Halstead Mosquito Forceps, Curved (115-412)
- 1 5 1/2" Olsen Hegar Needle Holder, TC serrated (1100-106)
- 4 5 1/4" Backhaus Towel Forceps (117-503)
- 1 6 3/4" Mayo Scissors, Straight (1100-250)
- 1 Knife Handle, #3 (1100-740)
- 1 7" Metzenbaum Scissors, Curved (1100-244)
- 1 Brown Adson Forceps, 9 x 9 Teeth (136-686)

**Feline Spay Set**

**1100-006**

- 1 Snook Ovariectomy Hook (1100-756)
- 1 5 1/2" Olsen Hegar Needle Holder, TC serrated (1100-106)
- 1 6 3/4" Mayo Scissors, Straight (1100-250)
- 1 Brown Adson Forceps, 9 x 9 Teeth (136-686)
- 1 Knife Handle, #3 (1100-740)
- 4 3 1/2" Backhaus Towel Forceps (117-500)
- 2 5" Halstead Mosquito Forceps, Straight (115-410)
- 2 5" Halstead Mosquito Forceps, Curved (115-412)
- 2 5 1/2" Kelly Forceps, Straight (115-446)
- 2 5 1/2" Kelly Forceps, Curved (115-448)

**Canine Spay Set**

**1100-007**

**Includes everything in Feline Spay Pack listed above plus**

- 1 6" Allis Forceps, 4 x 5 Teeth (140-320)

**Rabbit Dental Set**

**1100-040**

- 1 Small Cheek Spreader (1103-363)
- 1 Chinchilla Cheek Spreader (1103-367)
- 1 Dental Rasp, Fine (1103-379)
- 1 Tooth Cutting Forceps (1103-368)
- 1 Small Rodent Mouth Gag (1103-380)

**Deluxe Rodent Dental Set**

**1100-042**

- 1 Operating Table for Rodents (1103-376)
- 1 Small Cheek Spreader (1103-363)
- 1 Dental Rasp, Fine (1103-372)
- 1 Tooth Cutting Forceps (1103-368)

**Basic Orthopedic Set**

**1100-022**

- 1 IM Pin Chuck With Key (1103-185)
- 1 Lempert Rongeur, Curved, 2.5 mm x 10 mm Jaws (315-544)
- 1 Wire Suture Scissors, Angled, Serrated (1100-308)
- 1 7" Wire Twister / Needle Holder, With Hole, Golded (1103-150)
- 1 Complete Assorted Pins & K-wires, with Canvas Bag (1106-730)
- 2 Orthopedic SS Wire, 2 Sizes (1106-620)

**Orthopedic Set**

**1100-020**

- 1 5 3/4" Wire End Cutter, TC (1103-110)
- 2 Senn Retractors, Double-Ended, Sharp (1100-668)
- 1 6 3/4" Bruns Curette, Straight, Sizes 00000-5 (320-808)
- 1 5 3/4" Weitlaner Retractor, Sharp (1100-618)
- 1 Sontec® Mallet, With Nylon Head (1100-462S)
- 1 Gigli Saw Handles, Pair (1100-508)

- 1 12" Gigli Braided SS Wire (1100-503)
- 1 7" Wire Twister / Needle Holder, With Hole, Golded (1103-150)
- 1 7 3/4" Freer Periosteal Elevator (1100-798)
- 1 5 1/2" Kern Bone Holding Clamp (305-334)
- 1 8 1/2" Kern Bone Holding Clamp (305-336)
- 1 8 1/4" Foman 4-Sided Double-Ended Rasp (1100-492)
- 1 Lempert Rongeur, Curved, 2.5 mm x 10 mm Jaws (315-544)
- 1 Wire Suture Scissors, Angled, Serrated (1100-308)
- 1 IM Pin Chuck With Key (1103-185)
- 1 Sontec® Osteotome, 8 mm x 5" (1103-284)
- 2 Orthopedic SS Wire, 2 Sizes (1106-620)
- 1 Complete Assorted Pins & K-wires, with Canvas Bag (1106-730)

**Orthopedic Knee Surgery Set**

**1100-024**

- 1 Hohmann or Mini Hohmann Elevator
- 1 Neroma-Gelpi Retractor \*
- 2 Senn or Ragnell Retractors
- 1 Cartilage Forceps, With Large Multi-Toothed Jaws

\* Exclusive Sontec® design, size of your choice

**Orthopedic Drill Set**

**1100-026**

- 1 Makita Rechargeable Variable Speed Drill
- 1 Battery Charger
- 1 3/8" SS Chuck
- 1 3" Extension
- 1 Manufacturer's Plastic Case
- 1 Chuck Key

**Basic Ophthalmic Set**

**1100-030**

- 1 Thermoplastic Case, 3" x 6" (1103-700)
- 1 Halsey Needle Holder (132-373)

- 1 Bishop Harmon Forceps, 1 x 2 Teeth, 0.8 mm Tip (14-3810)
- 1 Stevens Tenotomy Scissors, Curved (13-8810)
- 1 Barraquer Wire Speculum, Large (10-1030)

**Extended Ophthalmic Set**

**1100-035**

- 1 Thermoplastic Case, 4" x 8" (1103-723)
- 1 Castroviejo Needle Holder, TC Dust, With Lock (15-1912)
- 2 Micro Eye Blades, #64 (19-1510)
- 1 3K Eye Blade Knife Handle (117-560)
- 1 Bishop Harmon Forceps, 1 x 2 Teeth, 0.8 mm Tip (14-3810)
- 1 Stevens Tenotomy Scissors, Curved (13-8810)
- 1 Barraquer Wire Speculum, Large (10-1030)
- 1 Desmarres Chalazion Clamp, Medium (14-9901)

**Titanium Avian Set**

**1103-900**

- Tray 1103-723
- Ring Tip Forceps 2600-525
- Needle Holder 2600-684L
- Scissors 1103-869T

**General Dental Set**

**1100-044**

- 1103-389A Winged Elevator with short handle 2 mm
- 1103-389C Winged Elevator with short handle 4 mm
- 1103-389D Winged Elevator with short handle 5 mm
- 1102-ER1 Root Pick straight flat tip (ER1)
- 1103-583 Molt Periosteal Elevator CMS9 DE
- 1103-353 Micro Upper Pedo Extractor TCD 4 3/4"
- 1103-352 Micro Lower Pedo Extractor TCD 4 3/4"
- 1102-EX9 DBL END Probe/Hook Explorer PW-23
- 1102-PW23 Goldman Fox Curette double end (SC GF2)
- 1102-SCJ2-3 Gracey Curette - SCGR13-14
- 1102-RESCGR13-14 Gracey Curette - SCGR13-14
- 1103-715 Plastic Tray double 10 X 6 X 1 1/2 PT



**Avian Micro Set**

**1103-900 set**

**Includes:**

- 1103-723 4" x 8" tray
- 2600-525 ring tip forcep
- 1103-885C needle holder
- 2600-916 double-action scissors

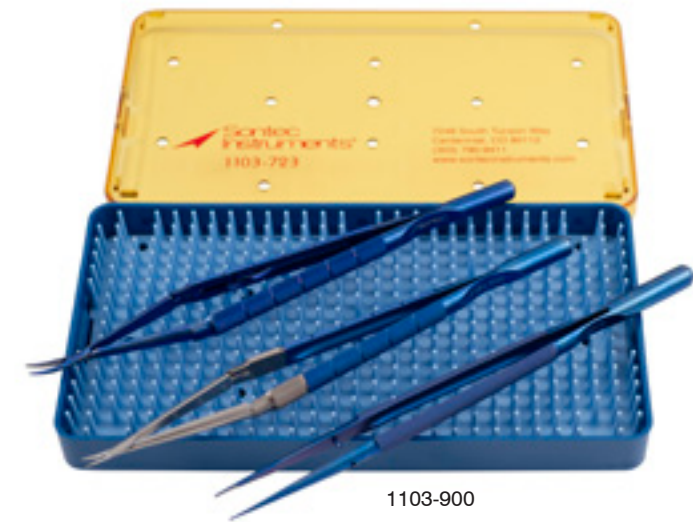

**HF-Ciradur Scissors**

Monopolar / blunt/blunt / 4.5 mm diameter / 300 mm working length

20925-56 30° curved down up opening  
20925-53 30° curved down side opening

Metzenbaum / monopolar / curved left / 4.5 mm diameter / 300 mm working length

20928-51 30° curved down up opening  
20928-53 30° side opening side opening

\* 7 mm trocar



**Hook Electrode**

4.7 mm diameter / 300 mm working length

20945-01 30° down curved upward  
20945-03 30° down curved upward-hook curved left  
20945-04 30° down curved upward-hook curved right

\* 7 mm trocar



**Bipolar Dissector**

Curved / 5 mm diameter / 340 mm working length

26950-05 insert only: article no. 04-02735-07



**VATS Starter Set**

2100-818 Cardiovascular Clamp-1x2 Debakey jaw / with ratchet / curved / 15"

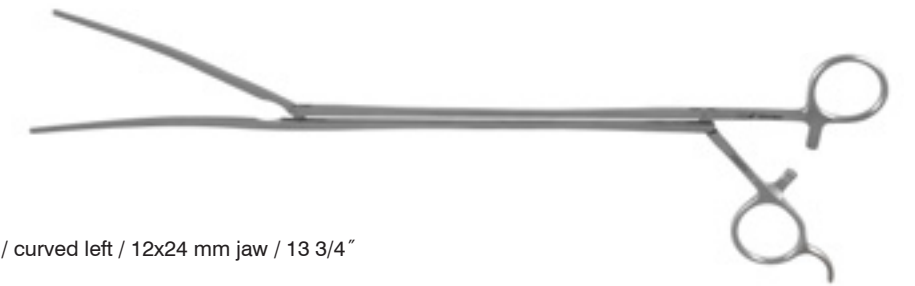

2100-823 VATS Foerster Clamp- with ratchet / curved left / 12x24 mm jaw / 13 3/4"



2100-824 VATS Foerster Clamp- with ratchet / curved left / 6 mm oval ring jaw / 13.25"

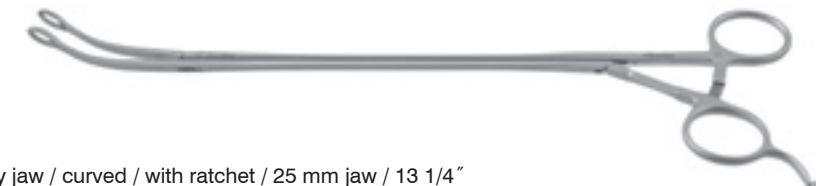

2100-826 Duval Cardio vascular Clamp- 1 x 2 Debakey jaw / curved / with ratchet / 25 mm jaw / 13 1/4"



2405-920 Metz VATS Slider Scissors- power cut / curved / 14"



2300-904 VATS Needle Holder- fine / TC serrated / with ratchet / 10 mm shaft / 13"



180-429 Thoracic Suction Tube- straight / 5 mm tube / 17 1/4"





# 13 PIECE DENTAL SCALERS, CURETTES, DEPTH PROBES AND ELEVATORS SET

FINEST QUALITY IN THE INDUSTRY / AGGRESSIVE PRICING

1102-100-SET

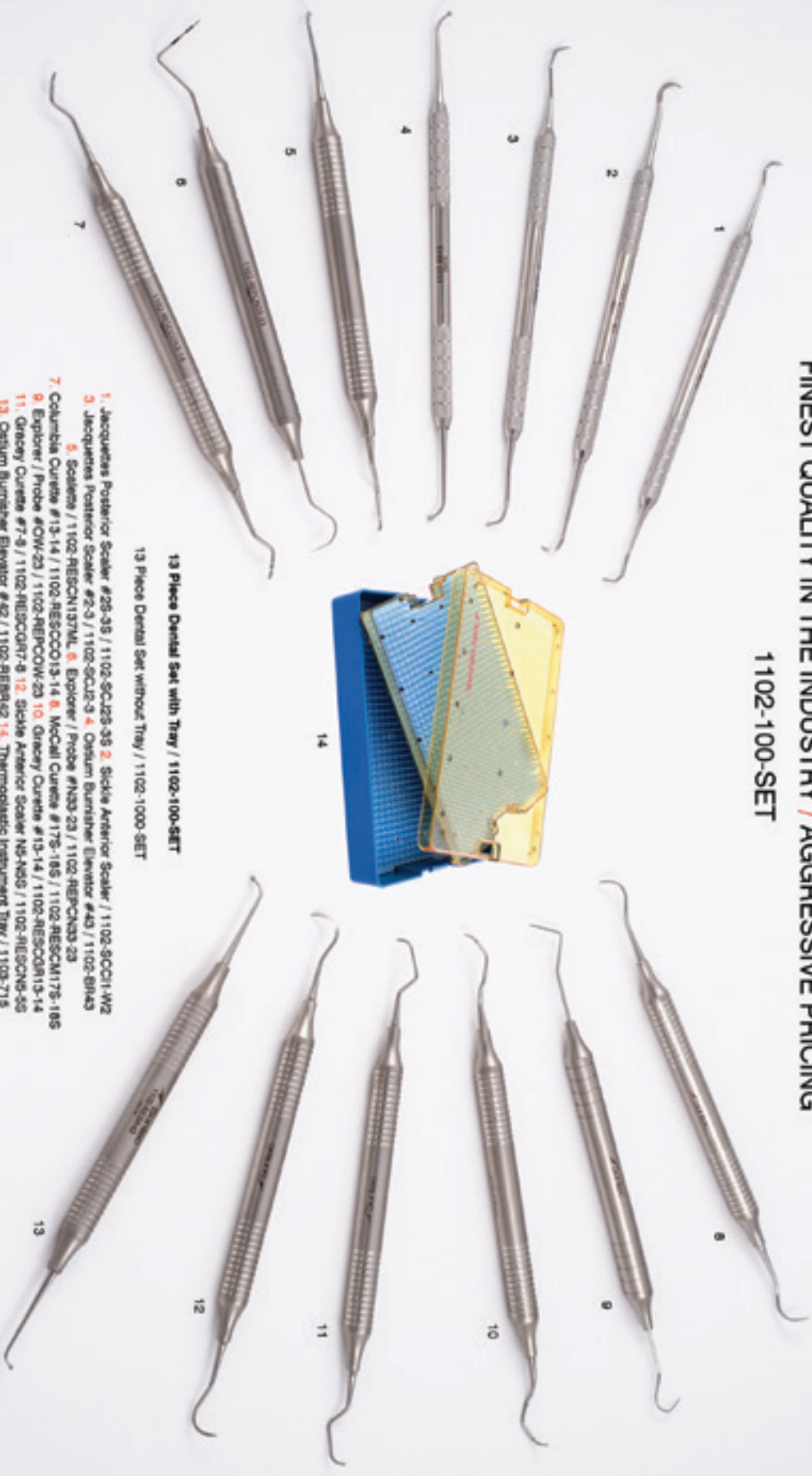

- 1. Jacquettes Posterior Scaler #29-35 / 1102-SC29-35
- 2. Stiehl Anterior Scaler / 1102-SC01-W2
- 3. Jacquettes Posterior Scaler #2-3 / 1102-SC12-3
- 4. Ostium Burnisher Elevator #43 / 1102-BH43
- 5. Scalera / 1102-RESCN137ML
- 6. Explorer / Probe #N3-23 / 1102-HEPCN3-23
- 7. Columbia Curette #13-14 / 1102-RESCCO13-14
- 8. Meccal Cureta #175-185 / 1102-RESCM175-185
- 9. Explorer / Probe #QW-23 / 1102-HEPCQW-23
- 10. Gracey Cureta #13-14 / 1102-RESCGM13-14
- 11. Gracey Cureta #7-8 / 1102-HESCGF-7-8
- 12. Stiehl Anterior Scaler NS-N35 / 1102-RESCNS-55
- 13. Ostium Burnisher Elevator #42 / 1102-REBH42
- 14. Thermoplastic Instrument Tray / 1102-715

13 Piece Dental Set with Tray / 1102-100-SET

13 Piece Dental Set without Tray / 1102-1000-SET

## Sontec Instruments®

A TRADITION OF FINE SURGICAL INSTRUMENTS

[www.Sontecinstruments.com](http://www.Sontecinstruments.com)

Colorado / USA / 800.821.7496



# 10 PIECE DENTAL LUXATOR ELEVATOR SET

FINEST QUALITY IN THE INDUSTRY / AGGRESSIVE PRICING

1100-586-SET



- 1. Luxator Elevator S1 / 1100-586S1
- 2. Luxator Elevator C1 / 1100-586C1
- 3. Luxator Elevator S2 / 1100-586S2
- 4. Luxator Elevator C2 / 1100-586C2
- 5. Luxator Elevator S3 / 1100-586S3
- 6. Luxator Elevator C3 / 1100-586C3
- 7. Luxator Elevator S4 / 1100-586S4
- 8. Luxator Elevator C4 / 1100-586C4
- 9. Luxator Elevator S5 / 1100-586S5
- 10. Luxator Elevator C5 / 1100-586C5
- 11. Thermoplastic Tray / 1102-715

10 Piece Dental Luxator Elevator Set with Tray / 1100-586

10 Piece Dental Luxator Elevator Set without Tray / 1100-5860

## Sontec Instruments®

A TRADITION OF FINE SURGICAL INSTRUMENTS

[www.Sontecinstruments.com](http://www.Sontecinstruments.com)

Colorado / USA / 800.821.7496



# 9 PIECE DENTAL WINGGED ELEVATOR SET

FINEST QUALITY IN THE INDUSTRY / AGGRESSIVE PRICING

1103-3891-SET



- 1. Root Tip Elevator 1.0 / 1103-1.0S
- 2. Root Tip Elevator 2.0 / 1103-2.0S
- 3. Winged Elevator / 1103-3891A
- 4. Winged Elevator / 1103-389B
- 5. Winged Elevator 34S / 1103-389C
- 6. Winged Elevator E40 / 1103-389D
- 7. Winged Elevator E51 / 1103-389E
- 8. Winged Elevator E50 / 1103-389F
- 9. Winged Elevator E50 / 1103-389G
- 10. Thermoplastic Tray / 1103-715



9 Piece Dental Winged Elevator Set with Tray / 1103-3891-SET

9 Piece Dental Winged Elevator Set without Tray / 1103-3890-SET

**Sontec Instruments®**

A TRADITION OF FINE SURGICAL INSTRUMENTS

[www.Sontecinstruments.com](http://www.Sontecinstruments.com)

Colorado / USA / 800.821.7498



# CLASSIC DENTAL ELEVATOR SET

FINEST QUALITY IN THE INDUSTRY / AGGRESSIVE PRICING

1103-399-SET



Classic Dental Elevator Set with Tray / 1103-399-SET

Classic Dental Elevator Set without Tray / 1103-3990-SET

- 1. Elevator 34 / 1103-391
- 2. Elevator 46 / 1103-396
- 3. Elevator / 1103-39225
- 4. Elevator / 1103-3922B
- 5. Elevator 34S / 1103-391S
- 6. Elevator E40 / 1103-394
- 7. Elevator E51 / 1103-392
- 8. Elevator E50 / 1103-395
- 9. Thermoplastic Tray / 1103-715



**Sontec Instruments®**

A TRADITION OF FINE SURGICAL INSTRUMENTS

[www.Sontecinstruments.com](http://www.Sontecinstruments.com)

Colorado / USA / 800.821.7498



# THE ORIGINAL GOLD STANDARD

FOR MIS FOR OVER 20 YEARS

FINEST QUALITY IN THE INDUSTRY / AGGRESSIVE PRICING



### Special

- Tungsten scissors
  - Tungsten DeBakey
  - Increased life
  - Dual purpose
- 510K Registered
  - Largest selection of working ends on the market
  - 3 sizes of shafts for a variety of procedures
  - Unique handle coloring
  - Gold for TC items
  - Black/Red for forceps & scissors

**Sontec Instruments®**

A TRADITION OF FINE SURGICAL INSTRUMENTS

[www.Sontecinstruments.com](http://www.Sontecinstruments.com)

Colorado / USA / 800.821.7486



# BAYONNET HEARTLINE M.I.S. COMPLETE SET

FINEST QUALITY IN THE INDUSTRY / AGGRESSIVE PRICING



- Micro Vascular Needle Holders
- DeBakey TC Forceps
- Metznerbaum Blades
- Potts Blades
- Jamesson Blades
- Knot Pusher
- Dissecting Forceps
- 360° Rotatable Shafts
- Tapered Shafts



**Sontec Instruments®**

A TRADITION OF FINE SURGICAL INSTRUMENTS

Colorado / USA / 800.821.7486

[www.Sontecinstruments.com](http://www.Sontecinstruments.com)

**FOR THE PROCEDURE**  
FINEST QUALITY IN THE INDUSTRY / AGGRESSIVE PRICING



**Sontec Instruments®**

A TRADITION OF FINE SURGICAL INSTRUMENTS

Colorado / USA / 800.821.7496

www.SontecInstruments.com

# PLASTILOGICAL INSTRUMENTATION

FINEST QUALITY IN THE INDUSTRY / AGGRESSIVE PRICING

1. Cottle Crusher 350-849
2. Gillies 132-984C
3. Davis 412-767
4. Sontec 3mm 1100-479M
5. Lacrimai Probe 16-2510
6. Westcott 13-3906
7. Deemures 10-4220
8. Kahn Face Lift Scissors 475-175



9. Eye Shield 1100-409M
10. Eye Shield Pair 18-8020
11. 2 mm 40° Kerrison 404-491
12. Deemures Electro Blue 14-9908
13. Bipolar Suction Forceps 2700-817
14. Joseph 16-2210
15. 0.5 Castroviejo 14-2820
16. Coble 6 mm 350-849C

17. Puttermann 714-9400
18. Jeweleo 14-8840
19. Mini Neuro 1100-086
20. Silicon Eye Spheres 1100-411-23
21. Joseph Hook Electro Blue 199-432
22. Stevens 1200-497
23. Sphera Introducer 17-1000
24. Castroviejo 15-1910

**Sontec Instruments®**

A TRADITION OF FINE SURGICAL INSTRUMENTS

Colorado / USA / 800.821.7496

www.SontecInstruments.com



# SONTEC INSTRUMENTATION OF EXPERTS

FINEST QUALITY IN THE INDUSTRY / AGGRESSIVE PRICING

1. Martez Dissector - 11-3420
2. Lasic Flap Spatula - 12-2860
3. Kelly Marmarae Punch 1.0 mm - 11-9270
4. 0.12 Collet with Angled Teeth - 14-2820
5. Fine Stitch Scissors - 13-4800
6. Marshall 0.3 mm Forceps - T14-3000
7. Serrine Clamp - 14-9240
8. Desmarres Lid Retractor - 10-4200
9. Maslet Capulathexis Forceps - 14-8384
10. Rizzuti Iris Retractor and Lens Expresor 2 mm - 12-4800
11. Castroviejo TC Needle Holder - 15-1910
12. Bishop Harmon Forceps 0.5 mm - T14-3805
13. Silicone Eye Sphere
14. Fomon Enucleation Scissors - 508-822
15. Micro Interocular Biopsy Forceps - 14-7751
16. 7° Ceramic TC/PC Metzenbaum Scissors - 1200-915
17. Full Curved Iris Forceps 1 x 2.0 mm - 14-4655
18. Singer Capsule Squee/Pelsher - T12-2800
19. Gemard Fusion 1 x 2 Forceps 0.5 mm - 14-3200E
20. Cook Speculum Medium - 10-1402
21. Grade Scissors - 190-550
22. Seven Clamp Medium - 14-9907
23. Eye Shield Plastic - 1100-429M
24. Suction Cup (for above lens) - 18-8028
25. Tissue Forceps Bipolar Nonstick - 2700-884NS



Sontec Instruments®

A TRADITION OF FINE SURGICAL INSTRUMENTS

www.SontecInstruments.com

Colorado / USA / 800.821.7486



# SONTEC LAPAROSCOPIC BIPOLAR

FINEST QUALITY IN THE INDUSTRY / AGGRESSIVE PRICING

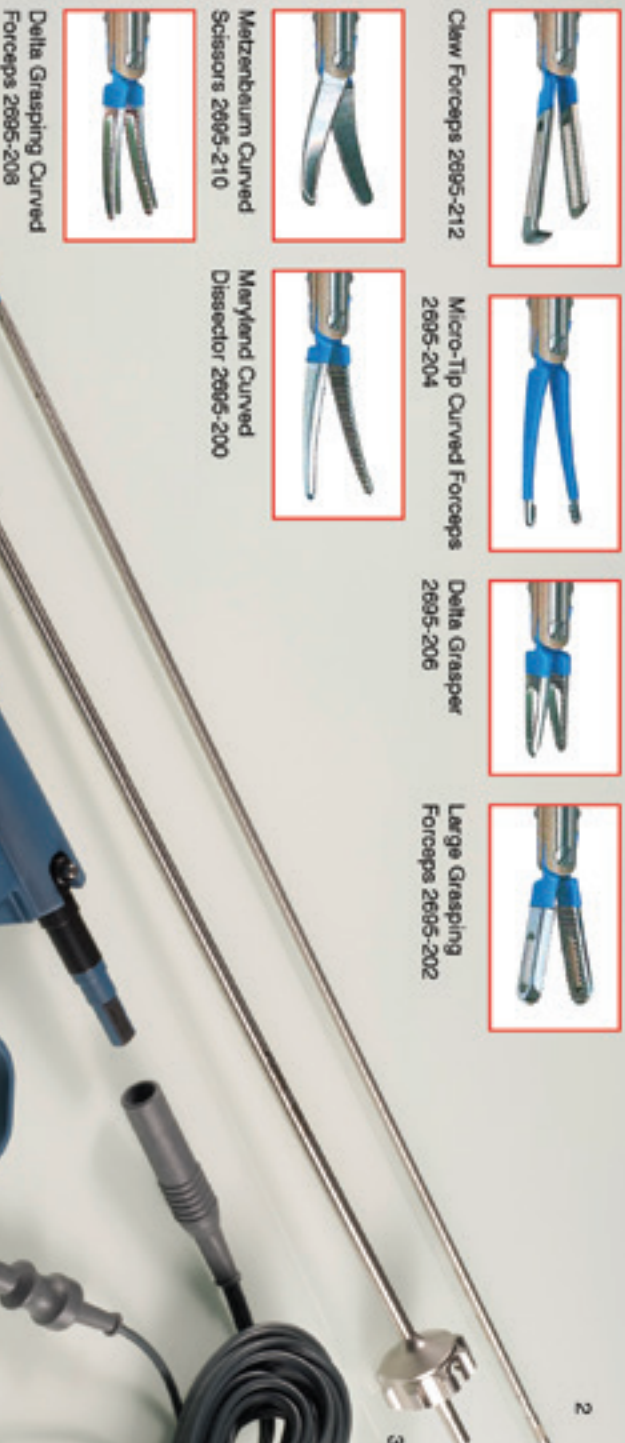

Claw Forceps 2695-212

Micro-Tip Curved Forceps 2695-204

Delta Grasper 2695-206

Large Grasping Forceps 2695-202

Metzenbaum Curved Scissors 2695-210

Maryland Curved Dissector 2695-200

Delta Grasping Curved Forceps 2695-208



## BIPOLAR POWER GRIP & BIPOLAR POWER CUT

### COAGULATION INSTRUMENTATION

Universal and rotatable handpiece offers a variety of tip options sold individually or as a set

1. Universal Handle Rotatable 360° / 2695-150
2. Maryland Curved Dissector / 2695-200
3. Obstructor Outer Shaft / 2695-110
4. 5 m Bipolar Cord Banana Plug / 2695-100

Sontec Instruments®

A TRADITION OF FINE SURGICAL INSTRUMENTS

www.SontecInstruments.com

Colorado / USA / 800.821.7486

# NECESSARY SELECTIONS

FINEST QUALITY IN THE INDUSTRY / AGGRESSIVE PRICING



- 1 Westcott with wide grip - 13-3301
- 2 0.5 Bishop Harmon - T14-3805
- 3 Ceramic Stevens - 1200-690
- 4 Jewelers #4 - 2200-0014
- 5 Barraquer - T10-1000
- 6 Barraquer - T10-1005
- 7 Colibri 0.12 fluted handle - 14-5395
- 8 Castroviejo speculum - 10-1700C
- 9 Dert TC - 132-354
- 10 2.5 mm Burr - 11-4612
- 11 Easy Change Handle - 16-3100
- 12 0.5 Binkhorst - 16-3107B
- 13 Strabismus Power Cut - 1200-023
- 14 Manhester 0.3 - T14-3060

Sontec Instruments®

A TRADITION OF FINE SURGICAL INSTRUMENTS

Colorado / USA / 800.621.7486

www.SontecInstruments.com

# SONTEC EXPERTS OF INSTRUMENTATION

FINEST QUALITY IN THE INDUSTRY / AGGRESSIVE PRICING



- 1 Verges Pizzo Chopper - 12-1407
- 2 Stevens Ergonomical Scissors - 1200-708
- 3 Castroviejo Colibri - 14-2200
- 4 Pigtail Probe with Hook - 16-2600
- 5 Easy Change Pizzo I/A Cannula System - 16-3100
- 6 0.5 mm 90° Pizzo Tip - 16-3103D
- 7 Plastic Eye Shield - 1100-429L
- 8 Thopce Caliper - 12-8400
- 9 Eye Shield Set - 18-8028
- 10 Serrafe - 14-8985
- 11 Castroviejo Retractor - 10-1701C
- 12 Trautman Scissors - 13-1510
- 13 Silcock Eye Spheres
- 14 Gill Weasas Scissors - 13-5415
- 15 Barraquer Speculum - T10-1010
- 16 Tennant Forceps - 1200-072
- 17 Micro Alligator - 14-9570
- 18 Sheppard Lens Forceps - T14-8940
- 19 Wilder Lens Loop - 12-4402
- 20 20 Gauge Vitreotomy Scissors - 13-6000
- 21 Grife Fixation Forceps - 14-5122
- 22 Rosh Strich Scissors - 13-4025
- 23 Jewelers Dipolar Nonack - 2700-824
- 24 Ana Needle Holder - 15-3830
- 25 Jable Forceps - T14-8900

Sontec Instruments®

A TRADITION OF FINE SURGICAL INSTRUMENTS

Colorado / USA / 800.621.7486

www.SontecInstruments.com

# PEAPOODS BY SONNTEC

FINEST QUALITY IN THE INDUSTRY / AGGRESSIVE PRICING

Select from a variety of jaw sizes, angles and shaft lengths. Peapods offer the perfect jaw design for tight small and hard to navigate joint areas!



Sontec Instruments®

A TRADITION OF FINE SURGICAL INSTRUMENTS

Colorado / USA / 800.821.7486

www.SontecInstruments.com

# TAKAHASHI RONGEURS

FINEST QUALITY IN THE INDUSTRY / AGGRESSIVE PRICING



Select from a variety of jaw sizes, angles and shaft lengths. Peapods offer the perfect jaw design for tight small and hard to navigate joint areas!

Sontec Instruments®

A TRADITION OF FINE SURGICAL INSTRUMENTS

Colorado / USA / 800.821.7486

www.SontecInstruments.com

**SONTEC MINIMAL INVASIVE SURGICAL INSTRUMENTATION**  
FINEST QUALITY IN THE INDUSTRY / AGGRESSIVE PRICING



1. Hook Scissors 4.5 mm / 1271-470
2. Kerrison Endoscopic / 404-6025E
3. Wedgegrasper Jr. 2.7 mm / 1273-171
4. Cannula with Stopcock 3.2 mm / SC99-0315
5. Biopsy Grasper with Ratchet / 1271-020H
6. MIS Micro 20 Gauge Scissors / 13-6630
7. Micro Scissors Large Gauge / 13-5710
8. Micro Neuro Bayonet Scissors / 2900-016

**DID YOU KNOW?**

Sontec specializes in MIS instruments including but not limited to: Laparoscopic, Thoracoscopic, Microdissection, Endoscopic Neuro/Brain Surgery, Arthroscopy, Vitrectomy and Intraocular instrumentation designed for the future of surgery.

**Sontec Instruments®**

A TRADITION OF FINE SURGICAL INSTRUMENTS

Colorado / USA / 800.821.7496

www.Sontecinstruments.com

9. MIS Scissors 15° Axial / 2800-230
10. MIS Cannula Trocar / 20007-17
11. Atraumatic Forceps 3 mm / 2901-201
12. Axial Handle with Spring and Ratchet / 2901-076
13. Atraumatic Forceps 5 mm / 2901-245S
14. Axial Ring Handle / 2901-076
15. Dissecting Forceps without Ratchet / 2100-933

**EXTRADURAL ANTERIOR CLINOIDECTOMY SET**  
FINEST QUALITY IN THE INDUSTRY / AGGRESSIVE PRICING

The anterior clinoidectomy is a very important maneuver for the management of anterior skull base lesions, tumors and vascular. Introduced by Hakuba in 1982 and Dolenc in 1983 this technique can be done using drilling and/or using a combination of special instruments for safe bone resection, and can be performed intradural, extradural or combined. The Sontec's Set for Anterior Clinoidectomy provide the proper tools for a safe extradural anterior clinoidectomy.



In collaboration with Jorge Mura, MD, FACS, IFMAANS, Chief of Cervicocranial and Skull Base Surgery, Institute of Neurosurgery Asierio, Department of Neurological Surgery, Clinica Las Condes, Assistant Professor of Neurological Surgery, University of Chile.



1. Mini Neuro Premier Rongeur - 1106-091
2. Jeuris Lempert Neuro Rongeur - 1100-578
3. Levesque Neuro Rongeur - 1100-576A
4. Kerrison Universal Rotating 360° Rongeur - 404-606
5. Shaft: 3 mm Bite 40° - 404-606S
6. Kerrison Universal Rotating 360° Rongeur - 404-606
7. Shaft: 1 mm Bite 40° - 404-6061

**Sontec Instruments®**

A TRADITION OF FINE SURGICAL INSTRUMENTS

Colorado / USA / 800.821.7496

www.Sontecinstruments.com



# CeramiTec

FINEST QUALITY IN THE INDUSTRY / AGGRESSIVE PRICING



- 1 7 1/4" Jacobson Micro Needle Holder Straight / 2300-1948
- 2 7" Jacobson Micro Scissors 60° Micro 14mm Blades / 2400-693C
- 3 8" Kerrison Ringeur 40° Thin Fod. Palla Term / 404-4008B
- 4 8" Kerrison Ringeur 40° 2.0mm / 404-402B
- 5 4 1/2" TC/PC Ceramic Stevensen Tenotomy Curved / 1200-697
- 6 5 1/2" TC/PC Ceramic Metzenbaum Spread Handle Curved / 1100-1060

**Sontec Instruments®**

A TRADITION OF FINE SURGICAL INSTRUMENTS

Colorado / USA / 800.821.7498

www.Sontecinstruments.com

- 7 PC Ceramic Strabismus Spread / 1200-699
- 8 5 1/2" TC/PC Ceramic Knowles Angled / 1200-989
- 9 7" PC Ceramic Metzenbaum Curved / 1200-918
- 10 4 1/2" TC/PC Ceramic His Scissors Curved / 2700-310
- 11 7" TC/PC Ceramic Metzenbaum Spread / 1200-9192
- 12 6 3/4" TC/PC Ceramic Mayo Curved / 1200-986



# CeramiTec

FINEST QUALITY IN THE INDUSTRY / AGGRESSIVE PRICING

Sontec's **CeramiTec** line of unique instrumentation is identified at first glance by its bold jet black surface with bright gold lettering for easy recognition and recording. **CeramiTec** is designed to reduce friction which prolongs the sharpness of a scissors' blades. Please visit [Sontecinstruments.com](http://Sontecinstruments.com) to view all **CeramiTec** products. You may also request a printed catalog.



- 1 Bandage Scissors / 1200-680
- 2 Metzenbaum / 1200-915 3 Freeman / 1200-970
- 4 Dissector 45° / 413-003 5 Micro Hook / 413-010
- 6 5 mm Hook 90° / 413-017 7 7 mm Probe 45° / 413-018
- 8 Curved Dissecting Spatula / 413-004 9 Baby Metzenbaum / 1200-922
- 10 His Scissors / 1200-950 11 Metzenbaum 5 3/4" / 1200-911 12 Stevens 4 1/2" / 1200-930
- 13 Jabaley / 1200-640 14 Baby Metzenbaum Spread Handle / 1200-898 15 Stevens 4 1/4" / 1200-929
- 16 Westcott / 13-3004B 17 Stevens Spread Handle / 1200-905 18 Jacobson / 2400-603B

**Sontec Instruments®**

A TRADITION OF FINE SURGICAL INSTRUMENTS

Colorado / USA / 800.821.7498

www.Sontecinstruments.com

# BALANCING INSTRUMENTATION

FINEST QUALITY IN THE INDUSTRY / AGGRESSIVE PRICING



Small Animal  
Equine  
Minimal Invasive Surgery  
Arthroscopy  
Ophthalmology  
Joint Surgery  
and on and on...

1. Micro 1x2 Tying Forceps / 14-2830
2. Dual Purpose Delicate Tissue Forceps / 2200-079
3. NEW Micro Fracture Pick / 1271-317
4. Micro Level Osteotome / 200-792M
5. NEW MS 300° Micro Grasper / 2900-013
6. NEW Orhal Gelpi Retractor Right / 1100-6293
7. NEW Orhal Gelpi Retractor Left / 1100-6292
8. Equine Eye Speculum / 10-1704
9. Eye Speculum / 10-1702
10. NEW Ceramic Matzenbaum Scissors / 1200-9192
11. NEW Ceramic Micro Tons Scissors / 1200-927
12. Deluxe Extra Large Needle Holder / 1100-1100
13. Deluxe Micro Needle Holder / 132-982

Sontec Instruments®

A TRADITION OF FINE SURGICAL INSTRUMENTS

www.Sontecinstruments.com

Colorado / USA / 800.821.7498

# SONTEC SURGICAL ARMAMENTARIUM

FINEST QUALITY IN THE INDUSTRY / AGGRESSIVE PRICING



Offering more than  
12,000 individual  
instruments covering  
the entire human  
anatomy including  
instruments  
specifically designed  
for veterinary  
medicine.

1. Classic Neuro Forceps / 315-544
2. 1x2 Ophthalmic Forceps (select tooth size) / T14-0820
3. Velocaptor Jr. Arthroscopic Forceps / 1273-171
4. Bipolar Non-stick Bayonet Forceps / 2700-825N5
5. Dooden Bone Clamp / 1103-848R 6. Deluxe-Sontec OlsenHejper / 1100-1060
7. Eye Wire Barraquer Speculum / T10-1010 8. 1mm Wire Cutter Angled Jaws / 1103-115
9. Baby Poodle Suction / 180-420 10. Unique Freer Suction Elevator / 2700-310
11. Cheekzation Clamp / 14-9201 12. 6r Biopsy Cup Forceps / 469-054 13. Bone Rasp Miller / 1100-490
14. Sontec Ostiome (select mm size or order set) / 330-804M 15. Ceramic Cut Westcott Scissors / 13-3294B
16. 8 French Fractur Suction / 412-692 17. Micro Needle Holder TC / 18-3990

Sontec Instruments®

A TRADITION OF FINE SURGICAL INSTRUMENTS

www.Sontecinstruments.com

Colorado / USA / 800.821.7498



# SMALL ANIMAL ARTHROSCOPY SET

FINEST QUALITY IN THE INDUSTRY / AGGRESSIVE PRICING



1. Micro Cut Through Forceps / 1271-007
2. Micro Grasping Straight / 1271-006
3. Micro Grasping Forceps / 1271-009R (available without ratchet)
4. Bipolar Cup Forceps / 1273-171
5. Egress Cannula / SC95-0315
6. Pull Knife / 1271-127T
7. Micro Hook / 400-448
8. Micro Hook / 412-445ALT
9. Micro Hook / 412-445ALT
10. Push Knife / 1271-138

**Sontec Instruments**

A TRADITION OF FINE SURGICAL INSTRUMENTS

Colorado / USA / 800.821.7496

www.Sontecinstruments.com



# SONTEC ELECTRIFIED BIPOLAR

FINEST QUALITY IN THE INDUSTRY / AGGRESSIVE PRICING

Creating non-stick ceramic & silver electro cauterly instrumentation



**CERAMIC**  
Layered blades provide an incredible smooth cut.



**FORCEPS**  
all shown are available in a variety of lengths, tip sizes and angles. Choose wide or classic grip.



1. Bayonet Wide Grip Forceps - 2700-852NS
2. Bayonet Wide Grip with Suction - 2700-817
3. Bayonet Wide Grip Forceps - 2700-807NS
4. Bipolar Non-Stick Frazer Suction - 2700-552NS
5. Adson 5-Hole Forceps - 2700-908NS
6. Metzenbaum Scissors 2700-5331
7. Cushing Trause Forceps - 2700-904NS
8. Metzenbaum Scissors 2700-5371
9. Metzenbaum Scissors 2700-5431
10. Jensen Bayonet Classic Grip Forceps 2700-891NS
11. Metzenbaum Scissors 2700-5431
12. Bayonet Wide Grip Forceps 2700-844NS

**NEW** **WIDE GRIP HANDLE**  
offers yet another option to surgeons by providing more handle space to articulate the non-stick silver tips

**Sontec Instruments**

A TRADITION OF FINE SURGICAL INSTRUMENTS

Colorado / USA / 800.821.7496

**EUROPEAN PLUG**  
connections available upon special order

www.Sontecinstruments.com



# UNIVERSAL KLICK KERRISON SET

FINEST QUALITY IN THE INDUSTRY / AGGRESSIVE PRICING

- 360° 8-point rotation
- Built in ejector pin on all shaft designs



1. 5 mm 40° 404-6085
2. 3 mm 40° 404-6083
3. 2 mm 90° 404-6072
4. 1 mm 40° 404-6081
5. Endoscopic Shaft 2.5 mm 40° 404-6082SE
6. Bealy Foamotomy
7. Bealy Foamotomy  
Curved Down 2 mm 40° 404-6082C
8. Universal Klick Kerrison Handle 404-606
9. Bealy Foamotomy  
Curved Up 3 mm 40° 404-6083B
10. Endoscopic Shaft 3 mm 40° 12 1/2° 404-6088E
11. Endoscopic Shaft 3 mm 40° 404-6083EB
12. Bayonet Shaft 3 mm 40° 16° 404-6083B

**Sontec Instruments**

Colorado / USA / 800.821.7486

A TRADITION OF FINE SURGICAL INSTRUMENTS

[www.SontecInstruments.com](http://www.SontecInstruments.com)



# NEUROSURGICAL INNOVATION

BY THE LEADER IN INSTRUMENTATION / FINEST QUALITY IN THE INDUSTRY / AGGRESSIVE PRICING



1. Decker Rongeur 469-057
2. Sontec Tapered S-Retractor 207-417
3. Micro Axial Bayonet Scissors 2900-022
4. 3 mm Tumor Grasping Forceps 400-075
5. Jacob Bayonet Needle Holder  
TC Round Handle Curved Jaws 400-229
6. Bayonet Foreminotomy Kerrison 404-468
7. Micro Axial New Large Gauge Handle **Needle Holder** 2900-004
8. Suction Monopolar Silver Non-Slick 2700-554NS

9. Neuro Jacobson Scissors 2400-6500
10. Dissector 412-550T
11. Axial Curette 320-886D
12. Dissecting Suction Elevator 478-360
13. Dissecting Suction Elevator 2700-310
14. Brain Spatula 2 mm 412-779
15. Elevator with Suction 478-375
16. Dissector Curette 412-547T
17. Dissector Wax Packer 412-549

**Sontec Instruments**

Colorado / USA / 800.821.7486

A TRADITION OF FINE SURGICAL INSTRUMENTS

[www.SontecInstruments.com](http://www.SontecInstruments.com)



# GET A VASCULAR GRIP

FINEST QUALITY IN THE INDUSTRY / AGGRESSIVE PRICING



 Sontec Instruments®

A TRADITION OF FINE SURGICAL INSTRUMENTS

Colorado / USA / 800.821.7496

[www.Sontecinstruments.com](http://www.Sontecinstruments.com)



# CASALE SONTEC RING RETRACTOR

FINEST QUALITY IN THE INDUSTRY / AGGRESSIVE PRICING

- Malleable Blades
- Kelly Blades
- Abdominal Blades
- Cushing Blades
- Tilting Locks
- Rigid Locks
- Oval Ring

\* Inquire with your local representative for pricing and to view samples



 Sontec Instruments®

A TRADITION OF FINE SURGICAL INSTRUMENTS

Colorado / USA / 800.821.7496

[www.Sontecinstruments.com](http://www.Sontecinstruments.com)

HERCULES  
AND THE  
POWER OF  
THE GREEK  
GOD'S CAN  
BE IN YOUR  
HANDS



1. Wire Cutter  
9" - 355-189 / 11" - 355-191
2. TC Blades Replacement Set  
9" - 355-190 / 11" - 355-192
3. Rubber Jaws Replacement Set  
9" - 355-193 / 11" - 355-193

**Sontec Instruments**

A TRADITION OF FINE SURGICAL INSTRUMENTS



AUTHORIZED DEALER  
OF LIGHTS & LOUPES

Colorado / USA / 800.821.7496

www.SontecInstruments.com

# ELITE WIRELESS LED HEADLIGHT

FINEST QUALITY IN THE INDUSTRY / AGGRESSIVE PRICING



Wrap around rear  
cranial support on  
headband for added  
comfort. Removable  
if needed

Rheostat control  
0-30,000 Lux  
at 16"/40 cm  
working distance

Easy change battery  
fixture holds one  
battery while the  
backup is charging



Removable / sterilizable  
lever to safely adjust  
beam direction

Battery indicator /  
Low battery indicator

Sold with 2 batteries, each with  
4 hours of power at 100% output  
and a lightweight carrying case

Designed to remove shadows  
in complex surgical operations

- Cardiovascular
- Orthopedic
- Spinal
- Abdominal

Rheostat for spot  
variability 20-110 mm  
at 16"/40 cm working  
distance

Ideal color  
temperature  
at 4,500° K

**Sontec Instruments**

A TRADITION OF FINE SURGICAL INSTRUMENTS

Colorado / USA / 800.821.7496

www.SontecInstruments.com

**Product update: HEINE® LoupeLight 2**

With HEINE HR or HRP Binocular Loupes for a perfect view.

The combination of light and loupe delivers the ultimate in performance as high quality illumination with LEDHQ maximises the image quality of the loupe.

For a perfect view and a precise diagnosis, the LoupeLight 2 is now 25% brighter than its predecessor model, with a homogeneous edge-to-edge illumination of typ. 55,000 lux.

For intensive use, the LoupeLight 2 now features a replaceable connecting cord which connects the device to the mPack mini – the new and compact power source for the LoupeLight 2 (product description see overleaf).

**NEW!**  
 ✓ Now 25% brighter due to improved LED technology  
 ✓ Replaceable connecting cord



Replaceable connecting cord with high-quality splashproof threaded connector for heavy duty use.

Now even 25% brighter

**LEDHQ**  
 LED NOW IN HEINE QUALITY.



HR 2.5x High Resolution Binocular Loupes. Achromatic optics for crisp, bright images.

**HEINE® MicroLight 2**

Ultralight, universal headlight.

For those who need a compact, lightweight illumination solution without magnification, we offer the MicroLight 2. Featuring LEDHQ illumination for homogeneous illumination with true and natural colour rendering for every examination situation. Two mounting options offer individuality and easy handling. Illumination without compromises, in a lightweight design.



HEINE MicroLight 2 on S-FRAME



HEINE MicroLight 2 on Lightweight Headband

See overleaf for ordering information.



**HEINE® mPack mini** – The compact and light power source for LoupeLight 2 and MicroLight 2.

The new, high performance power source HEINE mPack mini for LoupeLight 2 and MicroLight 2 offers freedom from cables that tie the users to desk, wall or static power sources. With a weight of just 95g and dimensions of 44 x 23 x 101 mm, this mobile power source is now approximately approx. 70% smaller and lighter than its predecessor.

The pouch, which is included in the delivery, can be attached to the belt. The mPack mini can also be charged whilst in the pouch. Thanks to the LI-ion battery technology the power source has an operating time of typ. 9 hours, in continuous operation at maximum power typ. 4 hours. The mPack mini is flexible in charging due to its USB connector. Charge it via laptop, desktop or USB charger.

**NEW!**  
 ✓ 70% smaller and lighter  
 ✓ Operating time typ. 9 hours  
 ✓ Charging time typ. 4 hours



USB charging option



Size comparison of HEINE mPack LL/mPack mini

LoupeLight 2 Sets with HR Binocular Loupes	
HR 2.5x optics with i-View on S-FRAME, LoupeLight 2, detachable yellow filter, mPack mini, mPack mini Belt Clip, E4-USB plug-in transformer, protective lenses, 2 sterilisable levers, retaining cord, cleaning fluid, cleaning cloth, carrying case	
340mm working distance	C-008.32.450
420mm working distance	C-008.32.451
520mm working distance	C-008.32.452
MicroLight 2 Sets	
MicroLight 2 on S-FRAME with mPack mini, mPack mini Belt Clip, E4-USB plug-in transformer, retaining cord and cleaning fluid in case	J-008.31.276
MicroLight 2 on Lightweight Headband with mPack mini, mPack mini Belt Clip, E4-USB plug-in transformer, case	J-008.31.277
Single Devices	
LoupeLight 2 for HR/HRP Loupes with i-View loupe mount	C-008.32.226
mPack mini with LI-ion rechargeable battery and E4-USB plug-in transformer	X-007.99.650
mPack mini with LI-ion rechargeable battery, without E4-USB plug-in transformer	X-007.99.649
Connecting cord SC1 (1.6m) for LoupeLight 2 or MicroLight 2/mPack mini	C-000.32.240

For further ordering information please contact your HEINE distributor **Sontec Instruments**

**Sontec Instruments**  
 7248 S. Tucson Way  
 Centennial, CO 80112  
 USA Headquarters  
 Heine USA



AUTHORIZED DEALER

**HEINE Optotechnik GmbH & Co. KG**, Kientalstr. 7, 82211 Herrsching, Germany  
 Tel. +49 (0) 8152/38-0, Fax +49 (0) 8152/38-202, E-Mail: info@heine.com, www.heine.com



A-090300218 • 04/17  
 We reserve the right to change specifications without notice.  
 © 2018 HEINE Optotechnik GmbH & Co. KG. All rights reserved.

## Index

T10-1000	86	10-4230	90	12-9450	39
T10-1000C	86	10-4231	91	13-1300	124
T10-1005	86	10-4233	90	13-1306	124
T10-1010	86	10-4236	90	13-1307	124
#00 Jewelers aka Cilia & Suture Removal		10-4240	90	13-1310	124
Forceps	106	10-4241	91	13-1320	124
9-5201 . 48		10-4245	91	T13-1320	124
9-5203 . 48		10-4246	91	13-1330	124
9-12015-BH	48	T10-4255	91	T13-1330	124
9-12019-BH	48	10-4269	90	13-1340	124
10-1000	86	10-4270	90	13-1350	124
10-1000C	86	10-4520	85	13-1840	126
10-1000C-13	86	10-4521	85	13-1842	126
10-1005	86	10-4522	85	13-2500	126
10-1005C	86	10-4525	85	13-2500F	126
10-1007	86	10-4530	85	13-2520	126
10-1010	86	10-4535	85	13-2520F	126
10-1010C	86	10-4540	85	13-2540	126
10-1010C-08	86	10-5500	58	13-3140	126
10-1015	87	11-3420	95	13-3150	126
10-1016	87	11-4560	95	13-3160	126
10-1020	88	11-4600	95	13-3162	126
T10-1020	88	11-4601	95	13-3301	127
10-1030	88	11-4609	95	13-3303	125
T10-1030	88	11-4610	95	13-3304	125
10-1370	84	11-4611	95	13-3306	127
10-1500	89	11-4612	95	13-3307	127
10-1510	89	11-4613	95	13-3307S	127
10-1704	88	11-4614	95	13-3311	125
10-3100-SET	102	11-4615	95	T13-3417	125
10-3140	102	11-4616	95	T13-3418	125
10-3150	102	11-4617	95	13-3420	124
10-3160	102	11-4618	95	13-3425	124
10-3170	102	11-9350	94	13-3430	124
10-3180	102	12-1285	446	13-3435	124
10-3190	102	12-1290	446	13-3460	124
10-3200	102	12-1300	446	13-4300	125
10-3210	102	12-1310	446	13-4400	127
10-3220	102	12-1320	446	13-4402	127
10-3310	102	12-1355	446	13-5600	97
10-3312	102	12-1360	446	13-5605	97
10-3314	102	12-1365	446	13-5610	97
10-3890	85	12-1367	446	13-5615	97
10-4192	90	12-1368	446	13-5700	97
10-4194	90	T12-4330	94	13-5701	97
10-4196	90	12-4500	94	13-5710	97
10-4198	90	12-4600	94	13-5710B	97
T10-4198	91	12-4601	94	13-5711	97
10-4200	90	12-4602	94	13-6800	305
10-4201	90	12-4604	94	13-6810	305
10-4206	90	12-4608	94	13-6815	305
10-4207	90	12-4610	94	13-7500	120
10-4210	90	12-4750	94	13-7510	120
10-4211	91	12-4800	84	13-7520	120
10-4213	90	12-9300	38	13-7522	120
10-4216	90	T12-9300	38	13-7524	120
10-4218	90	12-9305	38	13-7526	120
10-4220	90	12-9310	38	13-7528	120
10-4221	91	12-9315	38	13-7530	120
10-4223	90	12-9316	38	13-7532	120
10-4226	90	12-9318	38	13-7533	120
10-4227	90	12-9400	39	13-7550	118

13-7560	118	14-3074	113	14-6831	106
13-7720	120	T14-3074	113	14-6840	106
13-7730	120	14-3075	113	T14-6840	106
13-7786	119	T14-3075	113	14-6850	106
13-8325	267	14-3077	113	T14-6850	106
13-8805	117	T14-3077	113	T14-6860	106
13-8815	117	14-3150	109	14-6870	106
13-8820	117	14-3152	109	14-7750	97
13-8825	117	14-3154	109	14-7751	97
13-8865	117	14-3240	109	14-9893	112
13-8866	117	14-3245	109	14-9894	112
13-9334	300	14-3246	109	14-9895	112
13-9335	300	14-3247	109	14-9900	112
13-9340	118	14-3248	109	14-9901	112
13-9341	118	14-3260A	109	14-9902	112
13-9800	301	14-3260B	109	14-9906	112
13-9805	96, 123	14-3260C	109	T14-9906	112
13-9810	96, 123	14-3260D	109	14-9907	112
13-9820	96, 123	14-3800	108	T14-9907	112
13-9822	96, 123	T14-3803	108	14-9908	112
T14-1819	107	14-3805	108	T14-9908	112
14-1820	107	T14-3805	108	14-9935	74
T14-1820	107	14-3810	108	14-9940	74
14-1845	107	T14-3810	108	14-9990	226
T14-1845	107	14-3900	107	T14-9990	226
T14-1845W	107	T14-3900	107	14-9992	226
14-1847	107	14-3910	107	15-0230	152
T14-1847	107	T14-3910	107	15-0231	152
14-1850	107	T14-3920	107	15-0232	152
T14-1850	107	14-4600	109, 113	15-0233	152
14-1851	107	14-4620	109, 113	15-1900	325
T14-1851	107	14-4625	109	15-1901	325
T14-1852	107	14-4800	113	15-1910	325
14-2220	108	14-5120	111	15-1911	325
T14-2220	108	14-5122	111	15-1912	325
14-2630	113	14-5130	111	T15-1912	325
14-2800	108	14-5200	111	15-1913	325
T14-2800	108	T14-5200	111	T15-1913	325
14-2805	108	14-5205	111	15-1914	325
T14-2805	108	14-5215	111	T15-1914	325
14-2810	108	14-5220	111	15-1915	325
T14-2810	108	T14-5220	111	T15-1915	325
14-2815	108	14-5240	111	15-1916	325
T14-2815	108	14-6303	110	T15-1916	325
14-2820	108	T14-6303	110	15-1917	325
T14-2820	108	14-6400	110	T15-1917	325
14-2830	108	T14-6400	110	15-1980	340
T14-2830	108	14-6415	110	15-1982	340
14-2840	108	14-6500	110	15-3915	328
T14-2840	108	T14-6500	110	15-3920	328
14-2860	108	14-6510	110	15-3925	328
14-2880	108	T14-6510	110	T15-3925	328
14-2890	113	14-6560	198	15-3930	328
14-2935	108	14-6562	198	T15-3930	328
14-3050	113	14-6564	198	15-3960	328
T14-3050	113	14-6805	106	15-3961	328
14-3060	113	T14-6805	106	15-3964	328
T14-3060	113	14-6810	106	15-3965	328
14-3070	113	14-6815	106	16-2207	518
T14-3070	113	14-6816	106	16-2208	518
14-3071	113	T14-6816	106	16-2209	518
T14-3071	113	14-6820	106	16-2210	518
14-3072	113	T14-6820	106	16-2440	99
T14-3072	113	14-6821	106	16-2442	99
14-3073	113	14-6830	106	16-2460	99
T14-3073	113	T14-6830	106	16-2470	99

16-2480	99	18-8026B	101	105-578	19
16-2500	99	18-8028	101	105-579	19
16-2510	95, 99	18-8301	41	105-580	19
16-2520	98	23-1818	96	105-581	19
16-2530	98	53-0510	484	105-590	19
16-2530S	98	53-0512	484	105-600	19
16-2540	98	53-0514	484	105-602	19
16-2540S	98	53-0516	484	105-610	19
16-2541	98	53-0518	484	105-612	19
16-2550	98	53-0520	484	105-614	19
16-2550S	98	53-0522	484	105-616	19
16-2551	98	53-0524	484	105-618	19
16-2560	98	53-0526	484	105-620	19
16-2560S	98	53-0528	484	105-622	19
16-2561	98	53-0530	484	105-624	19
16-2570	98	53-0532	484	105-626	19
16-2570S	98	53-0534	484	105-628	19
16-2571	98	53-0536	484	105-630	19
16-2578	98	53-0538	484	105-632	19
16-2579	98	53-0542	484	105-640	19
16-2580	98	53-0544	484	105-642	19
16-2581	98	53-0546	484	105-644	19
16-2582	98	53-0552	484	105-646	19
16-2583	98	53-0554	484	105-650	19
16-2584	98	53-0556	484	105-652	19
16-2585	98	53-0560	484	105-654	19
16-2586	98	53-0562	484	105-656	19
16-2587	98	53-0564	484	105-660	19
16-2588	98	53-0566	484	105-662	19
16-2589	98	53-0574	484	105-664	19
16-2600	99	53-0582	484	105-666	19
16-2760	201	53-0584	484	105-670	19
16-3290	103	53-0590	484	105-672	19
16-3300	103	53-0592	484	105-674	19
16-3310	103	53-0594	484	105-676	19
16-3314	103	77-0450	393	105-686	19
16-3320	103	77-0451	393	105-688	19
16-3330	103	77-0452	393	105-690	19
16-3346	103	90-0620	493	105-692	19
16-3348	103	90-0622	493	105-694	19
16-3350	103	90-0630	493	105-696	19
16-3800	103	90-0632	493	105-700	20
16-3810	103	90-0652	493	105-702	20
16-3820	103	90-0654	493	105-704	20
16-3821	103	90-0662	493	105-706	20
16-3826	103	90-0664	493	105-708	20
16-5300-SET	102	103-115	15	105-710	20
16-5310	102	103-117	15	105-712	20
16-5320	102	103-119	15	105-714	20
16-5321	102	105-540	19	105-716	20
16-5325	102	105-541	19	105-720	19
16-5330	102	105-542	19	105-722	19
16-5331	102	105-543	19	105-723	19
16-5340	102	105-544	19	105-724	19
17-1000	100	105-550	19	105-725	19
18-3209	11	105-551	19	105-726	19
18-3270	11	105-552	19	105-727	19
18-3564	472	105-553	19	105-730	18
18-8020	101	105-570	19	105-732	18
18-8020B	101	105-571	19	105-734	18
18-8022	101	105-572	19	105-736	18
18-8022B	101	105-573	19	105-738	18
T18-8023	101	105-574	19	105-742	18
18-8025	101	105-575	19	105-744	18
18-8025B	101	105-576	19	105-746	18
18-8026	101	105-577	19	105-748	18

105-750	18	T115-450	216	123-600	226
105-780	18	115-452	216	123-601	226
105-781	18	T115-452	216	123-603	226
105-782	18	115-454	215	123-605	226
105-783	18	115-456	215	123-606	226
105-784	18	115-458	215	123-608	226
105-785	18	115-460	215	123-610	226
105-786	18	115-465	215	123-611	226
105-787	18	115-467	215	123-615	226
105-789	18	115-480	217	123-616	226
105-790	18	115-482	217	125-634	16
105-791	18	115-484	217	125-635	16
105-791A	18	115-486	217	125-636	16
105-792	18	115-490	217	125-637	16
105-793	18	115-492	217	125-638	16
105-794	18	115-500	217	125-639	16
105-796	18	115-502	217	125-640	16
105-797	18	115-506	217	125-642	16
105-798	18	115-508	217	125-644	16
105-799	18	115-510	217	125-646	16
105-7951	18	115-512	217	125-655	16
110-268	280	115-514	217	125-656	16
110-269	280	115-515	217	125-657	16
110-271	280	115-518	218	125-658	16
110-272	280	115-519	218	125-659	16
110-280	282	115-520	218	125-661	16
110-281	282	115-522	218	125-662	16
110-308	306	115-524	218	125-663	16
110-340	269	115-526	218	125-664	16
110-344	269	115-530	218	125-666	16
110-345	269	115-532	218	125-667	16
110-347	269	115-534	218	125-668	16
110-351	269	115-536	218	125-669	16
110-908	299	115-538	218	125-670	16
110-910	299	115-540	218	125-671	16
110-915	300	115-585	74	125-673	16
110-920	300	115-586	74	125-674	16
112-580	302	115-600	214	125-675	16
112-581	302	115-602	214	125-676	16
112-582	302	115-604	214	127-226	17
112-585	302	115-606	214	127-227	17
112-602	305	115-4121	212	127-228	17
112-603	305	117-500	227	127-229	17
112-908	299	T117-500	227	130-508	314
112-910	299	117-500L	227	130-517	315
115-295	207	117-501	228	130-518	315
115-310	211	117-503	228	130-521	320
115-312	211	117-518	229	130-523	320
115-410	212	117-521	229	130-525	320
115-410D	212	117-523	229	130-526	320
115-412	212	117-543	81	130-527	317
115-412D	212	117-546	81	130-529	317
115-412S	212	117-549	81	130-531	317
115-422	211	117-559	25	130-563	326
115-422K	220	117-560	25	130-564	327
115-422M	211	T117-560	25	130-565	327
115-424	211	117-561	25	130-570	341
115-424K	220	117-562	81	130-572	341
115-426	211	117-564	25	130-574	341
115-426D	211	117-565	81	132-115	317
115-428	211	117-568	81	132-118	317
115-428D	211	117-571	25	132-120	317
115-429	211	117-577	24	132-122	317
115-432	216	117-578	24	132-123	317
115-434	216	117-582	25	132-125	317
115-450	216	117-5781	24	132-135	338

132-210	320	136-613	191	136-766	187
132-212	320	136-615	191	136-767	187
132-214	320	136-617	191	136-771	187
132-216	320	136-619	191	136-773	187
132-218	320	136-621	190	136-775	187
132-223	320	136-624	190	136-776	187
132-224	320	136-626	190	136-6508	190
132-225	320	136-626F	190	136-6741	194
132-359	337	136-629	190	140-202	197
132-360	337	136-632	190	140-203	197
132-361	337	136-632B	190	140-207	197
132-362	337	136-633	190	140-297T	193
132-362D	337	136-634	190	140-298T	193
132-362S	337	136-636	190	140-302	196
132-364	314	136-637	190	140-302D	196
132-364L	314	136-639	190	140-302F	196
132-364S	314	136-640	190	140-302T	194
132-365	314	136-641	190	140-303	197
132-372	315	136-642	190	140-303F	196
132-373	315	136-643	190	140-304	197
132-374	315	136-644	190	140-304F	197
132-375	314	136-645	190	140-304T	193
132-376	314	136-646	190	140-305	197
132-376S	314	136-648	190	140-305F	197
132-382	339	136-649	190	140-306	197
132-382L	339	136-650	190	140-307	197
132-383	339	136-652	190	140-309	197
132-383L	339	136-653	190	140-313	225
132-384C	338	136-659	198	140-315	225
132-384D	338	136-659D	198	140-320	225
132-384L	338	136-666	195	140-322	225
132-387	339	136-667	195	140-329	225
132-388	320	136-668	195	140-330A	225
132-450	326	136-668A	196	140-331	225
132-632	314	136-669	195	140-334	225
132-634	314	136-671A	199	140-350	189
134-240	380	136-671B	199	140-352	189
134-242	380	136-671C	199	140-354	189
134-243	382	136-671D	199	140-358	189
134-245	382	136-672	195	140-360	189
134-247	383	136-674	196	140-362	189
134-248	383	136-674D	196	140-364	189
134-267	382	136-675	198	140-366	189
134-268	383	136-676	195	140-368	189
134-276	380	136-677	198	140-369	189
134-277	382	136-678P	198	140-376B	189
134-277M	382	136-679	196	140-378	223
134-278	382	136-680	193	140-381	223
134-278M	382	136-682	195	140-383	223
134-280	382	136-682P	195	140-500	192
134-280M	382	136-683	195	140-502	192
134-281	382	136-684	193	140-504A	192
134-281M	382	T136-686	194	140-504B	192
134-282A	382	T136-688	194	140-505T	192
134-282B	382	136-688T	194	140-3032	197
134-288	268	136-690	186	140-3042	197
134-296	267	136-691	186	142-010	221
134-304	121	136-692	186	142-015	221
134-305	121	136-694	186	142-103	188
136-578	192	136-695	186	142-104	188
136-580	192	136-699	196	142-106	188
136-600	191	136-701	189	142-107	188
136-602	191	136-702	189	142-108	188
136-605	191	136-704	189	142-110	188
136-607	191	136-706	189	142-111	188
136-610	191	136-708	189	142-113	187

142-114	187	197-695	152	205-856	149
142-140	220	197-700	152	205-857	149
142-142	220	197-701	152	205-858	149
142-144	220	197-702	152	205-859	149
142-146	220	197-703	152	205-860	149
142-148	220	197-704	152	205-861	149
142-150	220	197-705	152	207-261-SET	57
142-197	222	199-129	448	207-263	57
142-198	222	199-130	448	207-265	57
142-199	590	199-131	448	207-267	57
142-200	221	199-132	448	207-268	57
142-202	221	199-133	448	207-269	57
142-207	222	199-136	448	207-275	57
142-208	222	199-300	449	207-350	415
150-239	154	199-302	449	207-352	415
150-241	154	199-304	449	207-354	415
150-243	154	199-306	449	207-356	415
150-307	210	199-308	449	207-411	411
150-315	210	199-310	449	207-413	411
150-348	206	199-312	449	207-415	411
150-349	206	199-314	449	207-454	410
150-350	206	199-320	449	207-455	410
150-351	206	199-322	449	207-456	410
150-353	206	199-365	193	207-460	410
150-355	206	199-365S	193	207-461	410
150-356	206	199-365T	193	207-462	410
150-357	206	199-368	193	207-463	410
150-358	206	199-372	150	207-464	410
150-359	206	199-380	150	207-465	410
150-361	206	199-382	150	207-466	410
180-373	253	199-383	411	207-467	410
180-374	253	199-384T	150	207-468	410
180-375	253	199-385	150	207-469	410
180-376	253	199-387	150	207-470	410
180-377	253	199-390	150	207-471	410
180-378	253	199-391	150	207-472	410
180-379	253	199-392	151	207-473	410
180-380	253	199-392T	151	207-474	410
180-381	253	199-393A	151	207-482	410
180-382	253	199-393B	151	207-484	410
180-403	253	199-393C	151	207-486	410
180-404	253	199-394	150	207-488	410
180-405	253	199-395	151	207-490	410
180-406	253	199-396	151	214-052	411
180-407	253	199-402T	151	220-114	408
180-408	253	199-480	148	230-380	58, 84
180-409	253	199-481	148	230-381	84
180-410	253	199-482	148	230-382	84
180-411	253	199-483	148	230-385	58, 84
180-412	253	199-517	121	230-386	84
180-420	260	199-520	121	230-387	84
180-422	260	199-522	121	230-390	58
180-424	260	199-524	121	230-392	58
180-432	258	199-600	35	230-511	59
180-433	258	199-602	35	240-613	273
180-436	258	199-604	35	240-614	273
180-439	258	199-606	35	240-625	272
180-440	258	199-3841T	150	305-328	421, 424
180-448	259	199-3921T	151	305-332	421, 424
180-449	259	205-800	90	305-334	421, 424
180-451	259	205-844	148	305-336	421, 424
197-690	152	205-846	148	305-338	421, 424
197-691	152	205-847	148	305-344A	420
197-692	152	205-848	148	305-347	421, 424
197-693	152	205-849	414	305-365	423
197-694	152	205-849B	414	305-365M	423

305-366	423	315-767	372	320-873	442
305-367	423	315-768	372	320-873A	442
305-367S	423	315-775	372	320-874	442
305-368	423	315-776	372	320-874A	442
305-368A	423	315-777	372	320-875	442
305-369	423	315-778	372	320-875A	442
305-369A	423	315-779	372	320-876	442
305-910	381	315-781	373	320-876A	442
310-160	409	320-708	440	320-877	442
315-500	165	320-709	440	320-877A	442
315-500M	165	320-710	440	320-878	442
315-501	165	320-711	440	320-878A	442
315-501M	165	320-712	440	320-925	147
315-505	458	320-713	440	320-930	147
315-505C	458	320-714	440	320-935	147
315-505S	458	320-715	440	320-949	449
315-511	459	320-716	440	320-950	443
315-513	459	320-717	440	320-951	443
315-515	459	320-718	440	320-952	443
315-526	463	320-769	449	320-953	443
315-527	463	320-770	449	320-954	443
315-538	464	320-771	449	320-955	443
315-540	464	320-778	443	330-001	538
315-542	461	320-779	443	330-002	538
315-544	461	320-780	443	330-003	538
315-548	461	320-808	441	330-004	538
315-550	461	320-809	441	330-005	538
315-559	463	320-810	441	330-010	538
315-566	460	320-811	441	330-011	538
315-567	460	320-812	441	330-012	538
315-572	465	320-813	441	330-013	538
315-573	465	320-814	441	330-014	538
315-574	465	320-815	441	330-015	538
315-576	465	320-816	441	330-016	538
315-580	457	320-817	441	330-017	538
315-581	457	320-818	441	330-018	538
315-585	468	320-827	441	330-100	539
315-586	468	320-829	441	330-105	539
315-587	468	320-830	441	330-110	539
315-588	468	320-831	441	330-120	539
315-589	468	320-832	441	330-125	539
315-590	468	320-833	441	330-130	539
315-593	468	320-834	441	330-135	539
315-610	468	320-835	441	330-550	537
315-612	468	320-835T	442	330-551	537
315-614	468	320-836	441	330-552	537
315-616	468	320-837	441	330-553	537
315-619	468	320-838	441	330-554	537
315-621	468	320-848	441	330-555	537
315-671	469	320-849	441	330-556	537
315-672	469	320-850	441	330-557	537
315-673	469	320-851	441	330-558	537
315-674	469	320-852	441	330-559	537
315-675	469	320-853	441	330-570	537
315-676	469	320-854	441	330-571	537
315-677	469	320-855	441	330-572	537
315-678	469	320-855T	442	330-573	537
315-679	469	320-856	441	330-574	537
315-680	469	320-857	441	330-575	537
315-681	469	320-858	441	330-576	537
315-682	469	320-870	442	330-577	537
315-752	373	320-870A	442	330-578	537
315-754	373	320-871	442	330-579	537
315-756	373	320-871A	442	330-610	536
315-765	372	320-872	442	330-611	536
315-766	372	320-872A	442	330-612	536

330-613	536	330-824	529	345-402	34
330-614	536	330-824NH	529	345-405	32
330-615	536	330-824S	529	350-861	298
330-616	536	330-824SH	529	350-861B	298
330-620	536	330-849A	533	350-862	298
330-621	536	330-849B	533	350-862B	298
330-622	536	330-849C	533	350-863	298
330-623	536	330-849D	533	350-864	298
330-624	536	330-849E	533	350-866	591
330-625	536	330-882	532	350-867	591
330-626	536	330-883	532	350-869	591
330-660	537	330-884	532	350-871	591
330-661	537	330-885	532	350-880	591
330-662	537	330-886	532	350-8453T	155
330-663	537	330-887	532	355-161	146
330-664	537	330-888	532	355-162	144
330-665	537	330-889	532	355-163	144
330-670	537	330-890	532	355-163L	144
330-671	537	330-891	532	355-170	145
330-672	537	330-892	532	355-171	145
330-673	537	330-895	532	355-171L	145
330-674	537	335-105	520	355-172	145
330-675	537	335-106	520	355-173	145
330-690	533	335-205	513	355-173L	145
330-691	533	335-207	513	355-182	546
330-692	533	335-210	513	355-183	546
330-693	533	335-212	513	355-186	573
330-694	533	335-250	514	355-187	573
330-695	533	335-254	514	355-188	573
330-696	533	335-255	514	355-189	572
330-700	533	335-260	514	355-190	572, 577
330-701	533	335-265	514	355-191	572
330-702	533	335-270	515	355-192	572, 577
330-703	533	335-275	515	355-193	572, 573
330-704	533	335-280	515	355-198	575
330-705	533	335-285	515	355-199	575, 577
330-706	533	345-212	376	355-202	571
330-708	532	345-226	391	355-207	576
330-708A	532	345-228	391	355-209	571
330-730	533	345-243	390	355-210	571
330-731	533	345-246	395	355-211	576
330-732	533	345-246A	395	355-212	570
330-733	533	345-248	376	355-213	570
330-790M	534	345-249	376	355-214	570
330-791M	534	345-262	394	355-230	553
330-792M	534	345-263	394	355-235	553
330-793M	534	345-264	390	355-236A	552
330-794M	534	345-265	390	355-236B	552
330-795M	534	345-266	390	355-236N	552
330-796M	534	345-267	390	355-236-SET	552
330-799B	534, 535	345-281	387	355-245	553
330-799-SET	534	345-282	387	355-265	154
330-800M-SET	534	345-283	387	400-250	326
330-801M	534	345-285	387	400-252	326
330-802M	534	345-287	387	400-254	326
330-803M	534	345-289	387	400-256	326
330-804M	534	345-310	390	400-418	32
330-805M	534	345-311	390	400-426	33
330-806M	534	345-315	521	400-427	33
330-807M	534	345-320	395	400-427T	33
330-808	527	345-322	395	400-445	232
330-811	528	345-324	395	400-445C	232
330-814	528	345-326	395	400-445L	232
330-814R	528	345-330	395	400-446	232
330-817	527	345-332	395	400-446L	232
330-819	527	345-400	34	400-447	232

400-447L	232	404-796	486	404-6093	474
400-448	232	404-796LP	485	404-7871	480
400-448L	232	404-800	486	404-7875	480
400-4271T	33	404-800LP	485	404-7885	480
404-605	474, 475	404-801	486	404-7929	486
404-606	474, 475	404-801LP	485	404-7929LP	486
404-606B	473	404-802	486	404-7959	486
404-607	474, 475	404-802LP	485	404-60825E	473
404-608-SET	472	404-802S	486	412-414	235
404-719E	483	404-803	486	412-415	235
404-734E	483	404-803LP	485	412-422	235
404-739	482	404-810	486	412-443	232
404-739D	482	404-810LP	485	412-445A	233
404-739U	482	404-811	486	412-445AL	233
404-740	482	404-811LP	485	412-445B	233
404-742	482	404-812	486	412-445BL	233
404-744	482	404-812LP	485	412-445C	233
404-747	482	404-813	485	412-445CL	233
404-747E	483	404-814	485, 488	412-445D	233
404-749	482	404-822	488	412-445EL	233
404-751	482	404-823	488	412-455	32
404-754	482	404-824	490	412-456	32
404-754D	482	404-825	486	412-457	32
404-755	482	404-826	486	412-458	32
404-755D	482	404-827	486	412-459	32
404-755L	482	404-828	486	412-460	32
404-756	482	404-829	486	412-461	32
404-756D	482	404-830	486	412-462A	32
404-758	482	404-831	486	412-462B	32
404-759	482	404-832	486	412-462C	32
404-760	482	404-833	486	412-462D	32
404-761	482	404-834	486	412-520	512
404-762	482	404-835	486	412-522	512
404-763	482	404-836	486	412-524	512
404-766	478	404-837	486	412-526	512
404-767	478	404-838	486	412-527	521
404-768	478	404-839	486	412-528	512
404-769	478	404-6061B	473	412-530	513
404-770	478	404-6062B	473	412-555	519
404-771	478	404-6063B	473	412-556	519
404-772	478	404-6063EB	473	412-557	519
404-777	487	404-6071	475	412-558	519
404-782	491	404-6072	475	412-559	31
404-783	491	404-6073	475	412-571	518
404-784	491	404-6074	475	412-575	518
404-785	491	404-6075	475	412-580	520
404-786	480	404-6076	475	412-583	519
404-787	480	404-6077	475	412-585	519
404-788	480	404-6078	475	412-618T	234
404-788U	480	404-6079	475	412-667A	246
404-790	486	404-6080	475	412-667B	246
404-790LP	485	404-6081	474	412-667C	246
404-791	486	404-6082	474	412-667D	246
404-791LP	485	404-6082B	473	412-677I	252
404-792	486	404-6082C	473	412-677L	251
404-792B	486	404-6083	474	412-677M	251
404-792LP	485	404-6083B	473	412-678	251
404-792S	486	404-6083E	473	412-678I	252
404-793	486	404-6084	474	412-678L	251
404-793K	487	404-6085	474	412-678M	251
404-793LP	485	404-6086	474	412-679	251, 252
404-794	486	404-6087	474	412-679I	252
404-794LP	485	404-6088	474	412-679L	251
404-795	486	404-6089	474	412-680	251, 252
404-795LP	485	404-6090	474	412-680I	252
404-795SLP	485	404-6091	474	412-680L	251

412-680M	251	412-830	256	417-049	412
412-681	251, 252	412-839	254	417-058	413
412-681I	252	412-840	254	417-058D	413
412-681L	251	412-841	254	417-0061	406
412-681M	251	412-844	254	417-062D	406
412-682	251, 252	412-845	254	417-0064	407
412-682I	252	412-846	254	417-064A	407
412-682L	251	412-847	254	417-064B	407
412-682M	251	412-848	254	417-064C	407
412-683	251, 252	412-849	254	417-064D	407
412-683I	252	412-850	254	417-064E	407
412-683L	251	412-851	254	417-064F	407
412-683M	251	412-852	254	417-0482	405
412-684	251, 252	412-853	255	417-0482B	405
412-684I	252	412-854	255	438-591	214
412-684L	251	412-855	255	438-592	214
412-684M	251	412-856	255	438-610	219
412-685	251, 252	412-857	255	438-611	219
412-685I	252	412-858	255	438-612	219
412-685L	251	412-859	255	438-613	219
412-685M	251	412-860	255	438-614	219
412-686	251, 252	412-861	255	438-615	219
412-686I	252	412-5563	519	440-352	74
412-686L	251	412-7151B	257	440-354	74
412-686M	251	413-001	238	440-356	74
412-688	251	413-001S	238	440-358	74
412-688M	251	413-002	238	440-360	74
412-689	251, 252	413-002S	238	440-362	74
412-690	252	413-003	238	440-364	74
412-691	252	413-003S	238	440-370	74
412-692	252	413-004	238	440-372	74
412-694	252	413-004S	238	440-374	74
412-696	252	413-005	238	440-376	74
412-700	252	413-005S	238	440-378	74
412-701	252	413-006	239	440-380	74
412-702	252	413-006S	239	440-382	74
412-704	252	413-007	239	460-156	300
412-705	251	413-007S	239	460-158	301
412-706	252	413-008	239	460-159	301
412-715	257	413-008S	239	460-160	301
412-715A	257	413-009	239	467-370	450
412-715B	257	413-009S	239	467-370S	451
412-715C	257	413-010	240	467-371	450
412-715D	257	413-010S	240	467-371S	451
412-716	257	413-011	240	467-372	450
412-716A	257	413-011S	240	467-372S	451
412-717	257	413-012	240	467-372SL	451
412-718	257	413-012S	240	467-374	450
412-719	257	413-013	240	467-374S	451
412-724	260	413-013S	240	467-376	450
412-727A	256	413-014	240	467-376S	451
412-727B	256	413-014S	240	467-376SL	451
412-728	256	413-015	240	467-378	450
412-728B	256	413-015S	240	467-378S	451
412-729	256	413-016	241	467-379	450
412-729B	256	413-016S	241	467-379S	451
412-736-1	256	413-017	241	467-379SL	451
412-736-2	256	413-017S	241	467-380	450
412-736-3	256	413-018	241	467-380S	451
412-736-4	256	413-018S	241	467-380SL	451
412-740	261	413-019	241	467-382	450
412-741	261	413-019S	241	467-382S	451
412-800	261	417-046	412	467-382SL	451
412-805	261	417-047	412	467-384	450
412-810	261	417-048	404	467-384S	451
412-815	261	417-048R	404	467-384SL	451

467-386	450	467-4341	446	478-277	453
467-386S	451	467-4351	446	478-278	453
467-386SL	451	467-5303	34	478-279	453
467-388	450	467-5304	34	478-280	453
467-388S	451	467-5305	34	478-281	453
467-388SL	451	467-5313	34	478-322	493
467-389	450	467-5314	34	478-360	247
467-389S	451	467-5315	34	478-370	247
467-390	450	468-140	520	478-375	247
467-390S	451	468-150	522	478-380	247
467-392	450	468-160	522	478-382	247
467-392S	451	468-163	520	478-395	523
467-394	450	468-165	520	478-400	523
467-394S	451	468-169	234	478-402	523
467-396	450	468-170	234	478-405	523
467-396S	451	468-171	234	485-634	214
467-398	450	468-172	234	485-636	214
467-398S	451	468-181	234	485-646	214
467-403	450	468-182	234	485-648	214
467-403S	451	468-183	234	485-675	31
467-404	450	468-184	234	502-409	149
467-404S	451	468-185	234	508-523	257
467-406	450	468-548	478	508-532	224
467-406S	451	468-550	478	508-534	225
467-408	450	468-600	479	508-536	153
467-408S	451	468-606	479	508-538	153
467-410	450	468-610	479	508-541	153
467-410HL	451	468-616	479	508-542	153
467-410S	451	468-620	479	508-543	153
467-412	450	468-622	479	508-544	153
467-412S	451	468-636	479	508-547	153
467-414	146	468-638P	479	508-615	122
467-415	447	469-035	481	508-619	122
467-430	446	469-036	497	508-622	122
467-431	446	469-040	497	508-624	122
467-432	446	469-048	497	515-505	380
467-433	446	469-050	497	516-240	224
467-434	446	469-053	488	516-242	224
467-435	446	469-055	488	516-244	224
467-436	447	469-056	488	516-246	224
467-438	447	469-057	488	516-770	155
467-440	447	469-058	488	516-771	155
467-440XS	447	469-062	501	525-254	492
467-441	150	469-063	501	525-256	492
467-450	30	469-063A	501	525-364	435
467-452	30	469-063L	501	1100-005	620
467-454	30	469-063M	501	1100-006	620
467-460	31	469-063X	501	1100-007	620
467-461	31	469-080	501	1100-020	620
467-462	31	469-081	501	1100-022	620
467-463	32	469-082	501	1100-024	620
467-464	32	469-083	501	1100-026	620
467-464A	32	469-084	501	1100-030	620
467-465	31	475-185	297	1100-035	620
467-467	31	475-186	297	1100-040	620
467-532	522	475-187	297	1100-042	620
467-533	522	475-188	297	1100-044	621
467-534T	34	475-855	247	1100-094	327
467-535	518	475-950	35	1100-096G	327
467-4131	447	478-260	452	1100-098	327
467-4131A	447	478-265	452	1100-105A	334
467-4132	447	478-267	452	1100-105D	334
467-4132A	447	478-269	452	1100-106	336
467-4133	447	478-271	452	1100-106A	336
467-4133A	447	478-273	452	1100-106D	334
467-4134	447	478-276	453	1100-106DBP	335

1100-106DL	334	1100-268	295	1100-479A	535
1100-108	336	1100-270	295	1100-479B	535
1100-110DBP	335	1100-272R	280	1100-479C	535
1100-114L	317	1100-274	281	1100-479D	535
1100-124	336	1100-274R	280	1100-479E	535
1100-124D	334	1100-276	282	1100-479F	535
1100-126	336	1100-278R	280	1100-479G	535
1100-126D	334	1100-280	281	1100-479H	535
1100-128D	334	1100-280R	280	1100-479J	535
1100-140L	212	1100-282	282	1100-479K	535
1100-150	219	1100-291	286	1100-479L	535
1100-151	219	1100-295	265	1100-479M	535
1100-152	219	1100-296	265	1100-479N	535
1100-152L	219	1100-297	265	1100-479-SET	535
1100-153	219	1100-298	265	1100-485	392
1100-161	223	1100-298D	265	1100-485-SET	392
1100-161D	222	1100-299	265	1100-490	389
1100-162	223	1100-301	265	1100-490C	388
1100-162D	222	1100-302	265	1100-491	388
1100-163	223	1100-304	266	1100-492	386
1100-163D	222	1100-305	266	1100-492A	386
1100-164	223	1100-306	266	1100-492B	386
1100-164D	222	1100-307	268	1100-492C	386
1100-165	190	1100-308	266	1100-492D	387
1100-167	190	1100-310	266	1100-492F	387
1100-169	190	1100-328	498	1100-492G	387
1100-179	190	1100-328L	496	1100-496	583
1100-185	195	1100-330	498	1100-496D	585
1100-187	190	1100-330S	496	1100-496L	584
1100-196	298	1100-331	497	1100-503	377
1100-197	298	1100-332	498	1100-504	377
1100-198	298	1100-333	496	1100-505	377
1100-199	298	1100-334	496	1100-506	377
1100-204	269	1100-344	119	1100-508	377
1100-204L	269	1100-346	119	1100-521	154
1100-205	269	1100-392	316	1100-521L	154
1100-206	269	1100-411-10	100	1100-521S	154
1100-207	270	1100-411-11	100	1100-529	568
1100-208	270	1100-411-12	100	1100-530	568
1100-209	274	1100-411-13	100	1100-530A	574
1100-209-Black	274	1100-411-14	100	1100-531	574
1100-209-Blue	274	1100-411-15	100	1100-532	546
1100-209-Pink	274	1100-411-16	100	1100-533	546
1100-209-Purple	274	1100-411-17	100	1100-533A	546
1100-212	294	1100-411-18	100	1100-536	546
1100-212L	294	1100-411-19	100	1100-542	461
1100-214	294	1100-411-20	100	1100-544	461
1100-214L	294	1100-411-21	100	1100-574	456
1100-216	295	1100-411-22	100	1100-576	456
1100-224	294	1100-411-23	100	1100-577	456
1100-226	294	1100-412-24	100	1100-577S	456
1100-228	295	1100-412-26	100	1100-578	462
1100-233	286	1100-412-28	100	1100-578A	462
1100-236	286	1100-412-30	100	1100-579	174
1100-236L	286	1100-412-33	100	1100-581	174
1100-238	286	1100-412-36	100	1100-581A	174
1100-241	286	1100-412-38	100	1100-582	174
1100-242	286	1100-412-40	100	1100-584	159, 465
1100-244	286	1100-412-43	100	1100-584A	159, 465
1100-250	281	1100-412-45	100	1100-586C1	162
1100-256	281	1100-412-47	100	1100-586C2	162
1100-256L	281	1100-461S	529	1100-586C3	162
1100-260	294	1100-462S	526	1100-586C4	162
1100-262	294	1100-462SH	526	1100-586C5	162
1100-264	294	1100-463S	526	1100-586S1	162
1100-265	294	1100-466	376	1100-586S2	162

1100-586S3	162	1100-633F	400	1100-722C	500
1100-586S4	162	1100-633G	400	1100-724A	500
1100-586S5	162	1100-633H	400	1100-724B	500
1100-586-SET	162	1100-633HR	400	1100-724C	500
1100-586V	160	1100-633I	400	1100-728	136
1100-586W1	160, 161	1100-635	408	1100-728S	136
1100-586W1.5	161	1100-635C	408	1100-739A	191
1100-586W2	160, 161	1100-648	411	1100-739B	191
1100-586W3	160, 161	1100-648B	411	1100-740	24
1100-586W4	160, 161	1100-650	411	1100-741	24
1100-586W5	160, 161	1100-650B	411	1100-756	130
1100-586W6	160, 161	1100-652	411	1100-757	130
1100-586W7	161	1100-652B	411	1100-758	130
1100-586W7V	160	1100-654	411	1100-767A	493
1100-586W.75	161	1100-654B	411	1100-767B	493
1100-586WS	160, 161	1100-656	411	1100-767C	493
1100-595	167	1100-656B	411	1100-768A	493
1100-599	167	1100-658	411	1100-768B	493
1100-600	159	1100-658B	411	1100-768C	493
1100-602	165	1100-660	411	1100-769	500
1100-606-SET	49	1100-660B	411	1100-770	500
1100-607-SET	49	1100-662	411	1100-771A	500
1100-609-SET	48	1100-662B	411	1100-771B	500
1100-610-SET	47	1100-668	414	1100-772	130
1100-611B-SET	44	1100-668B	414	1100-774	130
1100-611C-SET	46	1100-668T	414	1100-776	130
1100-611-SET	44	1100-669	414	1100-778	130
1100-612	45	1100-669B	414	1100-780	130
1100-613	45	1100-670	415	1100-781	130
1100-614-SET	48	1100-670B	415	1100-788	17
1100-627-SET	48	1100-671	416	1100-798	510
1100-628	401	1100-671E	416	1100-798A	510
1100-628A	398	1100-672	416	1100-798B	511
1100-628B	401	1100-672E	416	1100-798C	511
1100-628C	398	1100-673	416	1100-798D	511
1100-628G	402	1100-673E	416	1100-798E	510
1100-628GR	402	1100-674	416	1100-798F	510
1100-629	401	1100-675	416	1100-798G	510
1100-629A	398	1100-676	416	1100-798H	512
1100-629B	401	1100-677	417	1100-798S	510
1100-629G	402	1100-678	417	1100-851	317
1100-629GR	402	1100-679	417	1100-853	317
1100-629L	401	1100-680	417	1100-854	317
1100-630	401	1100-682	409	1100-866	25
1100-630A	401	1100-684	409	1100-868	25
1100-630G	402	1100-686	409	1100-903	134
1100-630GR	402	1100-710A	500	1100-904	134
1100-630N	400	1100-710B	500	1100-905	134
1100-631	398	1100-710C	500	1100-1618	222
1100-631A	398	1100-712A	500	1100-1638	222
1100-631B	398	1100-712B	500	1100-4851	392
1100-631G	402	1100-712C	500	1100-4852	392
1100-631GR	402	1100-714A	500	1100-4853	392
1100-631N	400	1100-714B	500	1100-5860-SET	162
1100-631S	398	1100-714C	500	1100-6071-SET	49
1100-632	401	1100-716A	500	1100-6280	401
1100-632G	402	1100-716B	500	1100-6691	409
1100-632GR	402	1100-716C	500	1100-6692	409
1100-632R	400	1100-718A	500	1100-6696	417
1100-633	399	1100-718B	500	1100-6780	417
1100-633A	399	1100-718C	500	1100-7411	24
1100-633B	399	1100-720A	500	1101-160	221
1100-633BR	399	1100-720B	500	1101-160D	222
1100-633C	399	1100-720C	500	1101-161	221
1100-633D	399	1100-722A	500	1101-161D	222
1100-633E	399	1100-722B	500	1101-162	221

1101-162D	222	1102-RESCJ1S-N5	172	1103-043	432
1101-163	221	1102-RESCJ1S-U15	172	1103-045	430
1101-163D	222	1102-RESCJ2-3	172	1103-054A	434
1101-164	221	1102-RESCJ2S-3S	172	1103-054B	434
1101-165	221	1102-RESCM0-00	171	1103-054C	434
1101-500	61	1102-RESCN1	171	1103-054D	434
1101-502	61	1102-RESCN5-48	171	1103-055	435
1101-504	61	1102-RESCN129	172	1103-056	435
1101-506	61	1102-RESCO7-9	171	1103-057	435
1101-523	53	1102-RESCU15-47	171	1103-060	435
1101-524	54	1102-RESCU15-K13	171	1103-061	435
1101-526	54	1102-SC21S-U15	172	1103-069	420
1101-528	54	1102-SC45-46	171	1103-070	422
1101-530	54	1102-SC45A-46A	171	1103-071	422
1101-532	54	1102-SC157-158	172	1103-073	422
1101-534	54	1102-SC204	172	1103-074	422
1101-536	54	1102-SC204IUFW	172	1103-075	422
1101-554	53	1102-SC204S	172	1103-075D	422
1101-560	143	1102-SC204SD	172	1103-076	422
1101-561	143	1102-SCALSR	171	1103-077	422
1102-1.3S	158	1102-SCCUMINE	171	1103-078	422
1102-1.30C	158	1102-SCGR13-14	173	1103-079	422
1102-100C	158	1102-SCJ1-1S	171	1103-080	422
1102-BR42	523	1102-SCJ1S-N5	172	1103-092	372
1102-CPLH20	163	1102-SCJ1S-U15	172	1103-093	372
1102-EEB12	173	1102-SCJ2-3	172	1103-094	372
1102-EPGAR2	163	1102-SCJ2S	173	1103-095	372
1102-EX3CH	170	1102-SCJ2S-3S	172	1103-100	569
1102-EX3DE	170	1102-SCJ2S-3SL	173	1103-102	568
1102-EX9	163	1102-SCM0-00	171	1103-103V	568
1102-EX9M	163	1102-SCM17-18	173	1103-104	567
1102-EX11-12	170	1102-SCN1	171	1103-105	569
1102-EX11-12L	170	1102-SCN5-48	171	1103-108	567
1102-EX16	170	1102-SCN129	172	1103-109	567
1102-EX16-23	170	1102-SCO7-9	171	1103-115	566
1102-EX19	163	1102-SCU15-47	171	1103-120	548
1102-EX51	163	1102-SCU15-K13	171	1103-122	547
1102-EX-SET	163	1102-WJ-S	158	1103-123	547
1102-PCN12-23	170	1103-003	425	1103-125	545
1102-PCN15-23	170	1103-004	425	1103-126	545
1102-PCOW23	170	1103-005	425	1103-127	545
1102-PCWHO-23	170	1103-006	426	1103-127A	545
1102-PW23	170	1103-008	426	1103-138	548
1102-REEP24G	163	1103-010	426	1103-140	571
1102-REEX3CH	170	1103-011	426	1103-140A	571
1102-REEX3DE	170	1103-013	426	1103-150	582
1102-REEX11-12	170	1103-014	426	1103-152	580
1102-REEX11-12L	170	1103-031	436	1103-152A	583
1102-REEX16	170	1103-037	437	1103-153	580
1102-REEX16-23	170	1103-037A	437	1103-154S	580
1102-REPCN12-23	170	1103-037S	437	1103-155	581
1102-REPCN15-23	170	1103-038	436	1103-158	585
1102-REPCOW-23	170	1103-039L	430	1103-158B	584
1102-REPCWHO-23	170	1103-039N	430	1103-158M	582
1102-REPW23	170	1103-040	432	1103-158S	585
1102-RESC21S-U15	172	1103-040A	431	1103-160	563
1102-RESC45-46	171	1103-040AS	431	1103-165	562
1102-RESC45A-46A	171	1103-040B	431	1103-166	562
1102-RESC157-158	172	1103-040BS	431	1103-166X	562
1102-RESC204	172	1103-040C	431	1103-167	562
1102-RESC204IUFW	172	1103-040R	432	1103-168	507
1102-RESC204S	172	1103-041	432	1103-168-SET	507
1102-RESC204SD	172	1103-041A	433	1103-170	40
1102-RESCALSR	171	1103-041B	433	1103-171	584
1102-RESCCUMINE	171	1103-041C	433	1103-179	544
1102-RESCJ1-1S	171	1103-042	432	1103-180	506

1103-180T	506	1103-286C	532	1103-389F	160
1103-184K	504, 505	1103-287	532	1103-389G	160
1103-184-SET	505	1103-287C	532	1103-389H	160
1103-184T-SET	505	1103-288	532	1103-389J	160
1103-185K	504, 505	1103-288C	532	1103-389X	160
1103-185-SET	505	1103-289	532	1103-390	179
1103-185T	505	1103-289C	532	1103-391	161
1103-185T-SET	505	1103-290	403	1103-391S	161
1103-187	505	1103-291	532	1103-392	161
1103-190	504, 505	1103-291C	532	1103-393	161
1103-190H	505	1103-292	532	1103-394	161
1103-191	504, 505	1103-292C	532	1103-395	161
1103-191H	505	1103-293	532	1103-396	161
1103-193	504	1103-293C	532	1103-396A	161
1103-193K	504	1103-297	403	1103-397	162
1103-200	542	1103-299	175	1103-398	162
1103-201	543	1103-300	175	1103-0425	432
1103-201A	543	1103-301	175	1103-500	103
1103-201B	543	1103-302	175	1103-500A	103
1103-201C	543	1103-303	175	1103-500B	103
1103-201D	543	1103-304	175	1103-500C	103
1103-201E	543	1103-308	176	1103-500D	103
1103-201F	543	1103-310	164	1103-500E	103
1103-201G	543	1103-320	164	1103-500F	103
1103-201H	543	1103-329	174	1103-500G	103
1103-202	589	1103-337	164	1103-500H	103
1103-202D	589	1103-339A	164	1103-500J	103
1103-203	589	1103-340	164	1103-583	164
1103-203D	589	1103-346	168	1103-595	341
1103-204	588	1103-348	166	1103-596	341
1103-204A	588	1103-348S	166	1103-597	341
1103-215	420	1103-350	166	1103-601	337
1103-219	377	1103-351	166	1103-604	337
1103-220-SET	377	1103-352	168	1103-708	242
1103-221	377	1103-353	168	1103-709	243
1103-224	386	1103-354	464	1103-712	10
1103-225C	388	1103-357	165	1103-715	162
1103-228	389	1103-358	165	1103-717	10
1103-230	459	1103-360	178	1103-717D	10
1103-232	388	1103-362	178, 181	1103-723	621
1103-236	389	1103-363	181	1103-730	17
1103-237	389	1103-364	181	1103-750	139
1103-238	389	1103-365	181	1103-752	139
1103-263	440	1103-366	181	1103-754	139
1103-264	440	1103-367	181	1103-756	139
1103-265	440	1103-367S	181	1103-758	139
1103-266	440	1103-368	177, 178	1103-760	139
1103-267	440	1103-369	177	1103-762	139
1103-268	440	1103-370	177	1103-770	139
1103-269	440	1103-371	175	1103-772	139
1103-270	440	1103-372	176, 178	1103-774	139
1103-271	440	1103-374	176	1103-776	139
1103-272	440	1103-376	178	1103-778	139
1103-280	532	1103-378	176	1103-780	139
1103-280C	532	1103-378M	176	1103-782	139
1103-281	532	1103-379	176	1103-808	198
1103-281C	532	1103-379M	176	1103-809	198
1103-282	532	1103-380	180	1103-810	198
1103-282C	532	1103-382	180	1103-811	199
1103-283	532	1103-385	179	1103-811T	199
1103-283C	532	1103-386	179	1103-812	198
1103-284	532	1103-389A	160	1103-812T	194
1103-284C	532	1103-389B	160	1103-815	213
1103-285	532	1103-389C	160	1103-816	213
1103-285C	532	1103-389D	160	1103-817	213
1103-286	532	1103-389E	160	1103-818	213

1103-841	563	1106-403	381	1200-202	269
1103-845	427	1106-404	381	1200-203	269
1103-846	427	1106-618	136	1200-204	269
1103-846R	427	1106-619	136	1200-204L	269
1103-847	563	1106-620	136	1200-205	269
1103-848	563	1106-621	136	1200-206	269
1103-848S	563	1106-622	136	1200-208	269
1103-870	271	1106-624	136	1200-210	269
1103-871	271	1106-625	136	1200-212	294
1103-873	271	1106-626	136	1200-214	294
1103-885C	621	1106-627	136	1200-216	295
1103-889	135	1106-628	136	1200-224	294
1103-890	135	1106-629	136	1200-226	294
1103-900	620, 621	1106-730	137	1200-228	295
1103-1381	548	1106-0791	457	1200-229	294
1103-1551	581	1106-900	132	1200-231	295
1103-1552	581	1106-905	132	1200-250	281
1103-2011	543	1106-910	132	1200-256	281
1103-3661	181	1106-915	132	1200-259	283
1103-3662	181	1106-930	132	1200-326	287
1103-3901	161	1106-935	132	1200-328	287
1103-16820	507	1106-940	132	1200-330	287
1103-16827	507	1106-945	132	1200-330L	287
1103-16835	507	1106-946	132	1200-332	287
1106-070	458	1106-948	131	1200-334	287
1106-075	458	1106-949	132	1200-335	287
1106-076	457	1106-949H	132	1200-340	287
1106-077	457	1106-950	132	1200-347	287
1106-078	457	1106-950H	132	1200-348	296
1106-079	457	1106-952	132	1200-402	302
1106-080	456	1106-952H	132	1200-404	299
1106-082	456	1106-960	131	1200-404B	299
1106-084	456	1106-962	131	1200-405	299
1106-086	456	1106-965	558	1200-405B	299
1106-091	456	1106-967	558	1200-445	307
1106-092	456	1106-970-SET	140	1200-480	270
1106-124	544	1106-971	140	1200-482	269
1106-130	549	1106-972	140	1200-485	269
1106-131	549	1106-973	140	1200-488	269
1106-132	549	1106-973C	140	1200-500	291
1106-140	549	1106-974	140	1200-501	291
1106-185	552	1106-975	140	1200-505	291
1106-190	40	1106-980-SET	141	1200-507	291
1106-196	542	1106-981	141	1200-510	291
1106-198	542	1106-982	141	1200-512	291
1106-199	543	1106-983	141	1200-514	291
1106-206	542	1106-983C	141	1200-515	291
1106-260	556	1106-984	141	1200-520	291
1106-261	556	1106-985	141	1200-526	291
1106-262	556	1106-990	138	1200-526S	291
1106-263	556	1106-992	138	1200-529	291
1106-264	558	1106-2881	559	1200-530	291
1106-266	558	1200-008	118	1200-531	291
1106-268	558	1200-009	118	1200-535	291
1106-270S	556	1200-020	119	1200-536	291
1106-271	556	1200-021	119	1200-537	291
1106-280	557	1200-022	119	1200-538	291
1106-281	557	1200-023	119	1200-540	281
1106-284	557	1200-070	305	1200-542	280
1106-285	557	1200-072	305	1200-543	282
1106-288	559	1200-076	305	1200-545	281
1106-289A	559	1200-076B	305	1200-547	280
1106-289B	559	1200-76M	288	1200-548	282
1106-400	381	1200-190	270	1200-550	280
1106-401	381	1200-192	270	1200-551	280
1106-402	381	1200-195	271	1200-600	298

1200-601	298	1271-090	361	1271-142U	353, 361
1200-602	298	1271-115	354	1271-143	354, 355, 357, 361
1200-603	298	1271-116T	354	1271-145	443
1200-686	269	1271-116U	354	1271-148S	354
1200-688	269	1271-117	359, 360	1271-148T	354
1200-690	270	1271-117-1	359, 360, 361	1271-149	354
1200-701	117	1271-117-2	359, 360, 361	1271-0151	30
1200-705	117	1271-117-3	359, 360, 361	1271-152	28
1200-708	116	1271-117-4	359, 360	1271-152B	29
1200-712	294	1271-117-5	359	1271-152C	29, 30
1200-713	294	1271-118	353	1271-152D	29
1200-714	294	1271-118T	352	1271-153	29
1200-715	294	1271-118U	353	1271-0154	30
1200-716	295	1271-119T	352	1271-155	30
1200-717	295	1271-119U	353	1271-156	30
1200-719	301	1271-120	146, 356	1271-156C	30
1200-720	301	1271-120U	355	1271-160	29
1200-727	281	1271-121	355	1271-163	29
1200-730	281	1271-121A	355	1271-165	28
1200-733	282	1271-121B	355	1271-175	28
1200-735	282	1271-121C	355	1271-180	28
1200-750	288	1271-121PT	352	1271-181	28
1200-752	288	1271-121T	352	1271-281D	142
1200-760	288	1271-121U	355, 361	1271-282	142
1200-762	288	1271-122	355	1271-283	143
1200-775	119	1271-122U	355, 361	1271-284	143
1200-775M	288	1271-123	356	1271-300	521
1200-776	119	1271-123LW	356	1271-301	521
1200-776M	288	1271-125T	352	1271-302	521
1200-776S	119	1271-125U	353	1271-307	522
1200-780	288	1271-126	353	1271-309	522
1200-782	288	1271-126T	352	1271-310	521
1200-783	288	1271-126U	353	1271-320	357
1200-784	288	1271-127	353	1271-321	357
1200-786	288	1271-127T	352	1271-322	357
1200-787	288	1271-127U	353, 361	1271-323	357
1200-788	289	1271-128	353	1271-324	357
1200-790	289	1271-128T	352	1271-325	357
1200-843	306	1271-128U	353	1271-326	357
1200-845	306	1271-129	356	1271-327	357
1200-846	306	1271-130	356	1271-330	357
1200-911	290	1271-130PH	356	1271-342	147
1200-912	290	1271-131	353	1271-350	350
1200-915	290	1271-132	353	1271-351	350
1200-916	290	1271-133AU	357	1271-352	350
1200-935	116	1271-133U	357	1271-353	350
1200-940	302	1271-134	355	1271-354	350
1200-945	303	1271-135T	352	1271-355	350
1200-990	301	1271-136	353	1271-360	350
1271-005	349	1271-136T	352	1271-361	350
1271-005A	349	1271-136U	353	1271-362	350
1271-006	349	1271-138	353	1271-364	350
1271-007	349	1271-138T	352	1271-365	350
1271-008	349	1271-138U	353	1271-370	346, 350
1271-009	349	1271-139	353	1271-371	346, 350
1271-010	498	1271-139S	353	1271-372	346, 350
1271-011	498	1271-139ST	352	1271-373	346, 350
1271-012	498	1271-139SU	353	1271-374	346, 350
1271-013	498	1271-139T	352	1271-375	346, 350
1271-016	349, 499	1271-139U	353, 361	1271-380	346, 350
1271-018	349, 499	1271-140	354	1271-381	346, 350
1271-020	349, 361, 499	1271-140U	354, 361	1271-382	346, 350
1271-020R	499	1271-142	353	1271-383	346, 350
1271-021	349, 499	1271-142LT	352	1271-384	346, 350
1271-021A	349, 499	1271-142RT	352	1271-385	346, 350
1271-060R	361	1271-142T	352	1271-390	346, 350

1271-391	346, 350	1271-510	351	1404-846A	481
1271-392	346, 350	1271-511	351	1404-846B	481
1271-393	346, 350	1271-512	351	1404-846D	481
1271-394	346, 350	1271-513	351	1404-855	491
1271-395	346, 350	1271-514	351	1404-857	490
1271-400	350	1271-515	351	1404-858	490
1271-401	350	1271-520	351	1404-860	489
1271-402	350	1271-521	351	1404-861	489
1271-403	350	1271-522	351	1404-862	489
1271-404	350	1271-523	351	1404-865	489
1271-410	350	1271-524	351	1404-882B	135
1271-411	350	1271-525	351	1404-882BM	135
1271-412	350	1271-530	351	1404-883B	135
1271-413	350	1271-531	351	1404-883BH	135
1271-414	350	1271-532	351	1404-883BM	135
1271-420	346, 350	1271-533	351	1404-884BM	135
1271-421	346, 350	1271-534	351	1404-885H	133
1271-422	346, 350	1271-535	351	1404-885-SET	133
1271-423	346, 350	1271-540	351	1404-886-SET	133
1271-424	346, 350	1271-541	351	1404-887-SET	133
1271-425	346, 350	1271-542	351	1404-890	133
1271-430	346, 350	1271-543	351	1404-895	138
1271-431	346, 350	1271-544	351	1404-897	138
1271-432	346, 350	1271-545	351	1404-8902	133
1271-433	346, 350	1271-550	347, 351	1467-456	33
1271-434	346, 350	1271-551	347, 351	1467-458	33
1271-435	346, 350	1271-552	347, 351	1467-460	33
1271-440	346, 350	1271-553	347, 351	2100-008	64
1271-441	346, 350	1271-554	347, 351	2100-010	64
1271-442	346, 350	1271-555	347, 351	2100-015	65
1271-443	346, 350	1271-1204U	355	2100-017	65
1271-444	346, 350	1271-1218	355	2100-019	65
1271-445	346, 350	1272-146R	348	2100-021	65
1271-450	347, 350	1272-147R	348	2100-023	65
1271-451	347, 350	1272-148R	348	2100-025	65
1271-452	347, 350	1272-149R	348	2100-027	65
1271-453	347, 350	1272-150R	348	2100-029	65
1271-454	347, 350	1272-151R	348	2100-031	65
1271-460	347, 350	1272-152R	348	2100-035	66
1271-461	347, 350	1272-153R	348	2100-037	66
1271-462	347, 350	1272-155R	348	2100-039	66
1271-463	347, 350	1273-031	367	2100-041	66
1271-464	347, 350	1273-112	366	2100-043	66
1271-470	347, 350	1273-113	366	2100-045	66
1271-471	347, 350	1273-114	367	2100-047	66
1271-472	347, 350	1273-115	368	2100-049	66
1271-473	347, 350	1273-122	364	2100-051	66
1271-474	347, 350	1273-123	364	2100-130	67
1271-480	351, 361	1273-150	364	2100-132	67
1271-481	351	1273-150L	364	2100-134	67
1271-482	351	1273-151	364	2100-136	67
1271-483	351	1273-152	364	2100-138	67
1271-484	351	1273-153	364	2100-220	68
1271-485	351	1273-154	364	2100-230	68
1271-490	351	1273-155	364	2100-232	68
1271-491	351	1273-156	364	2100-234	68
1271-492	351	1273-161	364	2100-400	69
1271-493	351	1273-162	369	2100-402	69
1271-494	351	1273-171	369	2100-405	69
1271-495	351	1273-1141	367	2100-407	69
1271-500	351	1404-840	142	2100-410	69
1271-501	351	1404-841	142	2100-412	69
1271-502	351	1404-841P	142	2100-415	69
1271-503	351	1404-845A	481	2100-417	69
1271-504	351	1404-845B	481	2100-450	69
1271-505	351	1404-845D	481	2100-452	69

2100-453	69	2100-497D	76	2100-589B	77
2100-454	69	2100-498A	76	2100-589C	77
2100-464	70	2100-498B	76	2100-589D	77
2100-482A	76	2100-498C	76	2100-590A	77
2100-482B	76	2100-498D	76	2100-590B	77
2100-482C	76	2100-499A	76	2100-590C	77
2100-482D	76	2100-499B	76	2100-590D	77
2100-483A	76	2100-499C	76	2100-591A	77
2100-483B	76	2100-499D	76	2100-591B	77
2100-483C	76	2100-575A	77	2100-591C	77
2100-483D	76	2100-575B	77	2100-591D	77
2100-484A	76	2100-575C	77	2100-592A	77
2100-484B	76	2100-575D	77	2100-592B	77
2100-484C	76	2100-576A	77	2100-592C	77
2100-484D	76	2100-576B	77	2100-592D	77
2100-485A	76	2100-576C	77	2100-733	80
2100-485B	76	2100-576D	77	2100-755	79
2100-485C	76	2100-577A	77	2100-756	79
2100-485D	76	2100-577B	77	2100-757	79
2100-486A	76	2100-577C	77	2100-781	78
2100-486B	76	2100-577D	77	2100-782	78
2100-486C	76	2100-578A	77	2100-783	78
2100-486D	76	2100-578B	77	2100-784	78
2100-487A	76	2100-578C	77	2100-785	78
2100-487B	76	2100-578D	77	2100-800	71
2100-487C	76	2100-579A	77	2100-802	71
2100-487D	76	2100-579B	77	2100-804	71
2100-488A	76	2100-579C	77	2100-806	71
2100-488B	76	2100-579D	77	2100-810	71
2100-488C	76	2100-580A	77	2100-812	71
2100-488D	76	2100-580B	77	2100-814	71
2100-489A	76	2100-580C	77	2100-816	71
2100-489B	76	2100-580D	77	2100-835	72
2100-489C	76	2100-581A	77	2100-836	72
2100-489D	76	2100-581B	77	2100-837	72
2100-490A	76	2100-581C	77	2100-838	72
2100-490B	76	2100-581D	77	2100-839	72
2100-490C	76	2100-582A	77	2100-840	72
2100-490D	76	2100-582B	77	2100-841	72
2100-491A	76	2100-582C	77	2100-842	72
2100-491B	76	2100-582D	77	2100-843	72
2100-491C	76	2100-583A	77	2100-875	73
2100-491D	76	2100-583B	77	2100-894	80
2100-492A	76	2100-583C	77	2100-895	80
2100-492B	76	2100-583D	77	2100-896	80
2100-492C	76	2100-584A	77	2100-897	80
2100-492D	76	2100-584B	77	2100-898	80
2100-493A	76	2100-584C	77	2100-899	80
2100-493B	76	2100-584D	77	2200-015	188
2100-493C	76	2100-585A	77	2200-016	188
2100-493D	76	2100-585B	77	2200-017	188
2100-494A	76	2100-585C	77	2200-018	188
2100-494B	76	2100-585D	77	2200-074	185
2100-494C	76	2100-586A	77	2200-075	185
2100-494D	76	2100-586B	77	2200-076	185
2100-495A	76	2100-586C	77	2200-077	185
2100-495B	76	2100-586D	77	2200-078	185
2100-495C	76	2100-587A	77	2200-079	185
2100-495D	76	2100-587B	77	2200-080	185
2100-496A	76	2100-587C	77	2200-081	185
2100-496B	76	2100-587D	77	2200-085	185
2100-496C	76	2100-588A	77	2200-090	185
2100-496D	76	2100-588B	77	2200-090P	185
2100-497A	76	2100-588C	77	2200-091	185
2100-497B	76	2100-588D	77	2200-092	185
2100-497C	76	2100-589A	77	2200-096	185

2200-097	185	2200-555	209	2300-0498	331
2200-098	185	2200-556	209	2300-499	331
2200-098P	185	2200-566	209	2300-516	316
2200-099	185	2200-567	209	2300-518	316
2200-099P	185	2200-568	209	2300-520	316
2200-100	185	2200-569	209	2300-521	316
2200-101	184	2200-750	191	2300-600	580
2200-101A	184	2200-752	191	2300-601	580
2200-101F	186	2200-0902	185	2300-602	580
2200-102	184	2200-0912	185	2300-604	580
2200-102A	184	2200-0922	185	2300-714	318
2200-102F	186	2200-1112	184	2300-716	318
2200-103	184	2200-1112P	184	2300-718	318
2200-103A	185	2200-1132	184	2300-718N	318
2200-103F	186	2200-1132A	185	2300-720	318
2200-104	184	2200-1133	184	2300-723	318
2200-104F	186	2200-1431	186	2300-726	318
2200-105	184	2200-1441	186	2300-730	318
2200-105A	184	2300-020	329	2300-730S	330
2200-105B	184	2300-022	329	2300-1530S	330
2200-106	185	2300-024	329	2300-3132	321
2200-107	184	2300-026	329	2400-010	120
2200-107A	185	2300-030	329	2400-012	120
2200-107C	185	2300-032	329	2400-015	120
2200-107P	184	2300-034	329	2400-017	120
2200-108	184	2300-036	329	2400-185	281
2200-108A	185	2300-038	329	2400-187	281
2200-108P	184	2300-040	329	2400-188	281
2200-109	184	2300-040S	329	2400-189	281
2200-110	184	2300-042	329	2400-190	281
2200-110P	184	2300-042S	329	2400-191	280
2200-111	184	2300-048	324	2400-192	280
2200-111P	184	2300-049	324	2400-193	280
2200-112	184	2300-126S	330	2400-194	280
2200-113	184	2300-128S	330	2400-195	280
2200-0175	188	2300-130S	330	2400-197	280
2200-228	209	2300-132S	330	2400-198	280
2200-382	188	2300-134S	330	2400-199	280
2200-403	590	2300-136S	330	2400-206	281
2200-405	590	2300-138S	330	2400-207	281
2200-516	210	2300-140S	330	2400-208	283
2200-517	210	2300-150S	330	2400-209	283
2200-518	210	2300-152S	330	2400-210	283
2200-519	210	2300-154S	330	2400-210B	283
2200-521	208	2300-156S	330	2400-211	283
2200-523	209	2300-166	330	2400-211B	283
2200-523A	208	2300-168	330	2400-212	283
2200-524	209	2300-170	330	2400-213	283
2200-525	209	2300-172	330	2400-214	283
2200-526	209	2300-307	321	2400-215	283
2200-527	209	2300-309	321	2400-216	283
2200-530	207	2300-310	321	2400-217	283
2200-532	207	2300-310L	321	2400-218	283
2200-534	207	2300-311	321	2400-222	281
2200-536	207	2300-313	321	2400-223	281
2200-537	209	2300-315	321	2400-225	282
2200-538	209	2300-328	317	2400-226	280, 281, 282
2200-539	209	2300-378	320	2400-227	281, 282
2200-540	207	2300-384S	320	2400-229	280
2200-542	207	2300-388S	320	2400-230	280
2200-544	207	2300-390S	320	2400-231	280, 281
2200-546	209	2300-394S	320	2400-232	280, 281
2200-547	209	2300-396S	320	2400-247	291
2200-548	209	2300-481	324	2400-248	291
2200-550	208	2300-0496	331	2400-259	291
2200-554	209	2300-0497	331	2400-281	291

2400-286	287	2405-326	296	2700-501	232
2400-287	287	2405-327	296	2700-502	232
2400-314	287	2405-824	296	2700-504	235
2400-315	287	2405-824S	296	2700-810	203
2400-316	287	2405-826	296	2700-812	203
2400-324	296	2405-827	296	2700-814	203
2400-324S	296	2500-096	56	2700-815	203
2400-326	296	2500-131	52	2700-817	203
2400-327	296	2500-131L	52	2700-819	203
2400-346	286	2500-206	55	2700-862NS	202
2400-349	286	2500-207	55	2700-864NS	202
2400-360	119	2500-208	55	2700-900	200
2400-362	119	2500-336	59	2700-902	200
2400-364	117	2500-340	60	2700-902F	200
2400-366	117	2500-345	60	2700-903NS	200
2400-374	304	2500-347T	60	2700-905	200
2400-375	304	2500-349	60	2700-906	200
2400-376	304	2600-092	70	2700-908NS	200
2400-377	304	2600-093	70	2700-915	201
2400-379	304	2600-094	70	2700-918	200
2400-381	304	2600-302	194	2700-920	201
2400-383	304	2600-311	194	2700-922	201
2400-383S	304	2600-391	191	2700-924NS	201
2400-385	304	2600-392	191	2700-925	201
2400-433	303	2600-525	621	2700-930	202
2400-438	303	2600-714	315	2700-947	202
2400-439	303	2600-716	315	2700-959	202
2400-440	303	2600-725	316	2700-995	202
2400-442	303	2600-730	324	2700-995NS	202
2400-701	280	2600-745	319	2700-5251	308
2400-702	280	2600-747	319	2700-5271	308
2400-703	280	2600-749	319	2700-5331	308
2400-704	280	2600-751	319	2700-5341	308
2400-706	280	2600-755	319	2700-5351	308
2400-708	280	2600-757	319	2700-5371	308
2400-710	120	2600-759	319	2700-5411	308
2400-712	120	2600-761	319	2700-5431	308
2400-714	301	2600-916	621	2700-5451	308
2400-733	303	2600-0921	70	2700-5471	308
2400-739	303	2600-0922	70	2901-060	597
2400-753	302	2600-0923	70	2901-062	597
2400-755	302	2600-0924	70	2901-064	597
2400-756	302	2600-0925	70	2901-066	597
2400-757	302	2600-0931	70	2901-070	599
2400-797	289	2600-0932	70	2901-072	599
2400-812A	288	2600-0933	70	2901-074	599
2400-813A	288	2600-0934	70	2901-076	599
2400-814A	288	2600-0935	70	2901-078	599
2400-815A	288	2600-0936	70	2901-080	599
2400-823	296	2600-0937	70	2901-082	599
2400-823S	296	2600-0941	70	2901-084	599
2400-824	296	2600-0942	70	2901-086	599
2400-824S	296	2600-0943	70	2901-090	596
2400-826	296	2600-0944	70	2901-092	596
2400-827	296	2600-0945	70	2901-094	596
2400-827S	296	2600-0946	70	2901-096	596
2400-865	117	2600-0947	70	2901-098	596
2400-867	117	2695-105	597	2901-101	600
2400-920	283	2700-309	258	2901-101L	600
2400-922	283	2700-310	246	2901-102	600
2400-924	283	2700-312	246	2901-102L	600
2400-926	283	2700-314	246	2901-103	600
2400-928	283	2700-320	246	2901-103L	600
2400-3751	304	2700-390	260	2901-104	601
2405-324	296	2700-392	260	2901-104L	601
2405-324S	296	2700-394	260	2901-105	601

2901-105L	601	2901-212	603	2901-234	605
2901-106	601	2901-212L	603	2901-234L	605
2901-106L	601	2901-212S	603	2901-234S	605
2901-107	601	2901-213	603	2901-235	605
2901-107L	601	2901-213L	603	2901-235L	605
2901-108	601	2901-213S	603	2901-235S	605
2901-108L	601	2901-214	603	2901-236	605
2901-109	601	2901-214L	603	2901-236L	605
2901-109L	601	2901-214S	603	2901-236S	605
2901-111	614	2901-215	603	2901-237	606
2901-111L	614	2901-215L	603	2901-237L	606
2901-111S	614	2901-215S	603	2901-237S	606
2901-113	614	2901-216	603	2901-238	606
2901-113L	614	2901-216L	603	2901-238L	606
2901-113S	614	2901-216S	603	2901-238S	606
2901-115	608	2901-217	603	2901-239	606
2901-115L	608	2901-217L	603	2901-239L	606
2901-115S	608	2901-217S	603	2901-239S	606
2901-117	608	2901-218	603	2901-240	606
2901-117L	608	2901-218L	603	2901-240L	606
2901-117S	608	2901-218S	603	2901-240S	606
2901-121	608	2901-219	603	2901-241	606
2901-121L	608	2901-219L	603	2901-241L	606
2901-121S	608	2901-219S	603	2901-241S	606
2901-123	608	2901-220	604	2901-242	606
2901-123L	608	2901-220L	604	2901-242L	606
2901-123S	608	2901-220S	604	2901-242S	606
2901-125	608	2901-221	604	2901-243	606
2901-125L	608	2901-221L	604	2901-243L	606
2901-125S	608	2901-221S	604	2901-243S	606
2901-127	608	2901-222	604	2901-244	607
2901-127L	608	2901-222L	604	2901-244L	607
2901-127S	608	2901-222S	604	2901-244S	607
2901-129	608	2901-223	604	2901-245	607
2901-129L	608	2901-223L	604	2901-245L	607
2901-129S	608	2901-223S	604	2901-245S	607
2901-131	608	2901-224	604	2901-246	607
2901-131L	608	2901-224L	604	2901-246L	607
2901-131S	608	2901-224S	604	2901-246S	607
2901-201	615	2901-225	604	2901-247	607
2901-201L	615	2901-225L	604	2901-247L	607
2901-201S	615	2901-225S	604	2901-247S	607
2901-202	615	2901-226	604	2901-248	607
2901-202L	615	2901-226L	604	2901-248L	607
2901-202S	615	2901-226S	604	2901-248S	607
2901-203	615	2901-227	604	2901-249	607
2901-203L	615	2901-227L	604	2901-249L	607
2901-203S	615	2901-227S	604	2901-249S	607
2901-204	615	2901-228	604	2901-250	607
2901-204L	615	2901-228L	604	2901-250L	607
2901-204S	615	2901-228S	604	2901-250S	607
2901-205	615	2901-229	605	2901-252	609
2901-205L	615	2901-229L	605	2901-252L	609
2901-205S	615	2901-229S	605	2901-252S	609
2901-206	615	2901-230	605	2901-254	609
2901-206L	615	2901-230L	605	2901-254L	609
2901-206S	615	2901-230S	605	2901-254S	609
2901-207	615	2901-231	605	2901-260	610
2901-207L	615	2901-231L	605	2901-260L	610
2901-207S	615	2901-231S	605	2901-260S	610
2901-208	615	2901-232	605	2901-261	610
2901-208L	615	2901-232L	605	2901-261L	610
2901-208S	615	2901-232S	605	2901-261S	610
2901-211	603	2901-233	605	2901-262	610
2901-211L	603	2901-233L	605	2901-262L	610
2901-211S	603	2901-233S	605	2901-262S	610

2901-263	612	2901-303L	602	26950-05	622
2901-263L	612	2901-303S	602	SC94-0312	359
2901-263S	612	2901-304	602	SC94-0313	359
2901-264	610	2901-304L	602	SC94-0314	359
2901-264L	610	2901-304S	602	SC94-0315	359
2901-264S	610	2901-305	602	SC94-0316	359
2901-265	610	2901-305L	602	SC94-0317	359
2901-265L	610	2901-305S	602	SC94-0318	359
2901-265S	610	2901-306	602	SC94-0319	359
2901-266	610	2901-306L	602	SC94-0320	359
2901-266L	610	2901-306S	602	SC94-0321	359
2901-266S	610	2901-307	602	SC94-0322	359
2901-267	611	2901-307L	602	SC94-03157	359
2901-267L	611	2901-307S	602	SC94-03158	359
2901-267S	611	2901-308	602	SC94-03159	359
2901-268	611	2901-308L	602	SC95-0315	361
2901-268L	611	2901-308S	602	SC95-0420	360, 361
2901-268S	611	2901-309	602	SC95-0421	360, 361
2901-269	612	2901-309L	602	SC95-0422	360, 361
2901-269L	612	2901-309S	602	SC95-0423	360, 361
2901-269S	612	2901-311	614	SC95-0424	360
2901-270	612	2901-311L	614	SC95-0425	360
2901-270L	612	2901-311S	614	ST52	14
2901-270S	612	2901-312	614	ST75	14
2901-271	612	2901-312L	614	ST83	12
2901-271L	612	2901-312S	614	ST83-2	12
2901-271S	612	2901-313	614	ST100	14
2901-272	612	2901-313L	614	ST106	14
2901-272L	612	2901-313S	614	ST107	14
2901-272S	612	2901-314	614	ST148	14
2901-273	612	2901-314L	614	ST170-0	12
2901-273L	612	2901-314S	614	ST170-2	12
2901-273S	612	2901-315	614	ST952	12
2901-274	612	2901-315L	614	ST952D-2	12
2901-274L	612	2901-315S	614	ST953	12
2901-274S	612	2901-321	609	ST1311-2	13
2901-275	611	2901-321L	609	ST2000-2	13
2901-275L	611	2901-321S	609	STE12104	13
2901-275S	611	2901-322	609	STE20124	13
2901-276	612	2901-322L	609	STE20126	13
2901-276L	612	2901-322S	609	STP12102	13
2901-276S	612	2901-323	609	STP12104	13
2901-277	612	2901-323L	609	STP20122	13
2901-277L	612	2901-323S	609	STP20124	13
2901-277S	612	2901-324	609		
2901-278	612	2901-324L	609		
2901-278L	612	2901-324S	609		
2901-278S	612	2901-330	613		
2901-279	611	2901-331	613		
2901-279L	611	2901-334	613		
2901-279S	611	2901-335	613		
2901-280	611	2901-336	613		
2901-280L	611	2901-337	613		
2901-280S	611	2901-340	613		
2901-281	598	2901-341	613		
2901-281-25	598	2901-350	598		
2901-281-40	598	9B-010	21		
2901-281-45	598	9B-020	21		
2901-281-60	598	9B-025	21		
2901-301	602	20925-53	622		
2901-301L	602	20925-56	622		
2901-301S	602	20928-51	622		
2901-302	602	20928-53	622		
2901-302L	602	20945-01	622		
2901-302S	602	20945-03	622		
2901-303	602	20945-04	622		

**A**

Aderer Wire Bending Pliers	548
Adson Bipolar Forceps	200
Adson Harris Ring Tip Forceps	198
Adson-Harris Ring Tip Forceps Titanium	194
Adson Periosteal Elevator	512
Adson Suction	260
Adson Tissue Forceps	195
Adson Tissue Forceps Titanium	193, 194
Adson Tissue Smooth Platform Forceps	196
Adson Tissue TC Dust Platform Forceps	196
Adson Tissue TC Serrated Platform Forceps	197
Air Injection Cannula	103
Algerbrush II Corneal Rust Ring Remover Burr	95
Algerbrush II Pterygium Burr	95
Allen Inge Stifle Retractor	403
Alligator Forceps Tubular Shaft	498
Allis Tissue Forceps	225

Alm Retractor	58, 84
Andrews Pynchon Suction	258
Angled Insulated Metal Handle	597
Anthony Suction	258
AO Type Bending Pliers Set	552
A.O. Type Universal Screw Driver	557
AO Type Universal Screwdriver Set	559
Arkansas Sharpening Stone	174
Arthroscopic	349
Arthroscopic Biopsy & Grasping Rongeur	348
Arthroscopic Crocodile Grasping Forceps	366
Arthroscopic Curette & Ring Curette	354
Arthroscopic Dilation Needle	360
Arthroscopic Grasping & Biopsy Combo Rongeur Forceps	499
Arthroscopic Hook Probe	355
Arthroscopic Hook Probe with Conical Handle	355
Arthroscopic Hook Punch	346
Arthroscopic Meniscotomes Hook	353
Arthroscopic Metzenbaum Hook Scissors	347
Arthroscopic Mini Scissors	349
Arthroscopic Mini Scissors Forceps Biopsy Grasping Forceps	349
Arthroscopic Punch Rongeur	351
Arthroscopic Punch & Scissors	350
Arthroscopic Rasp	355, 357
Arthroscopic Rottweiler Loosebody Grasping Forceps	367
Arthroscopic Switch Stick	359, 360
Arthroscopic Velociraptor Biopsy Forceps	369
Arthroscopic Velociraptor Junior Biopsy Forceps	369
Atraumatic Pediatric Vascular Clamp	64, 65, 66
Aufranc Cobra Retractor	409
Avian Micro Set	621
Avian Mini Wire Passer	563
Awl	
Daniel Nasal Awl	146
Liska Awl	147
Axel Wire Twister	581
Axial Handle	599
Axial Ring Handle	599
Azar Corneal Scissors	126

**B**

Babcock Tissue Forceps	223
Baby Farabeuf Retractor	57
Baby Finochietto Retractor	53
Baby GOLD-CUT HERCULES® Pin Cutter	573
Baby Poole Suction	260
Baby Stratte Scissors	123
Backhaus Towel Forceps	227, 228
Bailey Hemostatic Acute Angle Forceps	209
Bainbridge Forceps	214
Balfour Malleable Blade	48
Balfour Retractor	49
Ballenger Bayonet Swivel Knife	34
Ballenger Swivel Knife	34

Bane Single Action Rongeur	464
Barnhill Adenoid Curette	452
Barraquer Cilia Forceps	110
Barraquer Needle Holder	328
Barraquer Wire Speculum	86, 88
Barraquer Wire Speculum Third Eye Lid	87
Barr Double Ended Probe	153
Barr Fistula Probe	153
Barrier Wrap	
Sontec Instrument Fabric Barrier Wrap 2Ply	15
Basic Ophthalmic Set	620
Basic Orthopedic Set	620
Baylor Tactile Tone Periodontal Probe	173
Beasley-Babcock Tissue Forceps	196
Beaver Blade Chuck Handle #3K	25
Beaver Blade Chuck Handle #3KD	25
Bender	
Sontec Pin Driver / Bender	543
Vickers Easy Driver / Bender / Puller	544
Billeau Ear Loop/Curette	447
Bio-Met Type Wire Twister	584
Bio-Met Wire Twister	584
Biopsy	
Arthroscopic Biopsy & Grasping Rongeur	348
Biopsy Cup Working Part	614
Biopsy & Grasping Rongeur Forceps	349
Bipolar Bayonet Suction Wide Grip Forceps	203
Bipolar Dissector	622
Bipolar Sontec Olsen-Hegar Deluxe Needle Holder	335
Bishop-Harmon 1x2 Tissue Forceps	108
Bishop-Harmon 1x2 Tissue Forceps Titanium	108
Bishop-Harmon Irrigation Bulb Cannula Set	102
Blade	
Balfour Malleable Blade	48
Blair Hook Retractor	148
Blair Skin Graft Knife	35
Blalock Aorta Clamp	80
Blumenthal Oral Surgery Rongeur	165
Blumenthal Rongeur	464
Boies Nasal Fracture Elevator	521
Bolts	
Lubra Stainless Steel Bolt	132
Stainless Steel Bolts	132
Bonaccolto Suture Forceps	110
Bone Clamp	
Kern Bone Clamp	421, 424
Kern Hybrid Bone Clamp	420
Ulrich Bone Clamp	423
Verbrugge Bone Clamp	422
Verbrugge-Rogalski Bone Clamp	420
Bone Forceps	
Sequestrum Sontec Bone Forceps	426
Bone Grinder	154
Bone Grinder	154
Bone Holding Forcep	
Stefan Bone Holding Forcep	426
Bone Pick Micro Fracture	357
Bone Reduction Clamp	437
Schroeder Vulsellum Bone Reduction Clamp	435

Bone Reduction Forceps	
Plate & Bone Reduction Forceps	436
Bone Tamp	
Pin Driver & Bone Tamp	543
Bonney Tissue Forceps	192
Bonn Scissors	118
Bowl	
Sponge Bowl	14
Bowman Lacrimal Probe	98
Boynton Needle Holder	326
Bracken 1x2 Fixation Forceps	113
Brass Head Mallet	528
Braun-Ralph Suction	258
Brown Adson Tissue Forceps Titanium	194
Brown Forceps	198
Brown Tissue Forceps	186
Bruns Hexagonal Handle Curette	442
Bruns Oval Cup Curette	441
Bruns Round Cup Curette	440
Bruns Solid Hexagonal Curette	442
Brush	
Whisk 'R Brush	21
Buck Ear Curette Hex Handle	451
Buck Ear Round Handle Curette	450
Buck Myringotomy Knife	32
Buie Fistula Probe	153
Buie Pile Clamp Forceps	225
Buie Suction Tube	257
Bunge Evisceration Spoon	94
Bunt Forceps Holder Ring	17
Burr	
Algerbrush II Corneal Rust Ring Remover Burr	95
Algerbrush II Pterygium Burr	95
Virginia Roaring Burr Long	143
Virginia Roaring Burr Short	142

**C**

Cable	
Monopolar Cable	597
Caliper	
Castroviejo Caliper	38
Jameson Caliper	39
Orthopedic Vernier Caliper	40
Thorpe Caliper	39
Canine Spay Set	620
Cannula	
Air Injection Cannula	103
Egress Cannula Set	358, 359
Fasanella Lacrimal Cannula	103
Lacrimal Cannula	103
McIntyre Lacrimal Cannula	103
Severin Lacrimal Cannula	103
Shaninian Lacrimal Cannula	103
Small Joint Arthroscopic Cannula	360
Stainless Steel Feeding & Dosing Cannula	139
West Cannula	103
Carrier	
Eyebrow Lifting Ligature Carrier	383
Facia Ligature Carrier	383
Sanders Brown Ligature Carrier	383
Cartilage Cutting Block/Titanium	155
Caspar Grasping Rongeur	484
Cassio Ligature Carrier	380

Castaneda Enucleation Clamp Forceps . . . 96  
 Castroviejo Caliper . . . . . 38  
 Castroviejo Corneal Scissors . . . . . 126  
 Castroviejo Corneoscleral Scissors . . . 124  
 Castroviejo Equine Eye Speculum . . . . . 88  
 Castroviejo Keratoplasty & Keratectomy Wide Handle Scissors . . . . . 126  
 Castroviejo Keratoplasty Scissors . . . . . 126  
 Castroviejo Lacrimal Dilator . . . . . 95, 99  
 Castroviejo Needle Holder . . . . . 325, 329  
 Castroviejo Needle Holder with Scissors. 340  
 Castroviejo Suture 1x2 Teeth Forceps . . 108  
 Catheter Tray & Dome Lid Cover . . . . . 12  
 Ceramitec Stevens Tenotomy Ergonomic Spread Handle Power Cut Black® Scissors . . . . . 116  
 Cerclage Double Torpedo Type Wire Twister. 585  
 Cerclage Torpedo Type Wire Twister . . 583  
 Cerclage Wire . . . . . 136  
 Chisel Edge EX-16 Dental Elevator. . . . 162  
 Chuck  
     Sontec Hybrid I.M. Pin Chuck . . . . . 504  
     Sontec I.M. Pin Chuck . . . . . 504  
 Chuck Handle  
     Beaver Blade Chuck Handle #3K. . . . . 25  
     Beaver Blade Chuck Handle #3KD. . . . 25  
 Cicherelli Rongeur . . . . . 463  
 Cilia Forceps . . . . . 110  
 Cinelli lower lateral Scissors. . . . . 122  
 Clamp . . . . . 226  
     Atraumatic Pediatric Vascular Clamp . . 64, 65, 66  
     Blalock Aorta Clamp . . . . . 80  
     Bone Reduction Clamp . . . . . 437  
     Buie Pile Clamp Forceps. . . . . 225  
     Castaneda Enucleation Clamp Forceps . . 96  
     Cooley Anastomosis Clamp . . . . . 67  
     Cooley Multi-Purpose Clamp . . . . . 68  
     Cooley Neonatal Cardiovascular Clamp . . 76  
     DeBakey Bulldog Clamp . . . . . 71  
     DeBakey-Derra Anastomosis Clamp. . . 79  
     DeBakey Meniscus Clamp . . . . . 590  
     DeBakey Neonatal Cardiovascular Clamp . . 77  
     DeBakey-Satinsky Clamp . . . . . 78  
     Dietrich Micro Bulldog Clamp . . . . . 72  
     Ferguson Tenaculum Clamp Forceps. . . 224  
     Glover-Cooley Bulldog Clamp. . . . . 69  
     Ikuta Bone Clamp . . . . . 434  
     John Hopkins Bulldog Clamp . . . . . 74  
     Laparoscopic Bulldog Clamp . . . . . 598  
     Micro Sontec Vena Clava Satinsky-Glover Bulldog Clamp . . . . . 70  
     Microvascular Clamp. . . . . 73  
     Mini Glover (Weldon) Bulldog Clamp . . 69  
     Patella 2 x 2 Prong Bone Clamp . . . . . 420  
     Scudder Intestinal Clamp . . . . . 138  
     Serrefine Bulldog Clamp . . . . . 74  
     Sontec Delicate Meniscus Clamp . . . . . 589  
     Sontec Meniscus Clamp . . . . . 589  
     Sontec Mesh Meniscus Clamp . . . . . 591  
     Strong Aortic Clamp . . . . . 80  
     Universal Microvascular Clamp. . . . . 72  
     Vorse Tube Occluding Clamp . . . . . 81  
     Weldon Bulldog Artery Clamp Titanium . . . . . 70  
         Weldon Bulldog Vein Clamp Titanium. . 70  
     Clamp Insert . . . . . 607  
     Classic Bayonet Dental Rodent Rasp . . 176  
     Classic Lempert Rongeur . . . . . 461  
     Cleft Palate Elevator . . . . . 523  
     Cleveland Rongeur . . . . . 463  
     Cloward Dura Hook . . . . . 235  
     Coakley Antrum Curette . . . . . 453  
     Coaptation Bipolar Forceps . . . . . 202  
     Colibri Forceps . . . . . 107  
     Coller-Crile Forceps . . . . . 215  
     Combination Bone Rasp. . . . . 392  
     Commander Utility Shears . . . . . 272  
     Cone Ring Curette . . . . . 443  
     Converse Daniel Scissors. . . . . 300  
     Converse Wilmer Scissors . . . . . 301  
     Cooley Anastomosis Clamp . . . . . 67  
     Cooley and DeBakey Neonatal Cardiovascular Clamp . . . . . 75  
     Cooley Multi-Purpose Clamp . . . . . 68  
     Cooley Neonatal Cardiovascular Clamp . . 76  
     Cottle Bone Saw . . . . . 377  
     Cottle Daniel Raspatory/Packer . . . . . 522  
     Cottle Double Skin Hook . . . . . 150  
     Cottle Elevator. . . . . 521  
     Cottle Mallet . . . . . 529  
     Cottle Mucosa Knife . . . . . 31  
     Cottle Plastic Osteotome . . . . . 533  
     Cottle Skin Hook . . . . . 151  
     Cottle Skin Hook Titanium . . . . . 151  
 Cover  
     Stainless Steel Instrument Tray, Lid Cover & Perforated Nesting Sterilization Instrument Tray. . . . . 13  
     Tip Cover . . . . . 18  
 Covers  
     Catheter Tray & Dome Lid Cover. . . . . 12  
     Crile Forceps. . . . . 216  
     Crile-Wood Needle Holder . . . . . 320  
     Cronin Cleft Palate Elevator / Dissector . 523  
     Crossley Molar Luxator . . . . . 179  
     CSU Adolescent Balfour Retractor. . . . . 47  
     CSU Cottle Elevator . . . . . 521  
     CSU Meniscus Clamp. . . . . 588  
     CSU Pediatric Balfour Retractor . . 44, 45, 46  
     Culler Lens Spoon . . . . . 94  
     Culler Neuro Round Handle Hook . . . . . 233  
     Cup Insert . . . . . 608, 611  
 Curette  
     Arthroscopic Curette & Ring Curette. . . 354  
     Barnhill Adenoid Curette . . . . . 452  
     Billeau Ear Loop/Curette . . . . . 447  
     Bruns Hexagonal Handle Curette . . . . . 442  
     Bruns Oval Cup Curette. . . . . 441  
     Bruns Round Cup Curette. . . . . 440  
     Bruns Solid Hexagonal Curette . . . . . 442  
     Buck Ear Curette Hex Handle . . . . . 451  
     Buck Ear Round Handle Curette. . . . . 450  
     Coakley Antrum Curette . . . . . 453  
     Cone Ring Curette . . . . . 443  
     Dental Scaler/Curette. . . . . 173  
     Frontal Sinus Curette . . . . . 449  
     Hatt Spoon Curette . . . . . 443  
     House Curette . . . . . 448  
     Lingual Curette. . . . . 171  
     Martini Bone Curette . . . . . 447  
     Meyerhoefer-Chalazion Curette. . . . . 446  
     Rhoton Curette . . . . . 240  
     Shapleigh Ear Curette . . . . . 446  
     Sickle/Curette Combinations. . . . . 171  
     Sontec® Excavator Curette. . . . . 449  
     Stille Curette. . . . . 440  
     Tholl Curette . . . . . 449  
     Vogel Infant Adenoid Curette . . . . . 452  
     Williger Curette . . . . . 447  
 Cushing Bipolar Forceps . . . . . 202  
 Cushing Dura Hook . . . . . 235  
 Cushing Pituitary Rongeur . . . . . 483  
 Cushing Rongeur . . . . . 465  
 Cutter  
     Large Pin / Bolt Cutter . . . . . 570  
     Micro Double Action Wire Cutter. . . . . 574  
     Rod Cutter . . . . . 576  
     Rod Flush Cutter . . . . . 576  
 Cutting Block  
     Cartilage Cutting Block Titanium . . . . . 155  
     Sontec Corneal Cutting Block. . . . . 94

**D**

Daniel Endoscopic Forehead Elevator . . 247  
 Daniel-Gubisch Raspatory/Rasp . . . . . 522  
 Daniel Nasal Awl . . . . . 146  
 Davis Gallstone Scoop . . . . . 154  
 Davis Stifle Retractor . . . . . 403  
 DeBakey-Adson Tissue Forceps . . . . . 195  
 DeBakey Angled Tissue Forceps . . . . . 185  
 DeBakey Bulldog Clamp. . . . . 71  
 DeBakey-Derra Anastomosis Clamp . . . . 79  
 DeBakey Ergonomic-Handle Forceps . . 186  
 DeBakey Meniscus Clamp . . . . . 590  
 DeBakey Mosquito Forceps . . . . . 590  
 DeBakey Needle-Pulling Tissue Forceps. 185  
 DeBakey Neonatal Cardiovascular Clamp. 77  
 DeBakey-Satinsky Clamp . . . . . 78  
 DeBakey Tissue Forceps . . . . . 184  
 Decker Micro Rongeur . . . . . 488  
 Deluxe Balfour Retractor. . . . . 48  
 Deluxe Rodent Dental Set. . . . . 620  
 Dental Corn Forceps. . . . . 168  
 Dental Elevator Set Classic Handle . . . 161  
 Dental Luxating Elevator Short Handle . 162  
 Dental Micro Fragment Forceps. . . . . 167  
 Dental Periosteal Elevator. . . . . 164  
 Dental Root Tip Elevator. . . . . 158  
 Dental Scaler. . . . . 173  
 Dental Scaler/Curette . . . . . 173  
 Depth Gauge. . . . . 144  
 Depth Gauge EZ Clean. . . . . 145  
 Derf Needle Holder. . . . . 314  
 Derf Needle Holder Titanium . . . . . 315  
 Deschamps Ligature Carrier. . . . . 382  
 Desmarres Chalazion Clamp Forceps . . 112  
 Desmarres Lid Retractor . . . . . 90  
 Desmarres Lid Retractor Autoclavable Plastic . 91  
 Desmarres Lid Retractor Titanium . . . . . 91  
 Desmarres Severin Chalazion Clamp Forceps . . . . . 112  
 Dietrich Micro Bulldog Clamp. . . . . 72  
 Dilation Needle . . . . . 360  
 Dilator  
     Castroviejo Lacrimal Dilator. . . . . 95,  
     99  
     French Lacrimal Dilator . . . . . 99  
     Infant Lacrimal Dilator . . . . . 99  
     Muldoon Lacrimal Dilator. . . . . 99  
     Pigtail Lacrimal Probe Dilator . . . . . 99  
     Wilder Lacrimal Dilator. . . . . 99  
 Dissecting Forceps Insert. . . . . 609  
 Dissector  
     Bipolar Dissector . . . . . 622  
     Cronin Cleft Palate Elevator / Dissector . 523  
     Martinez Corneal Dissector . . . . . 95  
     Masing Elevator / Dissector. . . . . 518  
     Rhoton Circular Dissector 45° . . . . . 238  
     Rhoton Dissector / Raspatory . . . . . 238, 239  
     Rosen Circular Blade Dissector. . . . . 32  
     Sontec-Masing Septal Dissector. . . . . 518  
 Distractor  
     Foremann Kwire Distractor . . . . . 406  
     Mini Foremann Distractor . . . . . 406  
 Distractor, Foremann Kwire. . . . . 406  
 Doolen Bone Holding Clamp . . . . . 427  
 Doolen Neuro Hook . . . . . 232  
 Double Action Wire Cutter . . . . . 568, 574  
 Double-ended Dental Explorer. . . . . 170  
 Double-ended Dental Explorer/Probe  
     Combination . . . . . 170  
 Double-ended Endodontic . . . . . 170  
 Double-Ended Rasp . . . . . 386  
 Doyen Classic Model Power Cut Gold® Scissors . . . . . 298  
 Doyen-DeBakey Intestinal Clamp Forceps . 222  
 Doyen Intestinal Clamp Forceps . . . . . 223  
 Doyen-Kocher Intestinal Forceps . . . . . 221  
 Drill Guide  
     Universal Drill Guide . . . . . 507  
 Driver  
     K-Wire Pin Driver . . . . . 506  
     Piermattei Pin Bender / Driver . . . . . 542  
     Vickers Easy Driver / Bender / Puller. . . 544  
 Durrani Dorsal Vein Complex Ligation Needle . 380

**E**

Egress Cannula Set . . . . . 358, 359  
 Electro Blue Coated Skinner Tissue Forceps . 189  
 Electrode  
     Hook Electrode . . . . . 622  
 Elevator  
     Adson Periosteal Elevator . . . . . 512  
     Boies Nasal Fracture Elevator. . . . . 521  
     Chisel Edge EX-16 Dental Elevator . . . 162  
     Cleft Palate Elevator. . . . . 523  
     Cottle Elevator . . . . . 521  
     Cronin Cleft Palate Elevator / Dissector . 523  
     CSU Cottle Elevator. . . . . 521  
     Daniel Endoscopic Forehead Elevator . . 247  
     Dental Elevator Set Classic Handle. . . . 161  
     Dental Luxating Elevator Short Handle. 162  
     Dental Periosteal Elevator . . . . . 164  
     Dental Root Tip Elevator . . . . . 158  
     Elevator With Suction . . . . . 246  
     Freer Elevator / Mucosa Knife Round Handle 4.5 mm. . . . . 520  
     Freer Elevator / Packer . . . . . 520  
     Freer Periosteal Elevator . . . . . 510, 511, 512  
     Gubisch Suction Elevator . . . . . 247  
     Hirschfeld Periosteal Dental Elevator . . 163  
     Hoen Periosteal Elevator . . . . . 513  
     House Ear Elevator . . . . . 520  
     Joseph Masing Elevator . . . . . 520  
     Joseph Periosteal Elevator . . . . . 518  
     Killian Elevator . . . . . 518  
     Lane Periosteal Elevator . . . . . 513  
     Langenbeck Periosteal Elevator . . . . . 513  
     Love Adson Periosteal Elevator. . . . . 512  
     Masing Elevator / Dissector. . . . . 518  
     Maxillary Ostium Elevator / Probe . . . . 522  
     McDonald Elevator. . . . . 519  
     McKenty Elevator. . . . . 519  
     Molt Periosteal Dental Elevator . . . . . 164  
     Nelms Suction Elevator . . . . . 246  
     Ostium Burnisher Elevator. . . . . 523  
     Pennington Elevator . . . . . 520  
     Periosteal Elevator. . . . . 163  
     Roger Elevator. . . . . 519  
     Sesamoid Cottle Elevator . . . . . 521  
     Slimline Back Bent Elevator. . . . . 158  
     Sontec® Septum Elevator / Probe . . . . 522  
     Sontec A O Type Elevator / Raspatory . . 514, 515  
     Sontec Cottle Elevator. . . . . 521  
     Sontec Lane Lever Elevator. . . . . 417  
     Sontec S.P.T. Elevator . . . . . 519  
     Warwick James Root Elevator. . . . . 158  
     Winged Dental Elevator Set Classic Handle . 160, 161  
     Winged Dental Elevator Set Short Handle . 160  
     Woodson Elevator . . . . . 518  
 Elevator With Suction . . . . . 246  
 Emasculator  
     Reimer Emasculator . . . . . 134  
     Serra Modified Emasculator . . . . . 134  
 Embertson Esophageal Epiglottis Scissors . 135  
 End Cutter  
     Pin End Cutter . . . . . 571  
 Endodontic  
     Double-ended Endodontic . . . . . 170  
 End Pin Cutter . . . . . 567  
 Entner Ligature Carrier . . . . . 382  
 Enucleation Scissors . . . . . 96, 123  
 Equine Epiglottis Entrapment Knife . . . 133  
 Ergonomic Highly Rigid Plastic Ring Handle. 596  
 Esophageal Epiglottis Hook Scissors . . 135  
 Evans Tissue Forceps. . . . . 188  
 Explorer  
     Double-ended Dental Explorer . . . . . 170  
     Double-ended Dental Explorer/Probe  
     Combination. . . . . 170  
 Expressor  
     Rizzuti Iris Retractor & Lens Expressor. 84  
 Extended Ophthalmic Set. . . . . 620  
 External Fixator TPLO Set. . . . . 138  
 Eyebrow Lifting Ligature Carrier. . . . . 383  
 Eye Scissors . . . . . 300

**F**

Facia Ligature Carrier . . . . . 383  
 Farabeuf Retractor . . . . . 57  
 Fasanella Lacrimal Cannula . . . . . 103  
 Feline Spay Set. . . . . 620  
 Ferguson Gallstone Scoop. . . . . 154  
 Ferguson Tenaculum Clamp Forceps . . 224  
 Ferlit Micro Forceps . . . . . 192  
 Ferris-Smith Arthroscopic Rongeur. 485, 486  
 Ferris-Smith Rongeur . . . . . 487  
 Ferris-Smith Spinal Extended Shaft Rongeur . 488  
 Ferris-Smith Wilde Rongeur . . . . . 487  
 Finochietto-Baby-Haight Rib Spreader Retractor. . . . . 52  
 Finochietto Retractor. . . . . 54, 61  
 Finochietto Rib Spreader Retractor . . . . 56  
 Fisher Tonsil Knife. . . . . 31  
 Flieringa Scleral Fixation Ring . . . . . 102  
 Foerster Sponge Forceps . . . . . 226  
 Foman TC Insert Rasp . . . . . 387  
 Fomon Lateral Scissors . . . . . 122  
 Fomon Rasp . . . . . 387  
 Fomon Scissors . . . . . 122  
 Forceps . . . . . 349  
     Adson Bipolar Forceps . . . . . 200  
     Adson Harris Ring Tip Forceps . . . . . 198  
     Adson-Harris Ring Tip Forceps Titanium . 194  
     Adson Tissue Forceps . . . . . 195  
     Adson Tissue Forceps Titanium . . . . . 193, 194  
     Adson Tissue Smooth Platform Forceps . 196  
     Adson Tissue TC Serrated Platform Forceps . . . . . 197  
     Alligator Forceps Tubular Shaft . . . . . 498  
     Allis Tissue Forceps. . . . . 225  
     Arthroscopic Crocodile Grasping Forceps . 366  
     Arthroscopic, Forceps, Biopsy & Grasping Rongeur Forceps . . . . . 349  
     Arthroscopic Grasping & Biopsy Combo Rongeur Forceps . . . . . 499  
     Arthroscopic Rottweiler Loosebody Grasping Forceps . . . . . 367  
     Arthroscopic Velociraptor Biopsy Forceps . 369  
     Arthroscopic Velociraptor Junior Biopsy Forceps . . . . . 369  
     Babcock Tissue Forceps. . . . . 223  
     Backhaus Towel Forceps. . . . . 227, 228  
     Bailey Hemostatic Acute Angle Forceps . 209  
     Bainbridge Forceps . . . . . 214  
     Barraquer Cilia Forceps. . . . . 110  
     Beasley-Babcock Tissue Forceps. . . . . 196  
     Bipolar Bayonet Suction Wide Grip Forceps . . . . . 203  
     Bishop-Harmon 1x2 Tissue Forceps. . . 108  
     Bishop-Harmon 1x2 Tissue Forceps Titanium . . . . . 108  
     Bonaccolto Suture Forceps. . . . . 110  
     Bonney Tissue Forceps . . . . . 192  
     Bracken 1x2 Fixation Forceps. . . . . 113  
     Brown Adson Tissue Forceps Titanium . . 194  
     Brown Forceps. . . . . 198



Yasargil Arachnoid Knife . . . . .	33
Yasargil Bayonet Arachnoid Knife Titanium . . . . .	33
Knife Handle	
Knife Handle #3. . . . .	24
Knife Handle #3KL . . . . .	25
Knife Handle #3L . . . . .	25
Knife Handle #3 . . . . .	24
Knife Handle #3KL . . . . .	25
Knife Handle #3L . . . . .	25
Knives	
Sickle Knife . . . . .	31
Knot Pusher . . . . .	598
Knowles Bandage Scissors . . . . .	270
Kocher Forceps. . . . .	220
Krayenbuehl Nerve Hook . . . . .	232
Krayenbuehl Nerve Hook Extra Long Version . . . . .	232
K-Wire Pin Driver . . . . .	506
<b>L</b>	
Lacrimal Cannula . . . . .	103
LaGrange Scissors . . . . .	300
Lambotte Osteotome . . . . .	537
Lamina Spreader	
Inge Micro Ring Handle Lamina Spreader . . . . .	412
Lane Periosteal Elevator . . . . .	513
Langenbeck Metacarpal Saw . . . . .	376
Langenbeck Periosteal Elevator. . . . .	513
Laparoscopic Bulldog Clamp . . . . .	598
Laparoscopic Bulldog Clamp Forceps . . . . .	598
Large Pin / Bolt Cutter. . . . .	570
Large Sontec Combo Mallet. . . . .	529
Larry Fistula Probe . . . . .	153
Lateral Plate Bending Pliers . . . . .	553
Leksell Duckbill Rongeur . . . . .	469
Lester Fixation 1x2 Tissue Forceps. . . . .	109, 113
Lester Fixation Tissue Forceps. . . . .	109
Lever	
Sontec Stifle Thrust Lever . . . . .	409
Levesque Neuro Rongeur. . . . .	462
Lexer Osteotome. . . . .	538
Lid Cover & Perforated Nesting Sterilization Instrument Tray. . . . .	13
Ligature Carrier	
Cassio Ligature Carrier . . . . .	380
Deschamps Ligature Carrier . . . . .	382
Entner Ligature Carrier . . . . .	382
Graft Passer Ligature Carrier. . . . .	381
Reverdin Needle/Ligature Carrier . . . . .	380
Schmieden-Dick Ligature Carrier . . . . .	382
Sontec Reverdin Blunt Needle/Ligature Carrier. . . . .	380
Tendon Passer Ligature Carrier. . . . .	381
Lincoln Dissecting Forceps . . . . .	207
Linderman Amputation Saw . . . . .	376
Lingual Curette . . . . .	171
Liska Awl . . . . .	147
Lister Bandage Scissors. . . . .	269
Liston Bone Cutting Forceps . . . . .	372
Lockhart Mummery Fistula Probe . . . . .	152
Loop	
Billeau Ear Loop/Curette . . . . .	447
New Orleans Lens Loop . . . . .	94
Lorna-Edna Towel Forceps. . . . .	229
Loute Wire Twister. . . . .	584
Love Adson Periosteal Elevator . . . . .	512
Love Gruenwald Pituitary Rongeur. . . . .	483
Lubra Plates . . . . .	132
Lubra Screw Driver . . . . .	558
Lubra Stainless Steel Bolt. . . . .	132
Lubra Stainless Steel Nut Only . . . . .	131
Lubra Stainless Steel Washer Only . . . . .	131
Lubra Wrench . . . . .	131
Lucae Ear Hook . . . . .	234
Lukens Thymus Retractor. . . . .	149
Luxator	
Crossley Molar Luxator . . . . .	179
Rodent Incisor Luxator. . . . .	179
<b>M</b>	
Magnet	
Universal Magnet for Retrieval/ Demagnetizing . . . . .	142
Malleable Ribbon Retractor . . . . .	410
Mallet	
Brass Head Mallet . . . . .	528
Cottle Mallet. . . . .	529
Large Sontec Combo Mallet . . . . .	529
Mead Mallet . . . . .	528
Sontec Combo Nylon Mallet . . . . .	526
Sontec Double Nylon Mallet . . . . .	527
Sontec Micro Mallet. . . . .	527
Maltz Single-Ended Rasp. . . . .	390
Manhattan 1x2 Tissue Forceps. . . . .	113
Manhattan Severin 1x2 Tissue Forceps . . . . .	113
Martin Cartilage Clamp . . . . .	591
Martin Cartilage Tenotomy Classic Power Cut Gold Scissors . . . . .	298
Martinez Corneal Dissector. . . . .	95
Martini Bone Curette. . . . .	447
Masing Elevator / Dissector . . . . .	518
Mathieu Heavy Needle Holder . . . . .	327
Mathieu-Olsen Needle Holder . . . . .	341
Maxillary Ostium Elevator / Probe . . . . .	522
Mayo-Carroll Scissors. . . . .	282
Mayo Classic, Tungsten Carbide, Power Cut Gold, Power Cut Black, TC/PC Power Cut, Ceramic Coated Scissors . . . . .	281
Mayo-Harrington Scissors . . . . .	283
Mayo-Hegar Needle Holder . . . . .	317
Mayo-Hegar Needle Holder Titanium . . . . .	319
Mayo-Hegar Streamlined Needle Holder. . . . .	318
Mayo-Lexer Classic Power Cut Gold Power Cut Black TC/PC Power Cut Scissors . . . . .	282
Mayo-Lexer Fino Classic Tungsten Carbide Power Cut Gold Scissors. . . . .	281
Mayo Robson Forceps . . . . .	221
Mayo-Stille Classic, Tungsten Carbide, Power Cut Gold, Power Cut Black, TC/PC Power Cut, Ceramic Coated Scissors . . . . .	280
Mcdonald Elevator . . . . .	519
McGannon Retractor. . . . .	90
McGravey Tissue Forceps . . . . .	187
McIlwraith . . . . .	356
McIlwraith Arthroscopic Grasping Rongeur . . . . .	489
McIlwraith Arthroscopic Hook Probe . . . . .	356
McIlwraith Arthroscopic Scissors Rongeur . . . . .	491
McIlwraith Basket Cutter Rongeur . . . . .	490
McIlwraith Cup Rongeur. . . . .	481
McIlwraith-Peapod Rongeur . . . . .	491
McIlwraith Tendon Knife . . . . .	29
McIndoe Bone Cutting Forceps . . . . .	373
McIndoe Dressing and Tissue Forceps . . . . .	191
McIndoe Forceps Titanium. . . . .	191
McIntyre Lacrimal Cannula . . . . .	103
McKenty Elevator . . . . .	519
McNeill-Goldman Scleral Fixation Ring & Blepharostat . . . . .	102
McPherson Bipolar Forceps. . . . .	201
McPherson-Westcott Stitch Scissors . . . . .	125
Mead Mallet. . . . .	528
Medi-Mark™ Tape . . . . .	20
Meniscotome	
Arthroscopic Meniscotomes Hook, Probe & Knife . . . . .	353
Triangle Handle Arthroscopic Meniscotome, Hook, Probe & Knife . . . . .	352
Metzenbaum Ceramitec Power Cut® Scissors . . . . .	290
Metzenbaum Classic Model Scissors . . . . .	286
Metzenbaum Power Cut® Gold Scissors . . . . .	287
Metzenbaum Power Cut Black Scissors. . . . .	288, 289
Metzenbaum Power Cut Gold Scissors . . . . .	287
Metzenbaum Tungsten Carbide Power Cut® Gold/Black Scissors. . . . .	291
Meyerding Finger Retractor . . . . .	149
Meyerding Retractor . . . . .	411
Meyerhoefer-Chalazion Curette . . . . .	446
Michel Clips Applier Remover. . . . .	130
Micro Aneurysm Clamp Applier Forceps. . . . .	73
Micro Bone Reduction Clamp. . . . .	437
Micro Double Action Wire Cutter . . . . .	574
Micro Friedman Ring Handle Rongeur . . . . .	457
Micro Friedman Rongeur . . . . .	458
Micro Gerald Tissue Forceps . . . . .	186
Micro Hook Titanium. . . . .	235
Micro Lamina Spreader . . . . .	413
Micro Pedo Extracting Forceps . . . . .	168
Micro Sontec® Vena Clava Satinsky-Glover Bulldog Clamp . . . . .	70
Micro Tip Mixer Right Angle Forceps . . . . .	208
Microvascular Clamp . . . . .	73
Micro Weitlaner-Henley Retractor. . . . .	59
Miller Cross Serrated Rasp. . . . .	388
Miller Parallel Serrated Rasp. . . . .	389
Miller Skin Rake Retractor. . . . .	148
Mini Depth Gauge. . . . .	146
Mini Finochietto Retractor. . . . .	53
Mini Foremann Distractor . . . . .	406
Mini Friedman Rongeur . . . . .	458
Mini Glover (Weldon) Bulldog Clamp. . . . .	69
Mini Hohman Elevator Retractor. . . . .	417
Mini Inge Neroma Ceramitec Retractor . . . . .	405
Mini Inge Neroma Retractor . . . . .	405
Mini Jet Wire Twister Needle Holder . . . . .	582
Mini Lexer Osteotome. . . . .	538
Mini Neuro Premier Rongeur . . . . .	456
Mini Neuro Rongeur . . . . .	456
Mini Pedo Extracting Forceps. . . . .	167

Mixer-Paul Right Angle Forceps . . . . .	208
Mixer Right Angle Forceps. . . . .	207
Molt Periosteal Dental Elevator. . . . .	164
Monopolar Cable . . . . .	597
Muldoon Lacrimal Dilator . . . . .	99
Murphy-Lane Bone Skid . . . . .	409
<b>N</b>	
Nail Rasp. . . . .	390
Nasal/Tendon Knife. . . . .	28
Needle	
Durrani Dorsal Vein Complex Ligation Needle . . . . .	380
Reverdin Needle/Ligature Carrier . . . . .	380
Sontec Reverdin Blunt Needle/Ligature Carrier. . . . .	380
Needle Boat / Spiral Rack. . . . .	17
Needle Holder	
Barraquer Needle Holder. . . . .	328
Boynton Needle Holder. . . . .	326
Castroviejo Needle Holder . . . . .	325, 329
Castroviejo Needle Holder with Scissors . . . . .	340
Crile-Wood Needle Holder. . . . .	320
Derf Needle Holder . . . . .	314
Derf Needle Holder Titanium. . . . .	315
Foster-Gillies Needle Holder . . . . .	339
Gillies Needle Holder. . . . .	338
Glasser Micro Needle Holder . . . . .	331
Gregory Needle Holder . . . . .	324
Halsey Needle Holder . . . . .	315
Harrison Needle Holder. . . . .	135
Integrated Needle Holder . . . . .	613
Jacobson Needle Holder. . . . .	330
Mathieu Heavy Needle Holder. . . . .	327
Mathieu-Olsen Needle Holder. . . . .	341
Mayo-Hegar Needle Holder. . . . .	317
Mayo-Hegar Needle Holder Titanium . . . . .	319
Mayo-Hegar Streamlined Needle Holder . . . . .	318
Mini Jet Wire Twister Needle Holder . . . . .	582
New Orleans Wire Twister Needle Holder . . . . .	580
Olsen-Hegar Deluxe Needle Holder . . . . .	334
Olsen-Webster Needle Holder. . . . .	337
Parkhouse Needle Holder . . . . .	338
Ryder Standard Size Needle Holder . . . . .	321
Sontec Extra Micro Needle Holder . . . . .	326
Sontec Olsen-Hegar Needle Holder . . . . .	336
Sternal Wire Twister Needle Holder. . . . .	580
TC Jet Wire Twister Corkscrew Design Heavy Needle Holder. . . . .	583
Webster Needle Holder . . . . .	316
Webster Needle Holder Titanium . . . . .	316
Needle Holder Insert. . . . .	609
Nelms Suction Elevator. . . . .	246
Nemetz Bandage Scissors. . . . .	271
Nerve Hook Titanium . . . . .	234
New Orleans Lens Loop . . . . .	94
New Orleans Wire Twister Needle Holder . . . . .	580
Northbent Stitch Scissors. . . . .	267
Noyes Iris Scissors . . . . .	124
Nurse's Scissors . . . . .	275
Nuts	
Lubra Stainless Steel Nut Only . . . . .	131

**O**

O'Brien Stitch Scissors . . . . .	121
Obwegeser Fenestrated Serrations Rasp . . . . .	395
Obwegeser Split Osteotome . . . . .	539
Obwegeser Wedge Osteotome . . . . .	539
Ochsner Acute Angle Forceps . . . . .	210
Ochsner Baby Forceps. . . . .	218
Olsen-Hegar Deluxe Needle Holder . . . . .	334
Olsen-Lahey Right Angle Forceps . . . . .	210
Olsen-Webster Needle Holder . . . . .	337
Operating Classic, Tungsten Carbide, Power Cut Gold, Power Cut Black, TC/PC Power Cut Scissors . . . . .	294, 295
Orthopedic Drill Set. . . . .	620
Orthopedic Knee Surgery Set. . . . .	620
Orthopedic Set . . . . .	620
Orthopedic Vernier Caliper . . . . .	40
Osteotome	
Cottle Plastic Osteotome . . . . .	533
Hand Surgery Osteotome . . . . .	532
Hardt Micro Cartilage Osteotome Set (with bag) . . . . .	534
Hibbs Osteotome. . . . .	537
Hoke Osteotome . . . . .	533
Lambotte Osteotome. . . . .	537
Lexer Osteotome . . . . .	538
Mini Lexer Osteotome . . . . .	538
Obwegeser Split Osteotome . . . . .	539
Obwegeser Wedge Osteotome. . . . .	539
Sheehan Osteotome . . . . .	532
Smith Peterson Osteotome . . . . .	536
Stille Osteotome . . . . .	533
West Osteotome . . . . .	532
Ostium Burnisher Elevator . . . . .	523
<b>P</b>	
Packer	
Cottle Daniel Raspatory/Packer. . . . .	522
Freer Elevator / Packer . . . . .	520
Parkhouse Needle Holder. . . . .	338
Par Scissors . . . . .	302
Parsonnet Epicardial Retractor. . . . .	60
Pashley Knife Set . . . . .	33
Patella 2 x 2 Prong Bone Clamp. . . . .	420
Pean Intestinal Clamp Forceps. . . . .	220
Pedo Extracting Forceps . . . . .	166
Pennington Elevator . . . . .	520
Periosteal Elevator . . . . .	163
Peterson Fully Cannulated Pin Bender . . . . .	543
Pick	
Bone Pick Micro Fracture . . . . .	357
Rhoton Pick . . . . .	240
Taylor Micro Arthroscopic Hook Probe & Pick. . . . .	356
Taylor Micro Arthroscopic Pick . . . . .	146
Piermattai Pin Bender / Driver. . . . .	542
Pigtail Lacrimal Probe Dilator. . . . .	99
Pin Bender	
Peterson Fully Cannulated Pin Bender. . . . .	543
Piermattai Pin Bender / Driver . . . . .	542
Pin Bender Double-Ended. . . . .	542
Pin Bender Double-Ended . . . . .	542
Pin Cutter	
Baby GOLD-CUT HERCULES Pin Cutter . . . . .	573
End Pin Cutter . . . . .	567
GOLD-CUT HERCULES Front & Side Pin Cutter . . . . .	575
GOLD-CUT HERCULES Pin Cutter . . . . .	572
Large Plate & Pin Cutter . . . . .	567
Pin Puller / Side Cutter. . . . .	545
Sontec Pin Cutter. . . . .	571
TC Pin Cutter . . . . .	571
The Big GOLD-CUT HERCULES® Pin Cutter . . . . .	572
Pin Driver	
Pin Driver & Bone Tamp. . . . .	543
Sontec Pin Driver / Bender . . . . .	543
Pin Driver & Bone Tamp . . . . .	543
Pin End Cutter. . . . .	571
Pin Kit	
Steinmann Trocar Pin Kit Deluxe. . . . .	137
Pin Puller . . . . .	547
HERCULES GRIP Pin Puller . . . . .	546
Pin Puller . . . . .	547
Pin Puller / Side Cutter . . . . .	545
Pin Pulling Double Action Pliers. . . . .	546
Pin Pulling Pliers . . . . .	549
Pitanguy Elevator With Suction . . . . .	247
Pitanguy Raspatory Elevator With Suction . . . . .	246
Plate Bending Table Top Press. . . . .	552
Plate & Bone Reduction Forceps . . . . .	436
Plater Cutter	
Large Plate & Pin Cutter . . . . .	567
Plates	
Lubra Plates. . . . .	132
Platipus Micro Inge Lamina Spreader . . . . .	412
Plester First Incision Knife. . . . .	32
Pliers	
Aderer Wire Bending Pliers . . . . .	548
Lateral Plate Bending Pliers. . . . .	553
Pin Pulling Double Action Pliers . . . . .	546
Pin Pulling Pliers . . . . .	549
Whale Nose Plate Bending Pliers . . . . .	553
Wire Extraction Pliers. . . . .	549
Polack Corneal Forceps . . . . .	107
Politzer Ear Knife. . . . .	31
Poole Suction . . . . .	260
Press	
Plate Bending Table Top Press . . . . .	552
Probe	
Arthroscopic Hook Probe . . . . .	355
Arthroscopic Hook Probe with Conical Handle . . . . .	355
Arthroscopic Meniscotomes Hook, Probe & Knife . . . . .	353
Barr Double Ended Probe . . . . .	153
Barr Fistula Probe . . . . .	153
Baylor Tactile Tone Periodontal Probe . . . . .	173
Bowman Lacrimal Probe. . . . .	98
Buie Fistula Probe . . . . .	153
Double-ended Dental Explorer/Probe Combination. . . . .	170
Jacobson Button End Hook Probe . . . . .	241
Jacobson Button End Probe. . . . .	240
Jacobson Hook Probe. . . . .	241
Larry Fistula Probe. . . . .	153
Lockhart Mummery Fistula Probe. . . . .	152
Maxillary Ostium Elevator / Probe. . . . .	522
McIlwraith Arthroscopic Hook Probe. . . . .	356
Sontec® Septum Elevator / Probe . . . . .	522

St. Marks Fistula Probe . . . . .	153
Taylor Micro Arthroscopic Hook Probe & Pick . . . . .	356
Triangle Handle Arthroscopic Meniscotome, Hook, Probe & Knife . . . . .	352
Tufts Pigtail Neuro Hook Probe . . . . .	232
Probe & Knife . . . . .	352, 353
Probes & Knives . . . . .	352
Puller	
Vickers Easy Driver / Bender / Puller . . . . .	544
Punch	
Arthroscopic Hook Punch . . . . .	346
Arthroscopic Punch & Scissors . . . . .	350
Uterine Biopsy Punch . . . . .	492
Punched Hole Gauge Ruler . . . . .	40
Punch Insert . . . . .	608
Pusher	
Knot Pusher . . . . .	598
Putti Bone Rasp . . . . .	391
<b>R</b>	
Rabbit Dental Set . . . . .	620
Ragnell Retractor . . . . .	414
Ragnell Undermining Power Cut Gold Scissors . . . . .	304
Raleigh Bone Holding Forceps . . . . .	431
Randall Kidney Stone Forceps . . . . .	224
Rankin-Kelly Forceps . . . . .	215
Rasp	
Arthroscopic Rasp . . . . .	355, 357
Classic Bayonet Dental Rodent Rasp . . . . .	176
Combination Bone Rasp . . . . .	392
Daniel-Gubisch Raspatory/Rasp . . . . .	522
Double-Ended Rasp . . . . .	386
Foman TC Insert Rasp . . . . .	387
Fomon Rasp . . . . .	387
Good Bone Rasp . . . . .	394
Grooved Diamond Coated Dental Rasp . . . . .	176
Maltz Single-Ended Rasp . . . . .	390
Miller Cross Serrated Rasp . . . . .	388
Miller Parallel Serrated Rasp . . . . .	389
Nail Rasp . . . . .	390
Obwegeser Fenestrated Serrations Rasp . . . . .	395
Putti Bone Rasp . . . . .	391
Single Side Rasp . . . . .	391
Small Animal Dental Rasp . . . . .	175
Sontec Fomon Rasp . . . . .	386
Sontec-Glabella Sculpting TC Insert Rasp . . . . .	395
Sontec Micro Rasp . . . . .	390
Webster Glabella Sculpting Rasp . . . . .	395
Raspatory	
Cottle Daniel Raspatory/Packer . . . . .	522
Daniel-Gubisch Raspatory/Rasp . . . . .	522
Rhoton Dissector / Raspatory . . . . .	238, 239
Sontec A O Type Elevator / Raspatory . . . . .	514, 515
Retractor	
Rizzuti Iris Retractor & Lens Expressor . . . . .	84
Redler Reposition Reduction Clamp . . . . .	436
Reduction Clamp	
Redler Reposition Reduction Clamp . . . . .	436

Reeh Stitch Scissors . . . . .	267
Reimer Emasculator . . . . .	134
Remover	
Michel Clips Applier Remover . . . . .	130
Retractor	
Allen Inge Stifle Retractor . . . . .	403
Alm Retractor . . . . .	58, 84
Aufranc Cobra Retractor . . . . .	409
Baby Farabeuf Retractor . . . . .	57
Baby Finochietto Retractor . . . . .	53
Balfour Retractor . . . . .	49
CSU Adolescent Balfour Retractor . . . . .	47
CSU Pediatric Balfour Retractor . . . . .	44, 45, 46
Davis Stifle Retractor . . . . .	403
Deluxe Balfour Retractor . . . . .	48
Desmarres Lid Retractor . . . . .	90
Desmarres Lid Retractor Autoclavable Plastic . . . . .	91
Desmarres Lid Retractor Titanium . . . . .	91
Farabeuf Retractor . . . . .	57
Finochietto-Baby-Haight Rib Spreader Retractor . . . . .	52
Finochietto Retractor . . . . .	54, 61
Finochietto Rib Spreader Retractor . . . . .	56
Gelpi 1st Generation Deep Angle Retractor . . . . .	402
Gelpi Classic Retractor . . . . .	401
Gelpi Deep Angle Neroma (Crossover) Retractor . . . . .	400
Gelpi Deep Angle Retractor . . . . .	398
Gelpi Neroma (Crossover) Retractor . . . . .	399
Gil-Vernet Desmarres Retractor . . . . .	91
Hobday's Roaring Retractor . . . . .	143
Hohman Elevator Retractor . . . . .	416
Inge Neroma Retractor . . . . .	404
Jaffe Wire Lid Retractor . . . . .	84
Kawamoto Double-Ended Retractor . . . . .	90
Knapp Rollet Hook Retractor . . . . .	148
Lukens Thymus Retractor . . . . .	149
Malleable Ribbon Retractor . . . . .	410
McGannon Retractor . . . . .	90
Meyerding Finger Retractor . . . . .	149
Meyerding Retractor . . . . .	411
Micro Weitlaner-Henley Retractor . . . . .	59
Miller Skin Rake Retractor . . . . .	148
Mini Finochietto Retractor . . . . .	53
Mini Hohman Elevator Retractor . . . . .	417
Mini Inge Neroma Ceramitec Retractor . . . . .	405
Mini Inge Neroma Retractor . . . . .	405
Parsonnet Epicardial Retractor . . . . .	60
Ragnell Retractor . . . . .	414
Roux Retractor . . . . .	57
Segmented Adjustable Aluminum Retractor . . . . .	155
Senn Retractor . . . . .	414
Sewall Orbital Retractor . . . . .	85
Shanghai Neonatal Finochietto Retractor . . . . .	55
Sisson Spring Retractor . . . . .	408
Sontec Cross-Action Retractor . . . . .	58
Sontec-Hohman Retractor . . . . .	417
Stevenson Self-Retaining Retractor . . . . .	58
Strong Weitlaner Retractor . . . . .	59
Titanium I.M.A. Epicardial Retractor . . . . .	60
Volkman Retractor . . . . .	411
Wellace Stifle Retractor . . . . .	408
Blair Hook Retractor . . . . .	148
U.S. Army-Navy Retractor . . . . .	415
Retractor, Senn . . . . .	414
Reverdin Needle/Ligature Carrier . . . . .	380
Reynolds Tenotomy Classic, Power Cut Gold, Power Cut Black, TC/PC Power Cut Scissors . . . . .	296
Rhoton Circular Dissector 45° . . . . .	238
Rhoton Curette . . . . .	240
Rhoton Dissector / Raspatory . . . . .	238, 239
Rhoton Hook . . . . .	240
Rhoton Micro Neuro Suction . . . . .	254
Rhoton Pick . . . . .	240
Rizzuti Iris Retractor & Lens Expressor . . . . .	84
Rochester-Carmalt Forceps . . . . .	219
Rochester-Ochsner Forceps . . . . .	218
Rochester-Pean Forceps . . . . .	217
Rod Cutter . . . . .	576
Rodent Cheek Spreader Set . . . . .	181
Rodent-Classic Wolf Tooth Cutting Forceps . . . . .	177
Rodent Dental Spatula . . . . .	179
Rodent Incisor Luxator . . . . .	179
Rodent Molar Cutter . . . . .	177
Rodent Molar Extractor Forceps . . . . .	176
Rodent Table Retractor Restraint . . . . .	178
Rodent Tooth Cutting Set . . . . .	178
Rod Flush Cutter . . . . .	576
Roger Elevator . . . . .	519
Rongeur	
Arthroscopic Biopsy & Grasping Rongeur . . . . .	348
Arthroscopic Punch Rongeur . . . . .	351
Bane Single Action Rongeur . . . . .	464
Blumenthal Oral Surgery Rongeur . . . . .	165
Blumenthal Rongeur . . . . .	464
Caspar Grasping Rongeur . . . . .	484
Cicherelli Rongeur . . . . .	463
Classic Lempert Rongeur . . . . .	461
Cleveland Rongeur . . . . .	463
Cushing Pituitary Rongeur . . . . .	483
Cushing Rongeur . . . . .	465
Decker Micro Rongeur . . . . .	488
Ferris-Smith Arthroscopic Rongeur . . . . .	485, 486
Ferris-Smith Rongeur . . . . .	487
Ferris-Smith Spinal Extended Shaft Rongeur . . . . .	488
Ferris-Smith Wilde Rongeur . . . . .	487
Hakansson Rongeur . . . . .	459
Hoen Grasping Forceps . . . . .	489
Jeurs Lempert Neuro Rongeur . . . . .	462
Kerrison Universal Rotating 360° Rongeur . . . . .	473, 474, 475
Kleinert-Kutz Rongeur . . . . .	457
Leksell Duckbill Rongeur . . . . .	469
Levesque Neuro Rongeur . . . . .	462
Love Gruenwald Pituitary Rongeur . . . . .	483
McIlwraith Arthroscopic Grasping Rongeur . . . . .	489
McIlwraith Arthroscopic Scissors Rongeur . . . . .	491
McIlwraith Basket Cutter Rongeur . . . . .	490
McIlwraith Cup Rongeur . . . . .	481
McIlwraith-Peapod Rongeur . . . . .	491
Micro Friedman Ring Handle Rongeur . . . . .	457
Micro Friedman Rongeur . . . . .	458

Mini Friedman Rongeur . . . . .	458
Mini Neuro Premier Rongeur . . . . .	456
Mini Neuro Rongeur . . . . .	456
Ruskin Rongeur . . . . .	468
Schlesinger (Cloward) Rongeur . . . . .	482
Shearer Chickenbill Rongeur . . . . .	459
Sontec Lempert Rongeur . . . . .	461
Sontec Triangle Biopsy Punch Rongeur . . . . .	493
Spurling Pituitary Rongeur . . . . .	482, 483
Stellbrink Rongeur . . . . .	460
Takahashi Rongeur . . . . .	480
University of Pennsylvania Equine Biopsy Rongeur . . . . .	136
Weil Nasal Rongeur . . . . .	478
Wilde Ethmoid Rongeur . . . . .	479
Williams-Sontec Rongeur . . . . .	490
Yeoman Biopsy Punch Rongeur . . . . .	493
Rongeurs	
Weil-Blakesley Rongeur . . . . .	478
Root Extracting Forceps . . . . .	166
Root & Fragment Dental Extracting Forceps . . . . .	159
Rosen Circular Blade Dissector . . . . .	32
Rottweiler Junior Loosebody Grasping Forceps . . . . .	368
Roux Retractor . . . . .	57
Ruler	
Punched Hole Gauge Ruler . . . . .	40
Ruskin-Liston Bone Cutting Forceps . . . . .	372
Ruskin Rongeur . . . . .	468
Russian Adson Micro Forceps . . . . .	199
Russian Tissue Forceps . . . . .	187
Ryder Standard Size Needle Holder . . . . .	321
<b>S</b>	
Sanders Brown Ligature Carrier . . . . .	383
Saw	
Cottle Bone Saw . . . . .	377
Gigli Saw Blades . . . . .	377
Langenbeck Metacarpal Saw . . . . .	376
Linderman Amputation Saw . . . . .	376
Wellenschliff Nasal Saw . . . . .	376
SC95-0310-SET . . . . .	358
SC95-0315-SET . . . . .	358
SC95-0415-SET . . . . .	358
Scaler	
Dental Scaler . . . . .	173
Dental Scaler/Curette . . . . .	173
Schiotz Tonometer . . . . .	41
Schlesinger (Cloward) Rongeur . . . . .	482
Schmid Suction Tips . . . . .	256
Schmieden-Dick Ligature Carrier . . . . .	382
Schmidt Hemostatic Forceps . . . . .	214
Schroeder Vulsellum Bone Reduction Clamp . . . . .	435
Scissors	
Arthroscopic Metzenbaum Hook Scissors . . . . .	347
Arthroscopic Punch & Scissors . . . . .	350
Azar Corneal Scissors . . . . .	126
Baby Stratte Scissors . . . . .	123
Bonn Scissors . . . . .	118
Castroviejo Corneal Scissors . . . . .	126
Castroviejo Corneal Scissors . . . . .	124
Castroviejo Keratoplasty & Keratectomy	

Wide Handle Scissors . . . . .	126
Castroviejo Keratoplasty Scissors . . . . .	126
Ceramitec Stevens Tenotomy Ergonomic Spread Handle Power Cut Black® Scissors . . . . .	116
Cinelli lower lateral Scissors . . . . .	122
Commander Utility Shears . . . . .	272
Converse Daniel Scissors . . . . .	300
Converse Wilmer Scissors . . . . .	301
Doyen Classic Model Power Cut Gold® Scissors . . . . .	298
Embertson Esophageal Epiglottis Scissors . . . . .	135
Enucleation Scissors . . . . .	96, 123
Esophageal Epiglottis Hook Scissors . . . . .	135
Eye Scissors . . . . .	300
Fomon Lateral Scissors . . . . .	122
Fomon Scissors . . . . .	122
Freeman-Kaye Ergonomic Spread Handle Saberback Scissors . . . . .	297
Goldman-Fox Scissors . . . . .	299
Harris Micro Bandage Scissors . . . . .	271
Heath Suture Scissors . . . . .	268
HF-Ciradur Scissors . . . . .	622
Intraocular Scissors . . . . .	97
Iris Classic Tungsten Carbide Power Cut Gold Power Cut Black TC/PC Scissors . . . . .	120
Jabaley Scissors . . . . .	302
Joseph-Peck Saberback Classic Power Cut Gold Power Cut Black TC/PC Power Cut Scissors . . . . .	303
Kaye Blepharoplasty Scissors . . . . .	305
Knowles Bandage Scissors . . . . .	270
LaGrange Scissors . . . . .	300
Lister Bandage Scissors . . . . .	269
Martin Cartilage Tenotomy Classic Power Cut Gold Scissors . . . . .	298
Mayo-Carroll Scissors . . . . .	282
Mayo Classic, Tungsten Carbide, Power Cut Gold, Power Cut Black, TC/PC Power Cut, Ceramic Coated Scissors . . . . .	281
Mayo-Harrington Scissors . . . . .	283
Mayo-Lexer Classic Power Cut Gold Power Cut Black TC/PC Power Cut Scissors . . . . .	282
Mayo-Lexer Fino Classic Tungsten Carbide Power Cut Gold Scissors . . . . .	281
Mayo-Stille Classic, Tungsten Carbide, Power Cut Gold, Power Cut Black, TC/PC Power Cut, Ceramic Coated Scissors . . . . .	280
McPherson-Westcott Stitch Scissors . . . . .	125
Metzenbaum Ceramitec Power Cut® Scissors . . . . .	290
Metzenbaum Classic Model Scissors . . . . .	286
Metzenbaum Power Cut Black Scissors . . . . .	288, 289
Metzenbaum Power Cut Gold Scissors . . . . .	287
Metzenbaum Tungsten Carbide Power Cut® Gold/Black Scissors . . . . .	291
Nemetz Bandage Scissors . . . . .	271
Northbent Stitch Scissors . . . . .	267
Noyes Iris Scissors . . . . .	124
Nurse's Scissors . . . . .	275
O'Brien Stitch Scissors . . . . .	121

Operating Classic, Tungsten Carbide, Power Cut Gold, Power Cut Black, TC/PC Power Cut Scissors . . . . .	294, 295
Par Scissors . . . . .	302
Ragnell Undermining Power Cut Gold Scissors . . . . .	304
Reynolds Tenotomy Classic, Power Cut Gold, Power Cut Black, TC/PC Power Cut Scissors . . . . .	296
Smith Wire Cutting Scissors . . . . .	268
Sontec Bipolar Metzenbaum Scissors . . . . .	308
Sontec Stitch Scissors . . . . .	121
Spencer Suture Scissors . . . . .	265
Stevens Tenotomy Classic PC Gold Scissors . . . . .	117
Stevens Tenotomy Classic, Tungsten Carbide, Power Cut Gold, Power Cut Black, Ceramic Coated Scissors . . . . .	117
Stevens Tenotomy Ergonomic Spread Handle Power Cut Black Scissors . . . . .	116
Strabismus Classic Tungsten Carbide Power Cut Gold Power Cut Black Scissors . . . . .	119
Taylor Dura Scissors . . . . .	271
Titanium Westcott Tenotomy Scissors . . . . .	125
Utility Scissors . . . . .	274
Walton Thorek Scissors . . . . .	122
Westcott Stitch Scissors . . . . .	127
Westcott Tenotomy Scissors . . . . .	125
Westcott Utility Scissors . . . . .	125
Westcott Wide Handle Conjunctival Scissors . . . . .	127
Westcott Wide Handle Tenotomy Scissors . . . . .	127
Scissors Insert . . . . .	602, 611
Scissors Working Part . . . . .	614
Scissors	
Iris Stille Classic Large Cut Out Rings Scissors . . . . .	119
Scoop	
Davis Gallstone Scoop . . . . .	154
Ferguson Gallstone Scoop . . . . .	154
Screw Driver	
A.O. Type Universal Screw Driver . . . . .	557
Hexagonal Screw Driver . . . . .	556
Lubra Screw Driver . . . . .	558
Scudder Intestinal Clamp . . . . .	138
Segmented Adjustable Aluminum Retractor . . . . .	155
Selman Tissue Forceps . . . . .	187
Semken Forceps . . . . .	189
Sequestum Sontec Bone Forceps . . . . .	426
Serra Modified Emasculator . . . . .	134
Serrefine Bulldog Clamp . . . . .	74
Sesamoid Cottle Elevator . . . . .	521
Set	
3.0 mm Micro External Fixator Set . . . . .	140
4.0 mm Micro External Fixator Set . . . . .	141
AO Type Bending Pliers Set . . . . .	552
AO Type Universal Screwdriver Set . . . . .	559
Basic Ophthalmic Set . . . . .	620
Basic Orthopedic Set . . . . .	620
Bishop-Harmon Irrigation Bulb Cannula Set . . . . .	102
Canine Spay Set . . . . .	620
Deluxe Rodent Dental Set . . . . .	620

Extended Ophthalmic Set . . . . . 620  
 External Fixator TPLO Set . . . . . 138  
 Feline Spay Set . . . . . 620  
 Gallaher Bone Rasp Set . . . . . 393  
 General Dental Set . . . . . 621  
 General Surgery Set . . . . . 620  
 Hardt Micro Cartilage Osteotome Set (with bag) . . . . . 534  
 Orthopedic Drill Set . . . . . 620  
 Orthopedic Knee Surgery Set . . . . . 620  
 Orthopedic Set . . . . . 620  
 Rabbit Dental Set . . . . . 620  
 Rodent Cheek Spreader Set . . . . . 181  
 Small Joint Arthroscopic Cannula Switch Stick Set . . . . . 360  
 Sontec-Cottle Osteotome Set . . . . . 535  
 Sontec I.M. Pin Chuck Set . . . . . 505  
 TC Blades Replacement Set For Hercules Wire Cutter . . . . . 577  
 TC Inserts with Rubber Jaws Replacement Set for Hercules Front & Side Cutter . . . . . 577  
 Titanium Avian Set . . . . . 620  
 Unique Dental Periosteal Elevator Set . . . . . 163  
 Universal Klick Kerrison Rongeur Set with Tray . . . . . 472

**Sets**  
 Veterinary Surgical Sets . . . . . 620  
 Severin Lacrimal Cannula . . . . . 103  
 Sewall Orbital Retractor . . . . . 85  
 Sexton-Gerzog Ear Knife . . . . . 30  
**Shaft**  
 Tube Shaft Insulated . . . . . 600, 601  
 Shanghai Neonatal Finochietto Retractor . . . . . 55  
 Shaninian Lacrimal Cannula . . . . . 103  
 Shanz Pin . . . . . 136  
 Shapleigh Ear Curette . . . . . 446  
 Sharpener . . . . . 174  
 Sharpening  
 India Sharpening Stone . . . . . 174  
 Sharpening Stone  
 Arkansas Sharpening Stone . . . . . 174  
 Shearer Chickenbill Rongeur . . . . . 459  
**Shears**  
 Heavy Synthetic Cast Shears . . . . . 273  
 Sheehan Osteotome . . . . . 532  
 Sheen Fragment Retriever Forceps . . . . . 481  
**Sickle**  
 Sickle/Curette Combinations . . . . . 171  
 Sickle/Curette Combinations . . . . . 171  
 Sickle/Jacquettes Combinations . . . . . 172  
 Sickle Knife . . . . . 31  
 Silicone Eye Implants . . . . . 100  
 Single Side Rasp . . . . . 391  
 Singley Tuttle Forceps . . . . . 188  
 Sisson Spring Retractor . . . . . 408  
**Skid**  
 Murphy-Lane Bone Skid . . . . . 409  
 Slimline Back Bent Elevator . . . . . 158  
 Small Animal Dental Rasp . . . . . 175  
 Small Joint Arthroscopic Cannula . . . . . 360  
 Small Joint Arthroscopic Cannula Switch Stick Set . . . . . 360  
 Small Joint Complete Arthroscopic Set . . . . . 361  
 Smith Peterson Osteotome . . . . . 536  
 Smith Wire Cutting Scissors . . . . . 268

Snook Feline Spay Hook . . . . . 130  
 Snook Ovariectomy Hook . . . . . 130  
 Sontec® Excavator Curette . . . . . 449  
 Sontec Alligator Forceps . . . . . 496, 498  
 Sontec A O Type Elevator / Raspatory . . . . . 514, 515  
 Sontec Bipolar Metzbaum Scissors . . . . . 308  
 Sontec Bone Hook . . . . . 147  
 Sontec Combo Nylon Mallet . . . . . 526  
 Sontec Corneal Cutting Block . . . . . 94  
 Sontec Cottle Elevator . . . . . 521  
 Sontec-Cottle Osteotome Set . . . . . 535  
 Sontec Cross-Action Retractor . . . . . 58  
 Sontec Delicate Meniscus Clamp . . . . . 589  
 Sontec Dental Bone Cutting Forceps . . . . . 159, 465  
 Sontec Double Nylon Mallet . . . . . 527  
 Sontec Excavator Curette . . . . . 449  
 Sontec Extra Micro Needle Holder . . . . . 326  
 Sontec Eye Lid Forceps . . . . . 111  
 Sontec Fomon Rasp . . . . . 386  
 Sontec Forcep Holder . . . . . 16  
 Sontec Freer Skin Hook Titanium . . . . . 151  
 Sontec-Glabella Sculpting Rasp . . . . . 395  
 Sontec-Glabella Sculpting TC Insert Rasp . . . . . 395  
 Sontec-Hohman Retractor . . . . . 417  
 Sontec Hybrid I.M. Pin Chuck . . . . . 504  
 Sontec I.M. Pin Chuck . . . . . 504  
 Sontec I.M. Pin Chuck Set . . . . . 505  
 Sontec Instrument Fabric Barrier Wrap 2Ply . . . . . 15  
 Sontec Knife Handle #3XXL . . . . . 25  
 Sontec Lane Lever Elevator . . . . . 417  
 Sontec Lempert Rongeur . . . . . 461  
 Sontec-Masing Septal Dissector . . . . . 518  
 Sontec Meniscus Clamp . . . . . 589  
 Sontec Mesh Meniscus Clamp . . . . . 591  
 Sontec Micro Alligator Forceps . . . . . 497  
 Sontec Micro Biopsy Forceps . . . . . 501  
 Sontec Micro Mallet . . . . . 527  
 Sontec Micro Rasp . . . . . 390  
 Sontec Mosquito Forceps . . . . . 213  
 Sontec Neuro Suction . . . . . 255  
 Sontec Olsen-Hegar Needle Holder . . . . . 336  
 Sontec Perfusion Cannula Suction . . . . . 261  
 Sontec Pin Cutter . . . . . 571  
 Sontec Pin Driver / Bender . . . . . 543  
 Sontec Reverdin Blunt Needle/Ligature Carrier . . . . . 380  
 Sontec Septum Elevator / Probe . . . . . 522  
 Sontec Sheet Tape . . . . . 19  
 Sontec Single End Wire Passer . . . . . 562  
 Sontec Slim Thermoplastic Instrument Tray . . . . . 11  
 Sontec S.P.T. Elevator . . . . . 519  
 Sontec Stifle Thrust Lever . . . . . 409  
 Sontec Stitch Scissors . . . . . 121  
 Sontec Tissue Twist Hook . . . . . 150  
 Sontec Triangle Biopsy Punch Rongeur . . . . . 493  
**Spatula**  
 Rodent Dental Spatula . . . . . 179  
**Speculum**  
 Barraquer Wire Speculum . . . . . 86, 88  
 Barraquer Wire Speculum Third Eye Lid . . . . . 87

Castroviejo Equine Eye Speculum . . . . . 88  
 Williams Eye Speculum . . . . . 89  
 Spencer Suture Scissors . . . . . 265  
 Sponge Bowl . . . . . 14  
**Spoon**  
 Bunge Evisceration Spoon . . . . . 94  
 Culler Lens Spoon . . . . . 94  
 Wells Enucleation Spoon . . . . . 94  
**Spreader**  
 Inge Lamina Spreader . . . . . 407  
 Micro Lamina Spreader . . . . . 413  
 Platipus Micro Inge Lamina Spreader . . . . . 412  
 Spring Mouth Gag . . . . . 175  
 Spurling Pituitary Rongeur . . . . . 482, 483  
 Stainless Steel Bolts . . . . . 132  
 Stainless Steel Feeding & Dosing Cannula . . . . . 139  
 Stainless Steel Instrument Tray . . . . . 13  
 Staley Round Knurled Knife Handle . . . . . 25  
 Stefan Bone Holding Forceps . . . . . 426  
 Stefan Mini Bone Holding Forceps . . . . . 425  
 Steinmann Trocar Pin Kit Deluxe . . . . . 137  
 Steinman Pin Puller . . . . . 544  
 Stellbrink Rongeur . . . . . 460  
 Sternal Wire Twister Needle Holder . . . . . 580  
 Stern-Castroviejo Suture 1x2 Tissue Forceps . . . . . 113  
 Stevenson Self-Retaining Retractor . . . . . 58  
 Stevens Tenotomy Classic PC Gold Scissors . . . . . 117  
 Stevens Tenotomy Classic, Tungsten Carbide, Power Cut Gold, Power Cut Black, Ceramic Coated Scissors . . . . . 116  
 Stevens Tenotomy Ergonomic Spread Handle Power Cut Black Scissors . . . . . 116  
 Stille-Adson Dressing Forceps . . . . . 198  
 Stille-Adson Tissue Forceps . . . . . 198  
 Stille Curette . . . . . 440  
 Stille-Liston Bone Cutting Forceps . . . . . 373  
 Stille Osteotome . . . . . 533  
 St. Marks Fistula Probe . . . . . 153  
 Strabismus Classic Tungsten Carbide Power Cut Gold Power Cut Black Scissors . . . . . 119  
 Strabismus Forceps . . . . . 109  
 Stringer Forceps Holder . . . . . 17  
 Strong Aortic Clamp . . . . . 80  
 Strong Weitlaner Retractor . . . . . 59  
**Suction**  
 Adson Suction . . . . . 260  
 Andrews Pynchon Suction . . . . . 258  
 Anthony Suction . . . . . 258  
 Baby Poole Suction . . . . . 260  
 Braun-Ralph Suction . . . . . 258  
 Frazier Angled Suction . . . . . 251  
 Frazier Insulated Suction . . . . . 252  
 Frazier Straight Suction . . . . . 252  
 Fukushima Suction . . . . . 253  
 Gorney Elevator With Suction . . . . . 247  
 Haraldsson Elevator with Suction . . . . . 247  
 House-Baron Suction . . . . . 256  
 House Irrigator/Suction . . . . . 257  
 Killian (Von Eicken) Suction . . . . . 261  
 Pitanguy Elevator With Suction . . . . . 247  
 Pitanguy Raspatory Elevator With Suction . . . . . 246

Poole Suction . . . . . 260  
 Rhoton Micro Neuro Suction . . . . . 254  
 Schmid Suction Tips . . . . . 256  
 Sontec Neuro Suction . . . . . 255  
 Sontec Perfusion Cannula Suction . . . . . 261  
 Yankauer Suction . . . . . 259  
 Suction Cup Handle for Eye Shields . . . . . 101  
**Suction Tube**  
 Buie Suction Tube . . . . . 257  
**Sump Sucker**  
 Heartline Ross Sump Sucker . . . . . 260  
**Switch Stick**  
 Arthroscopic Switch Stick . . . . . 359

**T**  
 T10-1010C . . . . . 86  
 T10-1013 . . . . . 87  
 T10-1014 . . . . . 87  
 T10-1015 . . . . . 87  
 T10-1016 . . . . . 87  
 T14-3800 . . . . . 108  
 T15-3920 . . . . . 328  
 Takahashi Rongeur . . . . . 480  
 Tankersly Ovariectomy Hook . . . . . 130  
**Tape**  
 Medi-Mark™ Tape . . . . . 20  
 Sontec Sheet Tape . . . . . 19  
 Tartar Remover Forceps . . . . . 165  
 Taylor Dura Scissors . . . . . 271  
 Taylor Micro Arthroscopic Hook Probe . . . . . 356  
 Taylor Micro Arthroscopic Hook Probe & Pick . . . . . 356  
 Taylor Micro Arthroscopic Pick . . . . . 146  
 TC Blades Replacement Set For Hercules Wire Cutter . . . . . 577  
 TC Inserts with Rubber Jaws Replacement Set for Hercules Front & Side Cutter . . . . . 577  
 TC Jet Wire Twister Corkscrew Design Heavy Needle Holder . . . . . 583  
 TC Pin Cutter . . . . . 571  
 Telescoping Metal Fragment Retriever . . . . . 142  
 Tendon Knife . . . . . 29, 30  
 Tendon Passer Ligature Carrier . . . . . 381  
 Tenzel Bipolar Forceps . . . . . 201  
 The Big GOLD-CUT HERCULES Pin Cutter . . . . . 572  
 Thermoplastic Instrument Trays . . . . . 10  
 Tholl Curette . . . . . 449  
 Thorpe Caliper . . . . . 39  
 3.0 mm Micro External Fixator Set . . . . . 140  
 Thumb Dressing Forceps . . . . . 191  
 Tip Cover . . . . . 18  
 Tissue Bipolar Forceps . . . . . 202  
 Tissue Forceps with Teeth . . . . . 190  
 Titanium Avian Set . . . . . 620  
 Titanium I.M.A. Epicardial Retractor . . . . . 60  
 Titanium Westcott Tenotomy Scissors . . . . . 125  
 Tohoku Towel Forceps . . . . . 229  
**Tongue Tie**  
 Grooved Director Tongue Tie . . . . . 152  
**Tonometer**  
 Schiotz Tonometer . . . . . 41  
**Tooth Splitting & Separating Extracting Forceps** . . . . . 165

**Tray**  
 Catheter Tray & Dome Lid Cover . . . . . 12  
 Sontec Slim Thermoplastic Instrument Tray . . . . . 11  
 Stainless Steel Instrument Tray, Lid Cover & Perforated Nesting Sterilization Instrument Tray . . . . . 13  
 Thermoplastic Instrument Trays . . . . . 10  
 Triangle Handle Arthroscopic Meniscomote . . . . . 352  
 Troutman Micro Hook Forceps . . . . . 193  
 Tube Shaft Insulated . . . . . 600, 601  
 Tufts Pigtail Neuro Hook Probe . . . . . 232  
 Tyrell Skin Hook . . . . . 150

**U**  
 Ulrich Bone Clamp . . . . . 423  
 Unique Dental Periosteal Elevator Set . . . . . 163  
 Universal Adjustable Angle Knife Handle #3. 24 . . . . . 24  
 Universal Drill Guide . . . . . 507  
 Universal Klick Kerrison Rongeur Set with Tray . . . . . 472  
 Universal Magnet for Retrieval/ Demagnetizing . . . . . 142  
 Universal Microvascular Clamp . . . . . 72  
 University of Pennsylvania Equine Biopsy Rongeur . . . . . 136  
 U.S. Army-Navy Retractor . . . . . 415  
 Uterine Biopsy Forceps . . . . . 492  
 Uterine Biopsy Punch . . . . . 492  
 Utility Scissors . . . . . 118, 274

**V**  
 Verbrugge Bone Clamp . . . . . 422  
 Verbrugge-Rogalski Bone Clamp . . . . . 420  
 Veterinary Surgical Sets . . . . . 620  
 Vickers Easy Driver / Bender / Puller . . . . . 544  
 Virginia Roaring Burr Long . . . . . 143  
 Virginia Roaring Burr Short . . . . . 142  
 Vogel Infant Adenoid Curette . . . . . 452  
 Volkman Retractor . . . . . 411  
 Vorse Tube Occluding Clamp . . . . . 81

**W**  
 Wagner Hook . . . . . 234  
 Walton Thorek Scissors . . . . . 122  
 Wangenstein Tissue Forceps . . . . . 188  
 Warwick James Root Elevator . . . . . 158  
**Washers**  
 Lubra Stainless Steel Washer Only . . . . . 131  
 Waterston Dissecting Forceps . . . . . 209  
 Webster Glabella Sculpting Rasp . . . . . 395  
 Webster Needle Holder . . . . . 316  
 Webster Needle Holder Titanium . . . . . 316  
 Weil-Blakesley Rongeur . . . . . 478  
 Weil Nasal Rongeur . . . . . 478  
 Weitlaner Rodent Mouth Spreader . . . . . 180  
 Weldon Bulldog Artery Clamp Titanium . . . . . 70  
 Weldon Bulldog Vein Clamp Titanium . . . . . 70  
 Wellace Rodent Mouth Spreader . . . . . 180  
 Wellace Stifle Retractor . . . . . 408  
 Wellenschliff Nasal Saw . . . . . 376  
 Wells Enucleation Spoon . . . . . 94

West Cannula . . . . . 103  
 Westcott Stitch Scissors . . . . . 127  
 Westcott Tenotomy Scissors . . . . . 125  
 Westcott Utility Scissors . . . . . 125  
 Westcott Wide Handle Conjunctival Scissors . . . . . 127  
 Westcott Wide Handle Tenotomy Scissors . . . . . 127  
 West Osteotome . . . . . 532  
 Whale Nose Plate Bending Pliers . . . . . 553  
 Whisk 'R Brush™ . . . . . 21  
 Wide Barrel Grip Knife Handle #3 . . . . . 24  
 Wilde Ethmoid Rongeur . . . . . 479  
 Wilder Lacrimal Dilator . . . . . 99  
 Williams Eye Speculum . . . . . 89  
 Williams-Sontec Rongeur . . . . . 490  
 Williger Curette . . . . . 447  
 Winged Dental Elevator Set Classic Handle . . . . . 160, 161  
 Winged Dental Elevator Set Short Handle . . . . . 160  
**Wire Cutter**  
 Double Action Wire Cutter . . . . . 568, 574  
 Wire End Cutter . . . . . 569  
 Wire Side Cutter . . . . . 566  
 Wire End Cutter . . . . . 569  
 Wire Extraction Pliers . . . . . 549  
**Wire Passer**  
 Avian Mini Wire Passer . . . . . 563  
 Herbst-Doolen Wire Passer . . . . . 563  
 Herbst Wire Passer . . . . . 563  
 Sontec Single End Wire Passer . . . . . 562  
 Wire Side Cutter . . . . . 566  
**Wire Twister**  
 Axel Wire Twister . . . . . 581  
 Bio-Met Type Wire Twister . . . . . 584  
 Bio-Met Wire Twister . . . . . 584  
 Cerclage Double Torpedo Type Wire Twister . . . . . 585  
 Cerclage Torpedo Type Wire Twister . . . . . 583  
 Jet Wire Twister . . . . . 585  
 Loute Wire Twister . . . . . 584  
 Mini Jet Wire Twister Needle Holder . . . . . 582  
 New Orleans Wire Twister Needle Holder . . . . . 580  
 Sternal Wire Twister Needle Holder . . . . . 580  
 Wire Twister . . . . . 582  
 Woodson Elevator . . . . . 518  
**Working Parts**  
 Biopsy Cup Working Part . . . . . 614  
 Grasping Forceps Working Part . . . . . 615  
 Scissors Working Part . . . . . 614  
**Wrench**  
 Lubra™ Wrench . . . . . 131

**Y**  
 Yankauer Suction . . . . . 259  
 Yasargil Arachnoid Knife . . . . . 33  
 Yasargil Bayonet Arachnoid Knife Titanium . . . . . 33  
 Yeoman Biopsy Punch Rongeur . . . . . 493





Bringing the Highest Quality Surgical  
Instrumentation to the World since 1970



**Sontec Instruments®**

A TRADITION OF FINE SURGICAL INSTRUMENTS

Sontec Instruments, Inc.  
7248 South Tucson Way  
Centennial, Colorado 80112 USA  
Toll-free / 800.821.7496  
Local / 303.790.9411  
Fax / 303.792.2606

[SontecInstruments.com](http://SontecInstruments.com)